

# Section 18

## Contactors and Starters-IEC

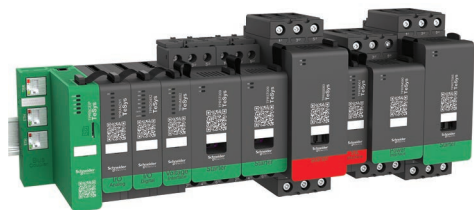

TeSys island Load Management System



TeSys Deca Series 9--150 Amperes



TeSys Giga Series 115--800 Amperes



TeSys Ultra Combination Motor Controllers







Scan here to access our online digital easy motor control selectors

<b>TeSys Selection Overview</b>	<b>18-2</b>
Solutions that enhance machine intelligence	18-2
Two-Component Motor Circuit Solutions to 520 amps	18-4
<b>Digital Motor Control Solution</b>	<b>18-5</b>
TeSys island Load Management System	18-5
<b>Contactors and Overload Relays</b>	<b>18-8</b>
TeSys™ K Contactors and Overload Relays	18-8
TeSys™ K Non-Reversing Mini-Contactors	18-8
TeSys™ K Overload Relays	18-9
TeSys™ K Reversing Mini-Contactors	18-9
TeSys™ Deca Series 9–150 Amperes	18-11
TeSys™ Deca Non-Reversing Contactors	18-11
TeSys™ Deca Overload Relays	18-12
TeSys™ Deca Reversing Contactors	18-14
TeSys™ Giga Series 115–800 Amperes	18-15
TeSys™ Giga Non-Reversing Contactors	18-15
TeSys™ Giga Overload Relays	18-16
TeSys™ Giga Reversing Contactors	18-16
TeSys™ F Contactors and Overload Relays	18-17
TeSys™ F Non-Reversing Contactors	18-17
<b>Contactor Accessories</b>	<b>18-18</b>
TeSys™ K Contactors	18-18
TeSys™ Deca and F Contactors	18-19
TeSys™ Deca Contactors	18-21
TeSys™ Giga Contactors	18-24
<b>Overload Relay Accessories</b>	<b>18-28</b>
TeSys™ Deca Overload Relays	18-28
TeSys™ Giga Overload Relay	18-29
<b>Motor Starters and Protectors</b>	<b>18-30</b>
TeSys™ Ultra Combination Motor Controllers	18-30
TeSys™ Deca Manual Motor Controllers	18-34
TeSys™ Deca Enclosed Starters	18-39
TeSys™ LS1 Fuse Holders	18-41
<b>Soft Starter Module ATSU01</b>	<b>18-42</b>
ATSU01 Altistart™ and TeSys™ Ultra	18-42
<b>Replacement Parts</b>	<b>18-43</b>
TeSys™ Deca Series	18-43
TeSys™ Giga Series	18-44
<b>Wiring Systems</b>	<b>18-45</b>
TeSys™ AK5 Panel Busbar System	18-45
<b>Dimensions</b>	<b>18-46</b>



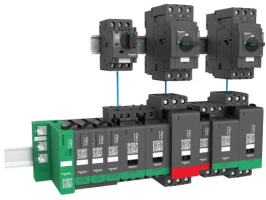





TeSys Control Solutions

TeSys offers solutions for a variety of common control applications, including small to large loads, motor and non-motor loads, in various forms to meet customers specific needs. Basic solutions offer traditional approaches that meet compact, cost-effective, and large HP applications. TeSys also equips OEMs and System Integrators with EcoStruxure Machine connected product solutions that are IoT ready offers to help enhance the intelligence of machinery and equipment, helping to recognize and address potential issues before stoppage and decrease unplanned downtime.

Table 18.1: Solutions that enhance machine intelligence

	Solution 1 — TeSys™ island as group motor	Solution 2 — TeSys island with individual protection	Solution 3 — TeSys Ultra (Type E self-protected) using Multi-function trip unit & communication module or using pre-trip alarm function module	Solution 4 — TeSys T overload relay	Solution 5 — TeSys GV4PB, GV5PB, GV6PB with SDx Module
					
Best Practice Scenario	Ideal for <b>panels with multiple loads</b> . Single bus coupler serves as connection to PLC, manages logic and configuration for starters.	Ideal for <b>panels with multiple loads</b> . Single bus coupler serves as connection to PLC, manages logic and configuration for starters.	Ideal for <b>panels with one or two motors</b> . Each starter communicates directly to PLC.	Ideal for <b>larger HP</b> . Each overload relay communicates directly to PLC.	Ideal for adding intelligence using a <b>simple NO/NC pre-trip alarm contact</b> — Use of PLC to receive/interpret data not required.
Benefits	See load, device and system performance. Set alarms to anticipate maintenance and optimize performance.	See load, device and system performance. Set alarms to anticipate maintenance and optimize performance.	See load performance. Set alarms to anticipate maintenance and optimize performance.	See load performance. Set alarms to anticipate maintenance and optimize performance.	Pre-trip alarm NO/NC contact alerts prior to trip, enabling proactive actions to minimize downtime or alert operators
Circuit Protection	Circuit breaker or fuse protection group	Circuit breaker or fuse	TeSys Ultra (applied as Type E self protected), using advanced trip unit/function modules	Breaker or fuse	GV4PB, GV5PB, GV6PB
Motor Control	TeSys island load management system with or without TeSys Deca Manual Motor Controllers	TeSys island load management system		TeSys Deca or Giga contactors	TeSys Deca or Giga contactor
Motor Overload Protection				TeSys T overload relay	(included in GV*PB)
Load Types	Motor, resistive/non-inductive, isolation	Motor, resistive/non-inductive, isolation	Motor loads only	Motor loads only	Motor loads only
Max HP 480V	40 HP	40 HP	20 HP	500 HP (up to 810 amps)	450 HP (up to 520 amps)
SCCR	basic 5 kA up to high 50 kA (with GV)	high, to 100 kA	High, to 65 kA	Depends on configuration	Depends on configuration
Available data	Device status/performance Load performance including alarms Voltage, Energy & Power	Device status/performance Load performance including alarms Voltage, Energy & Power	Load performance including alarms	Load performance including alarms Voltage & Power	Pre-trip alarm (via NO/NC contact)
Communication	Ethernet IP, Modbus TCP, Profinet, Profibus	Ethernet IP, Modbus TCP, Profinet, Profibus	Modbus™, CANopen, DeviceNet™, Profibus™	Modbus™, CANopen, DeviceNet™, Profibus™, Ethernet/IP, and Modbus/TCP	None

**Table 18.2: Basic — Traditional motor control solution**

	Solution 1 — Two component solution		Solution 2 — Single component solution	Solution 3 — Group Motor solution	Solution 5 — Three component solution (Breaker/fuse, contactor & overload relay)	Solution 6 — Type D solution (Motor circuit protector, contactor & overload relay)	Solution 7 — Non-motor load solution (Breaker/fuse + contactor)	
	Type F — up to 65 amps	Motor Protective Circuit Breakers + contactor - up to 520 amps	Type E — up to 32 amps	up to 65 amps				
								
Best Practice Scenario	Most cost effective, high SCCR solution		Most compact, also ideal for critical uptime applications resetable after a short-circuit with no component replacement), high SCCR solution	Few components, 480V delta rated	three-component solution, ideal for higher HPs or high SCCR	ideal for pumping applications, includes adjustable motor inrush sensitivity	ideal for non-motor loads	
Benefits	Simple, two-component solution, cost effective, fast power wiring using bus bars	Simple, two-component solution, cost effective for larger HP motors	Single component solution, Type 2 rated (minimize downtime after short-circuit)	cost effective solution ideal for panels with many motor loads (single breaker for multiple starters)	basic solution, ideal for 480V delta applications, resetable after breaker trip	adjustable motor inrush sensitivity, ideal for pumping applications	ideal for non-motor loads	
Circuit Protection	TeSys™ Deca GV2P, GV3P (applied as Type F with contactor)	TeSys™ Giga GV4PB, GV5PB, GV6PB (UL 489)	TeSys Ultra, with basic trip unit	PowerPact or Multi9 (UL 489) or fuses	PowerPact or Multi9 (UL 489) or TeSys DF, LS1 fuseholder, GS disconnect with fuses	TeSys BV4 (UL 489)	PowerPact or Multi9 (UL 489) or TeSys DF, LS1 fuseholder, GS disconnect with fuses	
Motor Control	Tesys Deca LC1D	TeSys Deca LC1D or Giga LC1G		TeSys Deca LC1D	TeSys Deca LC1D or TeSys Giga LC1G	TeSys Deca LC1D	TeSys Deca LC1D or TeSys Giga LC1G	
Motor Overload Protection	(included in GV)	(included in GV)		TeSys Deca GV	TeSys Deca LR or TeSys Giga LR9G	TeSys Deca LR	—	
Load Types	Motor loads only	Motor loads only	Motor loads only	Motor loads only	Motor loads only	Motor loads only	Resistive/non-inductive, isolation	

Two-Component Motor Circuit Solutions to 520 Amps

Simplify design, panel space and installation with TeSys™ high SCCR solution that use only two components that make up an entire branch circuit up to 520 amps. These two-component solutions are UL compliant using either a Type F combination motor controller rating or a UL 489 rating. For additional solutions and ratings, see Motor Control Solutions for North America data bulletin 8536DB0901.



TeSys™ Deca Series



TeSys™ Giga Series

Table 18.3: Quick selection table for TeSys™ two-component motor circuit solutions

200 V 3P		230 V 3P		460 V 3P		GV Ref	Overload Dial Range (A)	Contactor Ref [1]	SCCR 480Y as applied with specified protection
HP	FLA[2]	HP	FLA[2]	HP	FLA[2]				
—	—	—	—	1/2	1.1	GV2P06	1 to 1.6	LC1D09G7	65 kA[3]
—	—	—	—	3/4	1.6	GV2P06	1 to 1.6	LC1D09G7	65 kA[3]
1/2	2.5	1/2	2.2	1	2.1	GV2P07	1.6 to 2.5	LC1D09G7	65 kA[3]
—	—	—	—	1 1/2	3	GV2P08	2.5 to 4	LC1D09G7	65 kA[3]
3/4	3.7	3/4	3.2	2	3.4	GV2P08	2.5 to 4	LC1D09G7	65 kA[3]
1	4.6	1	4.2	3	4.8	GV2P10	4 to 6.3	LC1D09G7	65 kA[3]
—	—	1 1/2	6	—	—	GV2P10	4 to 6.3	LC1D09G7	65 kA[3]
1 1/2	6.9	2	6.8	—	—	GV2P14	6 to 10	LC1D12G7	65 kA[3]
2	7.8	—	—	5	7.6	GV2P14	6 to 10	LC1D12G7	65 kA[3]
—	—	3	9.6	—	—	GV2P16	9 to 14	LC1D12G7	50 kA[4]
3	11	—	—	7 1/2	11	GV2P16	9 to 14	LC1D18G7	50 kA[4]
—	—	—	—	10	14	GV2P16	9 to 14	LC1D18G7	50 kA[4]
5	17.5	5	15.2	—	—	GV2P20	13 to 18	LC1D18G7	50 kA[4]
—	—	7 1/2	22	15	21	GV2P21	17 to 23	LC1D25G7	50 kA[4]
7 1/2	25.3	—	—	—	—	GV2P22	20 to 25	LC1D25G7	50 kA[4]
—	—	10	28	20	27	GV3P32	23 to 32	LC1D32G7	65 kA[5]
10	32.2	—	—	25	34	GV3P40	30 to 40	LC1D40AG7	65 kA[5]
—	—	15	42	30	40	GV3P50	37 to 50	LC1D50AG7	65 kA[5]
15	48	20	54	40	52	GV3P65	48 to 65	LC1D65AG7	65 kA[5]
20	62.1	25	68	50	65	GV4PB115S	65 to 115	LC1D80G7	65 kA
25	78.2	30	80	60	77	GV4PB115S	65 to 115	LC1D80G7	65 kA
30	92	—	—	—	—	GV4PB115S	65 to 115	LC1D115G7	65 kA
—	—	40	104	75	96	GV5PB150S	58 to 130	LC1D115G7	65 kA
40	120	—	—	—	—	GV5PB150S	58 to 130	LC1D150G7	65 kA
—	—	50	130	100	124	GV5PB250S	114 to 217	LC1D150G7	65 kA
50	150	60	154	125	156	GV5PB250S	114 to 217	LC1G185	100 kA
60	177	75	192	150	180	GV5PB250S	114 to 217	LC1G225	100 kA
75	221	100	248	200	240	GV6PB400S	190 to 348	LC1G265	100 kA
100	285	125	312	250	302	GV6PB400S	190 to 348	LC1G330	100 kA
125	359	150	360	300	361	GV6PB600S	312 to 520	LC1G400	65 kA
150	414	200	480	400	477	GV6PB600S	312 to 520	LC1G500	65 kA
200	552	—	—	500	590	GV6PB600S	312 to 520	LC1G630	100 kA

18 CONTACTORS AND STARTERS-IEC

[1] Add coil suffix to complete reference part number (See Table 18.23 TeSys Deca Coil Voltage Codes , page 18-11 for LC1D and TeSys Giga Contactors — 3-Pole Standard Version, page 18-15 and Table 18.30 TeSys Giga Contactors — 3-Pole Advanced Version, page 18-15 for LC1F). For example, an LC1D09G7 includes a 120 Vac coil.  
 [2] Motor Full Load Amp Sizes are based on NEC Table 430.250.  
 [3] Requires use of GV1G09 or GV2GH7 line spacer for Type F rating. SCCR is 100 kA at 480Y with or without use of GV2G busbar links.  
 [4] Requires use of GV1G09 or GV2GH7 line spacer for Type F rating. SCCR is 42 kA at 480Y when using GV2G busbar links.  
 [5] Requires use of GV3G66 line spacer and GVAM11 short-circuit signaling contact for Type F rating.

**Island Concept**

TeSys island is an innovative digital load management solution—providing data for higher machine efficiency and ease of servicing, and allowing faster time to market.

TeSys island is a modular, multifunctional system providing integrated functions inside an automation architecture, primarily for the direct control and management of low-voltage loads. TeSys island can switch, help protect, and manage motors and other electrical loads up to 40 hp, 80 A installed in an electrical control Panel.

This system is designed around the concept of TeSys™ avatars.

These avatars:

- are the functional object representing a logical function of the physical module with pre-defined logic
- determine the configuration of the island.

The logical aspects of the island are managed with software tools, covering all phases of product and application lifecycle: design, engineering, commissioning, operation, and maintenance.

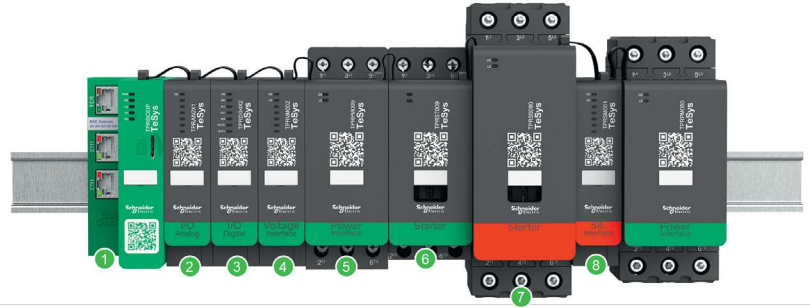

1	Bus Coupler	5	Power interface module
2	Analog I/O module	6	Standard Starter
3	Digital I/O module	7	SIL Starter
4	Voltage interface module	9	SIL interface module

The physical island consists of a set of devices installed on a single DIN rail controlling loads, monitoring data, diagnostics information and connected together with a ribbon cable providing the internal communication between modules.

The external communication with the automation environment is made via a single coupler module, and the island is seen as a single node on the network. The other modules include starters, power interface modules, analog and digital I/O modules, voltage interface modules, and SIL interface modules, covering a wide range of operational functions.

**Product References**

The TeSys island load management system consists of a bus coupler along with other starters and modules as needed to build an “island” of load management, monitoring & control functions. It is recommended to use the online EcoStruxure Motor Control Configurator to ensure proper application and sizing.



Scan here to access our online EcoStruxure Motor Control Configurator

**Table 18.4: Bus Couplers**

Designation	Upstream PLC protocol	Service Port protocol	Product Reference	Weight (kg)
TeSys island Bus Coupler	EtherNet/IP–Modbus TCP	Ethernet TCP/IP	TPRBCEIP	0.204
	PROFINET	Ethernet TCP/IP	TPRBCPFN	0.204
	PROFIBUS	Ethernet TCP/IP	TPRBCPFB	0.204

**Table 18.5: 3-Pole Starters**

Maximum Horsepower Ratings							Continu-ous Current Rating (A)	Product Reference	Weight (kg)
Single-Phase		Three-Phase							
115 V	230 V	200 V	230 V	460 V	575 V				
1/3	1	2	2	5	5	15	TPRST009	0.656	
2	3	7 1/2	7 1/2	15	20	30	TPRST025	0.718	
2	5	10	10	20	25	40	TPRST038	0.718	
5	10	20	20	40	50	80	TPRST065	1.248	
5	10	20	20	40	50	80	TPRST080	1.248	



TPRBCEIP



TPRST009



TPRS025



TPRSM001



TPRVM001



TPRDG4X2

**Table 18.6: 3-Pole SIL Starters**

Maximum Horsepower Ratings							Continu-ous Current Rating (A)	Product Reference	Weight (kg)
Single-Phase		Three-Phase							
115 V	230 V	200 V	230 V	460 V	575 V				
1/3	1	2	2	5	5	15	TPRSS009	0.656	
2	3	7 1/2	7 1/2	15	20	30	TPRSS025	0.718	
2	5	10	10	20	25	40	TPRSS038	0.718	
5	10	20	20	40	50	80	TPRSS065	1.248	
5	10	20	20	40	50	80	TPRSS080	1.248	

**Table 18.7: 3-Pole PIM Starters**

Maximum Horsepower Ratings							Continu-ous Current Rating (A)	Product Reference	Weight (kg)
Single-Phase		Three-Phase							
115 V	230 V	200 V	230 V	460 V	575 V				
1/3	1	2	2	5	5	15	TPRPM009	0.255	
2	5	10	10	20	25	40	TPRPM038	0.255	
5	10	20	20	40	50	80	TPRPM080	0.425	

**Table 18.8: SIL Interface Module**

Designation	Voltage (Vdc)	Product Reference	Weight (kg)
TeSys island SIL interface module (SIM)	24	TPRSM001	0.159

**Table 18.9: Voltage Interface Module (VIM)**

Designation	Phase	Voltage (V)	Frequency (Hz)	Product Reference	Weight (kg)
TeSys island Voltage interface module (SIM)	1P/3P	100 to 690	50–60	TPRVM001	0.159

**Table 18.10: Digital I/O Module**

Designation	Input Vdc	Output A / Vdc	Frequency (Hz)	Product Reference	Weight (kg)
TeSys island DG—Digital 4I/2O Module	24	0.5 / 24	50–60	TPRDG4X2	0.136

**Table 18.11: Analog I/O Module**

Designation	Inputs		Output		Product Reference	Weight (kg)
	mA dc	Vdc	mA dc	Vdc		
	TeSys island—Analog 2I/2O Module	0–20	–10 to +10	0–20		
	40–20	0–10	4–20	0–10		



TeSys™ K Non-Reversing Mini-Contactors



LC1K09



LP4K09

Table 18.12: Mini-Contactors with AC Operating Coils

Maximum Horsepower Ratings						Maximum Current (A)		Continuous Current Rating (A)	Type of Connection	Auxiliary Contacts		Catalog Number [1][2]	
Single-Phase		Three-Phase				Inductive AC3	Resistive AC1			N.O.	N.C.		
115 V	230 V	200 V	230 V	460 V	575 V								
0.5	1	1.5	1.5	3	3	6	20	10	Screw-clamp	1	—	LC1K0610	
—	—	—	—	—	—	—	—	—	—	1	—	LC1K0601	
0.5	1.5	2	3	5	5	9	20	20	Screw-clamp	1	—	LC1K0910	
—	—	—	—	—	—	—	—	—	—	—	1	—	LC1K0901
1	2	3	3	7.5	10	12	20	20	Screw-clamp	1	—	LC1K1210	
—	—	—	—	—	—	—	—	—	—	—	1	—	LC1K1201
<b>4-Pole Mini Contactor</b>													
1/2	1.5	2	3	5	5	9	20	20	Screw-clamp	4	—	LC1K09004	
—	—	—	—	—	—	—	—	—	—	2	2	LC1K09008	
1	2	3	3	7.5	10	12	20	20	Screw-clamp	4	—	LC1K12004	
<b>4-Pole Mechanically Interlocked Contactors</b>													
1/2	1.5	2	3	5	5	9	20	20	Screw-clamp	4	—	LC2K09004	
1	2	3	3	7.5	10	12	20	20	Screw-clamp	4	—	LC2K12004	

Table 18.13: Coil Voltage Codes for AC Contactors

Vac 50/60 Hz	24	110	120	230/240
Code	B7	F7	G7	U7

Table 18.14: Mini-Contactors with 24 Vdc Operating Coils

Maximum Horsepower Ratings						Maximum Current (A)		Continuous Current Rating (A)	Type of Connection	Auxiliary Contacts		Catalog Number [2]	
Single-Phase		Three-Phase				Inductive AC3	Resistive AC1			N.O.	N.C.		
115 V	230 V	200 V	230 V	460 V	575 V								
0.5	1	1.5	1.5	3	3	6	20	10	Screw-clamp	1	—	LP1K0610BD	
—	—	—	—	—	—	—	—	—	—	—	1	—	LP1K0601BD
0.5	1.5	2	3	5	5	9	20	20	Screw-clamp	1	—	LP1K0910BD	
—	—	—	—	—	—	—	—	—	—	—	1	—	LP1K0901BD
1	2	3	3	7.5	10	12	20	20	Screw-clamp	1	—	LP1K1210BD	
—	—	—	—	—	—	—	—	—	—	—	1	—	LP1K1201BD
<b>4-Pole Mini Contactor</b>													
1/2	1.5	2	3	5	5	9	20	20	Screw-clamp	4	—	LP1K09004BD	
—	—	—	—	—	—	—	—	—	—	2	2	LP1K09008BD	
1	2	3	3	7.5	10	12	20	20	Screw-clamp	4	—	LP1K12004BD	
<b>4-Pole Mechanically Interlocked Contactors</b>													
1/2	1.5	2	3	5	5	9	20	20	Screw-clamp	4	—	LP2K09004BD	
1	2	3	3	7.5	10	12	20	20	Screw-clamp	4	—	LP2K129004BD	

Table 18.15: Mini-Contactors with Low-Consumption 24 Vdc Operating Coil (includes built-in transient suppression) [3]

Maximum Horsepower Ratings						Maximum Current (A)		Continuous Current Rating (A)	Type of Connection	Auxiliary Contacts		Catalog Number [2]	
Single-Phase		Three-Phase				Inductive AC3	Resistive AC1			N.O.	N.C.		
115 V	230 V	200 V	230 V	460 V	575 V								
0.5	1	1.5	1.5	3	3	6	20	10	Screw-clamp	1	—	LP4K0610BW3	
—	—	—	—	—	—	—	—	—	—	—	1	—	LP4K0601BW3
0.5	1.5	2	3	5	5	9	20	20	Screw-clamp	1	—	LP4K0910BW3	
—	—	—	—	—	—	—	—	—	—	—	1	—	LP4K0901BW3
1	2	3	3	7.5	10	12	20	20	Screw-clamp	1	—	LP4K1210BW3	
—	—	—	—	—	—	—	—	—	—	—	1	—	LP4K1201BW3

[1] Complete the catalog number with the coil voltage from (for example LC1K0610G7).

[2] For additional terminal options and coil voltage/consumption options, see Catalog MKTED210011EN. Check with local sales office for availability.

[3] 1.8 W inrush.



### TeSys™ K Overload Relays

Table 18.16: Overload Relays for 3-Pole Contactors with Screw-Clamp Terminals



LR2K0316

Current Setting Range (A)	Catalog Number
0.11 to 0.16	LR2K0301
0.16 to 0.23	LR2K0302
0.23 to 0.36	LR2K0303
0.36 to 0.54	LR2K0304
0.54 to 0.8	LR2K0305
0.8 to 1.2	LR2K0306
1.2 to 1.8	LR2K0307
1.8 to 2.6	LR2K0308
2.6 to 3.7	LR2K0310
3.7 to 5.5	LR2K0312
5.5 to 8	LR2K0314
8 to 11.5	LR2K0316
10 to 14	LR2K0321 [4]

**LR2K overload relays:**

- AC or DC protection
- Ambient compensated bimetallic
- Class 10
- Single phase sensitivity
- Manual or auto reset
- Full load current dial



E164862  
CCN NLDX  
(screw terminals)



E164862  
CCN NLDX2  
(slip-on and solder-pin terminals)



LR43364  
Class 3211 04



Accessories: page 18-18  
Dimensions: page 18-63

### TeSys™ K Reversing Mini-Contactors



LC2K0910

Table 18.17: AC Operating Coils

Maximum Horsepower Ratings						Maximum Current (A)		Continuous Current Rating (A)	Type of Connection	Auxiliary Contacts		Catalog Number [5][6]
Single-Phase		Three-Phase				Inductive AC3	Resistive AC1			N.O.	N.C.	
115 V	230 V	200 V	230 V	460 V	575 V							
1/2	1	1.5	1.5	3	3	6	20	10	Screw-clamp	1	—	LC2K0610
										—	1	LC2K0601
1/2	1.5	2	3	5	5	9	20	20	Screw-clamp	1	—	LC2K0910
										—	1	LC2K0901
1	2	3	3	7.5	10	12	20	20	Screw-clamp	1	—	LC2K1210
										—	1	LC2K1201

Table 18.18: Coil Voltage Codes for AC Contactors

Vac 50/60 Hz Code	24	110	120	230/ 240
	B7	F7	G7	U7

[4] Not UL Listed.

[5] Complete the catalog number with the coil voltage code from Table 18.18 (for example, LC2K0610G7).

[6] For additional terminal options and coil options, see Catalog MKTED210011EN. Check with local sales office for availability.

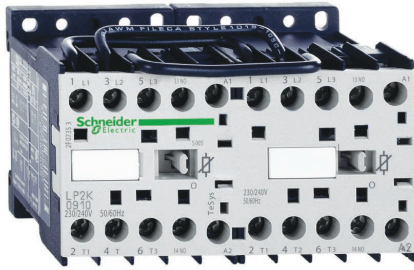

LP2K0910

**Table 18.19: DC Operating Coils**

Maximum Horsepower Ratings						Maximum Current (A)		Continuous Current Rating (A)	Type of Connection	Auxiliary Contacts		Catalog Number [7]		
Single-Phase		Three-Phase				Inductive AC3	Resistive AC1			N.O.	N.C.			
115 V	230 V	200 V	230 V	460 V	575 V									
1/2	1	1.5	1.5	3	3	6	20	10	Screw-clamp	1	—	LP2K0610BD		
—	—	—	—	—	—	—	—	—	—	—	1	—	LP2K0601BD	
1/2	1.5	2	3	5	5	9	20	20	Screw-clamp	1	—	LP2K0910BD		
—	—	—	—	—	—	—	—	—	—	—	1	—	LP2K0901BD	
1	2	3	3	7.5	10	12	20	20	Screw-clamp	1	—	LP2K1210BD		
—	—	—	—	—	—	—	—	—	—	—	—	1	—	LP2K1201BD



LC2K090045

**Table 18.20: Coil Voltage Codes for DC Contactors**

Coil with integral suppression device available. Add 3 to the code required. Example: JD3 [8]

Vdc	12	20	24	36	48	60	72	100	110	125	200	220	230	240	250
Code	JD	ZD	BD	CD	ED	ND	SD	KD	FD	GD	LD	MD	MPD	MUD	UD

**Table 18.21: Coil Voltages for DC Contactors—Low Consumption [9]**

Vdc	12	24	48	72
Code	JW3	BW3	EW3	SW3

Overload Relays: [page 18-9](#)

Accessories: [page 18-18](#)

Dimensions: [page 18-63](#)

[7] For additional terminal options and coil options, see Catalog [MKTED210011EN](#). Check with local sales office for availability.

[8] 3 W inrush.

[9] 1.8 W inrush.

TeSys™ Deca Non-Reversing Contactors



TeSys Deca Contactor

The TeSys™ Deca Control Series of contactors (formerly known as TeSys D) provides high reliability and performance in a modern, modular approach. TeSys Deca contactors are UL approved to 100 hp 480 V and 160 amperes continuous current. In addition, they provide a modern appearance with new features such as multi-standard screw terminals that accommodate flat, Phillips and Pozidriv screwdrivers, as well as the new UL60335 approved plastics with greater endurance in the presence of heat or fire.

Table 18.22: TeSys Deca Contactors—3 or 4 Pole, Screw Terminal Connections

Maximum Horsepower Ratings						Maximum Current (A)		Continuous Current Rating (A)	No. of Poles		Instantaneous Auxiliary Contacts		Catalog Number [10][11]
Single-Phase		Three-Phase				Inductive AC3	Resistive AC1		N.O.	N.C.	N.O.	N.C.	
115 V	230 V	200 V	230 V	460 V	575 V								
1/3	1	2	2	5	7.5	9	20	25	3	0	1	1	LC1D09
—	—	—	—	—	—	—			4				LC1DT20
—	—	—	—	—	—	—			2				LC1D098
1/2	2	3	3	7.5	10	12	25	25	3	0	1	1	LC1D12
—	—	—	—	—	—	—			4				LC1DT25
—	—	—	—	—	—	—			2				LC1D128
1	3	5	5	10	15	18	32	32	3	2	1	1	LC1D18
—	—	—	—	—	—	—			4				LC1DT32
—	—	—	—	—	—	—			2				LC1D188
2	3	7.5	7.5	15	20	25	40	40	3	0	1	1	LC1D25
—	—	—	—	—	—	—			4				LC1DT40
—	—	—	—	—	—	—			2				LC1D258
2	5	10	10	20	25	32	50	50	3	0	1	1	LC1D32
2	5	10	10	20	25	38			3				LC1D38
3	5	10	10	30	30	40			3				LC1D40A
3	7.5	15	15	40	40	50	60	60	4	0	1	1	LC1D60A
5	10	20	20	40	50	65			3				LC1D50A
—	—	—	—	—	—	—			4				LC1D65A
7.5	15	25	30	60	60	80	80	80	3	0	0	0	LC1D80A
—	—	—	—	—	—	—			4				LC1D80
—	—	—	—	—	—	—			2				LC1D80004
7.5	15	25	30	60	60	95	125	110	2	2	0	0	LC1D80008
—	—	—	—	—	—	—			3				LC1D95
—	—	30	40	75	100	115			3				LC1D115
—	—	40	50	100	125	150	200	160	3	0	1	1	LC1D150
—	—	—	—	—	—	—			4				LC1D115004

Table 18.23: TeSys Deca Coil Voltage Codes

Contactor	D09–D38	D40A–D65A	D80–D150
<b>AC 50/60 Hz</b>			
24 V	B7	B7	B7
110 V	F7	F7	F7
120 V	G7	G7[12]	G7
240 V	U7	U7	U7
480 V	T7	T7[12]	T7
<b>AC/DC</b>			
24–60 V	BNE	BNE	—
48–130 V	EHE	EHE	—
100–250 V	KUE	KUE	—
<b>DC</b>			
24 V	BL	BBE	BD

[10] Complete the catalog number by adding the coil voltage code from Table 18.23 TeSys Deca Coil Voltage Codes, page 18-11 for example, LC1D09G7).

[11] For additional terminal options and coil options, see Catalog MKTED210011EN. Check with local sales office for availability.

[12] Contactors LC1D40A...80A, LC1DT60A and LC1DT80A for this coil voltage are 60 Hz only.

Table 18.24: Definite Purpose Ratings, 3-Phase, Breaking All Lines, 100,000 Cycles (Hermetic Refrigeration Compressor)

Device	FLA	LRA		
		240 V	480 V	600 V
LC1D09 (AC coil only)	9	54	45	36
LC1D12 (AC coil only)	12	72	60	48
LC1D18 (AC coil only)	18	108	90	72
LC1D25 (AC coil only)	25	150	125	100
LC1D32 (AC coil only)	32	192	160	128
LC1D40A	40	240	200	160
LC1D50A	50	300	250	200
LC1D65A	65	390	325	260
LC1D80	75	450	375	300
LC1D115	115	690	575	460
LC1D150	150	900	750	600

TeSys™ Deca Overload Relays



LRD07



LR9D32

Table 18.25: TeSys™ Deca Overload Relays—Ambient Compensated, Bimetallic, Direct Mounting

Current Setting Range (A)	For Direct Mounting to LC1D/LC2D...	Class 10 with Single-Phase Sensitivity	Class 10 without Single-Phase Sensitivity	Class 20 with Single-Phase Sensitivity	Class 20 without Single-Phase Sensitivity
0.10–0.16	D09–D38	LRD01	LR3D01	—	—
0.16–0.25		LRD02	LR3D02	—	—
0.25–0.40		LRD03	LR3D03	—	—
0.40–0.63		LRD04	LR3D04	—	—
0.63–1		LRD05	LR3D05	LRD05L	—
1–1.6		LRD06	LR3D06	LRD06L	—
1.6–2.5		LRD07	LR3D07	LRD07L	LR3D07L
2.5–4		LRD08	LR3D08	LRD08L	LR3D08L
4–6		LRD10	LR3D10	LRD10L	LR3D10L
5.5–8		LRD12	LR3D12	LRD12L	LR3D12L
7–10		LRD14	LR3D14	LRD14L	LR3D14L
9–13		LRD16	LR3D16	LRD16L	LR3D21L
12–18		D18–D38	LRD21	LR3D21	LRD21L
16–24	D25–D38	LRD22	LR3D22	—	—
17–24	D25–D38	—	—	LRD22L	LR3D22L
23–32	D25–D38	LRD32	LR3D32	LRD32L	LR3D32L
30–38	D32–D38	LRD35	LR3D35	—	—
9–13	D40A–D65A	LRD313	LR3D313	LRD313L	—
12–18	D40A–D65A	LRD318	LR3D318	LRD318L	—
17–25	D40A–D65A	LRD325	LR3D325	LRD325L	—
23–32	D40A–D65A	LRD332	LR3D332	LRD332L	—
30–40	D40A–D65A	LRD340	LR3D340	LRD340L	—
37–50	D40A–D65A	LRD350	LR3D350	LRD350L	—
48–65	D40A–D65A	LRD365	LR3D365	LRD365L	—
17–25	D40–D95	LRD3322	LR3D3322	LRD23522	LR3D3522
23–32	D40–D95 [13]	LRD3353	LR3D3353	LRD23553	LR3D3553
30–40	D40–D95 [13]	LRD3355	LR3D3355	LRD23555	LR3D3555
37–50	D50–D95 [13]	LRD3357	LR3D3357	LRD23557	LR3D3557
48–65	D50–D95 [13]	LRD3359	LR3D3359	LRD23559	LR3D3559
55–70	D65–D95	LRD3361	LR3D3361	LRD23561	LR3D3561
63–80	D65–D95	LRD3363	LR3D3363	LRD23563	LR3D3563
80–104	D95	LRD3365	—	—	—
80–104	D115–D150	LRD4365	—	—	—
95–120	D115–D150	LRD4367	—	—	—
110–140	D150	LRD4369	—	—	—

[13] Direct Mount to old D2 style D40 to D65 (no Everlink terminations) and to D80 and D95 only.

**Table 18.26: TeSys Deca Electronic Overload Relays 01 to 32 Amperes**

Current Setting Range (A)	For Direct Mounting Beneath Contactor LC1D/ LC2D	Class 5/10/20/30 Selectable
0.1–0.5	D09–D38	LR9D01
0.4–2	D09–D38	LR9D02
1.6–8	D09–D38	LR9D08
6.4–32	D09–D38	LR9D32

**Table 18.27: TeSys Deca Electronic Overload Relays 60 to 150 Amperes**

Current Setting Range (A)	For Direct Mounting Beneath Contactor LC1	Class 10	Class 20	Class 10/20 Selectable
60–100	D115–D150	LR9D5367	LR9D5567	LR9D67
90–150	D115–D150	LR9D5369	LR9D5569	LR9D69

TeSys Deca contactor accessories: [page 18-19](#)  
 TeSys Deca overload relay accessories: [page 18-28](#)  
 TeSys Deca replacement coils: [page 18-43](#)  
 Dimensions: [page 18-46](#) to [page 18-58](#)

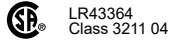

### TeSys™ Deca Reversing Contactors

Each 3-pole device is pre-wired with line and load side power wiring for reversing applications. Each 4-pole device is prewired with load side power wiring.

**Table 18.28: TeSys Deca Mechanically-Interlocked Reversing Contactors**

	Maximum Horsepower Ratings						Maximum Current (A)		Continuous Current Rating (A)	No. of N.O. Power Poles	Built In Auxiliary Contacts (per contactor)		Catalog Number [14][15][16]
	Single-Phase		Three-Phase				Inductive AC3	Resistive AC1			N.O.	N.C.	
	115 V	230 V	200 V	230 V	460 V	575 V							
 <p>LC2D09B7</p>	1/3	1	2	2	5	7.5	9	20	25	3	1	1	LC2D09
	1/2	2	3	3	7.5	10	12	25	25	3	1	1	LC2D12
	1	3	5	5	10	15	18	32	32	3	1	1	LC2D18
	2	3	7.5	7.5	15	20	25	40	40	3	1	1	LC2D25
	2	5	10	10	20	25	32	50	50	3	1	1	LC2D32
	2	5	10	10	20	25	38			3	1	1	LC2D38
	3	5	10	10	30	30	40	60	60	3	1	1	LC2D40A
	3	7.5	15	15	40	40	50	80	70	3	1	1	LC2D50A
	5	10	20	20	40	50	65			3	1	1	LC2D65A
	7.5	15	25	30	60	60	80	125	110	3	1	1	LC2D80
	7.5	15	25	30	60	60	95			3	1	1	LC2D95
	—	—	30	40	75	100	115	200	160	3	1	1	LC2D115[17]
	—	—	40	50	100	125	150			3	1	1	LC2D150 [17]

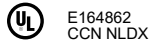

E164862  
CCN NLDX



LR43364  
Class 3211 04



TeSys Deca contactor accessories: [page 18-19](#)  
 TeSys Deca replacement coils: [page 18-43](#)  
 TeSys Deca dimensions: [page 18-46](#) to [page 18-58](#)

[14] Includes mechanical interlock without electrical contacts. Installer to complete wiring for electronically interlocking contactor operating coils by using a N.C. auxiliary contact integrated in the contactor or optional LADN or LAD8N auxiliary contact block.  
 [15] Complete the catalog number by adding the coil voltage code from [Table 18.23 TeSys Deca Coil Voltage Codes](#), [page 18-11](#) (for example, LC2D09KUE).  
 [16] For additional terminal options and coil voltage/consumption options, see Catalog [MKTED210011EN](#). Check with local sales office for availability.  
 [17] Includes mechanical interlock (LA9D11502) with prewired electrical contacts for interlocking contactor operating coils.

**TeSys™ Giga Non-Reversing Contactors**

TeSys™ Giga Series is the newest motor control range for large motor and large load applications. This new offering brings greater performance, panel design optimization, and enhanced ease of installation.

TeSys Giga contactors are available in 115 to 800 amperes in both 3-pole and 4-pole configurations. Designers can choose between the standard version and an advanced version. The advanced version provides additional features such as additional coil voltages, lower coil consumption, PLC input control, and a cable memory feature that permits maintenance without removing cables or busbar connections. For lug options, see [Table 18.59 Lugs and Mounting for TeSys™ Giga Contactors and Overload Relays](#), page 18-24.



TeSys™ Giga Contactors — Standard



TeSys™ Giga Contactors — Advanced

**Table 18.29: TeSys Giga Contactors — 3-Pole Standard Version**

Motor rating (hp) UL 3-phase				General purpose continuous current (A)	Reference Standard version contactors AC/DC coil voltage 3-pole <sup>[18]</sup>	
200/208 V	230/240 V	460/480V	575/600 V		UL	48–130 V
30	40	75	100	210	LC1G115EHEN	LC1G115KUEN
40	50	100	125	230	LC1G150EHEN	LC1G150KUEN
50	60	125	150	250	LC1G185EHEN	LC1G185KUEN
60	75	150	150	290	LC1G225EHEN	LC1G225KUEN
75	100	200	200	340	LC1G265EHEN	LC1G265KUEN
100	125	250	300	390	LC1G330EHEN	LC1G330KUEN
125	150	300	400	490	LC1G400EHEN	LC1G400KUEN
150	200	400	450	630	LC1G500EHEN	LC1G500KUEN
250	300	600	700	850	LC1G630EHEN <sup>[19]</sup>	LC1G630KUEN <sup>[19]</sup>
300	350	700	800	900	LC1G800EHEN <sup>[19]</sup>	LC1G800KUEN <sup>[19]</sup>

**Table 18.30: TeSys Giga Contactors — 3-Pole Advanced Version**

Motor rating (hp) UL 3-phase				General purpose continuous current (A)	Reference Standard version contactors AC/DC coil voltage 3-pole <sup>[18]</sup>		
200/208 V	230/240 V	460/480 V	575/600 V		UL	24–48 V <sup>[19]</sup>	48–130 V <sup>[19]</sup>
30	40	75	100	210	LC1G115BEHA	LC1G115EHEA	LC1G115LEA
40	50	100	125	230	LC1G150BEHA	LC1G150EHEA	LC1G150LEA
50	60	125	150	250	LC1G185BEHA	LC1G185EHEA	LC1G185LEA
60	75	150	150	290	LC1G225BEHA	LC1G225EHEA	LC1G225LEA
75	100	200	200	340	LC1G265BEHA	LC1G265EHEA	LC1G265LEA
100	125	250	300	390	LC1G330BEHA	LC1G330EHEA	LC1G330LEA
125	150	300	400	490	LC1G400BEHA	LC1G400EHEA	LC1G400LEA
150	200	400	450	630	LC1G500BEHA	LC1G500EHEA	LC1G500LEA
250	300	600	700	850	—	LC1G630EHEA	LC1G630LEA <sup>[19]</sup>
300	350	700	800	900	—	LC1G800EHEA	LC1G800LEA <sup>[19]</sup>

[18] See **MKTED210011EN** for 4-pole contactors and additional accessories.  
[19] Available 2Q 2022.



### TeSys™ Giga Overload Relays

TeSys™ Giga electronic overload relays provide wide protection flexibility in a limited number of references that cover up to 630 amperes. Alarm and status LEDs inform users in real time. Ground fault, phase imbalance, trip class (5E, 10E, 20E, 30E), and reset type can easily be configured on the device. Units can be directly mounted to the TeSys Giga contactors or can be individually wired.

Table 18.31: TeSys™ Giga 3-Pole Overload Relays

Relay setting range	For direct mounting beneath contactor LC1G	Reference
<b>A Class 5...30 A</b>		
28...115	LC1G115...225	LR9G115
57...225	LC1G115...225	LR9G225
125...500	LC1G265...500	LR9G500
160...630	LC1G630	LR9G630 <sup>[20]</sup>



LR9G225

### TeSys™ Giga Reversing Contactors

Components are available for customer assembly of TeSys™ Giga reversing contactors. For example, the following components must be ordered to build a reversing contactor, 200 hp at 460 V, with a 100–250 V AC/DC coil.

Table 18.32: Components Required for Building a Reversing Contactor

Description	Quantity	Reference
Contactors	2	LC1G265KUEN
Lugs	1	DZ2FJ6
Terminal Mounting	2	LA9G3612
Auxiliary Contacts	(included)	–
Power Connections	1	LA9G3761
Mechanical Interlock	1	LA9G970

[20] Available 2Q 2022.

**TeSys™ F Non-Reversing Contactors**

**Table 18.33: TeSys F Contactors—3 Pole**

	Maximum Three-Phase Horsepower Ratings				Maximum Current (A)		Continuous Current Rating (A)	Number of Poles	Catalog Number [21]	
	200 V	230 V	460 V	575 V	Inductive AC-3	Resistive AC-1			[22]	
 <p>LC1700, F2100</p>	350	400	900	—	1000	1000	1250	3	LC1F1000	
	—	450	900	900	780	1600	1350	3	LC1F780	
	Current Rated						1400	1400	3	LC1F1400
							1700	1700	3	LC1F1700
							2100	2100	3	LC1F2100

**Table 18.34: TeSys F Coil Voltage Codes [22]**

Contactor	F780[23]	F1000	F1400–F2100
Coil Suffix Code AC 50/60 Hz			
120 V	G7	G7	G7
Coil Part Number (Order Separately) AC 50/60 Hz			
120 V	LX1FX110	LX1FK065[24]	LX1FK070[24]
240 V	LX1FX220	LX1FK127[24]	LX1FK127[24]
480 V	LX1FX415	LX1FK240[24]	LX1FK240[24]
Coil Part Number (Order Separately) DC			
24 V	—	—	—

[21] Complete the catalog number by adding the coil voltage code from Table 18.34 TeSys F Coil Voltage Codes

[21] For additional pole options and coil voltage options, see Catalog . Check with local sales office for availability.

[21] For additional pole options and coil voltage options, see Catalog . Check with local sales office for availability. , page 18-17 (for example, LC1F265G7), or order the contactor (without a coil) and the coil separately. All coils except F780 include 1 N.O. holding circuit interlock contact. The F780 uses two coils that must be wired in series.

[22] For additional pole options and coil voltage options, see Catalog MKTED210011EN. Check with local sales office for availability.

[23] LC1F780 contactors operate with 2 coils as a set. The LX1FX\* part number includes both coils.

[24] Order 2 coils and connect them in series.

TeSys™ K Contactors

Table 18.35: Instantaneous Auxiliary Contact Blocks<sup>[1]</sup>



Clip-on front mounting, 1 block per contactor and 2 blocks per pair of mechanically interlocked contactors			
Type of connection	Auxiliary Contacts		Catalog Number
	N.O.	N.C.	
Screw clamp	2	—	LA1KN20
	—	2	LA1KN02
	1	1	LA1KN11
	4	—	LA1KN40 [2]
	3	1	LA1KN31 [2]
	2	2	LA1KN22 [2]
	1	3	LA1KN13 [2]
	—	4	LA1KN04 [2]

Table 18.36: Electronic Time Delay Auxiliary Contact Blocks

Clip-on front mounting, 1 block per contactor and 2 blocks per pair of mechanically interlocked contactors				
Voltage (V)	Type	Timing Range (S)	Contacts	Catalog Number
24–48 Vac or Vdc	On-delay	1–30	SPDT	LA2KT2E
110–240 Vac	On-delay	1–30	SPDT	LA2KT2U

**NOTE:** Relay outputs, with single pole double throw, 240 Vac/Vdc, 2 A max.  
Maximum switching capacity 250 VA / 150 W  
Operating temperature: –10 to +60°C (14 to 140°F)  
Reset time: 1.5 s during time delay, 0.5 after time delay

Table 18.37: Suppressor Module with Incorporated LED Indicator

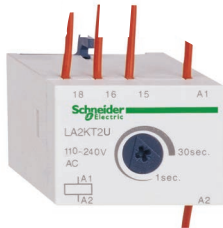

Clip-on front mounting			
Voltage range	Type	Sold in lots of	Catalog Number
12–24 Vac/Vdc	Varistor	5	LA4KE1B [3]
32–48 Vac/Vdc	Varistor	5	LA4KE1E [3]
50–129 Vac/Vdc	Varistor	5	LA4KE1FC [3]
130–250 Vac/Vdc	Varistor	5	LA4KE1UG [3]
12–24 Vdc	Diode + Zener	5	LA4KC1B [4]
32–48 Vdc	Diode + Zener	5	LA4KC1E [4]
220–250 Vac	RC	5	LA4KA1U [5]

Table 18.38: Power Connectors

Description	Sold in lots of	Catalog Number
Set of 6 power connections for reversing contactors with screw-clamp terminals	100	LA9K0969

Table 18.39: Accessories for Overload Relays

Description	Type of Connection	Catalog Number
Terminal block for separate clip-on mounting of the overload relay onto 35 mm omega rail (AM1DP200)	Screw-clamp	LA7K0064



[1] For additional terminal options, see Catalog MKTED210011EN. Check with local sales office for availability.  
 [2] Block of 4 contacts cannot be used with LP4K or LP5K contactors.  
 [3] Protection by limitation of the transient voltage to 2 Uc maximum. Maximum reduction of the transient voltage peaks. Slight time delay on drop-out (1.1–1.5 times normal).  
 [4] No overvoltage or oscillation frequency. Polarized component. Slight time delay on drop-out (1.1–1.5 times normal).  
 [5] Protection by limitation of the transient voltage to 3 Uc maximum and limitation of the oscillation frequency. Slight time delay on drop-out (1.2 times normal).

### TeSys™ Deca and F Auxiliary Contacts, Time Delay, Mechanical Latch

Table 18.40: Standard, Instantaneous Auxiliary Contact Blocks



Front Mounted Auxiliary Blocks

Snap-On Mounting	Number of Contacts	Contact Arrangement		Catalog Number [6]
		N.O.	N.C.	
To the front of LC•DT20–D258 (4P), LC•D09–D150 [6] or To the right side of LC•F	4 [6]	2	2	LADN22 [7]
		1	3	LADN13 [7]
		4	0	LADN40 [7]
		0	4	LADN04 [7]
	2	3	1	LADN31 [7]
		2	2	LADC22 [7] [8]
		1	1	LADN11 [7]
		2	0	LADN20 [7]
To the front of LC•D80–D150 or To the left side of LC•F	1	0	2	LADN02 [7]
		1	0	LADN10 [9]
To the side of LC•D09 to D150 only (not for use on TeSys F)	2	0	1	LADN01 [9]
		1	1	LAD8N11 [10]
		2	0	LAD8N20 [10]

Table 18.41: Instantaneous Blocks with Dust-Tight Auxiliary Contacts (IP54) NEMA 12

Snap-On Mounting	Standard Contacts		Dust-Tight Contacts		Catalog Number
	N.O.	N.C.	N.O.	N.C.	
To the front of LP•D40–D80, LC•DT20–D258 (4P), LC•D09 to D95 or To the right side of LC•F	—	—	2	—	LA1DX20
	2	—	2	—	LA1DZ40
	1	1	2	—	LA1DZ31
	—	—	2	—	LA1DY20 [11]

Table 18.42: Pneumatic Time Delay Contact Blocks

Snap-On Mounting	Time Delay Contacts		Type	Range of Time Delay	Catalog Number [12]
	N.O.	N.C.			
To the front of LP•D40–D80, LC•DT20–D258 (4P), LC•D09 to D150 or To the right side of LC•F	1	1	On energization (on delay)	0.1 to 3 s [13]	LADT0
				0.1 to 30 s	LADT2
	10 to 180 s	LADT4			
	1 to 30 s [14]	LADS2			
1	1	On de-energization (off-delay)	0.1 to 3 s [13]	LADR0	
			0.1 to 30 s	LADR2	
10 to 180 s	LADR4				

Table 18.43: Mechanical Latch Blocks with Manual or Electrical Unlatch (TeSys™ Deca only)

Front snap-on mounting onto	Application	Catalog Number [15]
LC•D09 to D65A	For silent operation and energy conservation	LAD6K10 [16][17]
LC1D80 to D150, LP1D80	For silent operation and energy conservation	LA6DK20 [16]

Table 18.44: Coil Voltage Codes for LAD6K/LA6DK Mechanical Latch Blocks

Volts	24	110/127	220/240
AC or DC	B	F	M



TeSys Deca contactors: TeSys™ Deca Non-Reversing Contactors, page 18-11 and TeSys™ Deca Reversing Contactors, page 18-14  
TeSys Deca overload relay accessories: page 18-28  
TeSys Deca replacement coils: page 18-43  
TeSys Deca dimensions: page 18-46 to page 18-58

[6] For low consumption coils (LC1D09–D38 only), only one front-mounted two-contact block allowed. No side-mounted contact blocks allowed.  
[7] For spring terminal versions of these blocks, add a 3 to the end of the catalog number (for example, LADN223). For slip-on versions, add 9 to the end of the catalog number (for example, LADN229).  
[8] Including 1 N.O. + 1 N.C. make-before break overlapping contacts.  
[9] This block cannot be added to the LC1D 09–D38 contactors; a maximum of 2 blocks can be mounted on the LC1D40A-LC1P/LP1D80 contactors only.  
[10] 1 block may be added to the left side of LC1D09–D38, AC coils only; only 1 block may be added to either side of the LC1D40A-D80 contactors, AC coils only. Cannot be installed on TeSys Deca contactors with DC coils.  
[11] Device supplied with 4 ground terminal points.  
[12] For spring terminal versions of these blocks, add a 3 to the end of the catalog number (for example, LADT23).  
[13] Scale range is expanded between 0.1 and 0.6 seconds on the dial for more accurate settings at the lower end of the range.  
[14] Switching time between the opening of the N.C. contact and the closing of the N.O. contact: 40 ms ± 15 ms.  
[15] To complete the catalog number, add the coil voltage code from Table 18.44. For additional voltage options, see Catalog MKTED210011EN. Check with local sales office for availability.  
[16] Does not include internal coil clearing contact.  
[17] Low consumption DC contactors (and relays) (code coil •L) are not compatible with the LAD6K10• mechanical latching blocks.

TeSys™ Deca Accessories [18]

Table 18.45: For Power Pole or Control Connection

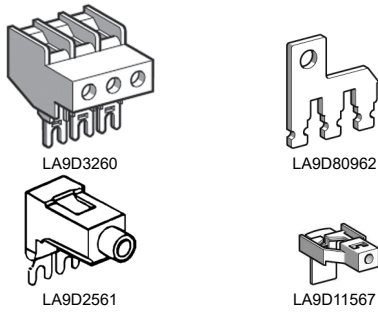

Description		For use with contactors LC1/LP1	Sold in lots of	Catalog Number
Connectors for larger cable sizes	3 poles #4 AWG (25 mm <sup>2</sup> )	D09–D38	1	LA9D3260
Everlink™ terminal block	3 poles	D40A–D65A	1	LAD96560
Links for the parallel connection of:	3 poles (wye-delta shorting strap)	D09–D38	10	LAD9P3
		D40A–D65A	1	LAD9P33
		D80, D95	1	LA9D80962
		F115	1	LA9FF601
		F150, F185	1	LA9FG601
		F225, F265, F330, F400	1	LA9FH601
		F500	1	LA9FK601
Control circuit take-off from main pole		D80, D95	10	LA9D8067
		D115, D150	10	LA9D11567
Replacement power terminal block		D115, D150	1	LA9D115603
Plunger (fire pump accessory)		D09–150	—	LAD9FP3

Table 18.46: For Marking

Description		For use with contactors LC1/LP1	Sold in lots of	Catalog Number
Reference label holder	Snap-on, 8 x 22 mm	4-pole contactors D80–D115	100	LA9D92
	Snap-on, 8 x 18 mm, 3 poles	D09–D65A, DT20–DT80A, LADN, LADT, LADR	100	LAD90
Sheet of 300 labels self adhesive, 7 x 21 mm		For holder LA9D92	1	LA9D93

Table 18.47: For Mounting

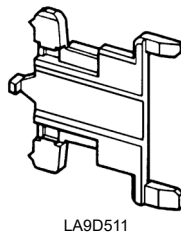

Description		For use with contactors LC1/LP1	Sold in lots of	Catalog Number
Set of shims for mounting LAD8N and LA8DN		D80–D95	1	LA9D511
Retrofit plate for replacing LC1D40–D65 with LC1D40A–D65A		D40A–D65A	1	LAD7X3
35 mm DIN Rail — 2 m		LC1D09–D80	10	AM1DP200

Table 18.48: Replacement Contacts

	For use with contactors		Catalog Number
Three-pole	LC1D115	3 poles	LA5D1158031
	LC1D150	3 poles	LA5D150803
Four-pole	LC1D115	4 poles	LA5D115804

Table 18.49: Arc Chambers

	For use with contactors		Catalog Number
Three-pole	LC1D115	3 poles	LA5D11550
	LC1D150	3 poles	LA5D15050
Four-pole	LC1D115	4 poles	LA5D115450

TeSys Deca contactors: page 18-11 and page 18-14  
 TeSys Deca overload relay accessories: page 18-28  
 TeSys Deca contactor accessories: page 18-19  
 TeSys Deca replacement coils: page 18-43  
 TeSys Deca dimensions: page 18-46 to page 18-58  
 TeSys F contactors: page 18-17 and page 18-18  
 TeSys F replacement coils and parts: page 18-44, page 18-45, and page 18-46

[18] For additional accessory and replacement part options, see Catalog MKTED210011EN. Check with local sales office for availability.

**RC and Varistor Coil Suppressors**

**RC Coil Suppressor**



LA4DA1U

- Limitation of transient voltage to 300% of nominal voltage maximum.
- Oscillating frequency limited to 400 Hz maximum. Slight increase in drop-out time (1.2–2 times normal).

**Table 18.50: Resistor/Capacitor Circuit (RC) for Reduction of Electrical Noise in AC Contactor Coils**

Installed by	Mounting on	Operating Voltage 50/60 Hz	Catalog Number
Snapping into the cavity on the right side without tools [19]	LC•D09–D38 (3P), LC1DT20–DT40 (4P)	24–28 Vac	LAD4RCE
		50–127 Vac	LAD4RCG
		110–240 Vac	LAD4RCU
Snap-on mounting, and connection without tools to the contactor coil terminals	LC1D40A–65A (3P), LC1DT60A–DT80A (4P)	24–48 Vac	LAD4RC3E
		50–127 Vac	LAD4RC3G
		110–240 Vac	LAD4RC3U
		380–415 Vac	LAD4RC3N
Screw connection to the contactor coil terminals	LC•D80–D150 (3P), LC1D80–D115 (4P)	24–48 Vac	LA4DA2E
		50–127 Vac	LA4DA2G
		110–240 Vac	LA4DA2U
		380–415 Vac	LA4DA2N

**Varistor Coil Suppressor[20]**

- Limitation of transient voltage value to 200% of nominal voltage maximum.
- Maximum reduction of transient voltage peaks. Slight increase in drop-out time (1.1–1.5 times normal).

**Table 18.51: Varistor (Peak Limiting) for Reduction of Electrical Noise in AC Contactor Coils**

Installed by	Mounting on	Operating Voltage	Catalog Number
Snapping into the cavity on the right side without tools [19]	LC•D09–D38 (3P), LC1DT20–DT40 (4P)	24–48 Vac	LAD4VE
		110–250 Vac	LAD4VU
Snap-on mounting, and connection without tools to the contactor coil terminals	LC1D40A–D65A (3P), LC1DT60A–DT80A (4P)	24–48 Vac/Vdc	LAD4V3E
		110–250 Vac/Vdc	LAD4V3U
Screw connection to the contactor coil terminals	LC•D80–D115 (3P), LC1D80–D115 (4P)	24–48 Vac	LA4DE2E
		110–250 Vac	LA4DE2U
Screw connection to the contactor coil terminals	LC•D80–D95 (3P), LC1D80 (4P)	24–48 Vdc	LA4DE3E
		110–250 Vdc	LA4DE3U

**Diode Coil Suppressor**

- No overvoltage or oscillating frequency.
- Polarized component. Increased drop-out time (6–10 times normal).



LA4DC3U

**Table 18.52: Diode for Reduction of Electrical Noise in DC Contactor Coils**

Installed on the upper part by	Mounting on	Operating Voltage, DC	Catalog Number
Snap-on mounting and connection w/o tools to the contactor coil terminals	LC•D09 to D38 (3P), LC1DT20 to DT40 (4P)	24–250 Vdc	LAD4DDL
Clip-on front mounting	LC•D40A to D65A (3P), LC1DT60A to DT80A (4P)	24–250 Vdc	LAD4D3U
Screw connection of wire to the contactor coil terminals	LC•D80 to D95 (3P), LC1D80 (4P)	24–250 Vdc	LA4DC3U

[19] Installing the suppressor into the cavity makes the electrical connection. Overall width of the contactor remains the same.  
[20] For additional accessory and replacement part options, see Catalog MKTED210011EN. Check with local sales office for availability.

### Bidirectional Diode Coil Suppressor

- Protection provided by limiting the transient voltage to 2 Uc max.
- Maximum reduction of transient voltage peaks

Table 18.53: Bidirectional Peak Limiting Diode<sup>[21]</sup>

Installed by	Mounting on	Operating Voltage		Catalog Number
		Vac (50/60 Hz)	Vdc	
Snapping into the cavity on the right side of the contactor <sup>[22]</sup>	LC•D09–D38 (3P) <sup>[23]</sup>	24	—	LAD4TB
	LC1DT20–DT40 (4P)	—	24	LAD4TBDL
Clip-on front mounting and connection without tools to the contactor coil terminals <sup>[23]</sup>	LC•D40A–D65A (3P), LC1DT60A–DT80A (4P)	12–24	12–24	LAD4T3B
Screw mounting <sup>[24]</sup>	LC•D80–D95 (3P), LC1D80 (4P)	—	24	LA4DB3B

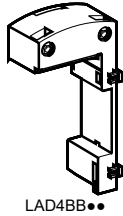
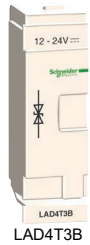

Table 18.54: Cabling Accessories<sup>[21]</sup>

Usage	Mounting on	Operating Voltage 50/60 Hz	Catalog Number
For adapting existing wiring to a new product or for use with top-mounting accessory.	LC1D09–D38	Without coil suppression	LAD4BB
		With coil suppression (varistor)	LAD4BBVE
For adapting existing wiring to a new product or for use with top-mounting accessory	LC1D40A–D65A	24–48 Vac	LAD4BBVG
		50–127 Vac	LAD4BB3

TeSys Deca contactors: TeSys™ Deca Non-Reversing Contactors, page 18-11 TeSys™ Deca Reversing Contactors, page 18-14 and TeSys Deca contactor accessories: page 18-19  
TeSys Deca overload relay accessories: page 18-28  
TeSys Deca replacement coils: page 18-43  
TeSys Deca dimensions: page 18-46 to page 18-58

### TeSys™ Deca Electronic Timers and Interface Modules

The following accessories require use of cabling accessories (LAD4BB••) for proper mounting. See page 18-22 for illustration.

Table 18.55: Electronic Serial Timer Modules

Type	Operational Voltage <sup>[25]</sup>		Time Delay	Catalog Number
	24–250 Vac	100–250 Vac		
On-delay	LC1D09–D65A	LC1D80–D150	0.1–2 s	LA4DT0U
			1.5–30 s	LA4DT2U
			25–500 s	LA4DT4U



Table 18.56: Interface Modules<sup>[21]</sup>

Interface Type <sup>[26]</sup>	Operational Voltage		Input Voltage	Catalog Number
	24–250 Vac	100–250 Vac		
Relay	LC1D09–D150	—	24 Vdc	LA4DFB
Solid State	LC1D09–D65A	LC1D80–D115	24 Vdc	LA4DWB

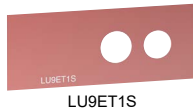

Table 18.57: TeSys™ Safety-Chain Identification System

Description	Compatibility	Package Qty	Catalog Number
Red retrofit contactor safety cover	LC1D09–D65A, CAD32, CAD50	10	LAD9ET1S
	LC1D80	1	LAD9ET3S
	LC1D115–D150	1	LAD9ET4S
Red auxiliary contact block, 2 N.O. + 2 N.C.	LC1D09–D150, CAD32, CAD50	1	LADN22S
Red retrofit safety sticker	TeSys™ Ultra	10	LU9ET1S

[21] For additional voltage and accessory options, see Catalog MKTED210011EN. Check with local sales office for availability.

[22] Installing the suppressor into the cavity makes the electrical connection. Overall width of the contactor remains the same.

[23] For LC•D09–LC•D65A with DC or low consumption DC coils, 3–pole contactors are fitted with built-in bidirectional diode suppression as standard.

[24] Mounting at the top of the contactor on coil terminals A1 and A2.

[25] For 24 V operation, the contactor must be fitted with a 21 V coil: coil voltage code Z5 for 50 Hz; Z6 for 60 Hz; and ZD for DC.

[26] Adapter required for D09–D65A, see .



**TeSys™ Deca Reversing Contactors**

**Table 18.58: Components and Kits for Reversing Assemblies<sup>[27]</sup>**

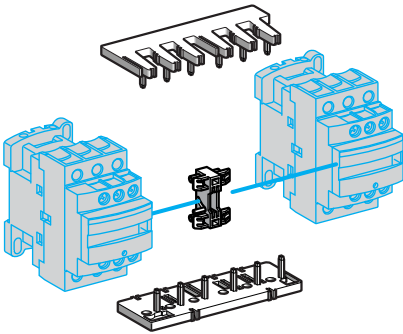
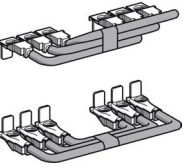



	Description		For contactor (2 identical contactors)	Part Number
<b>Kits for Assembly of Reversing Contactors</b>				
 <p>LAD 9R1</p>	Kit comprising of: <ul style="list-style-type: none"> <li>• Mechanical interlock</li> <li>• Electrical wiring links</li> <li>• Power wiring links</li> </ul>		LC1 D09 to D38	LAD9R1V
			LC1 DT20 to DT40	
 <p>LA9 D8069</p>	Kit comprising of: <ul style="list-style-type: none"> <li>• Mechanical interlock</li> <li>• Power wiring links</li> </ul>		LC1 D09 to D38	LAD9R1
			LC1 D40A to D65A	
	<b>For Contactor (2 Identical Contactors)</b>	<b>Mechanical Interlock</b>	<b>Mechanical Interlock with Integral Electrical Interlocking</b>	<b>Reversing Power Links (Parallel and Reverser)</b>
<b>Components for Assembly of Reversing Contactors</b>				
	LC1 D40A to D65A	LAD4CM	—	LA9D65A69
	LC1 D80 to D95 (AC coil)	LA9D50978	LA9D4002	LA9D8069
	LC1 D80 to D95 (DC coil)	LA9D80978	LA9D8002	LA9D8069
	LC1 D115 to LC1D 150	—	LA9D11502	LA9D11569

TeSys Deca contactors: TeSys™ Deca Non-Reversing Contactors, page 18-11 and TeSys™ Deca Reversing Contactors, page 18-14  
 TeSys Deca contactor accessories: page 18-19  
 TeSys Deca replacement coils: page 18-43  
 TeSys Deca dimensions: page 18-46 to page 18-58

[27] For additional reversing accessory options, see Catalog MKTED210011EN. Check with local sales office for availability.

Lugs and Mounting

Table 18.59: Lugs and Mounting for TeSys™ Giga Contactors and Overload Relays<sup>[28]</sup>

						
Reference	DZ2FG1 (includes 1 lug, (6 required))	DZ2FH1 (includes 1 lug, (6 required))	DZ2FJ1 (includes 1 lug, (6 required))	DZ2FK1 (includes 1 lug, (6 required))		DZ2FL1 (includes 1 lug, (6 required))
Rating	200	275	500	630		800
Wire range	6 to 3/0 AWG	6 to 300 MCM	4 to 500 MCM	2 to 600 MCM		2 to 600 MCM
For use with LC1	G115, G225	G115, G225	G115, G225, G265, G330, G400, G500	G265, G330, G400, G500	G630, G800	G630, G800
For use with LR9	G115, G225	G115, G225	G115, G225, G500	G500	G630	G630
Box lug spreader bar (required)	LA9G3711	LA9G3711	LA9G3711, LA9G3712	LA9G3712	LA9G3714	LA9G3714

					
Reference	AL400L61K3 (includes 3 lugs)		AL600LS52K3 (includes 3 lugs)	AI800M23K (includes 3 lugs)	AI800P6K (includes 3 lugs)
Rating (A)	400		400/600	800	800
Wire range	2 to 500 MCM (AL) 2 to 600 MCM (CU)		2/0 to 500 MCM (AL or CU)	3/0 to 500 MCM (AL or CU)	3/0 to 600 MCM (AL or CU)
For use with LC1	G115, G225	G265, G330 G400, G500	G265, G330 G400, G500	G630, G800	G630, G800
For use with LR9	G115, G225	G500	G500	G630	G630
Box lug spreader bar (required)	LA9G3711	LA9G3712	LA9G3712	LA9G3714	LA9G3714

LA9G3611 Spreader Bar

LA9G3601 Straight Bar

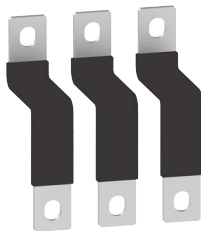

LA9G3111

Flexible Terminal Extensions

Flexible connecting bars to connect TeSys Giga High power contactors with MCCBs mounted in the same plane and orientation. These bars can be used along with Advanced or Standard version contactors. They help to get a quick and easy connection between contactor and MCCB with saving in installation time.

Table 18.60: Flexible Terminal Extensions for MCCBs

Description	Compatible with Contactors	To connect with PowerPac™ MCCB	Quantity Set of	Reference
Flexible terminal extensions 3-pole	LC1G115...LC1G225	H-J Frame 3P, GV5PB	3	LA9G3111
	LC1G265...LC1G500	L Frame 3P, GV6PB	3	LA9G3112
	LC1G630...LC1G800	P Frame 3P	3	LA9G3113

[28] See [MKTED210011EN](#) for additional accessories.



LAG8N13

### Auxiliary Contact Modules

Auxiliary contacts give an indication of the contactor status. They can be used for remote visual signaling, alarming, electrical locking, relay activation, and others.

Each contactor is equipped with 1 NO (normally open) and 1 NC (normally closed) auxiliary contact block as standard.

#### Mechanically linked mirror contacts

The NC (normally closed) contact of the auxiliary contact block is a mirror contact in conformity to IEC 60947–5–1. It is mechanically linked to reliably represent the state of the main power contacts and wherever auxiliary contact state reliability is essential.

The NC contact of the auxiliary contact cannot be closed at the same time as a normally open power contact.

#### Contact module compatibility

TeSys™ Giga auxiliary contact module is compatible with a range of TeSys Giga contactors. Each TeSys Giga contactor can be equipped with up to four auxiliary contact modules.

**Table 18.61: Electrical Characteristics**

Characteristics	
Rated thermal current (A)	10
Minimum load	1 mA at 17 V DC
Contact reliability	Failure rate <10

#### Type of connections:

- Push-In

**Table 18.62: Auxiliary Contact Modules**

Description	Terminal type	Types of contacts	Sold in lots of	Reference
Auxiliary contact module	Push-In	1 NO + 1 NC	1	<a href="#">LAG8N113P[29]</a>
		2 NO	1	<a href="#">LAG8N203P</a>

### Connection Kits and Mechanical Interlock

**Table 18.63: Star-Delta (Wye Delta) Connection Kits**



Description	Suitable for:	For Line/Delta contactor	+ Star contactor	Reference
Connection kit: bars for Line/Delta Star contactor assembly	3-pole	LC1G115/LC1G225	LC1G115/LC1G225	<a href="#">LA9GQQ330</a>
		LC1G265/LC1G500	LC1G115/LC1G225	<a href="#">LA9GSQ330</a>
		LC1G265/LC1G500	LC1G265/LC1G500	<a href="#">LA9GSS330</a>
	3-pole (with cable memory kit)	LC1G630/LC1G800	LC1G265/LC1G500	<a href="#">LA9GTS330</a>
		LC1G630/LC1G800	LC1G630/LC1G800	<a href="#">LA9GTT330</a>
		LC1G265/LC1G500	LC1G115/LC1G225	<a href="#">LA9GSQ331</a>
		LC1G630/LC1G800	LC1G265/LC1G500	<a href="#">LA9GTS331</a>

**NOTE:** RE17RMMWS timer to be used for Star-Delta starter application.

**Table 18.64: Reverser Connection Kits**

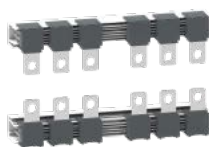

Description	Suitable for:	Compatible with contactors	Reference
Connection kit: bars for reverser contactor assembly	3-pole	LC1G115/LC1G225	<a href="#">LA9G3760</a>
		LC1G265/LC1G500	<a href="#">LA9G3761</a>
		LC1G630/LC1G800	<a href="#">LA9G3762</a>

**Table 18.65: Changeover Connection Kits**



Description	Suitable for:	Compatible with contactors	Reference
Connection kit: bars for changeover contactor assembly	3-pole	LC1G115/LC1G225	<a href="#">LA9G3750</a>
		LC1G265/LC1G500	<a href="#">LA9G3751</a>
		LC1G630/LC1G800	<a href="#">LA9G3752</a>
	4-pole	LC1G115/LC1G225	<a href="#">LA9G4750</a>
		LC1G265/LC1G500	<a href="#">LA9G4751</a>
		LC1G630/LC1G800	<a href="#">LA9G4752</a>

[29] Always supplied with TeSys™ Giga LC1G contactors (fitted to the right side lateral face).



Table 18.66: Mechanical Interlock<sup>[30]</sup>

Description	Reference	
Mechanical interlock between contactors <sup>[31]</sup>	Identical contactor frames	<a href="#">LA9G970</a>
	LC1G265 to 500 and LC1G182 to 225	<a href="#">LA9G971</a>
	LC1G630 to 800 and LC1G265 to 500	<a href="#">LA9G972</a>

### Retrofit Bases

- Suitable for 3-pole contactors
- Retrofit bases to replace similar ratings of TeSys™ F contactors with TeSys™ Giga contactors
- Enables quick and simple replacement in the existing installation
- Two references to cover ranges from LC1F115 to F500

TeSys™ Giga retrofit bases are designed for integrating new TeSys™ Giga contactors into installations using TeSys F™ contactors. The retrofit bases help reduce replacement and reinstallation time when you upgrade your system with the new range of contactors. The retrofit bases come in two frame sizes.



LA9GRFB1



LA9GRFB2

Table 18.67: Retrofit Bases

Description	Reference	
Accessory used to replace TeSys™	LC1F115–225 replaced by LC1G115–225	<a href="#">LA9GRFB1</a>
	LC1F265–500 replaced by LC1G265–500	<a href="#">LA9GRFB2</a>
	LC1F630–800 replaced by LC1G630–800	<a href="#">LA9GRFB3<sup>[32]</sup></a>

### Remote Wear Diagnostic (RWD) Module

Table 18.68: Remote Wear Diagnostic (RWD) Module

Description	Reference
Remote wear diagnostic module for TeSys™ Giga contactor - 1 NO	<a href="#">LA9GRD10<sup>[33]</sup></a>
Remote wear diagnostic module for TeSys™ Giga contactor - 1 NC	<a href="#">LA9GRD01</a>



LA9DRD10

<sup>[30]</sup> UL pending.

<sup>[31]</sup> Always supplied with TeSys™ Giga LCIG contactor, fitted to the right side lateral face.

<sup>[32]</sup> Available 2Q 2022.

<sup>[33]</sup> Remote wear diagnostic (RWD) module can be installed and used only in the Advanced contactor version.

**TeSys™ F Contactors**

**Table 18.69: Lugs for TeSys F Contactors**

Contactor Type LC1	Cable Size AWG Range	Lug Kit <sup>[34]</sup> (Quantity of 6)	Individual Lug (Quantity of 1)
F780	4 x 1/0 to 750 MCM	DZ2FX6	—

TeSys F overload relay accessories: [page](#)

TeSys F replacement coils and parts: [page 18-44](#), [page](#) , and [page](#)

TeSys F dimensions: [page 18-49](#), [page 18-61](#)

[34] For additional options and accessories, see [MKTED210011EN](#).

TeSys Deca Overload Relay Accessories

Table 18.70: Mounting Kits and Plates<sup>[1]</sup>

Description	For use with overload relays:	Cat. No.
Separate mounting kits for mounting to 35 mm DIN rail or for panel mounting with screws	LRD01–35 and LR3D01–35	LAD7B10
	LRD01–35 and LRD01–35 for ring tongue terminals	LAD7B106
	LRD04L–32L, LR3D04L–32L, and LR9D01–32	LAD7B205
	LRD3•••, LR3D3•••, LR2D35••	LAD96560



LA7D901



LA7D03

Table 18.71: Accessories

Description	For use with	Standard Package	Catalog Number
Prewiring kit allows direct connection of the N.C. contact of relay LRD01–D32 or LR3D01–D32 to the contactor	LC1D09 to D18	10	LAD7C1
	LC1D25 to D38	10	LAD7C2
Remote stop/tripping or electrical reset <sup>[2]</sup>	All relays except LRD01–D32	1	LAD703 <sup>[3]</sup>
Reset by flexible cable 500 mm (19.6 in.)	LRD01–D32, LRD3, LR3D3	1	LAD7305

Table 18.72: Control Circuit Voltages for LA7D03 and LAD703

Volts	24	110
AC 50/60 Hz	B	F
DC	B	F

[1] When using mounting plates, separate mounting kits are also required.

[2] The time that the LA7D03 can remain energized depends on its rest time; 1s pulse duration with 29s rest time; 3s pulse duration with 90s rest time; maximum pulse duration of 5s with rest time of 300s.

[3] Part number to be completed by adding coil voltage code, (for example, LAD703F).

**TeSys™ Giga Overload Relay Accessories**

**Table 18.73: Remote Reset Control Device**

Description	Sold in lots of:	Reference
Remote Reset control function by flexible cable (length = 0.5m)	1	<a href="#">LAD7305</a>



LAD7305



TeSys™ Ultra Motor Starter

The TeSys Ultra motor starter is integrated, making it simple to choose and install. It consists of a control unit snapped in a power base. TeSys Ultra can be configured to fit specific applications as well. Optional accessories include a reverser, a current limiter, predictive maintenance options, and communication options. For detailed information about TeSys Ultra, visit our website.

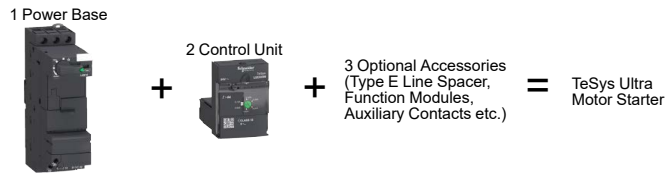

Selecting TeSys™ Ultra Motor Starters in Three Steps

Table 18.74: Step 1. Select Power Base (Only two different bases up to 32 A)



Control Connection	Max. Current (A)	Maximum Horsepower Ratings						Self-Protected Starter Base Catalog Number
		Three-Phase				Single-Phase		
		200 V	230 V	460 V	575 V	115 V	230 V	
With non-removable screw terminations	12	3	3	7.5	10	0.5	2	LUB12
	32	10	10	20	25	2	5	LUB32
Without screw terminations	12	3	3	7.5	10	0.5	2	LUB120 [1]
	32	10	10	20	25	2	5	LUB320 [1]

Table 18.75: Step 2. Select Control Unit [2]

Setting Range (A)	Standard 3-phase Class 10 trip [3]	Advanced 3-phase Class 10 trip [3]	Advanced single-phase Class 10 trip [3]	Advanced 3-phase Class 20 trip [3]
0.15–0.6	LUCAX6●●	LUCBX6●●	LUCCX6●●	LUCDX6●●
0.3–1.4	LUCA1X●●	LUCB1X●●	LUCC1X●●	LUCD1X●●
1.25–5.0	LUCA05●●	LUCB05●●	LUCC05●●	LUCD05●●
3–12	LUCA12●●	LUCB12●●	LUCC12●●	LUCD12●●
4.5–18	LUCA18●●	LUCB18●●	LUCC18●●	LUCD18●●
8–32	LUCA32●●	LUCB32●●	LUCC32●●	LUCD32●●

Table 18.76: Voltage Codes

Volts	24	110–240
DC	BL [4]	—
AC	B	—
DC or AC	—	FU

Table 18.77: Step 3. Select Auxiliary Contacts (optional)

Terminals	Contact Indicates	Contact Normal Status	Contact State for Each Mode [5]							Catalog Number
			Off	Ready	Run	Short Circuit Trip	Overload Trip (Manual Reset)	Overload Trip (Remote/Auto Reset) [6]		
<b>Auxiliary Contact Blocks</b>										
Screw	Ready condition	N.O.	O	I	I	O	O	I	I	LUA1C11
	Fault condition	N.C.	I	I	I	O	O	I	I	LUA1C20
Screw	Ready condition	N.O.	O	I	I	O	O	I	I	LUA1C20
	Fault condition	N.O.	O	O	O	I	I	O	O	LUA1C20
<b>Auxiliary Contact Function Modules</b>										
Screw	Pole state	2 N.O.	O	O	I	O	O			LUFN20
Screw	Pole state	1 N.O. and 1 N.C.	O   I	O   I	I   O	O   I	O   I			LUFN11
Screw	Pole state	2 N.C.	1	I	O	I	I			LUFN02

Table 18.78: Accessories

Accessory	Quick Description	For details & selection, see:
Current limiter	Increases the breaking capacity to 130 kA @ 460 V and to 65 kA @ 575 V	page 18-32
Reverser	Stacked or side mounted (LU6MB0●●● only)	page 18-32
Line phase barrier	Required for use as a self-protected combination starter (UL 508 Type E)	page 18-32
Multifunction control unit	Has functions for monitoring and predictive maintenance	page 18-32
Function modules	Fault differentiation, thermal overload, motor load indication	page 18-32
Communication modules	Integrates into existing networks, major protocols are available	page 18-33
Soft starter + TeSys Ultra	Use Altistart U01soft starter with TeSys Ultra	page 18-42
Powerbus	Use TeSys Ultra with a prewired system	page 18-33
Configuration and connection accessories	SoMove software, bus bar, external handle	page 18-33



E164862  
CCN NLDX



LR43364  
Class 3211 04



Accessories: Power Base and Plug-in Accessories, page 18-31 to page 18-33  
Dimensions: TeSys™ Ultra Starter Dimensions, page 18-64  
Overload Relays: page 18-9  
Accessories: page 18-18  
Dimensions: page 18-63

[1] For use with reversing modules or communication modules with prewired connector.

[2] The control unit contains solid-state overload relay and control power source for TeSys Ultra. For more details on the different control units, their functions, and placement on the power base, see Power Base and Plug-in Accessories, page 18-31.

[3] Complete the catalog number by adding appropriate code from Table 18.76 (for example, LUCAX6FU).

[4] DC voltage with range of 0.90 to 1.10 of nominal.

[5] I indicates closed contact; O indicates open contact.

[6] Requires multifunction or advanced control unit plus fault differentiation module LUFDA10.

**Control Units and Functions**

**Table 18.79: Control Units and Functions**

				
Reference	<b>LUCA</b>	<b>LUCB</b>	<b>LUCD</b>	<b>LUCM</b>
<b>Protection type</b>				
Class 10				
Class 20				
Class 5-30				
Single Phase: LUCC Class 10 only				
<b>Protection functions</b>				
Short circuit				
Over current				
Thermal overload				
Phase loss				
Phase imbalance				
Ground fault				
Underload, long start, jam				
<b>Control functions</b>				
Manual reset				
Automatic or local/remote reset				
Fault differentiation				
Thermal alarm				
Motor load display				
Fault history				
Alarm threshold adjustment				
Tripping test				
<div style="display: flex; justify-content: space-between; align-items: flex-start;"> <div style="width: 60%;"></div> <div style="width: 35%; font-size: small;"> <p style="margin: 0;">= built-in the control unit</p> <p style="margin: 0;">= works with the related function modules (see <a href="#">page 18-32</a>)</p> </div> </div>				

**Power Base and Plug-in Accessories**

See below where to install accessories on the power base. Only one accessory can be installed in each location.

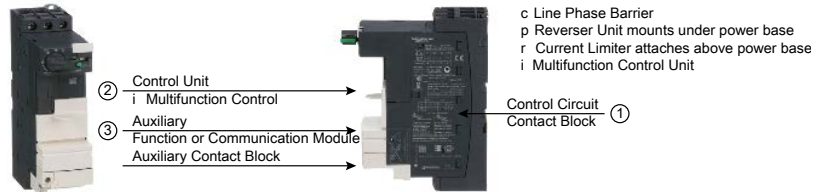

TeSys™ Reversing Starters

Table 18.80: Power Base with Reversing Unit assembled under the base



Line Phase Barrier



Reverser Unit Assembled under the Power Base

Control Connection	Max. Current (A)	Maximum Horsepower Ratings						Self-Protected Starter Base Catalog Number
		Three-Phase				Single-Phase		
		200 V	230 V	460 V	575 V	115 V	230 V	
With screw terminations	12	3	3	7.5	10	1.5	2	LU2B12 <sup>[7]</sup>
	32	10	10	20	25	2	5	LU2B32 <sup>[7]</sup>

Table 18.81: Select Control Unit Options<sup>[8][9]</sup>

Setting Range (A)	Standard Three-Phase Class 10 trip <sup>[10]</sup>	Advanced Three-Phase Class 10 trip <sup>[10]</sup>	Advanced Single-Phase Class 10 trip <sup>[10]</sup>	Advanced Three-Phase Class 20 trip <sup>[10]</sup>
0.15–0.6	LUCAX6●●	LUCBX6●●	LUCCX6●●	LUCDX6●●
0.3–1.4	LUCA1X●●	LUCB1X●●	LUCC1X●●	LUCD1X●●
1.25–5.0	LUCA05●●	LUCB05●●	LUCC05●●	LUCD05●●
3–12	LUCA12●●	LUCB12●●	LUCC12●●	LUCD12●●
4.5–18	LUCA18●●	LUCB18●●	LUCC18●●	LUCD18●●
8–32	LUCA32●●	LUCB32●●	LUCC32●●	LUCD32●●

Table 18.82: Voltage Codes

Volts	24	110–240
DC	BL <sup>[11][12]</sup>	—
AC	B	—
DC or AC	—	FU

Table 18.83: Reversing Modules for Field Addition

Mounting	Catalog No.	Wiring Adapter	
Beneath	LU2MB0	LU9MR1C	Note: For LU2MB0 and LU6MB0, voltage code required; must match control unit.
Beside	LU6MB0	LU9MR1	

TeSys™ Ultra Accessories

Table 18.84: Current Limiter<sup>[13][14]</sup>

Accessory	Application	Technical Data	Mounting	Cat. No.
Current limiter/isolator	Additional current limiting aspects for the starter	130 kA at 460 V 65 kA at 575 V	Direct mounting to LUB● and LU2B●	LUALB1
Limiter cartridge	Replacement cartridge for LUALB1	130 kA at 460 V 65 kA at 575 V	—	LUALF1

Table 18.85: Function Modules<sup>[13][15]</sup>

Module	Description	For use with:	Operation Requirements	Catalog Number
<b>Fault differentiation:</b> with manual reset (thermal overload) with auto reset	Provides indication between an overload trip and a short circuit trip.	Advanced control units only	24–250 Vac/Vdc (power from control unit)	LUFDA10
Thermal overload pre-alarm	Signals when the motor current reaches 1.05 of the full load setting on the control unit.	Advanced control units only	24–250 Vac/Vdc (power from control unit)	LUFW10
Motor load indication	Provides a signal proportional to the average currents in the three phases divided by the full load current setting of the control unit. The output corresponds to a load status of 0–2 times the full load setting of the control unit.	Advanced or multi-function control units	4–20 mA (requires separate 24 Vdc power supply)	LUFV2
Parallel wiring	Provides a convenient way to reduce control wiring and allow for connecting starters to a communications network by providing 24 Vdc for the starters.	Advanced or multi-function control units (24 Vdc only) and LU9BN11C or LU9MRC prewired connector	LU9G02 splitter box and PLC network	LUF00



Alarm Differentiation



Parallel Wiring



Motor Load Indicator

[7] Voltage code required.

[8] The control unit contains solid-state overload relay and control power source for TeSys Ultra. For more details on the different control units, their functions, and placement on the power base see *Control Units and Functions*, page 18-31.

[9] Control units for 4.5–18 and 8–32 can be used **only** with 32 A rated power bases (LUB32, LUB320, and LU2B32).

[10] Complete the catalog number by adding the appropriate code from (for example LUCAX6FU).

[11] DC voltage with range of 0.90 to 1.10 of nominal.

[12] Voltage code to use for a power base with a communication module.

[13] See page 18-31 for placement on the power base.

[14] Increases the breaking capacity of the motor starter.

[15] Offers customization for specific application requirements.

**Accessories**

**Table 18.86: Communication Modules [16][17]**

Communication modules allow the TeSys Ultra starter to be connected directly to the network. They are for use with advanced or multi-function control units (24 Vdc only) and require a separate 24 Vdc power supply.

Module	Prewired Connector	Catalog Number
Modbus™ Communication	LU9BN11C or LU9MRC	LULC033
CANopen Communication	LU9BN11L or LU9MRL	LULC08
Profibus Communication	LU9BN11L or LU9MRL	LULC07
DeviceNet™ Communication	LU9BN11L or LU9MRL	LULC09



**Table 18.87: TeSys™ Ultra Cabling Accessories—Power Bus Bars**

Description	Application	Pitch	Standard Pack	Catalog Number
3-Pole, 63 A Bus Bar	For feeding 2 TeSys Ultra controllers	45	1	GV2G245
		54	1	GV2G254
		72	1	GV2G272
	For feeding 3 TeSys Ultra controllers	45	1	GV2G345
		54	1	GV2G354
		72	1	GV2G372
	For feeding 4 TeSys Ultra controllers	45	1	GV2G445
		54	1	GV2G454
72		1	GV2G472	
For feeding 5 TeSys Ultra controllers	54	1	GV2G554	
Terminal blocks	Top feed for use with bus bars	—	1	GV1G09

**Table 18.88: Control Circuit Accessories [18] for placement on power base.**

Accessory	Application	Technical Data	Mounting	Catalog Number
Control circuit contact block	Switches control circuit power via LUB● handle (NEC430-74 compliance)	5 A at 600 Vac 5 A at 250 Vdc	Side mounting to LUB● and LU2B● only	LUA8E20
Through-the-door operating mechanism (without trip indication)	Use to enclose TeSys LUB● only.	NEMA 1, 12, 3R, 4, 4X Red/Yellow	Kit	LU9APN44
Control circuit filters	Use with electronic or triac output controllers	Up to 150 Vac max.	Directly to coil terminals	Non-reversing LUA4F11 Reversing LUA4F12
Pre-wired connector	Central control when using communication modules	See Table 18.86 for usage.	Lower power terminals to communication module.	Non-reversing LU9BN11C LU9BN11L Reversing LU9MRL

[16] See page 18-31 for placement on the power base.  
 [17] Communication capabilities can be integrated into existing automation architecture via a variety of protocols.  
 [18] See Power Base and Plug-in Accessories, page 18-31

TeSys™ Power Motor Circuit Breakers

The TeSys™ Power Motor Circuit Breakers family of products provide efficient motor control and protection solutions up to 520 amps. There are a variety of UL approved applications that enable specified configurations for use as a manual starter, motor disconnect, independent branch short-circuit protection, motor overload protection, or for use with a motor controller such as a contactor to build a complete motor control circuit. Certain configurations are approved for group motor applications as well. Refer to the following selection tables for application information, as well as the Motor Control Solutions for the North American Market data bulletin (8536DB0901) for additional information.

The GV2P (up to 32 amps) and GV3P (up to 65 amps) is rated to UL 60947-4-1 as a motor starter, and also possess Type E ratings for manual switching applications. These devices can be combined with a specified TeSys Deca contactor as a Type F combination motor controller (with specified line side spacer/accessories), with SCCR up to 100kA.

The GV2ME (up to 32 amps) combined with a specified TeSys Deca contactor is ideal for group motor applications.

The TeSys island load management starters are approved for use with TeSys GV2P and GV3P devices as a group motor arrangement. See selection table for application specifics.

The GV4PB, GV5PB, and GV6PB are motor protective circuit breakers rated to UL 489, are approved as branch circuit protection (no line side spacer required) and include motor overload protection. A full motor branch circuit is completed with the addition of a contactor, providing a compact two-component solution up to 520 motor full load amps. Pre-trip alarm accessories can be applied to these units to help anticipate and resolve issues, minimizing operator or maintenance interaction.



GV2P



GV4PB

Table 18.89: GV2, GV3 Manual Motor Protectors (UL 60947-4-1)

	Thermal Setting (A)	Maximum Horsepower Ratings								GV2ME push button <sup>[19]</sup> Catalog Number	GV2/3P rotary handle Catalog Number
		Single-Phase			Three-Phase						
		115 V	200 V	230 V	115 V	200 V	230 V	460 V	575 V		
 GV2P	0.10–0.16	—	—	—	—	—	—	—	—	GV2ME01	GV2P01
	0.16–0.25	—	—	—	—	—	—	—	—	GV2ME02	GV2P02
	0.25–0.40	—	—	—	—	—	—	—	—	GV2ME03	GV2P03
	0.40–0.63	—	—	—	—	—	—	—	—	GV2ME04	GV2P04
	0.63–1	—	—	—	—	—	—	—	1/2	GV2ME05	GV2P05
	1–1.6	—	—	1/10	—	—	—	3/4	3/4	GV2ME06	GV2P06
	1.6–2.5	—	1/6	1/6	—	1/2	1/2	1	1.5	GV2ME07	GV2P07
	2.5–4	1/8	1/4	1/3	—	3/4	3/4	2	3	GV2ME08	GV2P08
	4–6.3	1/4	1/2	1/2	3/4	1	1.5	3	5	GV2ME10	GV2P10
	6–10	1/2	1	1.5	1	2	3	5	7.5	GV2ME14	GV2P14
	9–14	3/4	2	2	2	3	3	10	10	GV2ME16	GV2P16
	13–18	1	2	3	2	5	5	10	15	GV2ME20	GV2P20
	17–23	1.5	3	3	3	5	7.5	15	20	GV2ME21	GV2P21
	20–25	2	—	—	—	7.5	7.5	15	20	GV2ME22	GV2P22
	24–32	2	5	5	5	7.5	10	20	25	GV2ME32	GV2P32
	 GV2ME	9–13	1/2	—	1.5	—	3	3	7.5	10	—
12–18		3/4	—	2	—	3	5	7.5	10	—	GV3P18
17–25		1.5	—	3	—	5	7.5	15	20	—	GV3P25
23–32		2	—	3	—	7.5	7.5	20	25	—	GV3P32
30–40		3	—	5	—	10	10	25	30	—	GV3P40
37–50		3	—	7.5	—	10	10	30	40	—	GV3P50
48–65		3	—	10	—	15	15	40	50	—	GV3P65

[19] For spring terminals add 3 to the catalog number (for example, GV2ME013). GV2ME013 is not available with spring terminals. For ring terminals, add 6.



GV4PB



GV5PB



GV2P10 with LC1D09

**Table 18.90: GV4, GV5, GV6 UL 489 Motor Protective Circuit Breakers**

Motor FLA Dial Range	Interrupting Rating: 240 V ... 35 kA 480Y/277 V ... 18 kA 600Y/347 V ... 14 kA	Interrupting Rating: 240 V ... 65 kA 480Y/277 V ... 35 kA 600Y/347 V ... 18 kA	Interrupting Rating: 240 V ... 100 kA 480Y/277 V ... 65 kA 600Y/347 V ... 25 kA
0.8 ... 2	—	GV4PB02N	GV4PB02S
1.4 ... 3.5	—	GV4PB03N	GV4PB03S
2.9 ... 7	—	GV4PB07N	GV4PB07S
5 ... 12.5	—	GV4PB12N	GV4PB12S
10 ... 25	GV4PB25B	GV4PB25N	GV4PB25S
20 ... 50	GV4PB50B	GV4PB50N	GV4PB50S
40 ... 80	GV4PB80B	GV4PB80N	GV4PB80S
65 ... 115	GV4PB115B	GV4PB115N	GV4PB115S
58 ... 130	—	GV5PB150N	GV5PB150S
114 ... 217	—	GV5PB250N	GV5PB250S
190 ... 348	—	GV6PB400N	GV6PB400S
312 ... 520	—	GV6PB600N	GV6PB600S

**GV2P + LC1D Pre-Assembled Kits**

Simplify your life! These new **pre-assembled kits** come with a GV2P manual motor protector already connected to an LC1D contactor. Panel builders and end users can now save wiring time by purchasing the pre-assembled kits.

**Table 18.91: Pre-Assembled Kits** <sup>New!</sup>

Components (includes GV2AF3)	UL File E134347 SCCR Type F 480Y/277V		Group Motor Rating UL File E89451 SCCR 480 V	Kit Part No. [20]
	With GV2GH7 or GV1G09 Line Side Adapter	With GV1G09 Line Side Adapter and GV2G Busbar		
GV2P02 + LC1D09G7	100 kA	100 kA	22 kA	GV2P02KD09
GV2P03 + LC1D09G7	100 kA	100 kA	22 kA	GV2P03KD09
GV2P04 + LC1D09G7	100 kA	100 kA	22 kA	GV2P04KD09
GV2P05 + LC1D09G7	100 kA	100 kA	22 kA	GV2P05KD09
GV2P06 + LC1D09G7	100 kA	100 kA	22 kA	GV2P06KD09
GV2P07 + LC1D09G7	100 kA	100 kA	22 kA	GV2P07KD09
GV2P08 + LC1D09G7	100 kA	100 kA	22 kA	GV2P08KD09
GV2P10 + LC1D09G7	100 kA	100 kA	22 kA	GV2P10KD09
GV2P14 + LC1D09G7	100 kA	100 kA	22 kA	GV2P14KD09
GV2P16 + LC1D25G7	50 kA	42 kA	22 kA	GV2P16KD25
GV2P20 + LC1D25G7	50 kA	42 kA	22 kA	GV2P20KD25
GV2P21 + LC1D25G7	50 kA	42 kA	22 kA	GV2P21KD25
GV2P22 + LC1D25G7	50 kA	42 kA	22 kA	GV2P22KD25

Coil Voltage Suffix	
120 Vac	G7
24 Vac	B7
24 Vdc Low Consumption	BL

[20] Complete the catalog number with the coil voltage suffix (for example **GV2P16KD25G7**).

Refer to Catalog MKTED210011EN and 8536CT1901

TeSys™ BV4 Motor Circuit Protection Selection

Providing UL508 type D combination ratings in accordance to current NEC installation requirements, the TeSys BV4 motor circuit protector allows for compact motor protection in conjunction with both the TeSys and Square D™ NEMA product families for motor control. The BV4 is a magnetic only, UL489 Listed circuit protector rated up to 100kA short-circuit protect with adjustable instantaneous trip points and can be installed directly to a panel or standard DIN rail.

Motor Circuit Protectors must be applied per a listed combination motor controller rating as required by NEC and UL 508A. See [UL.com/SCCR](http://UL.com/SCCR) for combination ratings or contact local support for a tested combination appendix.



Table 18.92: TeSys™ BV4 Motor Circuit Breaker Selection

Frame	MCP Ampacity (In)	Adjustable Instantaneous Trip (Ii)	Protection Level	
			Standard Fault Cat. No.	High Fault Cat. No.
BV4	2	12-28	BV4T002D	BV4T002J
	3.5	21-49	BV4T003D	BV4T003J
	7	42-98	BV4T007D	BV4T007J
	13	53-195	BV4T013D	BV4T013J
	25	110-360	BV4T025D	BV4T025J
	50	176-650	BV4T050D	BV4T050J
	80	320-1150	BV4T080D	BV4T080J
	115	600-1150	BV4T115D	BV4T115J

TeSys™ Deca GV2 Accessories and Enclosures

Table 18.93: Mounting Accessories for GV2 + LC1 D09 to D38<sup>[21]</sup>

	Mount GV Directly on Single DIN Rail	Mount on Single DIN Rail (Using Mounting Hardware)	Mount GV and LC1D Contactor on Independent DIN Rails	Mount on 2 DIN Rails (Using Mounting Hardware)
Electrical Interconnect	GV2AF3	GK2AF01	GV1G02	GV2AF4
Mounting Hardware	—	—	—	LAD311

Table 18.94: Mounting Accessories for GV2<sup>[21]</sup>

Description	Application	Standard Pack <sup>[22]</sup>	Catalog Number
Adapter plate	For screw mounting of GV2M	10	GV2AF02
7.5 mm compensation plate	To allow mounting of GV2M and GV2P on a common bus bar	10	GV1F03

Table 18.95: Bus Bar Accessories for GV2

Description	Application	Pitch	Catalog Number
Incoming Terminal	Type E line spacer, for use with or without GV2G busbars	—	GV1G09
	Type E line spacer, not for use with or with GV2G busbars	—	GV2GH7
	Bottom Feed, for use with GV1L3 current limiter	—	GV2G05
3-Pole, 63 A Bus Bar	For feeding 2 GV2 starters	45	GV2G245
		54	GV2G254
		72	GV2G272
	For feeding 3 GV2 starters	45	GV2G345
		54	GV2G354
	For feeding 4 GV2 starters	45	GV2G445
54		GV2G454	
For feeding 5 GV2 starters	72	GV2G472	
	54	GV2G554	
Protective Cover	To cover unused bus bar outlets	—	GV1G10 <sup>[23]</sup>

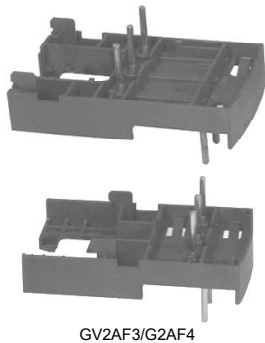

GV2AF3/G2AF4

[21] Must order in multiples of 10.  
[22] Orders must specify multiples of quantities listed.  
[23] Must order in multiples of 5.



**Table 18.96: GV2 Other Accessories**

Description	Application	Standard Pack [24]	Catalog Number
Current limiter—GV2	Increases interrupt capacity when attached to GV2ME or GV2P	1	GV1L3
Through-the-door operating mechanism kits	NEMA 1, 12, Black with trip indication, for use with GV2P	1	GV2APN01
	NEMA 1, 12, Red/Yellow with trip indication, for use with GV2P	1	GV2APN02
	NEMA 3R, 4, 4X, Red/Yellow without trip indication, for use with GV2P	1	GV2APN04
Angle bracket	Operating mechanism support shaft for deep enclosures (≥ 250 mm), for use with GV2P	1	GVAPK11
Operating mechanism short shaft	One-piece short shaft for installing operating mechanisms in shallow enclosures, for use with GV2P, GV3P and TeSys Ultra	1	GVAPA2
Laser tool	Laser tool for installing through-the-door kits	1	GVAPL01

**Table 18.97: GV2 Enclosures**

Description	Listing	Mounting	Enclosure Rating	Max. Side Mounting Aux. Contacts		Catalog Number
				Left Side	Right Side	
Enclosures for GV2ME with or without accessories	CSA Listed. Not UL Listed.	Surface mounting	NEMA 1, IP41	1	1	GV2MC01
			NEMA 12/4, IP55	1	1	GV2MC02
		Flush mounting	NEMA 1, IP41	1	1	GV2MP01
			NEMA 12/4, IP55	1	1	GV2MP02
		Flush mounting, front face reduced	NEMA 1, IP41	0	1	GV2MP03
			NEMA 12/4, IP55	0	1	GV2MP04

**Table 18.98: GV2 Enclosures Accessories**

Description	Type	Standard Pack [25]	Catalog Number	
Padlocking device for GV2M (when padlocked, starter is automatically in Off position)	—	1	GV2V01	
Mushroom head stop push button (40 mm, red) [26]	Spring return	1	GV2K011	
	Latching	Turn to Release	1	GV2K031
	Latching / Padlockable Turn to Release		1	GV2K04
Sealing kit	For enclosures GV2MC01 and GV2MP01	10	GV2E01	

**Voltage Trips**

**Table 18.99: Voltage Trips**

Only one trip or fault signaling contact can be installed per GV2/GV3 device.				
Description	Characteristics	Voltage	Frequency	Cat. No. [27]
Voltage trips GV2 or GV3P	Undervoltage or Shunt trip (external mounting, 1 block right side only)	110–115 V	60 Hz	GVA•116
		220–240 V	60 Hz	GVA•226



GVAU116

**Table 18.100: Voltage Trips—Technical Data (GV2AU, GV2AS)**

Rated Voltage—660 Vac					
Model	Inrush	Sealed	Pick-Up Voltage	Drop-Out Voltage	Operating Time [28]
GVAU	12 VA / 8 W	3.5 VA / 1.1 W	0.8–1.1	0.35–0.7	10–15 ms
GVAS	14 VA / 10.5 W	5 VA / 1.6 W	0.7–1.1	0.2–0.75	10–15 ms

[24] Orders must specify multiples of quantities listed.

[25] Supplied with IP55 sealing kit.

[26] Supplied with IP55 sealing kit.

[27] To order an undervoltage trip: replace the bullet (•) with a U (for example, GVAU025).

To order a shunt trip: replace the bullet (•) with an S (for example, GVAS025).

[28] From the loss of voltage at the trip terminals to the opening of the starter contacts.



GVAE11



GV3G66

Table 18.101: Auxiliary Contact Blocks [29]

Description	Mounting Location	Max. No. of Blocks	Contact Type	Sold in lots of	Cat. No.
Instantaneous auxiliary contacts GV2 or GV3P	Front [30][31]	1	N.O. or N.C. [32]	1	GVAE1
			N.O. + N.C.	10	GVAE11
	Left Hand Side	2	N.O. + N.O.	1	GVAE20
			N.O. + N.C.	1	GVAN11
Fault signaling contact + instantaneous auxiliary contact GV2 or GV3P	Left Hand Side [33]	1	N.O. (fault) + N.O.	1	GVAD1010
			N.O. (fault) + N.C.	1	GVAD1001
			N.C. (fault) + N.O.	1	GVAD0110
			N.C. (fault) + N.C.	1	GVAD0101
Short circuit signaling contact GV2 or GV3P	Left Hand Side	1	SPDT	1	GVAM11

Table 18.102: GV3P Accessories

Accessory	Application / Use With	Standard Pack	Cat. No.
Through-the-door operating mechanism kits	NEMA 1, 12, Black with trip indication, for use with GV3P	1	GV3APN01
	NEMA 1, 12, Red/Yellow, with trip indication, for use with GV3P	1	GV3APN02
	NEMA 3R, 4, 4X Red/Yellow without trip indication, for use with GV3P	1	GV3APN04
Angle bracket	Operating mechanism support shaft for deep enclosures (≥ 300 mm), for use with GV3P	1	GVAPK12
3-pole, 115 A busbar	For feeding 2 GV3P starters, 64 mm pitch	1	GV3G264
	For feeding 3 GV3P starters, 64 mm pitch	1	GV3G364
Incoming line spacer	Line spacer for GV3P when used in UL 508 Type E applications. One spacer required on line side.	1	GV3G66
IP20 cover	IP20 protective cover for ring tongue versions of GV3P and 3-pole TeSys™ Deca Everlink contactors. Two covers required for line and load side.	1	LAD96570
Padlocking device	For use with up to 4 padlocks (not supplied). Ø 6 mm shank maximum	1	GV2V03
Operating mechanism short shaft	One-piece short shaft for installing operating mechanisms in shallow enclosures, for use with GV2P, GV3P and TeSys Ultra	1	GVAPA2
Laser tool	Laser tool for installing through-the-door kits	1	GVAPL01
S-shaped busbar	For connecting GV3P starters and LC1D40A-65A contactors side by side without intrawiring	1	GV3S

Common Accessories for BV4, GV4, GV5 and GV6

Common Accessories	BV4 Reference	GV4 Reference	GV5 Reference	GV6 Reference	
<b>Auxiliary contacts OF or SD</b>					
Open/Closed Status	GV4AE11	GV4AE11	GV7AE11	GV7AE11	
Trip Alarm	—	—	—	—	
Open/Closed Status — Low Level	—	—	GV7AB11	GV7AB11	
<b>Fault signalization modules</b>					
For <b>GV4PB</b> , SDx module mounts externally on the right side, and provides pre-trip alarm and fault signalization					
<ul style="list-style-type: none"> <li>SDT95% overload alarm: thermal image of the motor is greater than 95 % of the permissible temperature rise.</li> <li>SDTxxs overload alarm: circuit breaker will trip in xx seconds with the same load. xx is adjustable between 10 to 40 seconds (default 20 seconds) on the circuit breaker itself through NFC or a computer with EcoStruxure Power Commission software and an interface module (TRV00911).</li> <li>SDTAM overload alarm just before tripping: in the event of a phase unbalance, overload, or on a jam fault, this output is activated to open the contactor and avoid circuit breaker tripping. In that case, contact can be manually or automatically reseted after an adjustable cooling time from 1 to 15 minutes. If after a 400 ms delay the motor is not stopped, the circuit breaker will trip.</li> <li>SDT overload trip indication: circuit breaker has tripped due to an overload fault.</li> <li>SDJAM jam trip indication: circuit breaker has tripped due to a jam fault.</li> <li>SDUNB phase unbalance trip indication: circuit breaker has tripped due to an unbalance fault.</li> <li>SDLS long start trip indication: circuit breaker has tripped due to a long start fault.</li> <li>SDGF ground-fault trip indication: circuit breaker has tripped due to a ground-fault.</li> </ul>					
For <b>GV5PB</b> & <b>GV6PB</b> , SDx module mounts internally, and includes a pre-trip contact (400 ms prior to trip) that can be used to open the contactor, as well as a contact that indicates overload trip of the circuit-breaker.					
<b>Instantaneous voltage release</b>					
Undervoltage Release (Mn)	24 V 50/60 Hz	GV4AU027	GV4AU027	P29404	P29404
	24 Vdc	—	—	—	—
	48 V 50/60 Hz—48 Vdc	GV4AU057	GV4AU057	GV7AU055	GV7AU055
	110–130 V 50/60 Hz—125 Vdc	GV4AU137	GV4AU137	GV7AU107	GV7AU107
	208–240 V 50/60 Hz	GV4AU247	GV4AU247	GV7AU207	GV7AU207
	277 V 60 Hz	GV4AU286	GV4AU286	—	—
	380–415 V 50 Hz	GV4AU415	GV4AU415	GV7AU387	GV7AU387
	440–480 V 60 Hz	GV4AU486	GV4AU486	—	—
Shunt Trip (Mx)	525–600 V 60 Hz	—	—	P29409	P29409
	24 V 50/60 Hz	GV4AS027	GV4AS027	P29384	P29384
	24 Vdc	—	—	—	—
	48 V 50/60 Hz—48 Vdc	GV4AS057	GV4AS057	GV7AS055	GV7AS055
110–130 V 50/60 Hz—125 Vdc	GV4AS137	GV4AS137	GV7AS107	GV7AS107	

[29] One trip or one fault signaling can be fitted per GV3.

[30] Cannot be used with **GV2GH7** insulator.

[31] Mounting of a **GVAE** contact block or a **GV2AK00** visible isolation block on **GV2P**.

[32] Choice of N.C. or N.O. contact operation, depending on which way the reversible block is mounted.

[33] The **GVAD** is always mounted next to the starter.

Common Accessories		BV4 Reference	GV4 Reference	GV5 Reference	GV6 Reference
	208–240 V 50/60 Hz	GV4AS287	GV4AS287	GV7AS207	GV7AS207
	277 V 60 Hz	—	—	—	—
	380–415 V 50 Hz–440–480 V 60 Hz	GV4AS487	GV4AS487	GV7AS387	GV7AS387
	525–600 V 60 Hz	—	—	P29389	P29389
Rotary handles					
Direct	With black handle on black font	GV4ADN01	GV4ADN01	GV5AP03	GV6AP03
	With red handle on yellow font	GV4ADN02	GV4ADN02	GV7AP04	LV432599
Front extended IP54	With black handle on black font	GV4APN01	GV4APN01	GV7AP01 (2)	LV432598 (2)
	With red handle on yellow font	GV4APN02	GV4APN02	GV7AP02 (2)	LV432600 (2)
Front extended IP65	With red handle on yellow font	GV4APN04	GV4APN04	—	—
Lateral	With black handle on black font	LV426935	LV426935	—	—
	With red handle on yellow font	LV426936	LV426936	—	—
Open door shaft operator		LV426937	LV426937	—	—
Laser alignment tool to aid in aligning hole on door with rotary mechanism		GVAPL01	GVAPL01	GVAPL01	GVAPL01

### Additional BV4 and GV4 Accessories

Accessory	BV4 Reference	GV4 Reference
Cabling Accessories		
EverLink Connector (replacement)	LAD96565	LAD96565
Large Spacing Cover for EverLink Connector (replacement)	GV4G66	—
Crimp Lug Connector + Screws	GV4LUG	GV4LUG
Transparent Terminal Shield for Crimped Lug Connector	LAD96590	LAD96590
Interphase Barriers	LV426920	LV426920
One Time Torque Limiters, Green—9 N.m (set of 6)	LV426990	LV426990
One Time Torque Limiters, Yellow—5 N.m (set of 6)	LV426992	LV426992
Locking Accessories		
Removable Toggle Locking Device for 1 to 3 Padlocks	29370	—
Bag of 6 Leads + 6 Sealing Accessories	LV429375	—
Programming Tools		
Pocket Battery—Allows changes to settings on the GV4PB when not powered by the line voltage	—	LV434206
GV4PB cord for USB Maintenance Interface	—	TRV00917
EcoStruxure Power Commission app	—	Free download

### Additional GV5 and GV6 Accessories

Accessory	GV5PB150.. Reference	GV5PB250.. Reference	GV6PB.. Reference
Cabling Accessories			
Mechanical lug kit (set of 3)	14–10 AWG (2.5–6mm <sup>2</sup> )—Al/Cu	AL150HD	—
	14–2/0 AWG (2.5–70mm <sup>2</sup> )—Cu	CU150HD	—
	4–4/0 AWG (25–95mm <sup>2</sup> )—Al/Cu	—	AL175JD
	3/0–350 kcmil AWG (95–185mm <sup>2</sup> )—Al/Cu	—	AL250JD
	1/0 AWG–300 kcmil (50–185mm <sup>2</sup> )—Al/Cu	—	CU250JD
	2 AWG–500 kcmil (35–240mm <sup>2</sup> )—Al	—	—
	2 AWG–600 kcmil (35–300mm <sup>2</sup> )—Cu	—	—
	2 AWG–600 kcmil (35–300mm <sup>2</sup> )—Cu	—	—
	2/0 AWG–500 kcmil (70–240 mm <sup>2</sup> )—Al/Cu	—	—
	2/0 AWG–500 kcmil (70–240mm <sup>2</sup> )—Cu	—	—
	3/0 AWG–500 kcmil (95–240)—Al/Cu	—	—
3/0 AWG–500 kcmil (95–240)—Cu	—	—	
Terminal Nut Insert kit/Bus Bar Connections	1/4–20 Tap (set of 3)	S37444	S37445
	M10 x 25 terminal screws and washers for one side (set of 4)	—	—
Terminal Shield	Short Terminal Shield	S37447	S37448
	Medium Terminal Shield	—	—
	Long Terminal Shield	—	—
Phase Barriers	Phase Barriers (set of 6)	S29329	S29329
32570	—	—	
Locking & Other Accessories			
Door Lock	Removable Door lock (lock off only)	S29370	S29370
	Fixed Door lock (on or off)	S29371	S29371
Toggle Extension	Fixed (set of 5)	S29313	S29313
S432553	—	—	

Refer to Catalog MKTED210011EN

Enclosed TeSys™ Deca Starters

TeSys Deca enclosed full-voltage starters are available in Type 1 and Type 12/3R enclosures. The enclosed TeSys Deca offer accepts standard TeSys Deca accessories and all Insta-Kits control units and control power transformer kits. For additional sizes, combinations and accessory options, see Catalog 8100CT1901. Check with local sales office for availability.



LE1D093A62OB70

Table 18.103: Insta-Kits for Enclosed Full Voltage Non-Reversing Starters<sup>[34]</sup>

Max. Horsepower Ratings						Auxiliary Contacts On Each Contactor		Current Rating of Contactor	Catalog Number <sup>[35]</sup>	
Single-Phase		Three-Phase				N.O.	N.C.		Type 1	Type 12/3R
120 V	240 V	208 V	230 V	460 V	575 V					
1/3	1	2	2	5	7.5	1	1	9	LE1D093A62O****	LE1D093A72O****
1/2	2	3	3	7.5	10	1	1	12	LE1D123A62O****	LE1D123A72O****
1	3	5	5	10	15	1	1	18	LE1D183A62O****	LE1D183A72O****
2	3	5	7.5	15	20	1	1	25	LE1D253A62O****	LE1D253A72O****
2	5	7.5	10	20	25	1	1	32	LE1D323A62O****	LE1D323A72O****
3	5	10	10	30	30	1	1	40	LE1D403A62O****	LE1D403A72O****
3	7.5	15	15	40	40	1	1	50	LE1D503A62O****	LE1D503A72O****
5	10	20	20	40	50	1	1	65	LE1D653A62O****	LE1D653A72O****

Table 18.104: Voltage Codes for Enclosed Starters

Primary Voltage	120	208	240
Code	G7	L7	U7

TeSys Deca dimensions: TeSys™ Deca Non-Combination Starter Dimensions, page 18-62

Insta-Kits Selection

With the use of Insta-Kits, only one operator scheme is allowed. For additional accessory kits and options, see Catalog 8100CT1901. Check with local sales office for availability.

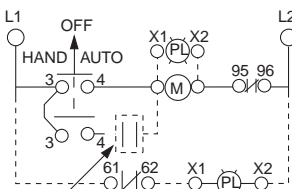
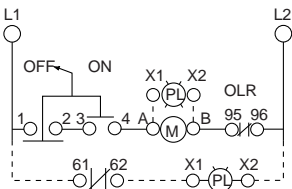
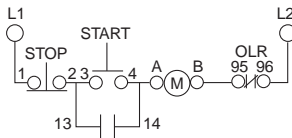



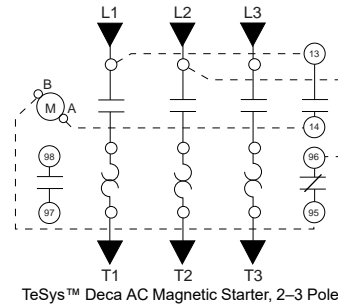

From top to bottom: Start/Stop, On - Off Selector Switch, HOA Selector Switch



[34] See Table 18.25 TeSys™ Deca Overload Relays—Ambient Compensated, Bimetallic, Direct Mounting, page 18-12 for field installable overload relays.

[35] To obtain a single phase non-reversing starter, change prefix LE1 to LES. (e.g., LE1D093A62O\*\*\*\* becomes LESD093A62O\*\*\*\*). Price remains unchanged.

**Table 18.105: Insta-Kit Accessories for Field Installation**

Symbol	Description	Color	Nameplate	Suffix/Cat. No. [36]
				NEMA Type 1
<b>One operator on cover</b>				
	2 Position selector switch	Black	Off - On	LA9CA06DT
	3 Position selector switch	Black	Hand - Off - Auto	LA9CA06ET
	2 Push buttons	Green Red	Start Stop	LA9CA06GT
	3 Position selector switch, Pilot light (transformer type)	Black Red/Green	Hand - Off - Auto Power On	LA9CA06UT

**TeSys™ LS1 Fuse Holders**

- 45 mm wide (same dimensions as GV2ME)
- Mounts directly to LC1D09–D38 contactors (with use of GV2AF3 or GV2AF4)
- Meets application needs for fusible starter
- Uses GV2AE instantaneous contact blocks to open control circuits
- DIN rail mounted

**Table 18.106: TeSys LS1 Fuse Holders**

Description	Fuse Type	Dimensions		Catalog Number
		in.	mm	
Screw clamp terminals, 3-pole	CC, KTK-R	0.41 x 1.5	10.3 x 38	LS1D30



LS1D30

  
 E164862  
 CCN NLDX  
  
 LR43364  
 Class 3211 04  

[36] Catalog numbers beginning with LA9 are only for starters with a "2" before the voltage code. When using a factory option that does not have a corresponding customer kit, the 10th digit of the starter must change from a "2" to a "1".

Altistart™ Drive and TeSys™ Ultra Motor Starter

Table 18.107: Soft Start / Soft Stop Unit for 0.75 to 15 kW Motors (can be combined with the TeSys Ultra starter)

Motor		Starter	
Motor Power, hp <sup>[1]</sup>		Nominal Current, A	Catalog Number
230 V	460 V		
3-phase supply voltage: 200 to 480 V 50/60 Hz			
1	2	6	ATSU01N206LT
1.5	3		
2	5	9	ATSU01N209LT
3	7.5	12	ATSU01N212LT
5	10		
7.5	15	22	ATSU01N222LT
10	20	32	ATSU01N232LT

Table 18.108: Accessories

Description	Used for Starter	Catalog Number
Power connector between ATSU 01N2●●LT and TeSys™ Ultra	ATSU01N2●●T	VW3G4104

Table 18.109: TeSys Ultra Starter and Soft Start Unit Combinations

Motor Power, hp		Soft Starter	TeSys Ultra	
Voltage			Power Base	Control Unit <sup>[2]</sup>
200 V	460 V			
1	2	ATSU01N206LT	LUB 12	LUC●05BL
1.5	3	ATSU01N206LT		LUC●12BL
2	5	ATSU01N209LT		LUC●12BL
3	—	ATSU01N212LT		LUC●12BL
—	7.5	ATSU01N212LT		LUC●18BL
5	10	ATSU01N222LT		LUC●18BL
7.5	15	ATSU01N222LT	LUB 32	LUC●32BL
10	20	ATSU01N232LT		LUC●32BL



ATSU01●●



E164862  
CCN NLDX



LR43364  
Class 3211 04



[1] Standard motor power ratings, HP power ratings indicated according to standard UL 508.

[2] Depending on the configuration of the chosen TeSys Ultra starter, replace the ● with A for standard, B for advanced, and M for multifunction. See Table 18.75 for a complete list of available control units. Control voltage must be 24 Vdc.

**TeSys™ Deca—AC Coils**

**Table 18.110: For LC1D09–D38, LC1DT20–DT40 Contactors and CAD Relays**

Rated Nominal Voltage	Catalog Number, 50/60 Hz
24	LXD1B7
120	LXD1G7
208	LXD1LE7
230/240	LXD1U7
277	LXD1W7
Specifications	50/60 Hz
Average consumption - Inrush (inductance 0.75) - Sealed (inductance 0.3)	70 VA 7 VA
Operating range @ 60° C	80–110% of nominal @ 50 Hz, 85–110% of nominal @ 60 Hz

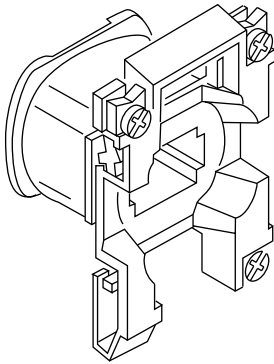

LX1D2

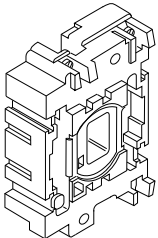

LX1D6

**Table 18.111: For Old D2 Style LC1D40, D50, D65, D80, and D95; For TeSys Deca LC1D40A, D50A, D65A, DT60A, and DT80A; For TeSys Deca LC1D115 and D150**

For TeSys™ Deca LC1D40A, D50A, D65A, DT60A, DT80A	
Rated Nominal Voltage, V	Catalog Number 50/60 Hz
<b>For TeSys™ Deca LC1D40A, D50A, D65A, DT60A, DT80A</b>	
24	LXD3B7
120	LXD3G7 <sup>[1]</sup>
208	LXD3LE7 <sup>[1]</sup>
240	LXD3U7
480	LXD3T7 <sup>[2]</sup>
Specification	50/60 Hz
Average consumption	
-inrush (inductance 0.3)	140 VA (Inductance: 0.9)
-sealed (inductance 0.3)	7.5 VA (Inductance: 0.9)
Operating range	
at $\theta \leq 55^\circ\text{C} / 131^\circ\text{F}$	80–115% of nominal voltage
<b>For TeSys™ Deca LC1D115, D150</b>	
24	LX1D8B7
120	LX1D8G7
208	LX1D8L7
240	LX1D8U7
277	LX1D8UE7
480	LX1D8T7
Specification	50/60 Hz
Average consumption	
-inrush (inductance 0.8)	350 VA (Inductance: 0.9)
-sealed (inductance 0.3)	18 VA (Inductance: 0.9)
Operating range	
at $\theta \leq 55^\circ\text{C} / 131^\circ\text{F}$	80–115% of nominal voltage

**Table 18.112: TeSys™ F—AC Coils (For LC1F115, F150, F185, F225, F265, F330, F400, F500, F630, F780, F800, and F1400–F2100)**

Contactor	F115-F150	F185-F225	F265-F330	F400	F500	F630	F780 <sup>[3]</sup>	F800 <sup>[4]</sup>	F1400-F2100 <sup>[4]</sup>
<b>Coil Part Number AC 50/60 Hz</b>									
120 V	LX9FF127	LX9FG127	LX1FH1272	LX1FJ127	LX1FK127	LX1FL110	LX1FX110	LX4F8FW	LX1FK070 <sup>[5]</sup>
240 V	LX9FF220	LX9FG220	LX1FH2402	LX1FJ240	LX1FK240	LX1FL220	LX1FX220	LX4F8MW	LX1FK127
480 V	LX9FF500	LX9FG500	LX1FH5002	LX1FJ500	LX1FK500	LX1FL415	LX1FX415	—	LX1FK240
<b>Coil Part Number DC</b>									
24 V	LX4FF024	LX4FG024	LX4FH024	—	—	—	—	—	—

[1] 60 Hz only  
 [2] This coil can only be used on 60 Hz.  
 [3] LC1F780 contactors operate with 2 coils as a set. The LX1FX\* part number includes both coils.  
 [4] Also requires rectifier DR5TE4U for 110–240 V coils.  
 [5] Order 2 coils and connect them in series.

TeSys™ Giga Contact Kits, Arc Chambers

Table 18.113: Replacement Contact Sets [6]

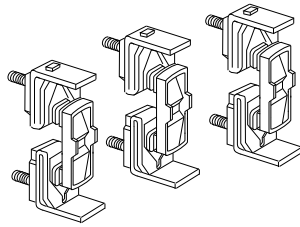

LA5FG431

	For use on contactors	Number of Poles	Catalog Number
Three-pole	LC1F115, F150	3 poles	LA5FF431
	LC1F185, F225	3 poles	LA5FG431
	LC1F265	3 poles	LA5FH431
	LC1F330, F400	3 poles	LA5F400803
	LC1F500	3 poles	LA5F500803
	LC1F630	3 poles	LA5F630803
	LC1F780	1 pole	LA5F780801 [7]
	LC1F800	3 poles	LA5F800803

TeSys Giga contactors: [page 18-17](#) and [page 18-18](#)  
 TeSys Giga overload relay accessories: [page 18-19](#)  
 TeSys Giga replacement coils and parts: [page 18-20](#), and [page 18-21](#)  
 TeSys Giga dimensions: [page 18-49](#), [page 18-61](#)

Replaceable Switching Modules

- Innovative contact switching modules for TeSys™ Giga Contactors
- Replace worn-out poles with a new switching module in minutes, without having to disassemble the entire product.
- No special tools are needed for the replacement



LA9G3QA

Table 18.114: TeSys™ Giga – Switching modules for TeSys Giga contactors (Standard and Advanced versions)

Description	Suitable for:	For contactors	Reference
3 or 4 switching module kits	3-pole	LC1G115/LC1G225	LA9G3QA
		LC1G265/LC1G330	LA9G3RA
		LC1G400/LC1G500	LA9G3SA
	4-pole	LC1G630/LC1G800	LA9G3TA[8]
		LC1G115/LC1G225	LA9G4QA
		LC1G265/LC1G330	LA9G4RA
		LC1G400/LC1G500	LA9G4SA
		LC1G630/LC1G800	LA9G4TA[8]

**NOTE:** During replacement, replace all switching modules. After replacement, change the position of the RESET button on the control module from A to B or B to A.

[6] Supplied per pole are: 2 fixed contacts, 1 moving contact, 2 deflectors, 1 backplate, mounting screws and washers.  
 [7] Two identical components per pole are supplied.  
 [8] Available 2Q 2022.



**TeSys™ AK5 Panel Busbar System**

The AK5 pre-fabricated bus bar system provides a quick and easy method of mounting control devices. All components are finger safe, UL Listed, CSA approved and CE marked. Although the AK5 system can be screw mounted onto any type of support, it **must be mounted** on the AM1DL201 DIN rail when component mounting plates incorporating a tap-off are used. When using tap-offs, the nominal operating current of the bus bar (160 A @ 35°) must not be exceeded. Approvals include IEC 439, UL, CSA, DNV and LROS.

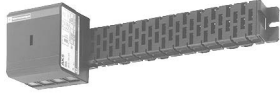

AK5JB busbar

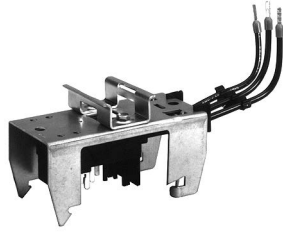

AK5PA231

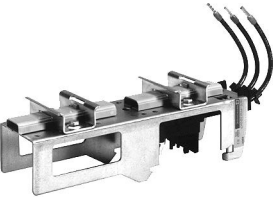

AK5PA232S

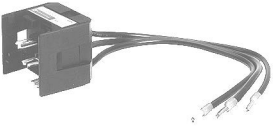

AK5PC33



AM1DL201

**Table 18.115: 160 A, 3-Phase Busbar System**

Maximum number of mounting plates						Length	Catalog Number
Tap-off		Standard Width Plate		Extension Plate			
1.42 in.	36 mm	2.13 in.	54 mm	2.80 in.	71 mm	in.	mm
15		10		5		26.05	668
24		16		8		38.69	992
							<a href="#">AK5JB146</a>
							<a href="#">AK5JB149</a>

**Table 18.116: Mounting Plate Tap-off (plugs into busbar mounted on AM1DL201 DIN rail)**

Width		Thermal Current Amperes	Application	Catalog Number
in.	mm			
2.13	54	25 A	GV2 with LUS or LUB 12 and 32 contactor	<a href="#">AK5PA231</a>
2.13	54	25 A		<a href="#">AK5PA232</a>

**Table 18.117: Bus Tap-off (plugs into busbar for wiring to a separately mounted device)**

Width		Thermal Current (A)	Length of Leads		Catalog Number
in.	mm		in.	mm	
1.42	36	32 A	9.84	250	<a href="#">AK5PC33</a>
1.42	36	32 A	39.37	1000	<a href="#">AK5PC33L</a>

**Table 18.118: Mounting Rail (must be used for mounting plates with tap-offs)**

Description	Depth	Length	Catalog Number
	mm	mm	
75 mm Omega Rail	15	2000	<a href="#">AM1DL201</a>



File E161251  
CCN NMTR



File LR 89150  
Class 6228-01

TeSys™ island Load Management System Module Dimensions

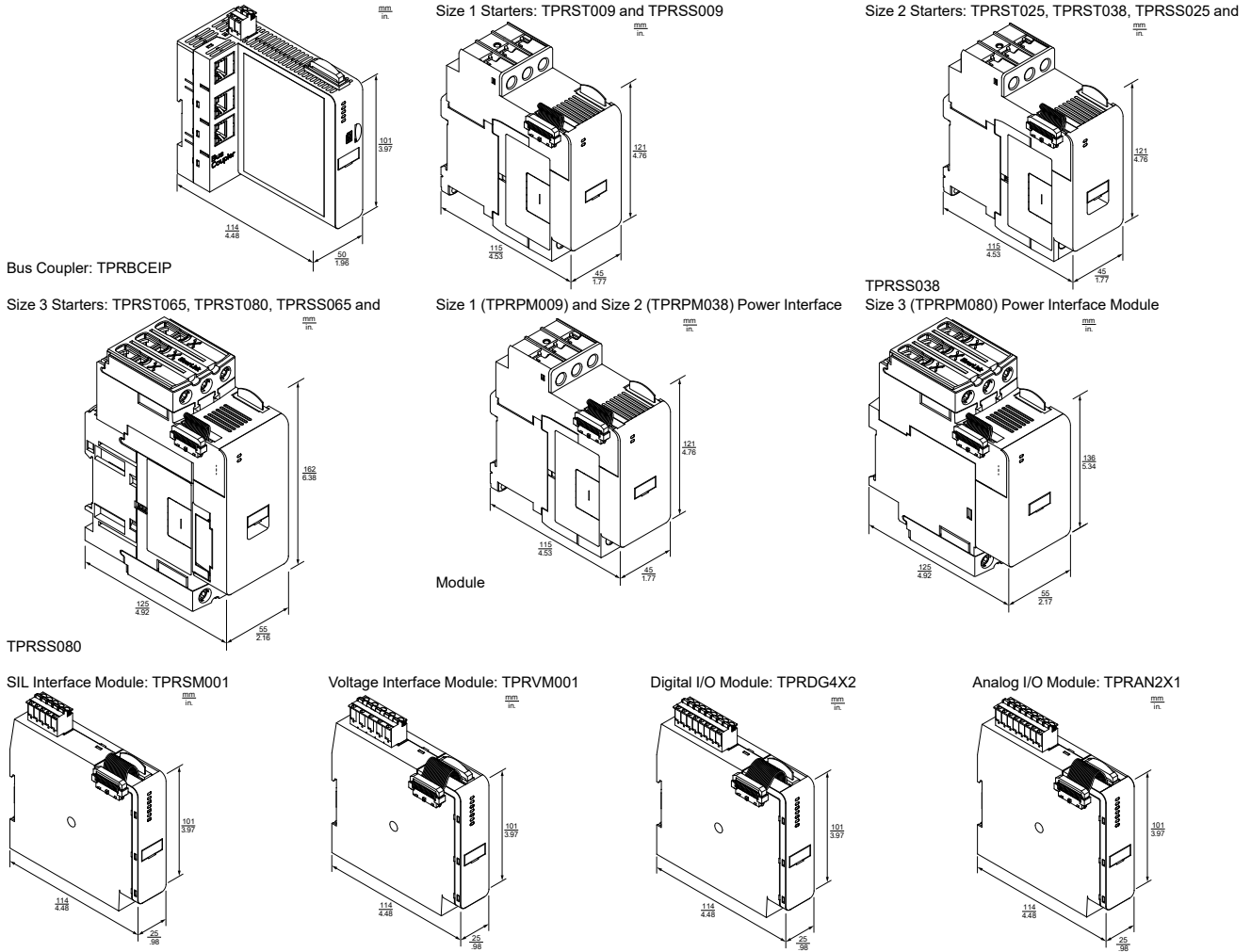

TeSys™ Deca Contactors, AC and DC Coil

Table 18.119: TeSys Deca 9 to 38 A Contactors, AC and DC Coils

LC1D09 to D18		LC1D25 to D38 (3-pole) and LC1DT20 to DT40 (4-pole)				
TeSys Deca contactors: LC1D		D09 to D18 in. (mm)	D25 to D38 in. (mm)	D098, D128, DT20, DT25 in. (mm)	DT32, DT40 in. (mm)	D188, D258 in. (mm)
b	AC coil, without add-on accessories	3.03 (77)	3.36 (85)	3.34 (85)	3.58 (91)	4.13 (105)
	DC coil	3.03 (77)	3.36 (85)	3.34 (85)	3.58 (91)	4.13 (105)
b1	AC coil, with LAD4BB	3.70 (94)	3.85 (98)	3.85 (98)	—	—
	AC coil, with LA4D*2	4.33 (110) [1]	4.48 (114) [1]	4.48 (114)	—	—
	AC coil, with LA4DF, DT	4.68 (119) [1]	4.84 (123) [1]	5.02 (129)	—	—
	AC coil, with LA4DR, DW, DL	4.96 (126) [1]	5.11 (130) [1]	7.48 (190)	—	—
c	AC coil, without cover or add-on blocks	3.30 (84)	3.54 (90)	3.54 (90)	3.85 (98)	3.85 (98)
	AC coil, with cover, without add-on blocks	3.38 (86)	3.62 (92)	3.62 (92)	3.93 (100)	3.93 (100)
	DC coil, without cover or add-on blocks	3.66 (93)	3.89 (99)	—	—	—
	DC coil, with cover, without add-on blocks	3.76 (95)	3.97 (101)	3.90 (99)	4.21 (107)	4.21 (107)
c1	AC coil, with LADN or C (two or four contacts)	4.60 (117)	4.84 (123)	4.84 (123)	5.15 (131)	5.15 (131)
	DC coil, with LADN or C (two or four contacts)	4.96 (126)	5.19 (132)	4.84 (123)	5.15 (131)	5.15 (131)
c2	AC coil, with LAD6K10	5.07 (129)	5.31 (135)	5.31 (135)	5.62 (143)	5.62 (143)

[1] Including LAD4BB.

**Table 18.119 TeSys Deca 9 to 38 A Contactors, AC and DC Coils (cont'd.)**

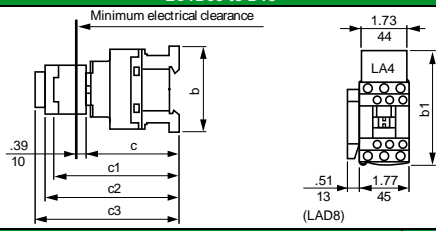
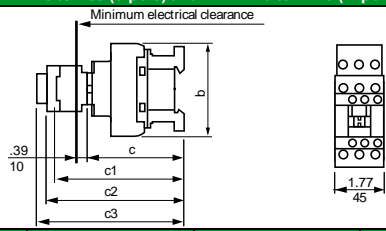
LC1D09 to D18		LC1D25 to D38 (3-pole) and LC1DT20 to DT40 (4-pole)				
						
TeSys Deca contactors: LC1D		D09 to D18 in. (mm)	D25 to D38 in. (mm)	D098, D128, DT20, DT25 in. (mm)	DT32, DT40 in. (mm)	D188, D258 in. (mm)
c3	DC coil, with LAD6K10	5.43 (138)	5.66 (144)	5.31 (135)	5.62 (143)	5.62 (143)
	AC coil, with LADT, R, S	5.39 (137)	5.62 (143)	5.62 (143)	5.94 (151)	5.94 (151)
	AC coil, with LADT, R, S and sealing cover	5.55 (141)	5.78 (147)	5.78 (147)	6.10 (155)	6.10 (155)
	DC coil with LADT, R, S	5.76 (146)	5.98 (152)	5.62 (143)	5.94 (151)	5.94 (151)
	DC coil with LADT, R, S and sealing cover	5.90 (150)	6.14 (156)	5.78 (147)	6.10 (155)	6.10 (155)

**Table 18.120: TeSys Deca 40 A to 65 A, AC and DC coil**

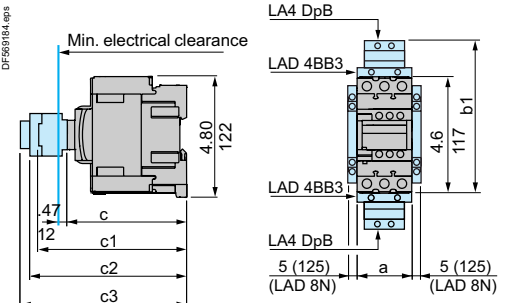
LC1 D40A–D65A (3P), LC1 DT60A–DT80A (4P) AC OR DC	LC1	D40A–D65A	DT60A–DT80A	
		in. (mm)	in. (mm)	
	a	2.17 (55)	2.76 (70)	
	b1	with LA4 D●2	—	—
		with LA4 DB3 or LAD 4BB3	5.35 (136)	—
		with LA4 DF, DT	6.18 (157)	—
		with LA4 DM, DW, DL	6.54 (166)	—
	c	without cover or add-on blocks	4.65 (118)	4.65 (118)
		with cover, without add-on blocks	4.72 (120)	4.72 (120)
	c1	with LADN (1 contact)	—	—
		with LADN or C (2 or 4 contacts)	5.91 (150)	5.91 (150)
	c2	with LAD 6K10 or LA6 DK	6.42 (163)	6.42 (163)
with LADT, R, S		6.73 (171)	6.73 (171)	
c3	with LADT, R, S and sealing cover	6.89 (175)	6.89 (175)	

**Table 18.121: TeSys Deca D80 and D95 AC Coil**

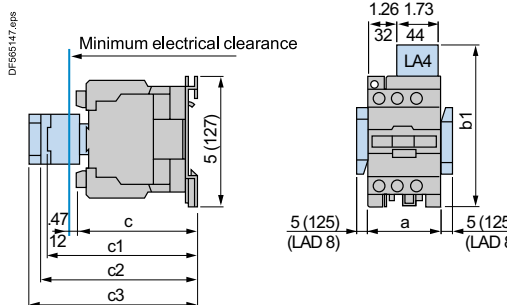
LC1D80 and D95 (3P), LP1 D80004 and D80008 (4P)	LC1	D80	D95	D80004	D80008	
		in. (mm)	in. (mm)	in. (mm)	in. (mm)	
	a	3.35 (85)	3.35 (85)	3.78 (96)	3.78 (96)	
	b1	with LA4 D●2	5.31 (135)	5.31 (135)	5.31 (135)	5.31 (135)
		with LA4 DB3 or LAD 4BB3	5.31 (135)	—	—	—
		with LA4 DF, DT	5.59 (142)	5.59 (142)	5.59 (142)	5.59 (142)
		with LA4 DM, DW, DL	5.90 (150)	5.90 (150)	5.90 (150)	5.90 (150)
	c	without cover or add-on blocks	4.92 (125)	4.92 (125)	4.92 (125)	5.51 (140)
		with cover, without add-on blocks	5.12 (130)	5.12 (130)	—	—
	c1	with LADN (1 contact)	5.90 (150)	5.90 (150)	5.90 (150)	5.90 (150)
		with LADN or C (2 or 4 contacts)	6.22 (158)	6.22 (158)	6.22 (158)	6.22 (158)
	c2	with LAD 6K10 or LA6 DK	6.69 (170)	6.69 (170)	6.69 (170)	6.69 (170)
with LADT, R, S		7 (178)	7 (178)	7 (178)	7 (178)	
c3	with LADT, R, S and sealing cover	7.16 (182)	7.16 (182)	7.16 (182)	7.16 (182)	

TeSys™ Deca Contactors, DC Coil

Table 18.122: DC Coil

LC1D80, D95 (3P), LP1D80004, D80008 (4P)	LC1	D80 and D95	D80004	D80008	
		in. (mm)	in. (mm)	in. (mm)	
<p>Minimum electrical clearance</p> <p>1.26 1.73 32 44 LA4 5 (127) 47 12 c c1 c2 c3 5 (125) (LAD 8) a b1 5 (125) (LAD 8)</p>	a	3.35 (85)	3.78 (96)	3.78 (96)	
	b1	with LAD 4BB3	—	—	—
		with LA4 DF, DT	—	—	—
	c	without cover or add-on blocks	7.13 (181)	7.13 (181)	7.72 (196)
		with cover, without add-on blocks	7.32 (186)	—	—
	c1	with LAD N (1 contact)	8.03 (204)	8.03 (204)	8.03 (204)
		with LAD N or C (2 or 4 contacts)	8.27 (210)	8.27 (210)	8.27 (210)
	c2	with LA6 DK10	8.70 (221)	8.70 (221)	8.70 (221)
		with LAD T, R, S	9.01 (229)	9.01 (229)	9.01 (229)
	c3	with LAD T, R, S and sealing cover	9.17 (233)	9.17 (233)	9.17 (233)
LC1D115, D150 (3P), LC1D115004 (4P), AC and DC Coils Panel mounted with 1/4" screws	LC1	D115, D150	D115004	D1150046	
<p>Min. electrical clearance</p> <p>1.39 1.0 6.22 158 3.9 1.0 c c1 c2 c3 5.35 5.91 6.10 6.61 6.77 LA4 LAD 8 a b1</p> <p>With 2 or 4 contacts. + 4 mm with sealing cover.</p>	a	4.72 (120)	5.91 (150)	6.10 (155)	
	b1	with LA4DA2	6.85 (174)	6.85 (174)	6.85 (174)
		with LA4DF, DT	7.28 (185)	7.28 (185)	7.28 (185)
		with LA4DM, DL	7.40 (188)	7.40 (188)	7.40 (188)
	c	with LA4DW	5.20 (132)	5.20 (132)	4.53 (115)
		without cover or add-on blocks	5.35 (136)	—	—
	c1	with cover, without add-on blocks	5.35 (136)	—	—
		with LAD N or C (2 or 4 contacts)	5.91 (150)	5.91 (150)	5.91 (150)
	c2	with LA6DK20	6.10 (155)	6.10 (155)	6.10 (155)
		with LAD T, R, S	6.61 (168)	6.61 (168)	6.61 (168)
c3	with LAD T, R, S and sealing cover	6.77 (172)	6.77 (172)	6.77 (172)	

**TeSys™ F Contactors, Dimensions**

All dimensions shown in mm.  
To convert to inches, divide by 25.4.

**LC1F115 to F330**

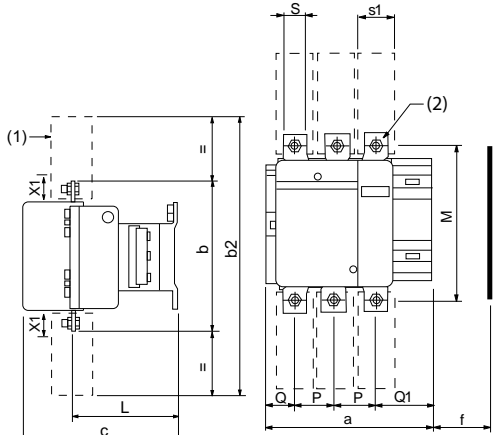

(1) Protective cover  
Type LA9F70•

(2) Optimal terminal shroud

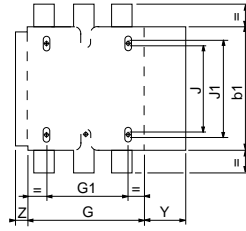

**Table 18.123: LC1F115–F330 Dimensions**

LC1	F115		F150		F185		F225		F265		F330	
	3-Pole	4-Pole	3-Pole	4-Pole	3-Pole	4-Pole	3-Pole	4-Pole	3-Pole	4-Pole	3-Pole	4-Pole
a	163.5	200.5	163.5	200.5	168.5	208.5	168.5	208.5	201.5	243.5	213	261
b	162	162	170	170	174	174	197	197	203	203	206	206
b1	137	137	137	137	137	137	137	137	145	145	145	145
b2	265	265	301	301	305	305	364	364	370	370	375	375
c	165 [2]	165 [2]	165 [2]	165 [2]	176	176	181	181	207	207	219	219
f	131	131	131	131	130	130	130	130	147	147	147	147
G	106	143	106	143	111	151	111	151	142	190	154.5	202.5
G1	80	80	80	80	80	80	80	80	96	96	96	96
J	106	106	106	106	106	106	106	106	106	106	106	106
J1	120	120	120	120	120	120	120	120	120	120	120	120
L	107	107	107	107	113.5	113.5	113.5	113.5	141	141	145	145
M	147	147	150	150	154	154	172	172	178	178	181	181
P	37	37	40	40	40	40	48	48	48	48	48	48
Q	29.5	29.5	26.5	26	29	29	21	17	39	34	43	43
Q1	60	60	57.5	55.5	59.5	59.5	51.5	47.5	66.5	66.5	74	74
S	15	15	20	20	20	20	25	25	25	25	25	25
S1	27	27	34	34	34	34	44.5	44.5	38	38	44.5	44.5
Y	44	44	44	44	44	44	44	44	38	38	38	38
Z	13.5	13.5	13.5	13.5	13.5	13.5	13.5	13.5	21.5	21.5	20.5	20.5

f = minimum distance required for coil removal.

**Table 18.124: LC1F115–F330 Voltage**

	200 to 500 V	600 to 1000 V
LC1F115, F150	10	15
LC1F185	10	15
LC1F225, F265	10	15
LC1F330	10	15

X1: Minimum clearance according to the operational voltage and the breaking capacity.

**LC1F400 to F500**

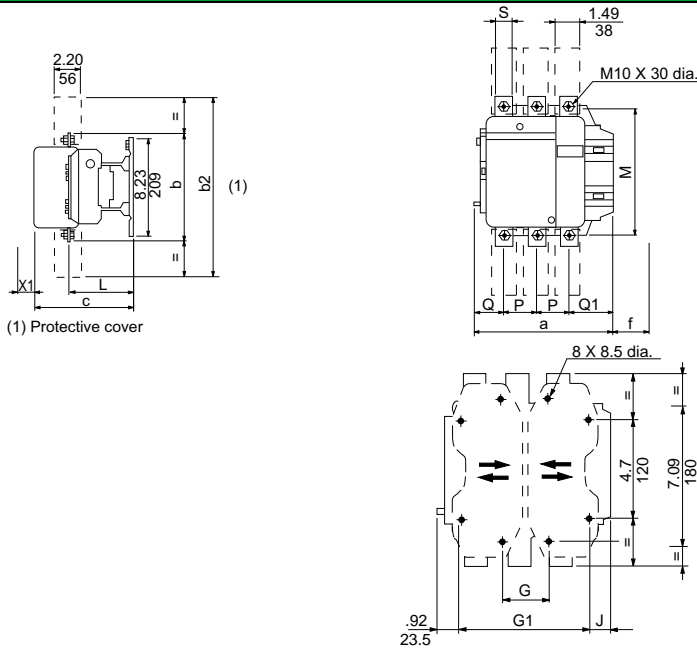

(1) Protective cover

**Table 18.125: LC1F400–F500 Dimensions**

LC1	F400			F500		
	2-Pole	3-Pole	4-Pole	2-Pole	3-Pole	4-Pole
a	213	213	261	233	233	288
b	206	206	206	238	238	238
b2	375	375	375	400	400	400
c	213	213	213	226	226	226
f	119	119	119	141	141	141
G [3]	80	80	80	80	80	140
G min.	66	66	66	66	66	66
G max.	102	102	150	120	120	175
G1 [3]	170	170	170	170	170	230
G1 min.	156	156	156	156	156	156
G1 max.	192	192	240	210	210	265
J	19.5	19.5	67.5	39.5	39.5	34.5
L	145	145	145	146	146	146
M	181	181	181	208	208	208
P	48	48	48	55	55	55
Q	69	43	43	76	46	46
Q1	96	74	74	102	77	77
S	25	25	25	30	30	30

f = Minimum distance required for coil removal.

**Table 18.126: LC1F400–F500 Voltage**

	200 to 500 V	600 to 1000 V
LC1F400	15	20
LC1F500	15	20

X1: Minimum clearance according to the operational voltage and the breaking capacity.

[2] +6 mm with time delay block (for F115 and F150).  
[3] Supplied.

Table 18.127: LC1F Dimensions

LC1F630 and LC1F800

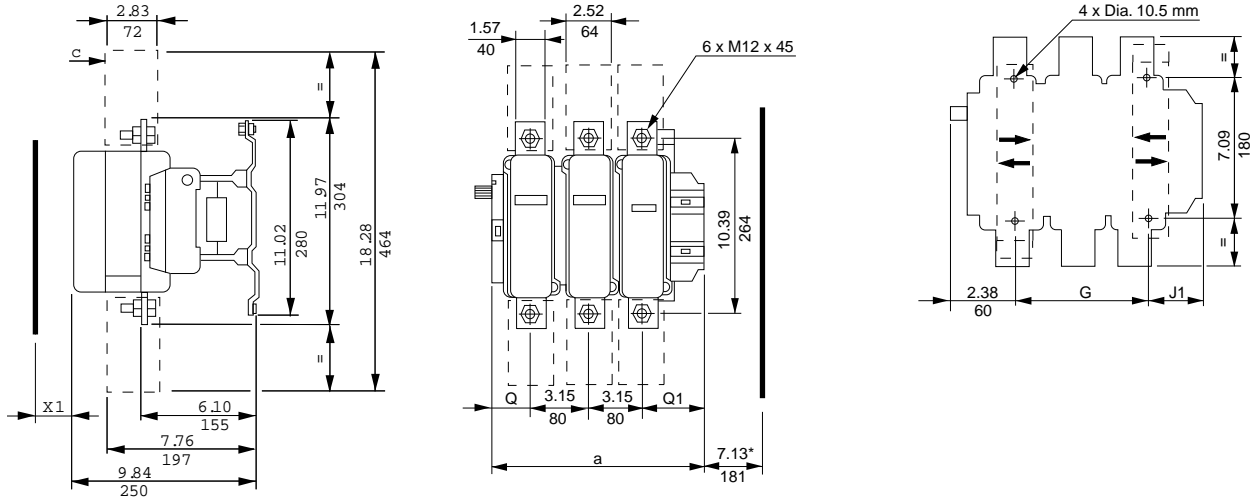

X1: Minimum clearance according to the operational voltage and the breaking capacity.

	LC1F630	a	G supplied	G min.	G max.	J1	Q	Q1							
* = minimum distance required for coil removal.	2 P	12.17	309	7.09	180	3.94	100	7.68	195	2.70	68.5	4.02	102	5.00	127
♦ Protective terminal cover.	3 P	12.17	309	7.09	180	3.94	100	7.68	195	2.70	68.5	2.36	60	3.50	89
	4 P	15.31	389	9.45	240	5.91	150	10.83	275	2.70	68.5	2.36	60	3.50	89

Voltage (V)	200–500 V	690–1000 V	200–690 V	1000 V
F630	20	30	—	—
F800	—	—	10	20

LC1F780, F7804

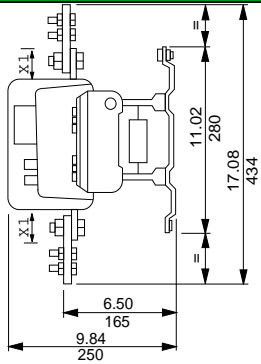

X1: Minimum clearance according to the operational voltage and the breaking capacity.

Voltage (V)	200–500 V	690–1000 V
X1 in mm	30	35

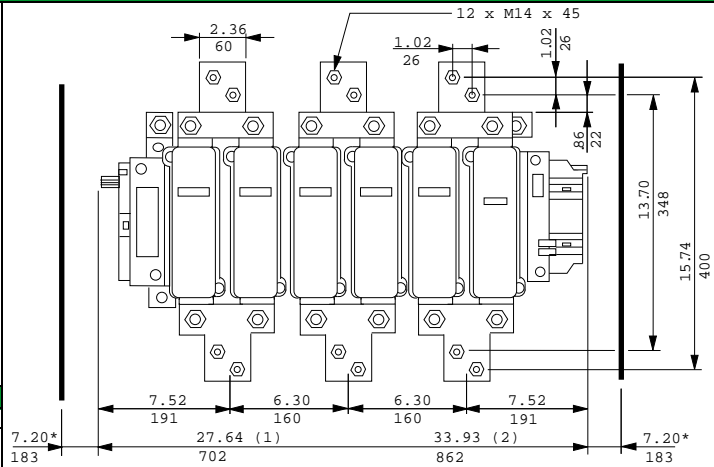

1) Overall length (3 poles).  
2) Overall length (4 poles).  
\* Minimum distance required for coil removal.

LC1F780 mounting

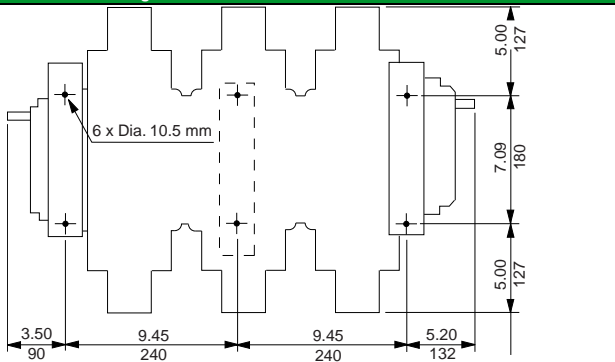

LC1F7804 mounting

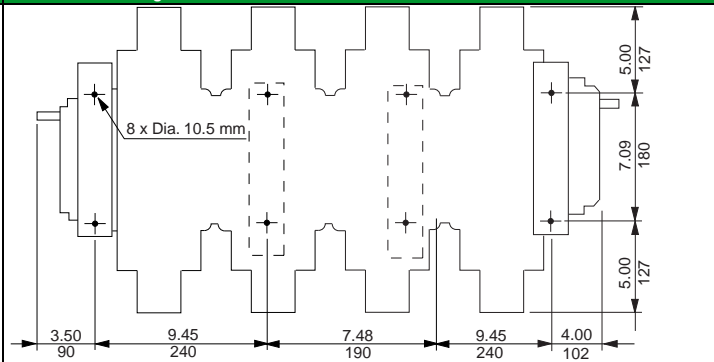

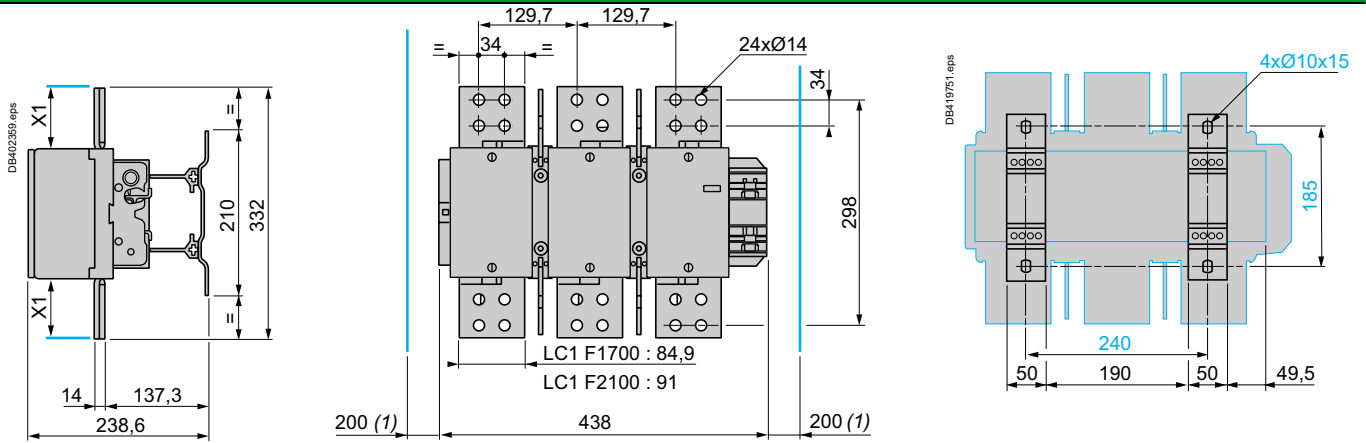

X1: Minimum clearance according to the operational voltage and the breaking capacity.  
 1) Minimum distance required for coil removal.

Voltage (V)	200–500 V	690–1000 V
X1 in mm	90	100

TeSys™ Deca Reversing Contactor Dimensions

Table 18.128: Reversing Contactor Dimensions

LC2D09–D38  
2 x LC1D09 to D38

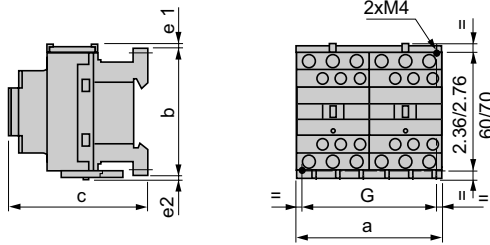

LC2 or 2 x LC1	a	b	c [4]	e1	e2	G
	in. (mm)	in. (mm)	in. (mm)	in. (mm)	in. (mm)	in. (mm)
D09 to D18 (AC Coil)	3.54 (90)	3.03 (77)	3.38 (86)	0.16 (4)	0.06 (1.5)	3.14 (80)
D093 to D123 (AC Coil)	3.54 (90)	3.9 (99)	3.38 (86)	—	—	3.14 (80)
D09 to D18 (DC Coil)	3.54 (90)	3.03 (77)	3.74 (95)	0.16 (4)	0.06 (1.5)	3.14 (80)
D093 to D123 (DC Coil)	3.54 (90)	3.9 (99)	3.74 (95)	—	—	3.14 (80)
D25 to D38 (AC Coil)	3.54 (90)	3.34 (85)	3.62 (92)	0.35 (9)	0.20 (5)	3.14 (80)
D183 to D383 (AC Coil)	3.54 (90)	3.9 (99)	3.62 (92)	—	—	3.14 (80)
D25 and D32 (DC Coil)	3.54 (90)	3.34 (85)	3.98 (101)	0.35 (9)	0.20 (5)	3.14 (80)
D183 to D383 (DC Coil)	3.54 (90)	3.9 (99)	3.98 (101)	—	—	3.14 (80)

e1 and e2: includes cabling

LC2DT20 to DT40  
2 x LC1 DT20 to DT40

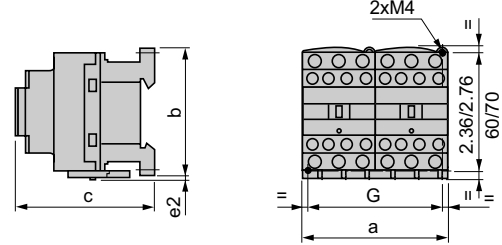

LC2 or 2 x LC1	a	b	c	G
	in. (mm)	in. (mm)	in. (mm)	in. (mm)
DT20 and DT25 (AC Coil)	3.54 (90)	3.34 (85)	3.62 (92)	3.14 (80)
DT32 and DT40 (AC Coil)	3.54 (90)	3.58 (91)	3.9 (99)	3.14 (80)
DT20 and DT25 (DC Coil)	3.54 (90)	3.34 (85)	4 (102)	3.14 (80)
DT32 and DT40 (DC Coil)	3.54 (90)	3.58 (91)	4.29 (109)	3.14 (80)

c, e: includes cabling

LC2D40A to D65A  
2 x LC1D40A to D65A

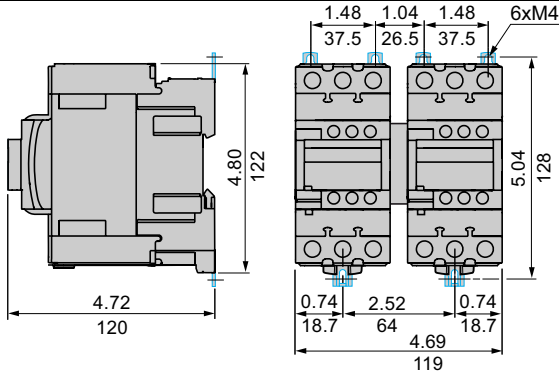

LC2D80 and D95  
2 x LC1D80 and D95 (AC Coil)

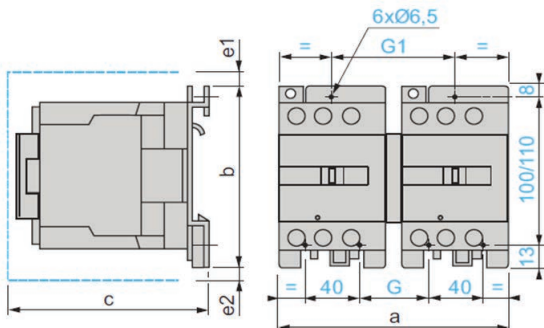

LC2 or 2 x LC1	a	b	c	e1	e2	G	G1
	in. (mm)	in. (mm)	in. (mm)	in. (mm)	in. (mm)	in. (mm)	in. (mm)
D80 and D95	7.17 (182)	5 (127)	6.22 (158)	0.51 (13)	—	2.24 (57)	3.78 (96)
D80004	8.15 (207)	5 (127)	6.22 (158)	—	0.79 (20)	2.8 (71)	4.37 (111)

c, e1, and e2: includes cabling

2 x LC1D80 and D95 (DC Coil)

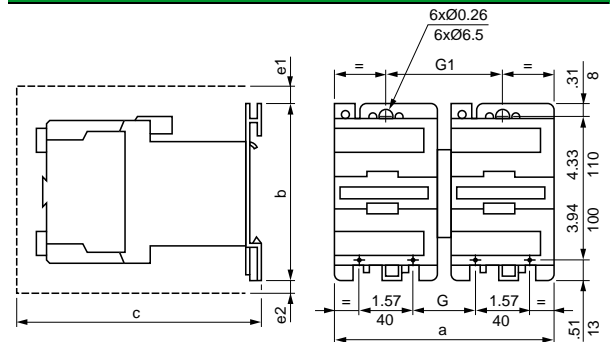

2 x LC1	a	b	c	e1	e2	G	G1
	in. (mm)	in. (mm)	in. (mm)	in. (mm)	in. (mm)	in. (mm)	in. (mm)
D80 and D95	8.15 (207)	5.0 (127)	8.46 (215)	0.51 (13)	0.79 (20)	3.78 (96)	4.37 (111)

c, e1 and e2: includes cabling.

[4] With safety cover, without add-on block.



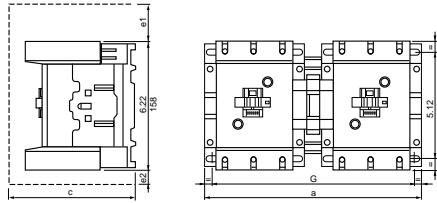

LC2 or 2 x LC1	a	c	e1	e2	G
	in. (mm)	in. (mm)	in. (mm)	in. (mm)	in. (mm)
D115, D150	10.47 (266)	5.83 (148)	2.2 (56)	0.71 (18)	9.53/10.08 (242/256)
D115004	13.15 (334)	5.83 (148)	—	2.36 (60)	12.2/12.76 (310/324)

c, e1 and e2 includes cabling

**NOTE:** For dimensions of TeSys F reversing contactors, please refer to catalog [MKTED210011EN](#).

TeSys™ Deca Open Starter Dimensions

Table 18.129: TeSys Deca Thermal Overload Relay Dimensions, in. (mm)

**LRD01-35**  
Direct mounting beneath contactors with screw clamp connections

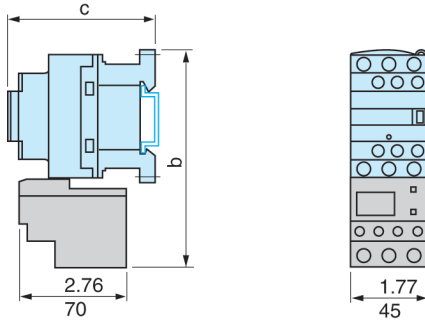

LC1•	D09-D18	D25-D38
b	4.84 (123)	5.39 (137)
c	See page 18-46	

**LRD04L-32L**  
Direct mounting beneath contactors with screw clamp connections

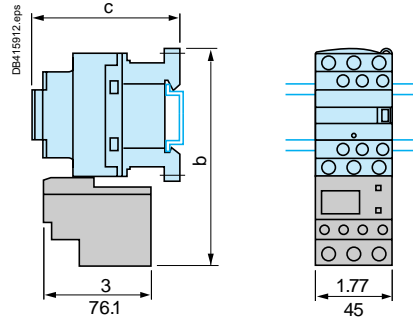

LC1•	D09-D18	D25-D38
b	4.84 (123)	5.39 (137)
c	See page 18-46	

**LR9D01, 02, 08, and 32**

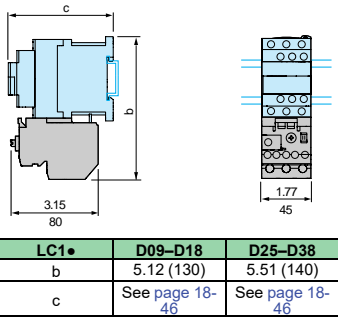

LC1•	D09-D18	D25-D38
b	5.12 (130)	5.51 (140)
c	See page 18-46	See page 18-46

**LRD313-365**  
Direct mounting beneath LC1D40A to D65A with screw clamp connectors or EverLink connectors

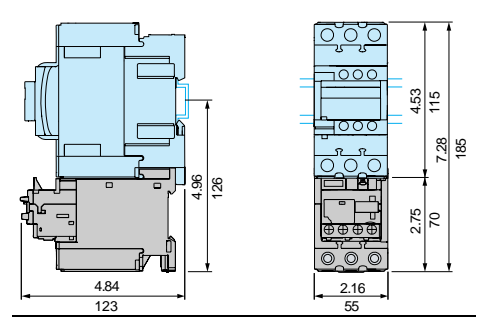

**LRD33•••**  
Direct mounting beneath contactors  
LC1D80 to D95

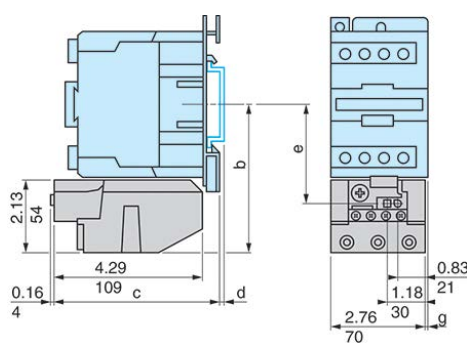

AM1•	DL201		DL200		
d	0.28 (7)		0.67 (17)		
	b	c	e	g (3P)	g (4P)
AC Control Circuit					
LC1D80	4.55 (115.5)	4.88 (124)	3.03 (76.9)	0.37 (9.5)	0.87 (22)
LC1D95	4.55 (115.5)	4.88 (124)	3.03 (76.9)	0.37 (9.5)	—
DC Control Circuit					
LP1D80	4.55 (115.5)	7.06 (179.4)	3.03 (76.9)	0.37 (9.5)	0.87 (22)

[www.se.com/us](http://www.se.com/us)

**LRD4••••[5]**  
Direct mounting beneath contactors LC1D115 and D150

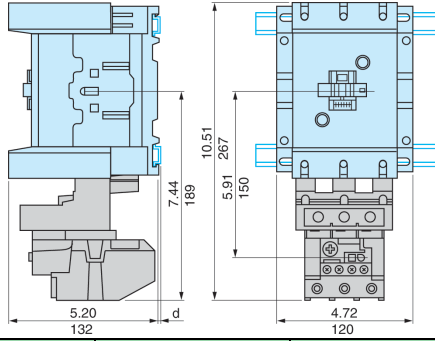

AM1	DL200 and DR200	DE200 and ED•••
d	0.10 (2.5)	0.41 (10.5)

**LR9D5••• and LR9D6•[5]**  
Direct mounting beneath contactors LC1D115 and D150

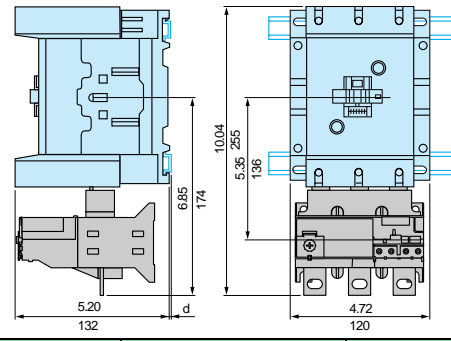

AM1	DP200 and DR200	DE200 and ED•••
d	0.10 (2.5)	0.41 (10.5)

[5] For additional specifications and selection information, see catalog [MKTED210011EN](#)

TeSys™ Giga Contactors (Dimensions)

Table 18.130: Standard Version LC1G630...800 TeSys™ Giga High Power Contactors

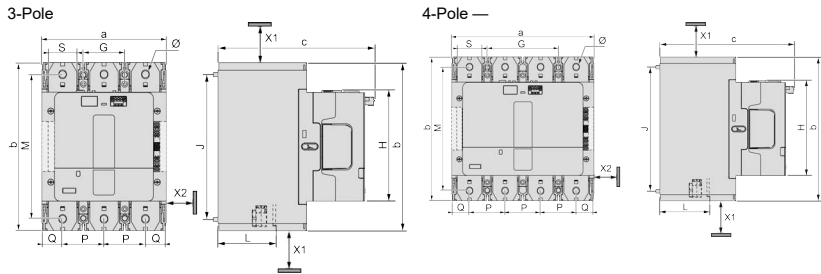

All dimensions are in mm.

X1 (mm) = Minimum electrical clearance.

LC1G115...800, up to 1000 V: 40 mm.

X2 (mm) = Minimum electrical clearance according to operating voltage inside metallic cabinets/adjacent installation of contactors.

LC1G115...800, up to 600 V: 5 mm.

Table 18.131: Standard Version — 3-Pole

a	b	c	G	J	M	H	L	P	Q	S	Ø
210	284	265	70	242	244	192	107	70	35.3	48	13

Table 18.132: Standard Version — 4-Pole

a	b	c	G	J	M	H	L	P	Q	S	Ø
280	284	265	140	242	244	192	107	70	35.3	48	13

Table 18.133: Mechanical Interlock

	Description	Reference
Mechanical Interlock (between the same frame sizes)	LC1G115 to 225 (3-Pole and 4-Pole)	LA9G970
	LC1G265 to 500 (3-Pole and 4-Pole)	LA9G973
Mechanical Interlock (between different frame sizes)	LC1G630 to 800 (3-Pole)	LA9G971
	LC1G265 to 500 and LC1G115 to 225 (3-Pole and 4-Pole)	LA9G972

**Table 18.134: Advanced Version LC1G630...800 TeSys™ Giga High Power Contactors**

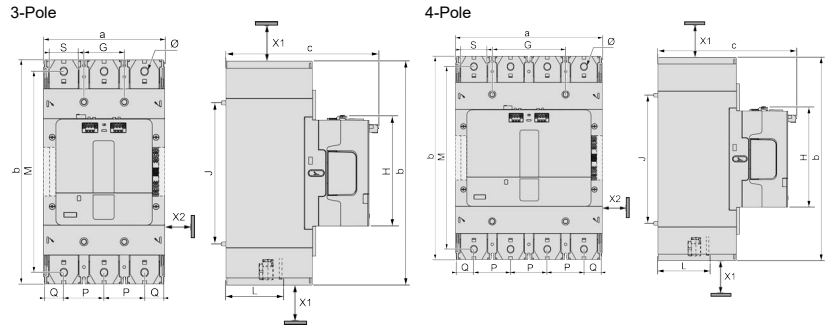

All dimensions are in mm.

X1 (mm) = Minimum electrical clearance.

LC1G115...800, up to 1000 V: 40 mm.

X2 (mm) = Minimum electrical clearance according to operating voltage inside metallic cabinets/adjacent installation of contactors.

LC1G115...800, up to 600 V: 5 mm

**Table 18.135: Advanced Version — 3-Pole**

a	b	c	G	J	M	H	L	P	Q	S	Ø
210	388.5	265	70	242	346.5	192	107	70	35.3	48	13

**Table 18.136: Advanced Version — 4-Pole**

a	b	c	G	J	M	H	L	P	Q	S	Ø
280	388.5	265	140	242	346.5	192	107	70	35.3	48	13

TeSys™ Deca Thermal Overload Relay Dimensions

LRD01-35  
Independent mounting on 1.97 in. (50 mm) centers or on rail AM1DP200 or DE200

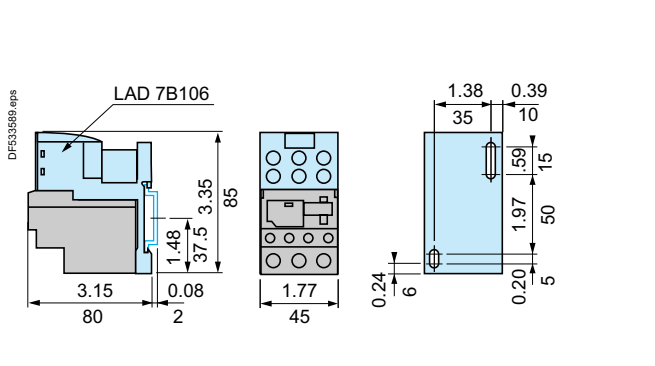

Independent mounting on 4.33 in. (110 mm) centers

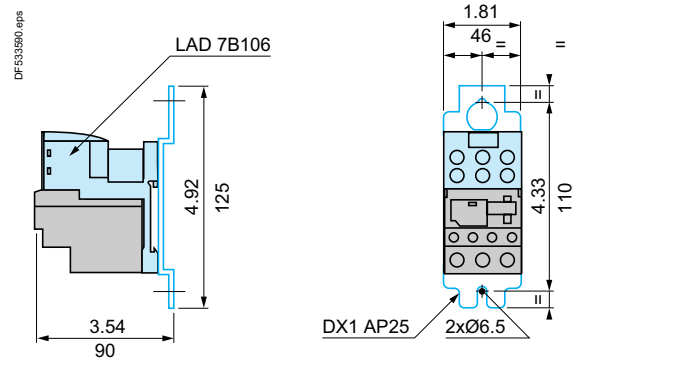

LRD04L-32L  
Independent mounting on 1.97 in. (50 mm) centers or on rail AM1DP200 or DE200

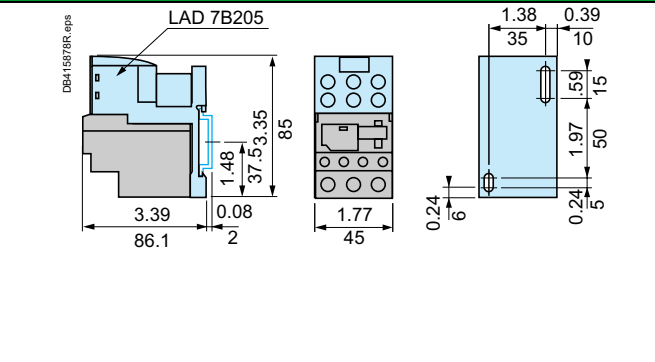

Independent mounting on 4.33 in. (110 mm) centers

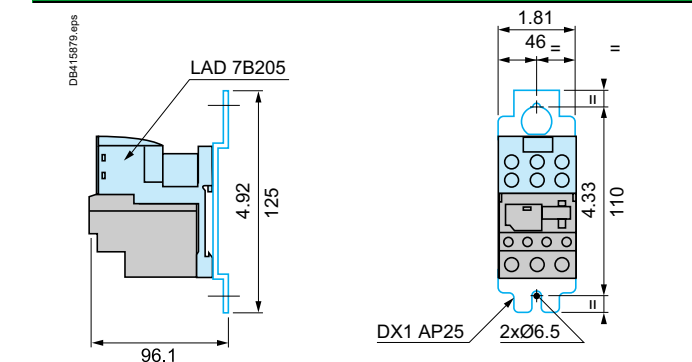

AM1	DP200	DE200
d	0.08 (2)	0.37 (9.5)

LRD313-365  
Mounting on rail AM1D•200 or ED200  
With terminal block LAD96560

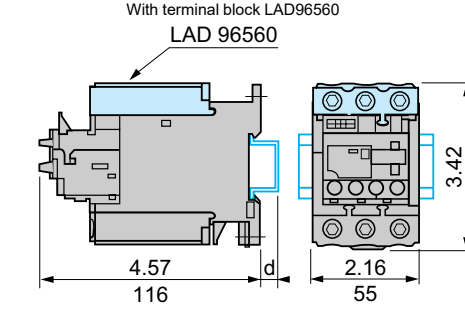

Panel mounting  
Outgoing terminal block not shown

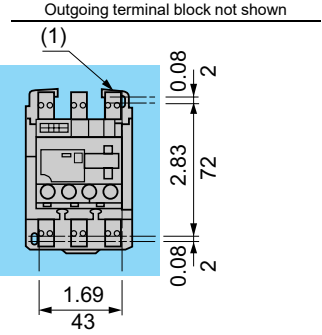

Mounted on plate AM1P

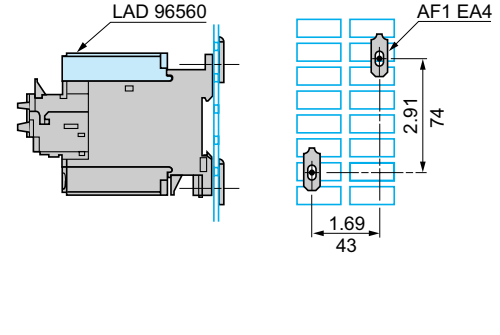

AM1	DP200	DE200	ED200
d	0.08 (2)	0.37 (9.5)	0.37 (9.5)

(1) 2 elongated holes Ø4.2 x 6.

LRD01-35 and LRD313-365  
Remote tripping or electrical reset

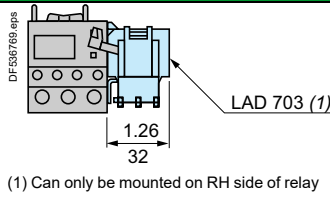

(1) Can only be mounted on RH side of relay

www.se.com/us

**LR9D01-D32**

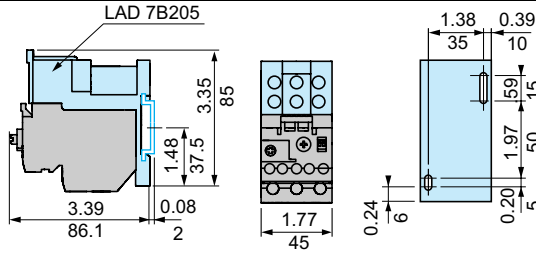

**LR9D110S**

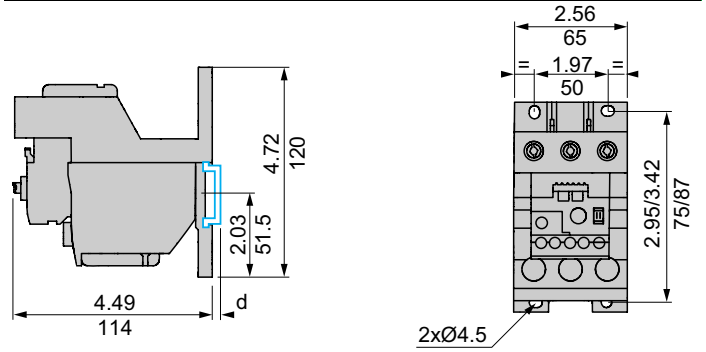

**LRD3... and LR2D35...**

Independent mounting on 1.97 in. (50 mm) centers or on rail AM1DP200 or DE200

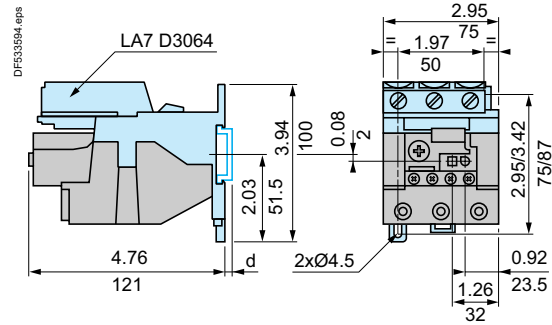

**LRD3..., LR2D35..., and LR9D5**  
Remote tripping or electrical reset

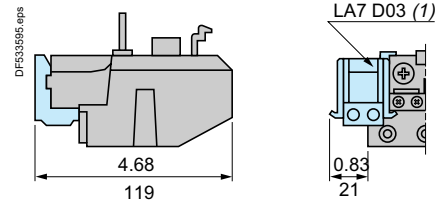

AM1	DP200	DE200
d	0.08 (2)	0.37 (9.5)

(1) Can be mounted on RH or LH side of relay LRD3..., LR2D35..., or LR9D

**LRD3... Adapter for door-mounted operator**

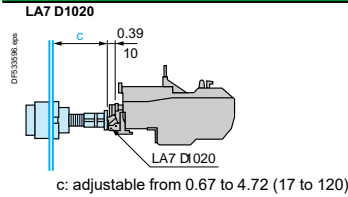

**LRD, LRD313-365, LRD04-32L, LR9D5, and LR9D6**  
"Reset" by flexible cable

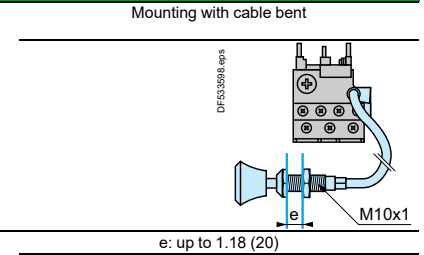
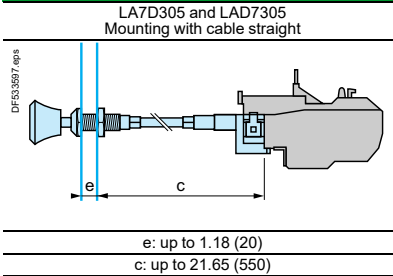

TeSys™ Giga Overload Relays (Dimensions)

Table 18.137: TeSys™ Giga Overload Relays, Dimensions — LR9G115...630

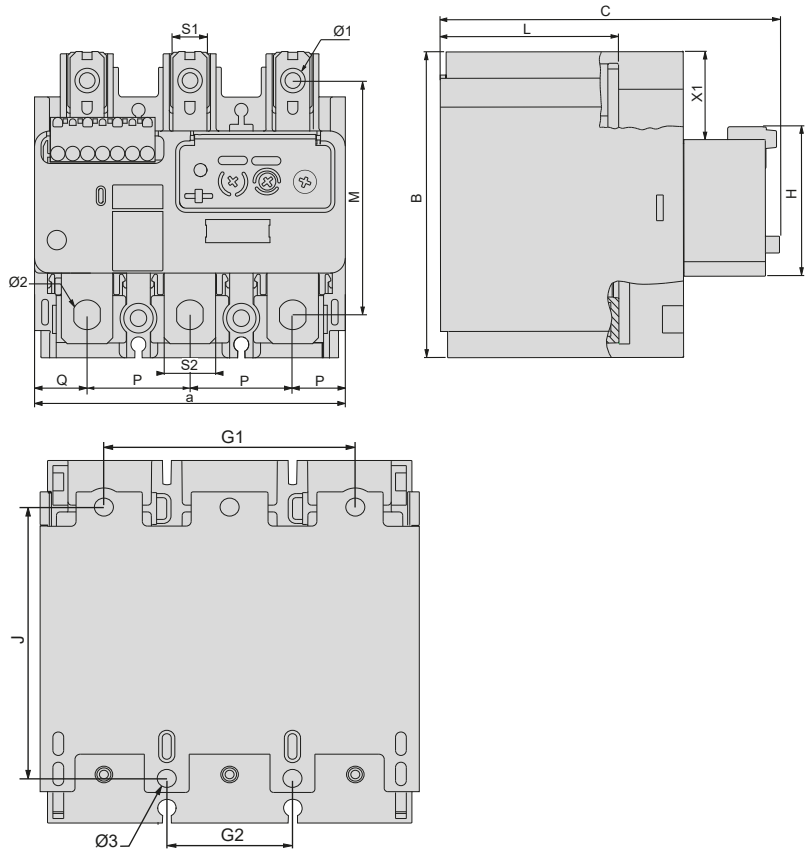

LR9G	115...225	500	630
a	105.7	140	210
b	109.55	115.65	149.45
c	126.2	139.2	185.9
G1	70	119.3	186.2
G2	35	45	70
J	80.1	68.25	87
M	78	83	100
H	52	47	47
L	66	79	107
P	35	45	70
Q	18	25	35
S1	11.5	22.5	22.5
S2	17.5	30.5	50
Ø1	8.3	10.6	13
Ø2	9	10.6	13
Ø3	5.3	5.3	8.5
X1	30	33	50



**TeSys™ F Overload Relay Dimensions**

All dimensions shown in mm.  
To convert to inches, divide by 25.4.

**Table 18.138: TeSys F Overload Relay Dimensions**

LR9F5•71, F71	LR9F5•57, F5•63, F5•67, F5•69, F57, F63, F67, F69
Common side view	Common side view
1) Terminal shroud LA9F70•	2) 6.5 x 13.5 for LR9F5•57 and F57. 8.5 x 13.5 for LR9F5•63, F5•67, F5•69, F63, F67, F69.

LR9F7•75, F7•79, F7•81, F75, F79, F81	LR9F7•81, F81									
Common side view	Common side view (for mounting beneath LC1F630 and LC1F800)									
(1) Terminal shroud LA9-F70•										
<table border="1"> <thead> <tr> <th></th> <th>P1</th> <th>P2</th> </tr> </thead> <tbody> <tr> <td>LR9F7•75, F75</td> <td>48</td> <td>48</td> </tr> <tr> <td>LR9F7•79, F7•81, F79, F81</td> <td>55</td> <td>55</td> </tr> </tbody> </table>		P1	P2	LR9F7•75, F75	48	48	LR9F7•79, F7•81, F79, F81	55	55	
	P1	P2								
LR9F7•75, F75	48	48								
LR9F7•79, F7•81, F79, F81	55	55								

Direct mounting beneath contactor LC1F	Direct mounting beneath reversing contactors or star-delta contactors
(2) Relay mounting plate, see .	(1) Connection accessories, see . (2) Relay mounting plate, see .

LC1 contactors	With LR9 relays	b	H1	H2	H3	LC1 contactors	With LR9 relays	b	H4	H2	H3
F115	F5•57, F5•63, F5•67, F5•69, F57, F63, F67, F69	240	30	76	120	F115	F5•57, F5•63, F5•67, F5•69, F57, F63, F67, F69	279	60	76	120
F150	F5•57, F5•63, F5•67, F5•69, F57, F63, F67, F69	246	30	76	120	F150	F5•57, F5•63, F5•67, F5•69, F57, F63, F67, F69	283	60	76	120
F185	F5•57, F5•63, F5•67, F5•69, F57, F63, F67, F69	250	30	76	120	F185	F5•57, F5•63, F5•67, F5•69, F57, F63, F67, F69	285	60	76	120
F225	F5•71, F71	273	40	76	120	F225	F5•71, F71	319	80	76	120
	F7•75, F7•79, F75, F79	308	50	108.8	120		F7•75, F7•79, F75, F79	360	100	108.8	120
F265	F5•71, F71	279	40	76	120	F265	F5•71, F71	332	90	76	120
	F7•75, F7•79, F75, F79	314	60	108.8	120		F7•75, F7•79, F75, F79	363	100	108.8	120
F330	F7•75, F7•79, F75, F79	317	60	108.8	120	F330	F7•75, F7•79, F75, F79	364	100	108.8	120
F400	F7•75, F7•79, F7•81, F75, F79, F81	317	60	108.8	180	F400	F7•75, F7•79, F7•81, F75, F79, F81	364	100	108.8	180
F500	F7•75, F7•79, F7•81, F75, F79, F81	346	70	108.8	180	F500	F7•75, F7•79, F7•81, F75, F79, F81	390	110	108.8	180
F630, F800	F7•81, F81	510	110	108.8	180	F630, F800	F7•81, F81	509	120	108.8	180

TeSys™ Deca Non-Combination Starter Dimensions

Table 18.139: Non-Combination Starter Dimensions [6]

Non-Combination Starters

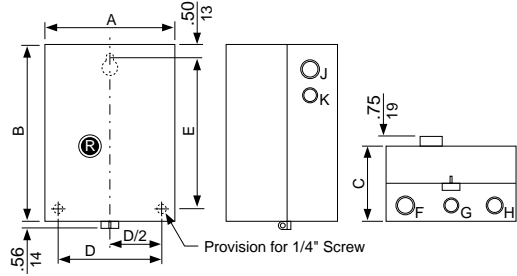

		Type 1										Type 12/3R	
Non-Reversing	Reversing	A	B	C	D	E	F	G	H	J	K	D	E
D09-32	—	6.77	10.04	6.25	5.38	9.00	1–1.25	0.5–0.75	—	1–0.25	0.5–0.75	5.38	11.37
D40-65	D09-32	8.66	10.83	7.21	7.25	9.75	1.25–1.5	0.5–0.75	1–1.25	1–0.25	0.5–0.75	5.38	12.15

[6] All dimensions in inches.

**TeSys™ K Contactor Dimensions**

**Table 18.140: TeSys K Contactor Dimensions**

<p><b>LR2K</b> Direct mounting under the contactor</p>	<p>Separate mounting with LA7-K0064 terminal block on 35 mm rail (AM1DP200 or AM1DE200)</p>
<p><b>Three-phase</b></p>	<p><b>Wiring Scheme</b></p>
<p><b>LC1, LP1, LP4K</b> Mini-contactors On baseplate</p>	<p><b>LC2, LC8, LP2, LP5K</b> Reversing mini-contactors On baseplate</p>
<p><b>On AM1DP200 or DE200 rail (35 mm)</b></p>	<p><b>On AM1DP200 or DE200 rail (35 mm)</b></p>
<p><b>On printed circuit board</b></p>	<p><b>On printed circuit board for reversing contactors or 2 mini-contactors side-by-side</b></p>
<p><b>LA2KT</b> Electronic time delay contact blocks</p>	<p><b>On mini-contactors or reversing mini-contactors</b></p>

TeSys™ Ultra Starter Dimensions

Table 18.141: TeSys Ultra Starter Dimensions

Starter Controllers			
Non-Reversing [7]		Reversing	
Rail Mounting	Screw Mounting	Rail Mounting	Screw Mounting

NOTE: Minimum electrical clearance:  
 X1: 35 mm for Ue = 440 V; and 70 mm for Ue = 500 and 690 V  
 X2: 0

Reversing Block for Mounting Separately from Power Base

Rail Mounting	Screw Mounting

Limiter Disconnecter LUALB1 [7]

--

Door interlock Mechanisms

LU9APN43 and LU9APN44

--

[7] Maximum depth (with Modbus™ communication module)

**Altistart™ U01 and TeSys™ Ultra Soft Starters, Mounting**

**Table 18.142: Altistart U01 and TeSys Ultra Soft Starters**

TeSys Ultra Combination (non-reversing power base) and ATSU01N212LT Mounting on (35 mm) rail with VW3 G4104 connector	TeSys Ultra Combination (non-reversing power base) and ATSU01N222LT to ATSU01N232LT Mounting on (35 mm) rail with VW3 G4104 connector
TeSys Ultra Combination (non-reversing or reversing power base) and ATSU01N2206LT to ATSU01N212LT Side-by-side mounting	TeSys Ultra Combination (non-reversing or reversing power base) and ATSU01N222LT to ATSU01N232LT Side-by-side mounting

**VW3G4104 Power Connector**

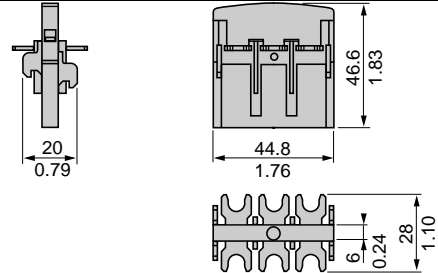

TeSys™ Deca GV2 and GV3 Manual Starter and Protector Dimensions

Table 18.143: TeSys™ Deca GV2 and GV3 Manual Starter and Protector Dimensions

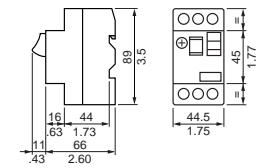
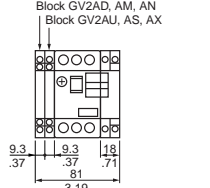
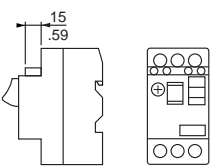
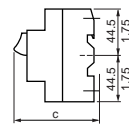
GV2M	GV2AD, AM, AN, AU, AS, AX	GV2AE	Mounting of GV2M
			<p>On 35 mm 1/2 rail                      C = 78.5 mm (3.09") on AM1DP200 (35 x 7.5 mm)                      C = 86 mm (3.39") on AM1DE200, ED200 (35 x 15 mm)</p> 

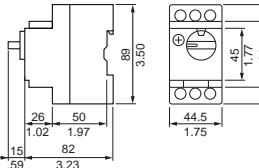
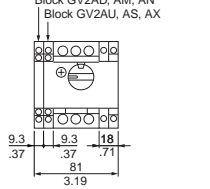
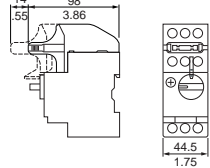
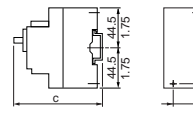
GV2P	GV2AD, AM, AN, AU, AS, AX	GV2AK00	Mounting of GV2P
			<p>On 35 mm 1/2 rail                      C = 98.5 mm (3.88") on AM1DP200 (35 x 7.5 mm)                      C = 106 mm (4.17") on AM1DE200, ED200 (35 x 15 mm)</p> 

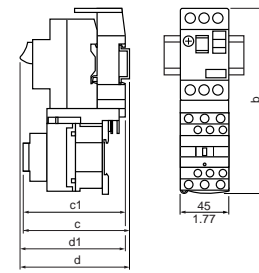
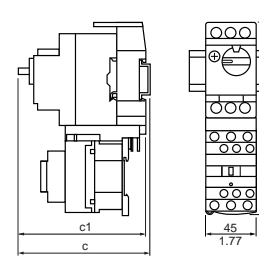
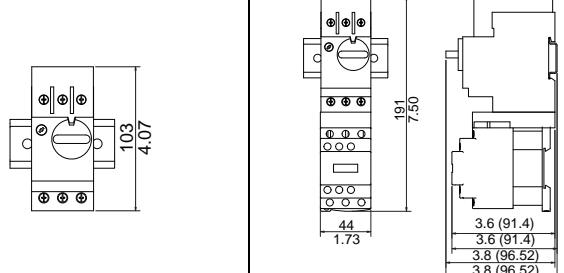
GV2AF4 + LAD31	GV2P + GV2GH7	GV2P + GV2GH7 + LC1D TeSys Deca contactor
<p>Combination GV2ME + LC1D TeSys Deca range contactor</p> 	<p>Combination GV2P + LC1D TeSys Deca range contactor</p> 	<p>for UL 508 Type E application</p> 

GV2ME +	LC2D09 to D18	LC2D25 and D32	GV2P +	LC2D09 to D18	LC2D25 and D32
b	7.4 (188.6)	7.8 (199)	b	6.61 (168.1)	7.9 (199.5)
c1	3.6 (92.7)	3.9 (99)	c1	4.6 (116.8)	4.6 (116.8)
c	3.9 (98.2)	4.11 (104.5)	c	4.8 (122.3)	4.8 (122.3)
d1	3.9 (98.3)	3.9 (98.3)	—	—	—
d	4.1 (103.8)	1.4 (103.8)	—	—	—

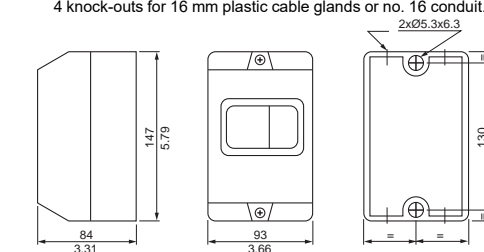
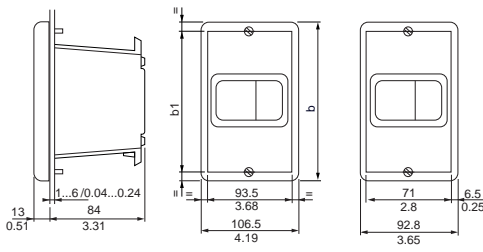
Surface mounting enclosure GV2MC0•	Flush mounting enclosure GV2MP0• (bracket cut-out)
<p>4 knock-outs for 16 mm plastic cable glands or no. 16 conduit.</p> 	

GV2	b		b1	
	in.	mm	in.	mm
MP01, MP02	5.51	140	5.00	127
MP03, MP04	5.24	133	4.61	117

Table 18.144: TeSys™ Deca GV2 and GV3 Manual Starter and Protector Dimensions (cont'd)

GV2M with GK2AF01 and LC1K	GV2M with GV2AF01 and LC1K	GV2M with GV2AF01 and LC2K	Adapter Plate GK2AF01																																		
Dimensions (mm)																																					
<b>Mounting external operator GV2AP0*</b>	<b>Door cut-out</b>	<b>GV2M on panel with GV2AF02 adapter plate</b>	<b>7.5 mm height compensation plate GV1F03</b>																																		
<b>Sets of bus bars, GV2G445, GV2G454, GV2G472 with terminal block GV2G05</b>		<b>Sets of bus bars with terminal block GV1G09</b>	<b>Sets of bus bars GV2G245, GV2G254, GV2G272</b>																																		
			<table border="1"> <thead> <tr> <th></th> <th>I</th> <th>P</th> <th></th> <th>I</th> </tr> </thead> <tbody> <tr> <td>GV2G445</td> <td>0.16 x 1.8 in. (4 x 45 mm)</td> <td>7.0 in. (179 mm)</td> <td>1.8 in. (45 mm)</td> <td>GV2G245</td> <td>0.08 x 1.8 in. (2 x 45 mm)</td> <td>3.5 in. (89 mm)</td> </tr> <tr> <td>GV2G454</td> <td>0.16 x 2.1 in. (4 x 54 mm)</td> <td>8.1 in. (206 mm)</td> <td>2.1 in. (54 mm)</td> <td>GV2G254</td> <td>0.08 x 2.1 in. (2 x 54 mm)</td> <td>3.9 in. (98 mm)</td> </tr> <tr> <td>GV2G472</td> <td>0.16 x 1.8 in. (4 x 45 mm)</td> <td>10.2 in. (260 mm)</td> <td>2.8 in. (72 mm)</td> <td>GV2G272</td> <td>0.08 x 2.8 in. (2 x 72 mm)</td> <td>4.6 in. (116 mm)</td> </tr> <tr> <td></td> <td></td> <td></td> <td></td> <td>GV2G354</td> <td>0.12 x 2.1 in. (3 x 54 mm)</td> <td>6.0 in. (152 mm)</td> </tr> </tbody> </table>			I	P		I	GV2G445	0.16 x 1.8 in. (4 x 45 mm)	7.0 in. (179 mm)	1.8 in. (45 mm)	GV2G245	0.08 x 1.8 in. (2 x 45 mm)	3.5 in. (89 mm)	GV2G454	0.16 x 2.1 in. (4 x 54 mm)	8.1 in. (206 mm)	2.1 in. (54 mm)	GV2G254	0.08 x 2.1 in. (2 x 54 mm)	3.9 in. (98 mm)	GV2G472	0.16 x 1.8 in. (4 x 45 mm)	10.2 in. (260 mm)	2.8 in. (72 mm)	GV2G272	0.08 x 2.8 in. (2 x 72 mm)	4.6 in. (116 mm)					GV2G354	0.12 x 2.1 in. (3 x 54 mm)	6.0 in. (152 mm)
	I	P		I																																	
GV2G445	0.16 x 1.8 in. (4 x 45 mm)	7.0 in. (179 mm)	1.8 in. (45 mm)	GV2G245	0.08 x 1.8 in. (2 x 45 mm)	3.5 in. (89 mm)																															
GV2G454	0.16 x 2.1 in. (4 x 54 mm)	8.1 in. (206 mm)	2.1 in. (54 mm)	GV2G254	0.08 x 2.1 in. (2 x 54 mm)	3.9 in. (98 mm)																															
GV2G472	0.16 x 1.8 in. (4 x 45 mm)	10.2 in. (260 mm)	2.8 in. (72 mm)	GV2G272	0.08 x 2.8 in. (2 x 72 mm)	4.6 in. (116 mm)																															
				GV2G354	0.12 x 2.1 in. (3 x 54 mm)	6.0 in. (152 mm)																															
<b>GV3P</b>																																					
<b>Dimension</b>		<b>Mounting on rail AM1 DE200 or AM1 ED201</b>																																			
<p>X1 = Electrical clearance (ISC max) 40 mm for Ue &lt; 500 V; 50 mm for Ue &lt; 690 V</p>		<p>Blocks GV AN●●, GV AD●●, GV AM11 Block GV3 AU●● and GV3 AS●●</p>																																			
<b>Mounting on panel, using M4 screws</b>		<b>Mounting on pre-slotted mounting plate AM1PA</b>																																			
<p><b>NOTE:</b> Leave a space of 9 mm between 2 manual motor protectors: either an empty space or side-mounting add-on contact blocks. Horizontal mounting is possible: please consult your regional sales office.</p>																																					

TeSys Power Motor Circuit Breakers Dimensions

BV4 With Toggle

With EverLink Connector

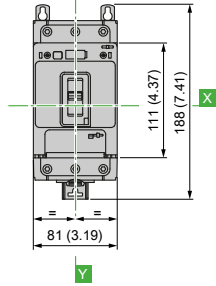
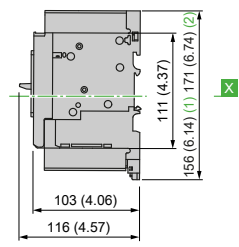

With Crimp Lug Connector

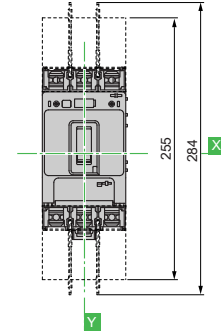
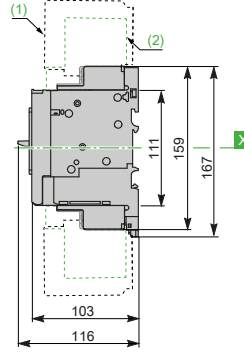

GV4PB

With EverLink Connector

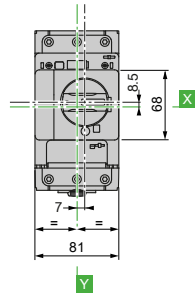
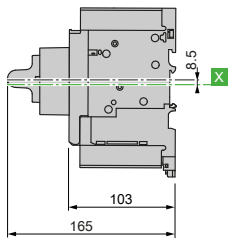

With Crimp Lug Connector

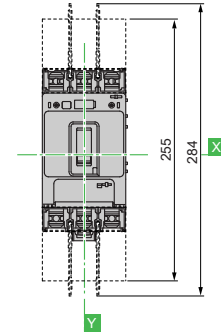
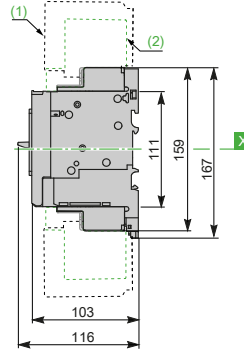

SDx Module

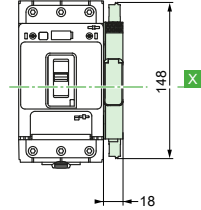

BV4 and GV4PB With Extended Rotary Handle

Front extended rotary handle GV4APN01, GV4APN02, GV4APN04

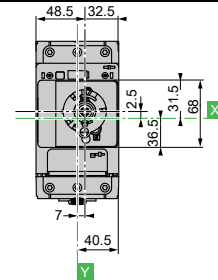
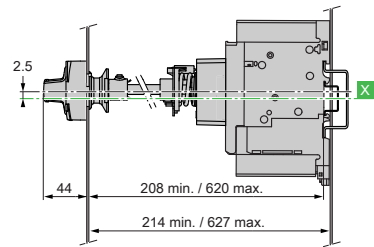

Front and side extended rotary handle, door/side panel cut-out

Front and side extended rotary handle

IP65, door panel cut-out

IP54, door/side panel cut-out

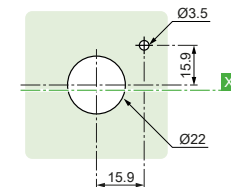
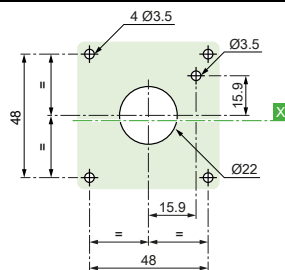
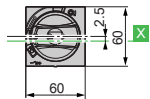
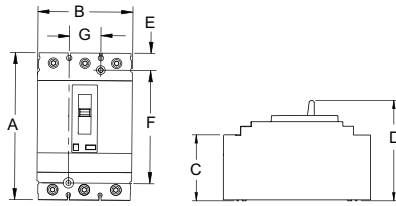



**Table 18.145: GV5PB and GV6PB Motor Protective Circuit Breakers**

Circuit Breaker Frame	Dimensions — Inches						
	A	B	C	D	E	F	G
GV5PB150	6.40	4.12	2.87	4.36	0.74	1.92	1.38
GV5PB250	7.52	4.12	2.87	5.00	1.30	4.92	1.38
GV6PB	13.38	5.51	3.75	6.61	2.22	7.87	1.77

GV5PB



GV6PB

