

Section 20

Electronic Sensors and Machine Cabling



Photoelectric Sensors



Proximity Sensors



Ultrasonic Sensors

Osisense Photoelectric Sensors	20-2
XUB Tubular Sensors	20-2
XUVR and XUVA Sensors	20-3
XUM Miniature, XUK and XUX Compact Sensors	20-4
Osisense Inductive Proximity Sensors	20-5
XS Plastic Rectangular	20-5
XS Plastic Rectangular Sensors	20-5
General Purpose, Plastic Case, Limit Switch Style, 5-Position Turret Head	20-5
DC Supply	20-5
Plug-in, AC or DC supply	20-5
XS General Purpose Tubular	20-6
3-Wire, 12–48 Vdc, Long Case Sensors and Accessories	20-6
3-wire 12–24 Vdc, Short Case Sensors	20-7
XS Basic and Basic Plus	20-8
Osisense Proximity Sensors	20-9
Inductive and Capacitive Proximity	20-9
2-Wire AC or DC, Long Case Sensors	20-9
Ultrasonic Sensors	20-10
XUV and XXV Sensors	20-10
VM Sensors	20-11
30 MM Ultrasonic Sensors	20-12
California Proposition 65	20-13

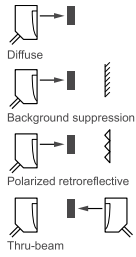

A single product that adapts to most environments.

For multi-mode models (XUB0, XUM0, XUK0, and XUX0) that are programmable to function as Diffuse, Diffuse/Background Suppression, Polarized Retroreflective, or Thru-Beam Receivers, consult the factory.

XUB Tubular Sensors



Table 20.1: XUB Tubular Sensors

XUB Tubular Sensors		XUB-A 18 mm plastic	XUB-B 18 mm metal
Usable sensing distance	Proximity diffuse (adjustable)	0.6 m (2.0 ft)	0.6 m (2.0 ft)
	Polarized retroreflective	2 m (6.6 ft)	2 m (6.6 ft)
	Retroreflective	4 m (13.1 ft)	4 m (13.1 ft)
	Thru-beam	15 m (49 ft)	15 m (49 ft)
Mounting (mm)		M 18 x 1	M 18 x 1
Enclosure: M (metal), P (plastic) / Dimensions (mm) Ø x L or W x H x D		P / M 18 x 46	P / M 18 x 46
Setup LEDs		—	—
Temperature range		-25 to +55 °C (-13 to +131 °F)	
Degree of protection (conforming to IEC 60529):		IP65, IP67 (XUK: IP65)	

Table 20.2: Sensors for DC Applications (Solid State Output: Transistor)

Connection		Precabled, PvR, 2 m [1]		M12 connector			
		Catalog No.	Catalog No.	Catalog No.	Catalog No.		
Receiver or Transmitter/Receiver, 3-wire PNP [2]	Proximity diffuse, adjustable	N.O.	XUB5APANL2	XUB5APANM12	XUB5BSPANL2	XUB5BSPANM12	
		N.C.	XUB5APBNL2	XUB5APBNM12	XUB5BPNL2	XUB5BPNM12	
	Polarized retroreflective	N.O.	XUB9APANL2	XUB9APANM12	XUB9BPNL2	XUB9BPNM12	
		N.C.	XUB9APBNL2	XUB9APBNM12	XUB9BPNL2	XUB9BPNM12	
	Retroreflective	N.O.	XUB1APANL2	XUB1APANM12	XUB1BPNL2	XUB1BPNM12	
		N.C.	XUB1APBNL2	XUB1APBNM12	XUB1BPNL2	XUB1BPNM12	
	Thru-beam	N.O.	XUB2APANL2R	XUB2APANM12R	XUB2BPNL2R	XUB2BPNM12R	
		N.C.	XUB2APBNL2R	XUB2APBNM12R	XUB2BPNL2R	XUB2BPNM12R	
Transmitter			XUB2AKSNL2T	XUB2AKSNM12T	XUB2AKSNL2T	XUB2AKSNM12T	
Supply voltage limits, min/max (V) including ripple		10–36		10–36		10–36	
Switching frequency (Hz)		500		500		500	
Common characteristics for DC versions		Switching capacity, max (mA): 100 / Overload and short-circuit protection / LED output state					

Table 20.3: Metal Body Sensors for Two-Wire AC [3] or DC Applications (Solid-State Output: Transistor)

Connection		Precabled, PvR, 2 m [1]		1/2"-20UNF Connector	
		Catalog No.	Catalog No.	Catalog No.	Catalog No.
System	Diffuse with adjustable background suppression	NO	XU8M18MA230	XU8M18MA230K	XU8M18MA230K
		NC	XU8M18MB230	XU8M18MB230K	XU8M18MB230K
	Diffuse	NO	XU5M18MA230	XU5M18MA230K	XU5M18MA230K
		NC	XU5M18MB230	XU5M18MB230K	XU5M18MB230K
	Polarized retroreflective [4]	NO	XU9M18MA230	XU9M18MA230K	XU9M18MA230K
		NC	XU9M18MB230	XU9M18MB230K	XU9M18MB230K
	Thru-beam[5]	NO	XU2M18MA230	XU2M18MA230K	XU2M18MA230K
		NC	XU2M18MB230	XU2M18MB230K	XU2M18MB230K
Rated supply voltage (Vac/Vdc)		24–240		24–240	
Switching frequency (Hz)		25		25	
Switching capacity (mA) [3]		10–200		10–200	

Table 20.4: Accessories

		mm	Catalog No.
Reflectors	24 x 21		XUZC24
	Ø 80		XUZC80
	50 x 50		XUZC50
Mounting brackets for XUB	Material		Catalog No.
	Die Cast Zinc		XUZA118
	Plastic		XUZA218
	90°		Straight
		Catalog No.	Catalog No.
Cables, 2 m, without LED [6] Suitable plug-in female connectors, including pre-wired versions	M8 (4-Pin)	XZCP1041L2	XZCP0941L2
	M12 (4-pin)	XZCP1241L2	XZCP1141L2
	1/2"-20UNF	XZCP1965L2	XZCP1865L2

[1] For a 5 m cable, change L2 to L5. For example, XUMB5APANL2 becomes XUMB5APANL5.
 [2] For version with NPN output, change "P" to "N". For example: XUB1APANL2 would become XUB1ANANL2.
 [3] These sensors do not incorporate overload or short-circuit protection. A 0.4 A fast-acting fuse must be connected in series with the load.
 [4] A 50 x 50 mm reflector XUZC50 is included with a polarized retroreflective system.
 [5] Includes a thru-beam transmitter and receiver.
 [6] For 5 or 10 meter lengths, replace 2 in the cable catalog number with 5 or 10.

XUVR / XUVA

Table 20.5: XUVR / XUVA Optical fork without adjustment

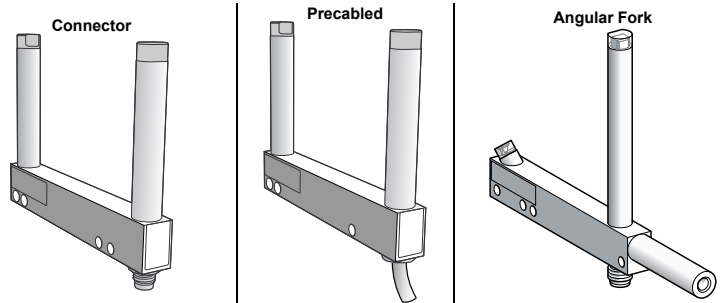

Sensing Characteristics		Thru-beam	
Sensing range, mm (in.)		2-180 (0.08 -7.09)	
Sensing frequency		4000 Hz	
Minimum size of object detected, mm (in.)	Passageway 2-120 mm	0.8 (0.03)	1.2 (0.05)
	Passageway u 150 mm	1 (0.04)	1.5 (0.06)
Fork type		XUVR*	XUVA*
Power Requirements			
Supply voltage		12-24 Vdc	
Max. load		100 mA with overload and short-circuit protection	
Environmental			
Operating temperature range		-10 to +60 °C (+14 to +140 °F)	
Environmental protection ratings		IP65 and IP67	
Construction			
Materials Case		Painted aluminum and polyamide	
Catalog numbers of forks type XUVR*			

Connection—Precabled, length 2 m. Depth (B): 40 mm (1.18 in.)			
Passageway (A)	Function	Output	Catalog Number
30 mm (1.18 in.)	NO	PNP	XUVR0303PANL2

Connection—M8, 3-Pin. Depth (B): 60 mm (2.36 in.)			
Passageway (A)	Function	Output	Catalog Number
50 mm (1.97 in.)	NO	PNP	XUVR0605PANM8
		NPN	XUVR0605NANM8
	NC	PNP	XUVR0605PBNM8
		NPN	XUVR0605NBNM8
80 mm (3.15 in.)	NO	PNP	XUVR0608PANM8
		NPN	XUVR0608NANM8
	NC	PNP	XUVR0608PBNM8
		NPN	XUVR0608NBNM8

Connection—M8, 3-Pin. Depth (B): 120 mm (4.72 in.)			
Passageway (A)	Function	Output	Catalog Number
120 mm (4.72 in.)	NO	PNP	XUVR1212PANM8
		NPN	XUVR1212NANM8
	NC	PNP	XUVR1212PBNM8
		NPN	XUVR1212NBNM8
180 mm (7.09 in.)	NO	PNP	XUVR1218PANM8
		NPN	XUVR1218NANM8
	NC	PNP	XUVR1218PBNM8
		NPN	XUVR1218NBNM8

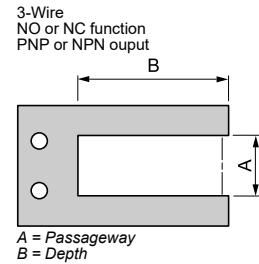

Catalog numbers of forks type XUVA*			
Connection—M8 connector, 3-Pin			

Passageway (A)	Function	Output	Catalog Number
50 mm (1.97 in.)	NO	PNP	XUVA0505PANM8
80 mm (3.15 in.)	NO	PNP	XUVA0808PANM8
120 mm (4.72 in.)	NO	PNP	XUVA1212PANM8
150 mm (5.91 in.)	NO	PNP	XUVA1515PANM8

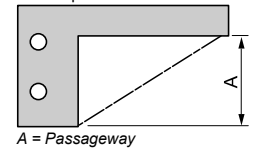

XUM Miniature, XUK and XUX Compact Sensors

Table 20.6: XUM Miniature, XUK and XUX Compact

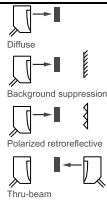

A single product that adapts to most environments.
For multi-mode models (XUB0, XUM0, XUK0, and XUX0) that are programmable to function as Diffuse, Diffuse/Background Suppression, Polarized Retroreflective, or Thru-Beam Receivers, consult the factory.





Sensors		XUM Miniature Design	XUK Compact Design 50 x 50	XUX Compact Design			
Usable sensing distance	Proximity diffuse (adjustable sensitivity)	1 m (3.28 ft)	1 m (3.2 ft) [7]	2.1 m (6.8 ft)			
	Polarized retroreflective	5 m (16.40 ft)[8]	5 m (16.4 ft) [7]	11 m (36 ft)			
	Retroreflective	—	7 m (23.0 ft) [7]	14 m (46 ft)			
	Thru-beam	15 m (49.21 ft)	30 m (98 ft) [7]	40 m (131.2 ft)			
Mounting (mm)		direct: mounting centers 25.5, M3 screws	direct: mounting centers 40 x 40, M4 screws	direct: mounting centers 30/36 to 40/50/74, M5 screws			
Enclosure: M (metal) P (plastic) / Dimensions (mm) Ø x L or W x H x D		P / 10.8 x 34 x 20	P / 18 x 50 x 50	P / 30 x 92 x 71			
Setup LEDs		⊗	⊗	⊗			
Common characteristics		LED output state indicator and power on LED (⊗): yes					
Sensors for DC Applications (Solid State Output: Transistor)		Catalog No.					
Connection		Precabled, PVC, 2 m	M8 connector	Precabled, PVC, 2 m	M12 connector	Screw terminals, ISO 16 cable gland	M12 connector
Transmitter		XUM2AKCNL2T	XUM2AKCNM8T	XUK2AKSNL2T	XUK2AKSNM12T	XUX0AKSAT16T	XUX0AKSAM12T
Proximity diffuse, adjustable	N.O.	—	—	XUK5APANL2	XUK5APANM12	XUX5APANT16	XUX5APANM12
	N.C.	—	—	XUK5APBNL2	XUK5APBNM12	XUX5APBNT16	XUX5APBNM12
	N.O./N.C. convertible	XUM5APCNL2	XUM5APCNM8	—	—	—	—
Receiver or Transmitter/Receiver, 3-wire PNP [9]	Polarized retroreflective	—	—	XUK9APANL2	XUK9APANM12	XUX9APANT16	XUX9APANM12
	N.C.	—	—	XUK9APBNL2	XUK9APBNM12	XUX9APBNT16	XUX9APBNM12
	N.O./N.C. convertible	XUM9APCNL2	XUM9APCNM8	—	—	—	—
Retroreflective	N.O.	—	—	XUK1APANL2	XUK1APANM12	XUX1APANT16	XUX1APANM12
	N.C.	—	—	XUK1APBNL2	XUK1APBNM12	XUX1APBNT16	XUX1APBNM12
	N.O./N.C. convertible	—	—	XUK2APANL2R	XUK2APANM12R	XUX2APANT16R	XUX2APANM12R
Thru-beam	N.O.	—	—	XUK2APBNL2R	XUK2APBNM12R	XUX2APBNT16R	XUX2APBNM12R
	N.C.	—	—	—	—	—	—
	N.O./N.C. convertible	XUM2APCNL2R	XUM2APCNM8R	—	—	—	—
Supply voltage limits, min/max (V) including ripple		10–30	10–30	10–30	10–30	10–36	10–36
Switching frequency (Hz)		1000	1000	250	250	250	250
Common characteristics for DC versions		indicator (⊗): yes / power on LED (⊗): yes					
Multi-current/multi-voltage sensors for AC/DC applications, 20–264 Vac/Vdc, including ripple (relay output, 1 C/O, 3 A)							
Connection		—	—	Precabled, 2 m	—	Screw terminals, ISO 16 cable gland	—
Transmitter		—	—	XUK2ARCNL2T	—	XUX0ARCTT16T	—
Receiver or Transmitter/Receiver	Diffuse	N.O. + N.C.	—	XUK5ARCNL2	—	XUX5ARCNT16	—
	Polarized retroreflective	N.O. + N.C.	—	XUK9ARCNL2	—	XUX9ARCNT16	—
	Retroreflective	N.O. + N.C.	—	XUK1ARCNL2	—	XUX1ARCNT16	—
Thru-beam		N.O. + N.C.	—	XUK2ARCNL2R	—	XUX2ARCNT16R	—
Switching frequency (Hz)		—	—	20	—	20	—
LED output state indicator (⊗) / power on LED (⊗)		—	—	⊗ / ⊗	—	⊗ / ⊗	—

NOTE: M8 is not Snap-C compatible.
See page 20-2 for suitable plug-in cables with female connectors.

[7] Excess gain of 2.
[8] With XUZC50 reflector.
[9] For version with NPN output, change "P" to "N". For example, XUM5APCNL2 would become XUM5ANCNL2.

XS Plastic Rectangular Sensors

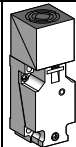
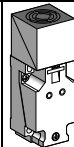
Sensor	Flush mountable in metal	Non-flush mountable in metal
<p>A single product that automatically adapts to most environments. Accurate position detection via teach mode.</p> <p>non-flush mountable in metal</p>  <p>flush mountable in metal</p> 		

General Purpose, Plastic Case, Limit Switch Style, 5-Position Turret Head

Table 20.7: General Specifications

Product certifications	UL, CSA, e
Degree of protection conforming to IEC 60529	IP67
Operating temperature	-25 to +70 °C (-13 to +158 °F)

DC Supply

Table 20.8: Catalog Numbers

Nominal sensing distance Sn, mm (in.)		Increased range 20 (0.79)	15 (0.59)	Increased range 40 (1.57)
4-wire DC (complementary outputs)	PNP, NO + NC	XS8C4A1PCN12	—	XS8C4A4PCN12
	NPN, NO + NC	XS8C4A1NCN12	—	XS8C4A4NCN12
	NO	XS8C4A1DPN12	XS7C4A1DPN12	—
2-wire DC (non-polarized)	NO or NC programmable	—	XS7C4A1DPN12	XS8C4A4DPN12
		0.220 (0.49)	0.220 (0.49)	0.220 (0.49)

Table 20.9: Supplemental Specifications

Connection [1]	Screw terminals, clamping capacity: 2 or 4 x 1.5 mm ² (16 AWG)					
Operating zone, mm (in.)	0–12 (0–0.47)	0–16 (0–0.63)	0–12 (0–0.47)	0–16 (0–0.63)	0–32 (0–1.26)	0–16 (0–0.63)
Repeat accuracy	≤ 3% of effective sensing distance (Sr)					
Differential travel	3–20% of effective sensing distance (Sr)					
Status indication	Output	Yellow LED	Yellow LED	Yellow LED	Yellow LED	
	Supply on	Green LED	—	Green LED	—	
Rated supply voltage	12–48 Vdc with protection against reverse polarity					
Voltage limits (including ripple)	10–58 Vdc					
Current consumption, no-load	≤ 10 mA		—		≤ 10 mA	
Switching capacity with overload + short-circuit protection	0–200 mA		1.5–100 mA		0–200 mA	
Residual current, open state	—		≤ 0.5 mA		—	
Voltage drop, closed state	≤ 2 V		≤ 4 V		≤ 2 V	
Maximum switching frequency	1000 Hz		1500 Hz		1000 Hz	500 Hz
	First-up	≤ 5 ms	≤ 5 ms	≤ 5 ms	≤ 5 ms	≤ 5 ms
Delays	Response	≤ 0.3 ms	≤ 2 ms	≤ 0.3 ms	< 1 ms	≤ 2 ms
	Recovery	≤ 0.7 ms	≤ 5 ms	≤ 0.7 ms	< 1 ms	≤ 7 ms

Plug-in, AC or DC supply

Table 20.10: Catalog Numbers

Nominal sensing distance Sn, mm (in.)		AC	AC/DC	AC/DC
		15 (0.59)		40 (1.57)
2-wire AC	NO or NC programmable	XS7C4A1DPN12	XS8C4A1DPN12	XS8C4A4DPN12
2-wire AC or DC universal model	NO or NC programmable	XS7C4A1MPN12	XS8C4A1MPN12	XS8C4A4MPN12
Weight, kg (lb)		0.220 (0.49)	0.220 (0.49)	0.220 (0.49)

Table 20.11: Supplemental Specifications

Connection [2]	Screw terminals, clamping capacity 2 x 1.5 mm ² (16 AWG)		
Operating zone, mm (in.)	0–12 (0–0.47)		0–16 (0–0.63)
Repeat accuracy	≤ 3% of effective sensing distance (Sr)		
Differential travel	3–20% of effective sensing distance (Sr)		
Output state indication	Yellow LED		
Rated supply voltage (with reverse polarity protection)	24–240 Vac, 50/60 Hz	24–240 Vac, 50/60 Hz / 24–210 Vdc	24–240 Vac, 50/60 Hz / 24–210 Vdc
Voltage limits (including ripple)	20–264 Vac	20–264 Vac or Vdc	20–264 Vac or Vdc
Current consumption, no-load	—		
Switching capacity [3]	5–300 mA (2 A inrush) [3]	5–300 mA AC or 5–200 mA DC [3]	5–300 mA AC or 5–200 mA DC [3]
Residual current, open state	≤ 1.5 mA	0.8 mA on 24 V 1.5 mA on 120 V	0.8 mA on 24 V 1.5 mA on 120 V
Voltage drop, closed state	≤ 5.5 V		
Maximum switching frequency	25 Hz	AC: 25 Hz; DC: 50 Hz	AC: 25 Hz; DC: 50 Hz
	First-up	≤ 120 ms	
Delays	Response	≤ 30 ms	
	Recovery	≤ 20 ms	

[1] 1/2" NPT conduit Entry. For PC13, change N12 to G13. For M20, change N12 to P20.

[2] 1/2" NPT conduit Entry. For PC13, change N12 to G13. For M20, change N12 to P20.

[3] These sensors do not incorporate overload or short-circuit protection. A 0.4 mA fast-acting fuse (XUZE04) must be connected in series with the load.

3-Wire, 12–48 Vdc, Long Case Sensors and Accessories

Table 20.12: General Purpose, Long Case, Increased Range, Flush Mountable, 3-Wire DC, Solid-State Output

Sensors, 3-wire 12–48 Vdc, long case model								
Sensing Distance Sn, mm (in.)	Function	Output	Connection	Weight		Catalog No.		
				kg	(lb)			
Ø 8, threaded M8 x 1	2.5 (0.10)	NO	PNP	Precabled (2 m) [4]	0.035	(0.08)	XS608B1PAL2	
				M12 connector	0.015	(0.03)	XS608B1PAM12	
			NPN	Precabled (2 m) [4]	0.035	(0.08)	XS608B1NAL2	
		M12 connector		0.015	(0.03)	XS608B1NAM12		
		NC	PNP	Precabled (2 m) [4]	0.035	(0.08)	XS608B1PBL2	
				M12 connector	0.015	(0.03)	XS608B1PBM12	
	NPN		Precabled (2 m) [4]	0.035	(0.08)	XS608B1NBL2		
	M12 connector	0.015	(0.03)	XS608B1NBM12				
	Ø 12, threaded M12 x 1	4 (0.16)	NO	PNP	Precabled (2 m) [4]	0.075	(0.17)	XS612B1PAL2
					M12 connector	0.020	(0.04)	XS612B1PAM12
				NPN	Precabled (2 m) [4]	0.075	(0.17)	XS612B1NAL2
			M12 connector		0.020	(0.04)	XS612B1NAM12	
NC			PNP	Precabled (2 m) [4]	0.075	(0.17)	XS612B1PBL2	
				M12 connector	0.020	(0.04)	XS612B1PBM12	
		NPN	Precabled (2 m) [4]	0.075	(0.17)	XS612B1NBL2		
M12 connector		0.020	(0.04)	XS612B1NBM12				
Ø 18, threaded M18 x 1		8 (0.31)	NO	PNP	Precabled (2 m) [4]	0.100	(0.22)	XS618B1PAL2
					M12 connector	0.040	(0.09)	XS618B1PAM12
					Remote screw term. connector	0.100	(0.22)	XS618B1PAL01B [5]
				NPN	Remote DIN 43650 connector	0.100	(0.22)	XS618B1PAL01C
	Remote M18 connector				0.100	(0.22)	XS618B1PAL01G	
	Precabled (2 m) [4]				0.100	(0.22)	XS618B1NAL2	
	NC		PNP	M12 connector	0.040	(0.09)	XS618B1NAM12	
				Remote screw term. connector	0.100	(0.22)	XS618B1NAL01B [5]	
				Remote DIN 43650 connector	0.100	(0.22)	XS618B1NAL01C	
			NPN	Precabled (2 m) [4]	0.100	(0.22)	XS618B1NBL2	
				M12 connector	0.040	(0.09)	XS618B1NBM12	
				Remote screw term. connector	0.100	(0.22)	XS618B1NBL01B [5]	
	Ø 30, threaded M30 x 1.5	15 (0.59)	NO	PNP	Precabled (2 m) [4]	0.205	(0.45)	XS630B1PAL2
					M12 connector	0.145	(0.32)	XS630B1PAM12
					Remote screw term. connector	0.205	(0.45)	XS630B1PAL01B [5]
				NPN	Remote DIN 43650 connector	0.205	(0.45)	XS630B1PAL01C
					Remote M18 connector	0.205	(0.45)	XS630B1PAL01G
					Precabled (2 m) [4]	0.205	(0.45)	XS630B1NAL2
			NC	PNP	M12 connector	0.145	(0.32)	XS630B1NAM12
					Remote screw term. connector	0.205	(0.45)	XS630B1NAL01B [5]
					Remote DIN 43650 connector	0.205	(0.45)	XS630B1NAL01C
				NPN	Precabled (2 m) [4]	0.205	(0.45)	XS630B1NBL2
					M12 connector	0.145	(0.32)	XS630B1PBM12
					Remote screw term. connector	0.205	(0.45)	XS630B1PBL01B [5]
Ø 30, threaded M30 x 1.5	15 (0.59)	PNP	Remote DIN 43650 connector	0.205	(0.45)	XS630B1PBL01C		
			Remote M18 connector	0.205	(0.45)	XS630B1PBL01G		
			Precabled (2 m) [4]	0.205	(0.45)	XS630B1NBL2		
		NPN	M12 connector	0.145	(0.32)	XS630B1NBM12		
			Remote screw term. connector	0.205	(0.45)	XS630B1NBL01B [5]		
			Remote DIN 43650 connector	0.205	(0.45)	XS630B1NBL01C		

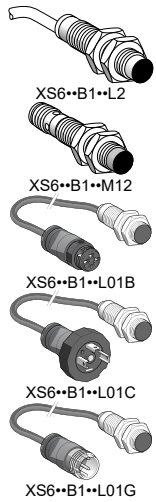





Table 20.13: Accessories

Description	For use with sensors	Weight		Catalog No.
		kg	(lb)	
90° metal mounting brackets	Ø 8	0.006	(0.01)	9006PA08
	Ø 12	0.006	(0.01)	9006PA12
	Ø 18	0.010	(0.02)	9006PA18
	Ø 30	0.020	(0.02)	9006PA30

[4] For a 5 m cable replace L2 with L5; for a 10 m cable replace L2 with L10. For example, XS608B1PAL2 becomes XS608B1PAL5 with a 5 m cable.

[5] Protective cable gland included with remote screw terminal connector.

Description	Cables		Mounting Bracket	
	90°	Straight	with Indexing Pin for Tubular Sensors	
Plug-in female connectors, including pre-wired versions (2 m, without LED)				
	Catalog No.	Catalog No.		Catalog No.
M8	XZCP0666L2	XZCP0566L2	M12	XSZB112
M12	XZCP1241L2	XZCP1141L2	M18	XSZB118
U20	XZCP1965L2	XZCP1865L2	M30	XSZB130

3-wire 12–24 Vdc, Short Case Sensors

Table 20.14: Sensors, 3-wire 12–24 Vdc, Short Case Model

Sensing Distance Sn, mm (in.)	Function	Output	Connection	Weight		Catalog Number
				kg	(lb)	
Ø 6.5, plain						
1.5 (0.06)	NO	PNP	Precabled (2 m) [6]	0.035	(0.08)	XS506B1PAL2
			M8 connector	0.025	(0.06)	XS506B1PAM8
			M12 connector	0.025	(0.06)	XS506B1PAM12
		NPN	Precabled (2 m) [7]	0.035	(0.08)	XS506B1NAL2
			M8 connector	0.025	(0.06)	XS506B1NAM8
			M12 connector	0.025	(0.06)	XS506B1NAM12
	NC	PNP	Precabled (2 m) [7]	0.035	(0.08)	XS506B1PBL2
			M8 connector	0.025	(0.06)	XS506B1PBM8
			M12 connector	0.025	(0.06)	XS506B1PBM12
		NPN	Precabled (2 m) [7]	0.035	(0.08)	XS506B1NBL2
			M8 connector	0.025	(0.06)	XS506B1NBM8
			M12 connector	0.025	(0.06)	XS506B1NBM12
Ø 8, threaded M8 x 1						
1.5 (0.06)	NO	PNP	Precabled (2 m) [7]	0.035	(0.08)	XS508B1PAL2
			M8 connector	0.025	(0.06)	XS508B1PAM8
			M12 connector	0.025	(0.06)	XS508B1PAM12
		NPN	Precabled (2 m) [7]	0.035	(0.08)	XS508B1NAL2
			M8 connector	0.025	(0.06)	XS508B1NAM8
			M12 connector	0.025	(0.06)	XS508B1NAM12
	NC	PNP	Precabled (2 m) [7]	0.035	(0.08)	XS508B1PBL2
			M8 connector	0.025	(0.06)	XS508B1PBM8
			M12 connector	0.025	(0.06)	XS508B1PBM12
		NPN	Precabled (2 m) [7]	0.035	(0.08)	XS508B1NBL2
			M8 connector	0.025	(0.06)	XS508B1NBM8
			M12 connector	0.025	(0.06)	XS508B1NBM12
Ø 12, threaded M12 x 1						
2 (0.08)	NO	PNP	Precabled (2 m) [7]	0.075	(0.17)	XS512B1PAL2
			M12 connector	0.035	(0.08)	XS512B1PAM12
			Precabled (2 m) [7]	0.075	(0.17)	XS512B1NAL2
		NPN	M12 connector	0.035	(0.08)	XS512B1NAM12
			Precabled (2 m) [7]	0.075	(0.17)	XS512B1PBL2
			M12 connector	0.035	(0.08)	XS512B1PBM12
	NC	PNP	Precabled (2 m) [7]	0.075	(0.17)	XS512B1NBL2
			M12 connector	0.035	(0.08)	XS512B1NBM12
			Precabled (2 m) [7]	0.075	(0.17)	XS512B1PBL2
		NPN	M12 connector	0.035	(0.08)	XS512B1PBM12
			Precabled (2 m) [7]	0.075	(0.17)	XS512B1NBL2
			M12 connector	0.035	(0.08)	XS512B1NBM12
Ø 18, threaded M18 x 1						
5 (0.20)	NO	PNP	Precabled (2 m) [7]	0.120	(0.26)	XS518B1PAL2
			M12 connector	0.060	(0.13)	XS518B1PAM12
			Precabled (2 m) [7]	0.120	(0.26)	XS518B1NAL2
		NPN	M12 connector	0.060	(0.13)	XS518B1NAM12
			Precabled (2 m) [7]	0.120	(0.26)	XS518B1PBL2
			M12 connector	0.060	(0.13)	XS518B1PBM12
	NC	PNP	Precabled (2 m) [7]	0.120	(0.26)	XS518B1NBL2
			M12 connector	0.060	(0.13)	XS518B1NBM12
			Precabled (2 m) [7]	0.120	(0.26)	XS518B1PBL2
		NPN	M12 connector	0.060	(0.13)	XS518B1PBM12
			Precabled (2 m) [7]	0.120	(0.26)	XS518B1NBL2
			M12 connector	0.060	(0.13)	XS518B1NBM12
Ø 30, threaded M30 x 1.5						
10 (0.39)	NO	PNP	Precabled (2 m) [7]	0.205	(0.45)	XS530B1PAL2
			M12 connector	0.145	(0.32)	XS530B1PAM12
			Precabled (2 m) [7]	0.205	(0.45)	XS530B1NAL2
		NPN	M12 connector	0.145	(0.32)	XS530B1NAM12
			Precabled (2 m) [7]	0.205	(0.45)	XS530B1PBL2
			M12 connector	0.145	(0.32)	XS530B1PBM12
	NC	PNP	Precabled (2 m) [7]	0.205	(0.45)	XS530B1NBL2
			M12 connector	0.145	(0.32)	XS530B1NBM12
			Precabled (2 m) [7]	0.205	(0.45)	XS530B1PBL2
		NPN	M12 connector	0.145	(0.32)	XS530B1PBM12
			Precabled (2 m) [7]	0.205	(0.45)	XS530B1NBL2
			M12 connector	0.145	(0.32)	XS530B1NBM12

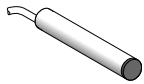

XS506B1-L2



XS508B1-L2



XS512B1-M12



XS518B1-M12



XS518B1-L2



XS530B1-L2

Table 20.15: Accessories

Description	For use with sensors	Weight		Catalog Number
		kg	(lb)	
Mounting brackets	Ø 6.5 (plain)	0.005	(0.01)	XSZB165
	Ø 8	0.006	(0.01)	XSZB108
	Ø 12	0.006	(0.01)	XSZB112
	Ø 18	0.010	(0.02)	XSZB118
	Ø 30	0.020	(0.02)	XSZB130





[6] For a 5 m cable replace L2 with L5; for a 10 m cable replace L2 with L10. Example: XS106B3PAL2 becomes XS106B3PAL5 with a 5 m cable.





[7] For a 5 m cable replace L2 with L5; for a 10 m cable replace L2 with L10.

Example: XS508B1PAL2 becomes XS508B1PAL5 with a 5 m cable.

XS...B3 Basic Plus Sensors

Table 20.16: Basic Plus, XS...B3



Sensing Characteristics	Ø 6.5 Plain Flush Mountable	Ø M8 Flush Mountable	Ø M12 Flush Mountable	Ø M18 Flush Mountable	Ø M30 Flush Mountable
Basic, Tubular, Flush-Mountable, Increased Range, 3-Wire DC, Solid-State Output					
Sensing range	2 mm (0–0.08 in.)	2 mm (0–0.08 in.)	4.0 mm (0–0.15 in.)	8.0 mm (0.31 in.)	15.0 mm (0.59 in.)
Switching frequency	2500 Hz	2500 Hz	2500 Hz	1000 Hz	500 Hz
Shock resistance	50 gn, duration 11 ms	50 gn, duration 11 ms	50 gn, duration 11 ms	50 gn, duration 11 ms	50 gn, duration 11 ms
Vibration resistance (10–55 Hz)	25 gn, amplitude ± 2 mm	25 gn, amplitude ± 2 mm	25 gn, amplitude ± 2 mm	25 gn, amplitude ± 2 mm	25 gn, amplitude ± 2 mm
Power Requirements					
Supply voltage	12–24 (10–36 max) Vdc with protection against reverse polarity, overload, and short circuit				
Switching capacity	50 mA		50 mA		100 mA
Specifications					
	XS1ppB3ppM8, XS1ppB3ppM12, XS1ppB3ppL2				
Operating zone	Ø 6.5 and Ø 8	0–2.0 mm (0–0.07 in.)			
	Ø 12	0–4.0 mm (0–0.15 in.)			
	Ø 18	0–8.0 mm (0–0.31 in.)			
	Ø 30	0–15 mm (0–0.59 in.)			
Degree of protection	Conforming to IEC 60529		IP65 and IP67		
Operating temperature	–25 to +70 °C (–13 to +158 °F)				
Materials	Case	Nickel-plated brass			
	Cable (XS1ppB3ppLp only)	PvR 3 x 0.34 mm ² (22 AWG), except Ø 6.5 and Ø 8: 3 x 0.11 mm ² (27 AWG)			
Vibration resistance	Conforming to IEC 60068-2-6		25 gn, amplitude ± 2 mm (10 to 55 Hz)		
Shock resistance	Conforming to IEC 60068-2-27		50 gn, duration 11 ms		
Rated supply voltage	12–24 Vdc with protection against reverse polarity				
Switching capacity	y 200 mA with overload and short-circuit protection				
Maximum switching frequency	Ø 6.5, Ø 8, and Ø 12	2500 Hz			
	Ø 18	1000 Hz			
	Ø 30	500 Hz			

Sensing Distance Sn, mm (in.)	Function	Output	Connection	Sold in lots of	Weight		Catalog Number
					kg	(lb)	
Ø 8, threaded M8 x 1							
Three-wire 12–24 Vdc, flush mountable							
 XS108B3-M8 2 (0.07)	NO	PNP	Precabled (2 m) [8]	1	0.070	(0.15)	XS108B3PAL2
			M8 connector	1	0.030	(0.06)	XS108B3PAM8
			M12 connector	1	0.060	(0.13)	XS108B3PAM12
		NPN	Precabled (2 m) [8]	1	0.070	(0.15)	XS108B3NAL2
			M8 connector	1	0.030	(0.06)	XS108B3NAM8
			M12 connector	1	0.060	(0.13)	XS108B3NAM12
	NC	PNP	Precabled (2 m) [8]	1	0.070	(0.15)	XS108B3PBL2
			M8 connector	1	0.030	(0.06)	XS108B3PBM8
			M12 connector	1	0.060	(0.13)	XS108B3PBM12
		NPN	Precabled (2 m) [8]	1	0.070	(0.15)	XS108B3NBL2
			M8 connector	1	0.030	(0.06)	XS108B3NBM8
			M12 connector	1	0.060	(0.13)	XS108B3NBM12
Ø 12, threaded M12 x 1							
Three-wire 12–24 Vdc, flush mountable							
 XS112B3-L2 4 (0.15)	NO	PNP	Precabled (2 m) [8]	1	0.090	(0.19)	XS112B3PAL2
			M12 connector	1	0.030	(0.06)	XS112B3PAM12
			Precabled (2 m) [8]	1	0.090	(0.19)	XS112B3NAL2
		NPN	M12 connector	1	0.030	(0.06)	XS112B3NAM12
			Precabled (2 m) [8]	1	0.090	(0.19)	XS112B3PBL2
			M12 connector	1	0.030	(0.06)	XS112B3PBM12
	NC	PNP	Precabled (2 m) [8]	1	0.090	(0.19)	XS112B3NBL2
			M12 connector	1	0.030	(0.06)	XS112B3NBM12
			Precabled (2 m) [8]	1	0.090	(0.19)	XS112B3PBL2
		NPN	M12 connector	1	0.030	(0.06)	XS112B3PBM12
			Precabled (2 m) [8]	1	0.090	(0.19)	XS112B3NBL2
			M12 connector	1	0.030	(0.06)	XS112B3NBM12
Ø 18, threaded M18 x 1							
Three-wire 12–24 Vdc, flush mountable							
 XS118B3-M12 8 (0.31)	NO	PNP	Precabled (2 m) [8]	1	0.110	(0.24)	XS118B3PAL2
			M12 connector	1	0.060	(0.13)	XS118B3PAM12
			Precabled (2 m) [8]	1	0.110	(0.24)	XS118B3NAL2
		NPN	M12 connector	1	0.060	(0.13)	XS118B3NAM12
			Precabled (2 m) [8]	1	0.110	(0.24)	XS118B3PBL2
			M12 connector	1	0.060	(0.13)	XS118B3PBM12
	NC	PNP	Precabled (2 m) [8]	1	0.110	(0.24)	XS118B3NBL2
			M12 connector	1	0.060	(0.13)	XS118B3NBM12
			Precabled (2 m) [8]	1	0.110	(0.24)	XS118B3PBL2
		NPN	M12 connector	1	0.060	(0.13)	XS118B3PBM12
			Precabled (2 m) [8]	1	0.110	(0.24)	XS118B3NBL2
			M12 connector	1	0.060	(0.13)	XS118B3NBM12
Ø 30, threaded M30 x 1.5							
Three-wire 12–24 Vdc, flush mountable							
 XS130B3-L2 15 (0.59)	NO	PNP	Precabled (2 m) [8]	1	0.180	(0.39)	XS130B3PAL2
			M12 connector	1	0.130	(0.28)	XS130B3PAM12
			Precabled (2 m) [8]	1	0.180	(0.39)	XS130B3NAL2
		NPN	M12 connector	1	0.130	(0.28)	XS130B3NAM12
			Precabled (2 m) [8]	1	0.180	(0.39)	XS130B3PBL2
			M12 connector	1	0.130	(0.28)	XS130B3PBM12
	NC	PNP	Precabled (2 m) [8]	1	0.180	(0.39)	XS130B3NBL2
			M12 connector	1	0.130	(0.28)	XS130B3NBM12
			Precabled (2 m) [8]	1	0.180	(0.39)	XS130B3PBL2
		NPN	M12 connector	1	0.130	(0.28)	XS130B3PBM12
			Precabled (2 m) [8]	1	0.180	(0.39)	XS130B3NBL2
			M12 connector	1	0.130	(0.28)	XS130B3NBM12

[8] For a 5 m cable replace L2 with L5; for a 10 m cable replace L2 with L10. Example: XS106B3PAL2 becomes XS106B3PAL5 with a 5 m cable.

2-Wire AC or DC, Long Case Sensors

Table 20.17: Accessories, Basic Plus, XS••B3

Mounting Bracket		Mounting Bracket w/ Indexing Pin for Cylindrical Sensors			
	Sensor Body	Catalog No.		Diameter	Catalog No.
	M8	9006PA08		M6	XSZB165
	M12	9006PA12		M8	XSZB108
	M18	9006PA18		M12	XSZB112
	M30	9006PA30		M18	XSZB118
				M30	XSZB130

Cables | See M8 and M12 connector cables on page 3—Wire, 12 — 48 Vdc, Long Case Sensors and Accessories, page 20-6.

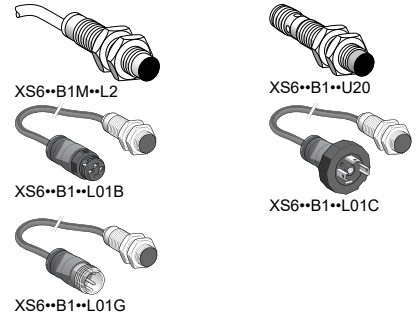

Table 20.18: General Purpose, Long Case, Tubular, Increased Range, Flush Mountable, 2-Wire AC or DC

Sensors, 2-wire 24–240 V AC or DC, long case model					
Sensing Distance Sn, mm (in.)	Function	Connection	Catalog Number	Weight	
				kg	lb
Ø 12, threaded M12 x 1					
4 (0.16)	NO	Precabled (2 m) [1]	XS612B1MAL2	0.075	0.17
		1/2"-20UNF connector	XS612B1MAU20	0.025	0.06
	NC	Precabled (2 m) [1]	XS612B1MBL2	0.075	0.17
		1/2"-20UNF connector	XS612B1MBU20	0.025	0.06
Ø 18, threaded M18 x 1					
8 (0.31)	NO	Precabled (2 m) [1]	XS618B1MAL2	0.100	0.22
		1/2"-20UNF connector	XS618B1MAU20	0.060	0.13
		Remote screw terminal connector	XS618B1MAL01B [2]	0.100	0.22
		Remote DIN 43650A connector	XS618B1MAL01C	0.100	0.22
	NC	Remote M18 connector	XS618B1MAL01G	0.100	0.22
		Precabled (2 m) [1]	XS618B1MBL2	0.100	0.22
		1/2"-20UNF connector	XS618B1MBU20	0.060	0.13
		Remote screw terminal connector	XS618B1MBL01B [2]	0.100	0.22
		Remote DIN 43650A connector	XS618B1MBL01C	0.100	0.22
		Remote M18 connector	XS618B1MBL01G	0.100	0.22
Ø 30, threaded M30 x 1.5					
15 (0.59)	NO	Precabled (2 m) [3]	XS630B1MAL2	0.205	0.45
		1/2"-20UNF connector	XS630B1MAU20	0.145	0.32
		Remote screw terminal connector	XS630B1MAL01B [2]	0.205	0.45
		Remote DIN 43650A connector	XS630B1MAL01C	0.205	0.45
	NC	Remote M18 connector	XS630B1MAL01G	0.205	0.45
		Precabled (2 m) [3]	XS630B1MBL2	0.205	0.45
		1/2"-20UNF connector	XS630B1MBU20	0.145	0.32
		Remote screw terminal connector	XS6 30B1MBL01B [2]	0.205	0.45
		Remote DIN 43650A connector	XS6 30B1MBL01C	0.205	0.45
		Remote M18 connector	XS6 30B1MBL01G	0.205	0.45
Description		For use with sensors	Catalog Number	Weight	
Mounting brackets		Ø 12	XSZB112	0.006	0.01
		Ø 18	XSZB118	0.010	0.02
		Ø 30	XSZB130	0.020	0.04

Table 20.19: Osisense Capacitive Proximity Sensors, Cylindrical Stainless Steel, DC

Sensing Characteristics			
	Ø M12 threaded M12 x 1		Ø M18 threaded M18 x 1
Sensing Range	2 mm (0.078 in.)		5 mm (0.197 in.)
Switching Frequency	300		200
Shock Resistance	Conforming to IEC 60068-2-27: 30 gn, 11 ms		150
Vibration Resistance	Conforming to IEC 60068-2-6 10 gn, +/- 1 mm (10–55 Hz)		
Power Requirements			
Supply Voltage	30 mm: 24 Vdc (12–30 Vdc limits)		32 mm: 24–240 Vac (20–264 Vac limits)
Max. Load	200 mA		
Environment			
Operating Temperature Range	–25 +70 °C (–13 +158 °F)		
Product Certification	CE, ETL		
Environmental Protection Ratings	IP67, NEMA 4X (Indoor Use Only), IP65 (Ø M12 PCM and Ø18 PCM)		
Connection	Precabled, PVC (2 m)		
Catalog Numbers			
Housing Material	Stainless Steel		Nickel Plated Brass
Cable (flush mountable)	Catalog No.		Catalog No.
3-wire / PNP / N.O. function	XT112S1PAL2		XT130B1PAL2
3-wire / NPN / N.O. function	XT112S1NAL2		XT130B1NAL2
4-wire / PNP / N.O./N.C. function	XT112S1PCL2		XT130B1PCL2
Connector (flush mountable)	M12		
4-wire / PNP / N.O./N.C. function	XT112S1PCM12	XT118B1PCM12	XT130B1PCM12

[1] For a 5 m cable, replace L2 with L5; for a 10 m cable, replace L2 with L10. Example: XS612B1MAL2 becomes XS612B1MAL5 with a 5 m cable.
 [2] Protective cable gland included with remote screw terminal connector.
 [3] Available in Ø8 plastic with double insulation. See page 2/30 of 9006CT1007.

XUV and XXV Sensors

Table 20.20: XUV Label Sensor



Sensing Characteristics	
Nominal Sensing Distance	3 mm (0.12 in.)
Switching Frequency	500 Hz
Power Requirements	
Supply Voltage	12–24 Vdc (10–30 Vdc limits)
Max. Load	100 mA
Environmental	
Operating Temperature Range	+5 to +55 °C (+41 to +131 °F)
Environmental Protection Ratings	IP65, NEMA 4X (indoor use only), 5, 12, 12k, 13
Construction	
Flat Profile Dimensions (W x H x D)	92.5 x 47.3 x 16.0 mm (3.64 x 1.86 x 0.63 in.)
Housing Material	Aluminium
Transducer	Glass Epoxy
Connection	
M8 Connector	XUVU06M3KCNM8
Precabled (2 m)	XUVU06M3KCNL2

Table 20.21: XXV 18 mm Ultrasonic Sensors



Sensing Characteristics		
Nominal Sensing Distance	2 mm to 50.8 mm (0.08 in. to 2.0 in.)	
Switching Frequency	80 Hz	
Power Requirements		
Supply Voltage	12–24 Vdc	
Max. Load	200 mA	
Environmental		
Operating Temperature Range	0 to 60 °C (32 to 140 °F)	
Environmental Protection Ratings	NEMA Type 4 and 13, and IP67	
Construction		
Barrel Dimensions (Ø x L)	18 x 1 x 43.2 mm (0.71 x 0.04 x 1.70 in.)	
Housing Material	Nickel Plated Brass	
Transducer	Glass Epoxy	
Connection		
Cable	Precabled, PVC (2 m)	
PNP	N.O.	XXV18B1PAL2
	N.C.	XXV18B1PBL2
NPN	N.O.	XXV18B1NAL2
	N.C.	XXV18B1NBL2
Connection		
PNP	N.O.	XXV18B1PAM12
	N.C.	XXV18B1PBM12
NPN	N.O.	XXV18B1NAM12
	N.C.	XXV18B1NBM12

Table 20.22: Mounting Brackets



Body Type	Catalog No.
M12	9006PA12
M18	9006PA18
M30	9006PA30

Table 20.23: Sensor Accessories



Teachable Pushbutton Accessory for Virtu Series	
Catalog No.	
XXZPB100	



Python AC/DC Power Converter	
Catalog No.	
XXZPM100M12	

Table 20.24: Accessories

	mm	Catalog No.	
Reflectors	24 x 21	XUZC24	
	Ø 80	XUZC80	
	50 x 50	XUZC50	
Material		Catalog No.	
Mounting Brackets for XUB	Die Cast Zinc	XUZA118	
	Plastic	XUZA218	
90°		Straight	
Catalog No.		Catalog No.	
Cables (PUR), 2 m, without LED ^[1] Suitable plug-in female connectors, including pre-wired versions	M8 (4-Pin)	XZCP1041L2	XZCP0941L2
	M12 (4-pin)	XZCP1241L2	XZCP1141L2
	1/2-20UNF	XZCP1965L2	XZCP1865L2

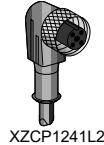
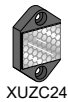

[1] For 5 or 10 meter lengths, replace 2 in the cable catalog number with 5 or 10.

VM Sensors

Table 20.25: Specifications and Catalog Numbers



Virtu™ VM1 and VM18

Specifications					
Sensing Characteristics					
Sensing Range	51–508 mm (2–20 in.)				
Max. Switching Frequency	300 Hz				
Power Requirements					
Supply Voltage	12–24 Vdc				
Supply Current	40 mA (excluding load)				
Environmental Ratings					
Operating Temperature	–30 to 70 °C (–22 to 158 °F)				
Environment	NEMA 4X (indoor use only), IP67				
Construction					
VM18 Barrel, ØxL	18 x 1 x 77.62 mm (0.709 x 3.06 in.)				
VM1 Dual Mount	Ø 18 mm and Flat Format 43.7 x 18 x 59.7 mm (1.72 x 0.70 x 2.35 in.)				
Housing Material	PBT Resin				
Transducer	Glass Epoxy				
Output Type		Catalog Number			
		Cable		Quick Disconnect	
Output		Dual Mount	Barrel	Dual Mount	Barrel
Proximity	PNP Sourcing	N.O.	VM18PNO	VM1PNOQ	VM18PNOQ
		N.C.	VM1PNC	VM18PNC	VM1PNCQ
	NPN Sinking	N.O.	VM1NNO	VM18NNO	VM1NNOQ
		N.C.	VM1NNC	VM18NNC	VM1NNCQ
	PNP Sourcing	N.O.	VM1PTO	VM18PTO	VM1PTOQ
		N.C.			
NPN Sinking	N.O.	VM1NTO	VM18NTO	VM1NTOQ	
	N.C.				
Dual-Level Pump In Normally Open	Off at loss of echo and at powerup	PNP	VM1PPI0000	VM18PPI0000	VM1PPI0000Q
		NPN	VM1NPI0000	VM18NPI0000	VM1NPI0000Q
	On at loss of echo and at powerup	PNP	VM1PPI1000	VM18PPI1000	VM1PPI1000Q
		NPN	VM1NPI1000	VM18NPI1000	VM1NPI1000Q
Hold on loss of echo, Off at powerup	PNP	VM1PPI2000	VM18PPI2000	VM1PPI2000Q	
	NPN	VM1NPI2000	VM18NPI2000	VM1NPI2000Q	
Dual-Level Pump Out Normally Open	Off at loss of echo and at powerup	PNP	VM1PPO0000	VM18PPO0000	VM1PPO0000Q
		NPN	VM1NPO0000	VM18NPO0000	VM1NPO0000Q
	On at loss of echo and at powerup	PNP	VM1PPO1000	VM18PPO1000	VM1PPO1000Q
		NPN	VM1NPO1000	VM18NPO1000	VM1NPO1000Q
	Hold on loss of echo, Off at powerup	PNP	VM1PPO2000	VM18PPO2000	VM1PPO2000Q
		NPN	VM1NPO2000	VM18NPO2000	VM1NPO2000Q
Analog	Voltage 0–10 Vdc with Temperature Compensation For Direct/Inverse models, change VD or VI to VA.				
	Direct, 0 V at loss of echo and at powerup	VM1VD0000	VM18VD0000	VM1VD0000Q	VM18VD0000Q
	Inverse, 0 V at loss of echo and at powerup	VM1VI0000	VM18VI0000	VM1VI0000Q	VM18VI0000Q
	Direct, 10 V at loss of echo and at powerup	VM1VD1000	VM18VD1000	VM1VD1000Q	VM18VD1000Q
	Inverse, 10 V at loss of echo and at powerup	VM1VI1000	VM18VI1000	VM1VI1000Q	VM18VI1000Q
	Direct, hold on loss of echo, 0 V at powerup	VM1VD2000	VM18VD2000	VM1VD2000Q	VM18VD2000Q
	Inverse, hold on loss of echo, 0 V at powerup	VM1VI2000	VM18VI2000	VM1VI2000Q	VM18VI2000Q
	Direct, hold on loss of echo, 10 V at powerup	VM1VD3000	VM18VD3000	VM1VD3000Q	VM18VD3000Q
	Inverse, hold on loss of echo, 10 V at powerup	VM1VI3000	VM18VI3000	VM1VI3000Q	VM18VI3000Q
	Current 4–20 mA with Temperature Compensation For Direct/Inverse models, change CD or CI to CA				
	Direct, 4 mA at loss of echo and at powerup	VM1CD0000	VM18CD0000	VM1CD0000Q	VM18CD0000Q
	Inverse, 4 mA at loss of echo and at powerup	VM1CI0000	VM18CI0000	VM1CI0000Q	VM18CI0000Q
	Direct, 20 mA at loss of echo and at powerup	VM1CD1000	VM18CD1000	VM1CD1000Q	VM18CD1000Q
	Inverse, 20 mA at loss of echo and at powerup	VM1CI1000	VM18CI1000	VM1CI1000Q	VM18CI1000Q
	Direct, hold on loss of echo, 4 mA at powerup	VM1CD2000	VM18CD2000	VM1CD2000Q	VM18CD2000Q
	Inverse, hold on loss of echo, 4 mA at powerup	VM1CI2000	VM18CI2000	VM1CI2000Q	VM18CI2000Q
	Direct, hold on loss of echo, 20 mA at powerup	VM1CD3000	VM18CD3000	VM1CD3000Q	VM18CD3000Q
	Inverse, hold on loss of echo, 20 mA at powerup	VM1CI3000	VM18CI3000	VM1CI3000Q	VM18CI3000Q

ELECTRONIC SENSORS AND MACHINE CABLING

30 MM Ultrasonic Sensors

Table 20.26: Specifications and Catalog Numbers



Virtu™ 30 mm



M30
30 mm (1 or 2 m)



M30
30 mm (8 m)

Specifications								
Sensing Characteristics								
Sensing Range	102–1000 mm (4–39 in.)		51 mm to 1 m (2–39 in.); 119 mm to 2 m (4.7–79 in.)		304.8 mm to 8 m (12–315 in.)			
Sensing Frequency	180 kHz		200 kHz		75 kHz			
Power Requirements								
Supply Voltage	12–24 Vdc discrete, 15–24 Vdc analog		12–24 Vdc discrete; 15–24 Vdc analog		12–24 Vdc discrete; 15–24 Vdc analog			
Supply Current	40 mA discrete, 90 mA analog (excluding load)		80 mA (excluding load)		80 mA (excluding load)			
Environmental Ratings								
Operating Temperature	0 to 70 °C (32 to 158 °F)		0 to 50 °C (32 to 122 °F) discrete –20 to 60 °C (–4 to 140 °F) analog		–40 to 60 °C (–40 to 140 °F)			
Environment	NEMA 4X (indoor use only), IP67		NEMA 4X (indoor use only), IP67		NEMA 4X (indoor use only), IP67			
Construction								
Barrel, ØxL	30 x 1 x 95.26 mm (1.18 x 3.75 in.)		30 x 1 x 95 mm (1.18 x 3.74 in.)		30 x 1 x 116 mm (9.18 x 4.58 in.)			
Housing Material	PBT Resin		PEI Resin		PEI Resin			
Transducer	Glass Epoxy		Silicon Rubber or Fluorosilicone		Glass Epoxy			
Output Type								
			1 m / 2 m		8 m			
Proximity Output	Description		Catalog No.		Description		Catalog No.	
	PNP Sourcing N.O.	XX6V3A1PAM12	1 m	Connector	SM950A100000	Cable	SM900A800000	
		XX6V3A1PBM12		Cable	SM900A100000			
	NPN Sinking N.O.	XX6V3A1NAM12	2 m	Connector	SM950A400000	Connector	SM950A800000	
XX6V3A1NBM12		Cable		SM900A400000				
Dual-Level Pump In	Connector		Cable 1 m [2]		PNP, NO		Cable 8 m	
	Normally Open		Pump-out latch		SM902A100000		Pump-out latch	
	Hold on loss of echo; Off on power up		Pump-out latch w/alarm		SM902A1560000		Pump-out latch w/alarm	
	PNP	XX2V3A1PGM12	Pump-out latch, w/setpoint		SM902A1760000		Pump-out latch, w/setpoint	
	NPN	XX2V3A1NGM12	Pump-in latch		SM902A1100000		Pump-in latch	
	Off on loss of echo; Off on power up		Pump-in latch w/alarm		SM902A1460000		Pump-in latch w/alarm	
	PNP	XX2V3A1PFM12	Pump-in latch, w/setpoint		SM902A1660000		Pump-in latch, w/setpoint	
	NPN	XX2V3A1NFM12	Dual setpoint		SM902A1260000		Dual setpoint	
Dual-Level Pump Out	Hold on loss of echo; Off on power up		Dual alarm		SM902A1360000		Dual alarm	
	PNP	XX2V3A1PJM12	Connector		PNP, NO		Connector	
	NPN	XX2V3A1NJM12	Pump-out latch		SM952A100000		Pump-out latch	
	Off on loss of echo; Off on power up		Pump-out latch w/alarm		SM952A1560000		Pump-out latch w/alarm	
	PNP	XX2V3A1PHM12	Pump-out latch, w/setpoint		SM952A1760000		Pump-out latch, w/setpoint	
	NPN	XX2V3A1NHM12	Pump-in latch		SM952A1100000		Pump-in latch	
			Pump-in latch w/alarm		SM952A1460000		Pump-in latch w/alarm	
			Pump-in latch, w/setpoint		SM952A1660000		Pump-in latch, w/setpoint	
			Dual setpoint		SM952A1260000		Dual setpoint	
			Dual alarm		SM952A1360000		Dual alarm	
	Quick Disconnect		Cable 1 m [2]		Cable 8 m		Cable 8 m	
	0–20 mA		Voltage (0–10 Vdc)		Voltage (0–10 Vdc)		Voltage (0–10 Vdc)	
Analog	Direct/Inverse slope		Auto slope		Auto slope		Auto slope	
	Direct output	XX9V3A1C4M12	SM906A180000		SM906A180000		SM906A88000	
	Direct output	XX9V3A1D4M12	SM906A1100000		SM906A1100000		SM906A81000	
	Inverse output	XX9V3A1E4M12	SM906A1000000		SM906A1000000		SM906A80000	
	4–20 mA		Current (4–20 mA)		Current (4–20 mA)		Current (4–20 mA)	
	Direct/Inverse slope	XX9V3A1C2M12	Auto slope		SM906A1900000		Auto slope	
	Direct output	XX9V3A1D2M12	Direct slope		SM906A1300000		Direct slope	
	Inverse output	XX9V3A1E2M12	Inverse slope		SM906A1200000		Inverse slope	
	0–5 Vdc		Connector		Connector		Connector	
	Direct/Inverse slope	XX9V3A1F3M12	Voltage (0–10 Vdc)		Voltage (0–10 Vdc)		Voltage (0–10 Vdc)	
	Direct output	XX9V3A1G3M12	Auto slope		SM956A1800000		Auto slope	
	Inverse output	XX9V3A1H3M12	Direct slope		SM956A1100000		Direct slope	
	0–10 Vdc		Inverse slope		SM956A1000000		Inverse slope	
	Direct/Inverse slope	XX9V3A1F1M12	Current (4–20 mA)		Current (4–20 mA)		Current (4–20 mA)	
	Direct output	XX9V3A1G1M12	Auto slope		SM956A1900000		Auto slope	
	Inverse output	XX9V3A1H1M12	Direct slope		SM956A1300000		Direct slope	
			Inverse slope		SM956A1200000		Inverse slope	

[2] For the 2 m version, change model from SMxxxA1xxxxx to SMxxxA4xxxxx.

California Proposition 65 Message

⚠ WARNING: Some of the products listed in this document can expose you to chemicals which are known to the State of California to cause cancer, birth defects, or other reproductive harm.

For more information, go to <https://www.p65warnings.ca.gov/>.