

NOTES:

1. INSTALLATION MUST COMPLY WITH ALL APPLICABLE NATIONAL AND LOCAL ELECTRICAL REGULATIONS.
2. PLEASE REFER TO THE PRODUCT MANUALS FOR DETAILED INFORMATION.
3. ALL DIMENSIONS ARE IN MILLIMETERS, UNLESS OTHERWISE SPECIFIED.
4. WEIGHT OF UNIT (TOTAL) = 636 kg.
5. BOTTOM CABLE ENTRY ONLY.

THIS DRAWING AND SPECIFICATIONS HEREIN ARE THE PROPERTY OF AMERICAN POWER CONVERSION AND SHALL NOT BE COPIED, REPRODUCED OR USED IN WHOLE OR IN PART, AS THE BASIS FOR THE MANUFACTURE OR SALE OF ITEMS WITHOUT WRITTEN PERMISSION FROM APC. THIS DRAWING IS BASED UPON LATEST AVAILABLE INFORMATION AND IS SUBJECT TO CHANGE WITHOUT NOTICE.



TITLE: SYMMETRA MW UPS  
400V AC, 3PH, 2000kW  
EXTERNAL STATIC SWITCH  
BOTTOM CABLE ENTRY OPTION  
MAIN MECHANICAL

PROJECT: SUBMITTAL DRAWINGS SHEET 1 OF 5

DWG NO: SYSSWB2000KH-MM REV. 4

DRAWN: JAYAPRAKASH 22-SEP-08

ENGINEER: L.DUELUND 22-SEP-08

APPROVED: C LARSEN/S WAGH 22-SEP-08

FIRST ANGLE PROJECTION

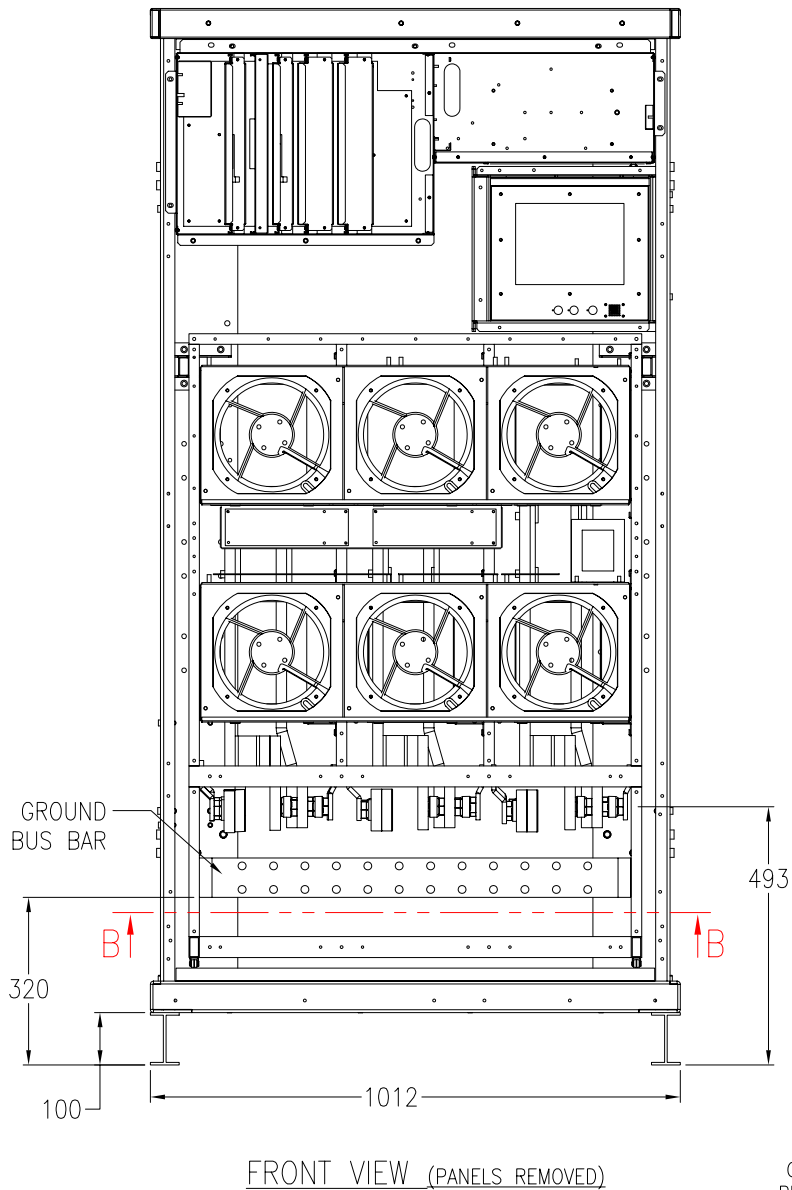

FRONT VIEW (PANELS REMOVED)

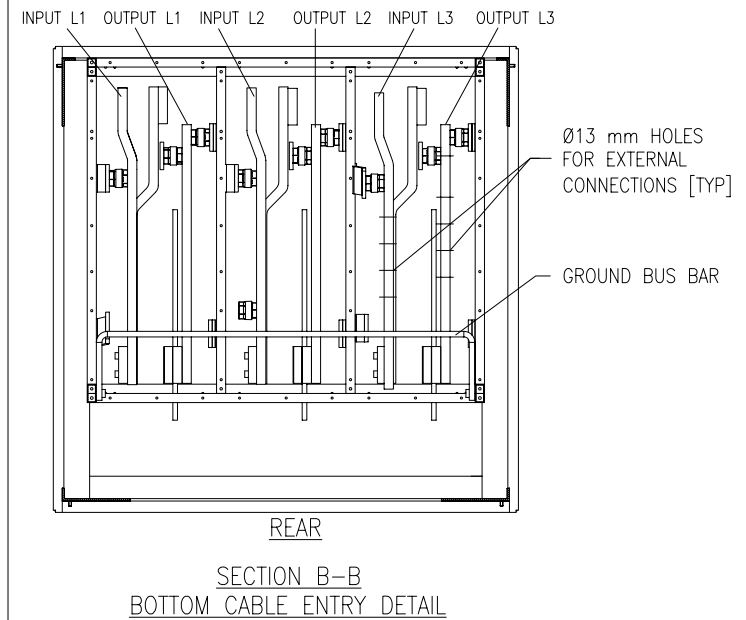
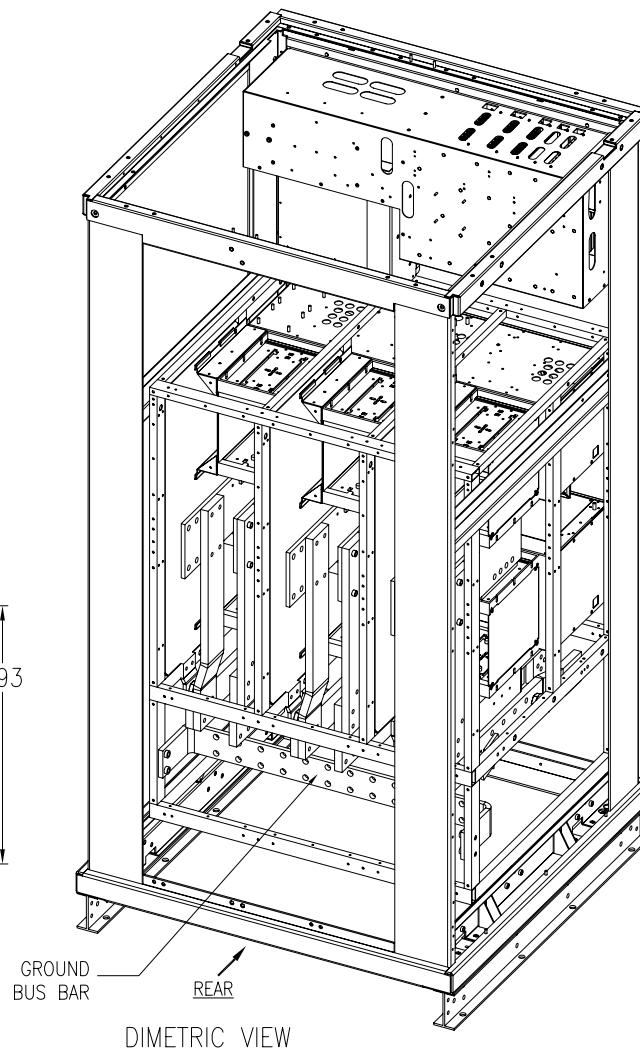

NOTES:

1. INSTALLATION MUST COMPLY WITH ALL APPLICABLE NATIONAL AND LOCAL ELECTRICAL REGULATIONS.
2. PLEASE REFER TO THE PRODUCT MANUALS FOR DETAILED INFORMATION.
3. ALL DIMENSIONS ARE IN MILLIMETERS, UNLESS OTHERWISE SPECIFIED.
4. SOME MECHANICAL COMPONENTS HAVE BEEN OMITTED FOR THE PURPOSE OF CLARITY.

THIS DRAWING AND SPECIFICATIONS HEREIN ARE THE PROPERTY OF AMERICAN POWER CONVERSION AND SHALL NOT BE COPIED, REPRODUCED OR USED IN WHOLE OR IN PART, AS THE BASIS FOR THE MANUFACTURE OR SALE OF ITEMS WITHOUT WRITTEN PERMISSION FROM APC. THIS DRAWING IS BASED UPON LATEST AVAILABLE INFORMATION AND IS SUBJECT TO CHANGE WITHOUT NOTICE.



TITLE: SYMMETRA MW UPS  
400V AC, 3PH, 2000kW  
EXTERNAL STATIC SWITCH  
BOTTOM CABLE ENTRY OPTION  
INTERNAL VIEW & SECTION VIEW

PROJECT: SUBMITTAL DRAWINGS SHEET 2 OF 5

DWG NO: SYSSWB2000KH-ME1

DRAWN: JAYAPRAKASH 22-SEP-08

ENGINEER: L.DUELUND 22-SEP-08

APPROVED: C LARSEN/S WAGH 22-SEP-08

REV. 3

FIRST ANGLE PROJECTION

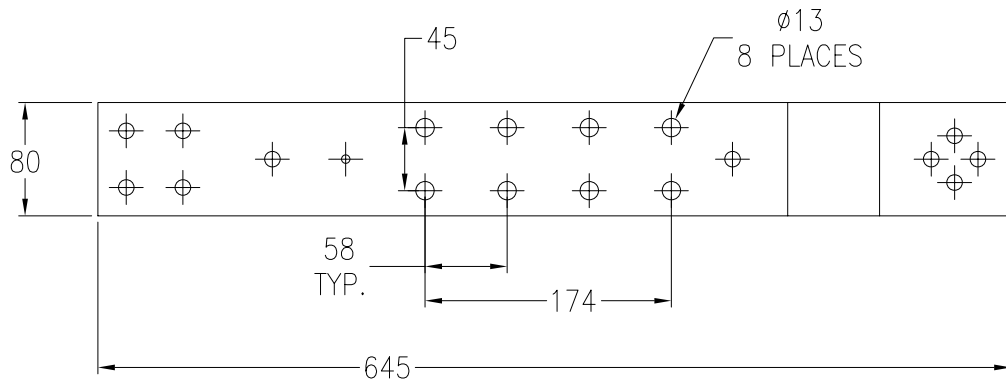

INPUT BUSBAR DETAILS  
Thickness- 20mm

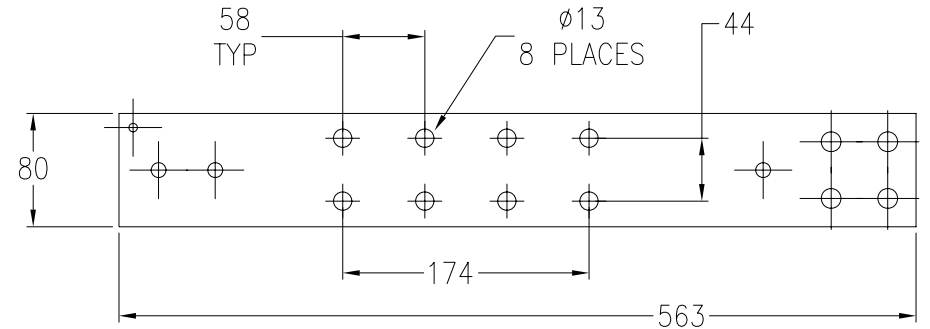

OUTPUT BUSBAR DETAIL  
Thickness- 20mm

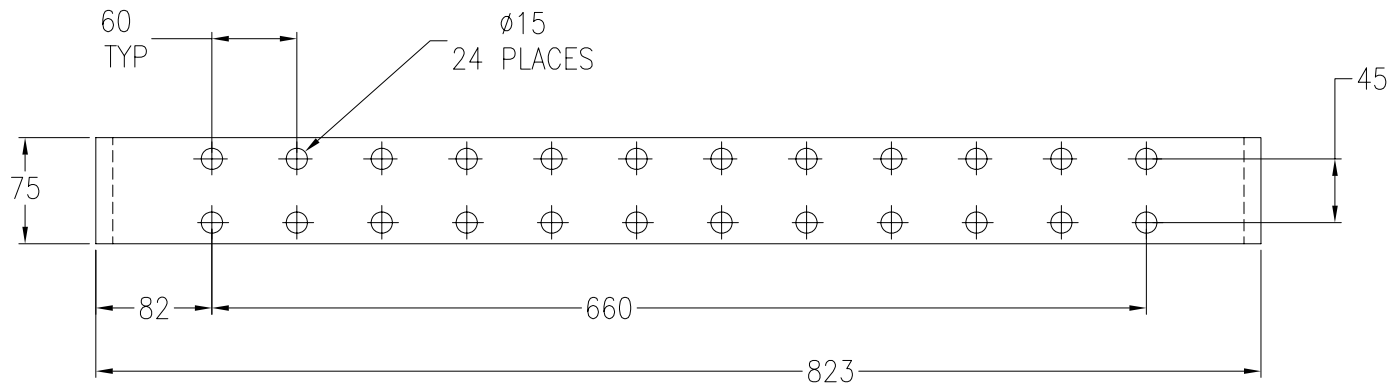

GROUND BUSBAR DETAIL  
Thickness- 12mm

NOTES:

1. INSTALLATION MUST COMPLY WITH ALL APPLICABLE NATIONAL AND LOCAL ELECTRICAL REGULATIONS.
2. ALL DIMENSIONS ARE IN MILLIMETERS, UNLESS OTHERWISE SPECIFIED.

THIS DRAWING AND SPECIFICATIONS HEREIN ARE THE PROPERTY OF AMERICAN POWER CONVERSION AND SHALL NOT BE COPIED, REPRODUCED OR USED IN WHOLE OR IN PART, AS THE BASIS FOR THE MANUFACTURE OR SALE OF ITEMS WITHOUT WRITTEN PERMISSION FROM APC. THIS DRAWING IS BASED UPON LATEST AVAILABLE INFORMATION AND IS SUBJECT TO CHANGE WITHOUT NOTICE.



TITLE: SYMMETRA MW UPS  
400V AC, 3PH, 2000kW  
EXTERNAL STATIC SWITCH  
BOTTOM CABLE ENTRY OPTION  
BUSBAR DETAILS

PROJECT: SUBMITTAL DRAWINGS SHEET 3 OF 5

DWG NO: SYSSWB2000KH-ME2 REV. 1

DRAWN: JAYAPRAKASH 22-SEP-08

ENGINEER: L.DUELUND 22-SEP-08

APPROVED: C LARSEN/S WAGH 22-SEP-08

FIRST ANGLE PROJECTION

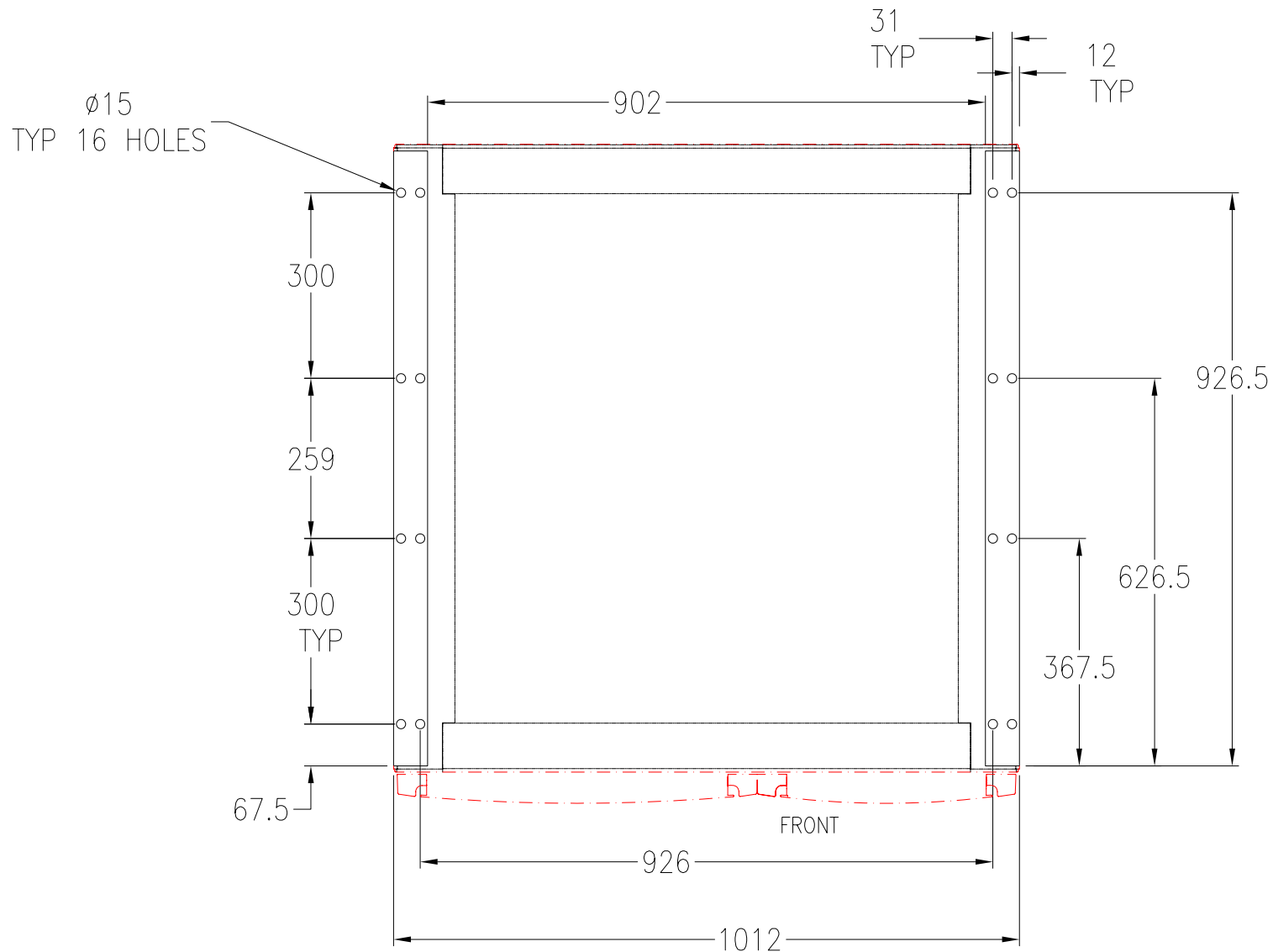

### FLOOR ANCHORING DETAILS

**NOTES:**

1. INSTALLATION MUST COMPLY WITH ALL APPLICABLE NATIONAL AND LOCAL ELECTRICAL REGULATIONS.
2. PLEASE REFER TO THE PRODUCT MANUALS FOR FLOOR ANCHORING PROCEDURE.
3. ALL DIMENSIONS ARE IN MILLIMETERS, UNLESS OTHERWISE SPECIFIED.
4. SOME STRUCTURAL DETAILS HAVE BEEN OMITTED FOR THE PURPOSE OF CLARITY.

THIS DRAWING AND SPECIFICATIONS HEREIN ARE THE PROPERTY OF AMERICAN POWER CONVERSION AND SHALL NOT BE COPIED, REPRODUCED OR USED IN WHOLE OR IN PART, AS THE BASIS FOR THE MANUFACTURE OR SALE OF ITEMS WITHOUT WRITTEN PERMISSION FROM APC. THIS DRAWING IS BASED UPON LATEST AVAILABLE INFORMATION AND IS SUBJECT TO CHANGE WITHOUT NOTICE.



TITLE: SYMMETRA MW UPS  
400V AC, 3PH, 2000kW  
EXTERNAL STATIC SWITCH  
BOTTOM CABLE ENTRY OPTION  
FLOOR ANCHORING

DWG NO: SYSSWB2000KH-FA

REV. 4

DRAWN: JAYAPRAKASH 22-SEP-08

FIRST ANGLE PROJECTION

ENGINEER: L.DUELUND 22-SEP-08

PROJECT: SUBMITTAL DRAWINGS SHEET 4 OF 5

APPROVED: C LARSEN/S WAGH 22-SEP-08

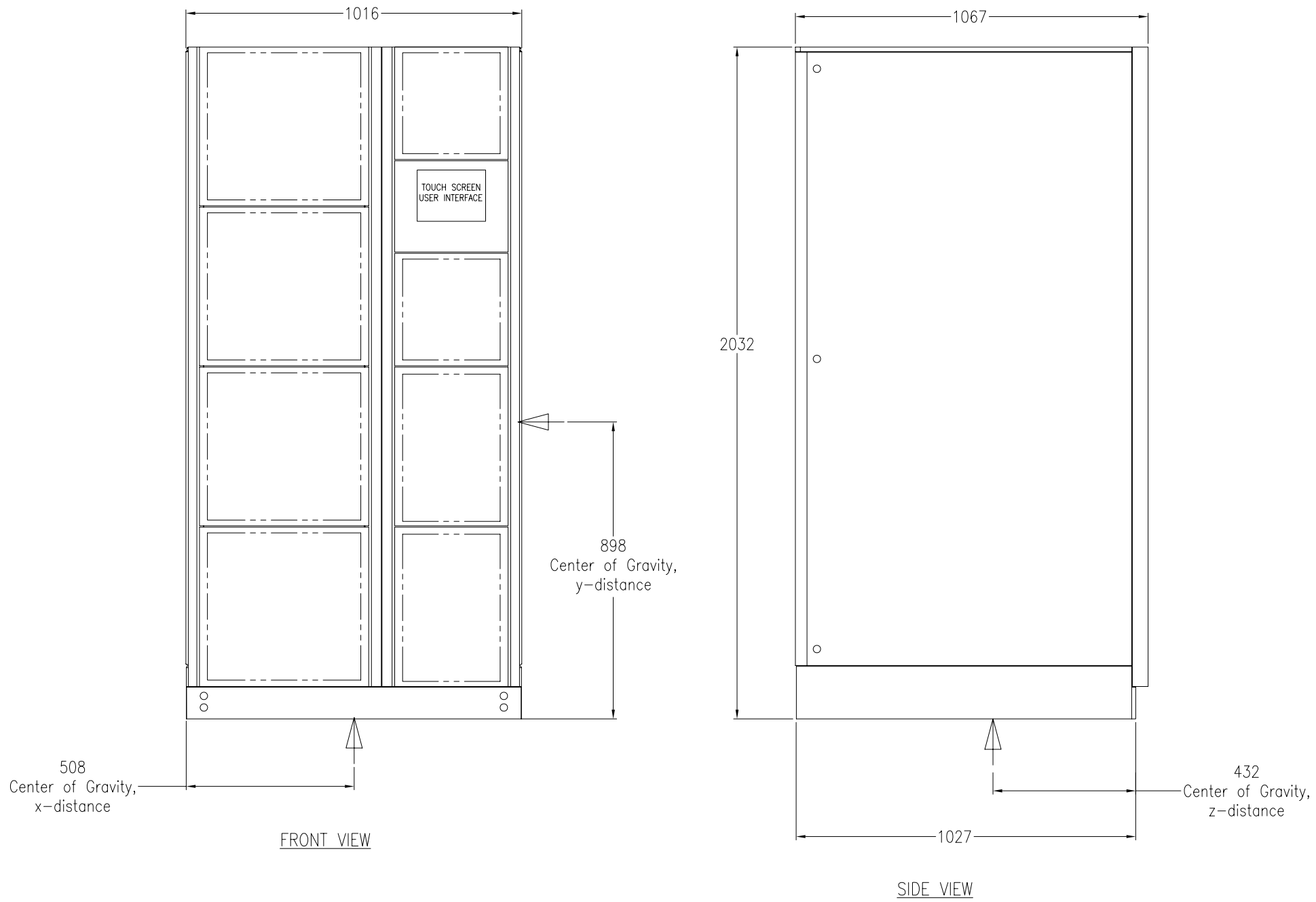

NOTES:

1. INSTALLATION MUST COMPLY WITH ALL APPLICABLE NATIONAL AND LOCAL ELECTRICAL REGULATIONS.
2. PLEASE REFER TO THE PRODUCT MANUALS FOR DETAILED INFORMATION.
3. ALL DIMENSIONS ARE IN MILLIMETERS, UNLESS OTHERWISE SPECIFIED.

THIS DRAWING AND SPECIFICATIONS HEREIN ARE THE PROPERTY OF AMERICAN POWER CONVERSION AND SHALL NOT BE COPIED, REPRODUCED OR USED IN WHOLE OR IN PART, AS THE BASIS FOR THE MANUFACTURE OR SALE OF ITEMS WITHOUT WRITTEN PERMISSION FROM APC. THIS DRAWING IS BASED UPON LATEST AVAILABLE INFORMATION AND IS SUBJECT TO CHANGE WITHOUT NOTICE.



TITLE: SYMMETRA MW UPS  
400V AC, 3PH, 2000KW  
EXTERNAL STATIC SWITCH  
BOTTOM CABLE ENTRY OPTION  
CENTER OF GRAVITY

PROJECT: SUBMITTAL DRAWINGS SHEET 5 OF 5

DWG NO: SYSSWB2000KH-CG

DRAWN: JAYAPRAKASH 22-SEP-08

ENGINEER: L.DUELUND 22-SEP-08

APPROVED: C LARSEN/S WAGH 22-SEP-08

REV. 5

FIRST ANGLE PROJECTION