

FRONT VIEW

SIDE VIEW

LEFT SIDE PLENUM

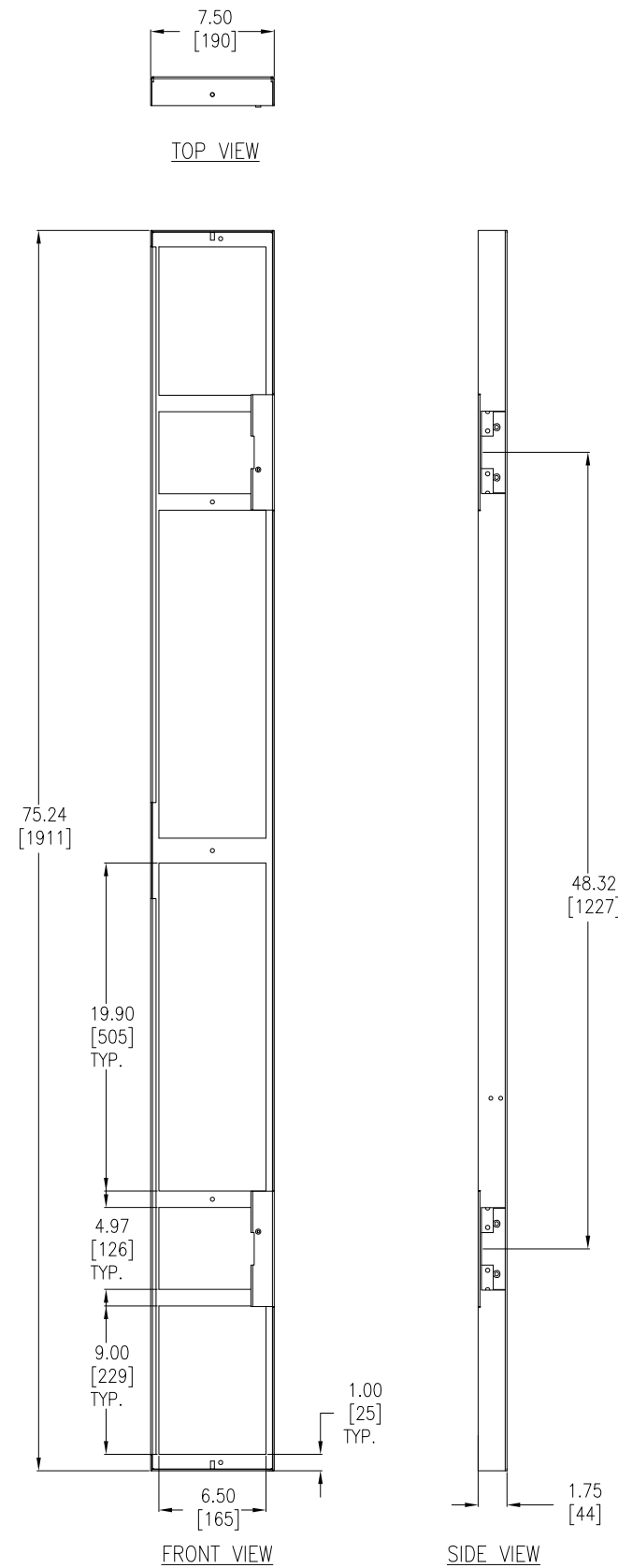

FRONT VIEW

SIDE VIEW

RIGHT SIDE PLENUM

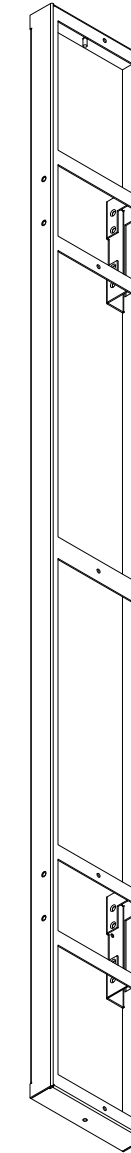

ISOMETRIC VIEW  
LEFT SIDE PLENUM

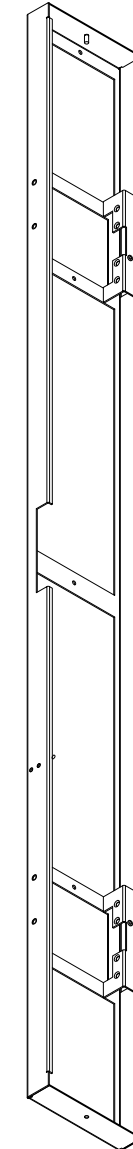

ISOMETRIC VIEW  
RIGHT SIDE PLENUM

**NOTES:**

1. INSTALLATION SHALL COMPLY WITH ALL APPLICABLE NATIONAL, STATE AND LOCAL CODES.
2. PLEASE REFER TO PRODUCT DOCUMENTATION FOR FURTHER INFORMATION.
3. UNLESS OTHERWISE SPECIFIED, ALL DIMENSIONS ARE IN INCHES [MILLIMETERS].

THIS DRAWING AND SPECIFICATIONS HEREIN ARE THE PROPERTY OF SCHNEIDER ELECTRIC AND SHALL NOT BE COPIED, REPRODUCED OR USED IN WHOLE OR IN PART, AS THE BASIS FOR THE MANUFACTURE OR SALE OF ITEMS WITHOUT WRITTEN PERMISSION FROM SCHNEIDER ELECTRIC. THIS DRAWING IS BASED UPON LATEST AVAILABLE INFORMATION AND IS SUBJECT TO CHANGE WITHOUT NOTICE.



TITLE:  
RACK AIR CONTAINMENT  
FRONT ASSEMBLY FOR  
NETSHELTER SX, 42U, 600mm WIDE  
LEFT & RIGHT SIDE PLENUMS

PROJECT: STD SUBMITTAL DRAWING SHEET: 1 OF 4

DWG NO: **ACCS1005** REV. 1

DRAWN: C KRISHNA/S CUNHA 29-SEP-14

ENGINEER: G IVEY/M BROWN 29-SEP-14

APPROVED: C GUMMSKEY/C ZALDIVAR 29-SEP-14

THIRD  
ANGLE  
PROJ

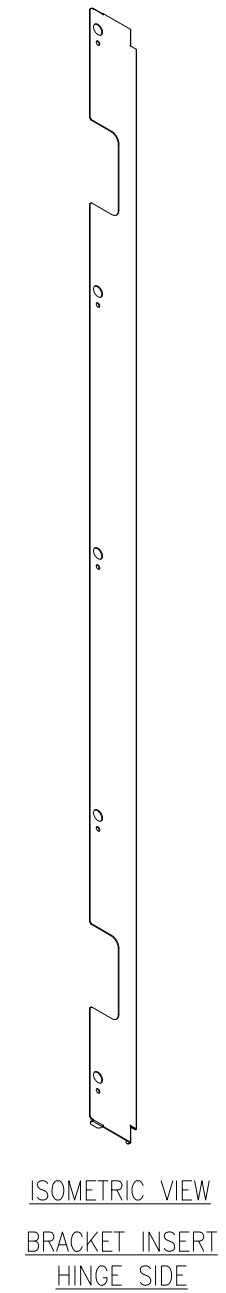
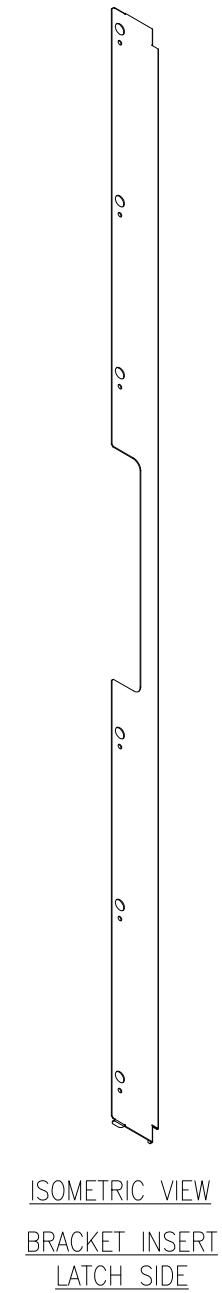
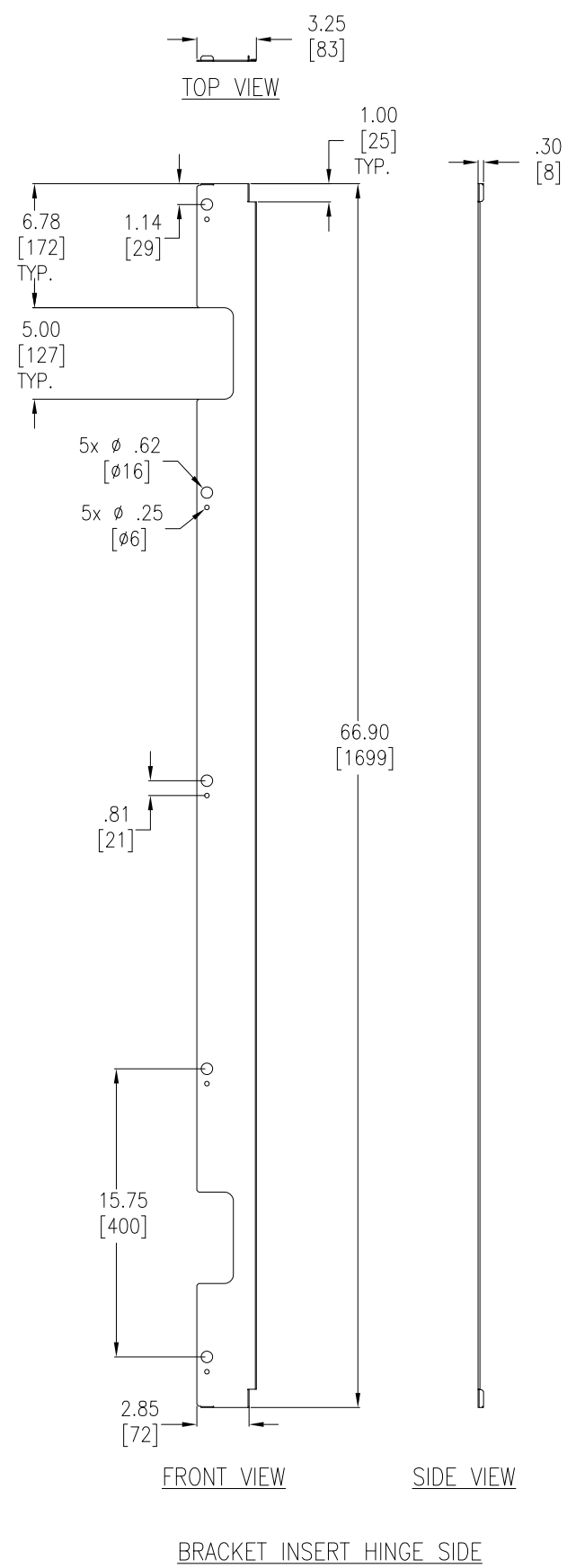
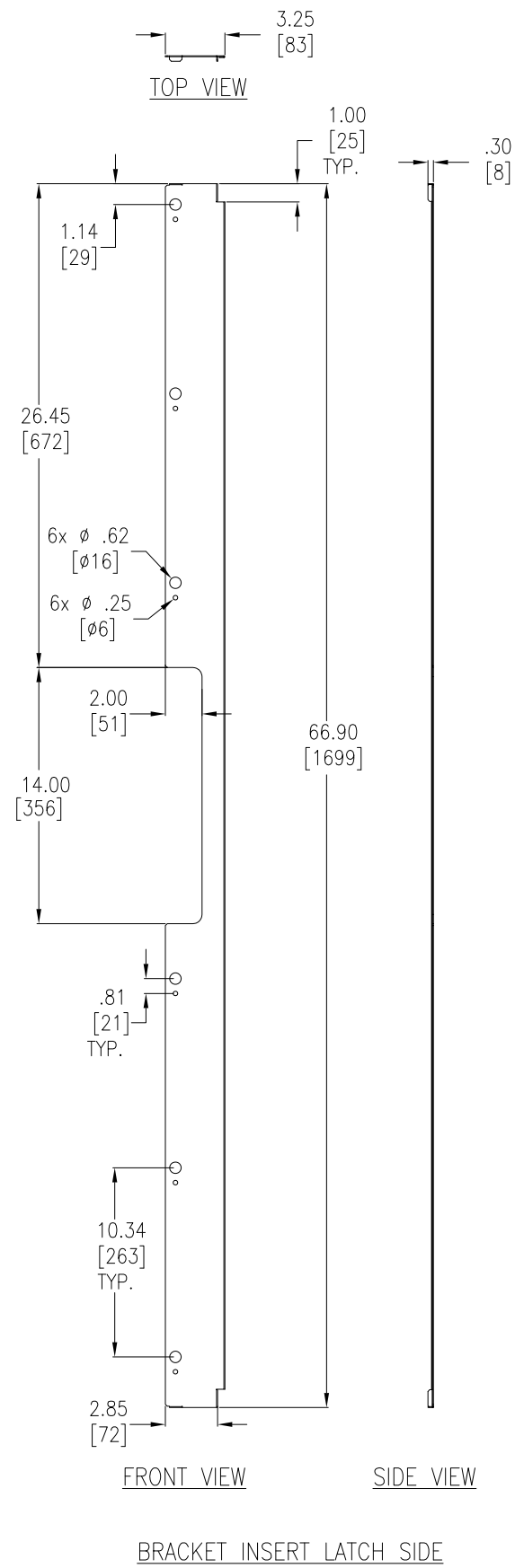

**NOTES:**

1. INSTALLATION SHALL COMPLY WITH ALL APPLICABLE NATIONAL, STATE AND LOCAL CODES.
2. PLEASE REFER TO PRODUCT DOCUMENTATION FOR FURTHER INFORMATION.
3. UNLESS OTHERWISE SPECIFIED, ALL DIMENSIONS ARE IN INCHES [MILLIMETERS].

THIS DRAWING AND SPECIFICATIONS HEREIN ARE THE PROPERTY OF SCHNEIDER ELECTRIC AND SHALL NOT BE COPIED, REPRODUCED OR USED IN WHOLE OR IN PART, AS THE BASIS FOR THE MANUFACTURE OR SALE OF ITEMS WITHOUT WRITTEN PERMISSION FROM SCHNEIDER ELECTRIC. THIS DRAWING IS BASED UPON LATEST AVAILABLE INFORMATION AND IS SUBJECT TO CHANGE WITHOUT NOTICE.



TITLE: RACK AIR CONTAINMENT FRONT ASSEMBLY FOR NETSHELTER SX, 42U, 600mm WIDE BRACKET INSERTS  
PROJECT: STD SUBMITTAL DRAWING SHEET: 2 OF 4

DWG NO: <b>ACCS1005</b>	REV. <b>1</b>
DRAWN: C KRISHNA/S CUNHA	29-SEP-14
ENGINEER: G IVEY/M BROWN	29-SEP-14
APPROVED: C CUMMSKEY/C ZALDIVAR	29-SEP-14

THIRD ANGLE PROJ

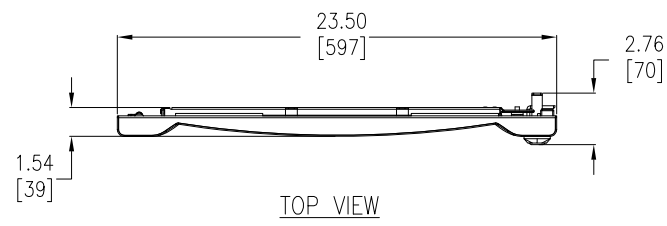

TOP VIEW

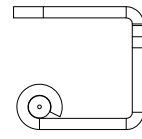

TOP VIEW

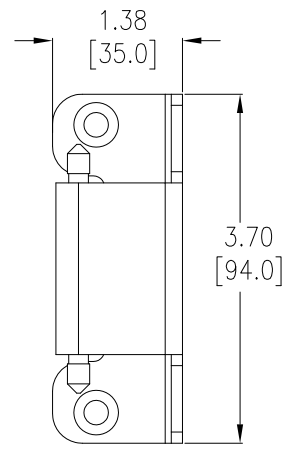

FRONT VIEW

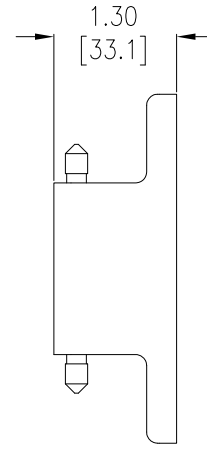

SIDE VIEW

HINGE

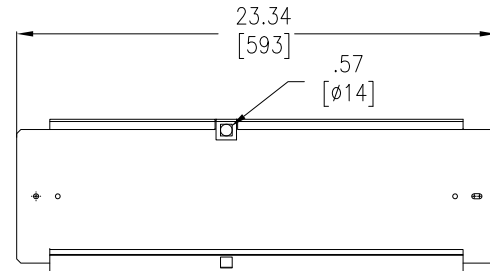

TOP VIEW

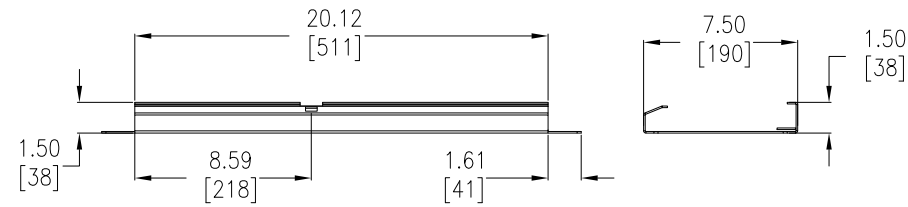

FRONT VIEW

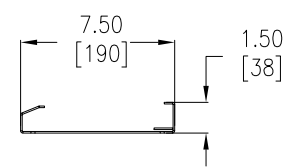

SIDE VIEW

TOP / BOTTOM PLENUM

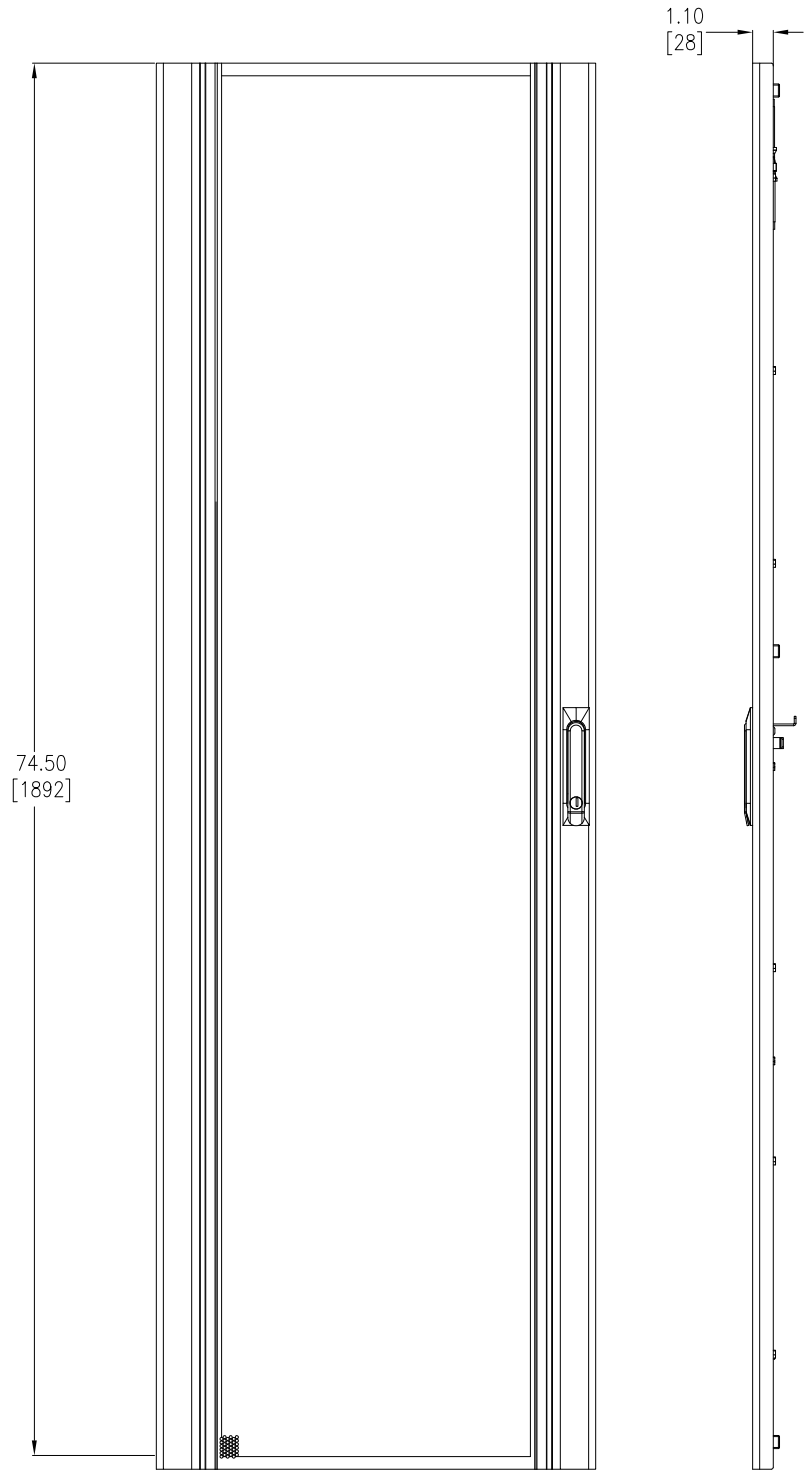

FRONT VIEW

SIDE VIEW

FRONT DOOR

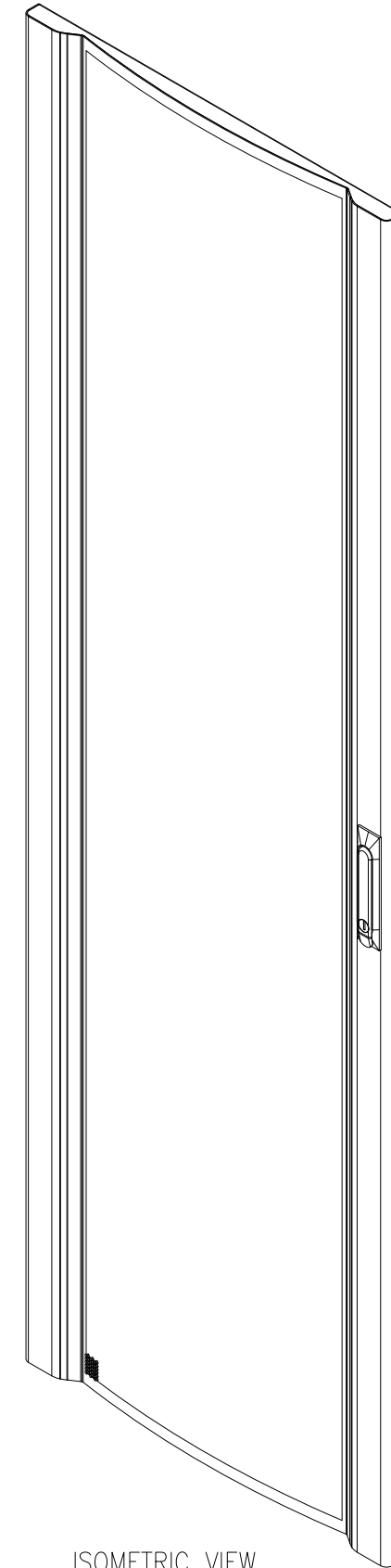

ISOMETRIC VIEW  
FRONT DOOR

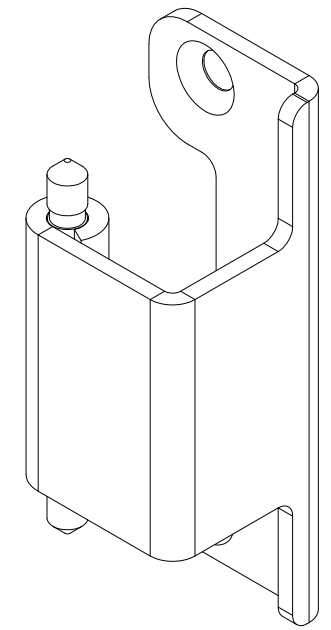

ISOMETRIC VIEW  
HINGE

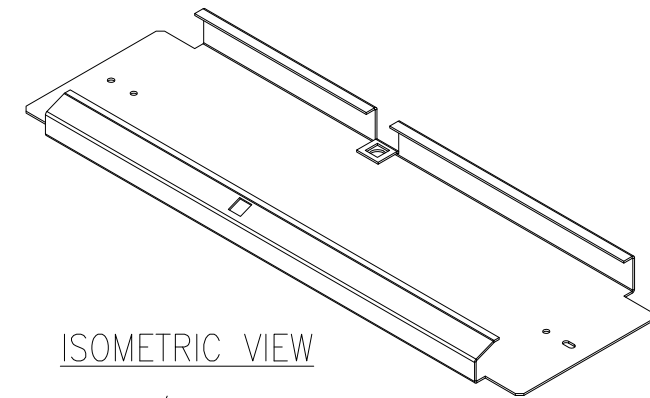

ISOMETRIC VIEW  
TOP / BOTTOM  
PLENUM

**NOTES:**

1. INSTALLATION SHALL COMPLY WITH ALL APPLICABLE NATIONAL, STATE AND LOCAL CODES.
2. PLEASE REFER TO PRODUCT DOCUMENTATION FOR FURTHER INFORMATION.
3. UNLESS OTHERWISE SPECIFIED, ALL DIMENSIONS ARE IN INCHES [MILLIMETERS].

THIS DRAWING AND SPECIFICATIONS HEREIN ARE THE PROPERTY OF SCHNEIDER ELECTRIC AND SHALL NOT BE COPIED, REPRODUCED OR USED IN WHOLE OR IN PART, AS THE BASIS FOR THE MANUFACTURE OR SALE OF ITEMS WITHOUT WRITTEN PERMISSION FROM SCHNEIDER ELECTRIC. THIS DRAWING IS BASED UPON LATEST AVAILABLE INFORMATION AND IS SUBJECT TO CHANGE WITHOUT NOTICE.



TITLE: RACK AIR CONTAINMENT FRONT ASSEMBLY FOR NETSHELTER SX, 42U, 600mm WIDE DOOR, PLENUM & HINGE DETAILS

PROJECT: STD SUBMITTAL DRAWING SHEET: 3 OF 4

DWG NO:	<b>ACCS1005</b>	REV.	1
DRAWN:	C KRISHNA/S CUNHA	29-SEP-14	THIRD ANGLE PROJ
ENGINEER:	G IVEY/M BROWN	29-SEP-14	
APPROVED:	C GUMMSKEY/C ZALDIVAR	29-SEP-14	

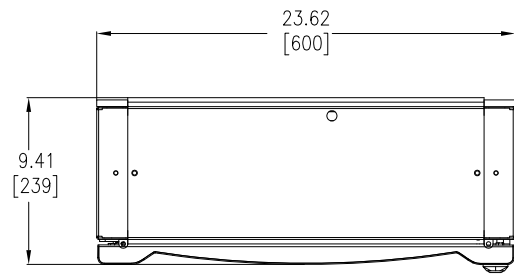

TOP VIEW

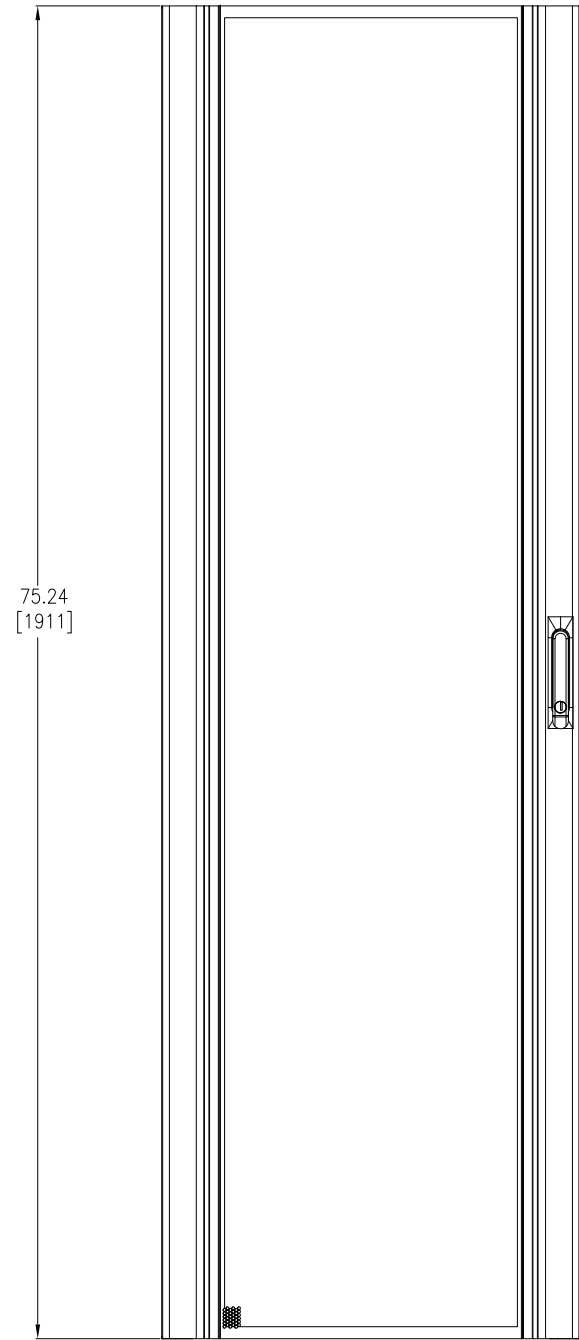

FRONT VIEW

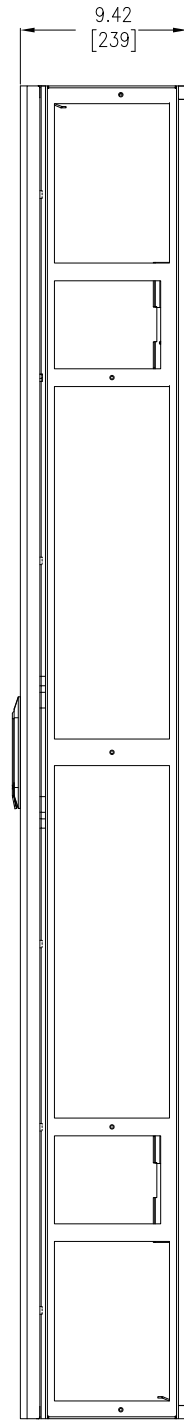

SIDE VIEW

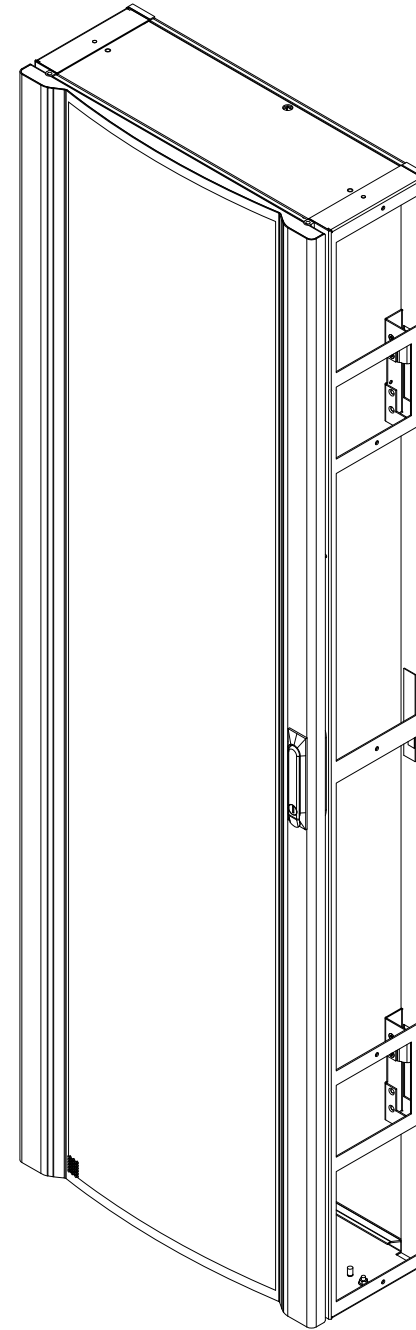

ISOMETRIC VIEW

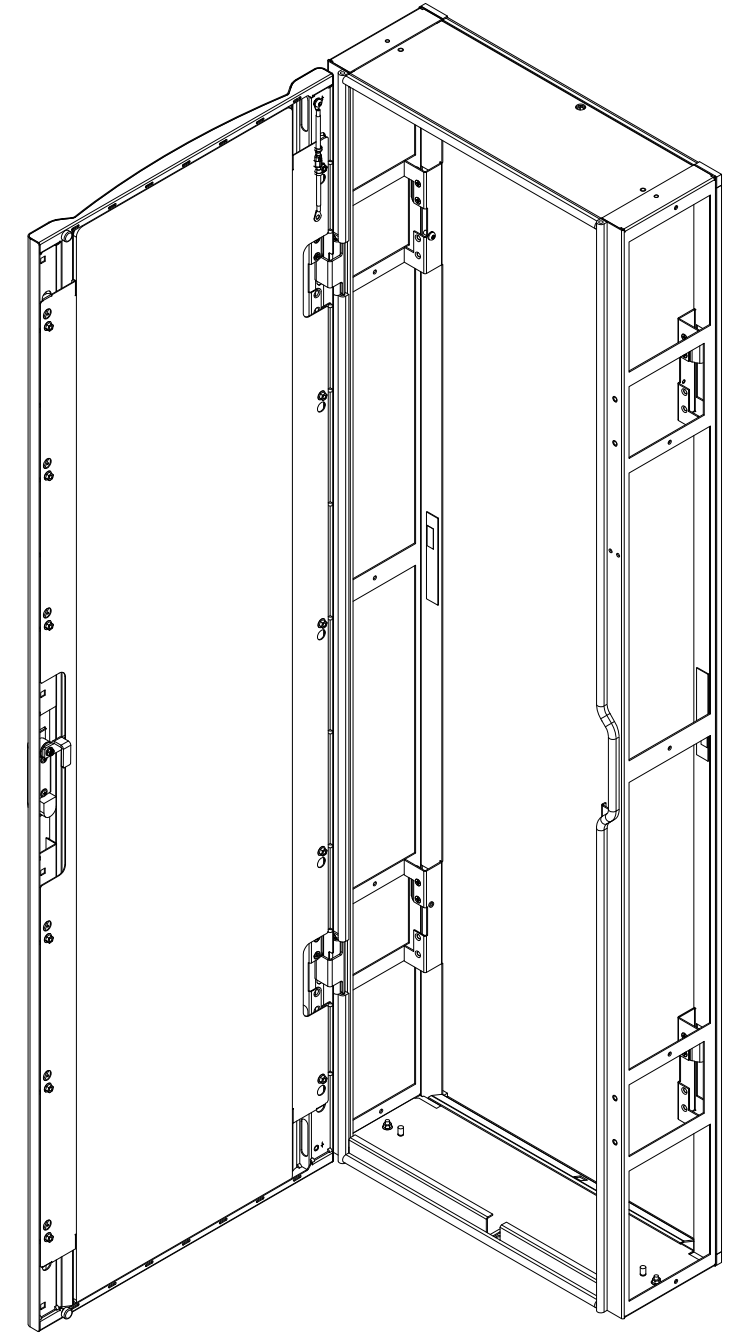

ISOMETRIC VIEW  
DOOR OPEN

**NOTES:**

1. INSTALLATION SHALL COMPLY WITH ALL APPLICABLE NATIONAL, STATE AND LOCAL CODES.
2. PLEASE REFER TO PRODUCT DOCUMENTATION FOR FURTHER INFORMATION.
3. UNLESS OTHERWISE SPECIFIED, ALL DIMENSIONS ARE IN INCHES [MILLIMETERS].
4. NET WEIGHT OF UNIT IS 47.30 lbs [21.50 kg].

THIS DRAWING AND SPECIFICATIONS HEREIN ARE THE PROPERTY OF SCHNEIDER ELECTRIC AND SHALL NOT BE COPIED, REPRODUCED OR USED IN WHOLE OR IN PART, AS THE BASIS FOR THE MANUFACTURE OR SALE OF ITEMS WITHOUT WRITTEN PERMISSION FROM SCHNEIDER ELECTRIC. THIS DRAWING IS BASED UPON LATEST AVAILABLE INFORMATION AND IS SUBJECT TO CHANGE WITHOUT NOTICE.



TITLE: RACK AIR CONTAINMENT FRONT ASSEMBLY FOR NETSHELTER SX, 42U, 600mm WIDE ASSEMBLY

PROJECT: STD SUBMITTAL DRAWING SHEET: 4 OF 4

DWG NO: **ACCS1005** REV. 1

DRAWN: C KRISHNA/S CUNHA 29-SEP-14

ENGINEER: G LIVEY/M BROWN 29-SEP-14

APPROVED: C CUMMSKEY/C ZALDIVAR 29-SEP-14

THIRD ANGLE PROJ