

LEFT VIEW

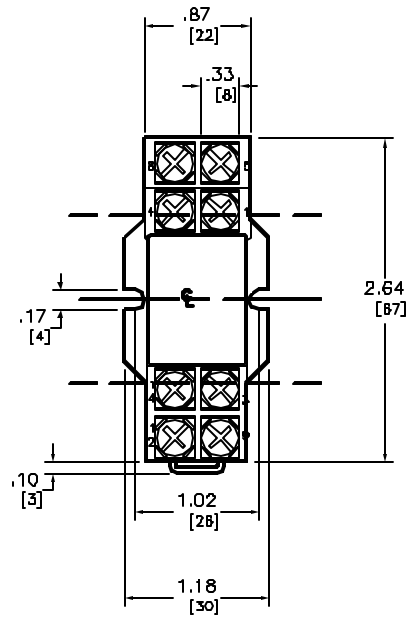

FRONT VIEW

SHOWN WITH RELAY INSTALLED

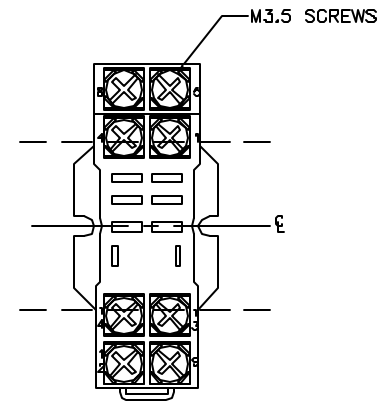

FRONT VIEW

SHOWN WITHOUT RELAY INSTALLED

Catalog Number: 8501-NR42
 Ratings: 300V, 10A
 UL File/CCN: E88924/SW1V2
 CSA File/Class: LRB4913/3211 D7
 Meets Standards: -
 Weight: -
 Wire Sizes: #12-#22 AWG
 Terminal torque: -
 Mounting Hwd.: (2) #6-32 SCREWS, 35mm DIN TRACK

DUAL DIMENSIONS: INCHES
 MILLIMETERS

GENERAL PURPOSE RELAY SOCKET
 CLASS 8501 TYPE NR42



DWG# E0703701-01
 NO.