

NOTES: UNLESS OTHERWISE SPECIFIED

1. INSTALLATION SHALL COMPLY WITH ALL APPLICABLE NATIONAL, STATE AND LOCAL CODES.
2. PLEASE REFER TO PRODUCT MANUALS FOR ADDITIONAL DETAILS.
3. ALL EXTERNAL WIRING BY CUSTOMER.
4. POWER AND CONTROL CABLES SHALL BE IN SEPARATE CONDUITS.
- △5. ALL INPUTS MUST BE FROM THE SAME SOURCE. 3 PHASE & GROUND PER UNIT.
- △6. UPSTREAM PROTECTIVE DEVICE REQUIRED. PROVIDED BY CUSTOMER.
- △7. REFERENCE SHEET 2.
- △8. CABLES SUPPLIED BY CUSTOMER. REFERENCE DRAWING 90-174706-00 FOR BREAKERS AUX CONTACTS CONNECTIONS.
- △9. CABLE SIZES AND LENGTHS FROM AC SOURCE TO EACH UPS AND FROM EACH UPS OUTPUT TO THE SBC MUST BE IDENTICAL.

SINGLE LINE INTERCONNECTION-3 UPS SINGLE INPUT 2CB SBC

THIS DRAWING AND SPECIFICATIONS HEREIN ARE THE PROPERTY OF SCHNEIDER ELECTRIC AND SHALL NOT BE COPIED, REPRODUCED OR USED IN WHOLE OR IN PART, AS THE BASIS FOR THE MANUFACTURE OR SALE OF ITEMS WITHOUT WRITTEN PERMISSION FROM SCHNEIDER ELECTRIC. THIS DRAWING IS BASED UPON LATEST AVAILABLE INFORMATION AND IS SUBJECT TO CHANGE WITHOUT NOTICE.



TITLE:

GALAXY 5000
PARALLEL CONFIGURATION
3 UPS SINGLE INPUT 2CB SBC
SINGLE LINE DIAGRAM

PROJECT: SUBMITTAL DRAWINGS SHEET 1 OF 2

DWG NO:

90-174804-00

REV.

0

DRAWN BY: BALAMURUGAN

31-MAR-10 ANGLE

ENGINEER: I. KENNEDY

21-FEB-08 PROJECTION

APPROVED BY: B.SHERIDAN/F.DIOSA

21-FEB-08 N.A.

INTERCONNECTIONS BETWEEN UPS UNITS EXCHANGE CURRENT AND CAN BUS INTERCONNECTIONS BETWEEN UPS UNITS TO SBC

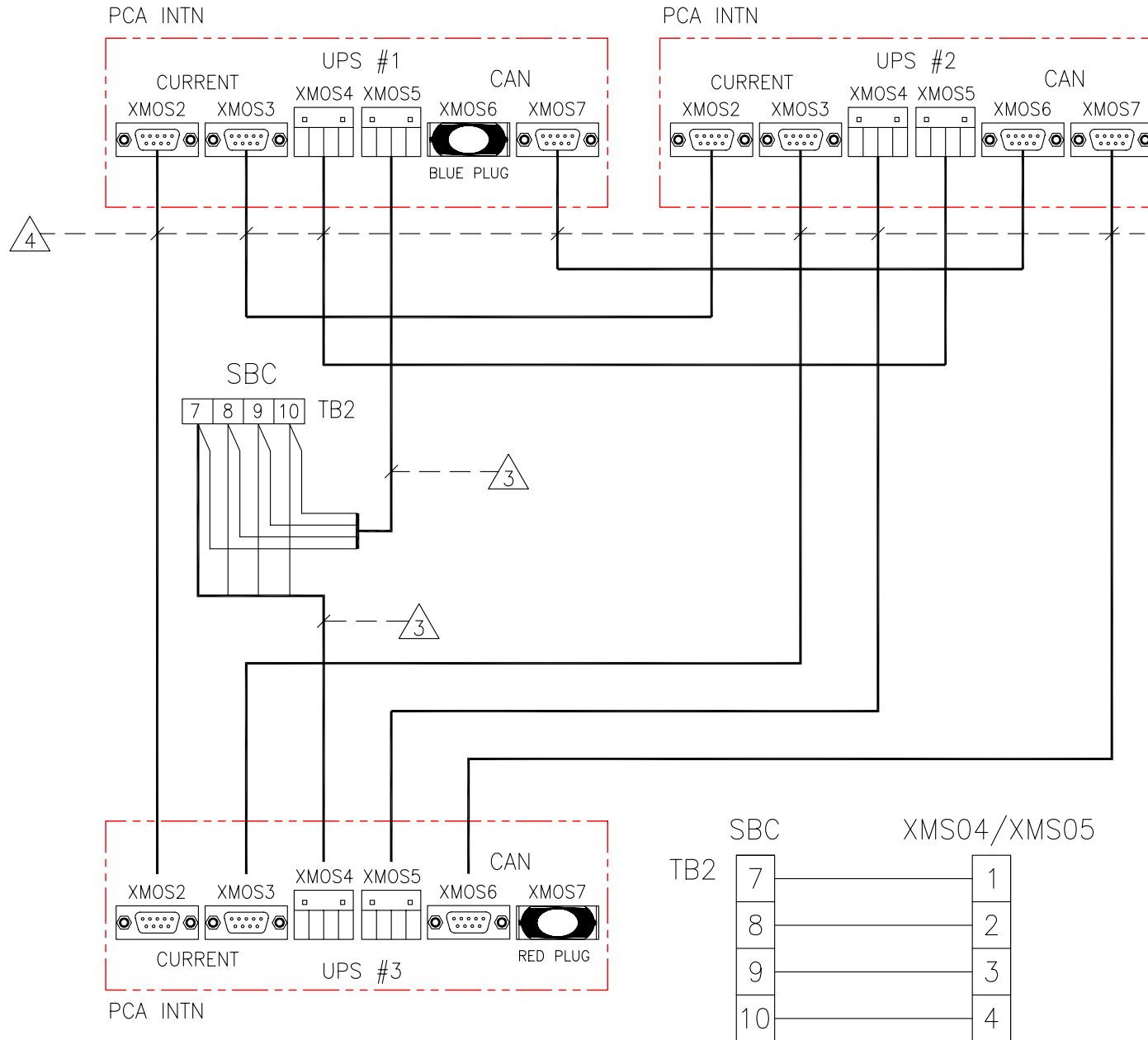

NOTES: UNLESS OTHERWISE SPECIFIED

1. INSTALLATION SHALL COMPLY WITH ALL APPLICABLE NATIONAL AND LOCAL CODES.
2. PLEASE REFER TO PRODUCT MANUALS FOR ADDITIONAL DETAILS.
3. CABLES SUPPLIED BY CUSTOMER.
4. THE CABLES SUPPLIED (33 FT) LIMIT THE DISTANCE BETWEEN THE UPS UNITS.

THIS DRAWING AND SPECIFICATIONS HEREIN ARE THE PROPERTY OF SCHNEIDER ELECTRIC AND SHALL NOT BE COPIED, REPRODUCED OR USED IN WHOLE OR IN PART, AS THE BASIS FOR THE MANUFACTURE OR SALE OF ITEMS WITHOUT WRITTEN PERMISSION FROM SCHNEIDER ELECTRIC. THIS DRAWING IS BASED UPON LATEST AVAILABLE INFORMATION AND IS SUBJECT TO CHANGE WITHOUT NOTICE.



TITLE:
 GALAXY 5000
 PARALLEL CONFIGURATION
 3 UPS SINGLE INPUT 2CB SBC
 INTERCONNECTIONS BETWEEN UPS UNITS TO SBC
 PROJECT: SUBMITTAL DRAWINGS SHEET 2 OF 2

DWG NO:	90-174804-00	REV.	0
DRAWN BY:	BALAMURUGAN	31-MAR-10	ANGLE
ENGINEER:	I. KENNEDY	21-FEB-08	PROJECTION
APPROVED BY:	B.SHERIDAN/F.DIOSA	21-FEB-08	N.A.