

NOTES:

1. INSTALLATION SHALL COMPLY WITH ALL APPLICABLE LOCAL AND NATIONAL CODES.
2. PLEASE REFER TO PRODUCT DOCUMENTATION FOR ADDITIONAL DETAILS.
3. DRAWING DEPICTS POWER AND CONTROL SYSTEM CONNECTIONS AND IS NOT REPRESENTATIVE OF PHYSICAL LAYOUT. PLEASE REFER TO MECHANICAL DRAWINGS FOR PHYSICAL LAYOUT.
- △ 4. SINGLE MAINS INSTALLATION IS A DEFAULT.
FOR DUAL MAINS OPTION REFER TO DRAWING #SUVTJP20KF2C1-WD.
5. CABLING PROVIDED BY OTHERS.
6. POWER WIRING AND CONTROL WIRING MUST BE IN SEPARATE CONDUITS.
- △ 7. THESE CONNECTIONS ARE APPLICABLE TO APC XR ENCLOSURE ONLY.

THIS DRAWING AND SPECIFICATIONS HEREIN ARE THE PROPERTY OF SCHNEIDER ELECTRIC AND SHALL NOT BE COPIED, REPRODUCED OR USED IN WHOLE OR IN PART, AS THE BASIS FOR THE MANUFACTURE OR SALE OF ITEMS WITHOUT WRITTEN PERMISSION FROM SCHNEIDER ELECTRIC. THIS DRAWING IS BASED UPON LATEST AVAILABLE INFORMATION AND IS SUBJECT TO CHANGE WITHOUT NOTICE.



TITLE: SMART-UPS VT, PARALLEL SYSTEM
INPUT: 200V AC, 3PH, SINGLE MAINS
OUTPUT: 200V AC, 20kVA N
1 MODULE CAPACITY
SYSTEM WIRING DIAGRAM

PROJECT: SUBMITTAL DRAWINGS SHEET 1 OF 1

DWG NO:	SUVTJP20KF1C1-WD	REV:	0
DRAWN:	BALAMURUGAN	04-MAY-09	ANGLE
ENGINEER:	T.YAMAMOTO	04-MAY-09	PROJECTION
APPROVED:	T.YAMAMOTO/J.SUN	04-MAY-09	N.A

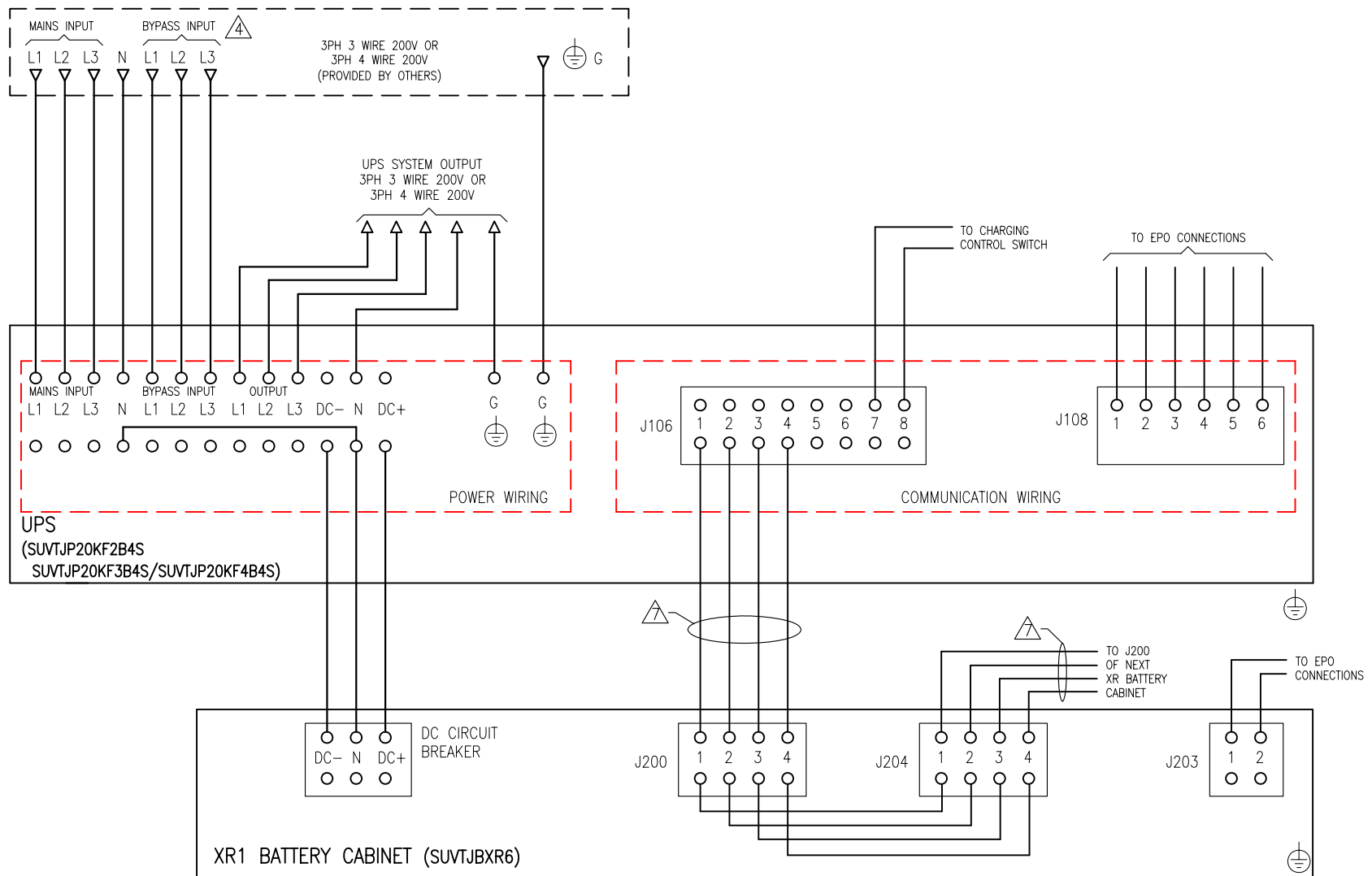

NOTES:

1. INSTALLATION SHALL COMPLY WITH ALL APPLICABLE LOCAL AND NATIONAL CODES.
2. PLEASE REFER TO PRODUCT DOCUMENTATION FOR ADDITIONAL DETAILS.
3. DRAWING DEPICTS POWER AND CONTROL SYSTEM CONNECTIONS AND IS NOT REPRESENTATIVE OF PHYSICAL LAYOUT. PLEASE REFER TO MECHANICAL DRAWINGS FOR PHYSICAL LAYOUT.
- △ 4. SINGLE MAINS INSTALLATION IS A DEFAULT.
FOR DUAL MAINS INSTALLATION THE REMOVABLE BUS LINKS IN UPS NEEDS TO BE REMOVED.
5. CABLING PROVIDED BY OTHERS.
6. POWER WIRING AND CONTROL WIRING MUST BE IN SEPARATE CONDUITS.
- △ 7. THESE CONNECTIONS ARE APPLICABLE TO APC XR ENCLOSURE ONLY.

THIS DRAWING AND SPECIFICATIONS HEREIN ARE THE PROPERTY OF SCHNEIDER ELECTRIC AND SHALL NOT BE COPIED, REPRODUCED OR USED IN WHOLE OR IN PART, AS THE BASIS FOR THE MANUFACTURE OR SALE OF ITEMS WITHOUT WRITTEN PERMISSION FROM SCHNEIDER ELECTRIC. THIS DRAWING IS BASED UPON LATEST AVAILABLE INFORMATION AND IS SUBJECT TO CHANGE WITHOUT NOTICE.



TITLE: SMART-UPS VT, PARALLEL SYSTEM
 INPUT: 200V AC, 3PH, DUAL MAINS
 OUTPUT: 200V AC, 20KVA N
 1 MODULE CAPACITY
 SYSTEM WIRING DIAGRAM

PROJECT: SUBMITTAL DRAWINGS SHEET 1 OF 1

DWG NO:	SUVTJP20KF2C1-WD	REV:	0
DRAWN:	BALAMURUGAN	04-MAY-09	ANGLE
ENGINEER:	T.YAMAMOTO	04-MAY-09	PROJECTION
APPROVED:	T.YAMAMOTO/J.SUN	04-MAY-09	N.A