

POWER CIRCUIT

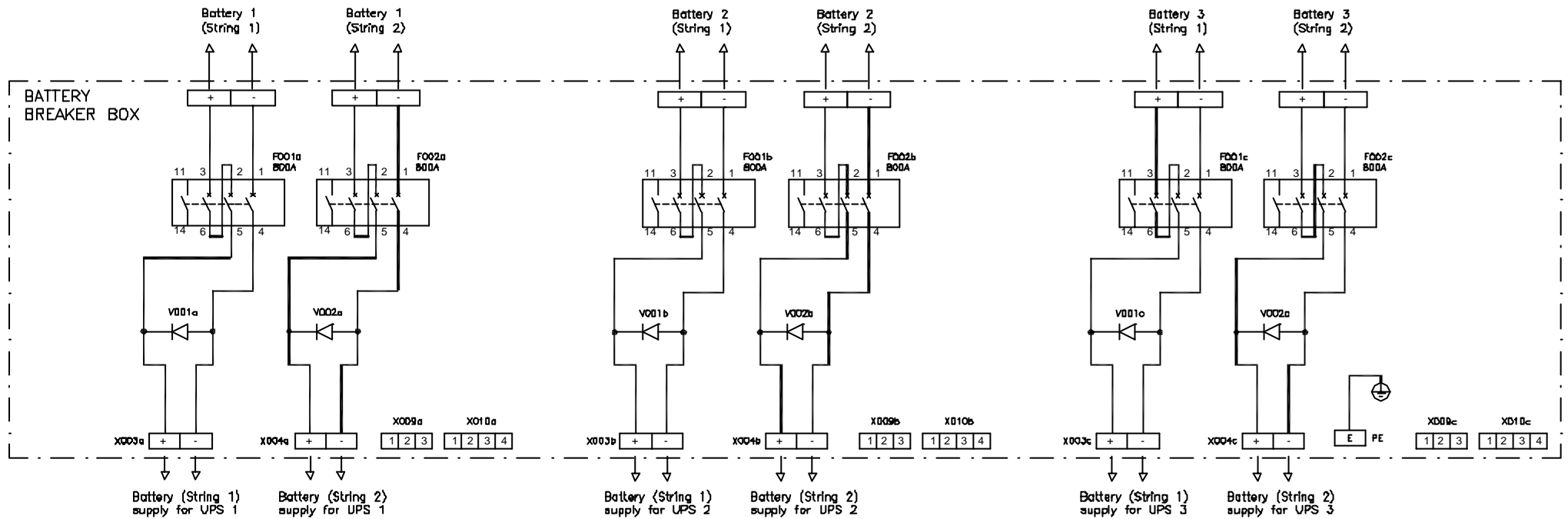

CONTROL CIRCUIT

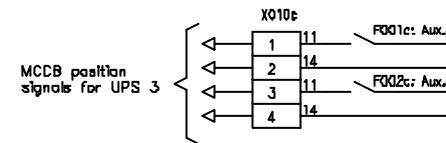
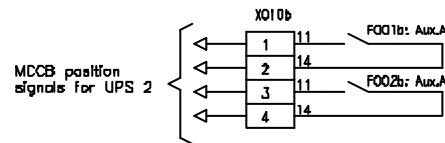
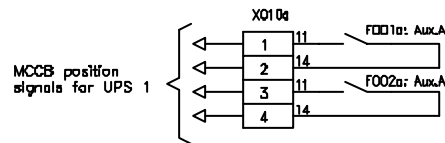
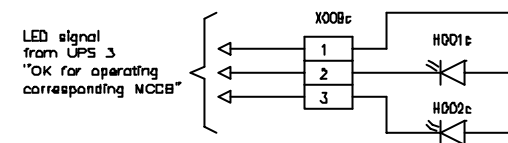
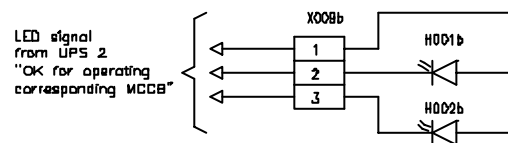
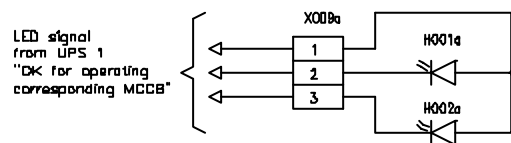

THIS DRAWING AND SPECIFICATIONS HEREIN ARE THE PROPERTY OF AMERICAN POWER CONVERSION AND SHALL NOT BE COPIED, REPRODUCED OR USED IN WHOLE OR IN PART, AS THE BASIS FOR THE MANUFACTURE OR SALE OF ITEMS WITHOUT WRITTEN PERMISSION FROM APC. THIS DRAWING IS BASED UPON LATEST AVAILABLE INFORMATION AND IS SUBJECT TO CHANGE WITHOUT NOTICE.

TITLE: SILICON 480kW UPS
ELECTRICAL SCHEMATIC FOR
BATTERY BREAKER BOX
400V, 3 MOD N+1

DWG NO: SBBJ480KHR3-ES
DRAWN: C.KRISHNAMOORTHY
CHECKED: MILIND S/K KATD
ENGINEER: S WACH

REV: -
21/03/02
21/03/02
SCALE: NTS
PROJECTION



PROJECT: SUBMITTAL DRAWINGS SHEET 1 OF 1