

FRONT

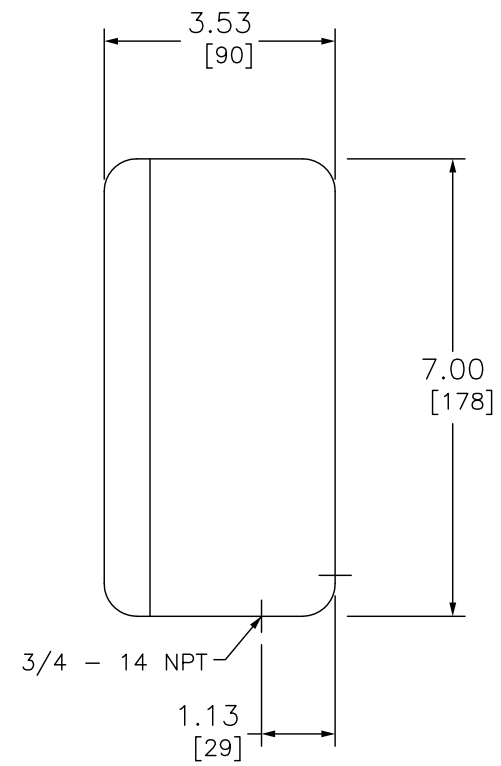

RIGHT

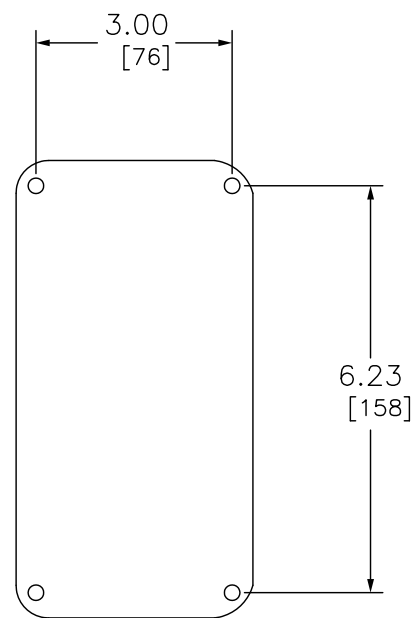

BACK

DUAL DIMENSIONS: INCHES
MILLIMETERS

CONTROL STATION + OPERATORS



DWG# 9001KYK32
NO.