

PANEL THICKNESS E DIM		NUMBER OF GASKET
IN	MM	
.06	2	4
.13	3	3
.19	5	2
.25	6	1

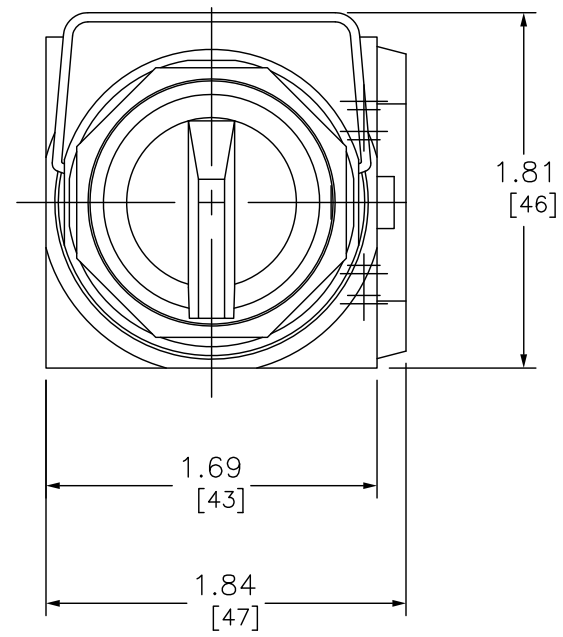

FRONT

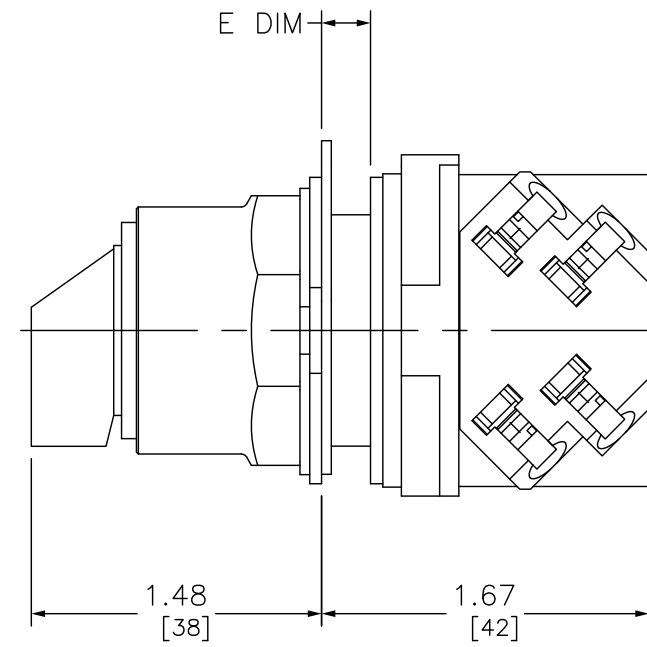

RIGHT

DUAL DIMENSIONS: INCHES
MILLIMETERS

SELECTOR SWITCH 600VAC 10A 30MM TYPE K



DWG# 9001KS11BH2
NO.