

PANEL THICKNESS E DIM		NUMBER OF GASKET
IN	MM	
.06	2	4
.13	3	3
.19	5	2
.25	6	1

A DIM					
DEPRESSED (STOP)		MIDWAY (NEUTRAL)		EXTENDED (START)	
IN	MM	IN	MM	IN	MM
1.38	35	1.85	47	2.37	60

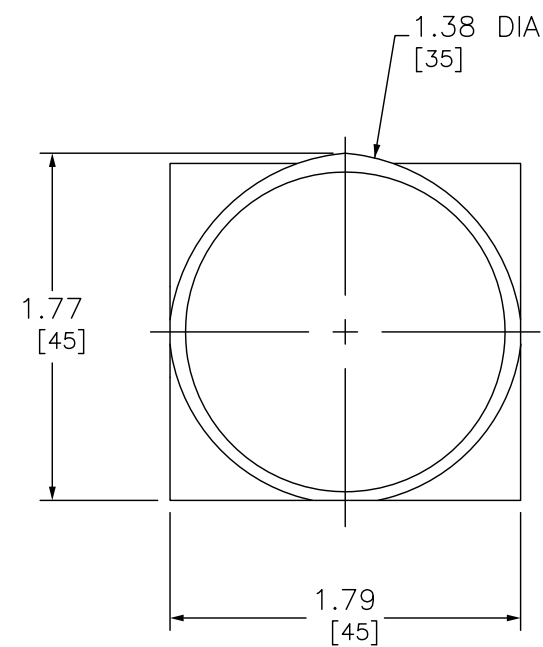

FRONT

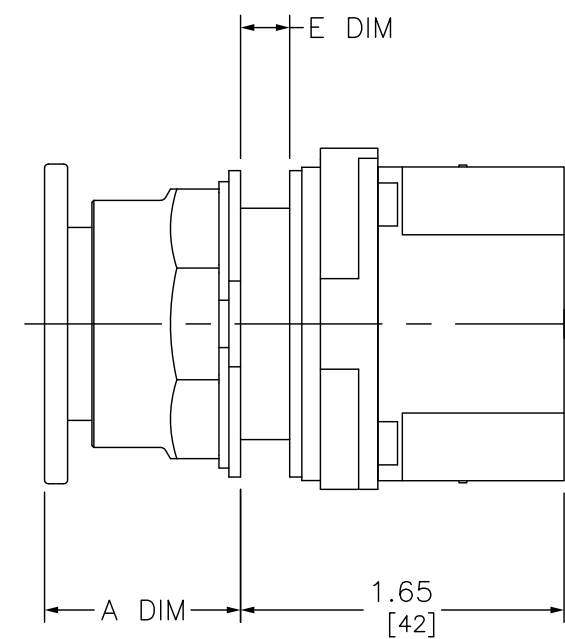

RIGHT

DUAL DIMENSIONS: INCHES  
MILLIMETERS

PUSH BUTTON 600VAC 10A 30MM T-K



DWG# 9001KR8RH25  
NO.