

CATALOG NUMBER	PRIMARY VOLTAGE	SECONDARY VOLTAGE	50/60 Hz 1 PHASE		APPROXIMATE WEIGHT (Lbs/Kg)
			UL/cUL/CSA/NOM RATINGS (VA)	CE RATINGS (VA)	
9070TF1500D3	208	120	1500	1000	34.7 / 15.7
9070TF1500D5	550	110	1500	1000	33.9 / 15.3
	575	115			
	600	120			

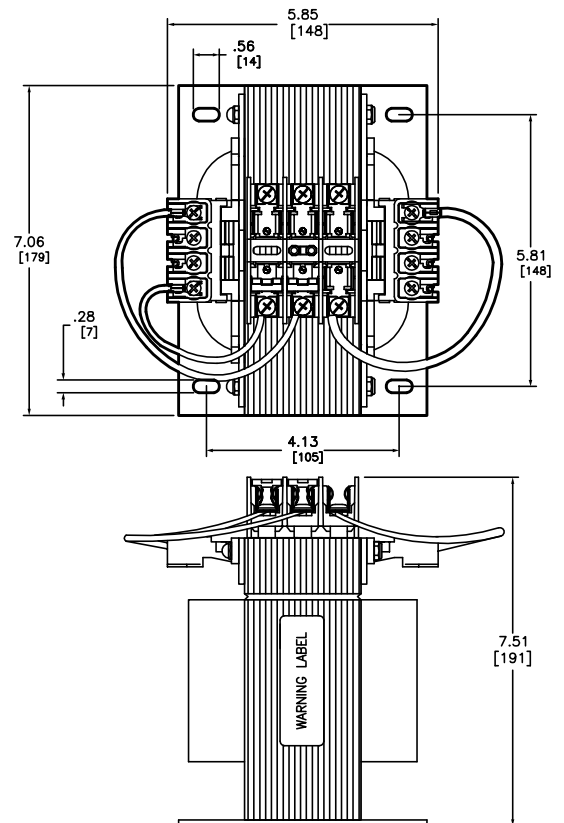

FILES/STANDARDS:
 UL/cUL FILE: E61239
 CSA FILE: LR37055
 CE: TUV CERTIFIED TO 61558
 NOM 117

1500VA--CONTROL POWER TRANSFORMER
 9070 TYPE TF
 CATALOG NUMBERS: FROM CHART



DWG# 5946
 NO.