

BUCK AND BOOST TRANSFORMER
 3.0 KVA 1Ø 60HZ
 120 X 240V PRIMARY

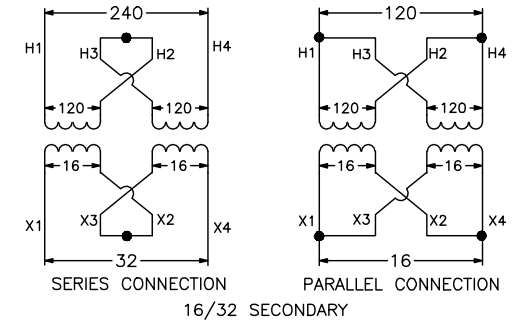
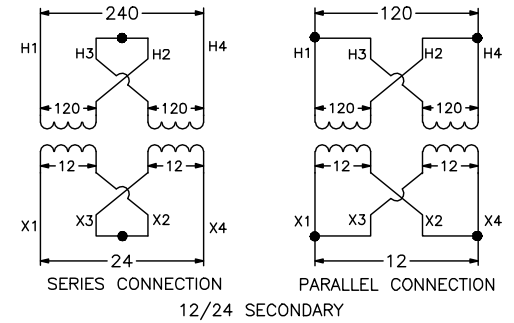

SEISMIC QUALIFICATION:
 TO BE COMPLIANT WITH THE SEISMIC REQUIREMENTS OF ASCE/SEI7, THIS UNIT HAS BEEN QUALIFIED BY SHAKE TABLE TESTING THROUGH SELF CERTIFICATION TO ICC ES AC156. THE ENCLOSURE SHOWN ABOVE IS 9A. CONTACT YOUR LOCAL SCHNEIDER ELECTRIC/SQUARE D REPRESENTATIVE FOR RELATED QUESTIONS.

NOTES:
 UL/CUL LISTED
 NEMA 3R NON-VENTILATED ENCLOSURE
 COPPER WOUND
 185°C INSULATION SYSTEM FOR 115°C RISE
 EPOXY-RESIN ENCAPSULATED

DUAL DIMENSIONS: INCHES
 MILLIMETERS

KVA	CATALOG NUMBERS		TEMP. RISE	WGT LBS
	12/24 SECONDARY	16/32 SECONDARY		
3.0	3S43F	3S46F	115°C	59.5

BUCK AND BOOST TRANSFORMERS
 3.0 KVA 1PH 60HZ
 120 X 240V PRIMARY



DWG# 3621
 No.