

## Line differential protection stages in Vamp 59

The VAMP 59 is a user-friendly differential protection relay especially suitable for sub-transmission overhead lines, medium voltage cables and intermediate transformers. The back-up functions include overcurrent and earth fault protection with three-pole auto reclosing.

There are two line differential protection stages in the VAMP 59, Ldl> (87L) and Ldl>> (87L), enabling the user to configure new protection elements and to create new triggering conditions to the disturbance recorder.

The Ldl> protection stage represents phase-segregated protection based on current (vector) differential. Combination of both phase and magnitude differential is used to determine operation. The differential element takes a sampled version of the instantaneous current waveform as its local input and compares it with a corresponding current from the remote end. The signal is converted to magnitude and to angle information for comparison. The threshold characteristics are biased for CT saturation. Bias current calculation is used in this stage. Bias current describes the average current flow in the protected line. Bias and differential currents are calculated individually for each phase.

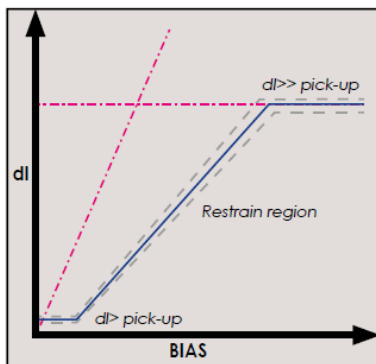

Phase segregated protection is based on current (vector) differential.

$$I_b = \frac{|\bar{I}_{RELAY1}| + |\bar{I}_{RELAY2}|}{2}$$

$$I_d = |\bar{I}_{RELAY1} - \bar{I}_{RELAY2}|$$

Example case without in-zone transformer

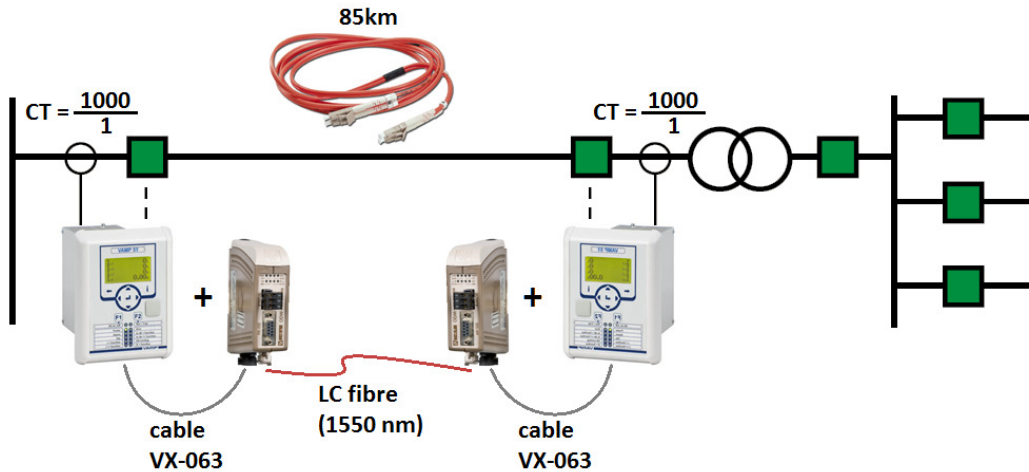

Figure 1. Following application requires 2 x VAMP 59 units, 2 x fibre converters and 2 x communication cables between the relay and converter. When protected distance is 80km or more the used link between the protection units has to be 1550nm single mode fibre (LC).

How to select correct type of fibre converter? VAMP has tested converter units of two different manufacturers. With MOXA converters it is possible to establish connection up to 40km. With WESTERMO converters it is possible to reach up to 120km. Connection cable between the relay and fibre -converter has to be selected according the chosen converter type.

Accessories :		VX -cable according the selected converter	Note
Order Code	Explanation		
<b>Base unit</b> →	VSE001 Fiber optic Interface Module		Max. distance 1 km
	3P032 WESTERMO ODW-720-F1	↓	(Base module)
	3P033 WESTERMO SLC20 (1310 nm)		Max. distance 20 km
	3P034 WESTERMO SLC40 (1310 nm)		Max. Distance 40 km
	3P035 WESTERMO SLC80 (1550 nm)		Max. distance 80 km
	3P036 WESTERMO SLC120 (1550 nm)		Max. distance 120 km
<b>Transceiver unit</b> →	VX063 RS232 converter cable for WESTERMO ODW-720-F1		Cable length 3m
	3P014 MOXA TCF-90		Max. distance 40 km
	VX048 RS232 converter cable for MOXA TCF-90		Cable length 3m
	3P022 MOXA TCF-142-S-ST		Max. distance 40 km
	VX062 RS232 converter cable for MOXA TCF-142-S-ST		Cable length 3m

Figure 2. Fibre -converter selection table. Biggest difference between MOXA and WESTERMO is that WESTERMO has separate base unit and transceiver unit.

Since distance in this application is more than 80km there is only one possible option to be selected (WESTERMO SLC120). Link above is selected from the ordering code of VAMP 59.

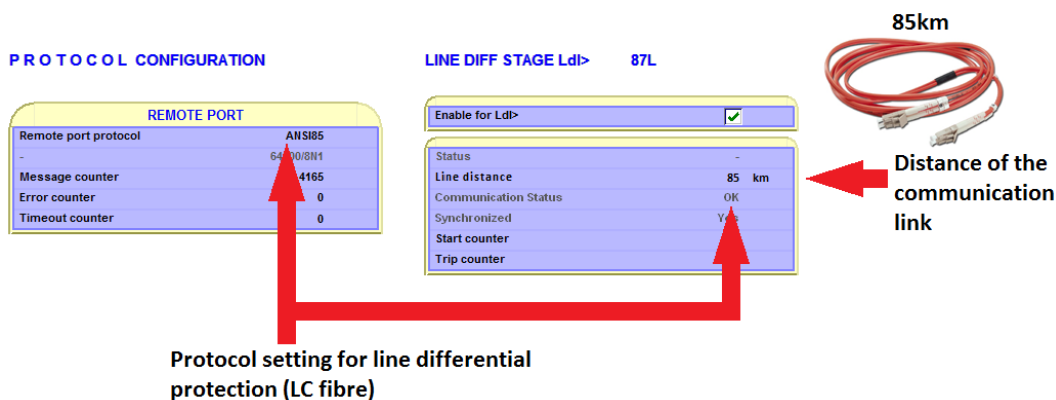

Figure 3. When physical communication link is established the software has to be set to communicate correctly.

Fibre -converters are connected to the remote port of the relay. When wiring between the relay units is complete and fibre connection is established the software has to be configured. Remote port protocol has to be selected as ANSI85. When communication link is ok and correct remote port protocol is selected “Communication status” in differential stage menu turns to OK -state. Message counter in p r o t o c o l configuration menu starts to run and error counter should remain as zero.

Movement of the light in fibre has its own delay therefore it is necessary to set “Line distance” correctly in line differential menu. This gives better accuracy to the calculation of differential -and BIAS currents.

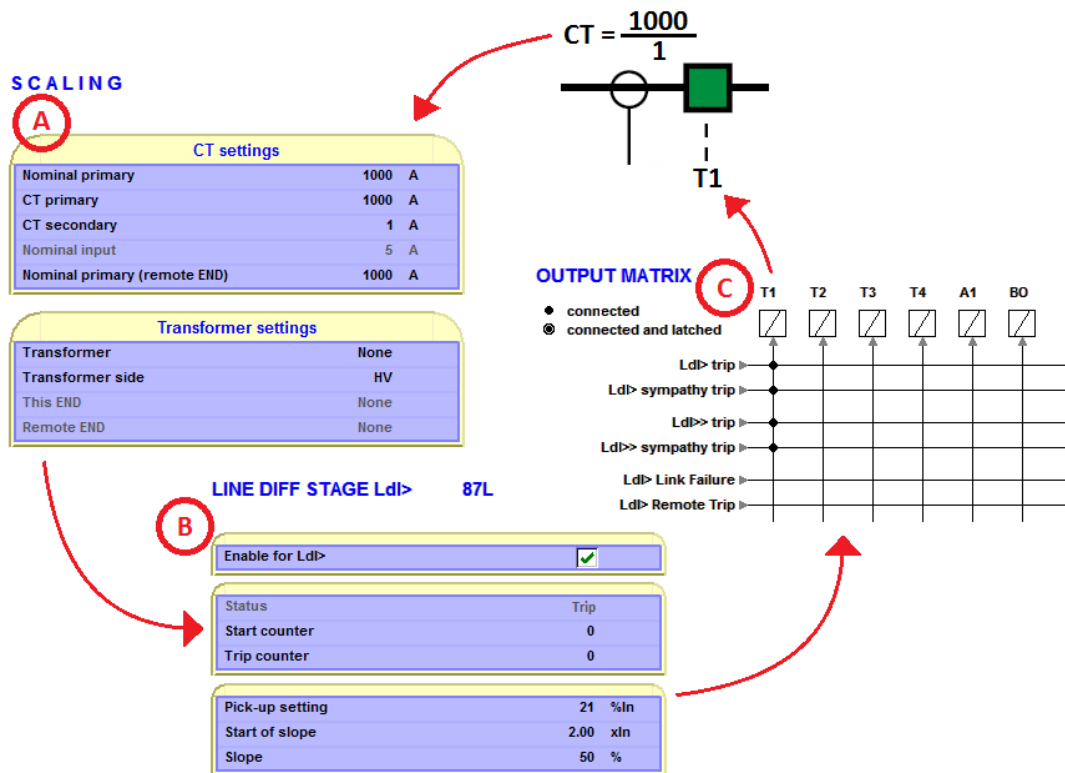

Figure 4. CT setting, stage settings and matrix settings

**A:** When there is no transformer inside the protected zone the “Nominal primary” setting has to be same as the primary side value of the current transformer. Nominal primary of other end has to be set correctly as well to ensure correct calculation.

**B:** Protection stages Ldl> and Ldl>> do trip according the CT and transformer settings. In this application there is no transformer. When set value of line differential stage exceeds the stage will trip.

**C:** Tripping of the stage causes the horizontal line in output matrix to lid. In this application tripping of stage Ldl> and Ldl>> do activate the tripping contact T1. Contact T1 is connected to the open coil of the breaker and therefore differential fault opens the breaker when fault occurs.

Ldl> sympathy trip is a trip command from the other end that is sent to the relay through fiber, this can be used to trip both ends if even one of the relays do see fault.

### Fault clearing

The typical fault clearing time in a fault situation is approximately 35ms (including the tripping contact). Operation time very close to the curve is not as fast. When 2<sup>nd</sup> or 5<sup>th</sup> harmonic blocking is enabled the operation time of line differential stage is about 5ms slower.

## Other features

### 1. Frequency adaptation

VTo secondary	57.735 V
Voltage meas. mode	3LI/LIly
Frequency adaptation mode	Fixed
Adapted frequency	50.0 Hz

Figure 5. Frequency adaptation mode has to be set as “Fixed” when line differential protection is used.

The frequency adaptation mode should be set as fixed when using the line differential protection stages. Adapted frequency should be set to same as the frequency of the grid.

#### NOTICE

Frequency protection stages cannot be used while frequency adaptation mode is set as “Fixed”.

### 2. Second harmonic blocking

2.harm. block enable	<input checked="" type="checkbox"/>
2.harm. block limit	5 %

Figure 6. Second harmonic blocking can be enabled in the Ldl> and Ldl>> menus.

Second harmonic blocking might be needed when there is a transformer inside the protected line. Transformer can cause great magnetizing current to the side of incomer.

Big through faults outside the protected zone might cause saturation to the CT and this might cause false tripping as well. Second harmonic blocking can be used to avoid this type of false trips.

### 3. Fifth harmonic blocking

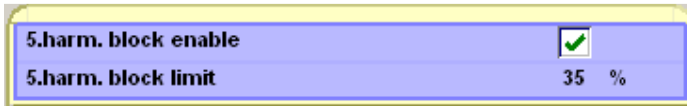

Figure 7. Fifth harmonic blocking can be enabled in the Ldl> and Ldl>> menus.

Sudden load drop might cause overvoltage situation. Overvoltage causes over-excitation to the transformer. Transformer over-excitation is another possible cause of differential relay undesired operation. The use of an additional fifth-harmonic restraint can prevent such operations. Transformer over-excitation causes about 20-50% of fifth harmonic component to the measured phase currents.

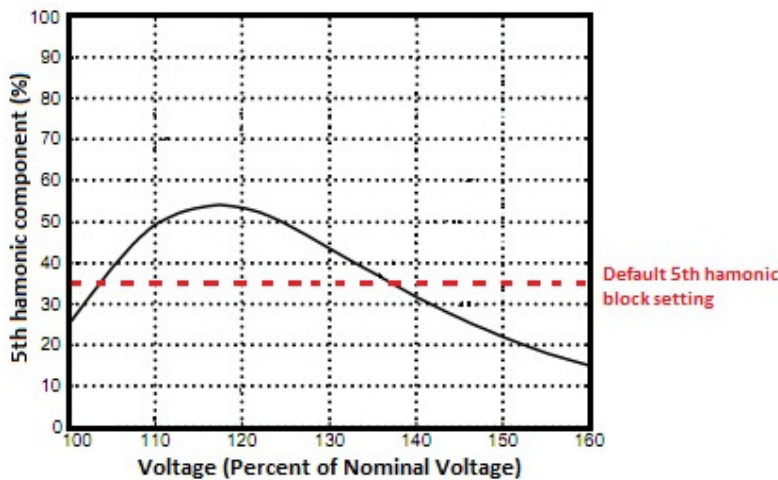

Figure 8. Harmonic content of transformer exciting current as a function of the applied voltage

5<sup>th</sup> harmonic blocking limit is set to 35% of the fundamental component as a default. This value can be used in most of the applications.

## 4. Transformer settings

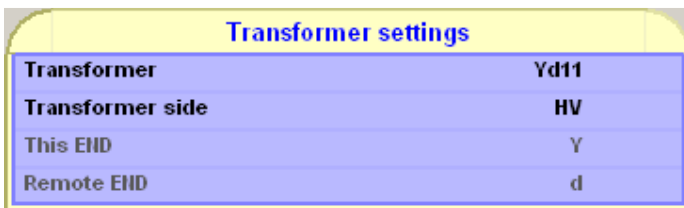

Figure 9. Transformer settings in the scaling menu of the relay

When there is transformer in the protected line, the transformer connection group has to be configured. The same applies to the relays at both ends of the protected line. Side of the transformer has to be selected as well to ensure correct calculation.

### Shared POC messages between the line differential relays

Vamp 59 relays located at both end of the protected cable can share up to 16 POC-messages used for trip, object status, interlocking transfer and auto reclosing.

ANSI85 communication has to be enabled to be able to share POC-signals between relays.

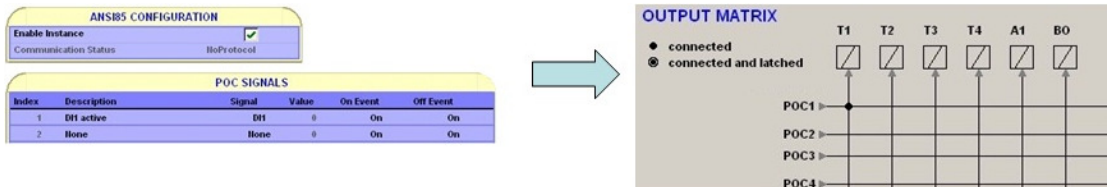

Figure 10. A total of 16 self-programmable messages can be shared between Vamp 59 units. Signals transferring these POC-messages take approximately 10-20ms excluding the DI/DO activation delay.

**Schneider Electric**

35 rue Joseph Monier  
 92506 Rueil-Malmaison  
 FRANCE  
 Phone: +33 (0) 1 41 29 70 00  
 Fax: +33 (0) 1 41 29 71 00  
[www.schneider-electric.com](http://www.schneider-electric.com)

© 2012 Schneider Electric Industries SAS - All rights reserved.  
 Electrical equipment should be installed, operated, serviced,  
 and maintained only by qualified personnel. No responsibility  
 is assumed by Schneider Electric for any consequences  
 arising out of the use of this material.

Publishing: 4/2013