

THE INFORMATION CONTAINED IN THIS DRAWING IS THE SOLE PROPERTY OF AMERICAN POWER CONVERSION. ANY REPRODUCTION IN PART OR WHOLE WITHOUT THE WRITTEN PERMISSION OF AMERICAN POWER CONVERSION IS PROHIBITED

REVISIONS				
REV	ALFA	DESCRIPTION	DATE	APPR
01		INITIAL RELEASE	12/OCT/2011	MP

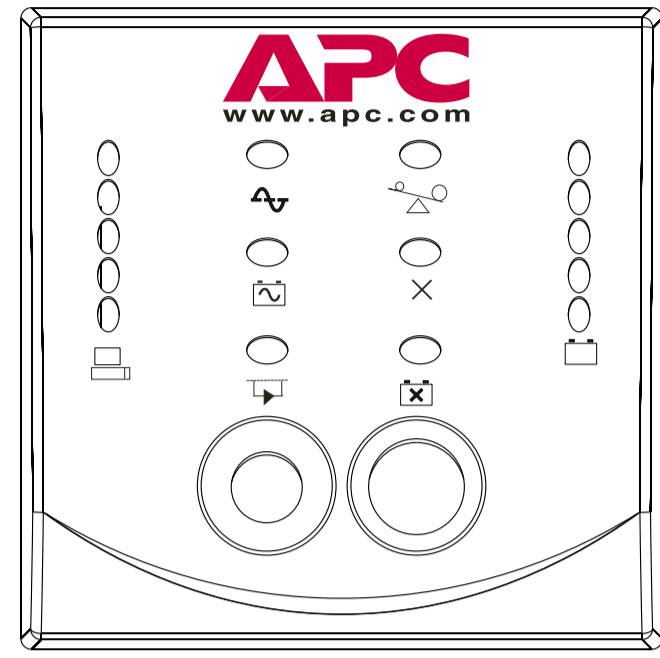

**CONTROL PANEL**  
(Enlarged view)

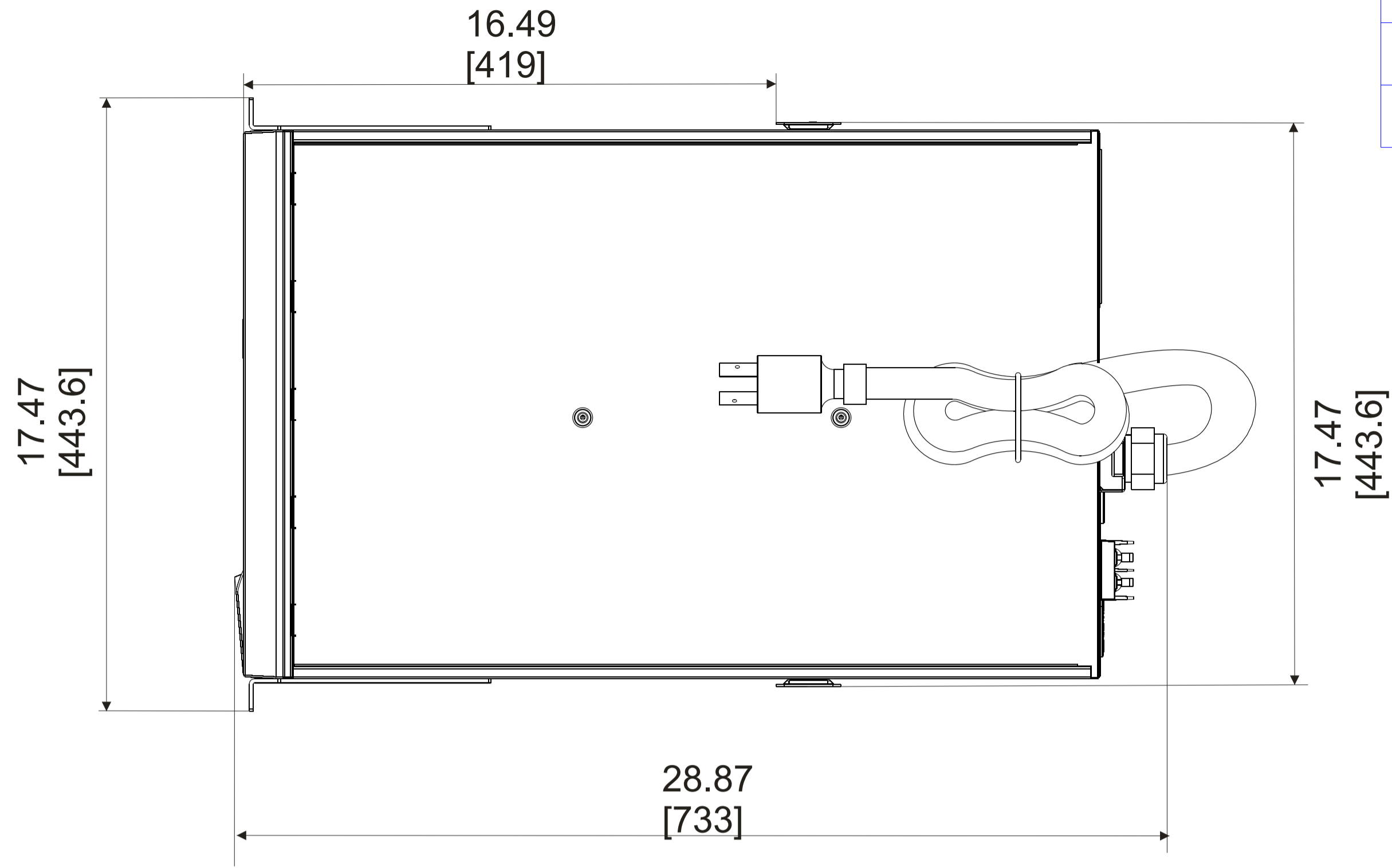

**UPS Top view**  
(WITHOUT RACK)

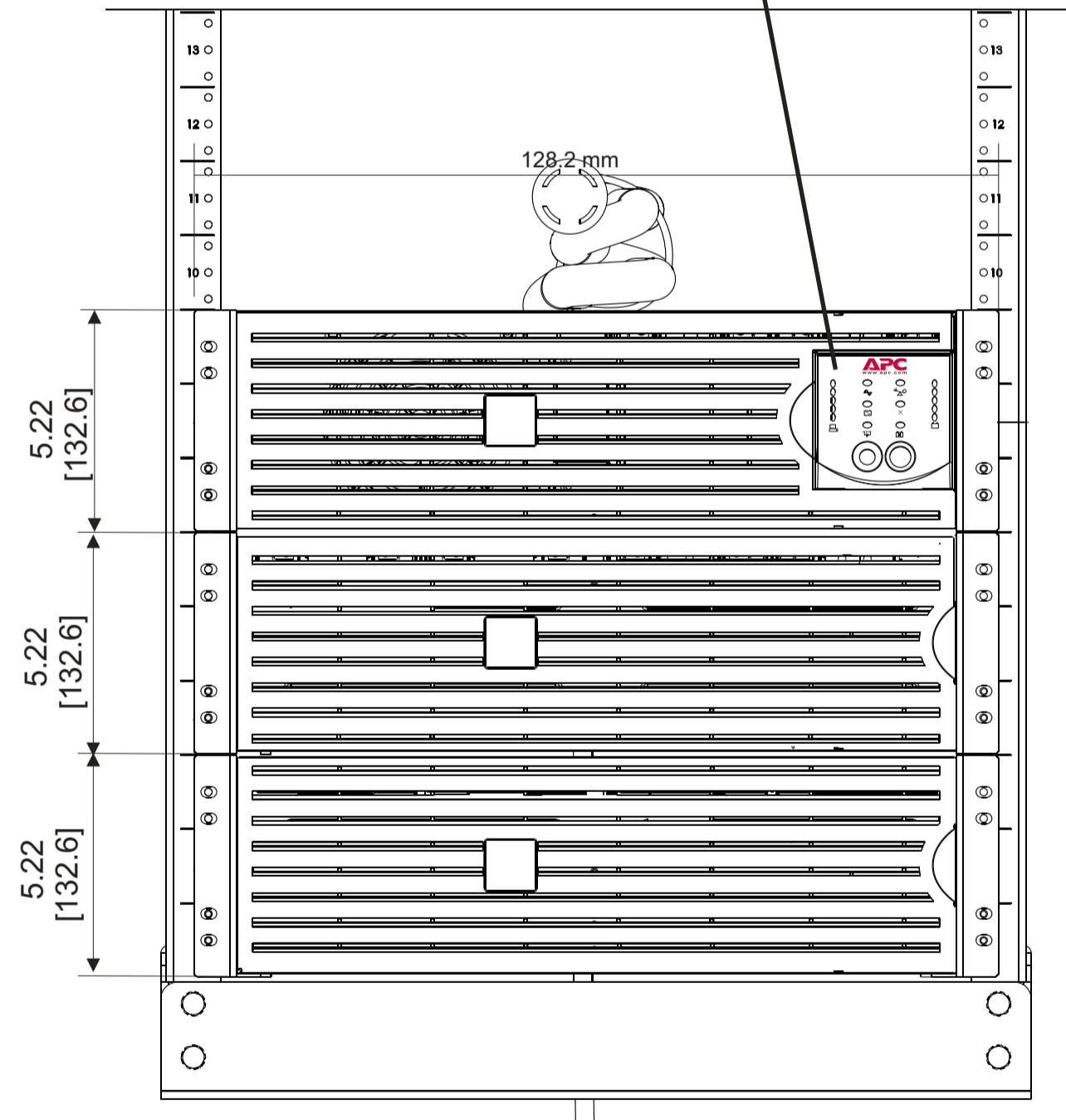

**Front view**  
(WITH RACK)

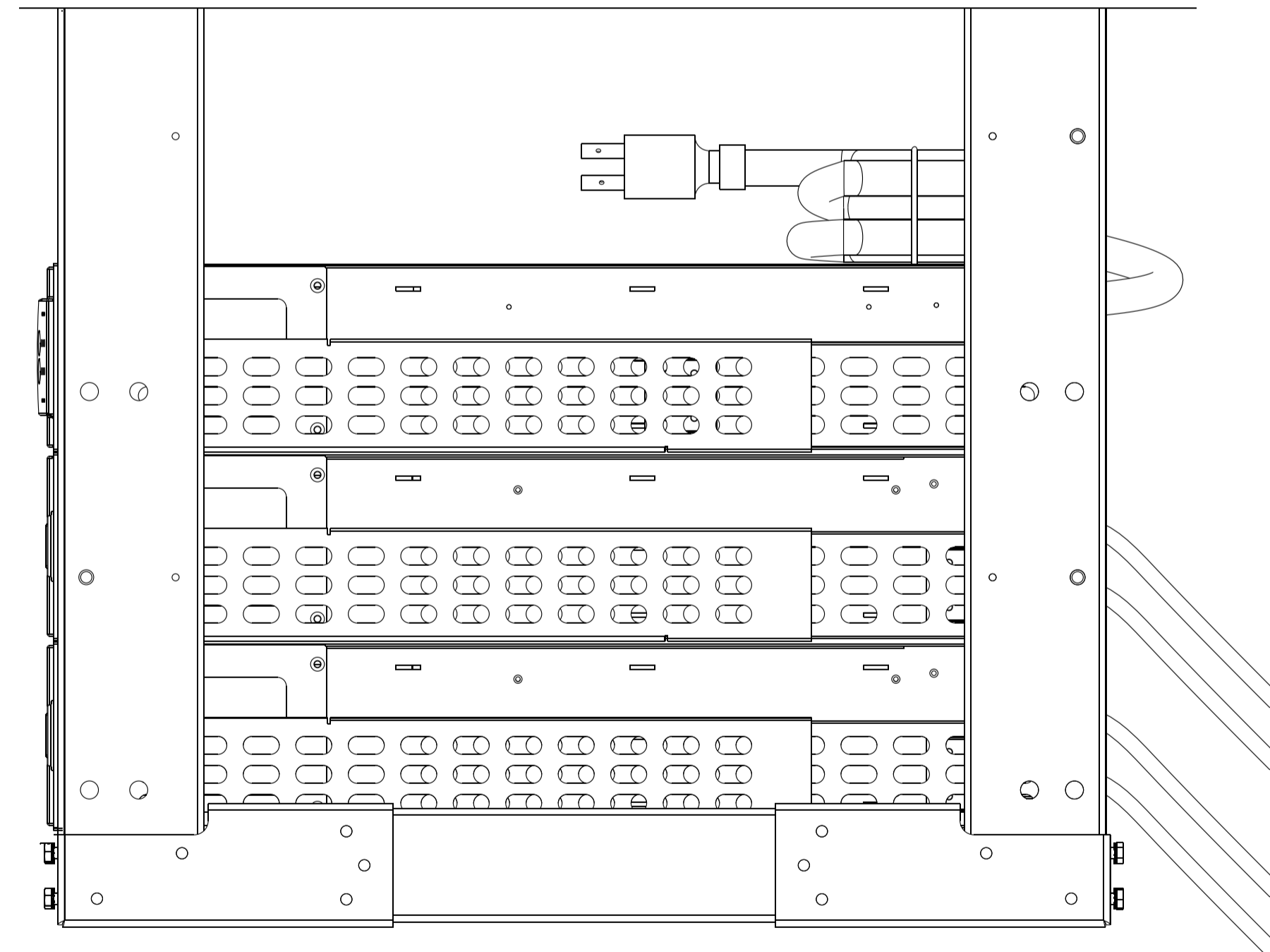

**Side view**  
(WITH RACK)

- NOTES:**
1. INSTALLATION SHALL COMPLY WITH ALL APPLICABLE LOCAL AND NATIONAL CODES.
  2. PLEASE REFER TO PRODUCT MANUALS FOR ADDITIONAL DETAILS.
  3. ALL DIMENSIONS ARE IN INCHES [MILLIMETERS].

ITEM NO.	APC PART NUMBER	VENDOR PART NUMBER	DESCRIPTION/MATERIAL/SPECIFICATION		QTY.
PARTS LIST					
	ENGINEER Mahesh	12/Oct/2011	 AMERICAN POWER CONVERSION KALYANI PLATINA, BLOCK 1, NO. 24, EPIP ZONE, PHASE 2, WHITEFIELD, BANGALORE-560066, INDIA		
	CHECKED Prahlah	12/Oct/2011			
	ISSUED XXXX	XX/XXX/XX			
MATERIAL :	SEE NOTES	ARCHIVE MEDIA CODE 0S-4978_REV01.cdr	PROJECT	CHIRU	
FINISH :	SEE NOTES	THIRD ANGLE PROJECTION	SIZE D	FSCM NO.	DWG. NO. 0S-4978
DO NOT SCALE DRAWING			SCALE NTS	FIRST USED ON	REV 01 Sheet 1 of 3

THE INFORMATION CONTAINED IN THIS DRAWING IS THE SOLE PROPERTY OF AMERICAN POWER CONVERSION. ANY REPRODUCTION IN PART OR WHOLE WITHOUT THE WRITTEN PERMISSION OF AMERICAN POWER CONVERSION IS PROHIBITED

REVISIONS				
REV	ALFA	DESCRIPTION	DATE	APPR
01		INITIAL RELEASE	12/OCT/2011	MP

**PDU PLATE  
(ENLARGED VIEW)**

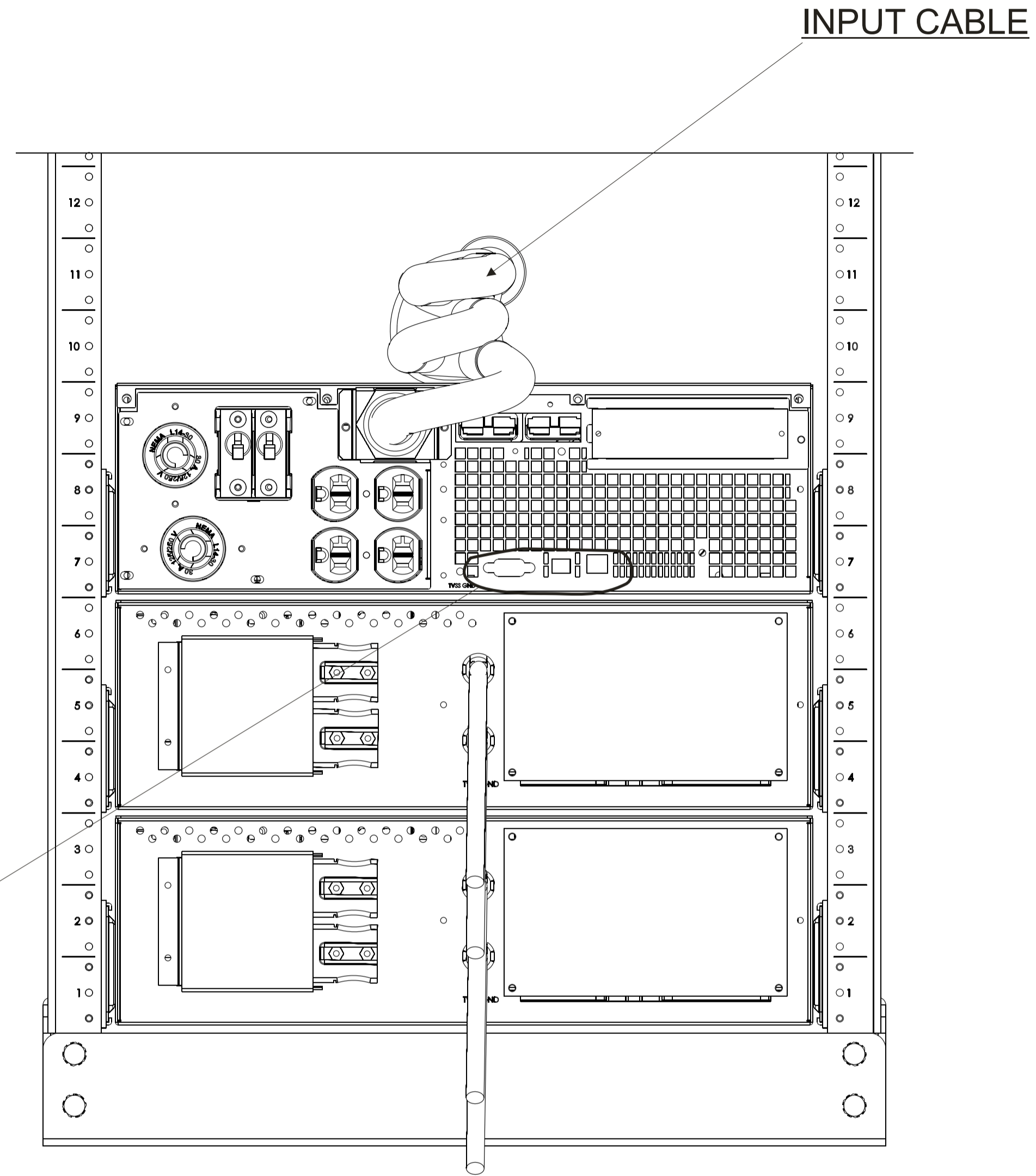
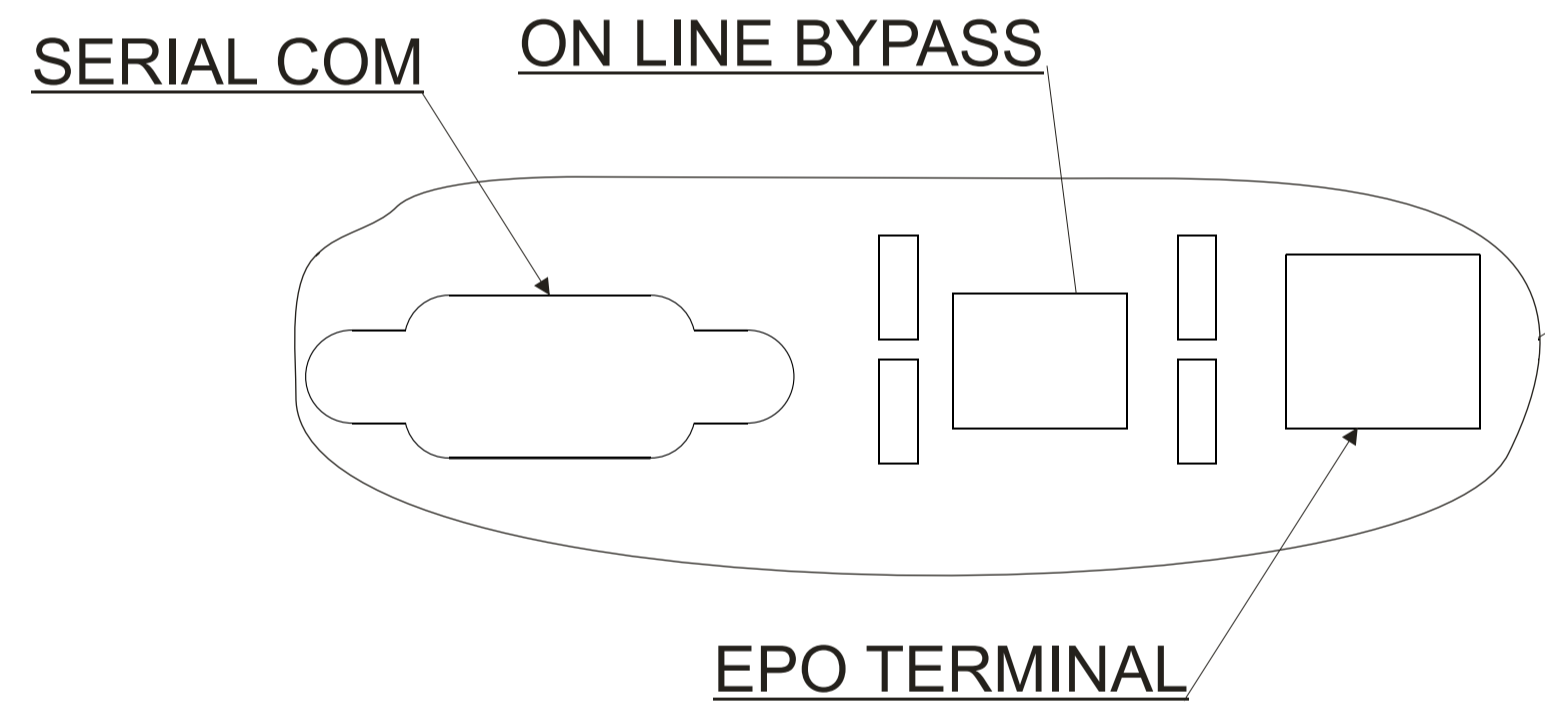
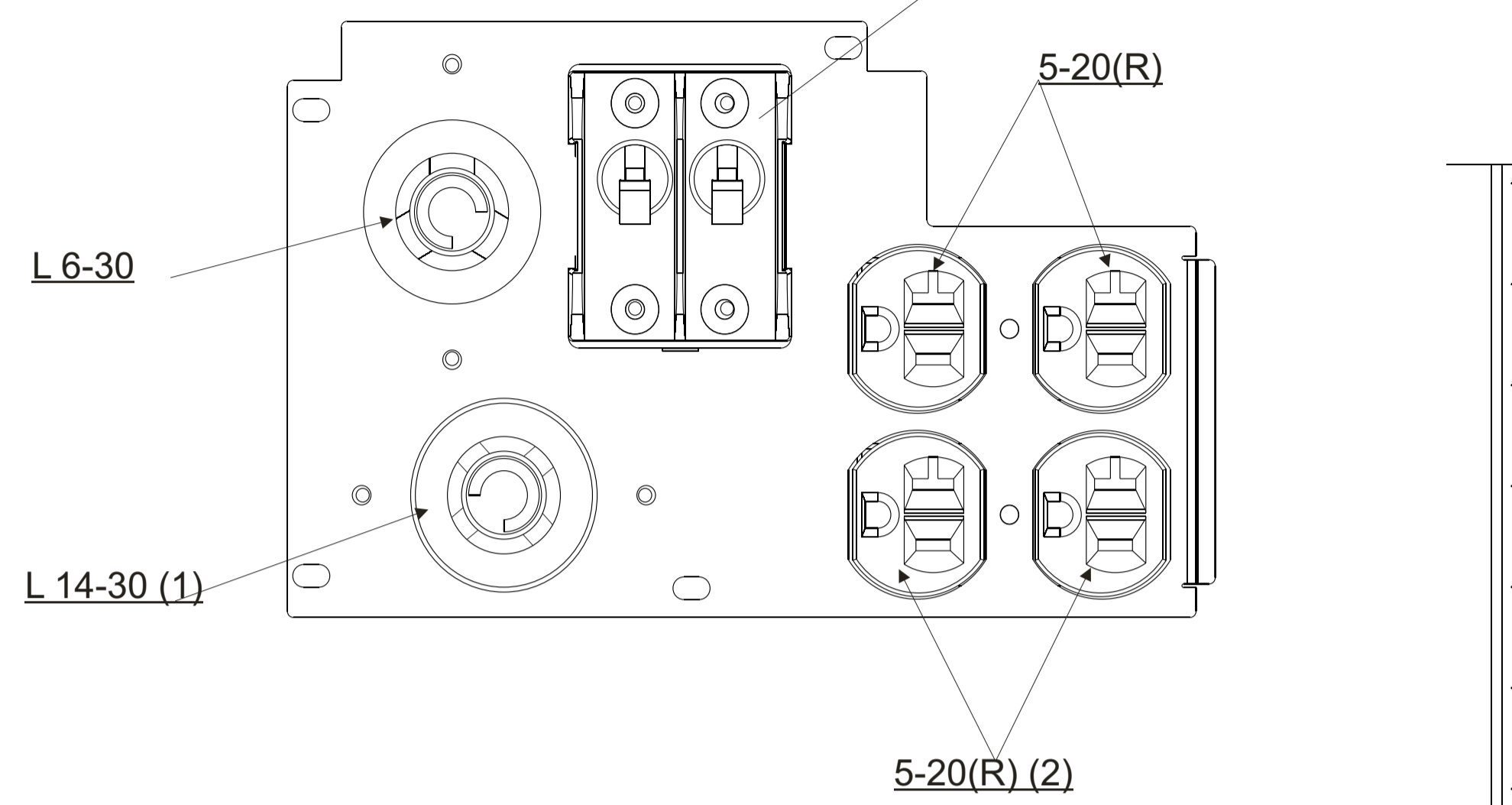

**REAR VIEW**

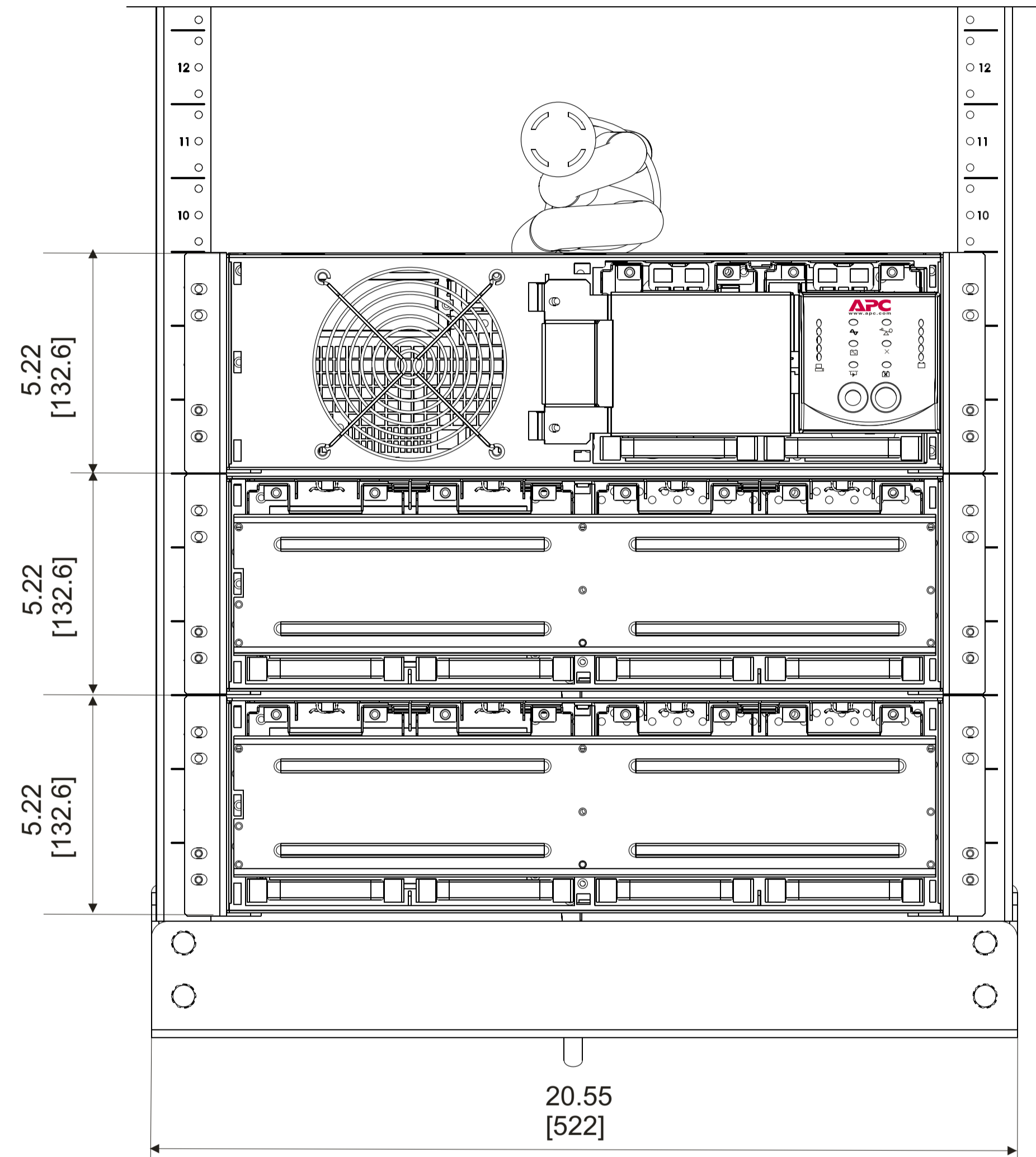

**FRONT VIEW  
(BEZEL REMOVED)**

- NOTES:**
1. INSTALLATION SHALL COMPLY WITH ALL APPLICABLE LOCAL AND NATIONAL CODES.
  2. PLEASE REFER TO PRODUCT MANUALS FOR ADDITIONAL DETAILS.
  3. ALL DIMENSIONS ARE IN INCHES [MILLIMETERS].

ITEM NO.	APC PART NUMBER	VENDOR PART NUMBER	DESCRIPTION/MATERIAL/SPECIFICATION	QTY.
PARTS LIST				
	ENGINEER Mahesh	12/Oct/2011	 AMERICAN POWER CONVERSION KALYANI PLATINA, BLOCK 1, NO.24, EPIP ZONE, PHASE 2, WHITEFIELD, BANGALORE-560066, INDIA	
	CHECKED Prahlad	12/Oct/2011		
	ISSUED XXXX	XX/XXX/XX		ITEM DIAGRAM_SINGLE LINE MECHANICAL CHIRU
MATERIAL :	SEE NOTES	ARCHIVE MEDIA CODE 0S-4978_REV01.cdr	PROJECT CHIRU	
FINISH :	SEE NOTES	THIRD ANGLE PROJECTION	SIZE D	FSCM NO. DWG. NO. 0S-4978
DO NOT SCALE DRAWING			SCALE NTS	FIRST USED ON

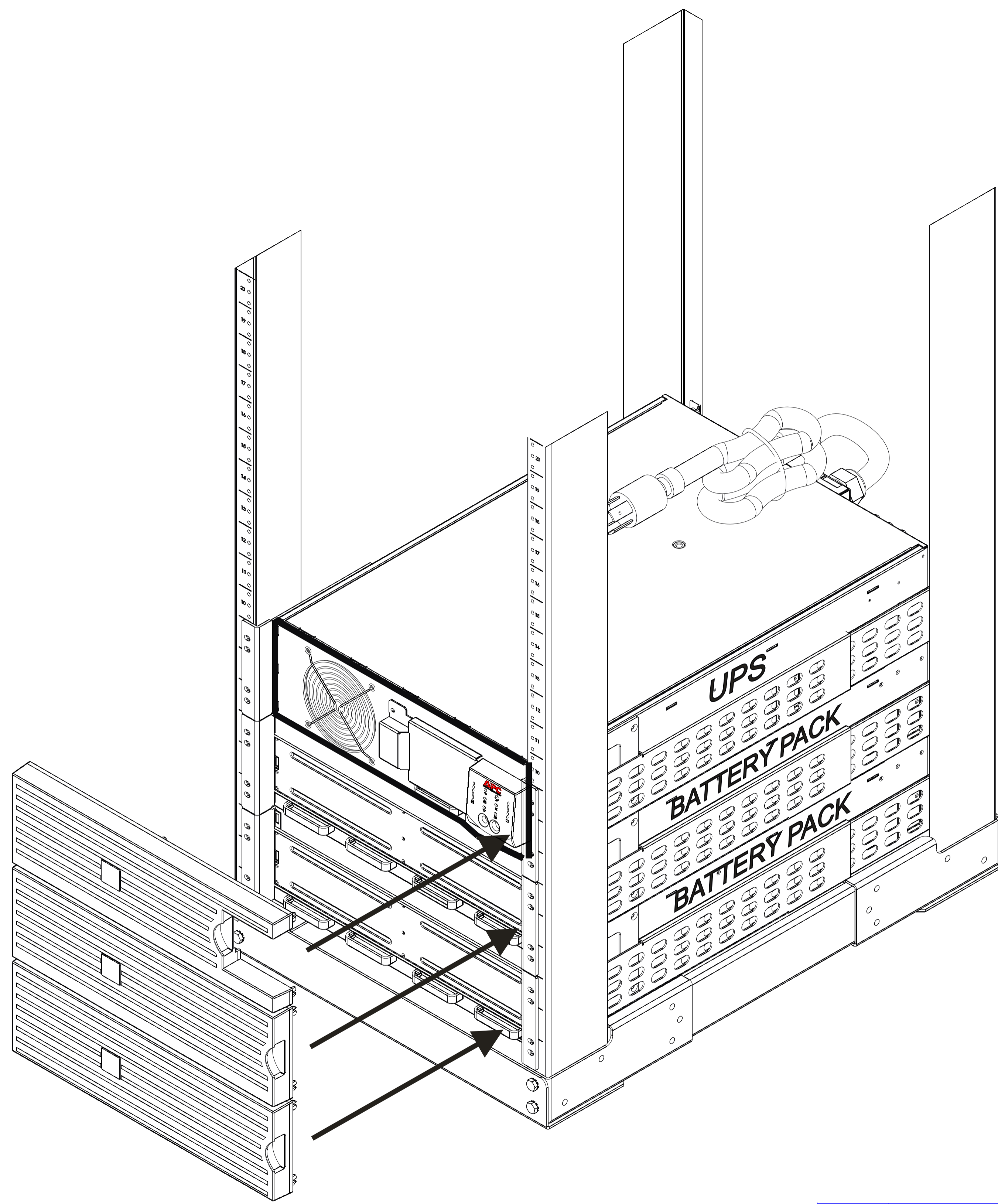

THE INFORMATION CONTAINED IN THIS DRAWING IS THE SOLE PROPERTY OF AMERICAN POWER CONVERSION. ANY REPRODUCTION IN PART OR WHOLE WITHOUT THE WRITTEN PERMISSION OF AMERICAN POWER CONVERSION IS PROHIBITED

REVISIONS				
REV	ALFA	DESCRIPTION	DATE	APPR
01		INITIAL RELEASE	12/OCT/2011	MP



ISOMETRIC VIEW

- NOTES:**
1. INSTALLATION SHALL COMPLY WITH ALL APPLICABLE LOCAL AND NATIONAL CODES.
  2. PLEASE REFER TO PRODUCT MANUALS FOR ADDITIONAL DETAILS.
  3. ALL DIMENSIONS ARE IN INCHES [ MILLIMETERS ].

ITEM NO.	APC PART NUMBER	VENDOR PART NUMBER	DESCRIPTION/MATERIAL/SPECIFICATION	QTY.
PARTS LIST				
		ENGINEER Mahesh 12/Oct/2011	 AMERICAN POWER CONVERSION KALYANI PLATINA, BLOCK 1, NO. 24, EPIP ZONE, PHASE 2, WHITEFIELD, BANGALORE-560066, INDIA	
		CHECKED Prahlad 12/Oct/2011		
		ISSUED XXXX XX/XXX/XX	ITEM	DIAGRAM_SINGLE LINE MECHANICAL CHIRU
	MATERIAL : SEE NOTES	ARCHIVE MEDIA CODE 0S-4978_REV01.cdr	PROJECT	CHIRU
	FINISH : SEE NOTES	THIRD ANGLE PROJECTION	SIZE D	FSCM NO. DWG. NO. 0S-4978
	DO NOT SCALE DRAWING		SCALE NTS	FIRST USED ON

THE INFORMATION CONTAINED IN THIS DRAWING IS THE SOLE PROPERTY OF AMERICAN POWER CONVERSION. ANY REPRODUCTION IN WHOLE OR IN PART WITHOUT THE WRITTEN PERMISSION OF AMERICAN POWER CONVERSION IS PROHIBITED.

REVISIONS				
REV	ALPHA	DESCRIPTION	DATE	APPR
1	-	INITIAL DRAFT	02/26/2010	
2	-	2 <sup>ND</sup> DRAFT	03/12/2010	

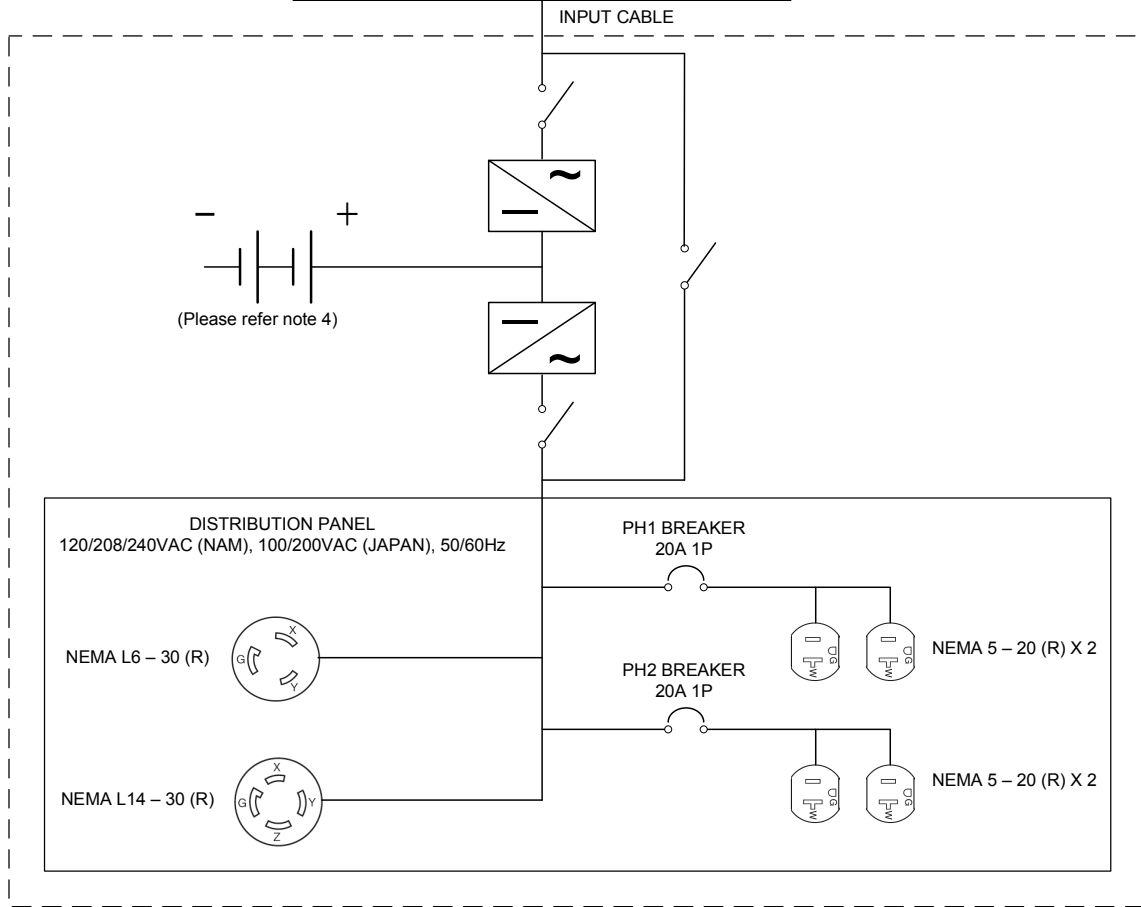
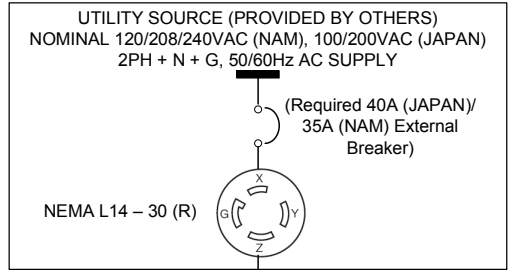

- NOTES:
1. INSTALLATION MUST COMPLY WITH NATIONAL, STATE AND LOCAL ELECTRICAL REGULATIONS.
  2. UTILITY SOURCE (2PH + N + G, PROVIDED BY OTHERS) TO BE NOMINAL 120/208/240VAC (NAM) OR 100/200VAC (JAPAN), 50/60Hz.
  3. SURTD6000RMXLP3U AND SURTD6000RMXLJP3U MODELS: TO DRAW FULL POWER FROM THE UPS, HAVE A QUALIFIED ELECTRICIAN CUT OFF THE INPUT PLUG AND HARDWIRE THE UPS TO THE APPROPRIATE POWER PANEL.
  4. EXTERNAL BATTERY PACKS (UPTO 10) CAN BE CONNECTED FOR EXTENDED BACKUP TIME.
  5. FOLLOWING OPTIONAL PDU / HARDWIRE KIT CAN BE PURCHASED SEPARATELY AND FITTED IN PLACE OF THE DEFAULT PDU - NAM: SURT014, SURT015, SURT016, SURT017, SURT018. JAPAN: SURT017J, SURT018J, SURT022J.
  6. PLEASE REFER TO PRODUCT DOCUMENTATION FOR FURTHER INFORMATION.

ITEM NO.	REV PART NUMBER	VENDOR PART NUMBER	DESCRIPTION/MATERIAL/SPECIFICATION	QTY.
PARTS LIST				
UNLESS OTHERWISE SPECIFIED DIMENSIONS ARE IN INCHES TOLERANCES ARE: FRACTIONS .XXX ± 1/16 DECIMALS .XXX ± .005 ANGLES ± 1/2° X.X ± .01 X.X ± .03		ENGINEER JAYA-CHANDRA	DATE 03/12/2010	PROJECT CHIRU
MATERIAL:		CHECKED HEMANT	ITEM SINGLE LINE ELECTRICAL DIAGRAM	
FINISH:		THIRD ANGLE PROJECTION	SIZE C	DWG NO. 0S-4977
DO NOT SCALE DRAWING		SCALE 1:1 FIRST USED ON		REV 1

