

Galaxy VM

UPS

Operation

Latest updates are available on the Schneider Electric website
2/2024



Legal Information

The information provided in this document contains general descriptions, technical characteristics and/or recommendations related to products/solutions.

This document is not intended as a substitute for a detailed study or operational and site-specific development or schematic plan. It is not to be used for determining suitability or reliability of the products/solutions for specific user applications. It is the duty of any such user to perform or have any professional expert of its choice (integrator, specifier or the like) perform the appropriate and comprehensive risk analysis, evaluation and testing of the products/solutions with respect to the relevant specific application or use thereof.

The Schneider Electric brand and any trademarks of Schneider Electric SE and its subsidiaries referred to in this document are the property of Schneider Electric SE or its subsidiaries. All other brands may be trademarks of their respective owner.

This document and its content are protected under applicable copyright laws and provided for informative use only. No part of this document may be reproduced or transmitted in any form or by any means (electronic, mechanical, photocopying, recording, or otherwise), for any purpose, without the prior written permission of Schneider Electric.

Schneider Electric does not grant any right or license for commercial use of the document or its content, except for a non-exclusive and personal license to consult it on an "as is" basis.

Schneider Electric reserves the right to make changes or updates with respect to or in the content of this document or the format thereof, at any time without notice.

To the extent permitted by applicable law, no responsibility or liability is assumed by Schneider Electric and its subsidiaries for any errors or omissions in the informational content of this document, as well as any non-intended use or misuse of the content thereof.

Table of Contents

Important Safety Instructions — SAVE THESE INSTRUCTIONS	5
Safety Precautions	6
Overview of UPS User Interface	7
Overview of Mimic Diagram	8
Overview of Status LEDs	9
Display Menu Tree	9
Display Symbols	11
Overview of Controller Interface	11
Operation Modes	12
UPS Modes	12
System Modes	16
Configuration	18
Add a New User or Edit an Existing User	18
Delete a User	18
Configure the Display Preferences	19
Configure the Display Settings	20
Configure the UPS Output Voltage Compensation	21
Configure High Efficiency Mode	22
Enable Peak Shaving Mode	23
Configure the Redundancy Level of the Parallel System	24
Configure the Input Contacts	25
Configure the Output Relays	26
Configure Reminder Settings	28
Configure Battery Alarm Threshold	29
Configure Automatic Battery Test	30
Configure the Network	31
Configure the Modbus	33
Restore Default Configuration	34
Operation Procedures	35
Access Password-Protected Screens	35
View the System Status Information	36
Start a Boost Charge of the Batteries	40
Access a Configured Network Management Interface	41
Operation Procedures for Single UPS Systems	42
Start Up Single System from Maintenance Bypass Operation	42
Shut Down Single System from Normal to Maintenance Bypass Operation	44
Transfer UPS from Normal to Requested Static Bypass Operation	46
Transfer UPS from Requested Static Bypass Operation to Normal Operation	46
Operation Procedures for Parallel UPS Systems	47
Start Up Parallel System from Maintenance Bypass Operation	47
Shut Down Parallel System from Normal to Maintenance Bypass Operation	49
Start Up and Add UPS to a Running Parallel System	51

- Isolate this Single UPS from the Parallel System 52
- Operation Procedures for Frequency Converter Systems 53
 - Start-Up System Operating as Frequency Converters..... 53
 - Shut Down System Operating as Frequency Converters 53
- Maintenance 54
 - Replace the Top Filter 54
 - Replace the Three Bottom Filters 55
- Troubleshooting 56
 - Troubleshooting via the Mimic Diagram LEDs 56
 - Reboot the Display 58
 - Logs 59
 - View the NMC Log 59
 - View the UPS Log 60
 - Export Data from Logs..... 61
 - View the Active Alarms..... 62
 - Alarm Levels 62
 - Alarm Messages 62
 - Tests 68
 - Perform a Battery Test..... 68
 - Perform a Runtime Calibration 68
 - Perform an Annunciators Test..... 69
 - Calibrate the Display 69
 - Determine if you need a Replacement Part..... 70
 - Find the UPS Serial Number 70
 - Return Parts to Schneider Electric..... 70

Important Safety Instructions — SAVE THESE INSTRUCTIONS

Read these instructions carefully and look at the equipment to become familiar with it before trying to install, operate, service or maintain it. The following safety messages may appear throughout this manual or on the equipment to warn of potential hazards or to call attention to information that clarifies or simplifies a procedure.



The addition of this symbol to a “Danger” or “Warning” safety message indicates that an electrical hazard exists which will result in personal injury if the instructions are not followed.



This is the safety alert symbol. It is used to alert you to potential personal injury hazards. Obey all safety messages with this symbol to avoid possible injury or death.

DANGER

DANGER indicates a hazardous situation which, if not avoided, **will result in death or serious injury.**

Failure to follow these instructions will result in death or serious injury.

WARNING

WARNING indicates a hazardous situation which, if not avoided, **could result in death or serious injury.**

Failure to follow these instructions can result in death, serious injury, or equipment damage.

CAUTION

CAUTION indicates a hazardous situation which, if not avoided, **could result in minor or moderate injury.**

Failure to follow these instructions can result in injury or equipment damage.

NOTICE

NOTICE is used to address practices not related to physical injury. The safety alert symbol shall not be used with this type of safety message.

Failure to follow these instructions can result in equipment damage.

Please Note

Electrical equipment should only be installed, operated, serviced, and maintained by qualified personnel. No responsibility is assumed by Schneider Electric for any consequences arising out of the use of this material.

A qualified person is one who has skills and knowledge related to the construction, installation, and operation of electrical equipment and has received safety training to recognize and avoid the hazards involved.

Per IEC 62040-1: "Uninterruptible power systems (UPS) -- Part 1: Safety Requirements," this equipment, including battery access, must be inspected, installed and maintained by a skilled person.

The skilled person is a person with relevant education and experience to enable him or her to perceive risks and to avoid hazards which the equipment can create (reference IEC 62040-1, section 3.102).

Safety Precautions

DANGER

HAZARD OF ELECTRICAL SHOCK, EXPLOSION OR ARC FLASH

All safety instructions in this document must be read, understood and followed.

Failure to follow these instructions will result in death or serious injury.

DANGER

HAZARD OF ELECTRICAL SHOCK, EXPLOSION OR ARC FLASH

After the UPS system has been electrically wired, do not start up the system. Start-up must only be performed by Schneider Electric.

Failure to follow these instructions will result in death or serious injury.

Overview of UPS User Interface

Display Model 1

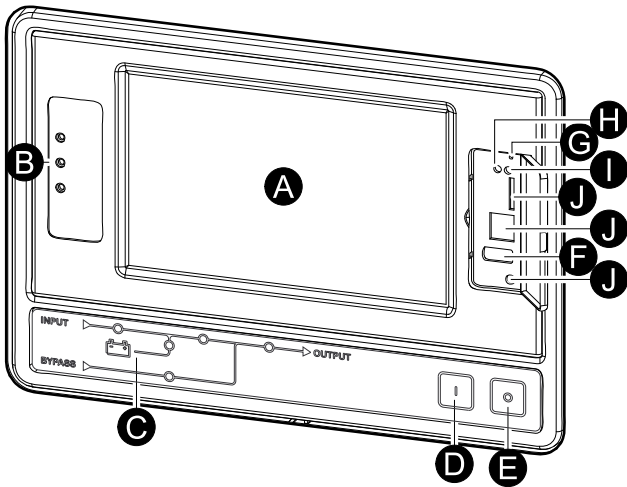

Display Model 2

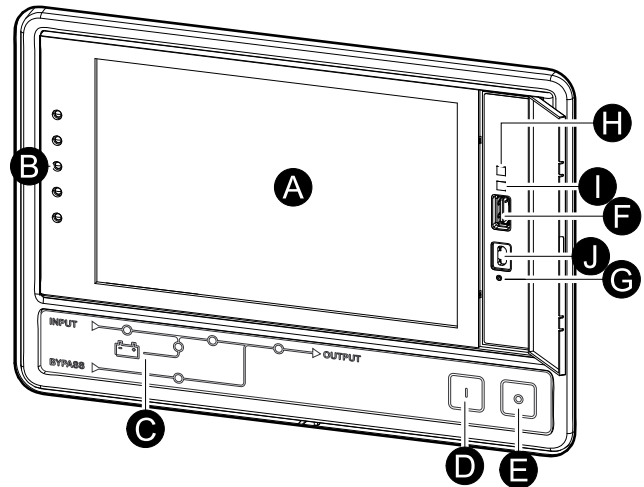

- A. Display¹
- B. Status LEDs
- C. Mimic diagram
- D. Inverter ON button
- E. Inverter OFF button
- F. USB port for export of logs
- G. Display reboot button
- H. Network connection LED:
 - Solid green: The system has valid TCP/IP settings.
See [Configure the Network](#), page 31.
 - Flashing green: The system does not have valid TCP/IP settings.
 - Solid orange: The display is inoperable. Contact Schneider Electric.
 - Flashing orange: The system is making BOOTP requests.
See [Configure the Network](#), page 31.
 - Alternately flashing green and orange: If the LED is alternately flashing slowly, the system is making DHCP requests.
See [Configure the Network](#), page 31.
 - If the LED is alternately flashing rapidly, the system is starting up.
 - Off: The display is not receiving input power or the display is inoperable.
- I. LED for indication of network connection type:
 - Solid green: The system is connected to a network operating at 10 Megabits per second (Mbps).
 - Flashing green: The system is receiving or transmitting data packets at 10 Megabits per second (Mbps).
 - Solid orange: The system is connected to a network operating at 100 Megabits per second (Mbps).
 - Flashing orange: The system is receiving or transmitting data packets at 100 Megabits per second (Mbps).
 - Off: One or more of the following exists: The display is not receiving input power, the cable that connects the system to the network is disconnected,

¹ Note that the UPS comes with one of the two display models.

the device that connects the system to the network is turned off, or the display is inoperable. Check the connections and if the LED remains off, contact Schneider Electric.

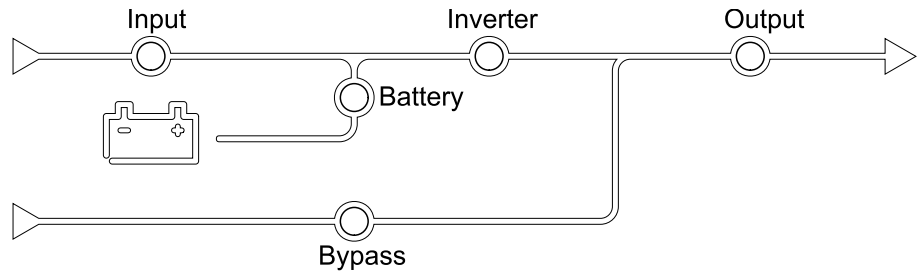

J. Reserved for service.

Overview of Mimic Diagram









The mimic diagram shows the power flow through the UPS system, and the status of the main functions.

Each LED can be in one of the below three states:

Green	The corresponding function is active and OK	
Red	The corresponding function is not working properly	
Off	The corresponding function is not active	

Overview of Status LEDs

The status LEDs placed next to the display show the current status of the UPS system:

Display Model 1 – LED symbols	Display Model 2 – LED symbols	LED color	LED description
		Green	<ul style="list-style-type: none"> Green LED on: The load is protected Green LED + orange LED on: The load is protected, but the system reports an alarm at warning level Orange LED + red LED on: The load is unprotected and the system reports an alarm at warning level and an alarm at critical level Red on: The load is unprotected and the system reports an alarm at critical level
		Yellow	
		Red	

Display Menu Tree





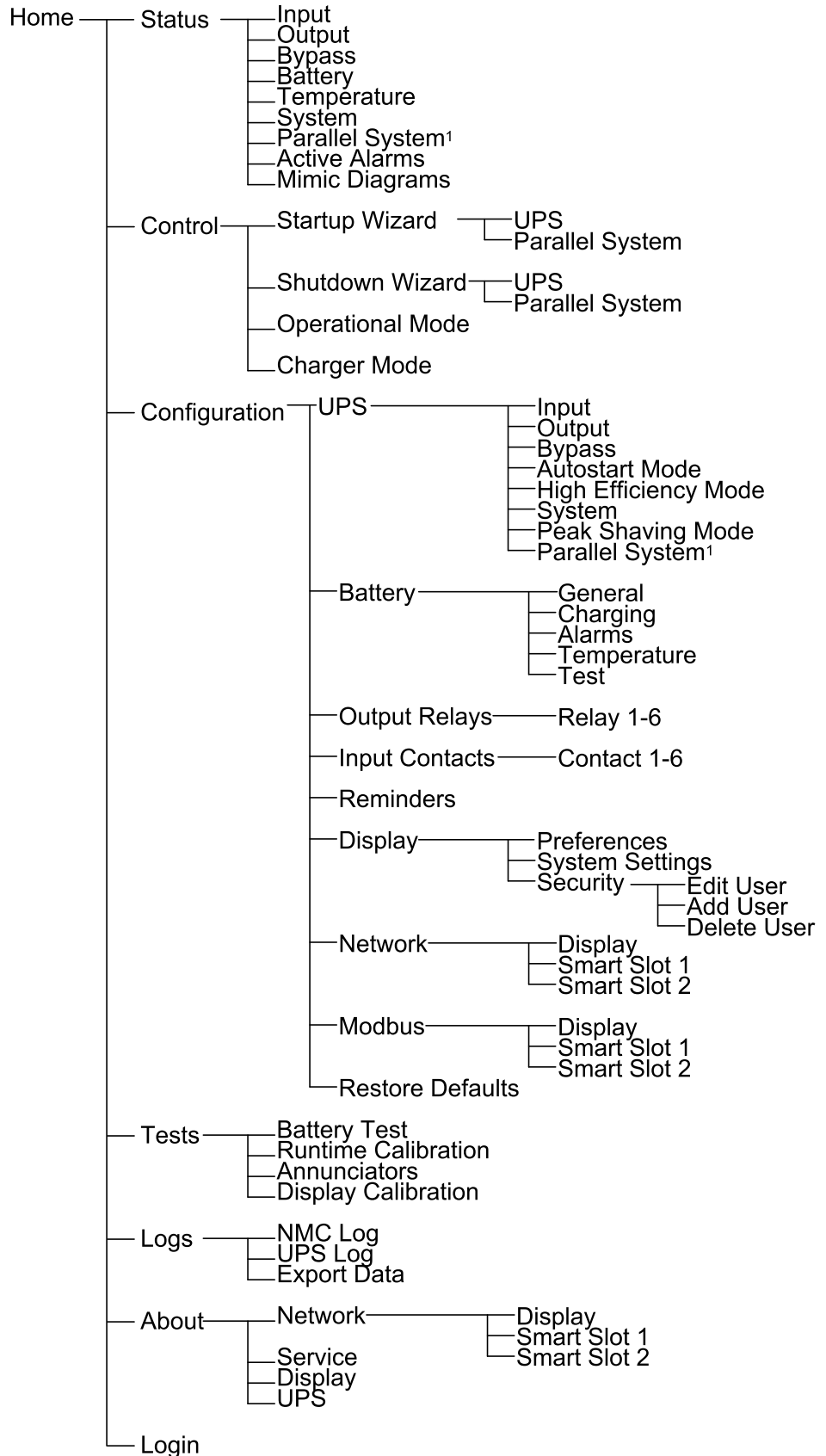

The menu tree is dependent on your system configuration. All screens might not be available on your UPS

NOTE: The control and configuration screens are password-protected.



¹ Only available in parallel systems

Display Symbols

Symbol	Description
	The locked home button appears when the system is locked by a password protection. Tap this button to go to the home screen of the display.
	The unlocked home button appears when the system has been unlocked using the password. Tap this button to go to the home screen of the display.
	Tap the OK button to confirm your selections and exit the current screen.
	Tap the ESC button to cancel your changes and exit the current screen.
	Tap the filter button to set up the filters for your logs.
	Tap the recycle bin button to clear the log.

Overview of Controller Interface

Front View of Power Cabinet

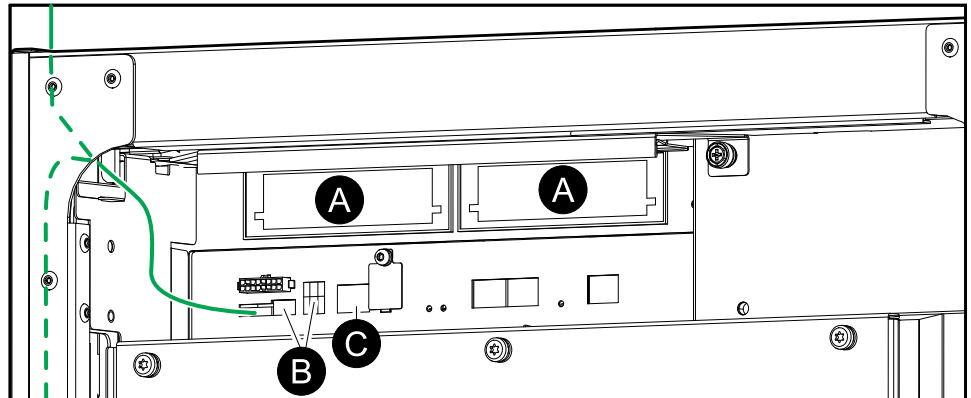

- A. Two Smart Slots for optional Network Management Cards
- B. Modbus and modbus dip switch settings
- C. Ethernet

Operation Modes

The Galaxy UPS has two different levels of operation mode:

- **UPS Operation Mode:** The operation mode of the operated UPS. See *UPS Modes*, page 12.
- **System Operation Mode:** The operation mode of the complete UPS system. See *System Modes*, page 16.

UPS Modes

eConversion Mode

eConversion provides a combination of maximum protection and highest efficiency, that permits to reduce the electricity absorbed by the UPS by a factor three compared with double conversion. eConversion is now the generally recommended operation mode and is enabled by default in the UPS but it can be disabled via the display menu. When enabled, eConversion can be set to always active or on a set schedule configured through the display menu.

In eConversion the UPS supplies the active part of the load through the static bypass as long as the utility/mains supply is within tolerance. The inverter is kept running in parallel so the input power factor of the UPS is maintained close to unity, regardless of the load power factor, as the reactive part of the load is significantly reduced in the UPS input current. In case of an interruption of the utility/mains supply, the inverter maintains the output voltage providing an uninterrupted transfer from eConversion to double conversion. The batteries are charged when the UPS is in eConversion mode and harmonics compensation is also provided.

eConversion mode can be used for the Galaxy VM UPS in the following conditions:

- The minimum load on the UPS is 5-10%.
- Voltage fluctuation is $\leq 10\%$ versus nominal voltage (adjustable setting from 3% to 10%).
- THDU is $\leq 5\%$.

NOTE: When changes to eConversion mode settings are made on one UPS in a parallel system, the settings are shared to all UPSs in the parallel system.

NOTE: When a genset/generator is in use and frequency fluctuations are seen (typically due to downsizing), it is recommended to configure an input contact to disable high efficiency modes while the genset/generator is on.

NOTE: If external synchronization is required, it is generally recommended to disable eConversion.

While the UPS is in eConversion, the bypass, inverter, and load LEDs are green, and the battery and input LEDs are off.

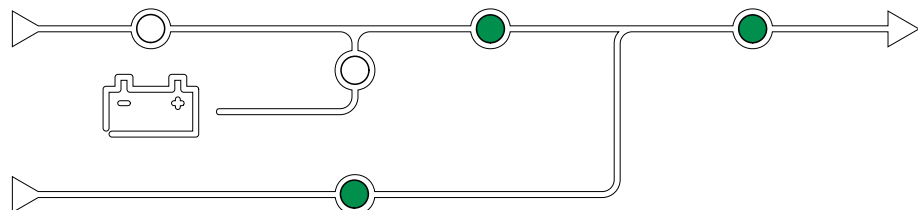

Double Conversion (Normal Operation)

The UPS supports the load with conditioned power. Double conversion mode permanently creates a perfect sinewave at the system output, but this operation also uses more electricity.

While the UPS is in double conversion, the input, inverter, and load LEDs are green, and the battery and bypass LEDs are off.

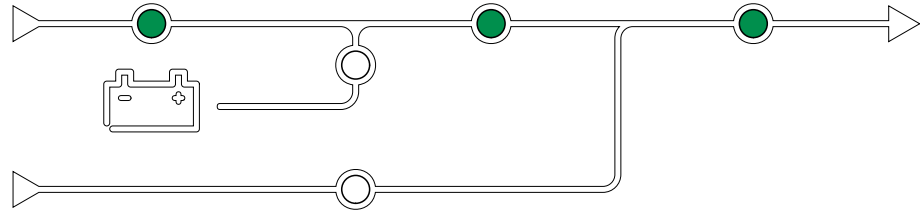

Battery Operation

If the utility/mains supply fails, the UPS transfers to battery operation and supports the load with conditioned power from the DC source.

While the UPS system is in battery operation, the battery, inverter, and load LEDs are green, the bypass LED is off and the input LED is red.

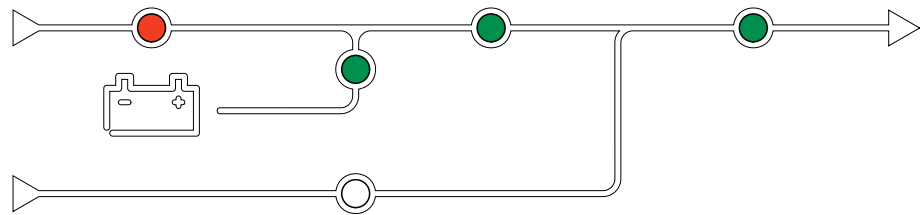

Requested Static Bypass Operation

The UPS can be transferred to requested static bypass operation following a command from the display. During requested static bypass operation, the load is supplied from the bypass source. If a fault is detected, the UPS will transfer to double conversion (normal operation) or forced static bypass operation. If there is an interruption to the utility/mains supply during requested static bypass operation, the UPS will transfer to battery operation.

During requested static bypass, the input, bypass and output LEDs are green and the battery and inverter LEDs are off.

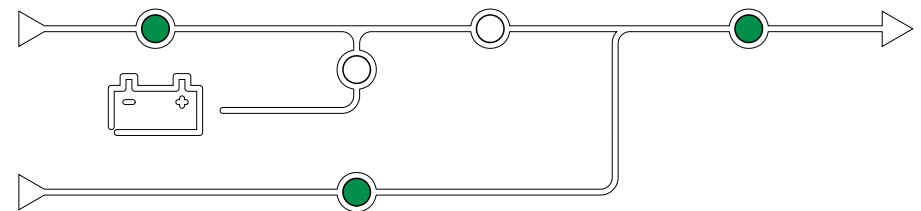

Forced Static Bypass Operation

The UPS is in forced static bypass operation following a command from the UPS or because the user has pressed the inverter OFF button on the UPS. During forced static bypass operation, the load is supplied from the bypass source.

NOTE: The batteries are not available as an alternate power source while the UPS is in forced static bypass operation.

During forced static bypass, the input, bypass and output LEDs are green and the battery and inverter LEDs are off or red if an alarm is present.

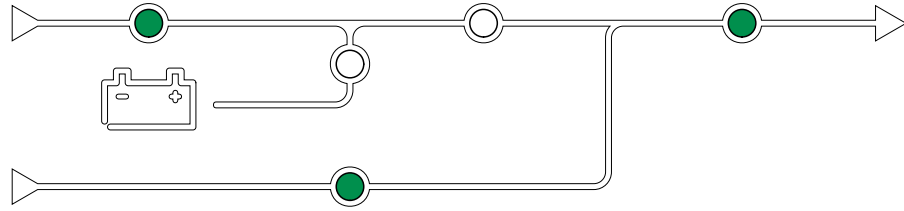

Maintenance Bypass Operation

When the maintenance bypass breaker MBB is closed in the external maintenance bypass cabinet, maintenance bypass panel, or third party switchgear, the UPS transfers to external maintenance bypass operation. The load is supplied with unconditioned power from the bypass source. Service and replacement can be performed on the entire UPS during external maintenance bypass operation via the maintenance bypass breaker MBB.

NOTE: The batteries are not available as an alternate power source while the UPS is in external maintenance bypass operation.

Static Bypass Standby Operation

Static bypass standby is only applicable to an individual UPS in a parallel system. The UPS enters static bypass standby operation if the UPS is prevented from entering forced static bypass operation and the other UPSs of the parallel system can support the load. In static bypass standby the output of the specific UPS is OFF. The UPS automatically transfers to the preferred operation mode when possible.

NOTE: If the other UPSs cannot support the load, the parallel system transfers to forced static bypass operation. The UPS in static bypass standby operation will then transfer to forced static bypass operation.

Inverter Standby

NOTE: Inverter standby is only applicable to an individual UPS in a parallel system.

The UPS enters inverter standby if there is an interruption to the utility/mains supply of one UPS and the other UPS units of the parallel system can support the load with the configured redundancy level maintained. This is to avoid that the batteries are being drained in situations where it is not necessary.

ECO Mode

NOTE: ECO mode must be enabled by a Schneider Electric field service engineer.

In ECO mode the UPS uses requested static bypass to power the load as long as the power quality is within tolerance. If a fault is detected (bypass voltage out of tolerance, output voltage out of tolerance, power interruption, etc) the UPS will transfer to double conversion (normal operation) or forced static bypass. Depending on the transfer conditions, a minimal interruption of the load supply may happen (up to 10 ms). The batteries are charged when the UPS is in ECO mode. The main advantage of ECO mode is a reduction in the consumption of electrical power compared with double conversion.

NOTE: When changes to ECO mode settings are made on one UPS in a parallel system, the settings are shared to all UPSs in the parallel system.

During ECO mode, the input, bypass and output LEDs are green and the battery and inverter LEDs are off.

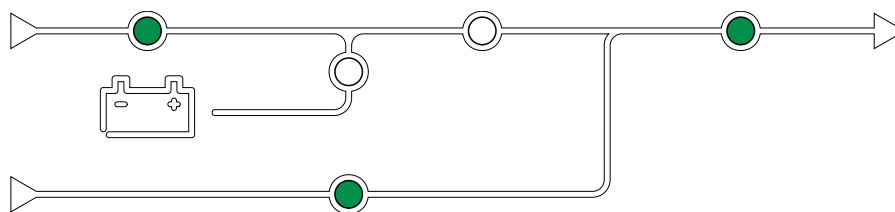

Self-test

After start-up of the UPS system, the UPS will perform an automatic self-test. The status and progress of the self-test are indicated by the flashing LEDs on the mimic diagram.

When the self-test has been passed, the LEDs will indicate the operation mode of the UPS system.

NOTE: If an LED continues to flash after completion of the self-test, please call Schneider Electric.

Battery Test Mode

The UPS is in battery test mode when the UPS is performing a battery self-test or a runtime calibration.

NOTE: The battery test will be aborted if the utility/mains supply is interrupted or if a critical alarm is present and the UPS will return to normal operation upon return of utility/mains.

OFF Mode

The UPS is not supplying the load with power. The batteries are charged and the display is on.

System Modes

The system operation mode indicates the output status of the complete UPS system including the switchgear and indicates which source supplies the load.

eConversion Mode

eConversion provides a combination of maximum protection and highest efficiency, that permits to reduce the electricity absorbed by the UPS by a factor three compared with double conversion. eConversion is now the generally recommended operation mode and is enabled by default in the UPS but it can be disabled via the display menu. When enabled, eConversion can be set to always active or on a set schedule configured through the display menu.

In eConversion the UPS system supplies the active part of the load through the static bypass as long as the utility/mains supply is within tolerance. The inverter is kept running in parallel so the input power factor of the UPS system is maintained close to unity, regardless of the load power factor, as the reactive part of the load is significantly reduced in the UPS system input current. In case of an interruption of the utility/mains supply, the inverter maintains the output voltage providing an uninterrupted transfer from eConversion to double conversion. The batteries are charged when the UPS system is in eConversion mode and harmonics compensation is also provided.

eConversion mode can be used for the Galaxy VM UPS system in the following conditions:

- The minimum load on the UPSs is 5-10%.
- Voltage fluctuation is $\leq 10\%$ versus nominal voltage (adjustable setting from 3% to 10%).
- THDU is $\leq 5\%$.

NOTE: When changes to eConversion mode settings are made on one UPS in a parallel system, the settings are shared to all UPSs in the parallel system.

NOTE: When a genset/generator is in use and frequency fluctuations are seen (typically due to downsizing), it is recommended to configure an input contact to disable high efficiency modes while the genset/generator is on.

NOTE: If external synchronization is required, it is generally recommended to disable eConversion.

Inverter Operation

In inverter operation the load is supplied by the inverters. The UPS mode can be in either double conversion (normal operation) or battery operation when the UPS system operation mode is inverter operation.

Requested Static Bypass Operation

When the UPS system is in requested static bypass operation, the load is supplied from the bypass source. If a fault is detected, the UPS system will transfer to inverter operation or forced static bypass operation.

Forced Static Bypass Operation

The UPS system is in forced static bypass operation following a command from the UPS system or because the user has pressed the inverter OFF button on the UPSs. During forced static bypass operation, the load is supplied directly by the bypass source with unconditioned power.

NOTE: The batteries are not available as an alternate power source while the UPS system is in forced static bypass operation.

Maintenance Bypass Operation

In maintenance bypass operation, the load is supplied directly by the bypass source with unconditioned power via the maintenance bypass breaker MBB.

NOTE: The batteries are not available as an alternate power source in maintenance bypass operation.

ECO Mode

In ECO mode the UPS system uses requested static bypass to power the load as long as the power quality is within tolerance. If a fault is detected (bypass voltage out of tolerance, output voltage out of tolerance, power interruption, etc) the UPS system will transfer to double conversion (normal operation) or forced static bypass. Depending on the transfer conditions, a minimal interruption of the load supply may happen (up to 10 ms). The batteries are charged when the UPS system is in ECO mode. The main advantage of ECO mode is a reduction in the consumption of electrical power compared with double conversion.

NOTE: When changes to ECO mode settings are made on one UPS in a parallel system, the settings are shared to all UPSs in the parallel system.

OFF Mode

The UPS system is not supplying the load with power. The batteries are charged and the display is on.

Configuration

Add a New User or Edit an Existing User

1. From the home screen on the display select **Configuration > Display > Security**.
2. Select **Add User** to add a new user or select **Edit User** to edit an existing user of the system.



The screenshot shows a configuration screen with a top navigation bar containing a home icon and buttons for 'Configuration', 'Display', 'Security', and 'Add User'. Below the navigation bar, there are three input fields labeled 'Name:', 'Pin:', and 'Confirm Pin:'. At the bottom right, there are two buttons labeled 'ESC' and 'OK'.

3. In the **Name** field, type in the name of the user. Complete with **Enter**.
4. In the **Pin** field, type in a pin code for the user. Complete with **Enter**.
5. In the **Confirm Pin** field, retype the pin code of the user. Complete with **Enter**.
6. Tap **OK** to save your settings.

Delete a User

1. From the home screen on the display select **Configuration > Display > Security > Delete User**.
2. Browse to the user that you wish to delete using the up and down arrows and tap **OK**.
3. Tap **Yes** to confirm deletion of an existing user of the system.

Configure the Display Preferences

1. From the home screen on the display select **Configuration > Display > Preferences**.

The screenshot shows a configuration menu with three tabs: Configuration, Display, and Preferences. The Preferences tab is active. The settings are as follows:

- Language: English (selected)
- Date Format: mm/dd/yyyy (selected)
- Temperature: US Customary, Metric
- Manual: Manual
- Current Date: [Empty text box]
- Current Time: [Empty text box]
- Synchronize with NTP Server

Buttons for ESC and OK are located at the bottom right of the screen.

2. Select the preferred language using the up and down arrows.
3. Select the preferred date format using the up and down arrows.
4. Select the preferred temperature units: **US Customary** (°Fahrenheit) or **Metric** (°Celsius).
5. Set the current date and time using one of the below two methods:
 - Set the date and time manually on the display by selecting **Manual** and typing the actual date and time and completing with **Enter**.
 - Set the date and time automatically by selecting **Synchronize with NTP server** (Network Time Protocol server).

NOTE: NTP server settings can be configured in the network management interface via the Web, command line, or config file.

6. Tap **OK** to save your settings.

Configure the Display Settings

- From the home screen on the display select **Configuration > Display > System Settings**.

The screenshot shows the 'System Settings' screen with the following configuration:

- Alarm Volume:** Low
- Button Volume:** Medium
- Brightness:** High
- Backlight Timeout:** Enable, 10 minutes
- Auto Log Off:** 1 minutes
- Backlight Intensity:** Off

Buttons: ESC, OK

- Set the **Alarm Volume**. Choose between: **Off, Low, Medium, and High**.
- Set the **Button Volume**. Choose between: **Off, Low, Medium, and High**.
- Set the **Brightness** of the display. Choose between: **Low, Medium, and High**.
- Enable or disable **Backlight Timeout**. If you wish to enable backlight timeout, set the time limit in minutes for enabling backlight timeout. Choose between: **60, 30, 10, 5, and 1**.
- Set the intensity of the backlight. Choose between: **Off, Very Low, Low, and Medium**.
- Set the time limit in minutes for automatic log off. Choose between: **60, 30, 10, 5, and 1**.
- Tap **OK** to save your settings.

Configure the UPS Output Voltage Compensation

1. From the home screen on the display select **Configuration > UPS > Output**.
2. Tap arrow to the right to go to the next output configuration screen.

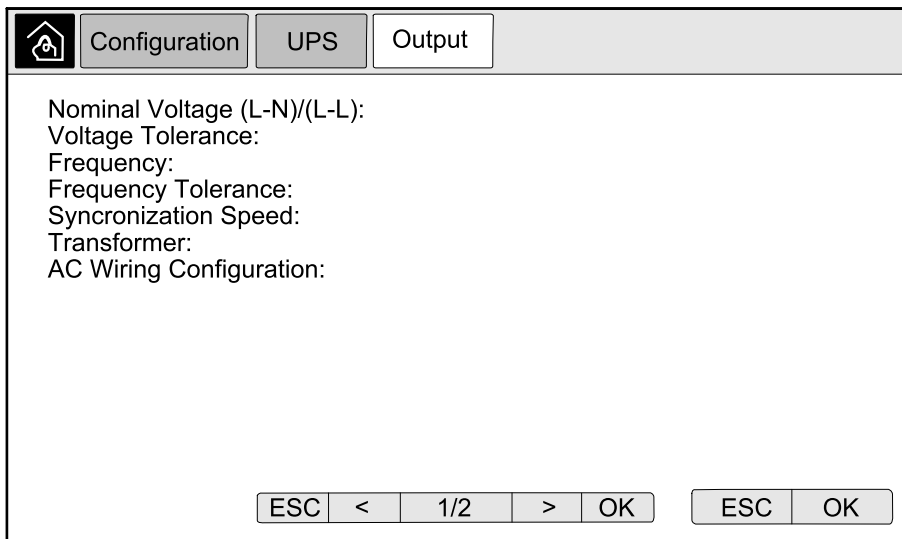

3. Under **Voltage Compensation** select the preferred voltage compensation for your system. Choose between **-3%**, **-2%**, **-1%**, **0%**, **1%**, **2%**, or **3%**.

NOTE: This setting is shared between all UPSs in a parallel system.

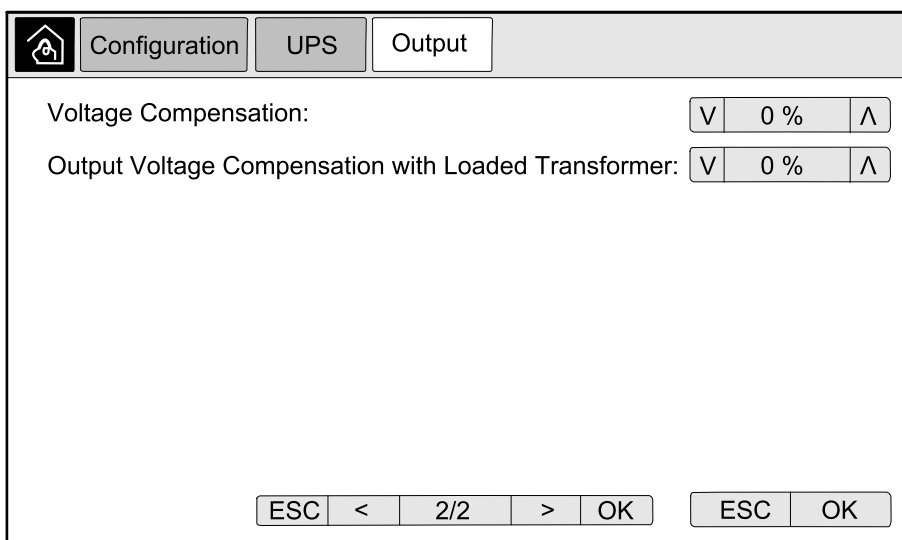

4. Under **Output Voltage Compensation with Loaded Transformer** select the preferred output voltage compensation to compensate for load dependent transformer voltage drop. Choose between **0%**, **1%**, **2%**, or **3%**.

NOTE: This setting must be identical for all UPSs in a parallel system.

NOTE: When this setting is set to 0%, the output transformer voltage compensation is disabled.

5. Tap **OK** to confirm your setting.

Configure High Efficiency Mode

NOTE: ECO Mode must be enabled by Schneider Electric during service configuration to make this selection available.

- From the home screen on the display select **Configuration > UPS > High Efficiency Mode** and configure the following settings:

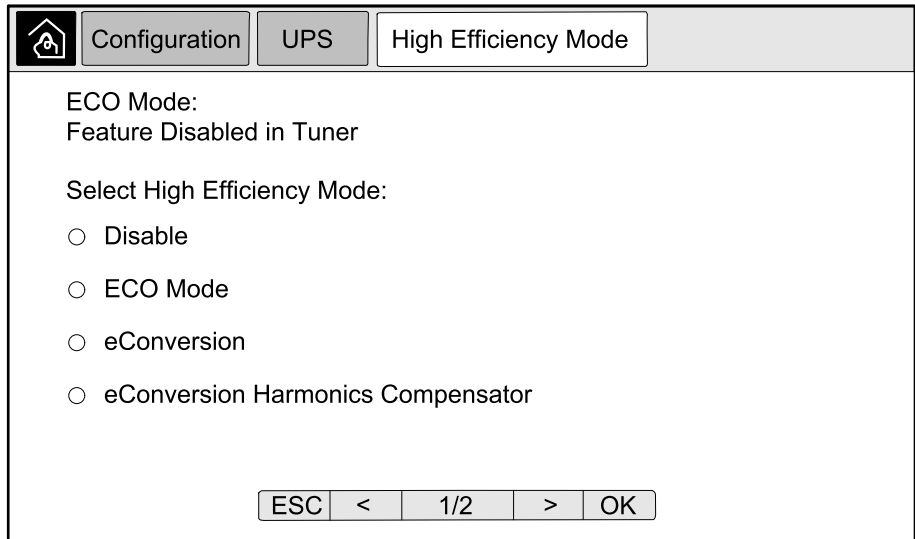

- Select High Efficiency Mode:** Choose between **Disable**, **ECO Mode**, **eConversion**, and **eConversion Harmonics Compensator**.

- Tap **>** and configure the schedule settings:

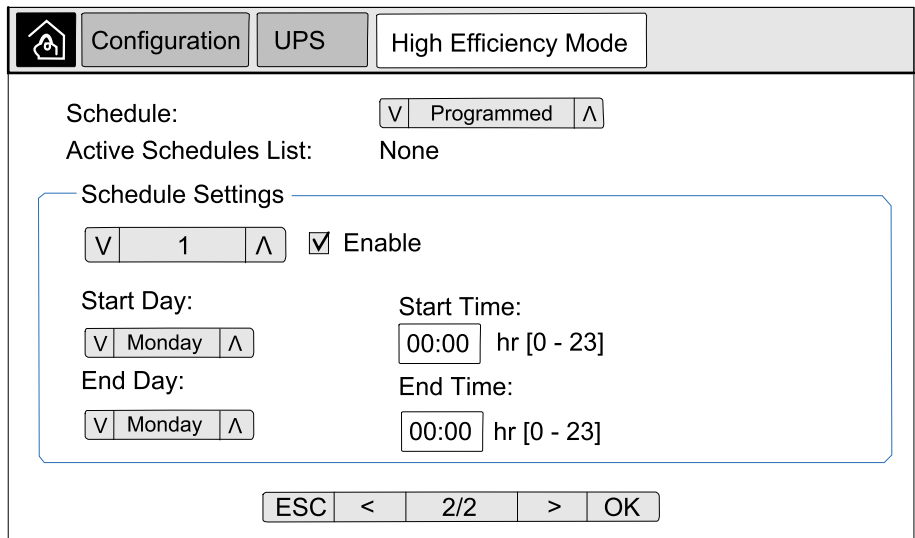

- Schedule:** Select when the system should enter the selected eConversion or ECO mode. Choose between **Always**, **Programmed** and **Never**.

- Active Schedules List:** If you chose **Programmed** above, select **Enable** and set the time and date for when the system should enter the selected eConversion or ECO mode.

- Tap **OK** to confirm your settings.

Enable Peak Shaving Mode

Peak shaving mode allows the UPS to reduce peak power consumed from the utility/mains supply.

NOTE: Peak shaving mode must be enabled locally by Schneider Electric during service configuration to make this selection available, but it must be controlled via a remote software application. Contact Schneider Electric for more details.

1. From the home screen on the display select **Configuration > UPS > Peak Shaving Mode**.
2. Select **Enable** to enable peak shaving mode.

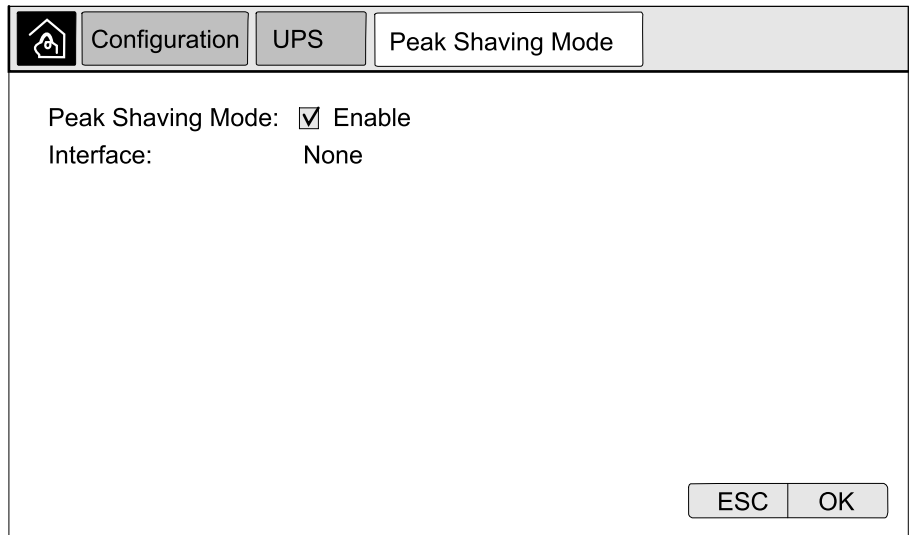

Configuration UPS Peak Shaving Mode

Peak Shaving Mode: Enable
Interface: None

ESC OK

3. Tap **OK** to confirm your settings.

Configure the Redundancy Level of the Parallel System

This procedure sets the redundancy level of your parallel system. The parallel system can contain up to five UPS units:

- a 4+1 system with four UPS units in capacity and one in redundancy
- a 5+0 system with five UPS units for capacity

1. From the home screen on the display select **Configuration > UPS > Parallel System**.

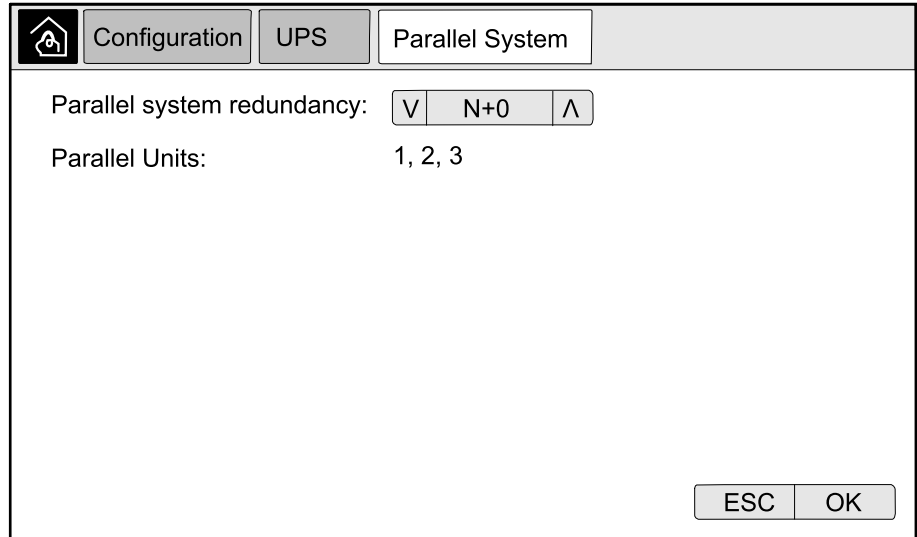

The screenshot shows a configuration menu with three tabs: 'Configuration', 'UPS', and 'Parallel System'. The 'Parallel System' tab is active. Below the tabs, there are two rows of settings. The first row is 'Parallel system redundancy:' followed by a dropdown menu showing 'N+0'. The second row is 'Parallel Units:' followed by the text '1, 2, 3'. At the bottom right of the screen, there are two buttons: 'ESC' and 'OK'.

2. Under **Parallel system redundancy** select the redundancy for your UPS system. Choose between **N+0**, **N+1**, **N+2**, **N+3**, **N+4**.
3. Tap **OK** to confirm your setting.

Configure the Input Contacts

1. On the display select **Configuration > Input Contacts** and select the input contact that you wish to configure.

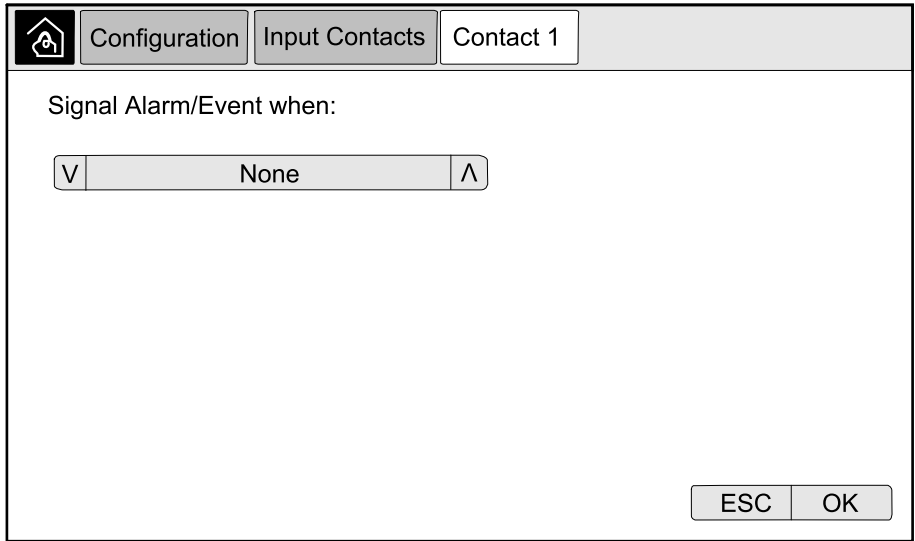

2. Choose between the below options:

Custom Input 1: General purpose input.	External Battery Monitoring Detected Fault: Input to indicate that the external battery monitor has detected a fault.
Custom Input 2: General purpose input.	Battery Room Ventilation Inoperable: Input to indicate that the battery room ventilation is inoperable. When the input is active, the battery charger will turn off.
Ground fault: Input to indicate that a ground fault is present.	Supplied By Genset: Input to indicate that the UPS is running on generator. The battery charge current will be reduced to the value set by Schneider Electric during start-up.
Inhibit Transfer from Static Bypass: When this input is active, and the system enters requested static bypass or forced static bypass, the system will be locked in static bypass as long as the input is active.	External energy storage: minor alarm: Input to indicate that the external energy storage monitor reports a minor alarm.
External energy storage: major alarm: Input to indicate that the external energy storage monitor reports a major alarm.	Force the Charger to Turn Off: Input that forces the charger to turn off.
Flywheel inoperable: Input to indicate that the flywheel is inoperable.	Disable High Efficiency Mode: Input to disable the use of high efficiency mode
Request bypass operation: Input that will transfer the UPS into requested static bypass operation if the conditions for a transfer are met.	Force battery operation: Input that will force a transfer to battery operation.

3. Tap **OK** to save your settings.

Configure the Output Relays

1. On the display select **Configuration > Output Relays**.
2. Select to enable or disable **Energized check mode**.
 - When **Energized check mode** is enabled the output relays are ON. If a signal is received or the power supply to the relay is lost, the circuit will open and the relay will be deactivated.
 - When **Energized check mode** is disabled the output relays are OFF. If a signal is received, the circuit will close and the relay will be activated.

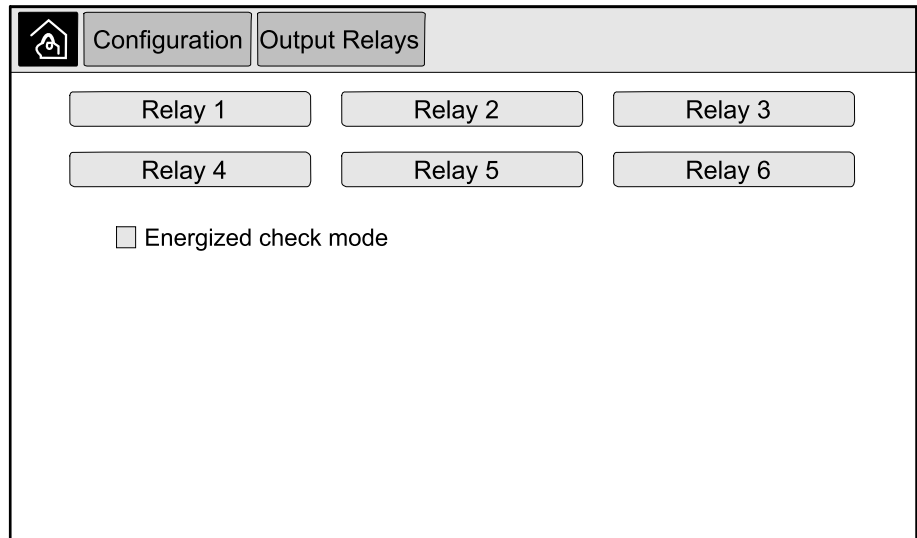

3. Select the output relay that you wish to configure.

4. Select the function that you wish to use the specific output relay for from the list below:

Common Alarm: The output is triggered when any alarm is present.	Normal Operation: The output is triggered when the UPS is running in normal operation.
Battery Operation²: The output is triggered when the UPS is running in battery operation.	Maintenance Bypass³: The output is triggered when the UPS is running in maintenance bypass operation.
Static Bypass²: The output is triggered when the UPS is running in forced static bypass operation or requested static bypass operation.	High Efficiency Mode: The output is triggered when the UPS is running in eConversion or ECO mode.
Output Overload: The input is triggered when there is an overload condition.	Fan Inoperable: The output is triggered when one or more fans are inoperable.
Battery is not Working Correctly²: The output is triggered when the batteries are not working correctly.	Battery Disconnected²: The output is triggered when the batteries have been disconnected or the battery breaker(s) are open.
Battery Voltage Low²: The output is triggered when the battery voltage is below the threshold.	Input Out of Tolerance: The output is triggered when the input is out of tolerance.
Bypass Out of Tolerance³: The output is triggered when the bypass is out of tolerance.	UPS Warning: The output is triggered when a warning alarm is present.
UPS Critical: The output is triggered when a critical alarm is present.	Parallel Redundancy Lost: The output is triggered when the specified redundancy has been lost.
External Fault: The output is triggered when a fault external to the UPS is present.	UPS Maintenance Mode: The output is triggered when the unit output breaker (UOB) is open.
System Warning: The output is triggered when a warning alarm is present in a parallel system.	System Critical: The output is triggered when a critical alarm is present in a parallel system.
System informational alarm: The output is triggered when an information alarm is present in a parallel system.	

5. Set the delay in seconds for the specific output to activate. Select a value between 0 and 60 seconds.
6. Tap **OK** to save your settings.

2. Not available when operating as a frequency converter without batteries.
 3. Not available when operating as a frequency converter.

Configure Reminder Settings

When the air filters have been replaced, the reminders settings must be updated.

- From the home screen on the display select **Configuration > Reminders**.

Configuration		Reminders	
Reminders Signalling	<input checked="" type="checkbox"/>	Enable	
<u>Air Filter Check</u>			
Reminder:	<input checked="" type="checkbox"/>	Enable	
Duration before 1st Reminder:	<input type="text" value="52"/>	weeks	[1 - 500]
Elapsed Time:	<input type="text" value="0"/>	days	[0 - 3650]
Remaining Time:	0	days	
Remaining Reminders:	3		
Reminder Status	In progress		<input type="button" value="ESC"/> <input type="button" value="OK"/>

- Configure the following settings:
 - Reminders Signalling:** Select **Enable** to enable the display of all reminders.
 - Reminder:** Select **Enable** to enable the display of reminders for air filter replacement.
 - Duration before 1st Reminder:** Set the time in weeks before the first reminder is shown.
 - Elapsed Time:** Manually set the number of days that the air filters have been used.
- Tap **OK** to confirm your settings.

Configure Battery Alarm Threshold

1. From the home screen on the display select **Configuration > Battery > Alarms**.

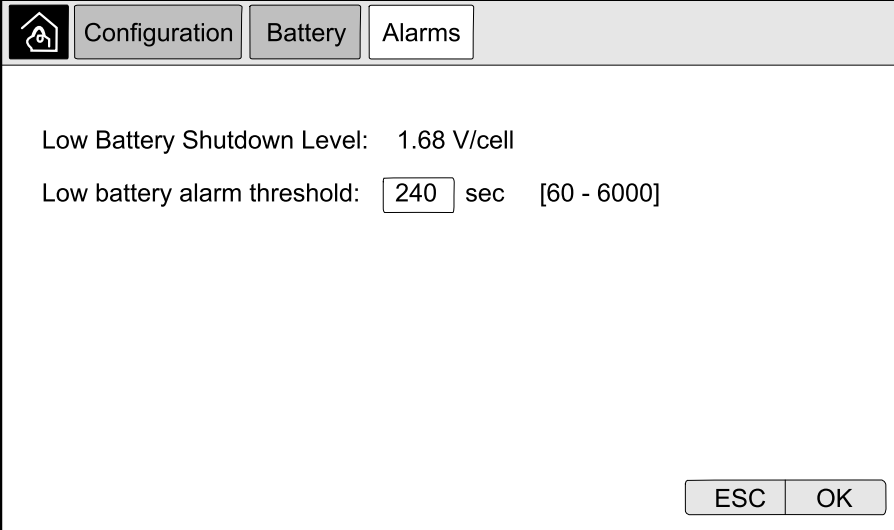

The screenshot shows a navigation menu at the top with a home icon, 'Configuration', 'Battery', and 'Alarms'. The main content area displays the following settings:

- Low Battery Shutdown Level: 1.68 V/cell
- Low battery alarm threshold: sec [60 - 6000]

At the bottom right, there are two buttons: 'ESC' and 'OK'.

2. Select your preferred battery alarm threshold in seconds. Select a value between 60 and 6000 seconds and complete with **Enter**.
3. Tap **OK** to confirm your setting.

Configure Automatic Battery Test

1. From the home screen on the display select **Configuration > Battery > Test**.

The screenshot shows a configuration menu for battery tests. At the top, there is a navigation bar with a home icon and three tabs: 'Configuration', 'Battery', and 'Test'. Below the tabs, there are three settings:

- Battery Test Interval:** A dropdown menu showing 'Every 8 Weeks'.
- Battery Test Start Time:** A text input field showing '0h 0m'.
- Battery Test Day of the Week:** A dropdown menu showing 'Tuesday'.

At the bottom right of the screen, there are two buttons: 'ESC' and 'OK'.

2. Set your preferred settings for the automatic battery test:
 - a. **Battery Test Interval:** Select your preferred interval for battery tests. Choose between: **Never**, **Every 52 Weeks**, **Every 26 Weeks**, **Every 12 Weeks**, **Every 8 Weeks**, **Every 4 weeks**, **Every 2 Weeks**, or **Once a Week**.

NOTE: If you run battery tests too frequently it can reduce the lifetime of the batteries.
 - b. **Battery Test Start Time:** Select the time of the day in 24 hour format that the test should take place and complete with **Enter**.
 - c. **Battery Test Day of the Week:** Select the day of the week that the test should take place and complete with **Enter**.
3. When all settings have been completed, tap **OK** to confirm your settings.

Configure the Network

The network can be configured for the display and for the cards in Smart Slot 1 and Smart Slot 2.

1. From the home screen on the display select **Configuration > Network** and select either **Display**, **Smart Slot 1**, or **Smart Slot 2** if present.
2. Configure the following settings:
 - a. **TCP/IPv4: Enable IPv4** (if applicable), and select the **Address Mode** (**Manual**, **DCHP**, or **BOOTP**).

The screenshot shows a configuration menu with a breadcrumb trail: Configuration > Network > Display > TCP/IPv4. The 'Enable IPv4' checkbox is checked. Under 'Address Mode', 'DHCP' is selected. There is an unchecked checkbox for 'Require vendor specific cookies to accept DHCP'. Under 'Manual Settings', there are three rows: 'System IP', 'Subnet Mask', and 'Default Gateway', each with a text input field containing '0.0.0.0' and a secondary '0.0.0.0' label. 'ESC' and 'OK' buttons are at the bottom right.

Field	Value	Label
System IP	0.0.0.0	0.0.0.0
Subnet Mask	0.0.0.0	0.0.0.0
Default Gateway	0.0.0.0	0.0.0.0

- b. **TCP/IPv6: Enable IPv6** (if applicable), select **Auto Configuration** or **Manual Configuration**, and select the **DHCPv6 Mode (Router controlled, Non-Address Information Only, Never, or Address and Other Information)**.

NOTE: Tap **Addresses** to see all valid IPv6 addresses.

- c. **Web Access: Enable Web** (if applicable) and select the **Access Mode (HTTP or HTTPS)**.

NOTE: Not available for Smart Slots.

- d. **FTP server: Enable FTP** (if applicable).

NOTE: Not available for Smart Slots.

Configure the Modbus

The modbus can be configured for the display and for the cards in Smart Slot 1 and Smart Slot 2.

NOTE: Only the display and optional Network Management Card AP9635 can be used for serial modbus.

1. From the home screen on the display select **Configuration > Modbus** and select either **Display, Smart Slot 1, or Smart Slot 2**.
2. Configure the modbus by enabling **Serial** or **TCP** access, and adding the needed values.

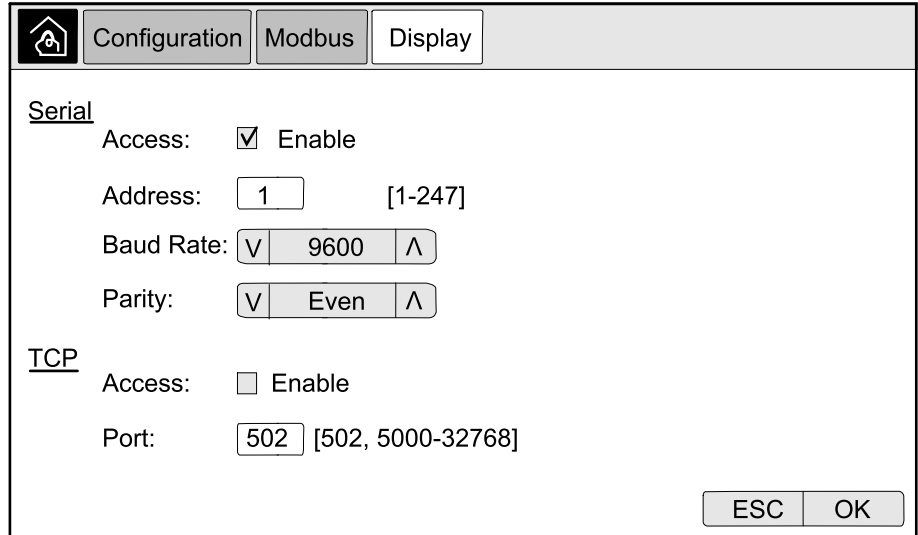

The screenshot shows the Modbus configuration interface. At the top, there are three tabs: 'Configuration' (with a home icon), 'Modbus', and 'Display'. The 'Modbus' tab is selected. Below the tabs, there are two sections: 'Serial' and 'TCP'. The 'Serial' section has 'Access' checked (Enable), 'Address' set to 1 (range [1-247]), 'Baud Rate' set to 9600, and 'Parity' set to Even. The 'TCP' section has 'Access' unchecked (Disable) and 'Port' set to 502 (range [502, 5000-32768]). At the bottom right, there are 'ESC' and 'OK' buttons.

3. Tap **OK** to confirm your settings.

Restore Default Configuration

1. From the home screen on the display select **Configuration > Restore Defaults**.

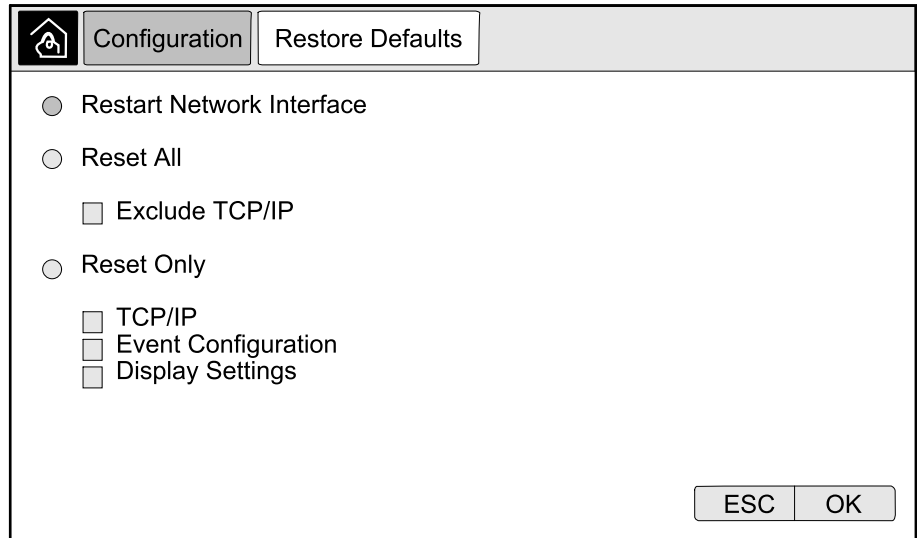

2. Select one of the below options:
 - **Restart Network Interface:** Select this option to restart network interface.
 - **Reset All:** Select this option to reset all settings to default. You can select to leave out the TCP/IP settings from the reset procedure.
 - **Reset Only:** Select this option if you only wish to reset parts of the settings to default values. You can select to reset the following settings: **TCP/IP**, **Event Configuration**, and **Display Settings**.
3. When you have made your selection, tap **OK** to reset the selected settings to default.

Operation Procedures

Access Password-Protected Screens

V				Λ
Pin				
<input type="text"/>				
1	2	3	±	
4	5	6	:	
7	8	9	.	
0	ESC	DEL	↩	

1. When prompted for the password, select your username.
2. Type in the pin code for your username.
NOTE: The default pin code is 1234.
3. Change the password. For more information see .

View the System Status Information

1. From the home screen on the display select **Status**.
2. Select the area for which you wish to see the status. Choose between:

Input

Phase-to-Neutral⁴	
Voltage (phase-to-neutral)	The present phase-to-neutral input voltage in volts (V).
Current	The present input current from the AC utility power source per phase in amperes (A).
Maximum RMS Current	The maximum current for the latest 30 days.
Apparent Power	The present apparent power input for each phase in kVA. Apparent power is the product of RMS (root mean square) volts and RMS amperes.
Active Power	The present active power (or real power) input for each phase in kilowatts (kW). Active power is the portion of power flow that, averaged over a complete cycle of the AC waveform, results in net transfer of energy in one direction.
Power Factor	The ratio of the active power to apparent power.
Phase-to-Phase	
Voltage (phase-to-phase)	The present phase-to-phase input voltage.
Total Apparent Power	The present total apparent power input (for all three phases) in kVA.
Total Active Power	The present total active power input (for all three phases) in kW.
Frequency	The present input frequency in hertz (Hz).
Energy	The total energy consumption since the time of installation or since the number was reset.

4. Only applicable in systems with neutral connection.

Output

Phase-to-Neutral⁵	
Voltage (phase-to-neutral)	The phase-to-neutral output voltage at the inverter in volts (V).
Current	The present output current for each phase in amperes (A).
Maximum RMS Current	The maximum current for the latest 30 days.
Apparent Power	The present apparent power output for each phase in thousands of Volt-Amps (kVA). Apparent power is the product of RMS (root mean square) volts and RMS amperes.
Active Power	The present active power (or real power) output for each phase in kilowatts (kW). Active power is the portion of power flow that, averaged over a complete cycle of the AC waveform, results in net transfer of energy in one direction.
Power Factor	The present output power factor for each phase. Power factor is the ratio of active power to apparent power.
Current Crest Factor	The present output crest factor for each phase. The output crest factor is the ratio of the peak value of the output current to the RMS (root mean square) value.
Current THD	The THD (total harmonic distortion) for each phase, as a percentage, for the present output current.
Phase-to-Phase	
Voltage (phase-to-phase)	The phase-to-phase output voltage at the inverter in volts (V).
Total Apparent Power	The present apparent power output for each phase in thousands of Volt-Amps (kVA). Apparent power is the product of RMS (root mean square) volts and RMS amperes.
Total Active Power	The present total active output power (for all three phases) in kilowatts (kW).
Load	The percentage of the UPS capacity presently used across all phases. The load percentage for the highest phase load is displayed.
Neutral Current ¹	The present output neutral current in amperes (A).
Frequency	The present output frequency in hertz (Hz).
Inverter Status	The general condition of the inverter.
PFC Status	The general condition of the PFC.
Energy	The total energy supplied since the time of installation or since the value was reset.

5. Only applicable in systems with neutral connection.

Bypass

Phase-to-Neutral⁶	
Voltage (phase-to-neutral)	The present phase-to-neutral bypass voltage (V).
Current	The present bypass current for each phase, in amperes (A).
Maximum RMS Current	The maximum current for the latest 30 days.
Apparent Power	The present apparent bypass power for each phase in thousands of Volt-Amps (kVA). Apparent power is the product of RMS (root mean square) volts and RMS amperes.
Active Power	The present active bypass power for each phase in kilowatts (kW). Active power is the time average of the instantaneous product of voltage and current.
Power Factor	The present bypass power factor for each phase. Power factor is the ratio of active power to apparent power.
Phase-to-Phase	
Voltage (phase-to-phase)	The present phase-to-phase bypass voltage (V).
Total Apparent Power	The present total apparent bypass power (for all three phases) in thousands of Volt-Amps (kVA).
Total Active Power	The present total active bypass power (for all three phases) in kilowatts (kW).
Frequency	The present bypass frequency in hertz (Hz).

Battery

Voltage	The present battery voltage.
Current	The present battery current in amperes (A). A positive current indicates that the battery is charging; a negative current indicates that the battery is discharging.
Power	The present DC power being drawn from the battery, in kilowatts (kW).
Estimated Charge Level	The present battery charge, as a percentage of full charge capacity.
Estimated Charge Time	The estimated time, in minutes, until the batteries reach 100% charge.
Runtime Remaining	The amount of time in hours and minutes before the batteries reach the low-voltage shutdown level.
Charger Mode	The operation mode of the charger (Off, Float, Boost, Equalization, Cyclic, Test).
Battery Status	The general condition of the battery.
Charger Status	The general condition of the charger.
Total Battery Capacity	The total capacity available from the available batteries.

Temperature

Ambient Temperature	Ambient temperature in degrees Celsius or Fahrenheit at the air intake of the UPS.
Exhaust Air Temperature	Exhaust air temperature in degrees Celsius or Fahrenheit at the air exhaust of the UPS.

6. Only applicable in systems with neutral connection.

System

Output Voltage	The phase-to-phase output voltage at the inverter in volts (V).
Output Current	The present output current for each phase in amperes (A).
Output Frequency	The present output frequency in hertz (Hz).
Runtime Remaining	The amount of time in hours and minutes before the batteries reach the low-voltage shutdown level.
System Time	The time of the UPS system.
UPS Operation Mode	The operation mode of the operated UPS.
System Operation Mode	The operation mode of the complete UPS system.
Total Output Power	The apparent and active power (or real power) output for each phase.
Output Power	The phase-to-phase apparent and active power (or real power) output for each phase.

Parallel System

Input Current	The present phase-to-phase input current in amperes (A).
Output Current	The present phase-to-phase output current in amperes (A).
Bypass Current	The present phase-to-phase bypass current in amperes (A).
Parallel UPS Number	The parallel UPS number of the operated UPS.
Parallel system redundancy	The redundancy for the parallel system.
Number of Parallel Units	The total number of UPSs in the parallel system.
Parallel Units	The numbers of all UPSs in the parallel system.
Output Total Apparent Power	The present total apparent output power (for all three phases) in thousands of Volt-Amps (kVA).
Output Total Load	The percentage of the UPS system capacity presently used across all phases. The load percentage for the highest phase load is displayed.

Active Alarms

Active Alarms	For more information on active alarms, go to View the Active Alarms, page 62.
---------------	---

Mimic

Mimic	The mimic diagram shows the current status of the main parts of the UPS system: power sources, converters, bypass static switch and breakers, and it shows the power flow through the system.
-------	---

3. Tap the home button to exit the screens and return to the home screen.

Start a Boost Charge of the Batteries

Boost charge gives the possibility of doing a fast recharge of a discharged battery.

NOTE: Boost charge must be enabled by Schneider Electric during start-up for this option to be available.

1. From the home screen on the display select **Control > Charger Mode**.

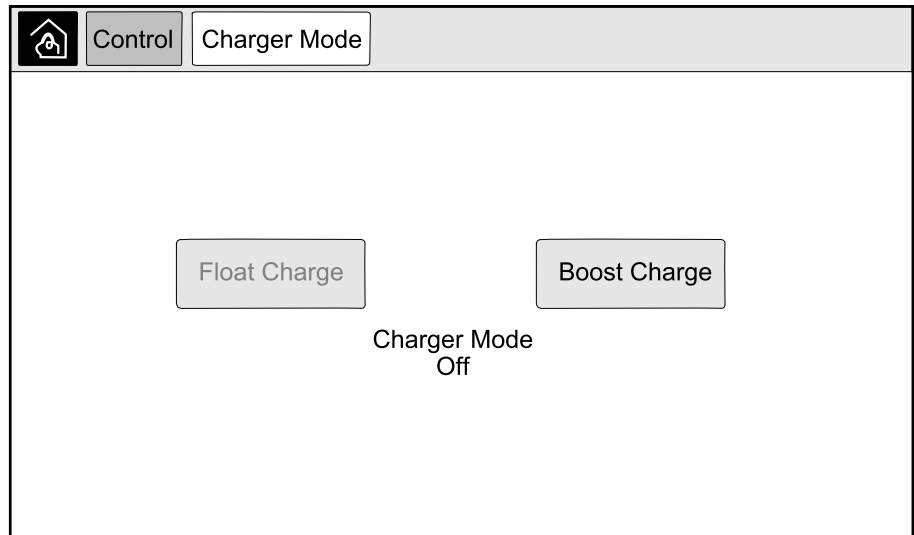

2. Select **Boost Charge** to initiate a single boost charge of the batteries.
The UPS system starts boost charging the batteries.
To stop the boost charge and go back to float charge, select **Float Charge**.

Access a Configured Network Management Interface

The below procedure describes how to access the network management interface from a web interface. It is also possible to use the following interfaces:

- Telnet and SSH
- SNMP
- FTP
- SCP

NOTE: Ensure that only one network management interface in the entire system is set to synchronize time.

Use Microsoft Internet Explorer® 7.x or higher on Windows operating systems only or Mozilla® Firefox® 3.0.6 or higher on all operating systems to access the web interface of the network management interface. Other commonly available browsers may work but have not been fully tested.

You can use either of the following protocols when you use the web interface:

- The HTTP protocol, which provides authentication by user name and Pin but no encryption.
 - The HTTPS protocol, which provides extra security through Secure Socket Layer (SSL); encrypts user names, Pin, and data being transmitted; and authenticates Network Management Cards by means of digital certificates.
1. Access the network management interface by its IP address (or its DNS name, if a DNS name is configured).
 2. Enter the user name and password.
 3. To enable or disable the HTTP or HTTPS protocol, use the **Network** menu on the **Administration** tab, and select the **Access** option under the **Web** heading on the left navigation menu.

Operation Procedures for Single UPS Systems

Start Up Single System from Maintenance Bypass Operation

Use this procedure to start up a single system from maintenance bypass operation with the load supplied through the MBB and all other breakers open.

NOTE: Only operate a breaker when the associated breaker LED is green.

Front View of Single UPS

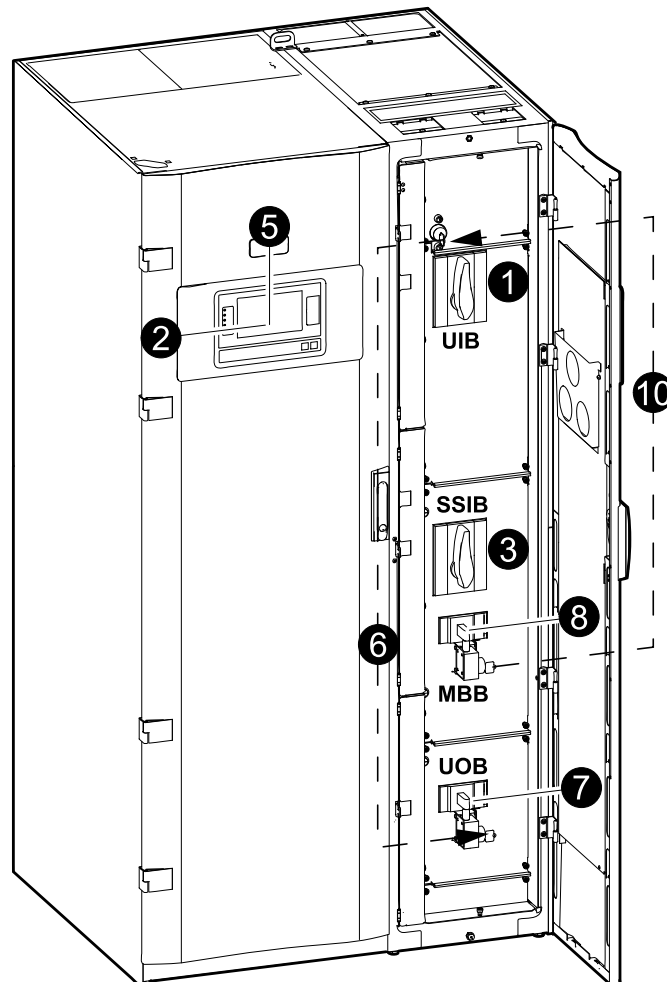

1. Close the unit input breaker UIB on the front of the I/O cabinet.
This will power up the display interface after approximately 30 seconds.
2. From the home screen on the display, select **Control > Startup Wizard**. Select **Startup from Maintenance Bypass** and follow the steps which appear on the screen.

NOTE: The following is a generic startup procedure. Always follow the steps of the **Startup Wizard** which are specific to your system.

3. Close the static switch input breaker SSIB on the front of the I/O cabinet.
4. Close the battery breakers in your specific battery solution.
5. Initiate transfer to static bypass by tapping the **Transfer Load to static bypass** button on the display interface.

In systems with kirk-keys, the key is released from the solenoid key release unit.

If the UPS system does not transfer to requested static bypass, go to **Status > Active Alarms** to see if there are active alarms that prevent the UPS system from transferring to static bypass.

6. In systems with kirk-keys, insert the key in the lock on the unit output breaker UOB and turn to unlock.
7. Close the unit output breaker UOB.
8. Open the maintenance bypass breaker MBB.
The system transfers to normal operation.
9. In systems with kirk-keys, turn the key in the lock of the maintenance bypass breaker MBB to lock open.
The key is released.
10. In systems with kirk-keys, insert the key in the solenoid key release unit.

Shut Down Single System from Normal to Maintenance Bypass Operation

Use this procedure to shut down a single system to maintenance bypass operation with the load supplied through the MBB.

NOTE: Only operate a breaker when the associated breaker LED is green.

Front View of Single UPS

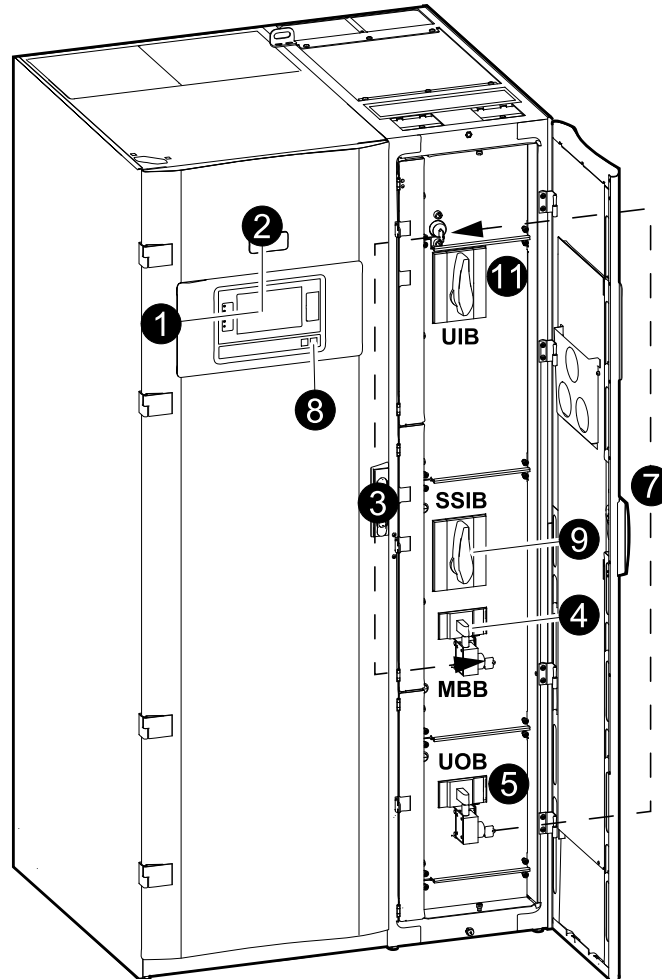

1. From the home screen on the display, select **Control > Shutdown Wizard**. Select **Shut down ending in Maintenance Bypass** and follow the steps which appear on the screen.

NOTE: The following is a generic shutdown procedure. Always follow the steps of the **Shutdown Wizard** which are specific to your system.

2. Initiate transfer to static bypass by tapping the **Transfer Load to static bypass** button on the display interface.

In systems with kirk-keys, the key is released from the solenoid key release unit.

If the UPS system does not transfer to requested static bypass, go to **Status > Active Alarms** to see if there are active alarms that prevent the UPS system from transferring to static bypass.

3. In systems with kirk-keys, insert the key in the lock on the maintenance bypass breaker MBB and turn to unlock.
4. Close the maintenance bypass breaker MBB on the front of the I/O cabinet.
In systems with kirk-keys, the key is held in the lock.
5. Open the unit output breaker UOB.

6. In systems with kirk-keys, turn the key in the lock on the unit output breaker UOB to lock open.
The key is released.
7. In systems with kirk-keys, insert the key in the solenoid key release unit.
8. Initiate transfer to forced static bypass by tapping the Inverter OFF button on the front of the UPS system.
9. Open the static switch input breaker SSIB on the front of the I/O cabinet.
10. Open the battery breakers in your specific battery solution.
11. Open the unit input breaker UIB on the front of the I/O cabinet.

Transfer UPS from Normal to Requested Static Bypass Operation

1. From the home screen on the display select **Control > Operational Mode**.

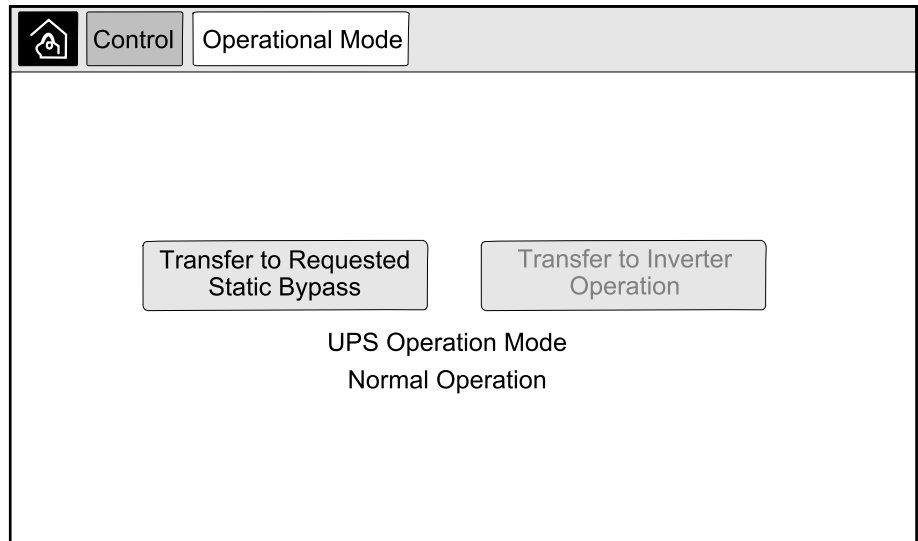

2. Tap the **Transfer to Requested Static Bypass** button.

NOTE: If the conditions for performing a transfer are not met, the button will be grayed out.

3. Verify that the **UPS Operation Mode** changes to **Requested Static Bypass**.

Transfer UPS from Requested Static Bypass Operation to Normal Operation

1. From the home screen on the display select **Control > Operational Mode**.

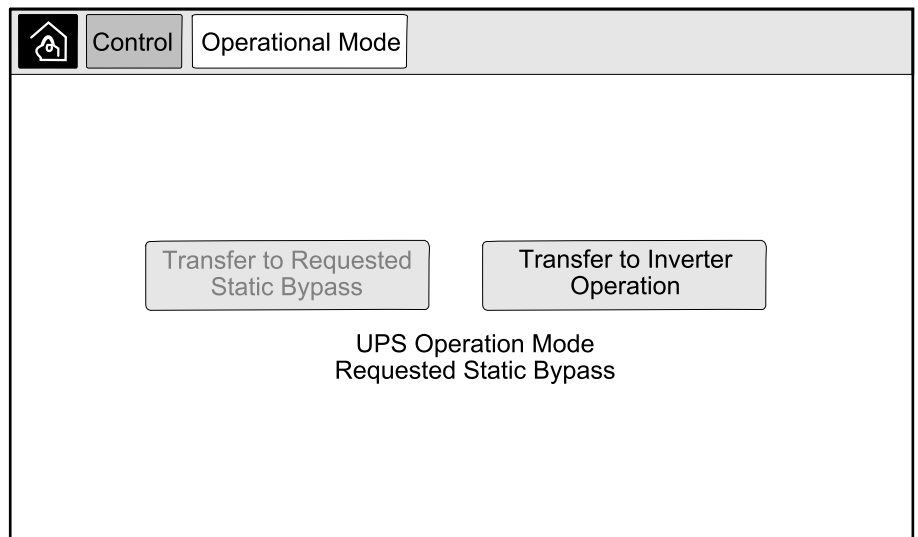

2. Tap the **Transfer to Inverter Operation** button.

NOTE: If the conditions for performing a transfer are not met, the button will be grayed out.

3. Verify that the **UPS Operation Mode** changes to **Normal Operation**.

Operation Procedures for Parallel UPS Systems

Start Up Parallel System from Maintenance Bypass Operation

Use this procedure to start up a parallel system from maintenance bypass operation with the load supplied through the MBB and all other breakers open.

NOTE: Only operate a breaker when the associated breaker LED is green.

Front View of One Parallel UPS and System Bypass Cabinet

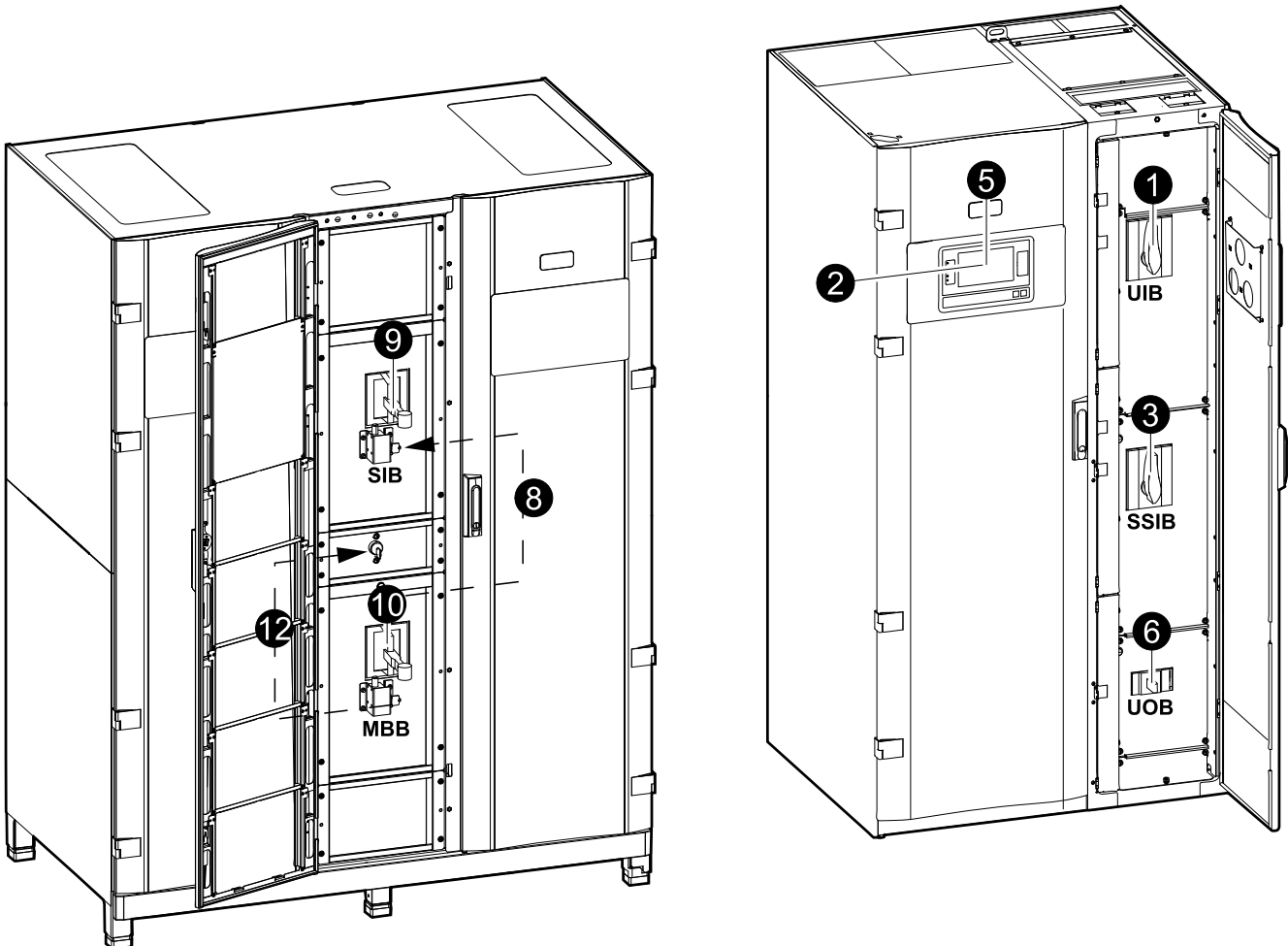

1. Close the unit input breaker UIB on the front of the I/O cabinet.
This will power up the display interface after approximately 30 seconds.
2. From the home screen on the display, select **Control > Startup Wizard**.
Select **Startup from Maintenance Bypass** and follow the steps which appear on the screen.

NOTE: The following is a generic startup procedure. Always follow the steps of the **Startup Wizard** which are specific to your system.

3. Close the static switch input breaker SSIB on the front of the I/O cabinet.
4. Close the battery breakers in your specific battery solution.
5. Initiate transfer to static bypass by tapping the **Transfer Load to static bypass** button on the display interface.

In systems with kirk-keys, the key is released from the solenoid key release unit.

If the UPS system does not transfer to static bypass, go to **Status > Active Alarms** to see if there are active alarms that prevent the UPS system from transferring to static bypass.

6. Close the unit output breaker UOB.
7. Repeat steps 1 to 6 for the remaining UPS units in the parallel system before continuing.
8. In systems with kirk-keys, insert the key from the solenoid key release unit in the lock on the system isolation breaker SIB and turn to unlock.
9. Close the system isolation breaker SIB.
10. Open the maintenance bypass breaker MBB.
The system transfers to normal operation.
11. In systems with kirk-keys, turn the key in the lock of the maintenance bypass breaker MBB to lock open.
The key is released.
12. In systems with kirk-keys, insert the key in the solenoid key release unit.

Shut Down Parallel System from Normal to Maintenance Bypass Operation

Use this procedure to shut down a parallel system to maintenance bypass operation with the load supplied through the MBB.

NOTE: Only operate a breaker when the associated breaker LED is green.

Front View of One Parallel UPS and System Bypass Cabinet

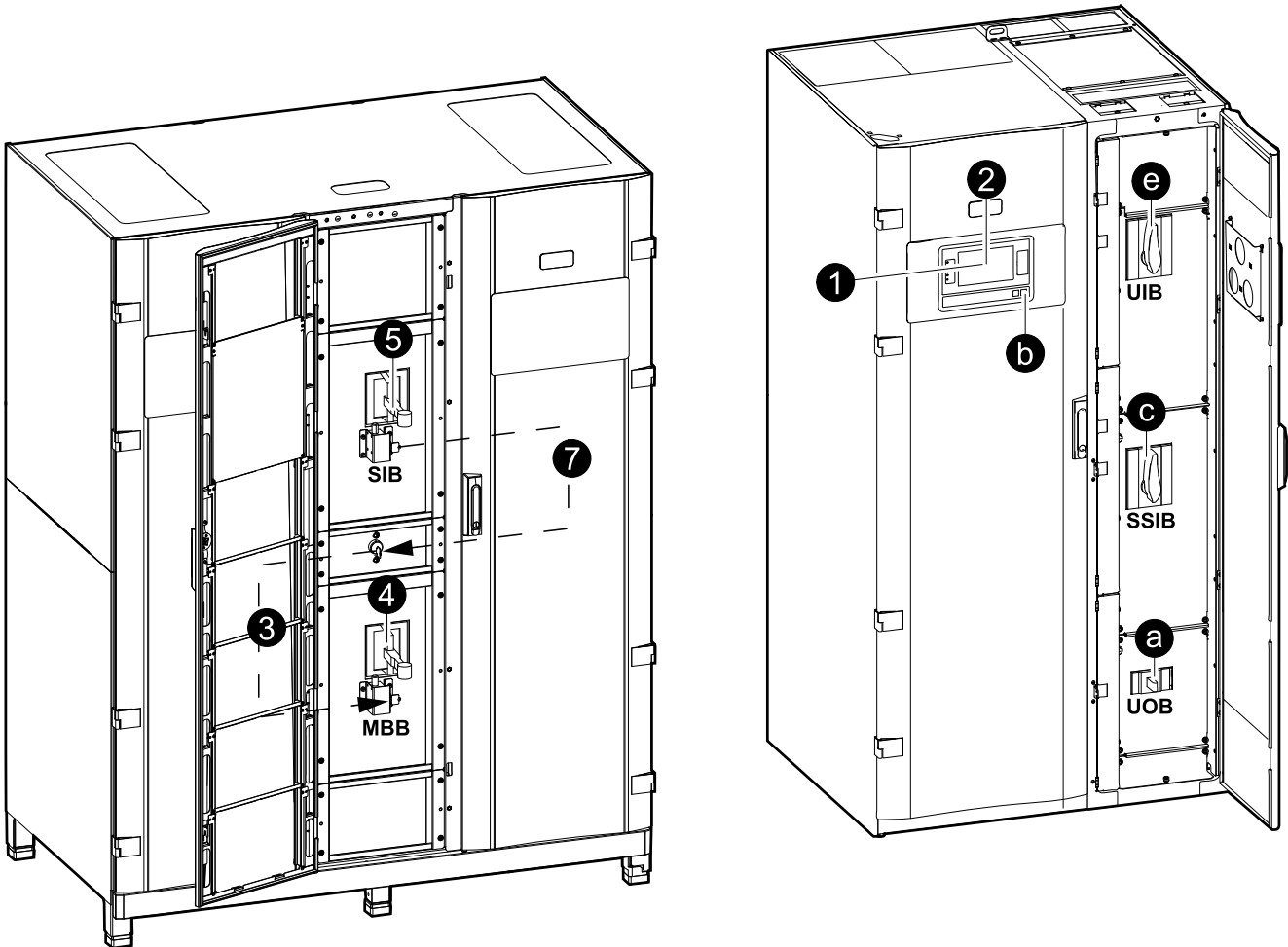

1. From the home screen on the display, select **Control > Shutdown Wizard**. Select **Shut down ending in Maintenance Bypass** and follow the steps which appear on the screen.

NOTE: The following is a generic shutdown procedure. Always follow the steps of the **Shutdown Wizard** which are specific to your system.

2. Initiate transfer to static bypass by tapping the **Transfer Load to static bypass** button on the display interface.

In systems with kirk-keys, the key is released from the solenoid key release unit in the system bypass cabinet.

If the UPS system does not transfer to requested static bypass, go to **Status > Active Alarms** to see if there are active alarms that prevent the UPS system from transferring to static bypass.

3. In systems with kirk-keys, insert the key in the lock on the maintenance bypass breaker MBB and turn to unlock.
4. Close the maintenance bypass breaker MBB in the system bypass cabinet. In systems with kirk-keys, the key is held in the lock.
5. Open the system isolation breaker SIB.

6. In systems with kirk-keys, turn the key in the lock on the system isolation breaker SIB to lock open.
The key is released.
7. In systems with kirk-keys, insert the key in the solenoid key release unit.
8. Perform the following steps for each UPS unit in the parallel system:
 - a. Open the unit output breaker UOB.
 - b. Initiate transfer to forced static bypass by tapping the Inverter OFF button on the front of the UPS system.
 - c. Open the static switch input breaker SSIB on the front of the I/O cabinet.
 - d. Open the battery breakers in your specific battery solution.
 - e. Open the unit input breaker UIB on the front of the I/O cabinet.

Start Up and Add UPS to a Running Parallel System

Use this procedure to start up a UPS and add it to a running parallel system.

NOTE: Only operate a breaker when the associated breaker LED is green.

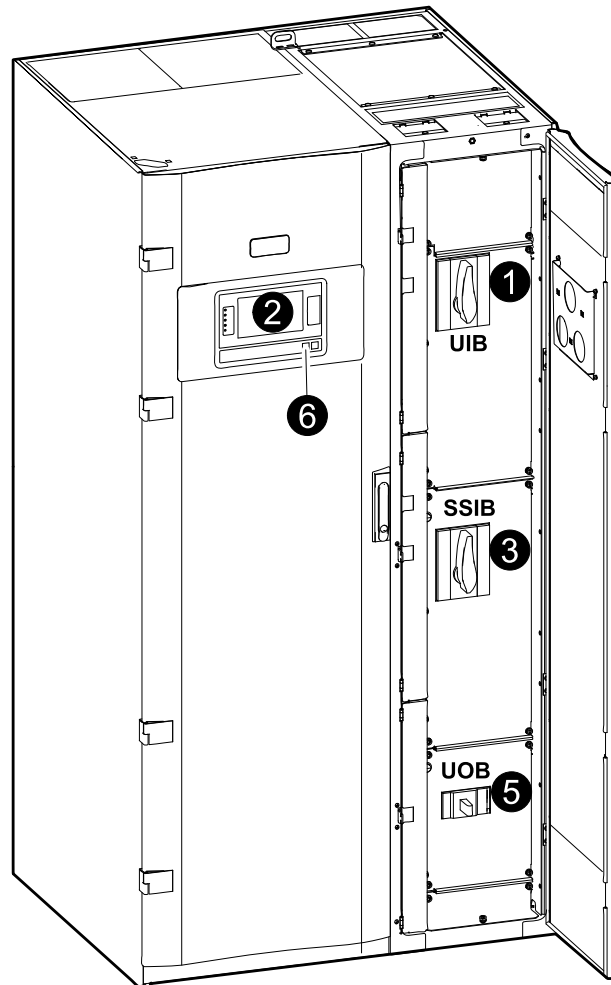

1. Close the unit input breaker UIB on the front of the I/O cabinet.

This will power up the display interface after approximately 30 seconds.

2. From the home screen on the display, select **Control > Startup Wizard**. Select **Startup UPS into a parallel system** and follow the steps which appear on the screen.

NOTE: The following is a generic startup procedure. Always follow the steps of the Startup Wizard which are specific to your system.

3. Close the static switch input breaker SSIB on the front of the I/O cabinet.
4. Close the battery breakers in your specific battery solution.
5. Close the unit output breaker UOB.

NOTE: In systems with additional individual downstream disconnection devices, the additional disconnection devices must be closed before the UOB in the added UPS.

6. Turn the inverter on by tapping the Inverter ON button on the front of the UPS.

Isolate this Single UPS from the Parallel System

Use this procedure to shut down one UPS in a running parallel system.

NOTE: Before initiating this procedure, ensure that the remaining UPS units can supply the load.

NOTE: Only operate a breaker when the associated breaker LED is green.

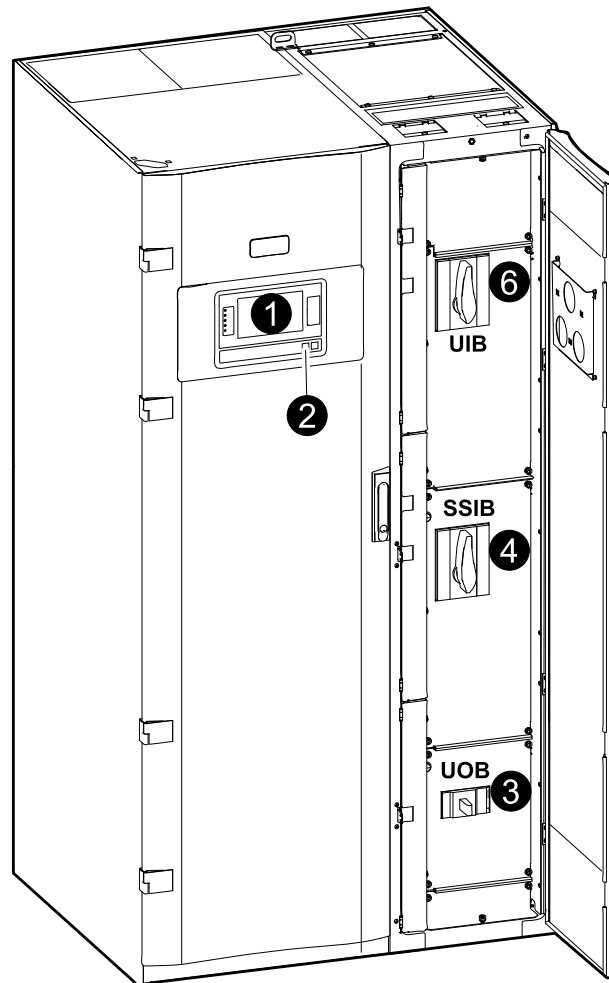

1. From the home screen on the display, select **Control > Shutdown Wizard**. Select **Shut down UPS in a parallel system** and follow the steps which appear on the screen.

NOTE: The following is a generic shutdown procedure. Always follow the steps of the Shutdown Wizard which are specific to your system.

2. Turn off the UPS by pressing the Inverter OFF key on the front of the UPS.
3. Open the unit output breaker UOB.
4. Open the static switch input breaker SSIB on the front of the I/O cabinet.
5. Open the battery breakers in your specific battery solution.
6. Open the unit input breaker UIB on the front of the I/O cabinet.

Operation Procedures for Frequency Converter Systems

Start-Up System Operating as Frequency Converters

Use this procedure to start up a single system, a parallel system working as frequency converters, or to start up a single frequency converter and add it into a running parallel system working as frequency converters.

NOTE: Only operate a breaker when the associated breaker LED is green.

1. Close the unit input breaker UIB on the front of the I/O cabinet.
This will power up the display interface after approximately 30 seconds.
2. From the home screen on the display, select **Control > Startup Wizard**. Select **Startup from Off Operation** and follow the steps which appear on the screen.

NOTE: The following is a generic startup procedure. Always follow the steps of the **Startup Wizard** which are specific to your system.

3. Close the battery breakers BB1 and BB2 (if present).
4. Close the unit output breaker UOB.
5. Close the system isolation breaker SIB.
6. Tap **Turn Inverter On** on the display interface.

Shut Down System Operating as Frequency Converters

Use this procedure to shut down a single system, a parallel system operating as frequency converters.

NOTE: Only operate a breaker when the associated breaker LED is green.

1. From the home screen on the display, select **Control > Shutdown Wizard**. Select **Shutdown ending in Off Operation** and follow the steps which appear on the screen.

NOTE: The following is a generic shutdown procedure. Always follow the steps of the **Shutdown Wizard** which are specific to your system.

2. Open the unit output breaker UOB.
3. Open battery breakers BB1 and BB2 (if present).
4. Open the unit input breaker UIB on the front of the I/O cabinet.
5. Repeat steps 1 to 4 on each Galaxy VM in the parallel system.
6. Open the system isolation breaker (if present).

Maintenance

User-Replaceable Parts

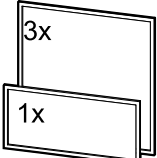
Part	Replacement Procedure	
Filter Kit (GVMDFW-KIT)	<ul style="list-style-type: none"> • Replace the Top Filter, page 54 • Replace the Three Bottom Filters, page 55 	

Replace the Top Filter

Rear View of the Front Door

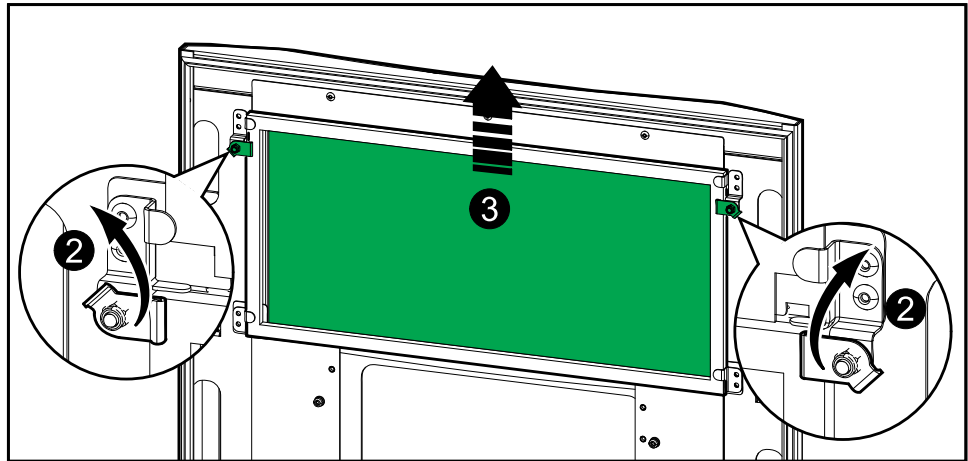

1. Open the front door of the cabinet.
2. Turn the filter locks to release the filter.
3. Lift up the filter.
4. Take the replacement filter from the installation kit and install the new filter.
5. Turn the filter locks to fasten the filter.

Replace the Three Bottom Filters

Rear View of the Front Door

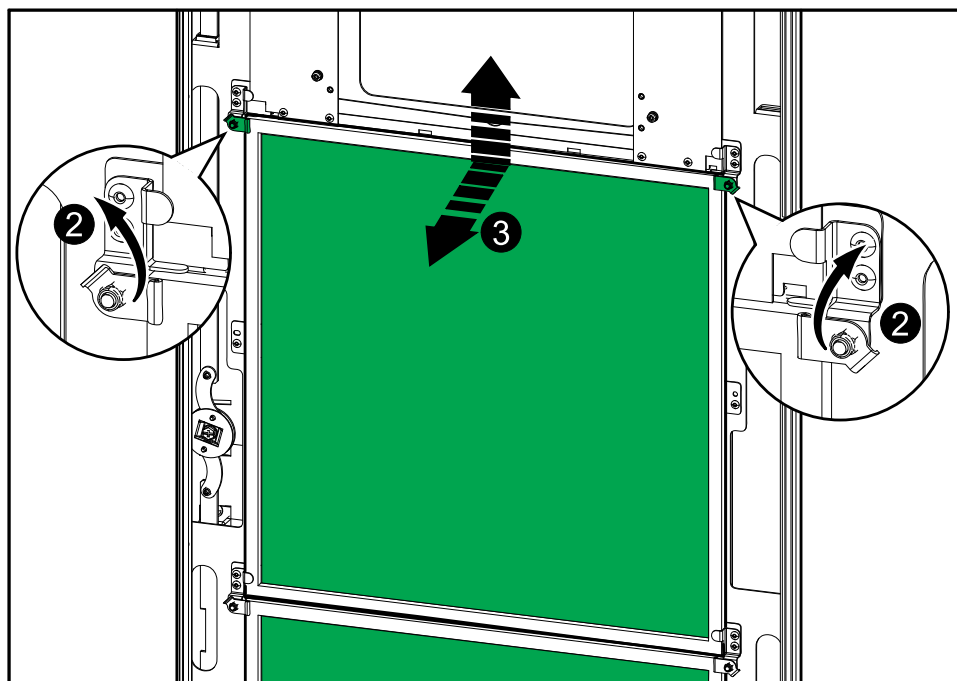

1. Open the front door of the cabinet.
2. Turn the filter locks to release the filters.
3. Tilt the filters out and lift them up.
4. Take the replacement filters from the installation kit and install the new filters.
5. Turn the filter locks to fasten the filters.

Troubleshooting

Troubleshooting via the Mimic Diagram LEDs

The mimic diagram shows the status of the main functions and the energy flow supplying the load. The different LEDs are either green, red or turned off depending on the status of the system functions. In this section it is listed what a red LED on the mimic diagram is indicating to help troubleshooting.

Input LED

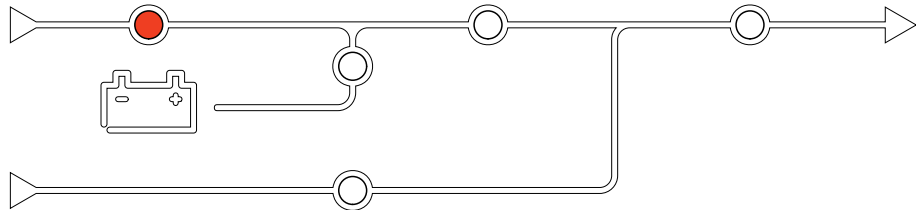

If the input LED is red, it can be caused by the following:

- UIB is open
- Input out of tolerance (waveform-, voltage-, or frequency out of tolerance)

Inverter LED

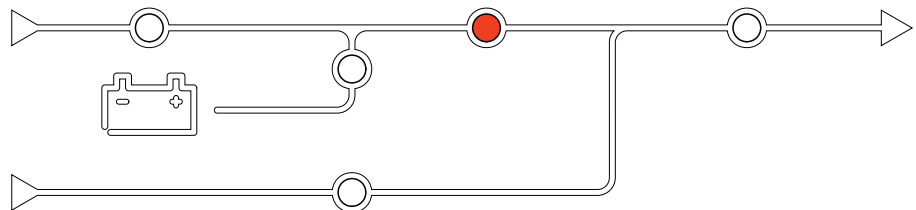

If the inverter LED is red, it can be caused by the following:

- Inverter inoperable

Load LED

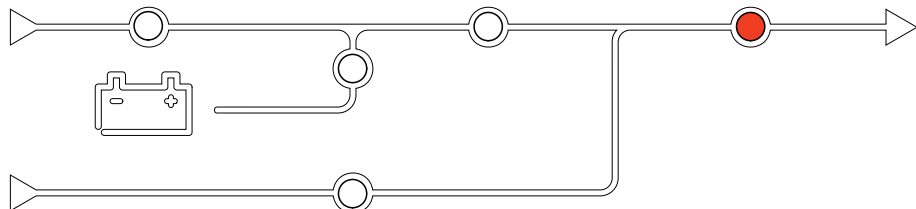

If the load LED is red, it can be caused by the following:

- UOB is open
- SIB is open
- Output voltage out of tolerance

Battery LED

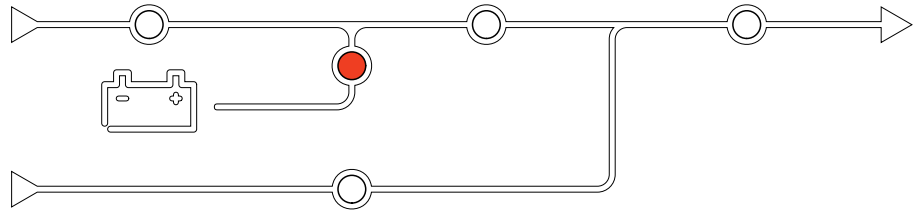

If the Battery LED is red, it can be caused by the following:

- Critical battery alarm active
- Charger inoperable
- Battery breaker disconnected

Bypass LED

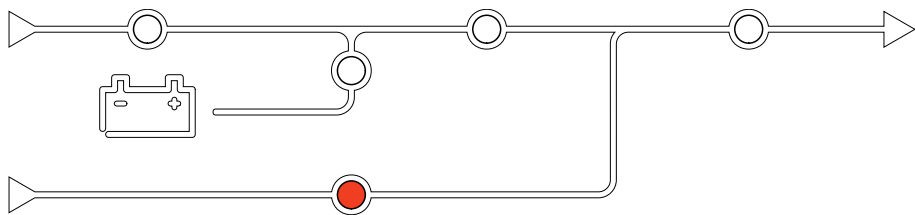

If the bypass LED is red, it can be caused by the following:

- SSIB is open
- Static bypass switch inoperable
- Bypass out of tolerance

Reboot the Display

NOTE: A reboot of the display does not impact the settings made.

1. Open the shutter door on the front right side of the display.
2. Press the reboot button (A) with a pointed object like a pen or a paper clip.

Display Model 1

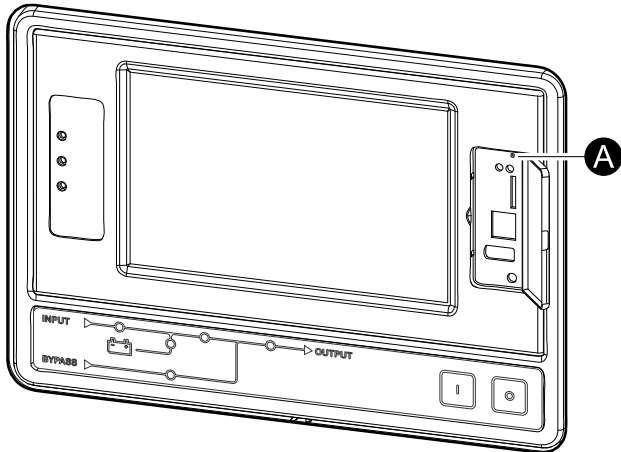

Display Model 2

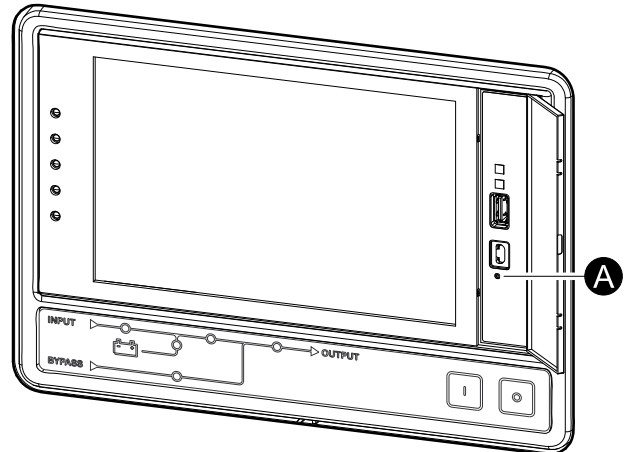

The display is rebooted.

Logs

There are two types of logs:

- NMC Log: Contains information about the display and network activities.
- UPS Log: Contains information about the system status and operation modes.

View the NMC Log

1. From the home screen on the display select **Logs > NMC Log**.
2. You can browse through the list of the events using the arrows.

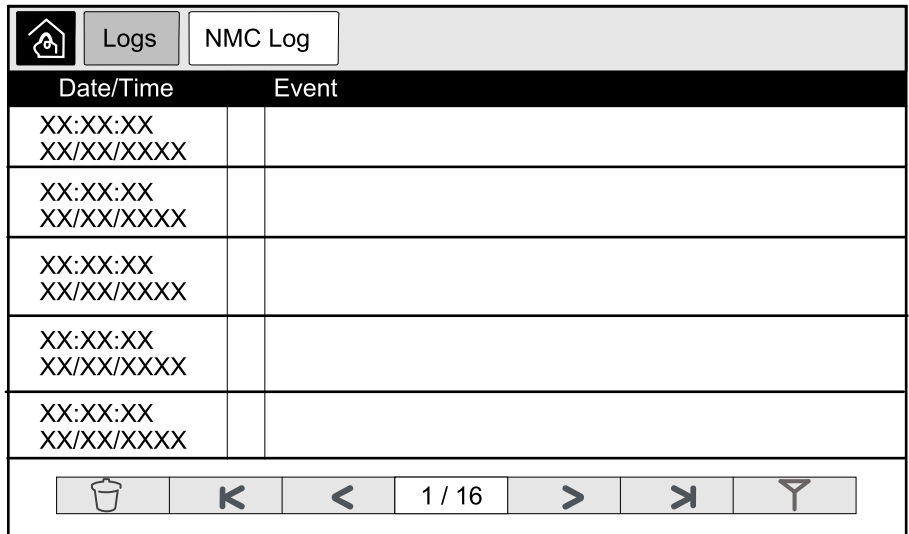

3. You can now perform the following operations in the event log:
 - a. Tap the filter button to filter the events. Different filter settings are available, including:

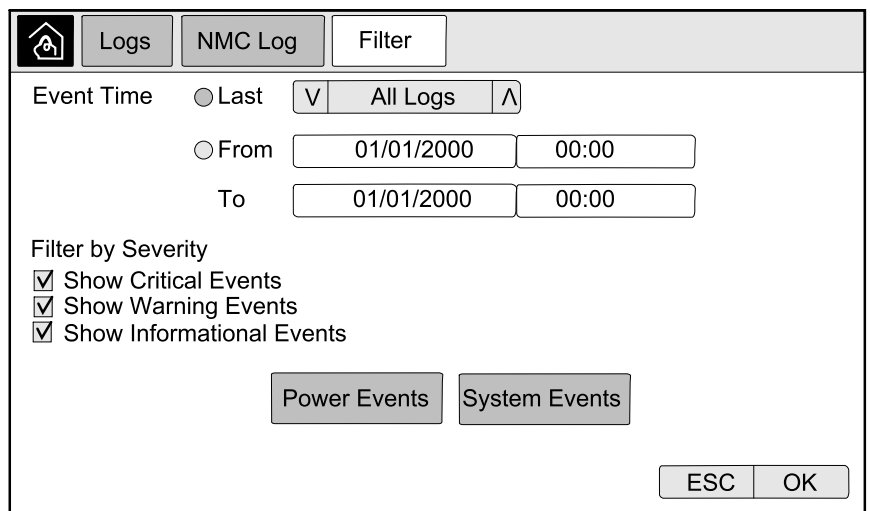

Filters for **Power Events**: **Communication, Device, Output, Input, Battery, UPS Operation Mode, Parallel System, Reminders, Switchgear, and/or RFC 1628 MIB.**

Filters for **System Events**: **Mass Configuration and/or Security.**

- b. Tap the recycle bin button to clear the event log and select **Yes** to confirm.
4. Tap the home button to exit the log.

View the UPS Log

1. From the home screen on the display select **Logs > UPS Log**.

Date/Time		Event
XX:XX:XX XX/XX/XXXX		
XX:XX:XX XX/XX/XXXX		
XX:XX:XX XX/XX/XXXX		
XX:XX:XX XX/XX/XXXX		
XX:XX:XX XX/XX/XXXX		

Refresh

1 / 16

2. You can now browse through the list of the UPS events using the arrows.
3. You can perform the following operations in the UPS log:
 - a. Tap the filter button to filter the events. Different filter settings are available, including:
 Filters for **Power Events: Communication, Device, Output, Input, Battery, UPS Operation Mode, Parallel System, Reminders, Switchgear, and/or RFC 1628 MIB.**

 Filters for **System events: Mass Configuration and/or Security.**
 - b. Tap the recycle bin button to clear the UPS log and select **Yes** to confirm.
4. Tap the home button to exit the log.

Export Data from Logs

The exported log can only be used by Schneider Electric customer support for analysis.

1. From the home screen on the display select **Logs > Export Data**.
2. Insert a USB device in the USB port (A) located on the front of the display.

Display Model 1

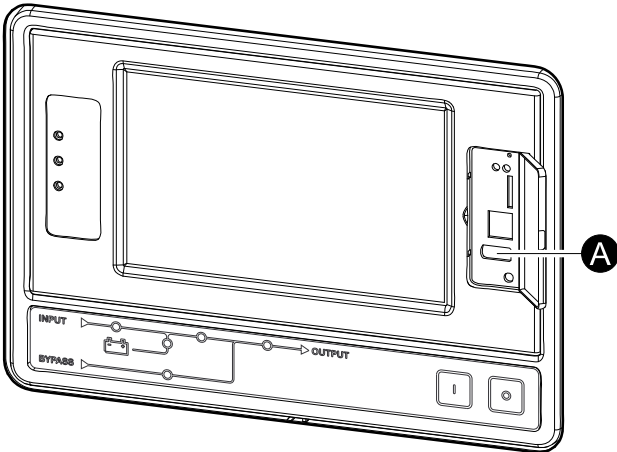

Display Model 2

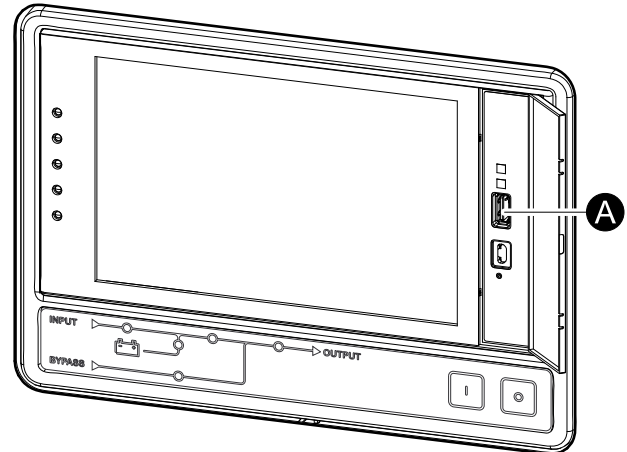

3. Tap the **Start Data Export** button.
When the download is complete, the following message will be shown on the screen: **Data Exported Successfully. Remove USB device.**
4. Remove the USB device and tap the home button to exit the screen.
5. The exported data on the USB device can now be sent to Schneider Electric support for analyzing.

View the Active Alarms

When there is an active alarm in the system, a symbol indicating the alarm level is shown in the top right corner of the screen and the buzzer is active.

1. From the home screen on the display select **Status > Active Alarms**. Tapping the display will also silence the buzzer temporarily without login. By logging in and tapping the display, the buzzer will be silenced permanently.
2. You can now browse through the list of active alarms using the left and right arrows.
3. Tap the **Refresh** button to update the list with the latest active alarms.

Alarm Levels

There are three alarm levels:

- **Critical:** Take immediate action and call Schneider Electric.
- **Warning:** The load remains supported, but action must be taken. Call Schneider Electric.
- **Informational:** No immediate action required. Check the cause of the alarm as soon as possible.

Alarm Messages

Alarm/Event	Severity	Display Text	Description	Corrective Action Text
Alarm	Warning	Abnormal state at input contact zone A	An abnormal state exists for integrated Environmental Monitor input contact zone A.	Please check the environment
Alarm	Warning	Abnormal state at input contact zone B	An abnormal state exists for integrated Environmental Monitor input contact zone B.	Please check the environment
Alarm	Warning	Air Filter technical check recommended	The air filters need to be checked as preventive maintenance is recommended.	The Air Filters may need to be replaced.
Alarm	Warning	Ambient temperature high	Ambient temperature is high.	
Alarm	Warning	Ambient temperature out of tolerance	The ambient temperature out of tolerance.	
Alarm	Warning	Batteries are discharging	The load is drawing more power than the UPS can draw from the input, causing the UPS to draw power from the batteries.	
Alarm	Warning	Battery breaker BB1 open	Battery breaker BB1 is open.	
Alarm	Warning	Battery breaker BB2 open	Battery breaker BB2 is open.	
Alarm	Warning	Battery capacity is below minimum acceptable level	The battery capacity is below the minimum acceptable value according to UPS power rating. Risk of battery damage.	Change battery configuration and/or add larger capacity battery
Event	Informational	Battery breakers tripped	To prevent the batteries deep discharging, the battery breakers have been tripped by the system.	Close the battery breakers manually.
Alarm	Warning	Battery condition is poor	Battery capacity is lower than 50%.	Batteries should be replaced.
Alarm	Warning	Battery condition is weak	Battery capacity is between 50% to 75%.	
Alarm	Warning	Battery is below minimum acceptable runtime	The battery runtime is below configured minimum acceptable value.	

Alarm/Event	Severity	Display Text	Description	Corrective Action Text
Alarm	Critical	Battery is not working correctly	A battery is not working correctly.	Please contact Schneider Electric.
Alarm	Warning	Battery room ventilation inoperable	Input relay indicates that the battery room ventilation is not working correctly.	
Alarm	Warning	Breaker MBB closed	Maintenance bypass breaker MBB is closed, feeding the load with unprotected power from bypass.	
Alarm	Warning	Breaker SIB open	System isolation breaker SIB is open, and system cannot feed the load.	
Alarm	Warning	Breaker SSIB open	Bypass static switch input breaker SSIB is open, making static bypass operation unavailable.	
Alarm	Warning	Breaker UIB open	Unit input breaker UIB is open, and the UPS is prevented from running in normal operation.	
Alarm	Warning	Breaker UOB open	Unit output breaker UOB is open, and UPS cannot feed the load.	
Alarm	Warning	Bypass frequency out of tolerance	Bypass input frequency is out of tolerance.	Check bypass input frequency and bypass input frequency setting.
Alarm	Warning	Bypass phase missing	Bypass input is missing a phase.	Check bypass input. Please contact Schneider Electric.
Alarm	Warning	Bypass phase sequence incorrect	The phase rotation on bypass input is incorrect.	Check bypass input. Please contact Schneider Electric.
Alarm	Warning	Bypass voltage out of tolerance	Bypass input voltage is out of tolerance and UPS is prevented from going into requested bypass mode.	
Alarm	Warning	Charge power is reduced	The battery charge power has been reduced.	The input for this functionality was activated, or the input current has reached the maximum limit. Please contact Schneider Electric.
Alarm	Warning	Communication cable termination missing or damaged	One or more communication cable terminators is/are missing or damaged.	
Alarm	Warning	Confirm redundancy lost and/or transfer to Forced Static Bypass	Off button has been pushed and user must confirm that the redundancy will be lost and/or system will transfer to Forced Static Bypass.	
Alarm	Warning	Confirm Turn Load Off	Off button has been pushed while inverter is on and with no bypass available. User must confirm that the UPS turns off the power to the load.	Confirm turn off either via display or by pushing the off button again.
Alarm	Informational	Customer Input 1 activated	Customer input relay 1 is activated.	
Alarm	Informational	Customer Input 2 activated	Customer input relay 2 is activated.	
Alarm	Warning	Delayed transfer from battery to normal operation	The delayed transfer from battery to normal operation is active.	
Alarm	Warning	Display communication is lost	Main Controller is unable to communicate with the display.	Please contact Schneider Electric.
Alarm	Warning	Display firmware incompatibility detected	The firmware of the display is detected as incompatible with the rest of the system.	Perform a firmware update.
Alarm	Critical	EPO Switch Activated	An emergency power off (EPO) switch is activated.	Deactivate the Emergency Power Off switch.
Alarm	Warning	External battery monitoring detected fault	Input relay indicates external battery monitoring detected fault	

Alarm/Event	Severity	Display Text	Description	Corrective Action Text
Alarm	Critical	External charger off command: activated	Input relay for charger off is activated.	Please contact Schneider Electric.
Alarm	Critical	External energy storage monitoring: major alarm	Input relay indicates external energy storage monitoring has detected a major alarm.	Please contact Schneider Electric.
Alarm	Warning	External energy storage monitoring: minor alarm	Input relay indicates external energy storage monitoring has detected a minor alarm	Please contact Schneider Electric.
Alarm	Warning	External sync frequency out of tolerance	External sync frequency is out of tolerance.	Check external sync frequency.
Alarm	Warning	External sync phase missing	External sync is missing a phase.	Check External sync.
Alarm	Warning	External sync phase sequence incorrect	The phase rotation on external sync is incorrect.	Please contact Schneider Electric.
Alarm	Warning	External sync temporarily disabled	External sync has been temporarily disabled because UPS cannot lock and synchronize to the external sync source.	Check external sync
Alarm	Warning	External sync voltage out of tolerance	External sync voltage is out of tolerance and UPS is prevented from going into external sync mode.	
Alarm	Critical	Fan inoperable	UPS has one or more inoperable fans. Fan redundancy is lost.	
Alarm	Critical	Firmware update - Incorrect UPS operation mode	The UPS is no longer in the correct operation mode during firmware update. Risk of load drop.	Transfer UPS to maintenance bypass.
Alarm	Warning	Firmware versions in parallel UPS units are not identical	The firmware versions in parallel UPS units are not identical.	Firmware update all UPS units in the parallel system to the same version
Alarm	Critical	Flywheel inoperable	Input relay indicates that the flywheel is not working correctly.	
Alarm	Informational	Forced battery operation activated	Forced battery operation has been activated by user.	
Alarm	Critical	General parallel system event	The parallel system is not configured correctly or is not working correctly.	Please contact Schneider Electric.
Alarm	Informational	Genset is supplying the UPS	Input relay indicates that a genset is supplying the UPS.	
Alarm	Warning	Ground fault detected	Input relay indicates that a ground fault has been detected.	Please contact Schneider Electric.
Alarm	Warning	High Battery Temperature Level	The battery temperature is above the Alarm setting.	Check the battery temperature. A high temperature may decrease the battery lifetime.
Alarm	Informational	High Efficiency Mode disabled	High efficiency mode is disabled from an input relay.	
Alarm	Warning	High humidity threshold violation at remote sensor	A high humidity threshold violation exists for integrated Environmental Monitor sensor.	Please check the environment.
Alarm	Warning	High temperature threshold violation at remote sensor	A high temperature threshold violation exists for integrated Environmental Monitor sensor.	Please check the environment.
Alarm	Warning	Input frequency out of tolerance	Mains input frequency is out of tolerance.	Check input frequency and input frequency setting.
Alarm	Warning	Input phase missing	Input is missing a phase.	Check input. Please contact Schneider Electric.
Alarm	Warning	Input phase sequence incorrect	The phase rotation on input is incorrect.	Check input. Please contact Schneider Electric.
Alarm	Warning	Input voltage out of tolerance	Mains input voltage is out of tolerance.	

Alarm/Event	Severity	Display Text	Description	Corrective Action Text
Alarm	Warning	Inverter is Off due to a request by the user	The inverter is off due to a request by the user.	
Alarm	Warning	Inverter output is not in phase with bypass input	The UPS inverter output is not in phase with the bypass input.	
Alarm	Warning	Lost communication to remote sensor	Lost the local network management interface-to-integrated Environmental Monitor.	Please check the environment.
Alarm	Warning	Lost parallel redundancy	The load exceeds limit for an N+x UPS in redundancy (x is the configurable parallel redundancy).	Reduce the load on the system.
Alarm	Warning	Low Battery Temperature Level	The battery temperature is below the Alarm setting.	
Alarm	Warning	Low humidity threshold violation at remote sensor	A low humidity threshold violation exists for integrated Environmental Monitor sensor.	Please check the environment.
Alarm	Warning	Low temperature threshold violation at remote sensor	A low temperature threshold violation exists for integrated Environmental Monitor sensor.	Please check the environment.
Alarm	Warning	Magelis 10 inch display firmware incompatibility detected	The firmware of the Magelis 10 inch display is detected as incompatible with the rest of the system.	Perform a firmware update.
Alarm	Warning	Maximum humidity threshold violation at remote sensor	A maximum humidity threshold violation exists for integrated Environmental Monitor sensor.	Please check the environment.
Alarm	Warning	Maximum temperature threshold violation at remote sensor	A maximum temperature threshold violation exists for integrated Environmental Monitor sensor.	Please check the environment.
Alarm	Warning	Minimum humidity threshold violation at remote sensor	A minimum humidity threshold violation exists for integrated Environmental Monitor sensor.	Please check the environment.
Alarm	Warning	Minimum temperature threshold violation at remote sensor	A minimum temperature threshold violation exists for integrated Environmental Monitor sensor.	Please check the environment.
Alarm	Warning	Modular battery breaker open	Modular battery breaker is open.	
Alarm	Warning	Modular battery cabinet is not working correctly	Modular battery cabinet is not working correctly.	Check battery cabinet. Please contact Schneider Electric.
Alarm	Warning	NMC 1 firmware incompatibility detected	The firmware of the NMC in Smart Slot 1 is detected as incompatible with the rest of the system.	Perform a firmware update.
Alarm	Warning	NMC 2 firmware incompatibility detected	The firmware of the NMC in Smart Slot 2 is detected as incompatible with the rest of the system.	Perform a firmware update.
Alarm	Warning	Not enough UPS units ready to turn on inverter	One or more parallel UPS units have been requested to turn on inverter, but not enough UPS units are ready for system to enter inverter on operation.	Turn on inverter of more UPS units and/or check the setting "Minimum Number of UPS Required to Supply Load".
Alarm	Warning	Output frequency out of tolerance	Output frequency is out of tolerance.	Check output frequency and output frequency setting.
Alarm	Warning	Output voltage out of tolerance	The output voltage is out of tolerance.	
Alarm	Warning	Overload on UPS due to high ambient temperature	The load exceeds the rated capacity when running with high ambient temperature.	Reduce load on system or ambient temperature.
Alarm	Warning	Overload or short circuit on UPS	Reduce load on system or check for output short circuit.	The load exceeds 100% of rated capacity or there is a short circuit on the output.
Alarm	Warning	Parallel communication lost on PBUS cable 1	PBUS cable 1 may be damaged.	Replace parallel Cable 1.

Alarm/Event	Severity	Display Text	Description	Corrective Action Text
Alarm	Warning	Parallel communication lost on PBUS cable 2	PBUS cable 2 may be damaged.	Replace parallel Cable 2.
Alarm	Warning	Parallel mixed operation mode	One or more parallel UPS units are operating in battery operation, while others are operating in normal operation.	
Alarm	Warning	Parallel unit not present	Main Controller is unable to communicate with parallel UPS X. The UPS might have been powered down or communication cables may be damaged.	
Alarm	Warning	Requested Bypass command from input contact activated	Requested Bypass command from input contact activated.	
Alarm	Critical	Restricted air flow	Restricted air flow.	This could be caused by a clogged air filter or other obstacle blocking air flow.
Alarm	Warning	RTC backup battery is discharged	The RTC backup battery is discharged or the time is not set correctly.	
Alarm	Critical	Self-test - Did not pass	Self-test did not complete correctly.	Check event log and active alarms for more details.
Alarm	Warning	Startup recommended	The product has been running overtime without startup.	Please contact Schneider Electric for secure startup.
Alarm	Critical	Static bypass switch inoperable	Static bypass switch is inoperable. UPS is prevented from going into static bypass operation.	Please contact Schneider Electric.
Alarm	Warning	Static bypass switch warning	The static bypass switch needs a technical check but is still fully operational.	Please contact Schneider Electric.
Alarm	Critical	Surveillance detected fault	Surveillance detected fault.	Please contact Schneider Electric.
Alarm	Warning	Synchronization unavailable - system is freerunning	The UPS is unable to synchronize to the bypass input, external source or parallel system.	
Alarm	Critical	System locked in bypass operation	The system is locked in bypass operation.	The system has toggled between inverter operation and bypass operation more than 10 times within 1 minute. Please activate on button to transfer back to normal operation.
Alarm	Critical	System operation mode - Forced Static Bypass	The system is in bypass in response to a critical event or an inverter off request.	
Alarm	Warning	System operation mode - Maintenance Bypass	The system load is supplied through Maintenance Bypass Breaker (MBB).	
Alarm	Critical	System operation mode - Off	The system output power is turned off.	
Alarm	Warning	System operation mode - Requested Static Bypass	The system is in bypass in response to the UPS front-panel or a user-initiated software command, typically for maintenance.	
Alarm	Critical	System operation mode - Static Bypass Standby	The system is in static bypass standby operation in response to a critical event or an inverter off request.	
Alarm	Warning	Technical Check recommended	The product and its batteries need to be checked as preventive maintenance is recommended.	Please contact Schneider Electric.
Alarm	Warning	Transfer from battery to normal operation delay activated	Input relay indicates that the transfer from battery to normal operation delay is activated.	

Alarm/Event	Severity	Display Text	Description	Corrective Action Text
Alarm	Warning	UPS locked in static bypass mode is activated	Input relay for UPS locked in static bypass mode is activated.	
Alarm	Critical	UPS configuration incorrect	UPS is configured incorrectly.	Please contact Schneider Electric.
Alarm	Warning	UPS operation mode - Battery	On battery power in response to an input power problem.	
Alarm	Informational	UPS operation mode - Battery Test	On battery power in response to a test of the performance of the batteries.	
Alarm	Critical	UPS operation mode - Forced Static Bypass	The UPS is in bypass in response to a critical event or an inverter off request.	
Alarm	Informational	UPS operation mode - Initialize	The UPS is initializing.	
Alarm	Informational	UPS operation mode - Inverter Standby	The UPS is ready to enter battery operation but awaits permission from the system. UPS output is off.	
Alarm	Warning	UPS operation mode - Maintenance Bypass	The UPS load is supplied through Maintenance Bypass Breaker (MBB).	
Alarm	Critical	UPS operation mode - Off	The output power is turned off.	
Alarm	Warning	UPS operation mode - Requested Static Bypass	The UPS is in bypass in response to the UPS front-panel or a user-initiated software command, typically for maintenance.	
Alarm	Warning	UPS operation mode - Static Bypass Standby	The UPS is ready to enter static bypass but awaits permission from the system. UPS output is off.	
Alarm	Critical	UPS settings reset to default	Unit settings has been reset to default. The UPS is locked in off operation until settings are confirmed.	Please contact Schneider Electric.
Alarm	Warning	Warranty expiring soon	The product is reaching the end of warranty.	Please contact Schneider Electric.

Tests

The UPS system can perform the following tests to ensure correct performance of the system:

- **Battery Test**
- **Runtime Calibration**
- **Battery SPoT Mode**
- **Annunciators**
- **Display Calibration**

Perform a Battery Test

Prerequisites:

- The batteries must be more than 50% charged.
- The runtime available must be more than 4 minutes.
- The operation mode must be normal operation, eConversion, or ECO mode.
- The system operation mode must be normal, eConversion, or ECO mode.

This feature performs a number of tests on the batteries, such as fuse-blown check, weak battery detection. The test will discharge the battery, and use about 10% of the total capacity. Meaning if you have 10 minutes of runtime, the test will run for 1 minute. The **Battery Test** can be set up to run automatically in different time intervals (from weekly and up to once a year).

1. From the home screen on the display select **Tests > Battery Test**.
2. Tap the **Start Battery Self-Test** button.

NOTE: If you wish to manually stop the battery self-test, tap the **Abort Battery Self-Test** button.

Perform a Runtime Calibration

This feature is used for calibrating the estimated remaining battery runtime value. In this test the UPS transfers to battery operation and the batteries are discharged to the low DC warning level. Based on the elapsed time and information about the load, the battery capacity can be calculated and the estimated runtime calibrated.

Schneider Electric recommends performing battery runtime calibration at start-up, when batteries are replaced, or when changes are made to the battery cabinets.

NOTICE

RISK OF EQUIPMENT DAMAGE

- During a runtime calibration the batteries will be at a very low level and therefore not capable of supporting your system load in case of a input power failure.
- Batteries will be discharged to 10% capacity and this will result in a low battery runtime after the calibration.
- Repeated battery testing or calibration can affect the lifetime of the battery.

Failure to follow these instructions can result in equipment damage.

Prerequisites:

- Batteries must be 100% charged.
- The load percentage must be at least 10% and must not change more than 20% during test.

- The bypass supply must be available.
 - The operation mode must be normal operation, eConversion, or ECO mode.
 - The system operation mode must be inverter, eConversion, or ECO mode.
1. From the home screen on the display select **Tests > Runtime Calibration**.
 2. Tap the **Start Runtime Calibration** button.
NOTE: If you wish to manually stop the runtime calibration, tap the **Abort Runtime Calibration** button.

Perform an Annunciators Test

1. From the home screen on the display select **Tests > Annunciators**.
2. Tap the **Start** button to initiate the test.
During the annunciators test the LEDs on the display and the mimic diagram and the audible alarm are tested.

Calibrate the Display

From the home screen on the display select **Tests > Display Calibration** and then select the calibration you want to perform.

- **Calibrate:** Tests and adjusts the touch screen target sensitivity.
- **Calibration Check:** Checks the calibration adjustments.

Determine if you need a Replacement Part

To determine if you need a replacement part, contact Schneider Electric and follow the procedure below so that the representative can assist you promptly:

1. In the event of an alarm condition, scroll through the alarm lists, record the information, and provide it to the representative.
2. Write down the serial number of the unit so that you will have it easily accessible when you contact Schneider Electric.
3. If possible, call Schneider Electric from a telephone that is within reach of the display so that you can gather and report additional information to the representative.
4. Be prepared to provide a detailed description of the problem. A representative will help you solve the problem over the telephone, if possible, or will assign a return material authorization (RMA) number to you. If a module is returned to Schneider Electric, this RMA number must be clearly printed on the outside of the package.
5. If the unit is within the warranty period and has been started up by Schneider Electric, repairs or replacements will be performed free of charge. If it is not within the warranty period, there will be a charge.
6. If the unit is covered by a Schneider Electric service contract, have the contract available to provide information to the representative.

Find the UPS Serial Number

1. From the home screen on the display interface select **About > UPS**.
2. Note down the serial number and have it ready for customer support.
NOTE: If the display is not available, the serial number can also be found on a label in each specific cabinet.

Return Parts to Schneider Electric

To return an inoperable part to Schneider Electric, contact Schneider Electric customer support to obtain an RMA number.

Pack the part in the original shipping materials, and return it by insured, prepaid carrier. The customer support representative will provide the destination address. If you no longer have the original shipping materials, ask the representative about obtaining a new set.

- Pack the part properly to avoid damage in transit. Never use styrofoam beads or other loose packaging materials when shipping a part. The part may settle in transit and become damaged.
- Enclose a letter in the package with your name, RMA number, address, a copy of the sales receipt, description of the problem, a phone number, and a confirmation for payment (if necessary).

NOTE: Damages sustained in transit are not covered under warranty.

Schneider Electric
35 rue Joseph Monier
92500 Rueil Malmaison
France

+ 33 (0) 1 41 29 70 00



As standards, specifications, and design change from time to time,
please ask for confirmation of the information given in this publication.