

Your OsiSense® Sensors Guide

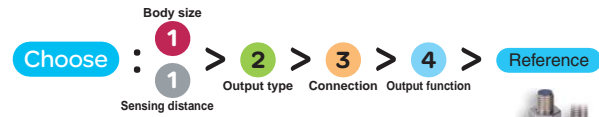

Choose & Use

OsiSense[®] XS Inductive



Flush mountable	Sensing distance, mm (in.)	M8		M12		M18		M30			
		1.5 (0.06)	2.5 (0.10)	2 (0.08)	4 (0.16)	5 (0.20)	8 (0.31)	10 (0.39)	15 (0.59)		
Short	DC3	PNP	cable	XS508B1P A L2	XS108B3P A L2	XS512B1P A L2	XS112B3P A L2	XS518B1P A L2	XS118B3P A L2	XS530B1P A L2	XS130B3P A L2
			connector	XS508B1P A M8	XS108B3P A M8	XS512B1P A M12	XS112B3P A M12	XS518B1P A M12	XS118B3P A M12	XS530B1P A M12	XS130B3P A M12
	NPN	cable	XS508B1N A L2	XS108B3N A L2	XS512B1N A L2	XS112B3N A L2	XS518B1N A L2	XS118B3N A L2	XS530B1N A L2	XS130B3N A L2	
		connector	XS508B1N A M8	XS108B3N A M8	XS512B1N A M12	XS112B3N A M12	XS518B1N A M12	XS118B3N A M12	XS530B1N A M12	XS130B3N A M12	
	DC2	cable	XS508BSD A L2	XS608B3D A L2	XS512BSD A L2	XS612B3D A L2	XS518BSD A L2	XS618B3D A L2	XS530BSD A L2	XS630B3D A L2	
		connector	XS508BSD A M12	XS608B3D A M12	XS512BSD A M12	XS612B3D A M12	XS518BSD A M12	XS618B3D A M12	XS530BSD A M12	XS630B3D A M12	
Long	DC3	PNP	cable	XS508BLP A L2	XS608B1P A L2	XS512BLP A L2	XS612B1P A L2	XS518BLP A L2	XS618B1P A L2	XS530BLP A L2	XS630B1P A L2
			connector	XS508BLP A M12	XS608B1P A M12	XS512BLP A M12	XS612B1P A M12	XS518BLP A M12	XS618B1P A M12	XS530BLP A M12	XS630B1P A M12
	NPN	cable	XS508BLN A L2	XS608B1N A L2	XS512BLN A L2	XS612B1N A L2	XS518BLN A L2	XS618B1N A L2	XS530BLN A L2	XS630B1N A L2	
		connector	XS508BLN A M12	XS608B1N A M12	XS512BLN A M12	XS612B1N A M12	XS518BLN A M12	XS618B1N A M12	XS530BLN A M12	XS630B1N A M12	
	DC2	cable	XS508B1D A L2	XS608B1D A L2	XS512B1D A L2	XS612B1D A L2	XS518B1D A L2	XS618B1D A L2	XS530B1D A L2	XS630B1D A L2	
		connector	XS508B1D A M12	XS608B1D A M12	XS512B1D A M12	XS612B1D A M12	XS518B1D A M12	XS618B1D A M12	XS530B1D A M12	XS630B1D A M12	
AC/DC	cable			XS512B1M A L2	XS612B1M A L2	XS518B1M A L2	XS618B1M A L2	XS530B1M A L2	XS630B1M A L2		
	connector			XS512B1M A U20	XS612B1M A U20	XS518B1M A U20	XS618B1M A U20	XS530B1M A U20	XS630B1M A U20		
Output function	NO		A	A	A	A	A	A	A		
	NC		B	B	B	B	B	B	B		

Accessories



M8	XSZB108
M12	XSZB112
M18	XSZB118
M30	XSZB130

Flush mountable	Sensing distance, mm (in.)	8x22x8 mm		15x32x8 mm		26x26x13 mm		40x40x15 mm		80x80x26 mm	
		2.5 (0.10)	5 (0.20)	10 (0.39)	15 (0.59)	15 (0.59)	25 (0.98)	60 (2.36)			
Flush mountable	DC3	PNP	cable	XS7J1A1P A L2	XS7F1A1P A L2	XS7E1A1P A L2	XS7C1A1P A L2	XS7D1A1P A L2			
			connector	XS7J1A1P A L01M8	XS7F1A1P A L01M8	XS7E1A1P A M8	XS7C1A1P A M8	XS7D1A1P A M12			
	NPN	cable	XS7J1A1N A L2	XS7F1A1N A L2	XS7E1A1N A L2	XS7C1A1N A L2	XS7D1A1N A L2				
		connector	XS7J1A1N A L01M8	XS7F1A1N A L01M8	XS7E1A1N A M8	XS7C1A1N A M8	XS7D1A1N A M12				
	DC2	cable	XS7J1A1D A L2	XS7F1A1D A L2	XS7E1A1D A L2	XS7C1A1D A L2	XS7D1A1D A L2				
		connector	XS7J1A1D A L01M8	XS7F1A1D A L01M8	XS7E1A1D A M8	XS7C1A1D A M8	XS7D1A1D A M12				
Flush adaptable mountable	DC3	PNP	cable			XS8E1A1P A L2	XS8C1A1P A L2	XS8D1A1P A L2			
			connector			XS8E1A1P A M8	XS8C1A1P A M8	XS8D1A1P A M12			
	NPN	cable			XS8E1A1N A L2	XS8C1A1N A L2	XS8D1A1N A L2				
		connector			XS8E1A1N A M8	XS8C1A1N A M8	XS8D1A1N A M12				
	AC/DC	cable			XS8E1A1M A L2	XS8C1A1M A L2	XS8D1A1M A L2				
		connector			XS8E1A1M A L01U20	XS8C1A1M A L01U20	XS8D1A1M A U20				
Output function	NO		A	A	A	A					
	NC		B	B	B	B					

Screw terminal Pg13. For 1/2" NPT add H7.

Flush mountable	Sensing distance, mm (in.)	40x40x117 mm			
		15 (0.59)	20 (0.79)	40 (1.57)	
DC4	PNP	NO+NC	XS7C40PC440	XS8C40PC440	XS8C40PC449
		NPN	NO+NC	XS7C40NC440	XS8C40NC440
DC2		NO	XS7C40DA210	XS8C40DA210	
		NO or NC	XS7C40DP210	XS8C40DP210	
AC/DC		NO or NC	XS7C40MP230	XS8C40MP230	
		NO or NC	XS7C40FP260	XS8C40FP260	

Accessories



For 26x26 XSZBE00 XSZBE90
For 40x40 XSZBC00 XSZBC90

DC3 24V, DC4 24V, AC/DC 24...240V, DC2 24V

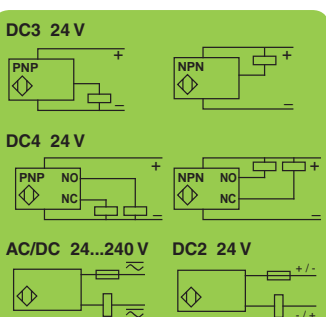

Cabling XS

Pre-wired connectors (female)

Body size	Length	3-pin	4-pin
M8	2 m	straight	XZCP0566L2
		elbowed	XZCP0666L2
	5 m	straight	XZCP0566L5
		elbowed	XZCP0666L5
	10 m	straight	XZCP0566L10
		elbowed	XZCP0666L10
1/2"	3-pin	straight	XZCP1865L5
		elbowed	XZCP1965L5
M12	2 m	straight	XZCP1141L2
		elbowed	XZCP1241L2
	5 m	straight	XZCP1141L5
		elbowed	XZCP1241L5
	10 m	straight	XZCP1141L10
		elbowed	XZCP1241L10
M12	4-pin	(1) straight	XZCC12FDM40B
		(2) straight	XZCC12FCM40B
M12	4-pin	(1) elbowed	XZCC12FDP40B
		(2) elbowed	XZCC12FCP40B

(1) Steel ring (2) Plastic ring

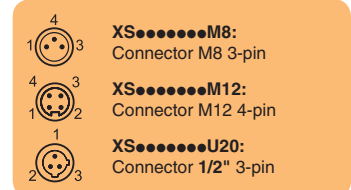

OsiSense® XU Photoelectric

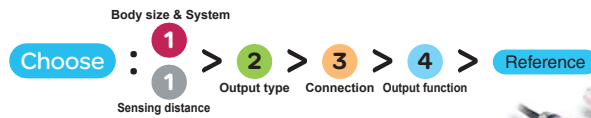

Sensing distance, m (ft)	Output type	Connection	M18 metal	M18 plastic	Miniature	Compact 50x50 mm	Compact 92x71 mm									
Diffuse (T/R)	DC3	PNP	cable	XUB5BP A NL2	XUB5AP A NL2	1 (3.28)	DC3	PNP	cable	XUK5AP A NL2	2.1 (6.89)	DC3	PNP	terminals	XUX5AP A NT16	
			connector 4P	XUB5BP A NM12	XUB5AP A NM12				connector 4P	XUK5AP A NM12				connector 4P	XUX5AP A NM12	
	DC3	NPN	cable	XUB5BN A NL2	XUB5AN A NL2	1 (3.28)	DC3	NPN	cable	XUK5AN A NL2	2.1 (6.89)	DC3	NPN	terminals	XUX5AN A NT16	
			connector 4P	XUB5BN A NM12	XUB5AN A NM12				connector 4P	XUK5AN A NM12				connector 4P	XUX5AN A NM12	
	0.1 (0.33)	DC3	PNP	cable	XUB4BP A NL2	XUB4AP A NL2	1 (3.28)	AC/DC	Relay	cable	XUK5ARCNL2	2.1 (6.89)	AC/DC	Relay	terminals	XUX5ARCNT16
				connector 4P	XUB4BP A NM12	XUB4AP A NM12				connector 4P	XUK5ARCNT16					
DC3	NPN	cable	XUB4BN A NL2	XUB4AN A NL2	1 (3.28)	AC/DC	Relay	cable	XUK5ARCNT16	2.1 (6.89)	AC/DC	Relay	terminals	XUX5ARCNT16		
		connector 4P	XUB4BN A NM12	XUB4AN A NM12				connector 4P	XUK5ARCNT16							
Polarised Reflex (T/R)	DC3	PNP	cable	XUB9BP A NL2	XUB9AP A NL2	5 (16.40)	DC3	PNP	cable	XUK9AP A NL2	11 (36.09)	DC3	PNP	terminals	XUX9AP A NT16	
			connector 4P	XUB9BP A NM12	XUB9AP A NM12				connector 4P	XUK9AP A NM12				connector 4P	XUX9AP A NM12	
	DC3	NPN	cable	XUB9BN A NL2	XUB9AN A NL2	5 (16.40)	DC3	NPN	cable	XUK9AN A NL2	11 (36.09)	DC3	NPN	terminals	XUX9AN A NT16	
			connector 4P	XUB9BN A NM12	XUB9AN A NM12				connector 4P	XUK9AN A NM12				connector 4P	XUX9AN A NM12	
	Accessories: Reflector	DC3	Relay	cable	XUB9ARCNL2	XUB9ARCNT16	5 (16.40)	AC/DC	Relay	cable	XUK9ARCNT16	11 (36.09)	AC/DC	Relay	terminals	XUX9ARCNT16
				connector 4P	XUB9ARCNT16	connector 4P				XUK9ARCNT16						
Reflex (T/R)	DC3	PNP	cable	XUB1BP A NL2	XUB1AP A NL2	7 (22.97)	DC3	PNP	cable	XUK1AP A NL2	14 (45.93)	DC3	PNP	terminals	XUX1AP A NT16	
			connector 4P	XUB1BP A NM12	XUB1AP A NM12				connector 4P	XUK1AP A NM12				connector 4P	XUX1AP A NM12	
	DC3	NPN	cable	XUB1BN A NL2	XUB1AN A NL2	7 (22.97)	DC3	NPN	cable	XUK1AN A NL2	14 (45.93)	DC3	NPN	terminals	XUX1AN A NT16	
			connector 4P	XUB1BN A NM12	XUB1AN A NM12				connector 4P	XUK1AN A NM12				connector 4P	XUX1AN A NM12	
	Accessories: Reflector	DC3	Relay	cable	XUB1ARCNL2	XUB1ARCNT16	7 (22.97)	AC/DC	Relay	cable	XUK1ARCNT16	14 (45.93)	AC/DC	Relay	terminals	XUX1ARCNT16
				connector 4P	XUB1ARCNT16	connector 4P				XUK1ARCNT16						
Thru-beam (T) (R)	DC3	PNP	cable	XUB2BP A NL2R	XUB2AP A NL2R	15 (49.21)	DC3	PNP	cable	XUK2AP A NL2R	40 (131.23)	DC3	PNP	terminals	XUX2AP A NT16R	
			connector 4P	XUB2BP A NM12R	XUB2AP A NM12R				connector 4P	XUK2AP A NM12R				connector 4P	XUX2AP A NM12R	
	DC3	NPN	cable	XUB2BN A NL2R	XUB2AN A NL2R	15 (49.21)	DC3	NPN	cable	XUK2AN A NL2R	40 (131.23)	DC3	NPN	terminals	XUX2AN A NT16R	
			connector 4P	XUB2BN A NM12R	XUB2AN A NM12R				connector 4P	XUK2AN A NM12R				connector 4P	XUX2AN A NM12R	
	Accessories: Transmitter	DC3	Relay	cable	XUB2AKSNL2T	XUB2AKSNM12T	15 (49.21)	AC/DC	Relay	cable	XUK2AKSNL2T	40 (131.23)	AC/DC	Relay	terminals	XUX2AKSNL2T
				connector 4P	XUB2AKSNM12T	connector 4P				XUK2AKSNM12T						
Output function	DC3	Relay	NO	A	NO or NC	C	AC/DC	Relay	cable	XUK2ARCNT16R	40 (131.23)	AC/DC	Relay	terminals	XUX2ARCNT16R	
			NC	B	connector 4P	XUK2ARCNT16R			connector 4P	XUX2ARCNT16R						
Multimode	DC3	PNP	cable	XUB0BPSNL2	XUB0APSNL2	15 (49.21)	DC3	PNP/NPN	cable	XUK0AKSAL2	40 (131.23)	DC3	PNP/NPN	terminals	XUX0AKSAT16	
			connector 4P	XUB0BPSNM12	XUB0APSNM12				connector 4P	XUK0AKSAM12				connector 4P	XUX0AKSAM12	
	DC3	NPN	cable	XUB0BNSNL2	XUB0ANSNL2	15 (49.21)	DC3	NPN	cable	XUK0ARCTL2	40 (131.23)	DC3	NPN	terminals	XUX0ARCTT16	
			connector 4P	XUB0BNSNM12	XUB0ANSNM12				connector 4P	XUK0ARCTT16						
	Sensing distance, m (ft)	DC3	Relay	Background Supp: 0.12 (0.39)	Diffuse: 0.3 (0.98)	15 (49.21)	AC/DC	Relay	cable	XUK0AKSAL2T	40 (131.23)	AC/DC	Relay	terminals	XUX0AKSAT16T	
				Background Supp: 0.12 (0.39)	Diffuse: 0.3 (0.98)				connector 4P	XUK0AKSAM12T				connector 4P	XUX0AKSAM12T	
Accessories: Transmitter	DC3	Relay	cable	XUB0AKSNL2T	XUB0AKSNM12T	15 (49.21)	AC/DC	Relay	cable	XUK0AKSAL2T	40 (131.23)	AC/DC	Relay	terminals	XUX0AKSAT16T	
			connector 4P	XUB0AKSNM12T	connector 4P				XUK0AKSAM12T							

Reflectors

XUZC24 XUZC80 XUZC50 XUZC100

3D mountings

Bracket with ball joint for sensors and reflector XUZC50

XUB XUZB2003
XUM0 XUZM2003
XUK... XUZK2003
XUX... XUZX2003

Protective housing with ball joint

XUZK2004 XUZX2004

M12 rod for ball joint

XUZ2001

Mounting support for M12 rod

XUZ2003

Other mountings

Single bracket: standard, with ball joint

XUB XUZA118 (stainless steel) XUZA218 (plastic)
XUM XUZAM02
XUK XUZA51
XUX XUZX2000

DC3 24 V

AC/DC Relay 24...240 V

Cabling XU

M8

Pre-wired connectors (female)

straight elbowed

4-pin 2 m XZCP0941L2 XZCP1041L2
5 m XZCP0941L5 XZCP1041L5
10 m XZCP0941L10 XZCP1041L10

M12

Pre-wired connectors (female)

straight elbowed elbowed PNP LED

4-pin 2 m XZCP1141L2 XZCP1241L2 XZCP1340L2
5 m XZCP1141L5 XZCP1241L5 XZCP1340L5
10 m XZCP1141L10 XZCP1241L10 XZCP1340L10

M12

Connectors (female)

straight elbowed

4-pin (1) XZCC12FDM40B XZCC12FCM40B
4-pin (2) XZCC12FDP40B XZCC12FCP40B

(1) Steel ring (2) Plastic ring

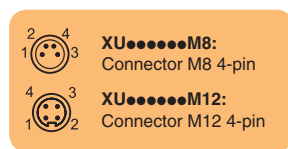

OsiSense® XC Limit Switches

Choose : **1** > **2** > **3** > **4** > Reference

	Body	Head	Contact	Connection						
XCKD Metal	NO+NC Snap	M16	XCKD2110P16	XCKD2102P16	XCKD2121P16	XCKD2106P16	XCKD2118P16	XCKD2145P16		
		Pg11	XCKD2110G11	XCKD2102G11	XCKD2121G11	XCKD2106G11	XCKD2118G11	XCKD2145G11		
		M12 5P	XCKD2110M12	XCKD2102M12	XCKD2121M12	XCKD2106M12	XCKD2118M12	XCKD2145M12		
		1/2 NPT	XCKD2110N12	XCKD2102N12	XCKD2121N12	XCKD2106N12	XCKD2118N12	XCKD2145N12		
XCKP Plastic	NO+NC Snap	M16	XCKP2110P16	XCKP2102P16	XCKP2121P16	XCKP2106P16	XCKP2118P16	XCKP2145P16		
		Pg11	XCKP2110G11	XCKP2102G11	XCKP2121G11	XCKP2106G11	XCKP2118G11	XCKP2145G11		
		M12 4P	XCKP2110M12	XCKP2102M12	XCKP2121M12	XCKP2106M12	XCKP2118M12	XCKP2145M12		
		1/2 NPT	XCKP2110N12	XCKP2102N12	XCKP2121N12	XCKP2106N12	XCKP2118N12	XCKP2145N12		
XCKT Plastic	NO+NC Snap	M16	XCKT2110P16	XCKT2102P16	XCKT2121P16	XCKT2106P16	XCKT2118P16	XCKT2145P16		
		Pg11	XCKT2110G11	XCKT2102G11	XCKT2121G11	XCKT2106G11	XCKT2118G11	XCKT2145G11		
		1/2 NPT	XCKT2110N12	XCKT2102N12	XCKT2121N12	XCKT2106N12	XCKT2118N12	XCKT2145N12		

	Body	Head	Contact	Connection							
XCMD Metal	NO+NC Snap	1m	XCMD2110L1	XCMD2102L1	XCMD2124L1	XCMD21F0L1	XCMD21F2L1	XCMD2115L1	XCMD2116L1		
		NO+NC Slow	1m	XCMD2510L1	XCMD2502L1	XCMD2524L1	XCMD25F0L1	XCMD25F2L1	XCMD2515L1	XCMD2516L1	
		NO+NC Snap	M12 5P	XCMD2110C12	XCMD2102C12	XCMD2124C12	XCMD21F0C12	XCMD21F2C12	XCMD2115C12	XCMD2116C12	
		NO+NC Snap	M12 4P	XCMD2110M12	XCMD2102M12	XCMD2124M12	XCMD21F0M12	XCMD21F2M12	XCMD2115M12	XCMD2116M12	

	Body	Head	Contact	Connection					
XCKM Metal	NO+NC Snap	M20	XCKM110H29	XCKM102H29	XCKM121H29	XCKM115H29	XCKM106H29		
		Pg11*	XCKM110	XCKM102	XCKM121	XCKM115	XCKM106		
XCKL Metal	NO+NC Snap	1/2 NPT	XCKL110H7	XCKL102H7	XCKL121H7	XCKL115H7	XCKL106H7		

*1/2 NPT w/included adapter

	Body	Head	Contact	Connection					
XCKJ Metal	NO+NC Snap	M20	XCKJ161H29	XCKJ167H29	XCKJ10511H29	XCKJ10513H29	XCKJ10541H29	XCKJ10559H29	
		Pg13	XCKJ161	XCKJ167	XCKJ10511	XCKJ10513	XCKJ10541	XCKJ10559	
		1/2NPT	XCKJ161H7	XCKJ167H7	XCKJ10511H7	XCKJ10513H7	XCKJ10541H7	XCKJ10559H7	
		M12 5P	XCKJ161D	XCKJ167D	XCKJ10511D	XCKJ10513D	XCKJ10541D	XCKJ10559D	

	Body	Head	Contact	Connection					
XCSA Metal	NC+2NO Slow	M20	XCSA502	XCSA702	XCSA802	XCSZ01	XCSZ03		
		Pg13	XCSA501	XCSA701	XCSA801				
		1/2NPT	XCSA503	XCSA703	XCSA803				

	Body	Head	Contact	Connection					
XCSPA Plastic	NC+NO Slow	M16	XCSPA592	XCSPA792	XCSPA892	XCSPA992	XCSPA492	XCSZ11	XCSZ13
		Pg11	XCSPA591	XCSPA791	XCSPA891	XCSPA991	XCSPA491		
		1/2NPT	XCSPA593	XCSPA793	XCSPA893	XCSPA993	XCSPA493		

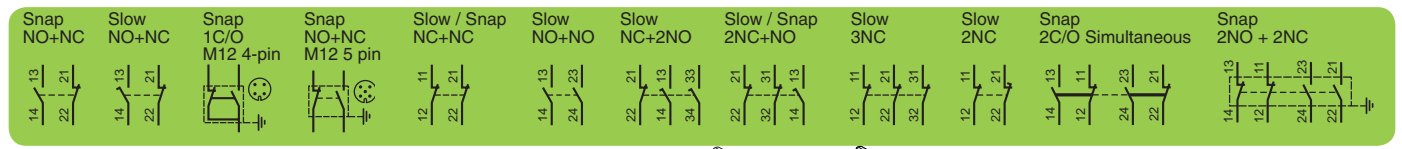

- M16 Tapped M16x1.5 for ISO cable gland
- M20 Tapped M20x1.5 for ISO cable gland
- Pg11 Tapped for a N°11 cable gland
- Pg13 Tapped for a N°13 cable gland
- 1/2NPT Tapped for a 1/2" NPT
- PF1/2 Tapped for a PF1/2"
- M12 5P Connector M12, 5 pin
- M12 4P Connector M12, 4-pin
- CG Tapped with cable gland include

		Pre-wired connectors (female)			Connectors (female)		
M12		straight	elbowed	elbowed PNP LED	M12	straight	elbowed
4-pin	2 m	XZCP1141L2	XZCP1241L2	XZCP1340L2	(1) 4-pin	XZCC12FDM40B	XZCC12FCM40B
	5 m	XZCP1141L5	XZCP1241L5	XZCP1340L5	(2) 4-pin	XZCC12FDP40B	XZCC12FCP40B
	10 m	XZCP1141L10	XZCP1241L10	XZCP1340L10	(1) 5 pin	XZCC12FDM50B	XZCC12FCM50B
5 pin	5 m	XZCP1164L5	XZCP1264L5				

(1) Steel ring (2) Plastic ring

XCKP / XCKD / XCKT

Plastic / Metal / Plastic

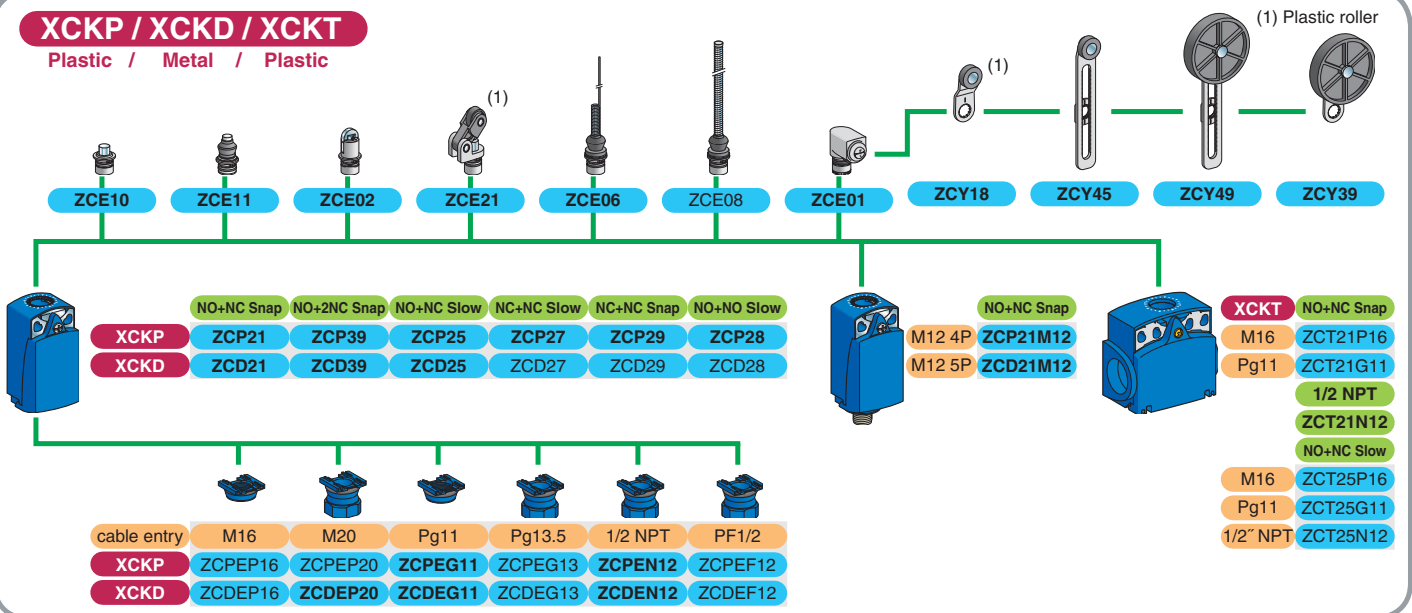

XCMD

Metal

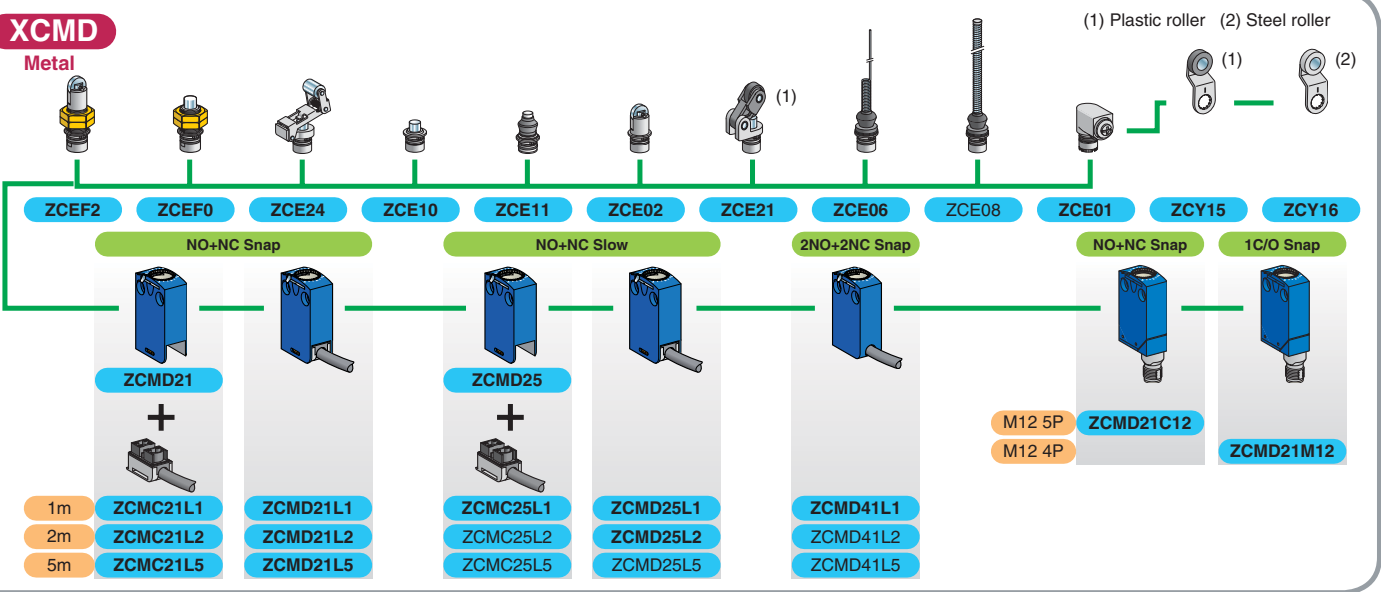

XCKM / XCKL

Metal / Metal

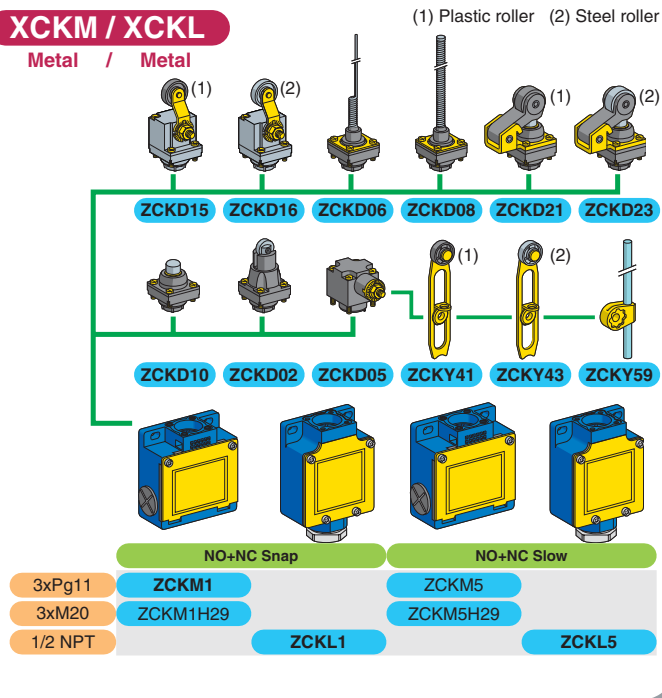

XCKJ

Metal

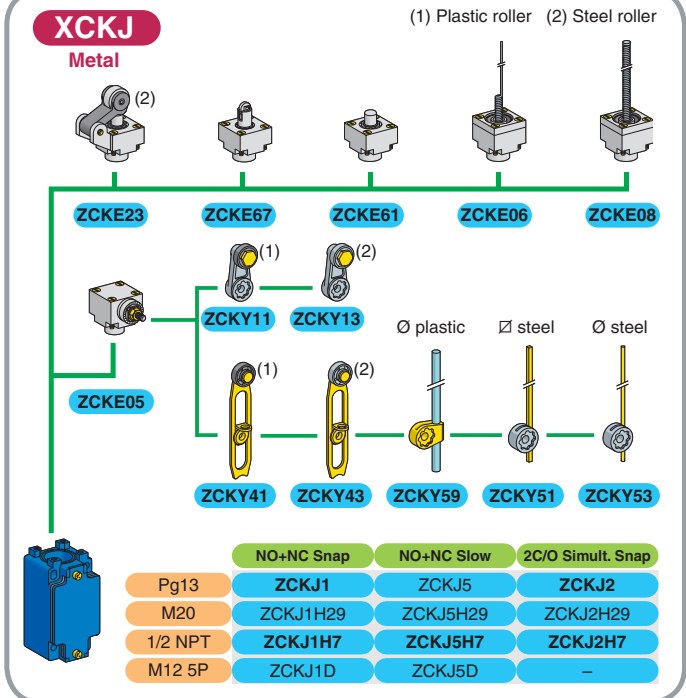

OsiSense® XM Pressure Switches

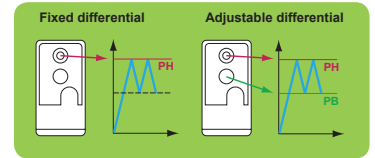
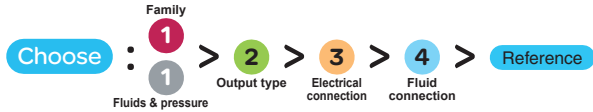

XMLA / XMLB Electromechanical

Hydraulic oils, air, fresh water, sea water / Temp : up to 70°C (158 °F)

		1 C/O single pole contact fixed differential			1 C/O single pole contact adjustable differential		
Screw terminal		1/2" NPT	Pg13	DIN connector	1/2" NPT	Pg13	DIN connector
Bars	psi						
-1	-14.5	XMLAM01V2S13	XMLAM01V2S11	XMLAM01V2C11	XMLBM02V2S13	XMLBM02V2S11	XMLBM02V2C11
2.5	36.3	XMLA002A2S13	XMLA002A2S11	XMLA002A2C11	XMLB002A2S13	XMLB002A2S11	XMLB002A2C11
4	58	XMLA004A2S13	XMLA004A2S11	XMLA004A2C11	XMLB004A2S13	XMLB004A2S11	XMLB004A2C11
10	145	XMLA010A2S13	XMLA010A2S11	XMLA010A2C11	XMLB010A2S13	XMLB010A2S11	XMLB010A2C11
20	290	XMLA020A2S13	XMLA020A2S11	XMLA020A2C11	XMLB020A2S13	XMLB020A2S11	XMLB020A2C11
35	508	XMLA035A2S13	XMLA035A2S11	XMLA035A2C11	XMLB035A2S13	XMLB035A2S11	XMLB035A2C11

Hydraulic oils / Temp: up to 160°C (320 °F)

1	14.5	XMLA001R2S13	XMLA001R2S11	XMLA001R2C11	XMLB001R2S13	XMLB001R2S11	XMLB001R2C11
70	1,015	XMLA070D2S13	XMLA070D2S11	XMLA070D2C11	XMLB070D2S13	XMLB070D2S11	XMLB070D2C11
160	2,320	XMLA160D2S13	XMLA160D2S11	XMLA160D2C11	XMLB160D2S13	XMLB160D2S11	XMLB160D2C11
300	4,350	XMLA300D2S13	XMLA300D2S11	XMLA300D2C11	XMLB300D2S13	XMLB300D2S11	XMLB300D2C11
500	7,250	XMLA500D2S13	XMLA500D2S11	XMLA500D2C11	XMLB500D2S13	XMLB500D2S11	XMLB500D2C11

1/4" NPTF (female)

XMLF Electronic + Display

Hydraulic oils, air, fresh water, sea water, corrosive fluids

		Discrete Outputs		Analog		Analog + Discrete Output	
		NO or NC	2 x (PNP or NPN)			PNP or NPN - NO or NC	
M12 4-pin		120 VAC Relay	NO or NC	4...20 mA	0...10 V	4...20 mA	0...10 V
Bars	psi						
-1	-14.5	XMLFM01E2046	XMLFM01D2036	XMLFM01D2016	XMLFM01D2116	XMLFM01D2026	XMLFM01D2126
1	14.5	XMLF001E2046	XMLF001D2036	XMLF001D2016	XMLF001D2116	XMLF001D2026	XMLF001D2126
2.5	36.25	XMLF002E2046	XMLF002D2036	XMLF002D2016	XMLF002D2116	XMLF002D2026	XMLF002D2126
10	145	XMLF010E2046	XMLF010D2036	XMLF010D2016	XMLF010D2116	XMLF010D2026	XMLF010D2126
016	232	XMLF016E2046	XMLF016D2036	XMLF016D2016	XMLF016D2116	XMLF016D2026	XMLF016D2126
025	362.5	XMLF025E2046	XMLF025D2036	XMLF025D2016	XMLF025D2116	XMLF025D2026	XMLF025D2126
040	580	XMLF040E2046	XMLF040D2036	XMLF040D2016	XMLF040D2116	XMLF040D2026	XMLF040D2126
070	1,015	XMLF070E2046	XMLF070D2036	XMLF070D2016	XMLF070D2116	XMLF070D2026	XMLF070D2126
100	1,450	XMLF100E2046	XMLF100D2036	XMLF100D2016	XMLF100D2116	XMLF100D2026	XMLF100D2126
160	2,320	XMLF160E2046	XMLF160D2036	XMLF160D2016	XMLF160D2116	XMLF160D2026	XMLF160D2126
250	3,625	XMLF250E2046	XMLF250D2036	XMLF250D2016	XMLF250D2116	XMLF250D2026	XMLF250D2126
400	5,800	XMLF400E2046	XMLF400D2036	XMLF400D2016	XMLF400D2116	XMLF400D2026	XMLF400D2126
600	8,700	XMLF600E2046	XMLF600D2036	XMLF600D2016	XMLF600D2116	XMLF600D2026	XMLF600D2126

1/4" NPTF (female)

XMLG Electronic

Hydraulic oils, air, fresh water, sea water, corrosive fluids

		Analog	
M12 4-pin		4...20 mA	0...10 V
Bars	psi		
-1	-14.5	XMLGM01D23	XMLGM01D73
1	14.5	XMLG001D23	XMLG001D73
6	87	XMLG006D23	XMLG006D73
10	145	XMLG010D23	XMLG010D73
16	232	XMLG016D23	XMLG016D73
025	362.5	XMLG025D23	XMLG025D73
100	1,450	XMLG100D23	XMLG100D73
250	3,625	XMLG250D23	XMLG250D73
400	5,800	XMLG400D23	XMLG400D73

1/4" NPTF (male)

Cabling XM

Pre-wired connectors (female)				Connectors (female)			Connectors (female)	
M12	straight	elbowed	elbowed PNP LED	M12	straight	elbowed	DIN connector	elbowed
4-pin	2 m XZCP1141L2	XZCP1241L2	XZCP1340L2	(1) 4-pin XZCC12FDM40B	XZCC12FCM40B		4-pin	XZCC43FCP40B
5 m	XZCP1141L5	XZCP1241L5	XZCP1340L5	(2) 4-pin XZCC12FDP40B	XZCC12FCP40B			
10 m	XZCP1141L10	XZCP1241L10	XZCP1340L10					

(1) Steel ring (2) Plastic ring

OsiSense® Ultrasonic: SM, XX, XUV

Body size

Choose: 1 > 2 > 3 > 4 > Reference

1 Sensing distance, 2 Output function, 3 Output type, 4 Connection

	M12		M18		M30		M30 stainless
Sensing distance, m	0.05 (1.97)	0.1 (3.94)	0.15 (5.91)	0.5 (19.68)	1 (39.37)	8 (26.25 ft)	1 (39.37)
Connectors	M8 4-pin	M8 3-pin	M12 4-pin	M12 4-pin	M12 4-pin	M12 4-pin	M12 4-pin
NO	DC4 PNP/NPN SM350A22800		SM650A68000		SM950A100000		
	DC3 PNP SM330A46000			VM18PNOQ (1)	XX6V3A1PAM12 (1)		
	NPN SM340A46000			VM18NNOQ (1)	XX6V3A1NAM12 (1)		
NO+NC	DC4 PNP SM950A130000				SM950A830000	SM950A130000S	
	NPN SM950A120000				SM950A820000	SM950A120000S	
Analog	4...20 mA			VM18CAQ (1)	XX9V3A1C2M12 (1)	SM956A820000	SM956A120000S

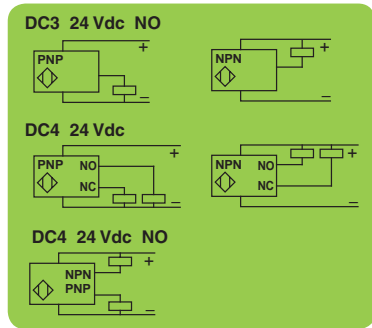

(1) Adjustable with XXZPB100

	Flat 7.6x19x33	Flat 16x30x74	Flat 60x30x18 + M18	M18
Connectors	M8 3-pin	M12 4-pin	M12 4-pin	M12 4-pin
Sensing distance, m	0.1 (3.94)	0.15 (9.84)	0.5 (19.68)	50 mm (1.97 in.)
NO	DC4 PNP/NPN SM650A68000FP			
	DC3 PNP SM330A46000FP			VM1PNOQ (1)
	NPN SM340A46000FP			VM1NNOQ (1)
Analog	4...20 mA			VM1CAQ (1)
	0...10 V			VM1VAQ (1)
		SM656A-674-00FP		
				(1) Adjustable with XXZPB100
M12	XXZ12			
M18	XUZA118			
M30	XXZ30			
SM3●FP	XXZ1933			
Adjustable	XXPB100			
NO, PNP				XXV18B1PAM12
NO, NPN				XXV18B1NAM12
NC, PNP				XXV18B1PBM12
NC, NPN				XXV18B1NBM12

New short-range ultrasonic sensor for inductive applications

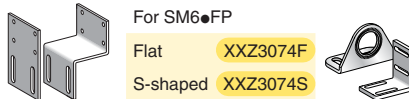
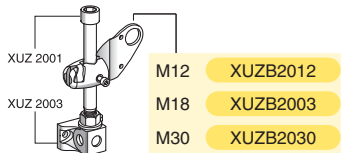

OsiSense® XUV Forks

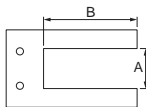

	Sensing distance, mm		A: 50 / B: 60 (1.97 / 2.36)	A: 80 / B: 60 (3.15 / 2.36)	A: 120 / B: 120 (4.72 / 4.72)	A: 180 / B: 120 (7.09 / 4.72)
DC3 PNP	M8 3-pin	XUVR0605P A NM8	XUVR0608P A NM8	XUVR1212P A NM8	XUVR1218P A NM8	
NPN	M8 3-pin	XUVR0605N A NM8	XUVR0608N A NM8	XUVR1212N A NM8	XUVR1218N A NM8	
Output function	NO	A	A	A	A	
	NC	B	B	B	B	

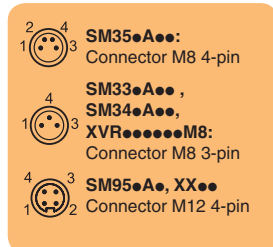
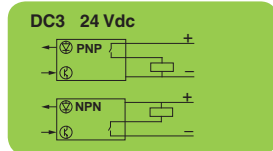

Cabling SM/XUV

	Pre-wired connectors (female)			Connectors (female)	
M8	straight	elbowed	elbowed PNP LED	straight	elbowed
3-pin	2 m XZCP0566L2	XZCP0666L2		(1) 4-pin XZCC12FDM40B	XZCC12FCM40B
	5 m XZCP0566L5	XZCP0666L5		(2) 4-pin XZCC12FDP40B	XZCC12FCP40B
	10 m XZCP0566L10	XZCP0666L10			(1) Steel ring (2) Plastic ring
4-pin	2 m XZCP0941L2	XZCP1041L2			
	5 m XZCP0941L5	XZCP1041L5			
	10 m XZCP0941L10	XZCP1041L10			
M12	straight	elbowed		straight	elbowed
4-pin	2 m XZCP1141L2	XZCP1241L2	XZCP1340L2	M12 4-pin XZCC12MDM40B	XZCC12MCM40B
	5 m XZCP1141L5	XZCP1241L5	XZCP1340L5		
	10 m XZCP1141L10	XZCP1241L10	XZCP1340L10	5 pin XZCC12MDM50B	XZCC12MCM50B

Schneider Electric USA, Inc.

www.SeSensors.com

Schneider Electric Sensor Competency Center
1875 Founders Drive
Dayton, Ohio 45420
(800) 435-2121

NOTE: Sensors described in this catalog with the exception of the safety detections products are designed to be used for standard industrial presence sensing applications. These sensors do not include the self-checking redundant circuitry necessary to allow for their use in safety applications.

Design: IGS-CP
Photos: Schneider Electric

© 2010 Schneider Electric. All rights Reserved.

April 2010

9006BR0902