

Panel Thickness E dim. inches (mm)	Number of Gasket
1/16 (1.6)	4
1/8 (3.2)	3
3/16 (4.8)	2
1/4 (6.4)	1

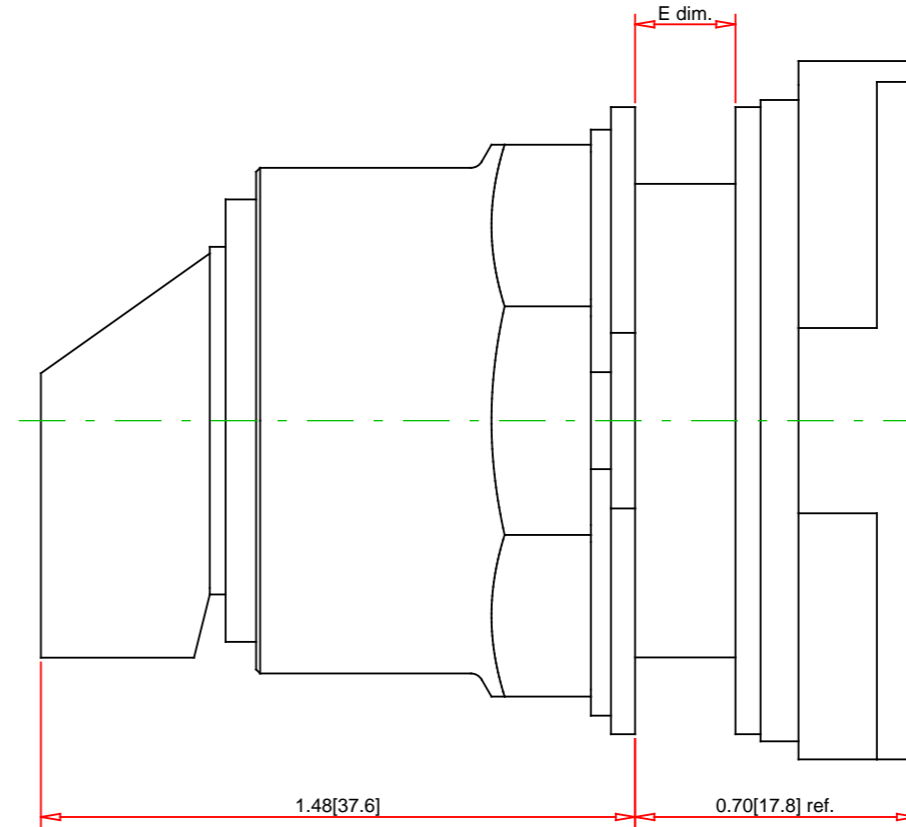
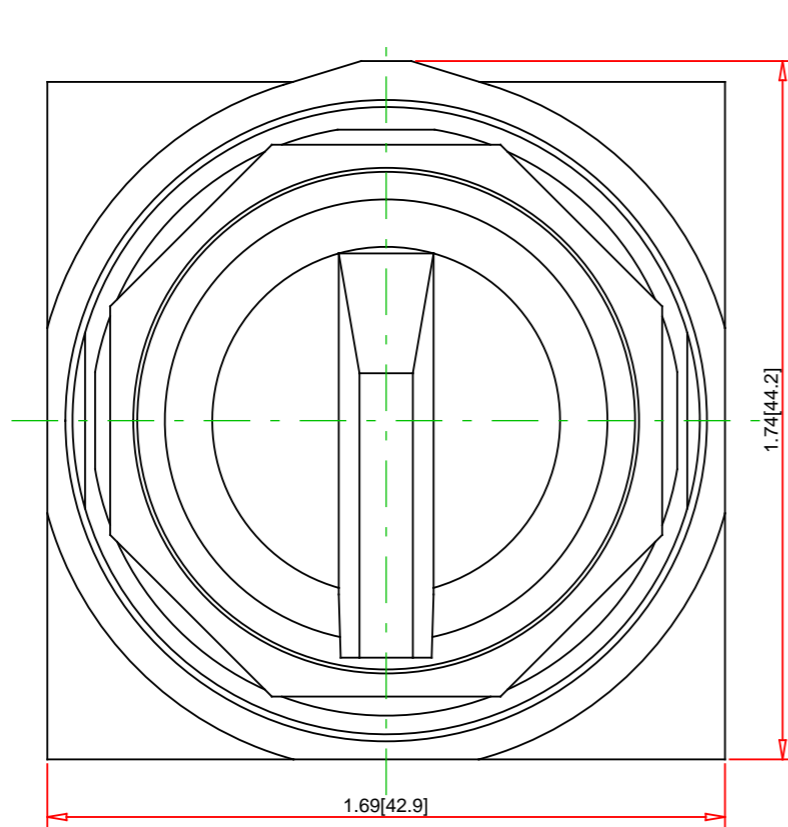

Note:  
 - Drawings Not To Scale  
 - Drawings Subject to Change Without Notice  
 - Dimensions are inches next to [Millimeters]

Part No.:

**9001KS73B**

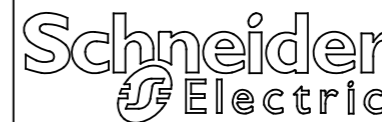

Schneider Electric United States  
 North American Division  
 Boston One Campus  
 800 Federal Street  
 Andover, MA 01810, USA  
 Phone: +1 8773425173  
 Email: CCC@us.schneider-electric.com

Technical Information:

UL File: E78403 CCN NKCR  
 CSA File: LR24590 Class 3211-03  
 CE Marked: Yes  
 RoHS: Yes  
 NEMA / IP Rating: NEMA 1/2/3/3R/4/6/12/13 Water tight, Dust tight and Oil tight (Indoor/Outdoor), IP66  
 Key Number: n/a  
 Key Removal: n/a  
 Light Module Supply Voltage: not applicable  
 Light Module Type: not applicable  
 Number of Operators: 1

Specification:

Description: 30mm Selector Switch  
 Ring Nut Material: Chromium Plated Zinc  
 Operator Type: Non-Illuminated  
 Operator Action: Spring Return (From Right to Center)  
 Button Type: n/a  
 Guard Type: n/a  
 Button/Cap Color: n/a  
 Lens Type: not applicable  
 Lens Color: not applicable  
 Knob Type: Standard Knob  
 Knob Color: Black  
 Number of Positions: 3