

# Wiser

## System User Guide (Spain and Portugal)

04/2024



Life Is On | Schneider Electric

**Schneider**  
Electric

# Legal Information

The information provided in this document contains general descriptions, technical characteristics and/or recommendations related to products/solutions.

This document is not intended as a substitute for a detailed study or operational and site-specific development or schematic plan. It is not to be used for determining suitability or reliability of the products/solutions for specific user applications. It is the duty of any such user to perform or have any professional expert of its choice (integrator, specifier or the like) perform the appropriate and comprehensive risk analysis, evaluation and testing of the products/solutions with respect to the relevant specific application or use thereof.

The Schneider Electric brand and any trademarks of Schneider Electric SE and its subsidiaries referred to in this document are the property of Schneider Electric SE or its subsidiaries. All other brands may be trademarks of their respective owner.

This document and its content are protected under applicable copyright laws and provided for informative use only. No part of this document may be reproduced or transmitted in any form or by any means (electronic, mechanical, photocopying, recording, or otherwise), for any purpose, without the prior written permission of Schneider Electric.

Schneider Electric does not grant any right or license for commercial use of the document or its content, except for a non-exclusive and personal license to consult it on an "as is" basis.

Schneider Electric reserves the right to make changes or updates with respect to or in the content of this document or the format thereof, at any time without notice.

**To the extent permitted by applicable law, no responsibility or liability is assumed by Schneider Electric and its subsidiaries for any errors or omissions in the informational content of this document, as well as any non-intended use or misuse of the content thereof.**

---

# Table of Contents

Safety Information.....	7
Reading the System User Guide Online .....	8
Getting to Know the Wiser System.....	9
List of Wiser Devices .....	10
Hubs .....	10
Climate .....	11
Lights .....	12
Shutters.....	13
Appliances .....	13
Sensors .....	15
Safety and Security.....	15
Energy.....	16
Setting-up the Wiser System.....	17
System Requirements.....	17
Support for battery-powered devices.....	18
Limitations of the Wiser System .....	18
Third party devices.....	19
Selecting the mounting location .....	20
Wiser Home App .....	20
Downloading the Wiser Home App .....	20
Roles in the Wiser App .....	22
Cybersecurity Principles.....	26
Setting up the Hub .....	27
Setting up as a Professional Installer .....	27
Downloading hub firmware into the app .....	30
Connecting to the Hub's Temporary Wi-Fi® Network .....	31
Updating the firmware .....	36
Entering Wi-Fi® login information.....	39
Setting an Account .....	41
Connecting Devices to the Hub.....	45
Getting to know the Hub.....	46
Wiser Hub 2 <sup>nd</sup> Generation .....	46
Operating Elements .....	46
LED behaviour.....	46
Updating .....	47
Resetting to factory defaults.....	47
Wiser Hub <sup>R</sup> 2 <sup>nd</sup> Generation.....	47
Operating Elements .....	48
LED Behavior .....	48
Updating .....	49
Resetting to factory defaults.....	49
Configuring the Wiser System .....	51
Devices .....	51
List of Devices .....	51
Adding a Device.....	53
Device Details .....	57
Rooms.....	58

List of Rooms .....	58
Adding a Room.....	59
Room Details.....	60
Moments.....	62
Creating a Moment .....	63
Editing a Moment.....	66
Deleting a Moment.....	67
Automations.....	68
Creating an Automation.....	69
Editing an Automation .....	77
Deleting an Automation .....	79
Schedules.....	80
Adding a Schedule.....	82
Editing a Schedule .....	84
Deleting a Schedule .....	86
Modes .....	86
Away Mode .....	86
Boost Mode.....	87
Smart Modes.....	88
App Settings .....	91
Support.....	93
App Theme .....	94
Account settings.....	94
Notifications and Alarms.....	96
Setting-up Overconsumption Alarm.....	98
Setting-up No Consumption Alarm .....	100
App Language.....	103
<b>Controlling the Wiser System.....</b>	<b>104</b>
Home Screen .....	104
Rearranging Rooms.....	105
Home Screen Settings .....	106
Device control .....	107
Climate control .....	109
Compatible third party devices .....	112
Voice Control.....	113
Amazon Alexa .....	113
Google Home .....	114
Insights.....	115
Energy overview .....	115
Activity and environment .....	116
Weather and Heating .....	117
Heat report.....	117
Energy.....	119
Live .....	120
History .....	122
Insights .....	124
<b>Additional Information .....</b>	<b>125</b>
About Signal Strength .....	125
Changing home Wi-Fi login information .....	126
<b>Troubleshooting .....</b>	<b>127</b>

---

Decommissioning a Wiser System.....	128
eSetup App .....	129



# Safety Information

## Important Information

Read these instructions carefully and look at the equipment to become familiar with the device before trying to install, operate, service, or maintain it. The following special messages may appear throughout this manual or on the equipment to warn of potential hazards or to call attention to information that clarifies or simplifies a procedure.



The addition of either symbol to a “Danger” or “Warning” safety label indicates that an electrical hazard exists which will result in personal injury if the instructions are not followed.



This is the safety alert symbol. It is used to alert you to potential personal injury hazards. Obey all safety messages that accompany this symbol to avoid possible injury or death.

<b>⚡ ⚠ DANGER</b>
<b>DANGER</b> indicates a hazardous situation which, if not avoided, <b>will result in death or serious injury.</b> <b>Failure to follow these instructions will result in death or serious injury.</b>
<b>⚠ WARNING</b>
<b>WARNING</b> indicates a hazardous situation which, if not avoided, <b>could result in death or serious injury.</b>
<b>⚠ CAUTION</b>
<b>CAUTION</b> indicates a hazardous situation which, if not avoided, <b>could result in minor or moderate injury.</b>
<b>NOTICE</b>
NOTICE is used to address practices not related to physical injury.

# Reading the System User Guide Online

Navigating through the system user guide and getting to know the functions.

The System User Guide is optimized for online presentation. Several functions are available to help you navigate.

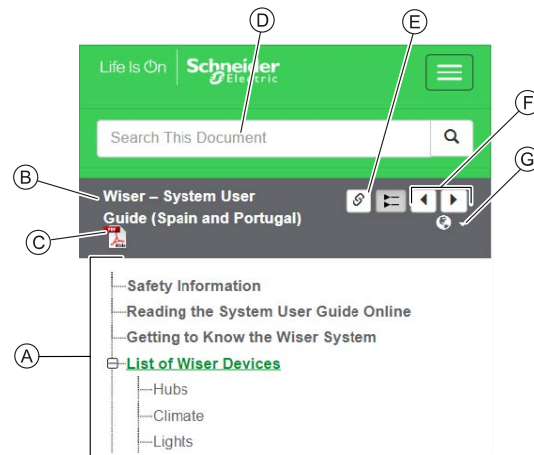

<b>A</b>	<b>Table of Contents</b>	Tap/Click to navigate through the topics. Tap/Click the + and - icons to expand/collapse a chapter.
<b>B</b>	<b>Document name</b>	Tap/Click to navigate to the first page of the document.
<b>C</b>	<b>PDF Icon</b>	Tap/Click to open the document as a PDF file.
<b>D</b>	<b>Search field</b>	Enter a search term and tap/click the magnifying icon.
<b>E</b>	<b>Copy Link</b>	Tap/Click to generate a link for the current chapter displayed on the screen.
<b>F</b>	<b>Previous / Next</b>	Tap/Click to navigate through the previous and next topics.
<b>G</b>	<b>Language selection</b>	Tap/Click to select your country.



# Getting to Know the Wiser System

The Wiser system provides an easy, convenient and flexible solution for controlling home devices using the Wiser Home App.

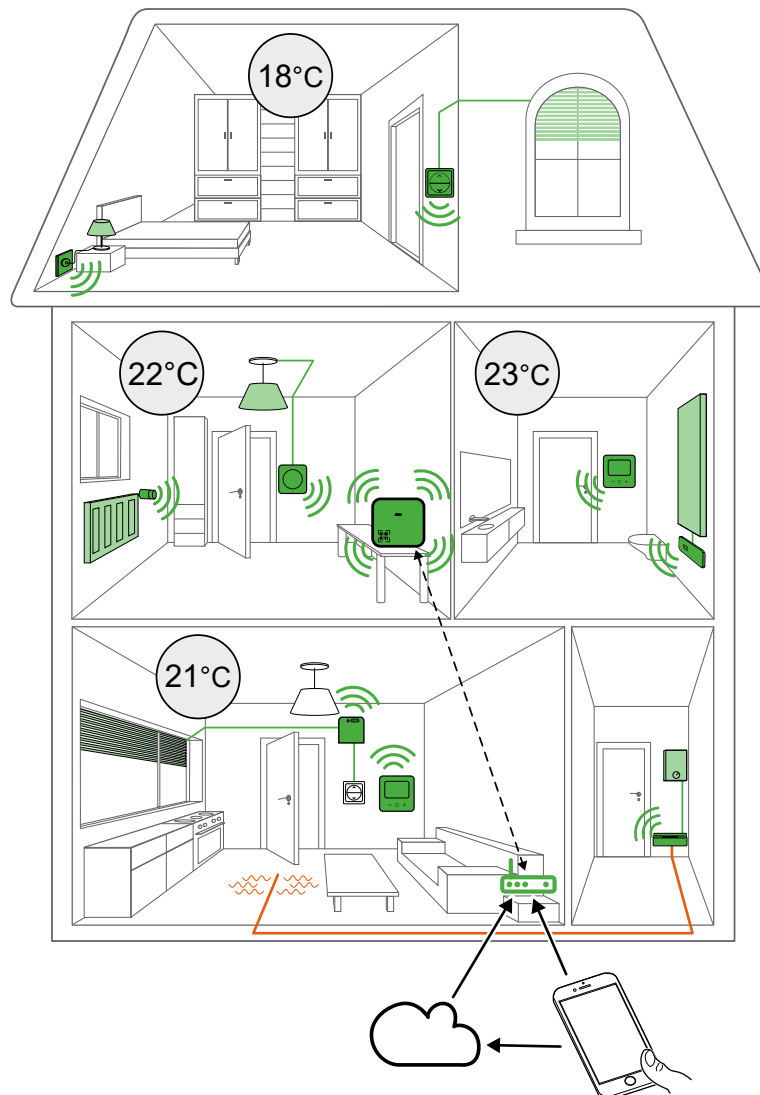

The Hub is the center of the system, processing control requests and status reports for connected Wiser devices, page 10.

With a personal account and the Wiser Home App on a smartphone you can control and monitor connected Wiser devices from anywhere where the internet is available for both mobile phone and the Hub.



## List of Wiser Devices

The devices listed in the following table are compatible Wiser devices.

Follow the device Instruction sheet links for installation instructions and device user guide links for more details on the device configuration.

### Hubs

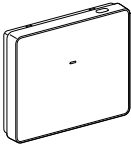
The Hub monitors and controls the Devices of your Home via the Wiser Home app, using Wi-Fi®.

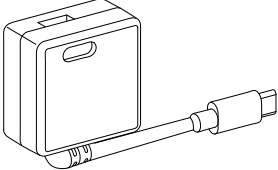
<p>Wiser Hub 2<sup>nd</sup> Generation</p>  <p>CCT501801</p>	<p>The Wiser Hub 2<sup>nd</sup> Generation monitors and controls the Devices of your Home via the Wiser Home App. It is connected to the Wiser Cloud for remote control via Wi-Fi®.</p>	<p><a href="#">Instruction Sheet (PDF)</a></p>
<p>Wiser HubR 2<sup>nd</sup> Generation</p>  <p>CCTFR6311G2</p>	<p>The Wiser HubR is used to connect all the Wiser devices. This version is used where central heating (e.g. boiler or heat pump) is used.</p>	<p><a href="#">Instruction Sheet (PDF)</a></p>
<p>Wiser Wall Box Power Supply</p>  <p>CCT501800-0001</p>	<p>Alternative power supply for the Wiser Hub 2<sup>nd</sup> Generation, placed in a wall box.</p>	<p><a href="#">Instruction Sheet (PDF)</a></p>

## Climate

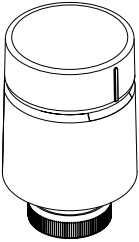
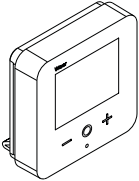
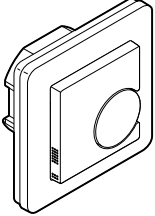
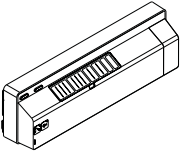
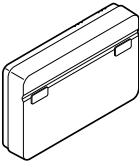
<p>Wiser Radiator Thermostat</p>  <p>CCTFR6100</p>	<p>Provides individual temperature control for radiators.</p>	<p>Instruction Sheet (PDF) Device User Guide</p>
<p>Wiser Room Thermostat with display</p>  <p>CCTFR6400</p>	<p>Wireless, battery-powered, colored touch-button display to set the room temperature.</p>	<p>Instruction Sheet (PDF) Device User Guide</p>
<p>Wiser Flush-mounted Thermostat 2 A</p>  <p>CFMT02ZB</p>	<p>The Wiser Flush-mounted Thermostat 2 A is mainly used for water-based heating and cooling applications, such as water-based underfloor heating and radiator heating.</p> <p><b>NOTE:</b> The thermostat is not suitable for directly connecting an electrical heating.</p>	<p>Instruction Sheet (PDF) Device User Guide</p>
<p>Wiser Underfloor Heating Connection Strip</p>  <p>CCTFR6600</p>	<p>Control thermal actuator valve heads to regulate the flow of hot water in the underfloor pipes.</p>	<p>Instruction Sheet (PDF) Device User Guide</p>
<p>Wiser Boiler Relay</p>  <p>CCTFR6001</p>	<p>Allows control of a domestic boiler in water based central heating applications.</p> <p><b>IMPORTANT:</b> The Wiser Boiler Relay is not compatible with the Wiser HubR 2nd Generation.</p>	<p>Instruction Sheet (PDF) Device User Guide</p>

## Third party devices

Devices that are compatible with a Wiser System, but are not provided by Schneider Electric.

<p>Airzone</p>	<p>Zoning system for HVAC (heating, ventilation, and air conditioning) used in buildings that regulates the indoor temperature.</p>	<p>Device User Guide</p>
----------------	---	--------------------------

## Lights

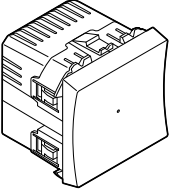
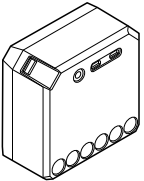
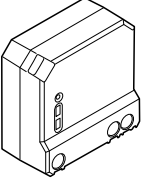
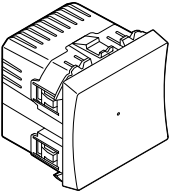
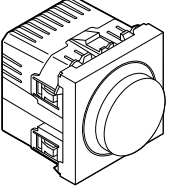
<p>Connected Relay Switch 10 A</p>  <p>NU3537xxW</p>	<p>Controls the lights in a room, or automatically switch lights On or Off in response to a specified condition or event.</p>	<p>Instruction Sheet (PDF) Device User Guide</p>
<p>Wiser Micro Module Light Switch</p>  <p>CCT5011-0002W</p>	<p>Converts compatible mechanical push-button switches into smart switches. Connect up to 10 compatible mechanical push buttons.</p> <p><b>NOTE:</b>Mechanical push buttons applications.</p>	<p>Instruction Sheet (PDF) Device User Guide</p>
<p>Wiser Micro Module Dimmer</p>  <p>CCT5010-0002W</p>	<p>Transforms a conventional switch into a connected device to dim lights.</p>	<p>Instruction Sheet (PDF) Device User Guide</p>
<p>Connected Universal Push-Button Dimmer LED</p>  <p>NU3515xxW</p>	<p>Controls the lighting level in a room, or automatically set lighting to a desired level in response to a specified condition or event.</p>	<p>Instruction Sheet (PDF) Device User Guide</p>
<p>Connected Universal Rotary Dimmer LED</p>  <p>NU3516xxW</p>	<p>Controls the lighting level in a room, or automatically set lighting to a desired level in response to a specified condition or event.</p>	<p>Instruction Sheet (PDF) Device User Guide</p>

## Shutters

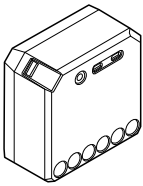
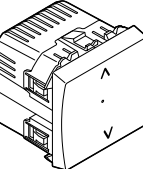
<p>Wiser Micro Module Shades Control</p>  <p>CCT5015-0002W</p>	<p>Controls blinds thru connected push-buttons or the Wiser Home app.</p>	<p>Instrucion Sheet (PDF) Device User Guide</p>
<p>Connected Blind Control Switch</p>  <p>NU3508xxW</p>	<p>Remotely open/close blinds or automatically set blind position in response to a specified condition or event.</p>	<p>Instruction Sheet (PDF) Device User Guide</p>

## Appliances

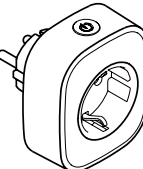
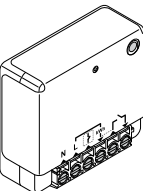
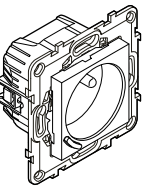
<p>Wiser Smart Plug</p>  <p>CCTFR6501</p>	<p>Remotely control and monitor the power consumption of the plugged-in load.</p>	<p>Instruction Sheet (PDF) Device User Guide</p>
<p>Wiser Power Micromodule</p>  <p>CCTFR6730</p>	<p>The Wiser Power Micromodule hereinafter referred as module is for switching loads (up to 3000 W resistive) such as a hot water tank or a socket outlet.</p> <p>In combination with the Wiser app, the energy consumption can be measured and the module can be used for load shedding or demand response.</p>	<p>Instruction Sheet (PDF) Device User Guide</p>
<p>Connected Single Socket Outlet 16 A</p>  <p>NU5557xxW</p>	<p>Control and monitor the power consumption of the plugged-in load.</p>	<p>Instruction Sheet (PDF) Device User Guide)</p>

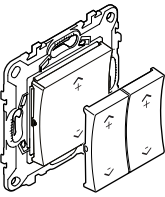
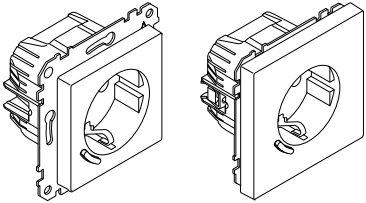
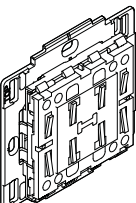
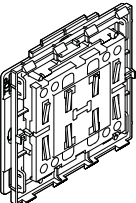
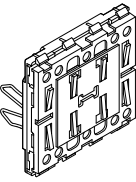
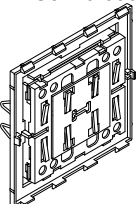
<p>Connected Wireless Switch 1-gang/2-gang</p>  <p>NU5571xxW</p>	<p>Battery powered push-button switch.</p> <p>Buttons can be freely assigned with functions with the Wiser Home App.</p>	<p>Instruction Sheet (PDF)</p> <p>Device User Guide</p>
<p>Connected single socket outlet 16A</p>  <p>MEG2380-0xxx MEG2380-60xx</p>	<p>Remotely control and monitor the power consumption of the plugged-in load.</p>	<p>Instruction Sheet (PDF)</p> <p>Device User Guide</p>
<p>Connected Wireless Switch 1-gang/2-gang</p>  <p>MEG5001-0300</p>  <p>MEG5001-6000</p>	<p>Battery powered push-button switch.</p> <p>Buttons can be freely assigned with functions with the Wiser Home App.</p>	<p>Instruction Sheet (PDF)</p> <p>Device User Guide</p>
<p>Connected Push-Button module, 1-gang/2-gang</p>  <p>MEG5116-0300 MEG5126-0300</p>  <p>MEG5116-6000 MEG5126-6000</p>	<p>Control different inserts thru the push-buttons or the Wiser Home app.</p> <p>To be combined with a blind control insert.</p>	<p>Instruction Sheet (PDF)</p> <p>Device User Guide</p>

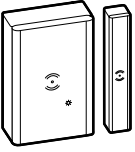
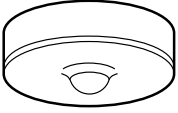
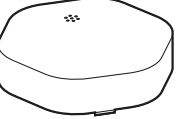
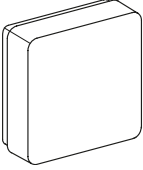

## Sensors

<p>Wiser Window/Door Sensor</p>  <p>CCT591012</p>	<p>Can be used to detect if a door or window is opened or closed.</p>	<p>Instruction Sheet (PDF) Device User Guide</p>
<p>Wiser Motion Sensor</p>  <p>CCT595012</p>	<p>Reports the detection of movement and measures the luminance of the environment.</p>	<p>Instruction Sheet (PDF) Device User Guide</p>
<p>Wiser Water Leakage Sensor</p>  <p>CCT592012</p>	<p>Detects water on a surface.</p>	<p>Instruction Sheet (PDF) Device User Guide</p>
<p>Wiser Temperature/Humidity Sensor</p>  <p>CCT593012</p>	<p>Measures temperature and humidity</p>	<p>Instruction Sheet (PDF) Device User Guide</p>

## Safety and Security

<p>Wiser Smoke Alarm - Battery</p>  <p>CCT599002</p>	<p>The Wiser Smoke Alarm - Battery uses a photoelectric sensor to detect smoke generated by fire. It also includes a temperature sensor that detects heat caused by rapid increase in temperature. When connected to the Wiser system, the device sends notifications to the user via the Wiser app.</p>	<p>Instruction Sheet (PDF) Device User Guide</p>
---	--	--

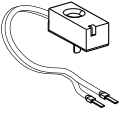
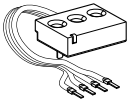
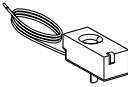
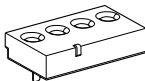
## Energy

<p>PowerLogic™ - PowerTag Resi9 F63</p>  <p>R9M60</p>  <p>R9M70</p>	<p>Wireless-communication energy sensor</p>	<p>Instruction Sheet (PDF)</p> <p>Device User Guide</p>
<p>PowerLogic™ - PowerTag Resi9 M63</p>  <p>R9M20</p>  <p>R9M41</p>	<p>Wireless-communication energy sensor</p>	<p>Instruction Sheet (PDF)</p> <p>Device User Guide</p>
<p>EVlink Home Smart</p>  <p>EVH4xxxN2</p>  <p>EVH4xxxNC</p>	<p>Supplies electric energy to charge plug-in electric vehicles</p>	<p>Instruction Sheet (PDF)</p> <p>Device User Guide</p>



# Setting-up the Wiser System

The following chapters guide you through the initial setup of your Wiser system.

## System Requirements

For a Wiser system you need at least the following devices and conditions.

### **Wiser Hub**

The Hub communicates with all Wiser devices and the Wiser Home app.

You can find more information about the available Hubs in Chapter List of Wiser Devices, page 10

### **Internet access for the Hub**

In order to properly control Wiser Devices, the Hub needs to be connected to the internet via your router.

### **Wiser devices**

You can find more information about the available Wiser Devices in Chapter List of Wiser Devices, page 10

### **Smartphone**

iOS Version 12 and higher

Android Version 5 and higher

### **Wiser Home App**

For more information, please read chapter Downloading the Wiser Home App, page 20.

### **A valid e-mail address.**

To set up your Wiser system, you will need to register an account at Schneider Electric with a valid e-mail address.

## Data localization

Data Localization in general refers to a mandatory legal or administrative requirement directly or indirectly requiring that data be stored or processed, exclusively or non-exclusively, within a specified jurisdiction.

If data localization laws apply in your region, we strongly recommend setting up this device or system in a way that would not conduct a data cross-border transfer directly or through other channels. Details of data localization laws may vary in different regions. Your legal team is the best resource to give you compliance advice for your specific situation.

## Support for battery-powered devices

By default, a system with a Hub can support up to 20 battery-powered devices, such as sensors. Systems that also include mains-powered devices can support additional battery-powered devices.

The reason for this is that mains-powered devices in the system also act as system network extenders.

**TIP:** Install and commission all mains-powered devices before commissioning battery-powered devices. This provides maximum hosting capacity prior to adding the battery-powered devices.

## Limitations of the Wiser System

When commissioning a Wiser system, it is important to understand the system limits, such as the maximum number of supported devices.

### System Limits

Maximum number of	
Devices total	63 Zigbee devices + 1 Hub + 20 PowerTag+ 1 EV Charger + 16 Airzone (Spain Only)
Devices Zigbee	63
Rooms	16
Moments	20
Automations	10

### Device Limits With Respect to Single Hub

Climate	Maximum overall	Maximum per Room
Room Thermostat	16	1
Radiator Thermostat	32	4
Underfloor Connection Strip	3	-
Boiler Relay	1	-
Flush-mounted Thermostat	16	4
16A Relay	48	4
Flush-mounted Thermostat + 16A Relay	48	Individually specified limits

Lights	Maximum overall	Maximum per Room
Lighting devices	32	32

Shutters	Maximum overall	Maximum per Room
Shutter Devices	32	32

Appliances	Maximum overall	Maximum per Room
Smart Plug + Connected Socket + Wiser Power Micromodule	20	20
1-gang / 2-gang Connected Wireless Switch	10	10
FIP Micromodule	48	4

<b>Sensors</b>	<b>Maximum overall</b>	<b>Maximum per Room</b>
Window + Door Sensor	10	10
Motion Sensor	10	10
Water Leakage Sensor	10	10
Temperature + Humidity Sensor	10	10

<b>Safety and Security</b>	<b>Maximum overall</b>	<b>Maximum per Room</b>
Smoke Alarm Battery	16	16

<b>Energy</b>	<b>Maximum overall</b>	<b>Maximum per Room</b>
PowerTag	20	-
EV Charger	1	1

## Third party devices

Third party devices

### Device Limits

<b>Device</b>	<b>Maximum overall</b>	<b>Maximum per Room</b>
Airzone	16	4

## Selecting the mounting location

The Hub is the controller of the system and must be within a range of all devices in order for the system to work properly.

The ideal location for the Hub is determined by the following:

- Layout of the building where the system is installed
- Location of other devices that will be used in the system

Referring to the next diagram, it is most important to locate the Hub (A) as central as possible to the area occupied by all mains-powered devices (B), such as switches and dimmers. Proximity to battery-powered devices (C) should also be considered in context with the tip mentioned after the diagram.

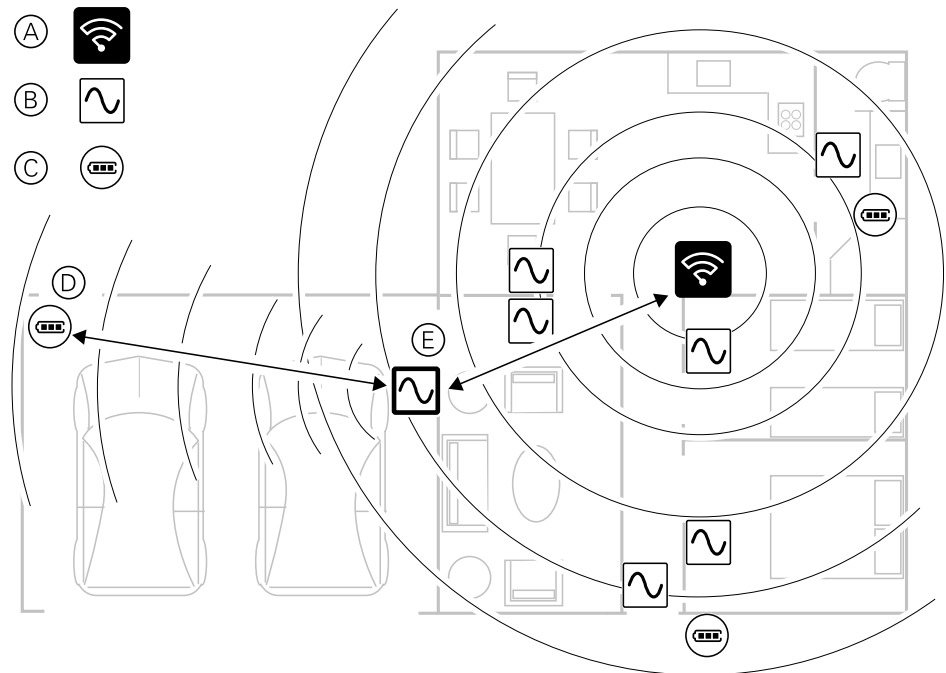

**TIP:** The battery-powered motion sensor in the garage (D) is a long way from the Hub. However, the sensor can connect to the hub via the main-powered device being used as the garage light switch (E). This is because mains-powered devices also act as system network extenders. Consider this when deciding where to locate the Hub.

## Wiser Home App

Use the Wiser Home app to set up the Wiser system, control Wiser devices and receive notifications.

## Downloading the Wiser Home App

Before you can set up your home, you need the Wiser Home app.

Download the Wiser Home app from the relevant app store:

### iOS

Requires iOS 12.0 or later

Search term: Wiser Home

<https://apps.apple.com/app/wiser-heat/id1222853887>

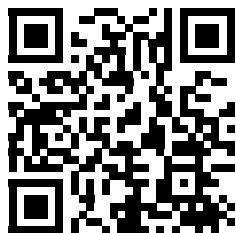

## Android

Requires Android 5.0 or later

Search term: Wiser Home

[https://play.google.com/store/apps/details?id=com.schneider\\_electric.WiserHeat](https://play.google.com/store/apps/details?id=com.schneider_electric.WiserHeat)



## Roles in the Wiser App

In the Wiser app, you can perform various tasks in the app, depending on the access level.

Function	Supported Features	Home owner	Professional Installer
<b>Creating an account</b>	Create an account by providing email address and setting up the password	Yes	No
<b>Setting up the Wiser System</b>	Adding and configuring the hub and devices.	Yes	Yes
<b>Manual Firmware Update</b>	Updating the hub firmware manually	No	Yes
<b>Manage Rooms</b>	Add or delete Rooms	Yes	Yes
	Name or rename Rooms	Yes	Yes
<b>Manage devices</b>	Add or delete devices	Yes	Yes
	Configure device feature setting and schedule	Yes	Yes
	Change device icon, name and location	Yes	Yes
	Control device	Yes	Yes
	Receive device notifications and alarms	Yes	Yes
<b>Manage Moments and Automations</b>	Create Moments and Automations	Yes	Yes
	Assign devices to Moments/Automations	Yes	Yes
	Adjust device settings in Moments/Automations	Yes	Yes
	Set Trigger conditions in Moments/Automations	Yes	Yes
	Receive Moment/Automation trigger notifications	Yes	Yes

### IMPORTANT:

1. As a professional installer, the app offers for setting up a Wiser System and adding devices without having to be logged in.
2. Any user can log in to the app, if the home owner provides the login credentials.

## Professional Installer

This is a setup role by the Professional Installer. The main task of the Professional Installer is to set up the Wiser system.

To use the App as a Professional Installer:

1. Tap **Get started** (A).



2. Tap **Professional Installer** (B).

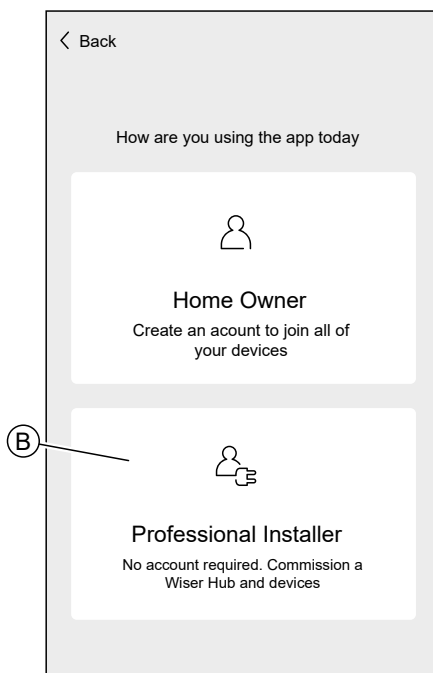

## Home Owner

The Home Owner can create an account and set-up the Wiser system.  
To use the App as a Home Owner:

1. Tap **Get started** (A).



2. Tap **Home Owner** (B) and create an account. Refer to [Setting an Account](#), page 41 for information on how to create an account.

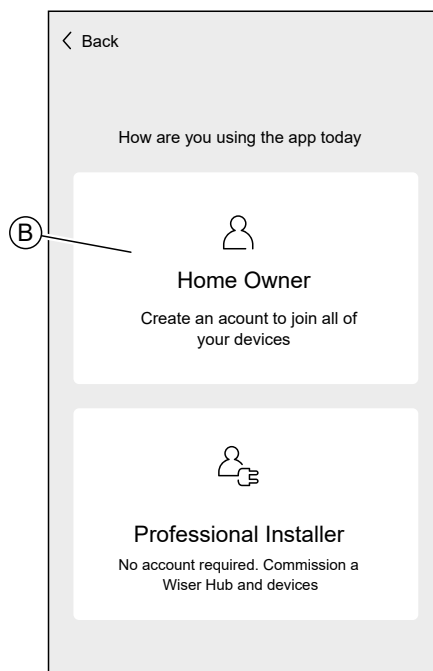

**NOTE:** After successfully creating your account using your email address and password, log in to the app and start using the Wiser system with your credentials.



## Login to the App

1. To login to the app, tap **Login (A)**.



2. Enter your credentials and tap **Login (B)**.

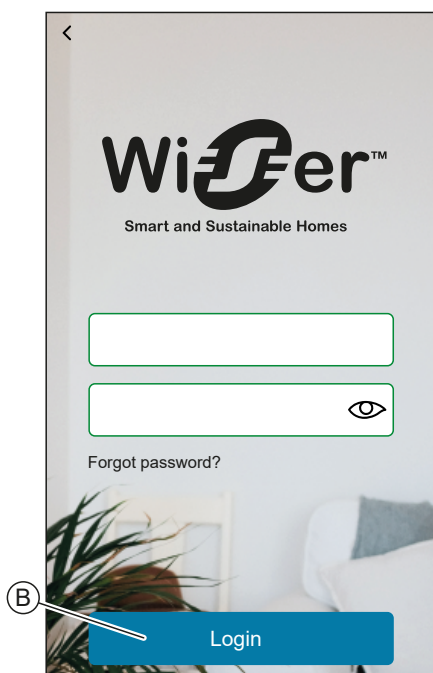

**NOTE:** You only have to log in to the app once. Each time you use the app again, you will be automatically logged in. You can log out of your account in the Account Settings, page 94.

---

## Cybersecurity Principles

This system hardening guideline can help you to follow best practices to improve the security of your system.

### Passwords

- Passwords should include upper case, lower case, number and special characters.
- The password must have 10 characters minimum.
- The password should not be easily found in the dictionary and a phrase is preferred.
- Passwords should be changed frequently, at least once a year.
- A default Admin password must be changed immediately when first received and after a factory reset.
- Never reuse passwords.
- After first login, change default password for local access.

### Network

- IoT devices should only be connected in your personal home internal network.
- IoT devices should not be made directly accessible from internet. Ensure that you DO NOT use port forwarding to access an IoT device from the public internet.
- An IoT device should be on its own network segment. If your router supports a VLAN or other form of network segmentation, the IoT device should be located there.
- Use the strongest Wi-Fi® encryption available.

### Software

- Always use the latest software for all devices in order to get new features, cyber security fixes and improvements.
- Keep your devices up to date.

### Firmware

- Always use the latest firmware for controlling devices in order to get new features, cyber security fixes and improvements.
- Keep the controlling devices up to date.

## Setting up the Hub

In order to be able to control the system via your smartphone, the hub must be connected to the internet.

You can set up the Hub by using the app as Home Owner and Professional Installer.

The app offers the Professional Installer menu for setting up a Wiser System and adding devices without having to be logged in.

You can also setup the Wiser System by using the app as a Home Owner after creating an account. Refer to [Setting up an Account](#), page 41 for information on how to create an account.

## Setting up as a Professional Installer

The app offers the Professional Installer menu for setting up a Wiser System and adding devices without having to be logged in.

**NOTE:** The option to act as a Professional Installer is only available if you are logged out of the app. To log out of the app, navigate to the [Account settings](#), page 94 and tap **Logout**.

To set up the Wiser System as Professional Installer:

1. On the welcome screen, tap **Get started** (A).



## 2. Tap **Professional Installer (B)**.

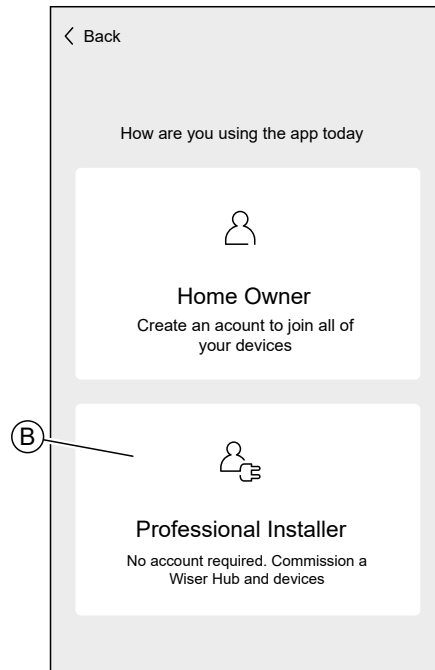

## 3. Select your country from the list.

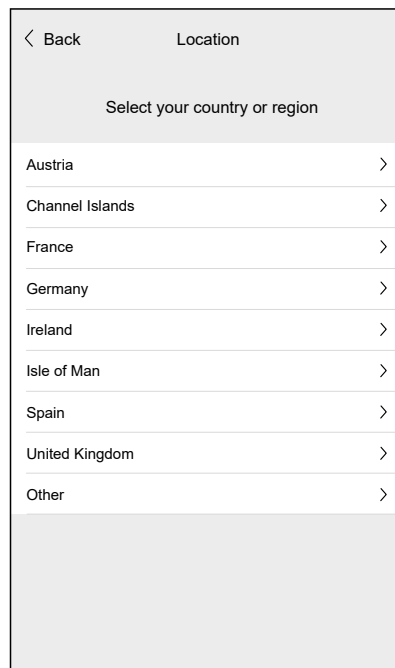

The Add Devices screen allows you to add a Hub to the system. Refer to and Entering Wi-Fi® login information, page 39 to add and setup the Hub.

You can also download firmware into your app that will update the hub during setup. See Downloading hub firmware into the app, page 30.

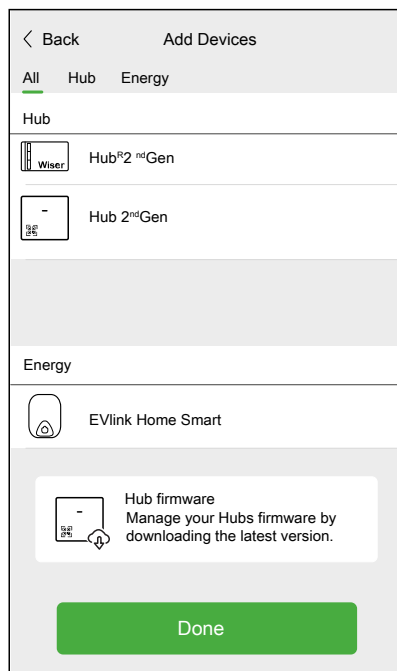

## Downloading hub firmware into the app

When the hub is connected to the Wiser cloud, it automatically updates the latest firmware.

If you want to update the hub manually before connecting to the cloud, you can use the app as a professional installer.

As professional installer, page 27:

1. Tap **Hub-Firmware (A)**.

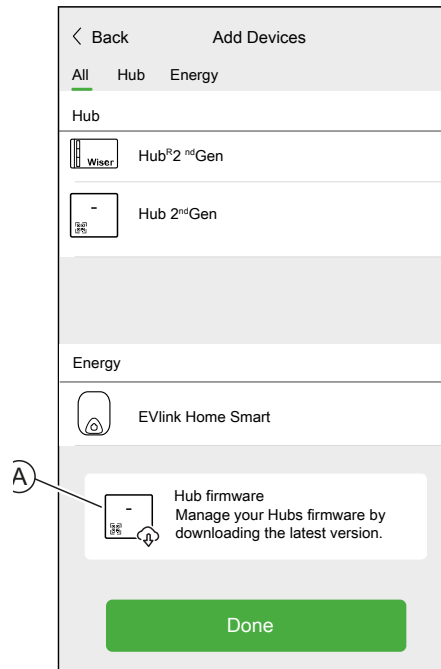

2. Tap **Check for updates (B)**.

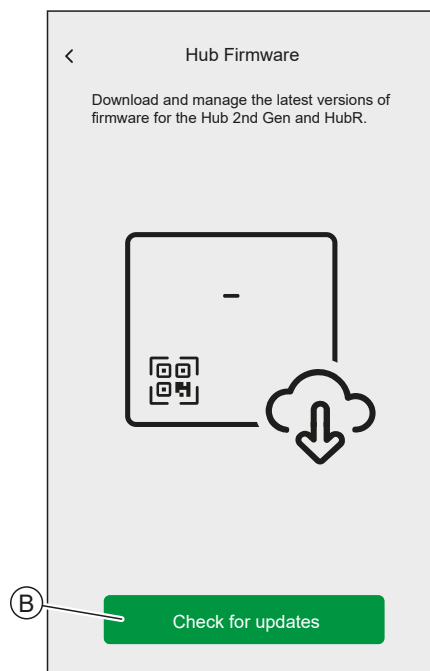

3. If there is a new version of firmware, it will be downloaded into the app.

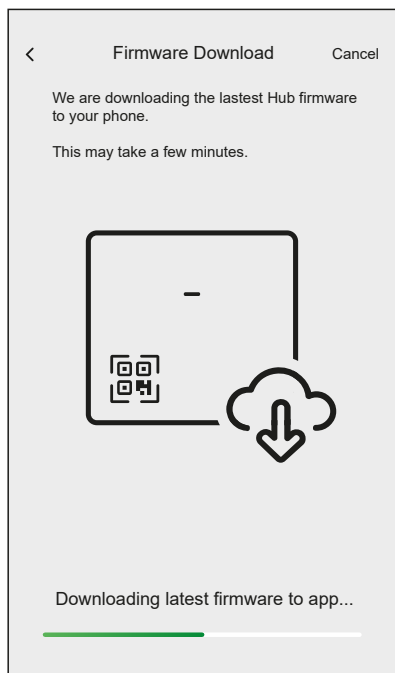

If a firmware is saved in the app, you can check the version number and expiry date.

To check if a newer version is available, tap **Update firmware** (A).

To remove a firmware from your app, tap the **bin** (B).

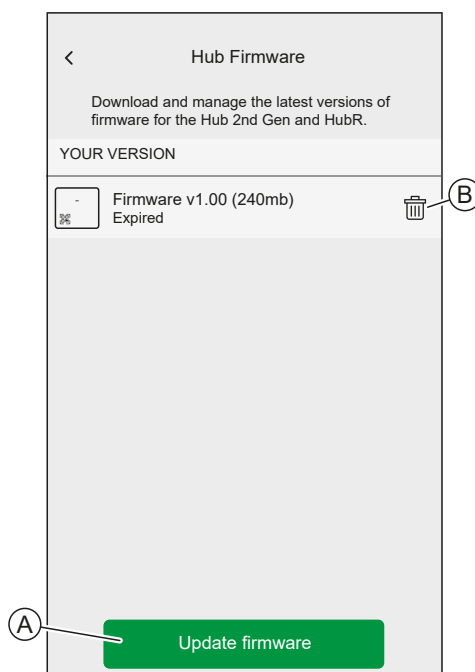

## Connecting to the Hub's Temporary Wi-Fi® Network

The hub will create a temporary Wi-Fi® network. Connect your phone to the Hub's Wi-Fi® network.

Using app as a Professional Installer, page 27 or Home Owner:

1. Select your Hub.

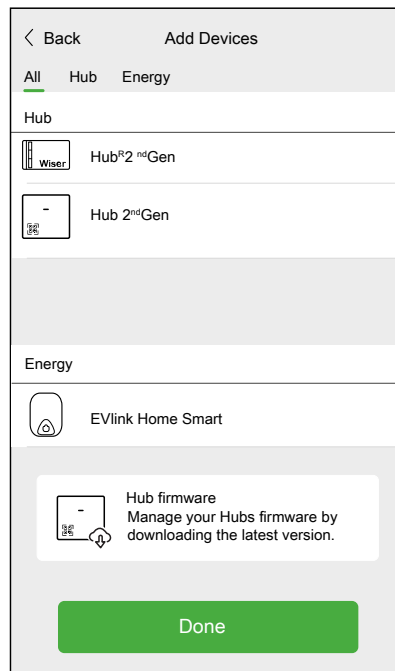

**NOTE:** If no firmware is saved in the app, you will be asked if you want to download the latest firmware.

2. Put the Hub into setup-mode.

**NOTE:** The method of putting the hub into setup-mode is individual for each hub. Refer to the instructions provided by the App.



3. Tap **Next** (A).

For Hub 2nd Generation:

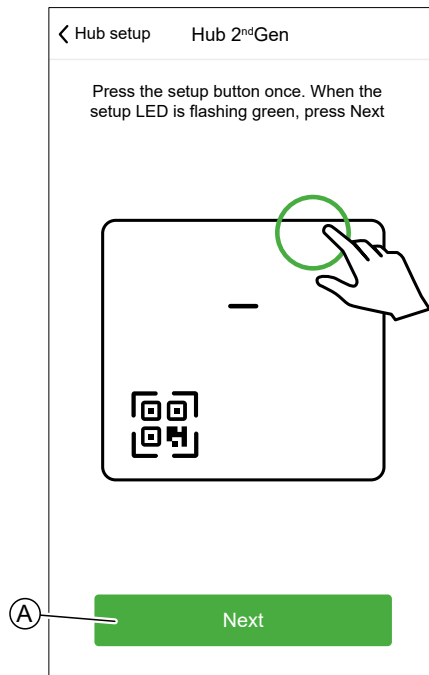

For HubR 2nd Generation:

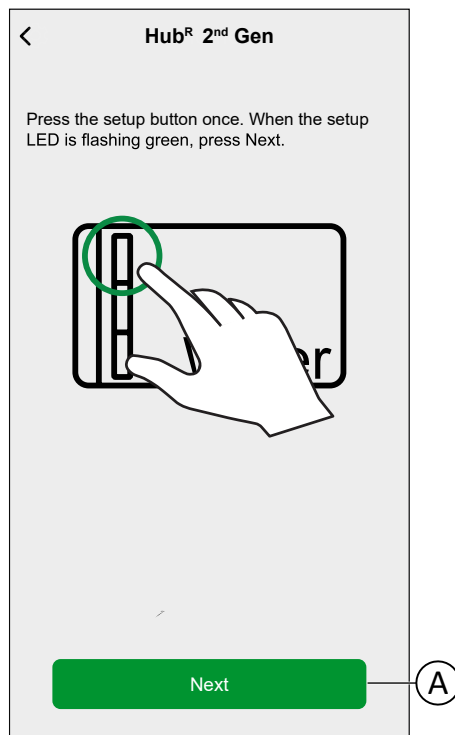

4. Connect your smartphone to the app's temporary WiFi network either by QR Code connection or Manual connection.

**TIP:** Tap **I can't find the password** to open the Schneider Electric FAQ site in your browser.

#### QR code Connection:

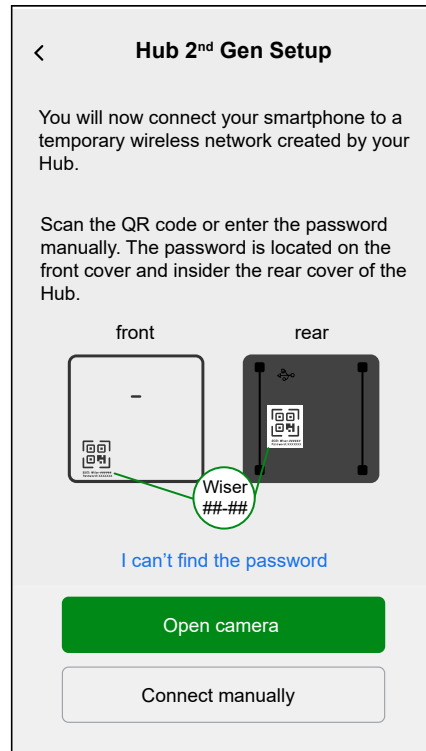

- a. Tap on **Open Camera** and scan the QR code from the device.

**IMPORTANT:** Allow the app to access your camera when prompted.

- b. A pop-up will appear, requesting permission to use a temporary WiFi network. Tap **Connect** to establish the connection.

#### Manual Connection:

- a. Tap on **Connect Manually**.
- b. Navigate to your smartphone's settings or tap **Open Wi-Fi Settings (C)**.
- c. Connect to the Hub Wi-Fi® and enter password located on the front cover and inside the rare cover of the Hub.
- d. Return to the Wiser Home App and tap **Continue (D)** to establish the connection.

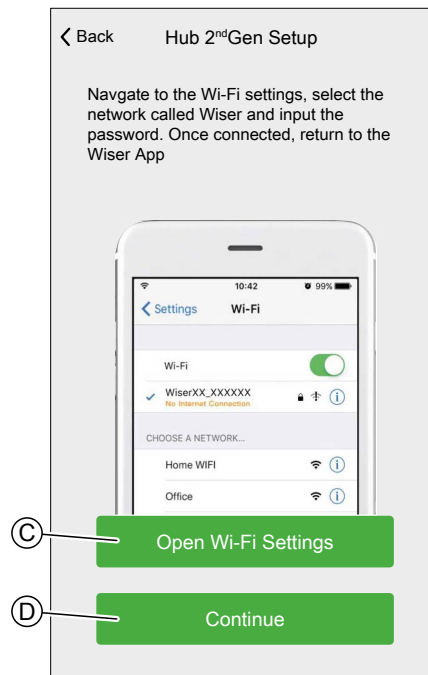

5. If you want to check if the Hub has the latest version of firmware or complete the installation process without connecting to the network, tap **Skip** (F) and continue with chapter Updating the firmware, page 36

**NOTE:** The **Skip** (F) option is not available if you login to the app as a Home Owner. Refer to Roles in the Wiser App, page 22 to find more information on the access levels.

**NOTE:** The Professional Installer has the ability to skip the Wi-Fi® setup on all Hubs and complete the installation process. However, this means you won't be able to connect the hub to Wi-Fi®, register for an account, or control your devices outside of your home.

6. To connect the hub with your Wi-Fi® network and continue the setup, tap **Continue** (G) and continue with chapter Entering Wi-Fi® login information, page 39.

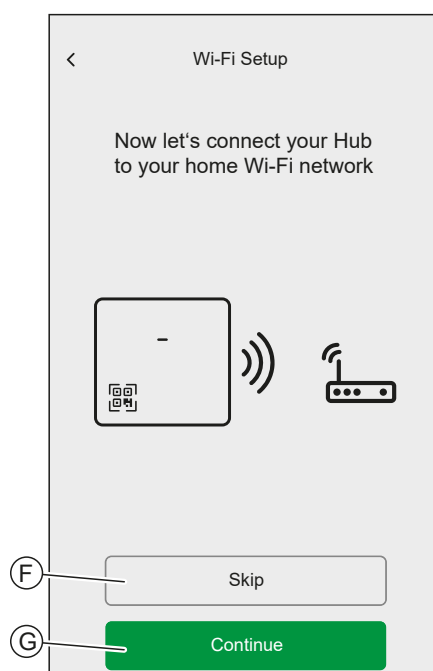

## Updating the firmware

When the hub is connected to the Wiser cloud, it automatically updates the latest firmware. For the first time installation, if you want to check and update the firmware manually, use the app as a professional installer.

To check and update the firmware manually:

1. Use the Wiser Home App as a professional installer, page 27.
2. Download the latest hub firmware to the app. Refer to Downloading hub firmware into the app, page 30.
3. Follow the steps in chapter Connecting to the Hub's Temporary Wi-Fi® Network , page 31.
4. When asked to Connect your Hub to your home Wi-Fi® network, tap **Skip** (A).

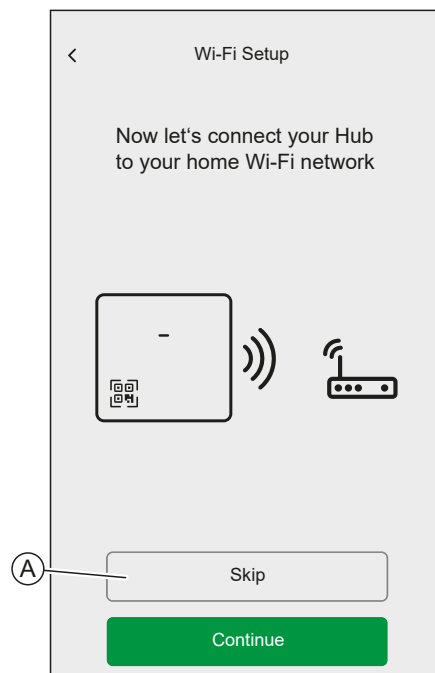

5. Tap **Yes, check and update** (B).

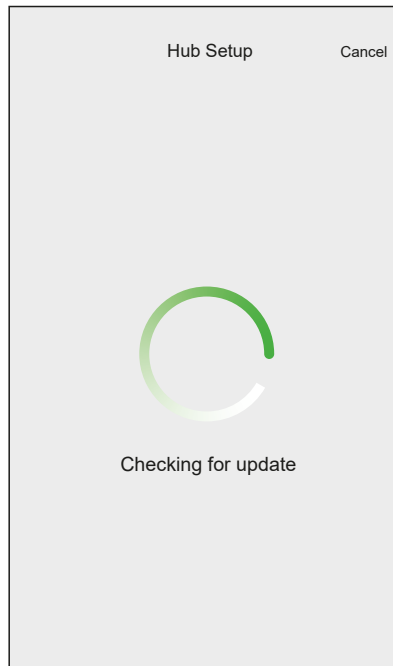
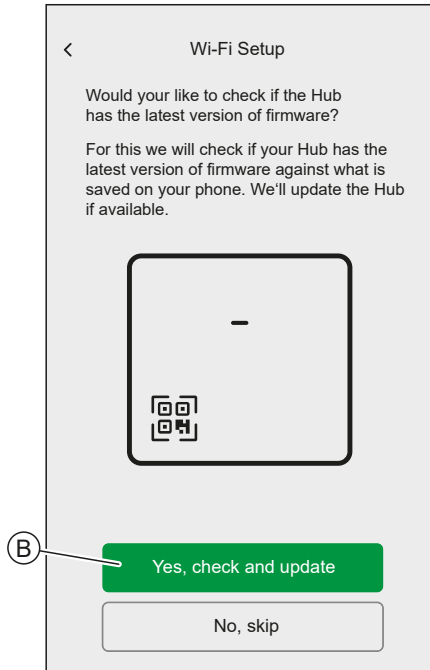

## 6. Here are the possible conditions:

- If the firmware version on your smartphone matches the one on the hub, your setup is complete. You can proceed to add devices.
- If the firmware version on your smartphone doesn't match the one on the hub, the hub will automatically update to the latest firmware version.

**IMPORTANT:** Do not close the Wiser Home App during this process.



## Entering Wi-Fi® login information

Once you are connected to the hub's Wi-Fi®, you can enter the login information of your home Wi-Fi® into the hub.

To enter the Wi-Fi® login information:

1. Use the Wiser Home App as a Professional Installer, page 27 or a Home owner.
2. Follow the steps in chapter Connecting to the Hub's Temporary Wi-Fi® Network , page 31.
3. When asked to Connect your Hub to your home Wi-Fi® network, tap **Continue (A)**.



4. Select your Wi-Fi® network from the list.

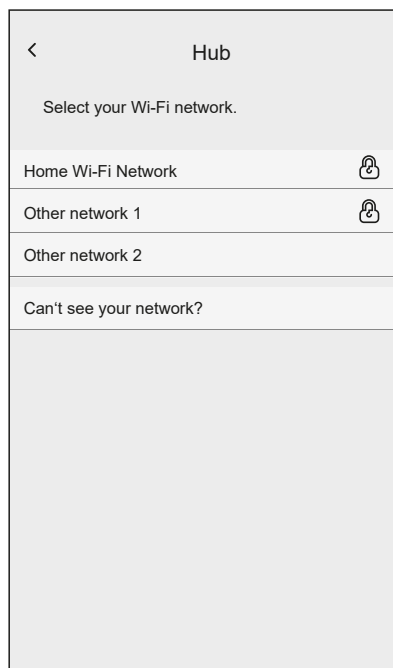

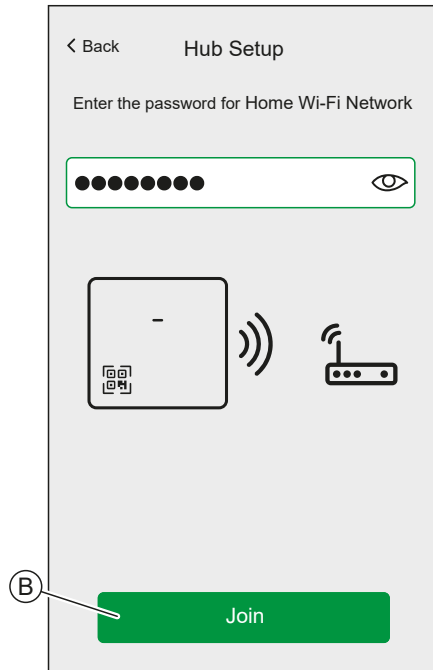
5. Enter the Wi-Fi® password and tap **Join** (B).

When the hub is connected to your Wi-Fi® network, you can start adding devices to your hub.

**NOTE:** The hub only operates in the 2.4 GHz range.

For more information about adding devices to the hub, refer to chapter *Adding a Device*, page 53.

When all devices are connected to the hub, tap **Done** (A).

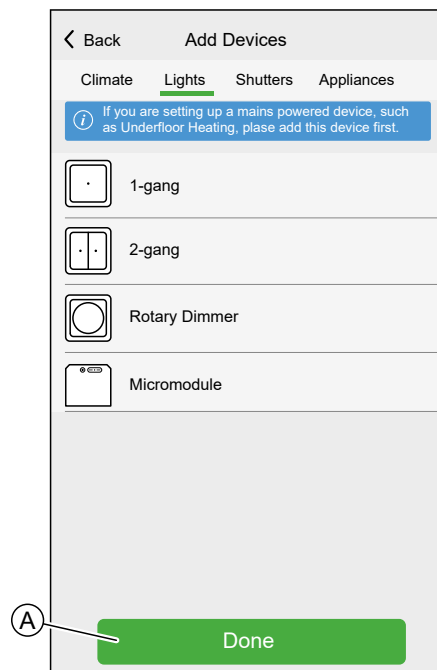



## Setting an Account

To be able to control the system from your smartphone, you need to create an account and log in.

Once the professional installer sets up the Wiser system, they will hand it over to the homeowner. Subsequently, the homeowner will create an account to have control over the Wiser system. Refer to the chapter [Setting-up the Wiser System](#), page 17 for information on how to setup the wiser system.

If the homeowner decides to set up the Wiser system independently, they need to begin by creating an account before proceeding with setting up the Wiser system.

**IMPORTANT:** Only a Home Owner have an access to create an account.

1. On the welcome screen, tap **Get started**.



2. Tap **Home Owner** to create an account.

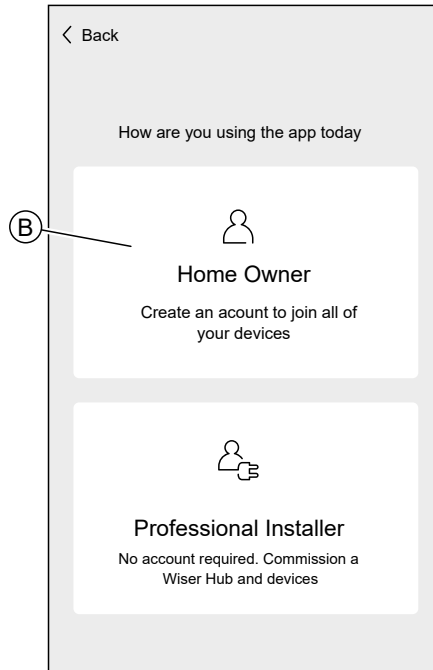

3. Enter your name and e-mail address

4. Enter a password

**NOTE:** The password must meet at least the following criteria:

- Eight characters long
- Contain at least one uppercase letter
- Contain at least one number

**TIP:** Increase the security of your password by observing the following points:

- Do not use any personal information such as a name, birthday, e-mail address, etc. These data are publicly visible and make it easier to guess the password.
- Use a long password. It should contain at least six characters; longer passwords help increase security.
- Do not use a password that you have already assigned for another service.
- If possible, include numbers, special characters and differences in upper and lower case.
- Change the password frequently.

**TIP:** For more information about securing your network, read chapter *Cybersecurity Principles*, page 26

5. Select the country in which your home is located.

6. Tap **Continue** .

The screenshot shows the 'Account' registration screen. At the top, there is a navigation bar with a back arrow and the title 'Account'. Below this are several input fields: 'First name', 'Last name', 'Email address', 'Password' (with an eye icon to toggle visibility), 'Repeat Password' (with an eye icon), and 'Country' (with a pencil icon). Below the 'Country' field, there is a small text note: 'Please ensure your password is at least 8 characters and it includes at least 1 capital and 1 number.' At the bottom of the form is a large green button labeled 'Continue'.

7. Activate account.

An e-mail will be sent to the specified e-mail address. Check your inbox and click the link in the e-mail.

**TIP:** If you do not see the e-mail in your inbox, also check the spam folder if your provider offers one.

You can change the information and have the e-mail sent again

After confirming the e-mail, the Wisier Home app shows the confirmation that the setup is complete.

8. Tap ✓ icon.

The screenshot shows the account verification confirmation screen. At the top, there is a navigation bar with a back arrow and the title 'Account'. In the center, there is a large envelope icon. Below the icon, there is text: 'A verification email has been sent to yourname@email.com. Please click the link in the email to verify your account and return to this App. Don't forget to check your junk folder!'. At the bottom, there are two buttons: 'Email address is incorrect' and 'Re-send the email'. At the very bottom of the screen is a large green bar with a white checkmark icon.

9. Read and tick the check box to agree with the **User Agreement** and **Privacy Notice** and tap **I accept**.

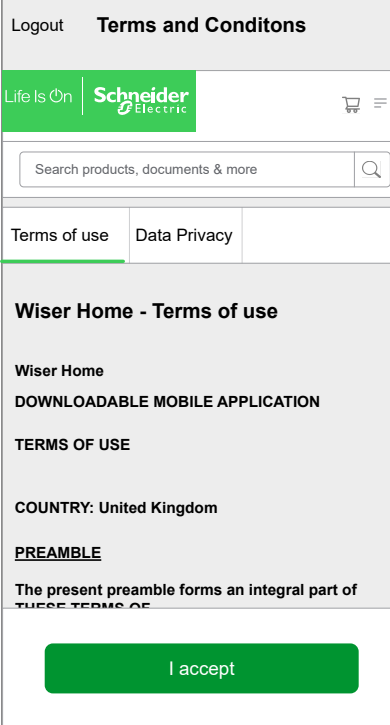

Logout **Terms and Conditions**

Life Is On | **Schneider**  
Electric

Search products, documents & more

Terms of use | Data Privacy

**Wiser Home - Terms of use**

**Wiser Home**

**DOWNLOADABLE MOBILE APPLICATION**

**TERMS OF USE**

**COUNTRY: United Kingdom**

**PREAMBLE**

The present preamble forms an integral part of  
THESE TERMS OF

I accept

10. Personalize your consents and tap **Continue**.

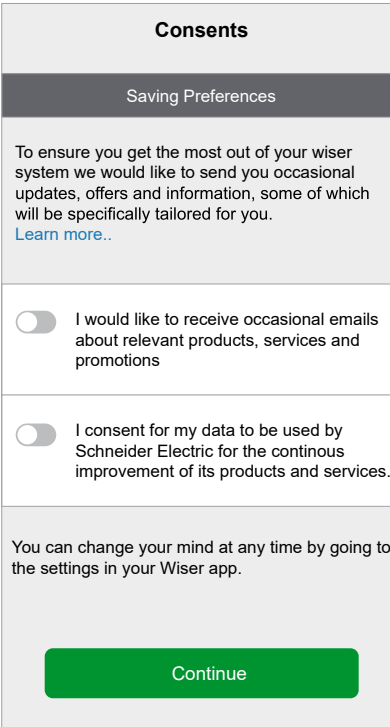

**Consents**

Saving Preferences

To ensure you get the most out of your wiser system we would like to send you occasional updates, offers and information, some of which will be specifically tailored for you.  
[Learn more..](#)

I would like to receive occasional emails about relevant products, services and promotions

I consent for my data to be used by Schneider Electric for the continuous improvement of its products and services.

You can change your mind at any time by going to the settings in your Wiser app.

Continue

### 11. Enter your home address and tap **Continue**.

The home address is required so that functions dependent on the location (e.g. Eco-Mode) work properly.

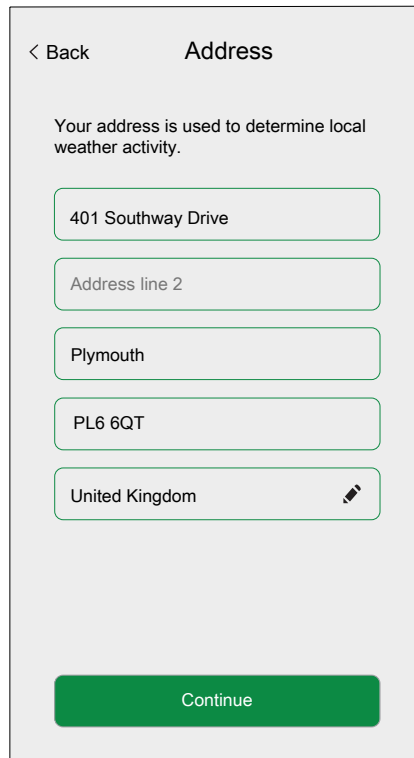

< Back      Address

Your address is used to determine local weather activity.

401 Southway Drive

Address line 2

Plymouth

PL6 6QT

United Kingdom 

Continue

You can now control your home with the Wiser Home app, add set up Devices and Rooms.

## Connecting Devices to the Hub

For the Wiser devices to be controlled by the hub, they must be connected to the hub.

Connecting devices to the hub is part of the set up process. You can also add devices to the hub at any time. The app guides you through the process of adding devices.

You can find detailed information about the necessary steps for adding devices in the chapter [Adding a Device](#), page 53.

## Getting to know the Hub

The Wiser Hub is the center of the system. It monitors and controls the Devices of your Home via the Wiser Home App. It is connected to the Wiser Cloud for remote control via Wi-Fi®.

### Wiser Hub 2<sup>nd</sup> Generation

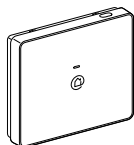

CCT501801

The Wiser Hub 2<sup>nd</sup> Generation monitors and controls the Devices of your Home via the Wiser Home App. It is connected to the Wiser Cloud for remote control via Wi-Fi®.

The Wiser Wiser Hub 2<sup>nd</sup> Generation is compatible with all Wiser Devices

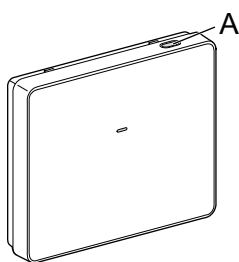

### Operating Elements





A	<b>Setup</b> button	For commissioning and resetting the Hub
---	---------------------	---

### LED behaviour



LED	Description
	Hub is powered on and operating as normal.
	Temporary Wi-Fi® network of Hub is enabled
	The Hub is actively searching for the device to pair.

LED	Description
	<p><b>Wi-Fi® Error</b></p> <p>Hub is unable to connect to your Wi-Fi® network.</p> <p>Check if your router is powered on and operating as normal. If you have changed your Wi-Fi® credentials or installed a new router, configure the hub accordingly.</p> <p><b>Firmware update</b></p> <p>During the firmware update process, Hub will disconnect from Wi-Fi®.</p>
	<p>Hub cannot connect to Wiser Cloud.</p> <p>The hub continues to control the connected devices as normal.</p> <p>The App will only connect to the Hub when your smartphone is in the same Wi-Fi® network as the Hub.</p>

## Updating

Firmware updates are intended for security and functional updates to help ensure that the System is always up to date. The firmware updates automatically and it runs in the background.

## Resetting to factory defaults

You can reset the Hub to it's factory defaults.

**NOTE:** Resetting the Hub will delete the Wiser System you have set up. If you want to reinstall your System, you will have to also reset all your Connected Devices and add them again to your System. Refer to resetting the device chapter in the Device User Guide of the respective Device. [List of Wiser Devices, page 10](#) provides the links to Device user guide for each devices. You will have to recreate all schedules, moments, automations, etc.

Only use the reset when you want to decommission your Wiser System or if all other troubleshooting measures failed.

To reset the Hub to factory defaults:

1. Press and hold the **Setup** button until the Setup LED flashes red.

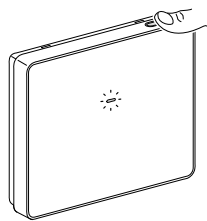

The LED flashes green once after a successful factory reset.

## Wiser Hub<sup>R</sup> 2<sup>nd</sup> Generation



CCTFR6311G2

You can connect a heating or hot water system directly to the Wiser Hub<sup>R</sup> 2<sup>nd</sup> Generation.

The app will guide you through the process to configure and add the devices to the system.

Once configured and added, the system connected to the Wiser Hub<sup>R</sup> 2<sup>nd</sup> Generation will show up as a device in the app and can be configured and operated accordingly.

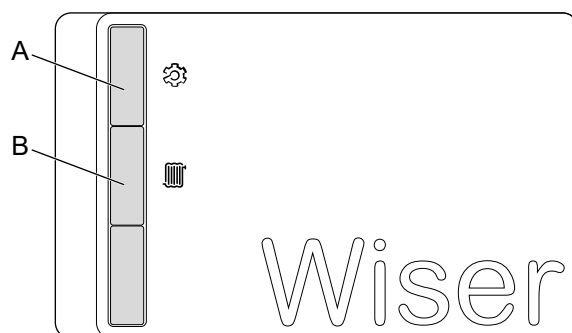

## Operating Elements





A	<b>Setup</b>	Activates the temporary Wi-Fi network of the Hub. Useful for troubleshooting.
B	<b>Heating Override</b>	<p>Only for troubleshooting.</p> <p>Turning on the heating override will turn on the connected heating system for 2 hours regardless of any settings in the app or thermostats.</p> <p>To start override: press and hold button for more than 3 seconds.</p> <p>To stop override, short press the button.</p>

## LED Behavior



### Setup LED

LED	Description
	Hub is powered on and operating as normal.
	Temporary Wi-Fi <sup>®</sup> network of Hub is enabled
	The Hub is actively searching for the device to pair.



LED	Description
	<p><b>Wi-Fi® Error</b></p> <p>Hub is unable to connect to your Wi-Fi® network.</p> <p>Check if your router is powered on and operating as normal. If you have changed your Wi-Fi® credentials or installed a new router, configure the hub accordingly.</p> <p><b>Firmware update</b></p> <p>During the firmware update process, Hub will disconnect from Wi-Fi®.</p>
	<p>Hub cannot connect to Wiser Cloud.</p> <p>The hub continues to control the connected devices as normal.</p> <p>The App will only connect to the Hub when your smartphone is in the same Wi-Fi® network as the Hub.</p>

## Heating LED

LED	Description
	Connected heating is active.
	Override is active.

## Updating

Firmware updates are intended for security and functional updates to help ensure that the System is always up to date. The firmware updates automatically and it runs in the background.

## Resetting to factory defaults

You can reset the Hub to it's factory defaults.

**NOTE:** Resetting the Hub will delete the Wiser System you have set up. If you want to reinstall your System, you will have to also reset all your Connected Devices and add them again to your System. Refer to resetting the device chapter in the Device User Guide of the respective Device. [List of Wiser Devices, page 10](#) provides the links to Device user guide for each devices. You will have to recreate all schedules, moments, automations, etc.

Only use the reset when you want to decommission your Wiser System or if all other troubleshooting measures failed.

To reset the Hub to factory defaults:

1. Press and hold the **Setup** button (A) until the Setup LED flashes green and amber.

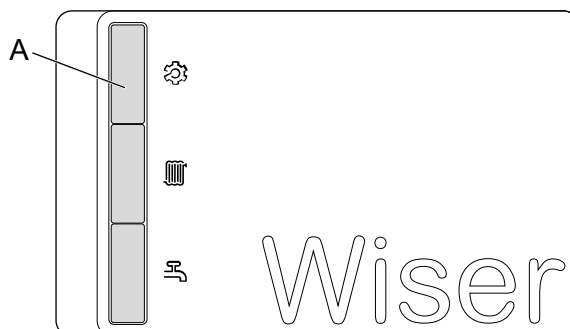

To signal the completion of the reset, all LEDs will flash green once.

# Configuring the Wiser System

## Devices

Adding new Devices / Assigning Devices to Rooms / Device settings / Removing a Device

## List of Devices

In the Devices page, you can find all installed Devices of your Home, sorted by their device type.

The Devices will also display their Name, their Room location and, if applies, other information, e.g. the charge level of the battery and the indication of zigbee signal strength.

Tap a Device in the List to navigate to the Device Details, page 57.

1. Login to the app.
2. On the Home Screen, tap  (A).

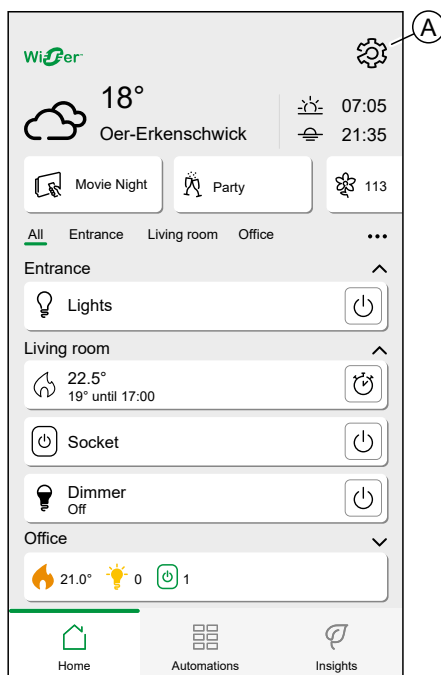

3. Tap **Devices** (B).

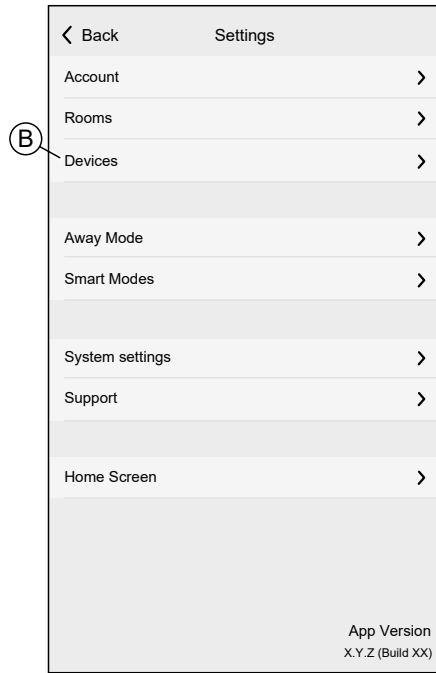

List of Devices:

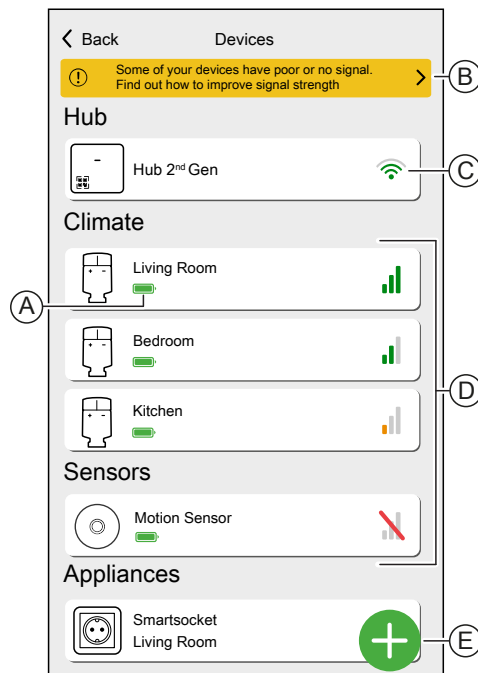

A	The battery charge level indicator which displays the current battery status for battery-powered devices.
B	Tap/click on the banner to get details about devices experiencing signal issues. Refer to <i>Device With Signal Issues</i> , page 53 for details on devices facing the signal issues and refer to <i>About Signal Strength</i> , page 125 to know more about the zigbee signal strength.
C	Hub Wi-Fi® signal strength indicator which displays your hub's connection to your Wi-Fi® network. When the indicator displays  , it signifies that there is no signal or connection.
D	Zigbee Signal strength indicator which displays the current signal strength of the zigbee devices. <b>NOTE:</b> This feature is not applicable for Wiser Plug device.
E	Tap/click to add devices.

## Device With Signal Issues

You can view devices which are currently offline and those with poor signal strength. Additionally, you'll find information regarding signal strength and solutions.

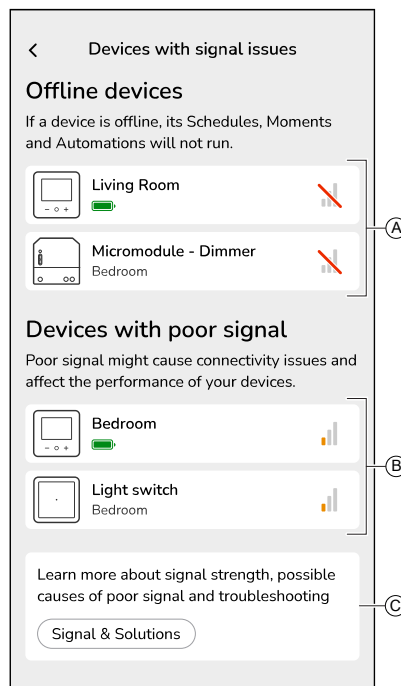

A	Displays a list of all devices that are currently offline.
B	Lists devices experiencing weak signal strength.
C	Tap <b>Signal &amp; Solutions</b> for detailed information about Zigbee signal strength and possible solutions.

## Adding a Device

You can add a new Device at any time.

**NOTE:**

- The Hub must be installed before adding a Wiser device.
- Add mains-powered devices before battery-powered devices. Refer to *Selecting the mounting location*, page 20.

1. Tap  (A) in the List of Devices, page 51.

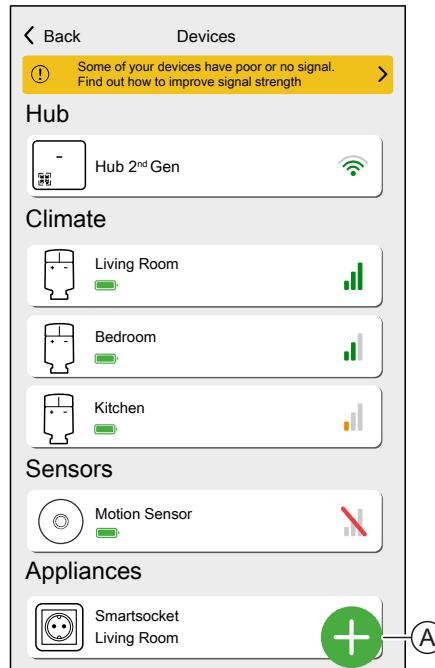

2. Find your device by navigating the categories at the top of the screen (B).
3. Tap the **type of Device** (C) you want to add and follow the instruction in the app.

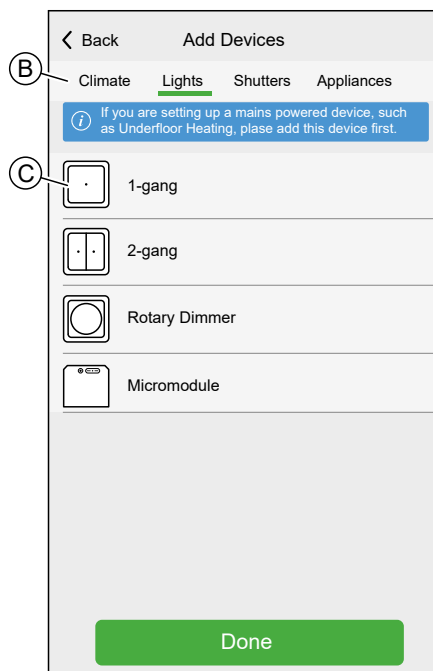

4. Tap **Next** (D).

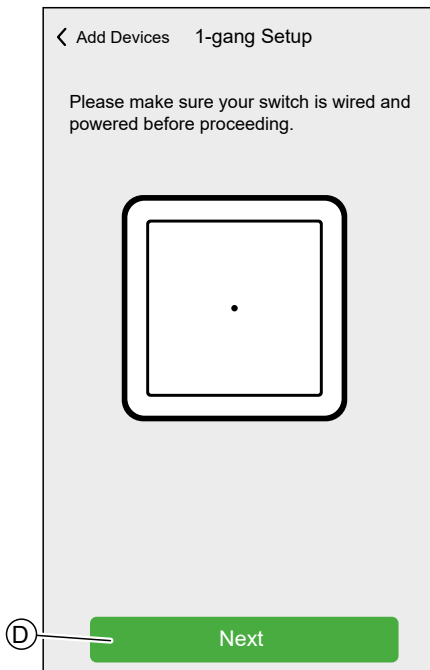

5. Set the Device into pairing mode.

The Wiser Home App will guide you through the pairing process. You can find detailed information about the pairing mode in the Device User Guide of the respective device. Refer to [List of Wiser Devices](#), page 10 for the links to Device user guide for each devices.

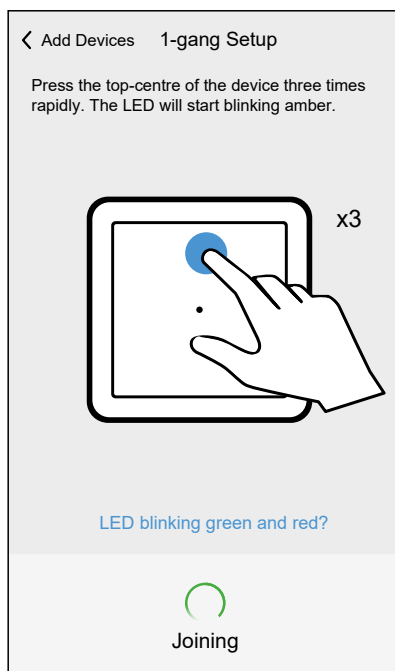

When the pairing is complete, you can give the device a name.

6. Enter a name for the Device.

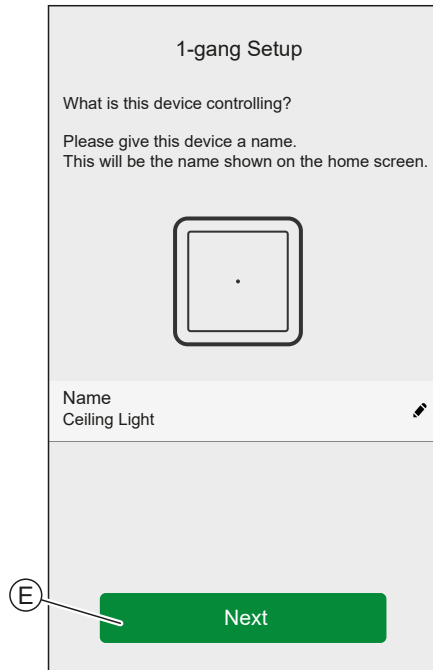
7. Tap **Next** (E).

## 8. Assign the Device to an existing Room, page 58 or create a new Room by entering a name in the field (F).

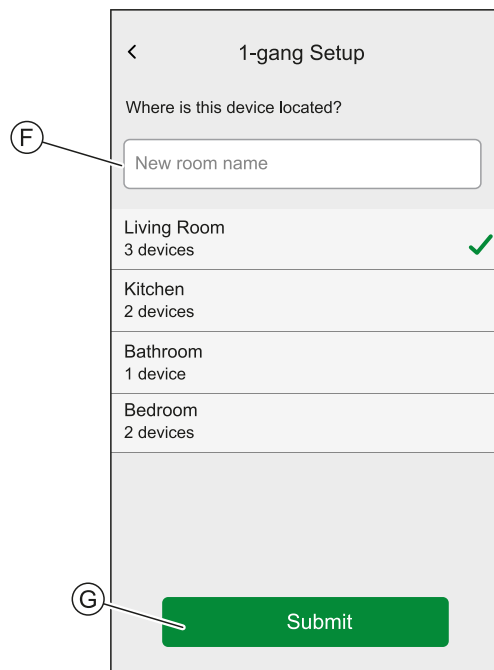
9. Tap **Submit** (G).

You can now control the Device with the Wiser Home App. You can find detailed information about controlling your Devices in chapter [Controlling the Wiser System](#), page 104

Depending on the type of Device, there are further features available. You can find detailed information in the Device User Guide of the respective device. Refer to [List of Wiser Devices](#), page 10 for the links to Device user guide for each devices.



## Device Details

You can find all relevant settings of a Device in the Device details.

You can navigate to the Device details from the List of Devices, page 51 by tapping the Device or from the Device control, page 107 by tapping the device setting.

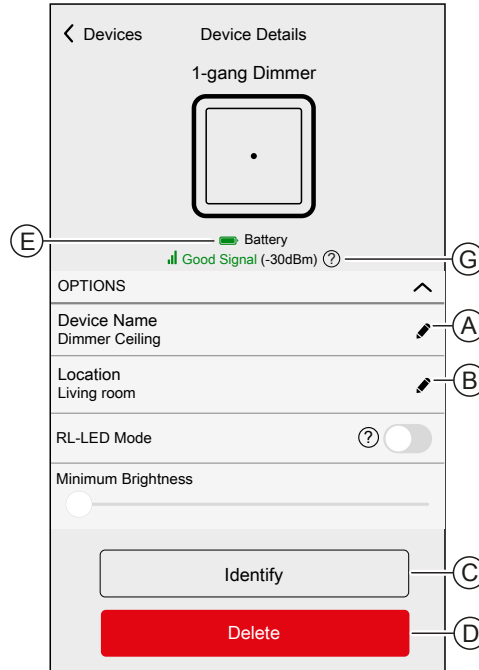

A	Tap to change the name of the device.
B	Tap to change the location of the of the device <b>NOTE:</b> <ul style="list-style-type: none"> <li>• A Device can only be assigned to one Room.</li> <li>• Devices (except the Climate devices) which you remove from the room are listed as <b>unassigned</b>.</li> <li>• Climate Devices must be assigned to a Room in order to function. Climate Devices will combine into a single Climate Control when assigned to the same room. You can find detailed information about the Climate Control in chapter: Climate Control, page 109.</li> </ul>
C	Tap to identify the device. <b>NOTE:</b> Most of the devices will light up their status LED to help locate them. You can find the detailed information about this behavior in the Device User Guide of the respective device. Refer to List of Wiser Devices, page 10 for the links to Device user guide for each devices.
D	Tap to remove the device from the Wiser system. <b>NOTE:</b> Removing a device should only be necessary if it needs to be replaced or as part of troubleshooting, for example, if you need to reconnect the device to the hub.
E	The battery charge level indicator which displays the current battery status for battery-powered devices.
G	Zigbee Signal strength indicator which displays the current signal strength of the zigbee devices. Refer to About Signal Strength, page 125 to know more about the zigbee signal strength. <b>NOTE:</b> This feature is not applicable for Wiser Plug device. <b>IMPORTANT:</b> The signal strength is not displayed for Wi-Fi devices. It will only display no-signal (  ) if the device is offline.

Some devices have specific features and settings. For example, Shutter devices have an option to set the duration for opening and closing. You can find detailed

information in the Device User Guide of the respective device. Refer to [List of Wisier Devices](#), page 10 for the link to device user guide of each devices.

## Rooms

Adding new Rooms / Changing Room Information / Room settings / Removing a Room

## List of Rooms

In the Rooms page, you can find all your Rooms in a condensed list.

You can add new Rooms.

Tap a Room in the list to navigate to the Room options.

On the Setting menu, page 91:

1. Tap **Rooms (A)**.

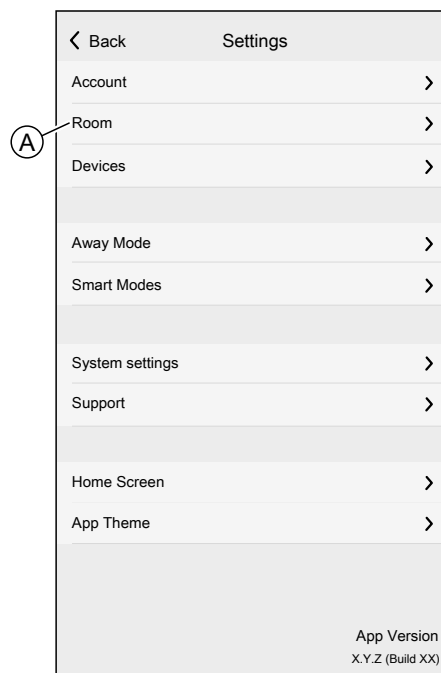

List of Rooms:

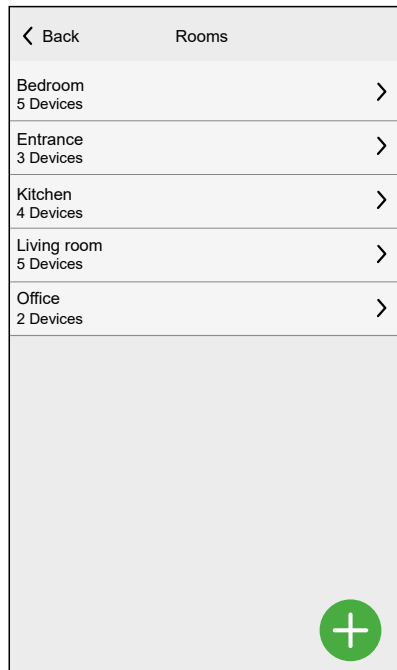

**NOTE:** When calculating the number of Devices in a Room, each Climate Device of a Climate control, page 109 will be counted individually.

For certain multi-gang Devices, each gang will be counted as a single Device.

## Adding a Room

You can add a new Room when assigning a Device or from the List of Rooms, page 58:

1. Tap  (A) icon.



2. Enter a name in the **text field** (B).

### 3. Tap **Submit** (C)

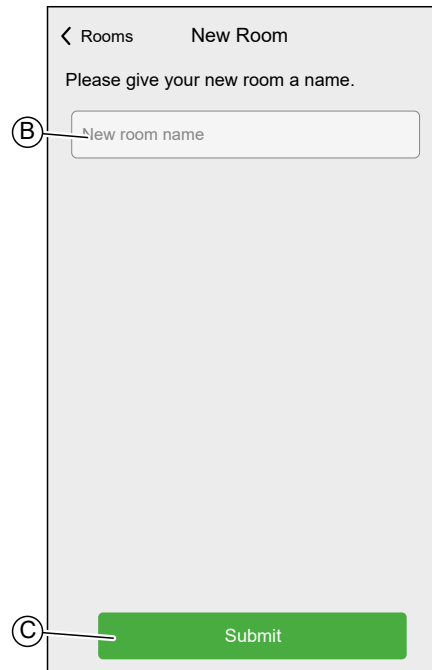

## Room Details

In the Room details screen, you can check and change Room specific options, like a list of Devices assigned to a Room or changing the name of the Room.

Some devices have specific options and settings. For example **Open Window Detection**, when a Radiator Thermostat is assigned to the Room. You can find detailed information in the Device User Guide of the respective device. Refer to List of Wiser Devices, page 10 for the links to Device user guide for each devices.

Tap a Device to navigate to the Device Options.

In the List of Rooms, page 58:

1. Tap a **Room** (A).

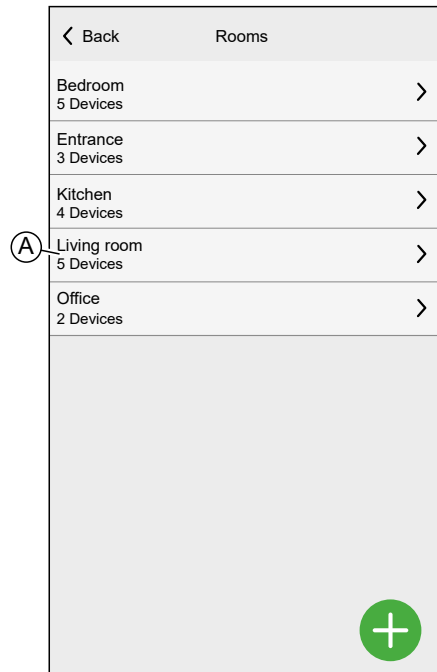

Room Details:

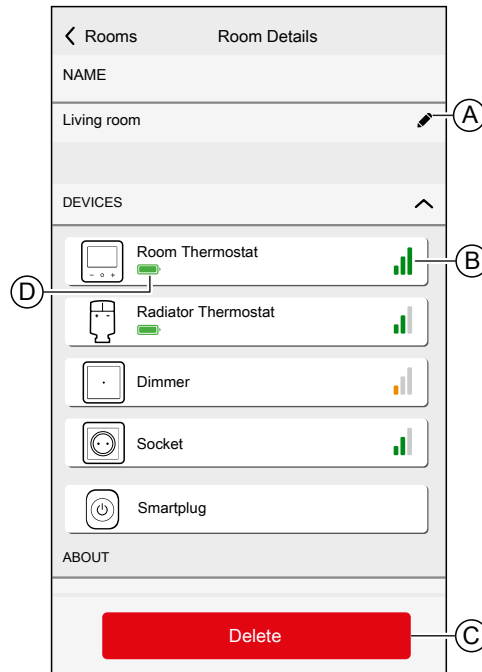

A	Tap to change the name of the room
B	Zigbee Signal strength indicator which displays the current signal strength of the zigbee devices. Refer to <i>About Signal Strength</i> , page 125 to know more about the zigbee signal strength. <b>NOTE:</b> This feature is not available for the Wiser Plug device.
C	Tap to delete the room. <b>NOTE:</b> <ul style="list-style-type: none"> <li>• Deleting a Room should not be necessary after you set up your Home, but you can do so at any time.</li> <li>• When you delete a Room, all the devices (except the climate device) assigned to that room will be listed as <b>Unassigned</b> in the Home screen.</li> </ul>
D	The battery charge level indicator which displays the current battery status for battery-powered devices.

## Moments

Create a Moment to change the state of several devices with the tap of one button.

Moments are created and edited on the **Automation** screen (A)

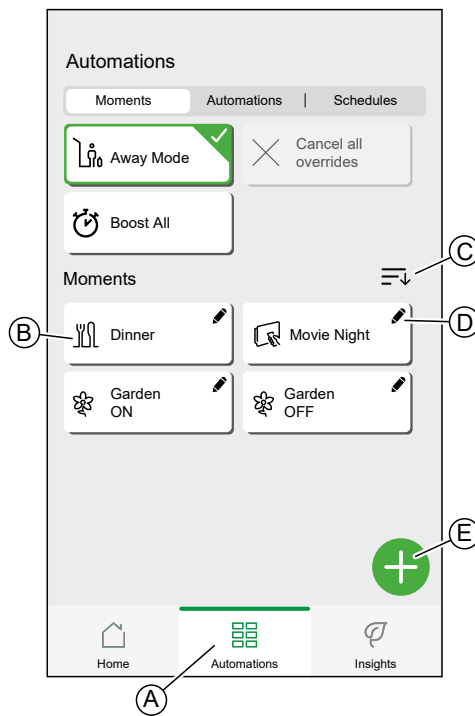

<b>A</b>	Navigate to the automations screen.
<b>B</b>	Activate a Moment.
<b>C</b>	Rearrange the order of Moments. Also affects the list on the Home Screen, page 104.
<b>D</b>	Edit a Moment.
<b>E</b>	Add a Moment

**NOTE:** A Moment will only set the status of devices. In order to put the affected devices in another status, you need to change it manually or create a reversing Moment.

If you added a Climate device to the Moment, you can reverse the change of the Climate device by tapping **Cancel all overrides**.

If a device follows a *Schedule*, page 80, the Moment of that device will only last to the next scheduled setting.

Moments can also be assigned to push-buttons of specific devices (e.g. Connected Wireless Switch). Find more information about this feature in the respective device user guide. Refer to *List of Wiser Devices*, page 10 for the links to Device user guide for each devices.

## Creating a Moment

On the **Automation** screen (A):

1. Tap  (B) icon.

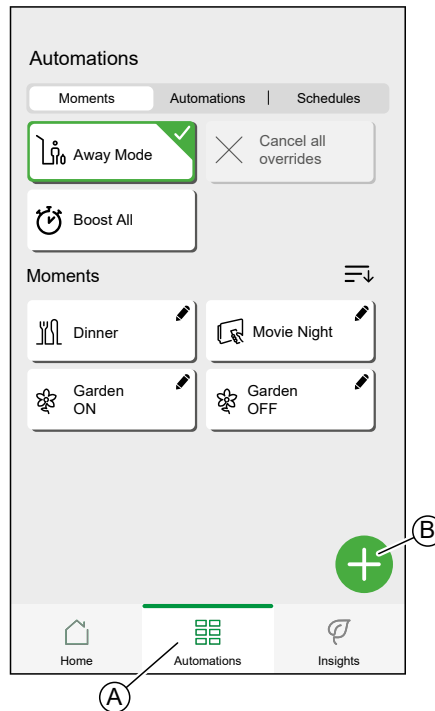

2. Select an **icon** from the list (C).
3. Enter a name for the Moment into the **text field**. (D).
4. Tap **Add actions** (E).

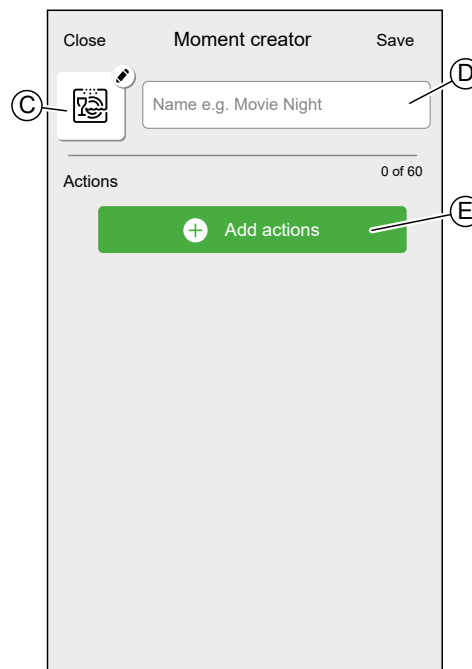

5. Tap the Device you want to add to the Moment.  
Tap a selected Device again to remove it from the Moment.  
You can add any Device in your Home. For your convenience, you can also filter the Devices by Room.  
You can add max. 60 Devices to a Moment.



6. Tap **Done** (F).

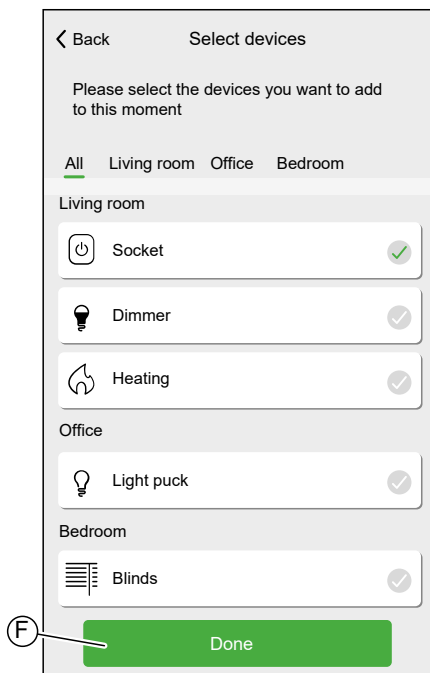

7. Tap a Device to open the **Device Control**.

Set the state you want to put the device into and tap **Set** in the upper right corner.

Repeat for all devices.

**TIP:** You can remove a Device by swiping it left and tapping the  icon.

8. Tap **Save** (G).

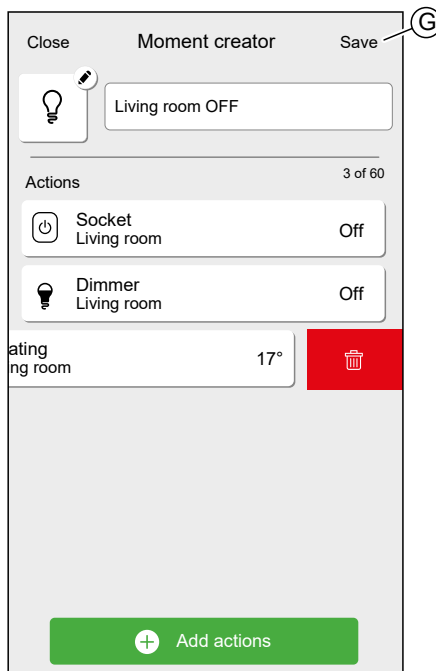

## Editing a Moment

On the **Automation** screen (A):

1. Tap  (B) icon.

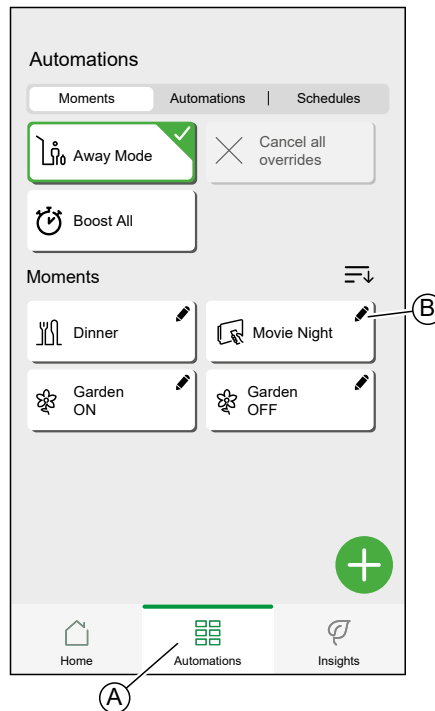

You can:

- Change the **Icon** (A).
- Change the **name** (B).
- Tap the Device to open the Device Control screen(C) and change the state of the device.
- Tap the **Add actions** (D) and more Devices to the Moment.  
Tap
- Swipe the Device left and tap the  (E) to remove a device from the Moment  
Tap **Save** to save the changes to the Moment.

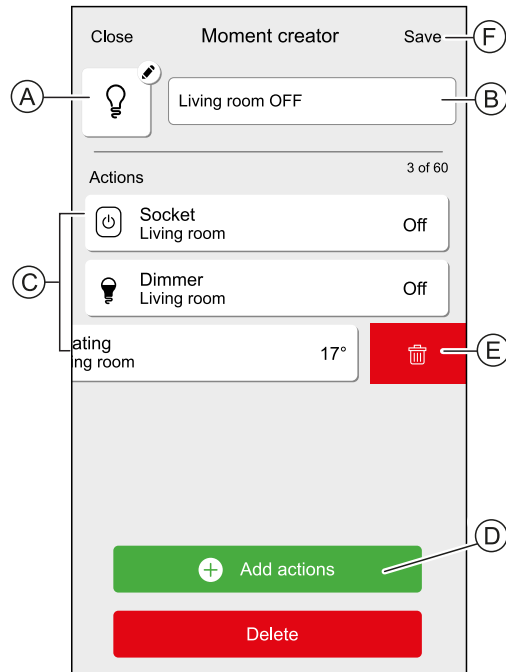

## Deleting a Moment

On the **Automation** screen (A):

1. Tap  (B).

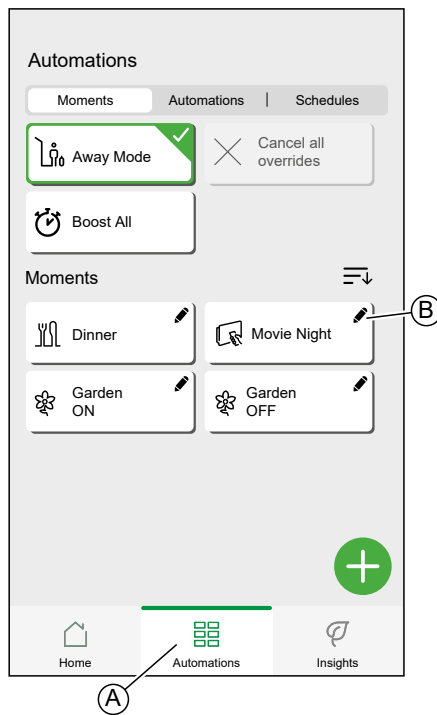

2. Tap **Delete** (C).

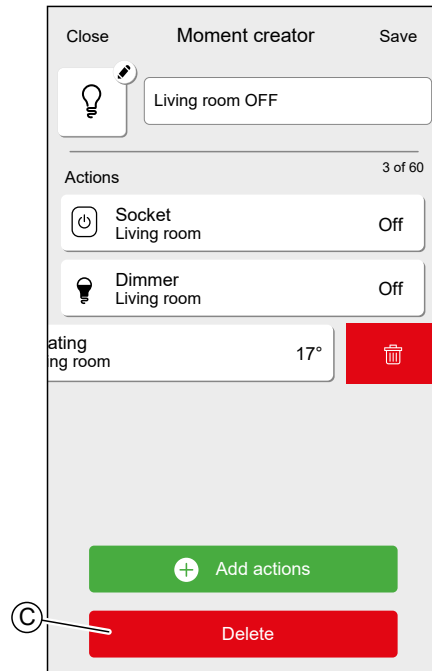
3. Confirm the deletion with **OK**.

## Automations

An automation allows you to group multiple actions that are usually done together, triggered automatically or at scheduled times. By using the Wiser app, you can create automations based on your needs.

Conditions can be:

- To change the state of a Device.
- Activate away mode.

Times can be:

- Specific time of a day (e.g. 7:30 each day).
- Period of time (e.g. from sunrise to sunset).

Actions can be:

- Change the state of a Device (e.g. open shutter 50%).
- Send a notification.
- Activate a Moment.

Limitations:

- Maximum number of Automations: 10
- Maximum number of conditions: 10
- Maximum number of actions: 10

An Automation needs at least one Action and one Condition or specific time of a day.

**NOTE:** An Automation changes the state of a Device only once, based on the conditions. If you want to reverse the state change, you will have to create another Automation. For example, if you want to switch a lamp based on motion detection, you will have to create an Automation “Presence detected – Light ON” and another one “No Presence detected – Light OFF.”

Automations are created and edited on the Automation screen (A).

You can turn an automation ON or OFF by tapping the slider (B).

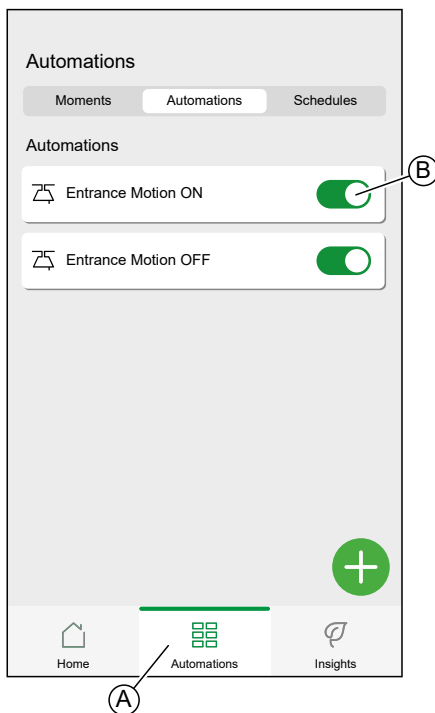

## Creating an Automation

In this chapter an example will be used to explain the necessary steps to create an automation:

Every day between sunset and sunrise, set the light in the room “Entrance” to ON and send a notification when the motion sensor detects a motion, the room is very dark and the socket called “Night Light” is OFF.

On the Automation Screen (A):

1. Tap  (B).

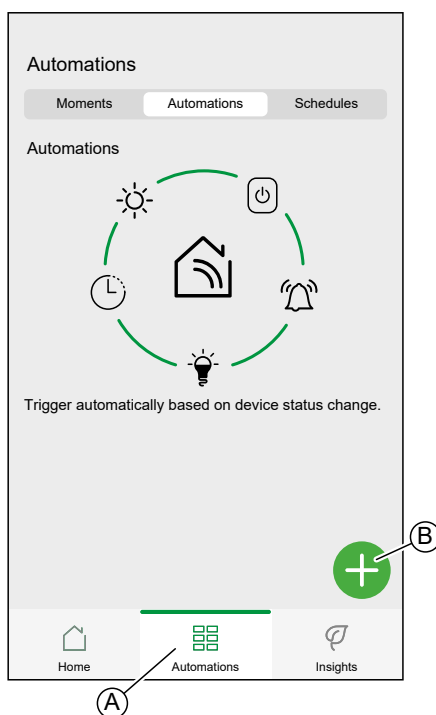

2. Select an Icon from the list (C).
3. Enter a name for the Automation into the **text field** (D).
4. Choose if the automation should trigger when ALL conditions are met or if it should trigger if ANY number of conditions are triggered  
In this example, the automation should trigger only when all conditions are met.
5. Tap **Add conditions** (E).

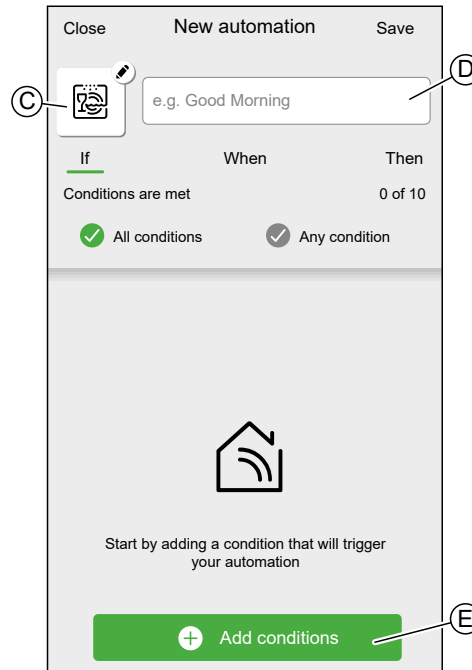

6. Choose the type of trigger to activate your automation. In this example, we want the device status change to activate the automation.

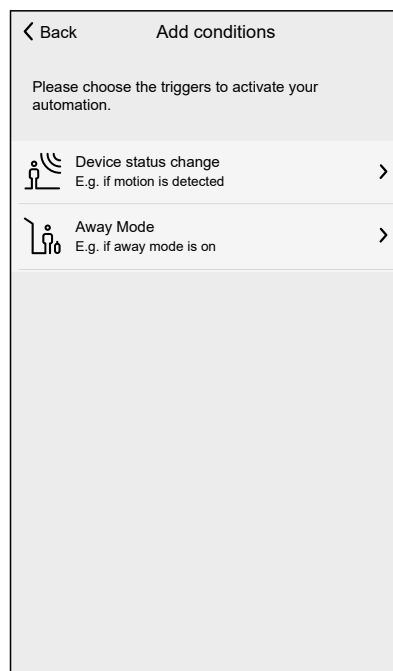

7. Select the device to open the Device Control page.

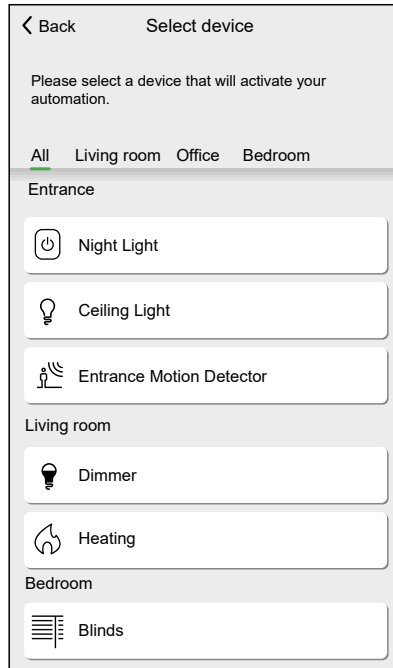

8. In the Device Control, set the state of the Device that will trigger the Automation. (e.g. Motion is detected) and tap **Set**.

**NOTE:** The available options and states are Device specific. Certain Devices offer extra options before you can set the state (e.g. for a Dimmer you will need to choose if you want ON/OFF as a condition or the brightness level). Detailed information can be found in the Device User Guide of the respective device. Refer to [List of Wiser Devices](#), page 10 for the links to device user guide for each devices.

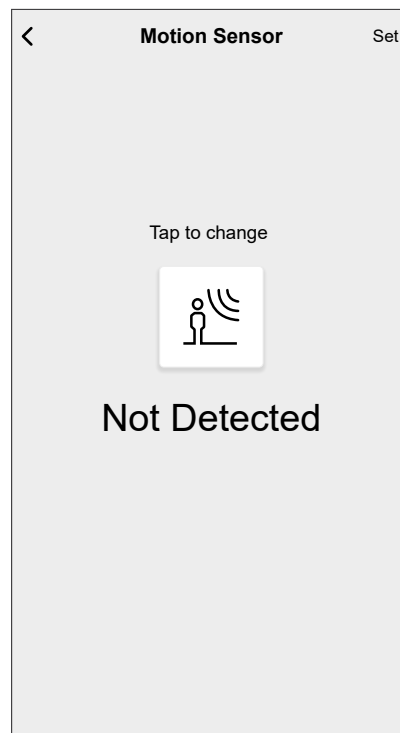

9. Keep adding conditions. Keep in mind the maximum amount of conditions that can be set.

**TIP:** If a Device offers more than one condition (e.g. Motion Sensor report motion detection and light level) you can add those as individual conditions.

**TIP:** The system will not only check for status changes, but also for the status of all condition-devices once one of them is triggered. In this example: The status of the Socket. Note that this also means that the System will check for the Motion Sensor status when you switch the Socket OFF.

10. When satisfied with the conditions, tap **When** (F).

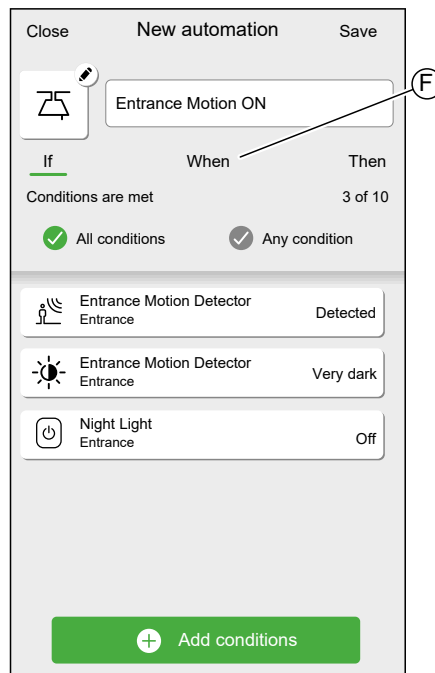

11. Tap **Add time** (G).

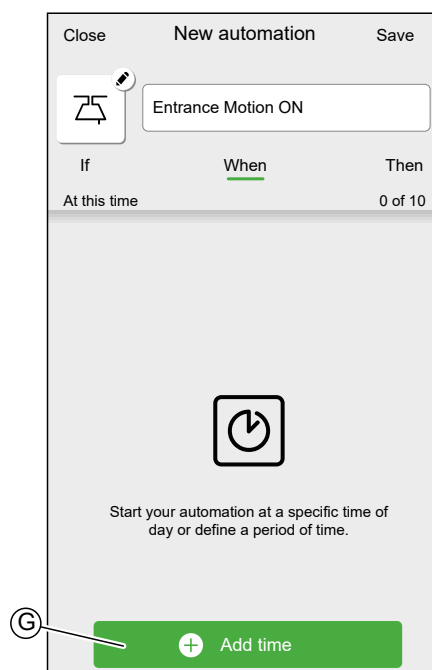



12. Choose the type of time you want to add.

**NOTE:** Specific time of day will act like a condition: The automation will trigger at that time when no conditions are set or if the conditions are met at that time of day. Periods of time will not trigger the automation by themselves, but the automation will only trigger during the set period.

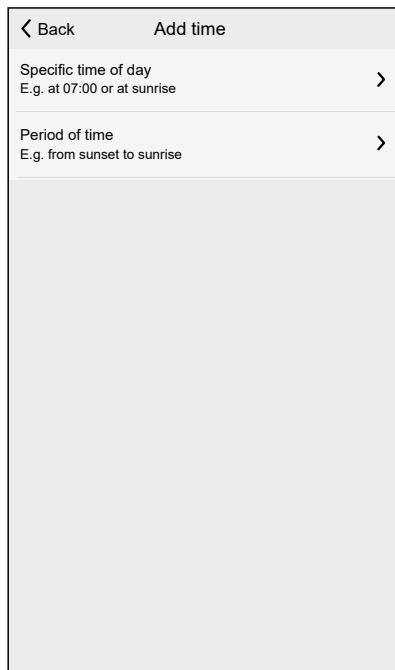

In this example: Period of time — Night time (From sunset to sunrise).

13. When satisfied with the settings, tap **Then** (H).

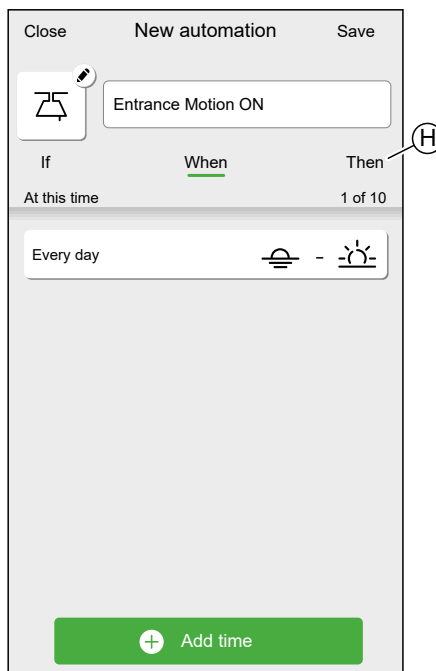

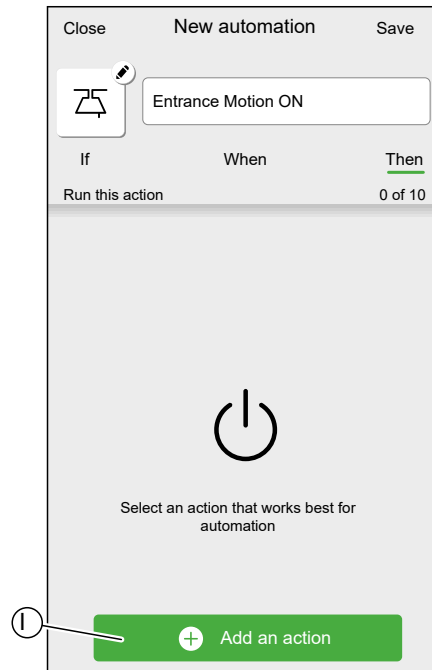
14. Tap **Add an action** (1).

## 15. Select the type of action:

- **Control a device:** Select the Device and set the desired state of the Device.
- **Send notification:** You will be notified if the condition is met.
- **Activate a moment:** Select a Moment.

In this example: **Control a device**.

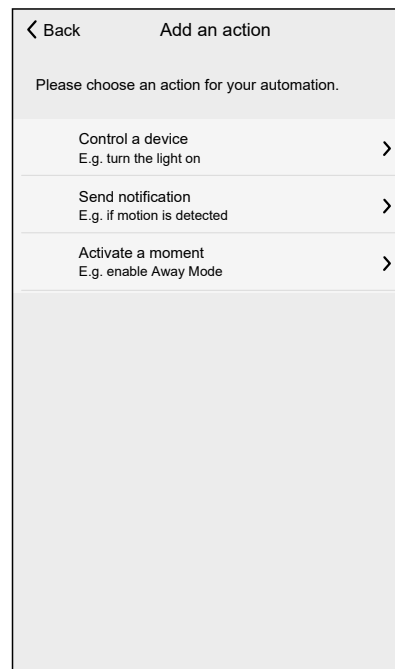

16. Select the Device that will be triggered as an action.

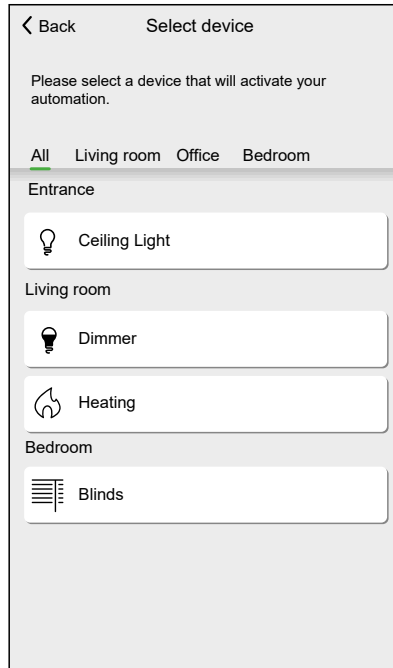

17. Set the desired state and tap **Set**.

18. Keep adding actions. Keep in mind the maximum amount of actions that can be set.

**TIP:** If you need more devices to be triggered than the action limit can provide, you can combine device state changes to a Moment and select that Moment as an action.

**NOTE:** The system will not check if a combination of actions does not make sense, e.g. switching a light ON and OFF at the same time.

19. When satisfied with the actions, tap **Save (J)**.

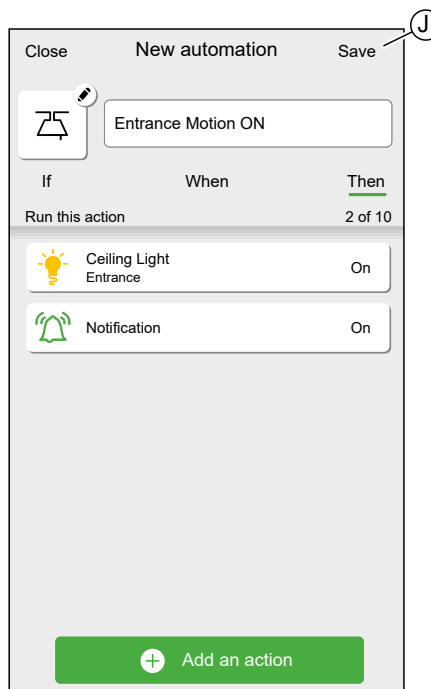

As stated in the introduction, this automation will only switch the light ON.

To switch the light OFF when no motion is detected, create another automation. In this example, it will suffice to set the condition “Not Detected” for the motion sensor and as action to switch the light OFF. Note that this will always switch the light OFF regardless of time of day, light level or status of the Socket.

**NOTE:** In this example, the time that has to pass between the motion sensor reporting motion and reporting no motion is not set in the automation. It is set in the Device Details of the motion sensor.

## Editing an Automation

On the **Automation** screen (A):

1. Tap the Automation you want to edit (B).

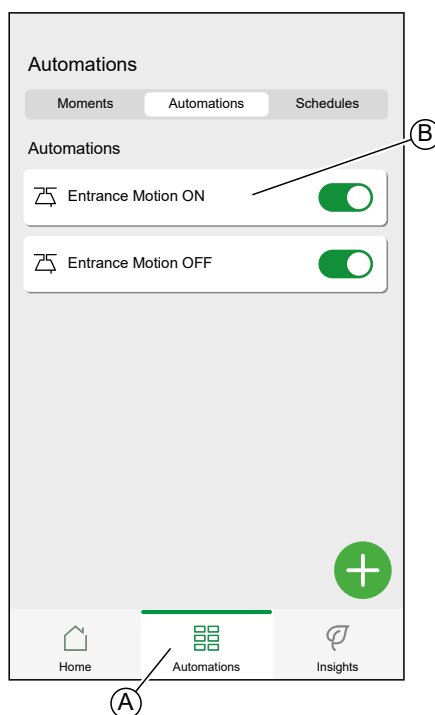

On the **Edit Automation** screen, you can:

- Change the icon.
- Rename the automation.
- Change the condition, time or action.

To change the condition, time or action of an Automation:

1. Navigate to the relevant tab (If/When/Then) and tap the condition, time or action you want to change.
2. Set the new values.

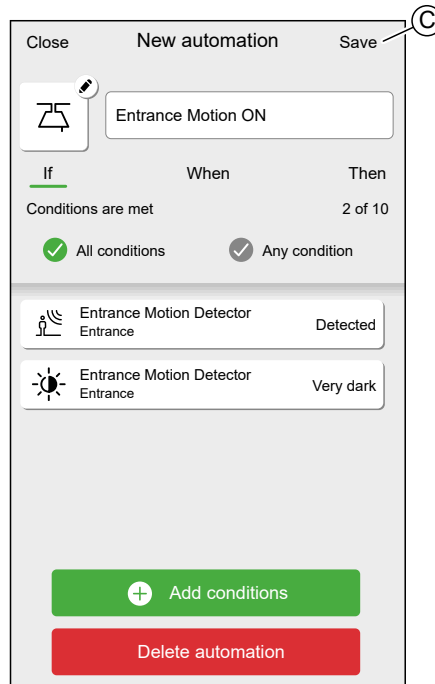
3. Tap **Save** (C).

To remove a condition, time or action:

1. Navigate to the relevant tab.
2. Swipe the relevant condition, time or action left.
3. Tap the  (A)

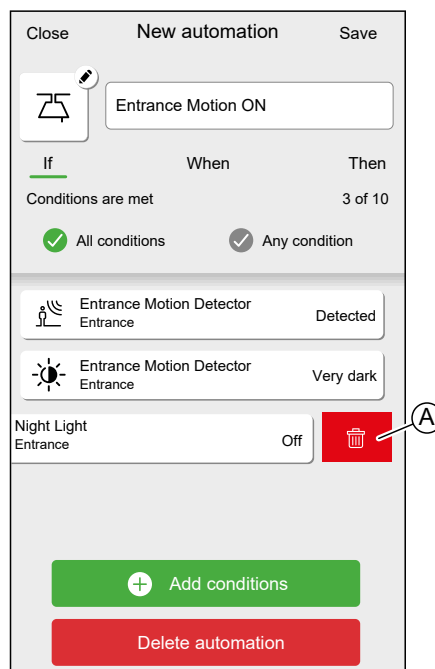

4. Tap **Save** (B).

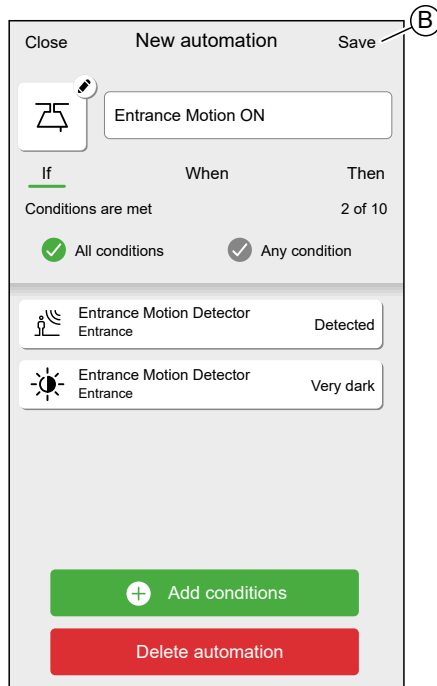

## Deleting an Automation

On the **Automation** screen (A):

1. Tap the Automation you want to delete (B).

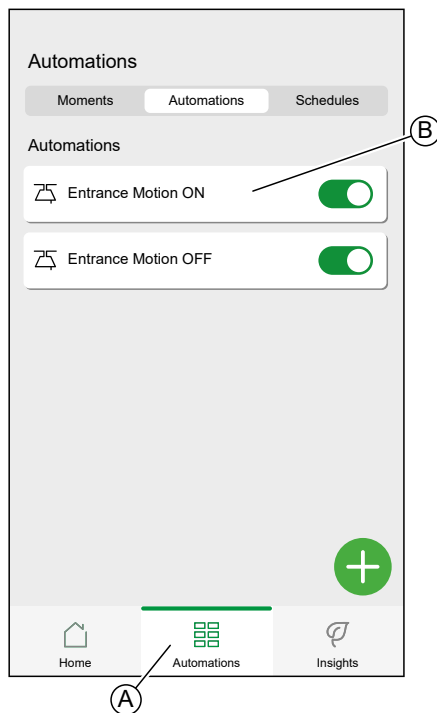

## 2. Tap **Delete automation** (C).

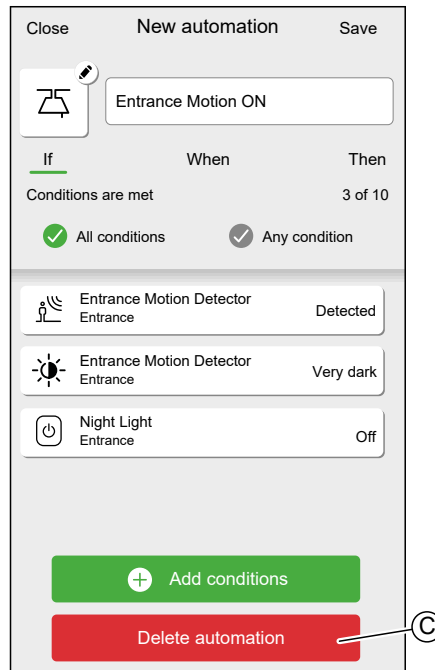

## Schedules

Set a Schedule to define the specific time for changing the state of the device.

**TIP:** The Schedule changes the device's state based on the events set at chosen time. If you need to reverse/change the state at a different time, add another schedule event.

- Example 1:  
Event 1: Set heating to 19 °C at 6:30.  
Event 2: Set heating to 15 °C at 8:30.  
Result: This action maintains the temperature at 19 °C from 6:30 to 8:30, and at 8.30, it changes to 15 °C.
- Example 2:  
Event 1: Set kitchen light to 'ON' at 19:00.  
Event 2: Set kitchen light to 'OFF' at 23:00.  
Result: This action keeps the kitchen light ON from 19:00 to 23:00, and at 23:00, the kitchen light turns OFF.

•

**NOTE:** The new action always overrides the current action. Therefore, if a new event is added to the device or manual operation occurs while a scheduled action is in progress, the system will stop the ongoing schedule.

Schedules are created and edited on the **Automation** screen (A)

Tap a Schedule to navigate to the Schedule details.



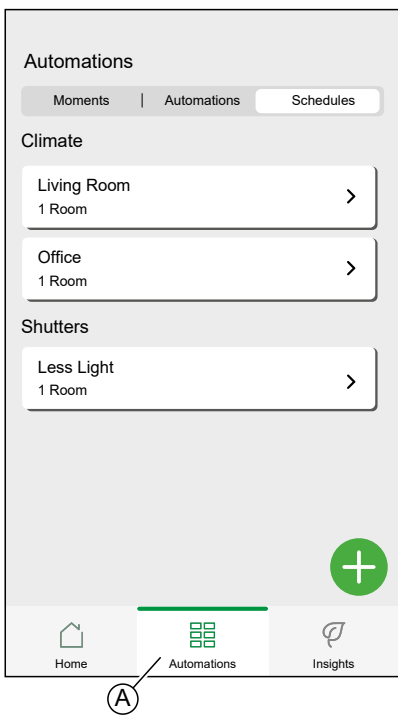

Schedule details:

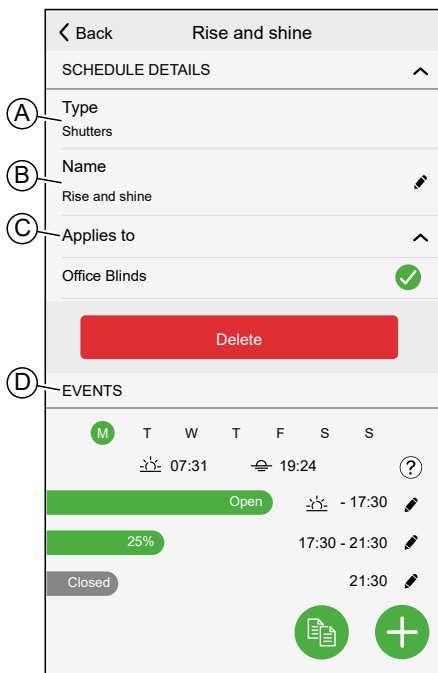

<b>A</b>	Device type A Schedule can only be set for one specific Device type.
<b>B</b>	Name of the Schedule

<b>C</b>	Devices the Schedule applies to
<b>D</b>	<p>Event list</p> <p>The events of the Schedule are listed here, sorted by day of the week.</p> <p>The bars give an overview of the status of the device during an event (e.g. full green bar when shutter fully open).</p> <p>The time of the event is shown next to the bar. An icon shows if the time is set automatically based on sunrise or sunset at the location of your Home.</p>

## Adding a Schedule

1. On the **Automation** Screen (A), tap  (B) icon.

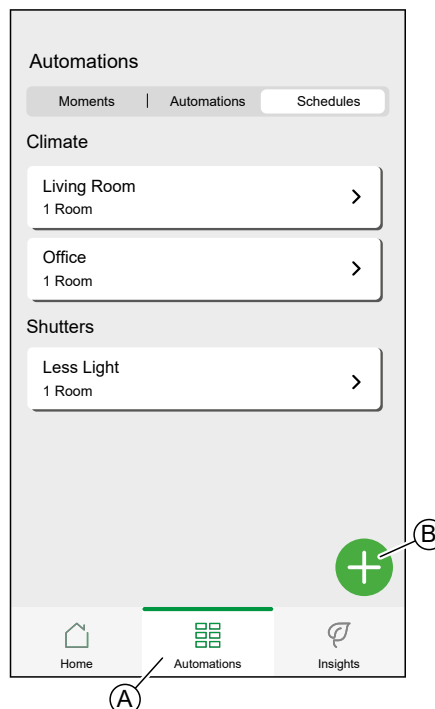

2. Enter a name in the **text field** (C).
3. Select the Device type of the Schedule

**NOTE:** A Schedule can only be created for one Device type. If you want to switch a light at the same time as closing a blind, you will need to create two Schedules.

When you assign a Climate Control device, such as a thermostat, to your room using the Wiser Home App, it will create a default schedule for you. However, you can edit the default schedule or add a new schedule for climate control in the same room. Refer to [Climate control](#), page 109 for detailed information on the climate controls.

4. Select the Devices to which the Schedule applies to.

**NOTE:** All Devices of the selected Device type are available in the list.

5. Tap **Create** (D).

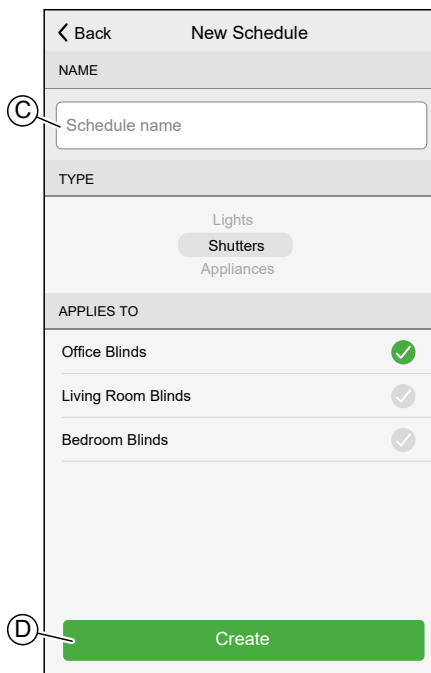

6. Tap **+** (E) icon and set the details of the event.

Find detailed information about adding events and editing Schedules in Chapter Editing a Schedule, page 84.

7. Keep adding events until the Schedule is complete.



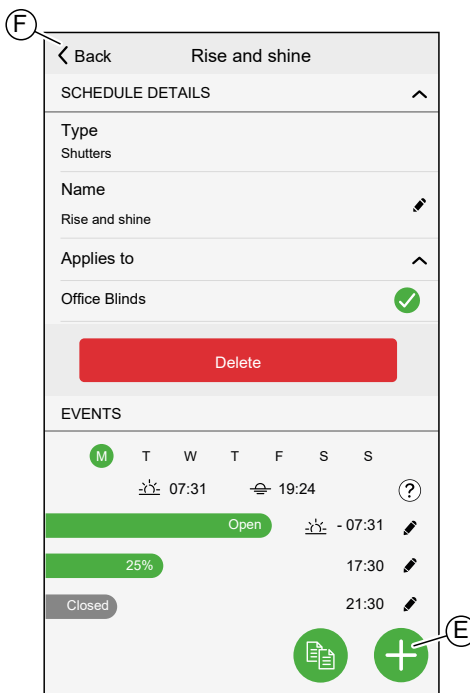

**NOTE:** Changes to the Schedule will be saved immediately.

8. When the Schedule is complete, tap **Back** (F) to save the schedule.



## Editing a Schedule

In the Schedule details screen:

- Tap  (A) icon to change the name of the Schedule.
- Select the **Devices** (B) the Schedule applies to.
- Select the **day** (C) you want to add or edit events.
- Tap  (D) icon to edit an event.
- Tap  (E) icon to add an event to the selected day.
- Tap  (F) icon to copy a day or a Schedule.

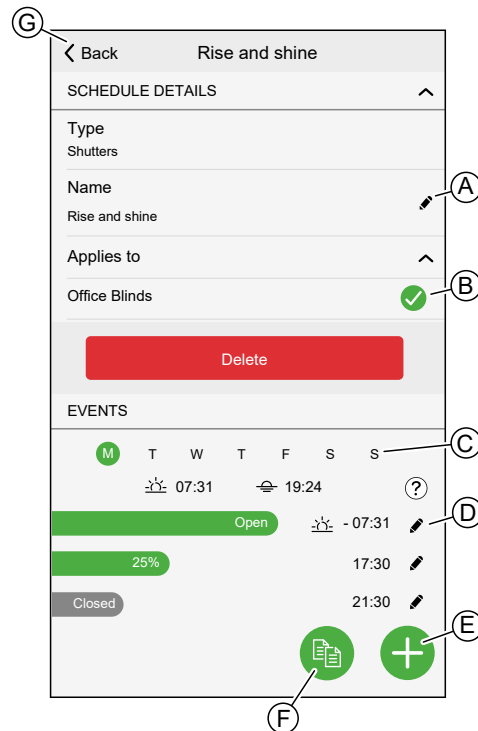

## Adding / Editing an event

- Set the desired **state** (A).  
**NOTE:** The Device state will be different for individual Device types.
- Set the **time** (B) of the event.  
**TIP:** You can also set the time of event to **sunrise** or **sunset** if the option is available for the selected device type. Wisier Home app will then set the time accordingly each day.
- To save the event settings, tap **Set**.
- To discard changes, tap **Cancel**.
- To remove an event, tap **Delete**. (Not available when adding an event.)  
**NOTE:** The available options and states are Device specific. Detailed information can be found in Device User Guide of the respective device. Refer to List of Wisier Devices, page 10 for the links to Device user guide of each devices.

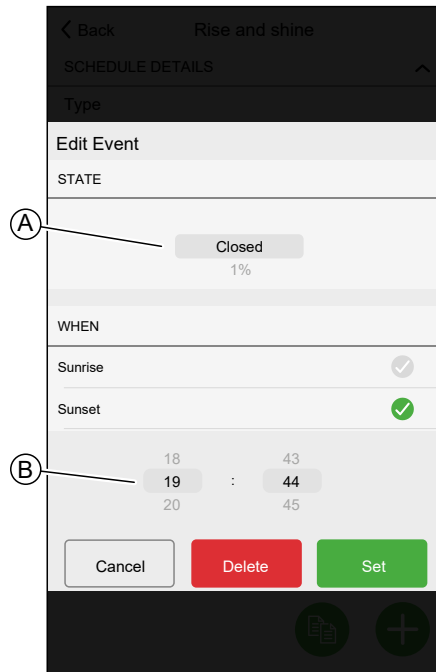

## Deleting a Schedule

On the Schedule details screen:

1. Tap **Delete** (A).

**NOTE:** The Wiser Home App automatically creates a default Schedule for Climate control devices.

If the Wiser Hub has to be reset, the Wiser Home App will again create a default Schedule for all Climate Control devices once assigned to the room.

To not follow the Schedule, remove the Device from the **Applies to** list in schedule details or disable the **Follow schedule** toggle switch in the Climate control, page 109/Device control, page 107 page.

It is recommended to not delete a default Climate Schedule.

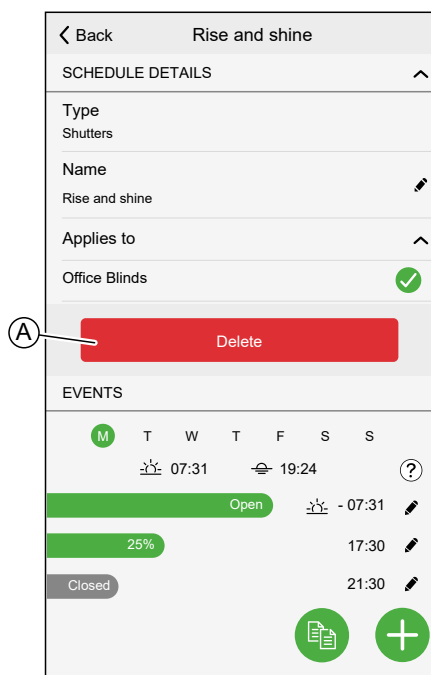

## Modes

### Away Mode

The Away Mode is designed to put your Home in a state that is sensible when you leave it for longer periods of time (e.g. being away for the weekend).

The default setting of the Away mode is to set the target temperature of all rooms in your Home to 16 °C.

You can change the target value and even add devices and their behavior to the Away Mode.

On the **Automation** Screen (A):

1. Tap **Away Mode** (B) to activate or deactivate the Away Mode.

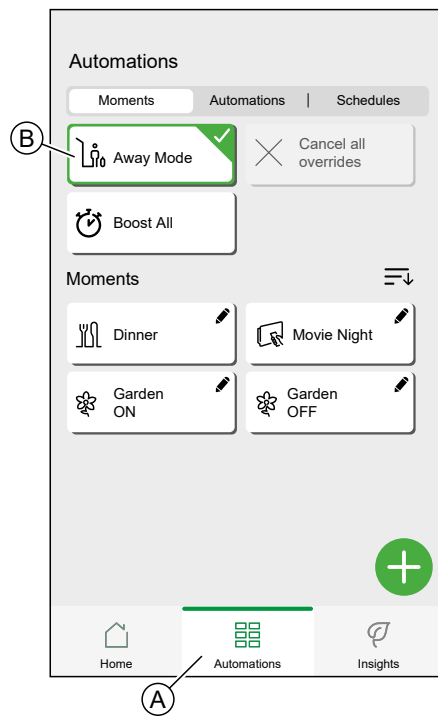

If Boost Mode, page 87 is active, Away Mode will lower the target temperature of all boosted heaters, if the Boost value is higher than the Away Mode value.

You can set the target temperature and device state in the Settings menu, page 91 -**Away Mode**.

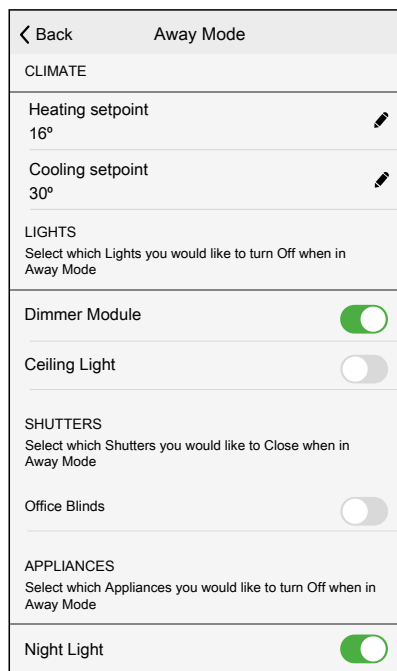

## Boost Mode

Boost Mode will apply a boost of +2 °C for one hour to every room in the system.

On the **Automation** Screen (A):

1. Tap **Boost Mode** (B).

2. To end boost mode earlier, tap **Cancel all overrides** (C).

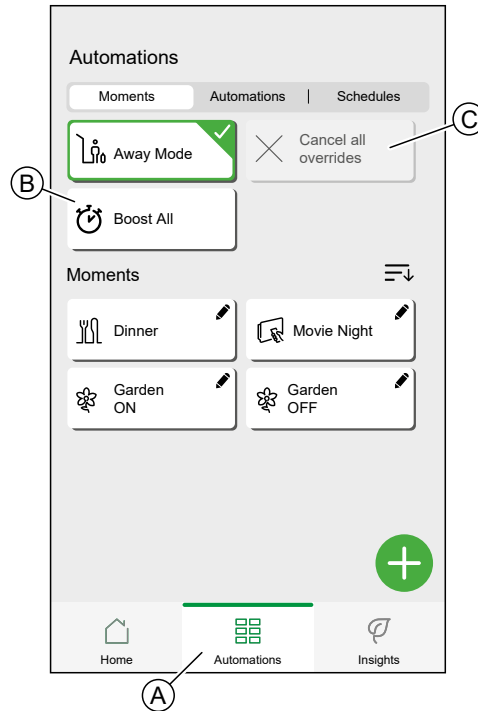

## Smart Modes

Smart Modes automatically adapt parameters of your Wiser System to increase comfort or energy savings.

Smart Modes are activated or deactivated in the **Settings, page 91** menu.

## Eco Mode

Eco Mode is a smart feature designed to maximize the efficiency of your heating system. It automatically optimizes the stop time of the heating phase, each time the set temperature changes from a higher to lower value.

**NOTE:** Eco Mode is a system feature that is either activated or deactivated for all rooms.

**NOTE:** Eco Mode feature will not activate when cooling Mode.

### Eco Mode deactivated

Wiser switches the set-point temperature at 10 pm according to the schedule. Depending on the weather and how well-insulated the home is, the room temperature drops proportionally starting at 10 pm.

The boiler keeps cycling until 10 pm.



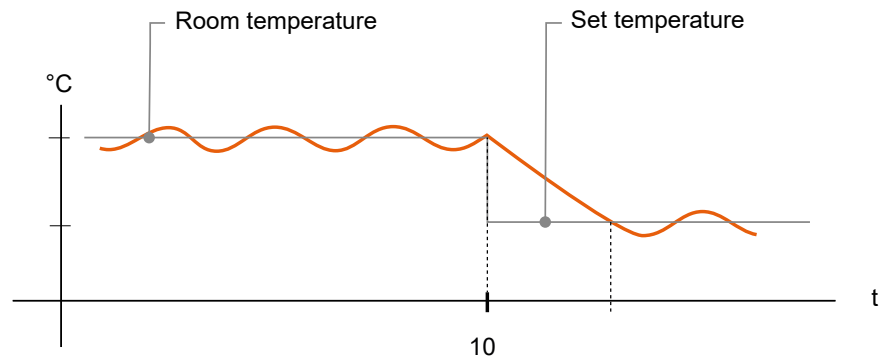

**Eco Mode activated**

When Eco Mode is activated, Wiser establishes how well your home retains heat in relation to the current and predicted outdoor temperatures. Based on this, the system switches to the next scheduled set-point temperature before 10 pm without any noticeable loss of comfort.

The period between the time that Eco Mode switches the set-point and 10 pm represents the eco period, and savings occur as a result of the boiler not being switched ON.

The boiler stops firing before 10 pm.

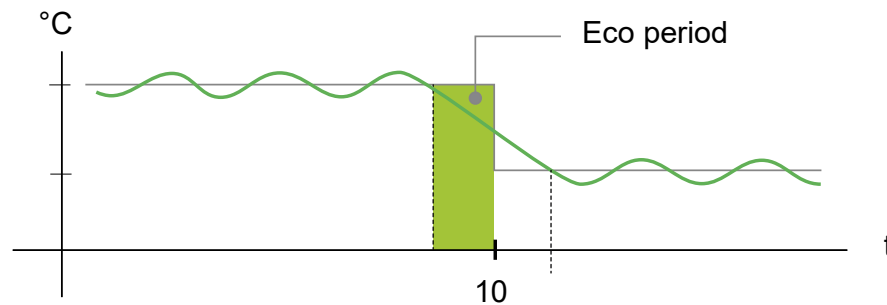

When a room is in an Eco period, an ECO icon will appear in the room on the home screen.

The ECO icon will also be visible on the temperature adjustment screen and the room thermostat.



**Comfort Mode**

Comfort Mode is a smart feature that ensures the set-point temperature is reached by the time the heating is scheduled to come ON.

It takes the guesswork out of scheduling and can save energy by optimizing the times the boiler comes on compared with a schedule, page 80 that has permanently set early start times.

**NOTE:** Comfort Mode as a feature applies to all rooms, and cannot be activated for individual rooms. If you have scheduled certain heating intervals to start requesting heat early, they will need to be re-programmed when Comfort Mode is activated.

**Comfort Mode deactivated**

When Comfort Mode is deactivated, the room starts heating at the scheduled time and it will reach the set-point temperature some time after the scheduled start time.

Boiler starts heating at 6 am, following the schedule request set for a temperature change.

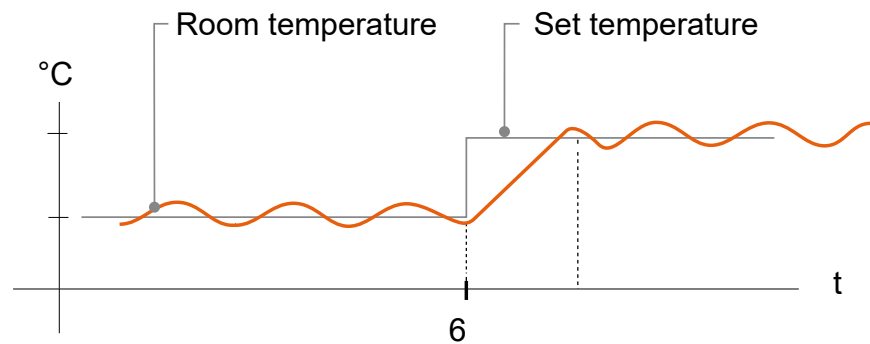

### Comfort Mode activated

With Comfort Mode activated a room will start to heat up to 3 hours ahead of a scheduled temperature change. The specific time needed to pre-heat the room is calculated by Wiser and may vary.

Boiler starts before 6 am in order to reach the requested temperature on time for the scheduled change.

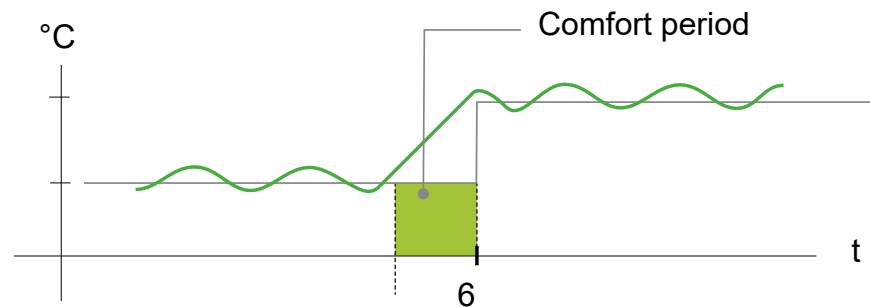

When a room is in a Comfort period, a 'C' icon with an encircling arrow will appear on the temperature adjustment screen of the app. This icon will also appear on the display of the room thermostat.

During a Comfort period, the Wiser Home App and Wiser Room Thermostat with display will display the upcoming set temperature that Wiser is controlling the heating to. For example, if the schedule calls for 16 °C overnight and then 21 °C from 6am, the Wiser Home App and room thermostat will display the encircled 'C' and 21 °C as the set temperature during the Comfort period.



## Summer Comfort Mode

If you have an shutter control devices installed at your home, Summer Comfort Mode feature will be available.

The Summer Comfort Mode automatically adjusts the shutters to a specific position when temperature is too hot both indoor and outdoor. This solution passively cools your home by lowering your shutters.

**Features:**

- The inside temperature is measured by sensor and the outside temperature is measured based on your location.
- Works only when the sun is out (during daytime).
- By default the blinds closes to 50%
- This feature is active only when there is minimum of 2 degrees difference between inside and outside temperature. For example: Inside temperature a minimum of 26 degrees, while the outside temperature a minimum of 28 degrees.

Find the details of setting-up the Summer Comfort Mode in the Device User Guide of the respective device. Refer to [List of Wiser Devices](#), page 10 for the links to Device user guide for each devices.

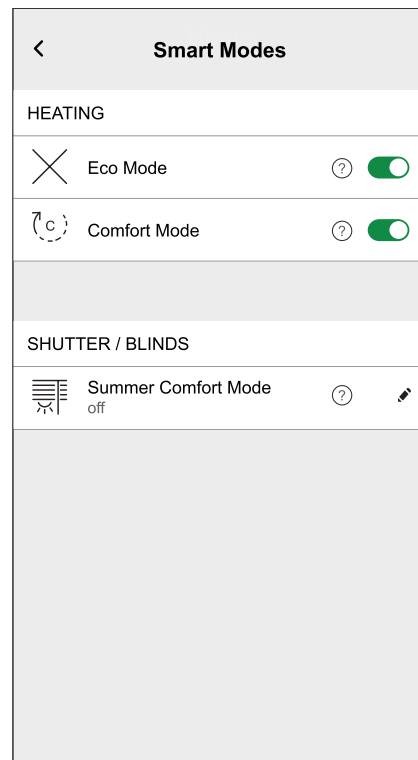

## App Settings

Overview of the options available in the settings menu.

The settings menu contains various settings for parts of the Wiser Home System.

Rooms, page 58 and Devices, page 51 are managed from the settings menu.

On the Home Screen, page 104:

1. Tap **Settings** (A).

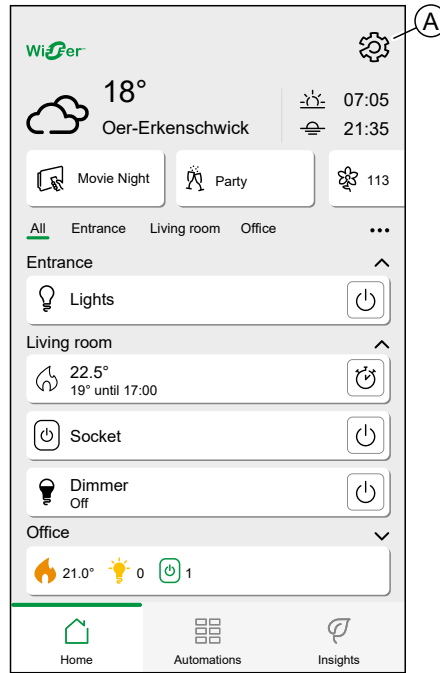

The settings menu:

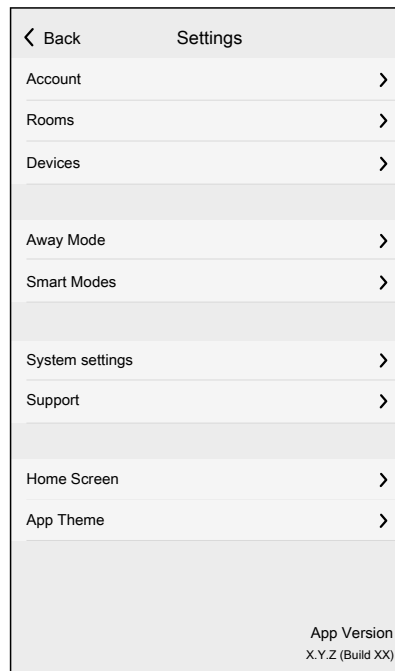

<b>Account</b>	Change the details of your account, like password, notification settings, home address, etc. <b>NOTE:</b> You can also find the notification settings (e.g. Battery low) here.
<b>Rooms</b>	List of all Rooms of your Home. Access to Room options.
<b>Devices</b>	List of all Devices of you Home. Access to Device options.
<b>Away Mode</b>	Specify what happens when you activate the Away Mode, like temperature setting and which devices should be switched off. Refer to <i>Away Mode</i> , page 86 for detailed information.
<b>Smart Modes</b>	Activate or deactivate the Smart Modes, like ECO Mode.

<b>System Settings</b>	More detailed Wiser Home App information. Set your time zone here.
<b>Support</b>	Provides you the general assistance such as the link to the FAQ section of se.com, access detailed guide, report errors, and provides contact information for customer support. Refer to <a href="#">Support</a> , page 93 for the detailed information.
<b>Home Screen</b>	Customize the appearance of the Home Screen.
<b>App Theme</b>	Personalize the appearance of Wiser home app to light mode or dark mode. Refer to <a href="#">App Theme</a> , page 94.

## Support

The Support page provides you with the essential resources and assistance options. From finding solutions to reporting errors, it's your go-to place for resolving issues and getting help.

1. On the App Settings, page 91, click on **Support**.
2. Support menu:

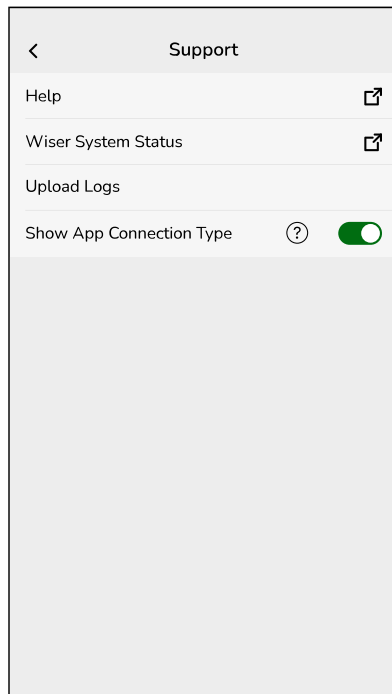

<b>Help</b>	Provides general assistance to users. Tap on the option to open the link to the FAQ section of se.com and contact information for customer support. Users can access this section to find solutions to common issues or seek guidance on how to use specific features within the app.
<b>Wiser System Status</b>	Tap to check the current status of the Wiser system.

<b>Upload Logs</b>	This option allows you to upload log files if you have identified any issues in the app. When you tap on the option, a popup will appear, allowing you to describe the issue. Click <b>OK</b> to generate an ID number for this problem, and then contact the Schneider support team for further assistance.
<b>Show App Connection Type</b>	This option displays information about the type of connection the app is using. It indicates whether the app is connected via local internet (when the phone and Hub are on the same Wi-Fi®) or via the cloud (when the phone uses mobile data or is connected to a different Wi-Fi® than the Hub). If this function is enabled, you can view the connection status directly from the app's Homescreen.

## App Theme

Wiser Home app is available with different color schemes. By default, the app automatically matches your device's overall theme for a seamless look. You can also personalize the app experience by selecting your preferred appearance to light mode or dark mode.

1. On the App Settings, page 91, click on **App Theme**.
2. App Theme:

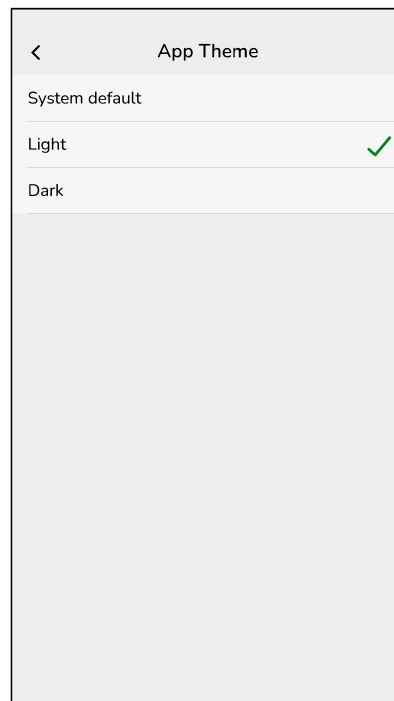

## Account settings

In the account menu you can manage your address, customize notifications and alarms, manage privacy, connect third-party apps, update your password, and even delete your account when needed.

In the Settings menu, page 91:

1. Tap **Account (A)**.

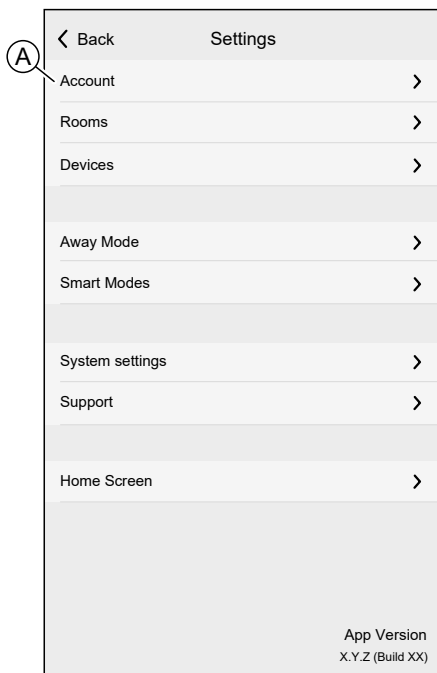

The Account menu:

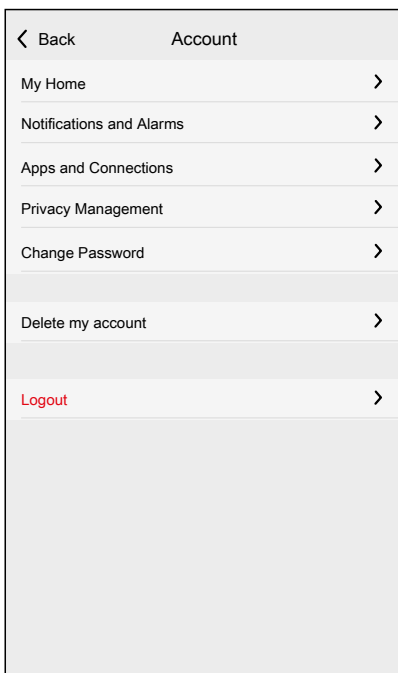

<b>My Home</b>	Set the details of your home.
<b>Notifications and Alarms</b>	Set which Notifications and Alarms, page 96 you want to receive.
<b>Apps and Connections</b>	If you have an Wiser Energy account, you can link it here. You can also create an account here.  Links to the places where you can get the necessary add-ons for Alexa or Google Home. <b>NOTE:</b> This will open your default browser on your device.
<b>Privacy Management</b>	Activate or deactivate the option to receive marketing emails, contribute to data analysis for service improvement, and share energy insights data to enhance our eliq service.

	Provide details about the terms of use and privacy notice.
<b>Change Password</b>	<p>You can change your password here.</p> <p><b>NOTE:</b> You can find the requirements of the Wiser Home password in chapter <i>Setting an Account</i>, page 41</p> <p><b>TIP:</b> Please consider the tips about passwords and other methods to harden your system in chapter <i>Cybersecurity Principles</i>, page 26</p>
<b>Logout</b>	<p>Log out of your Account</p> <p><b>NOTE:</b> In order to use the Wiser Home app, you need to be logged in with an Account.</p>
<b>Delete my account</b>	<p>Delete your Account.</p> <p>Deleting your account is immediate and permanent.</p> <p>You need to be logged in to your Wiser Hub to be able to delete your account.</p> <p><b>NOTE:</b> Deleting your Account will flag your E-Mail Address as deleted. You will not be able to create another Wiser Account with the same E-Mail address.</p> <p><b>NOTE:</b> A deleted account cannot be restored.</p> <p><b>NOTE:</b> Deleting your Account will log you out of your Wiser System and you will not be able to log in again. Make sure to decommission your Wiser System first.</p> <p><b>NOTE:</b> If you have enabled Personalized Energy Insights feature for your energy device, deleting your account will cancel the subscription from the Personalized Energy Insights notifications.</p> <p><b>TIP:</b> Instead of deleting your account if you need to leave a Wiser System behind (e.g. moving out), reset the Hub and keep your credentials ready for the next Wiser System.</p>

## Notifications and Alarms

Notifications and Alarms allows the wiser home app to send messages that show up in the notifications of your mobile device's operating system and also you can set an alarm for overconsumption and no consumption of the specific device.

You can select the Notifications and Alarms in the Account options of the Settings menu.

**NOTE:** Notifications and Alarms settings are saved for an account in the Wiser cloud. Changes to one mobile device affect all mobile devices using the same account.

1. Tap **Notifications and Alarms (A)**.



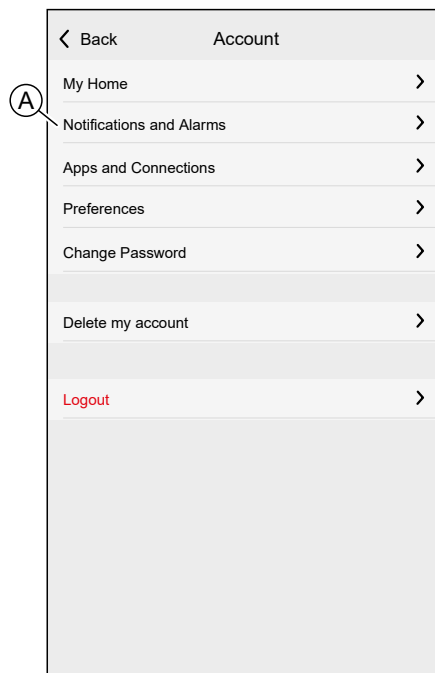

Notification and Alarm settings:

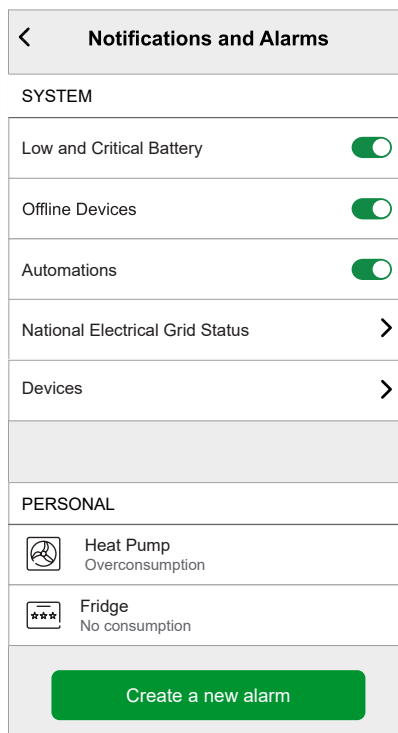

SYSTEM	
<b>Low and Critical Battery</b>	Will notify you when the battery of a Device is low.
<b>Offline Devices</b>	Will notify you when the hub lost connection to a Device.
<b>Automations</b>	Will notify you when an automation has been triggered.
<b>Devices</b>	Certain Devices can send notifications on their own. You can select the devices that are allowed to send notifications. <b>TIP:</b> You can also enable or disable notifications of a device in the device options.

<b>SYSTEM</b>	
<b>PERSONAL</b>	
<b>Overconsumption</b>	The app will trigger an alarm when the device's usage exceeds the set limit, helping you to manage and reduce overconsumption effectively. Refer to <i>Setting-up Overconsumption Alarm</i> , page 98 for information on how to set the overconsumption alarm.
<b>No Consumption</b>	The app will trigger an alarm when the device consumes 0 watts for a set period of time. Refer to <i>Setting-up No Consumption Alarm</i> , page 100 for information on how to set the no consumption alarm.

## Setting-up Overconsumption Alarm

This topic explains how to setup an overconsumption alarm for a device.

1. On the Notifications and Alarms, page 96 screen, tap **Create a new alarm** (A).

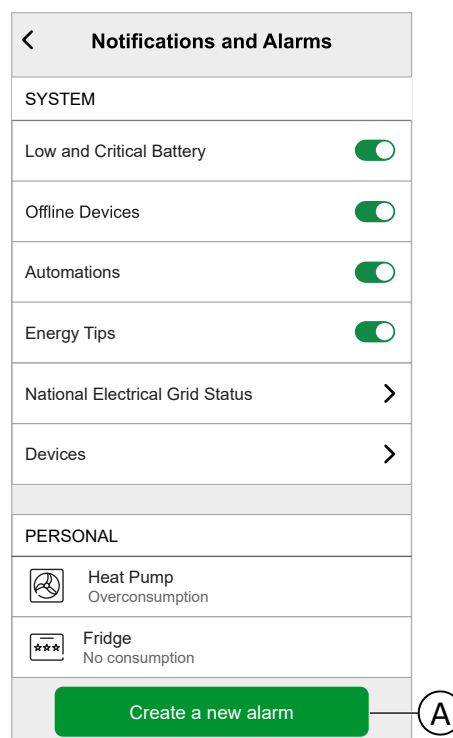

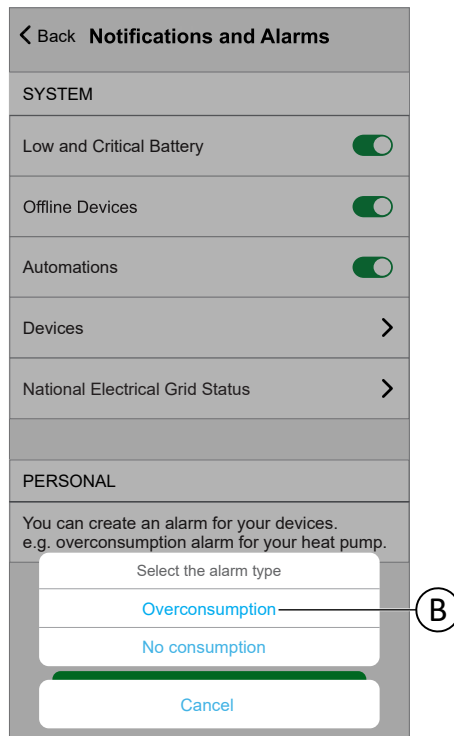

2. Choose alarm type as **Overconsumption** (B).

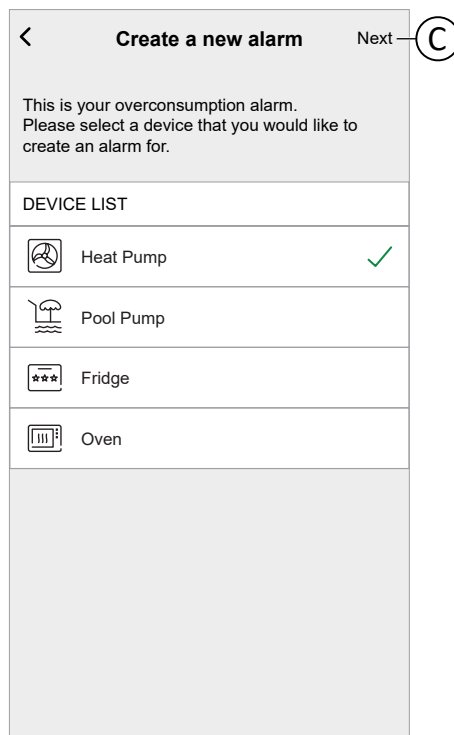

3. Select the device from the device list and tap **Next** (C).



4. Tap  icon (D) and set the power consumption limit that you consider normal for the selected device during its normal operation.
5. Tap  icon (E) and set the duration for which the device should be operating above the set power consumption limit before triggering an alarm.

6. Once you have entered the desired values for both the maximum power consumption and the duration, tap the **Save** (F).

← Back **Create a new alarm**

Your Heat Pump permanent consumption alarm.

Enable alarm

**When are you alerted?**  
If your Heat Pump has been permanently working for longer than it should.

**Consumes at least**

**Watts**  
1500  (D)

**During**  
12 hours  (E)

Save (F)

7. To delete an alarm, select the device and tap **Delete** (G).

← Back **Heat Pump**

Your Heat Pump permanent consumption alarm.

Enable alarm

**When are you alerted?**  
If your Heat Pump has been permanently working for longer than it should.

**Consumes at least**

**Watts**  
1500 

**During**  
12 hours 

Save

Delete (G)

## Setting-up No Consumption Alarm

This topic explains how to setup a No Consumption alarm for a device.

1. On the Notifications and Alarms, page 96 screen, tap **Create a new alarm** (A).

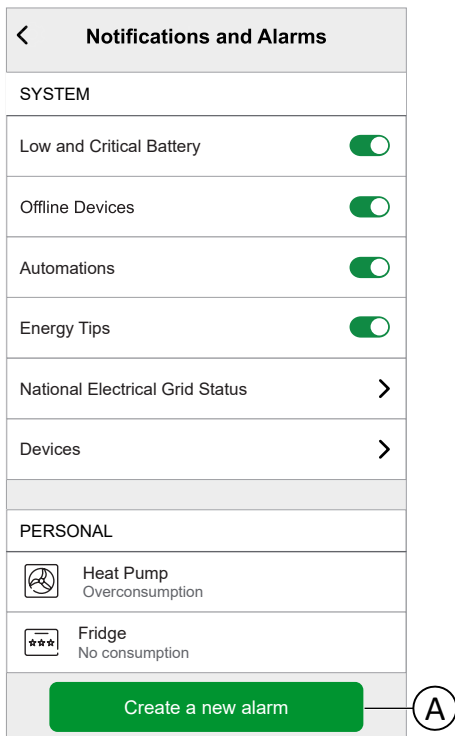

2. Choose alarm type as **No consumption** (B).

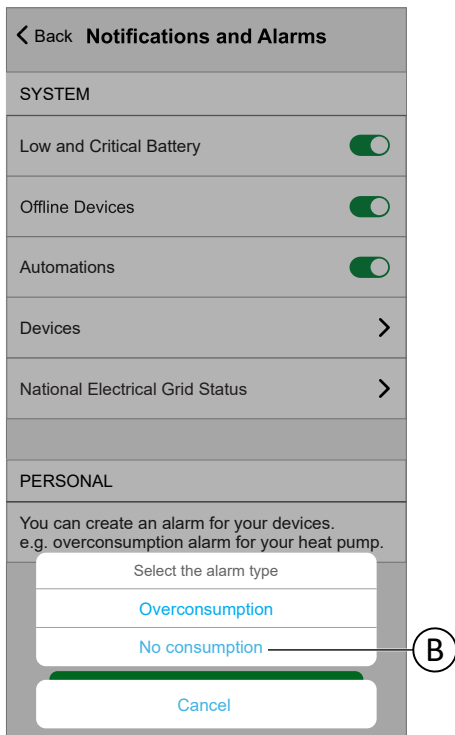

3. Select the device from the device list and tap **Next** (C).

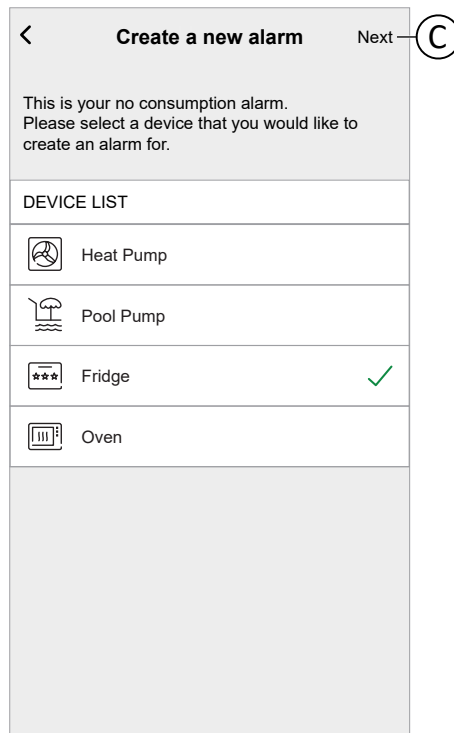

4. Tap  icon (D) and set the duration for which the device should remain at 0 Watts before triggering the alarm.
5. Once you have entered the desired values for both the maximum power consumption and the duration, tap the **Save** (E).

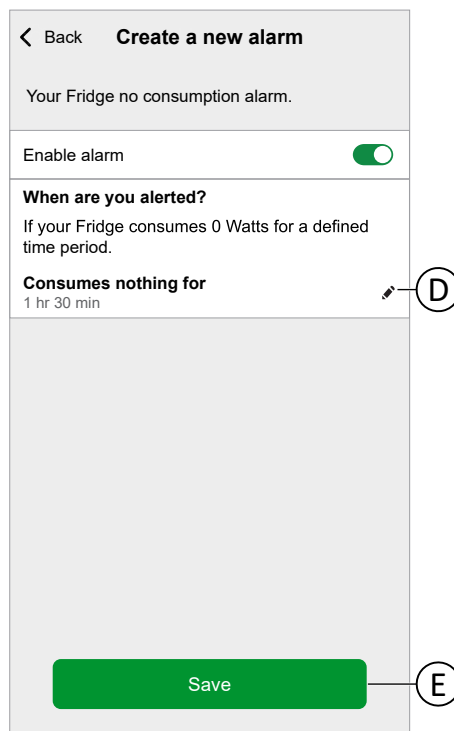

6. To delete an alarm, select the device and tap **Delete** (F).

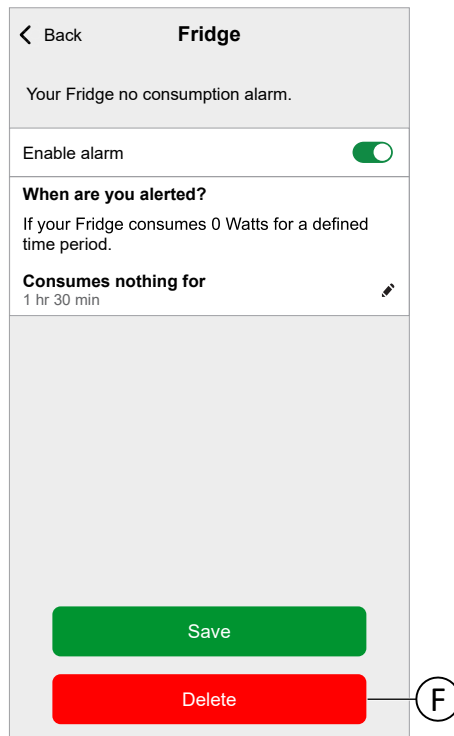

## App Language

To change the language of the app, go to your smartphone's settings and look for the option to set the language. If you're not sure how to find it, check the manual or guide of your smartphone's operating system for help.

# Controlling the Wiser System

## Home Screen

The Home Screen provides an overview of all the Devices of your home.

On the Home Screen you can view the status of Devices, as well as control Devices quickly. The Home Screen informs you about the local weather and much more. You can also activate your favorite moments:

Overview of the elements on the Home Screen:

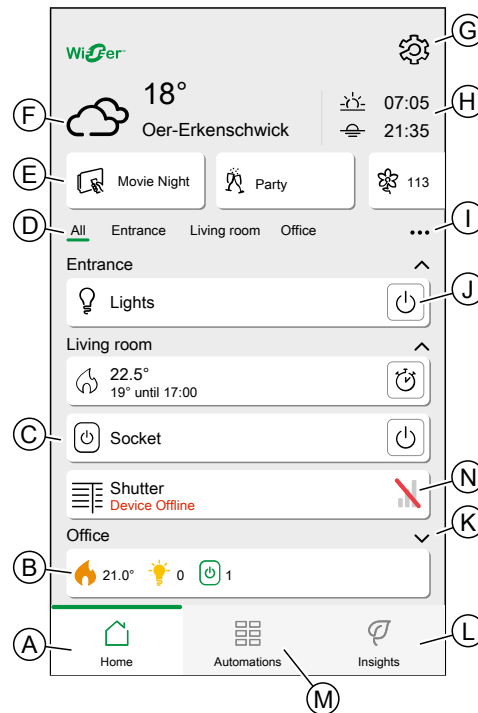

A	<b>Home screen</b>	Tap to show the Home Screen
B	<b>Room Quick Info</b>	Compact display of information about the devices in a Room. Tap to expand/collapse the Room Device list.
C	<b>Devices in a Room</b>	Tap a Device to open the Device Control.
D	<b>Room List</b>	Drag to scroll through the list. Tap to navigate to Room.
E	<b>Moments</b>	Tap to activate a Moment.
F	Local weather	Displays weather, temperature and location.
G	<b>Settings</b>	Tap to navigate to the settings screen.
H	Time of sunrise and sunset.	Displays time of sunrise and sunset.
I	Room order	Tap to rearrange the Room list.
J	Quick Access	Tap to control the Device without having to navigate to the Device Control  Available function depends on Device type.
K	Room details	Tap to expand / collapse a Room.
L	<b>Insights</b>	Tap to navigate to the Insights screen, where you can find detailed information about your Wiser System.  <b>NOTE:</b> When you added an Energy device, like PowerTag E, tapping will open the <b>Energy</b> information. Please read the relevant Device User Guide of the device for more information. Refer to <a href="#">List of Wiser</a>

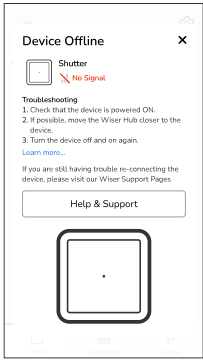

		Devices, page 10 for the links to Device user guide for each devices.
<b>M</b>	<b>Automation</b>	Tap to navigate to the Automation screen, where you can set up Moments, Schedules and more.
<b>N</b>	<b>Device Offline</b>	<p>The device is offline.</p> <p>Tap on the device to open the popup with troubleshooting steps. Tap <b>Learn more</b> to know more about the zigbee signal strength and tap <b>Help &amp; Support</b> if you require further assistance and visit our Wiser Support Pages.</p> 

## Rearranging Rooms

You can change the order of the Rooms displayed.

1. Tap the **...** icon (A)
2. Tap **Room order** (B)

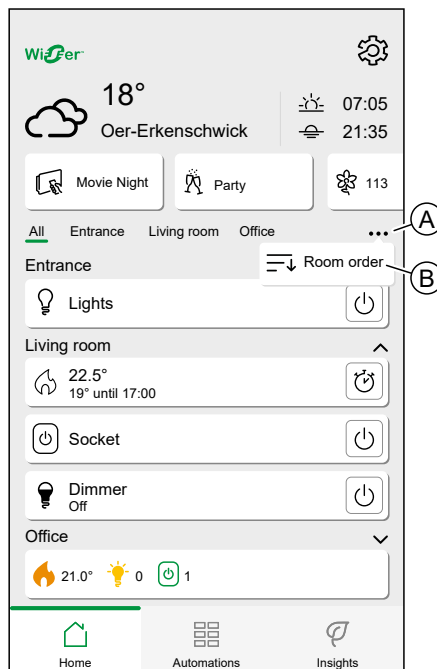

3. Rearrange the Rooms by long pressing the room, then dragging and dropping the room in the desired location.

#### 4. Tap **Done** (C).

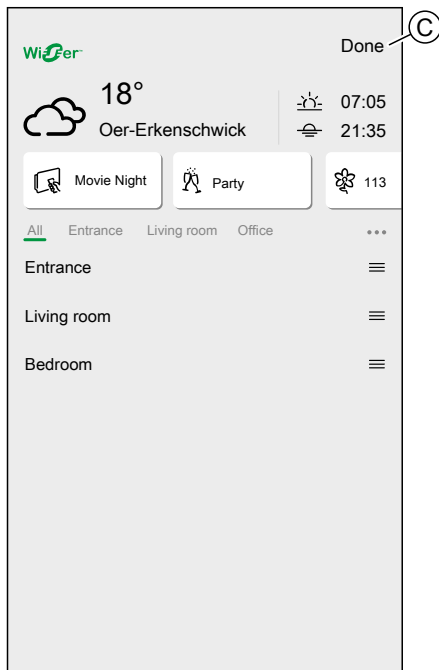

## Home Screen Settings

The Wiser Home App offers options to customize the Home Screen.

Find the Home Screen options in the Settings Menu, page 91.

Available options:

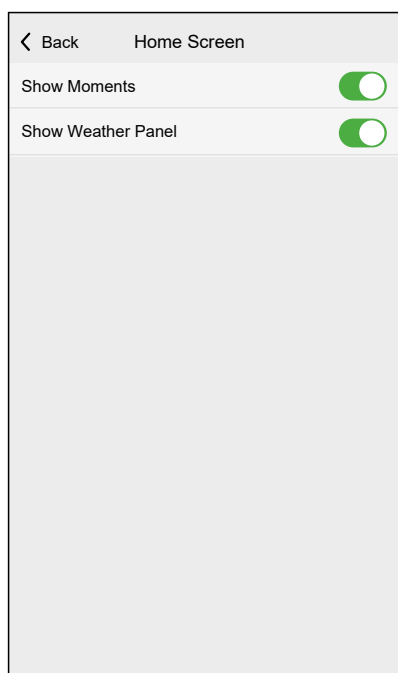

Setting	ON	OFF
<b>Moments</b>	The List of available Moments is shown in the upper part of the Home Screen.	Moments will not be shown on the Home Screen
<b>Weather Panel</b>	Weather information is shown at the top of the Home Screen.	Weather information will not be shown on the Home Screen.

## Device control

Control your Devices directly.

You can control a Device in your Home directly on the Home screen or with the Device Control page.

When you assigned the Device to a Room, you can find the Device in the Room on the Home Screen, page 104.

**NOTE:** Climate devices, like Radiator Thermostats, will be controlled like any other Device, but need to be set up properly.

Detailed information about setting up Climate devices can be found in chapter Climate control, page 109.

## Home Screen Control

1. In the List of Rooms, page 58, tap the **icon (A)** of the device you want to control.

**NOTE:** The displayed function differs for all Devices. The displayed function is the one most commonly used for the Device. Detailed functions (e.g. raising a blind to a specific value) can be found in the Device Controls page.

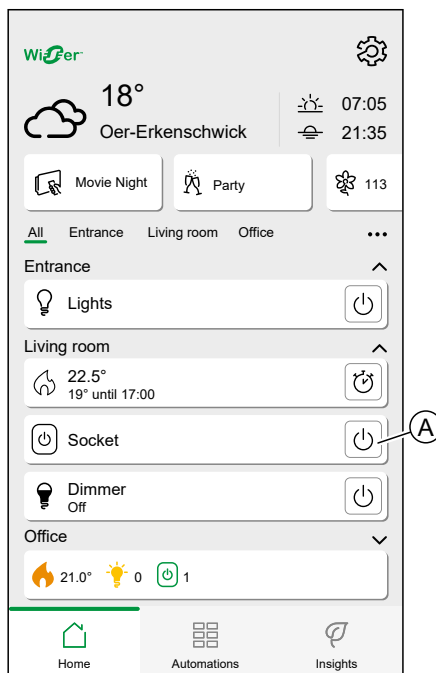

# Device Control Page

1. In the Home Screen, page 104, tap the **Device (A)** you want to control.

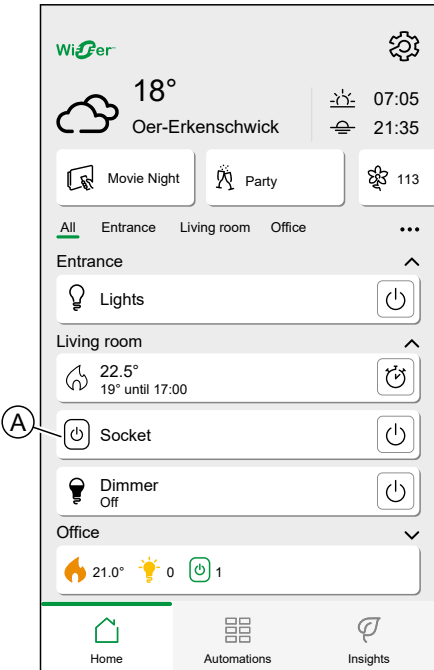

2. Set the desired state/value for the Device.

**NOTE:** The displayed function differs for all Devices.

You can find further Device specific options at the bottom of the screen, like navigating to the Device settings or if the Device should follow a Schedule.

Device Control page:

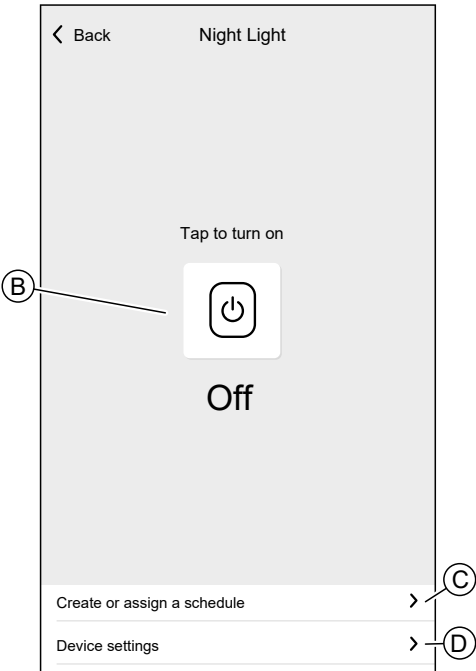

<b>B</b>	Device options and status display.  The icon and text show the status of the Device. The controls differ for each device type (e.g. a Blind Control Device will offer a slider and separate <b>open</b> and <b>close</b> buttons.)
<b>C</b>	Create a Schedule, page 80 or assign the device to an existing schedule.  When the Device is assigned to a schedule, you will find the options to enable/disable the <b>Follow Schedule</b> toggle switch and edit the schedule.
<b>D</b>	See and edit the Device Details, page 57.

## Climate control

Climate control involves managing the behavior of climate devices within the Wiser system. To create a climate control, climate devices must be assigned to a room.

## System-Level Climate Control

- If a Single Wiser Heat system, like UFH, supports a centralized water-based heat source (a boiler or heat pump), then that single source can either be heating or cooling, but not both.
- Rooms that are sourced from the single heat source and not capable of cooling (e.g., radiator-based rooms), will not operate during the cooling period. For example, when the system is in cooling mode in a non-cooling room:
  - The Radiator Thermostat shall not perform a Boost and shall display the same status as in Device Lock mode.
  - The Room thermostat shall wake up using any of the 3 keys (+, -, O), but subsequent button presses will not change the set point.
- Domestic Hot Water is generally out of scope of cooling. This means that during Cooling mode, any Hot Water control will operate as normal (this may be sourced by an alternate supply e.g. electrical)
- Rooms that are not sourced centrally from the heat source (e.g. electrical heating rooms) will continue to operate normally in the Heating mode when the cooling mode is ON.
- Where there are multiple UFH devices each containing a Heat/Cool switch input, only one of these needs to indicate cooling for the entire system to be put into cooling mode

**NOTE:** Refer to the dedicated device user guide for more detailed information on the climate control features of a specific device. [List of Wiser Devices](#), page 10 provides the links to Device user guide for each devices.

## Room-Level Climate Control

When a Climate Device is assigned to a Room, a single **Climate** is created which includes all the climate devices assigned to that room.



The Climate Control looks and acts like a Device Control. You can control the Climate Control directly from the Home Screen and assign it to Moments or Schedules.

- All Climate Devices assigned to a Room will be combined as one Climate Control.
- The Climate Control cannot be named unlike other devices, but will take the name of the Room.
- Individual Climate Devices can not be assigned to a Schedule or Moment. Instead, the Climate Control will show up in the relevant lists.

- Operating a single device of the Climate Control manually (e.g. one of three Radiator Thermostats) will send the command to the Climate Control, affecting all assigned Devices. (All three Radiator Thermostats will open/close based on the command).
- Individual Devices can be locked against manual operation.
- To remove a Climate Device from a Climate Control, remove the Climate Device from the Room.

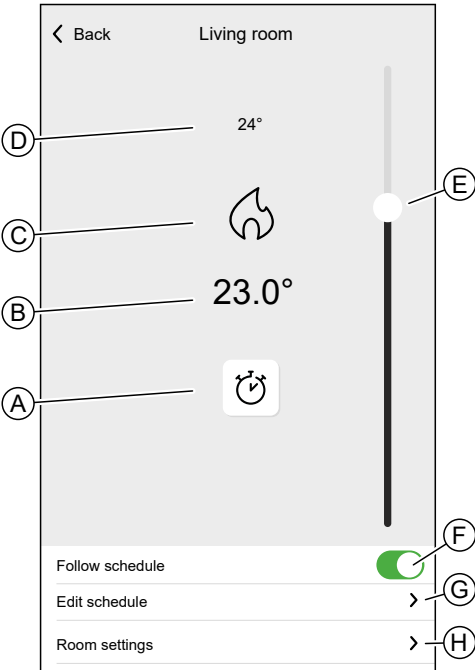
Climate Control:



<b>A</b>	Boost Mode
<b>B</b>	Target Temperature
<b>C</b>	Status Icon  Heating Icon:   Cooling Icon: 
<b>D</b>	Measured temperature in the Room
<b>E</b>	Slider to set target temperature
<b>F</b>	If the Climate Control is assigned to a Schedule, page 80, you can choose whether the Climate Control should follow the Schedule.
<b>G</b>	Lets you edit an existing Schedule, page 80.  <b>TIP:</b> If the Climate Control is not assigned to a Schedule, the option <b>Create or assign a schedule</b> will be available.
<b>H</b>	Navigate to the Room Details, page 60 of the room to which the climate control is assigned.

## Setting up a Climate Control

While setting up your Climate Control, make sure to consider the following information.

**Heating Control:**

- If your Home is using a Wiser 16A Relay for Temperature Control, you must add a Wiser Room Thermostat to that Room.
- If your Home is using a Wiser Underfloor Heating Connection Strip, you must add a Wiser Room Thermostat or Wiser Flush-mounted Thermostat 2 A to that Room.
- If you assigned more than two Radiator Thermostats to a Room, it is recommended to also assign a Room Thermostat or Wiser Flush-mounted Thermostat 2 A to that Room.
- Assign only one Room Thermostat to any Climate Control.

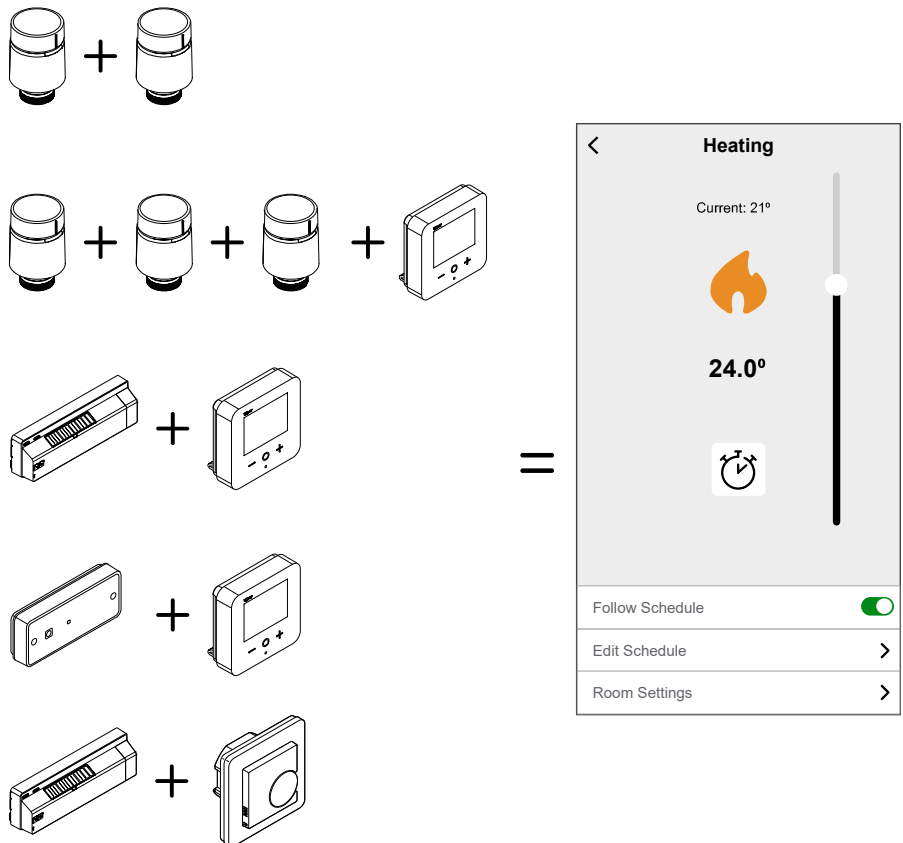

**Cooling Control:**

- If your Home is using a Wiser Underfloor Heating Connection Strip, you must add a Wiser Room Thermostat or a Wiser Flush-mounted Thermostat 2 A to the concerned Room.
- When the cooling mode is activated on a Wiser Flush-mounted Thermostat 2 A or on the UFH, all the devices switch to cooling mode. So, if the Wiser Flush-mounted Thermostat 2 A is in cooling mode, the UFH goes into cooling mode even if its cooling input is not enabled. Refer to device user guide of the respective device for more detailed information. List of Wiser Devices, page 10 provides the links to Device user guide for each devices.
- The UFH setpoint temperature ranges from 18°C to 30 °C.

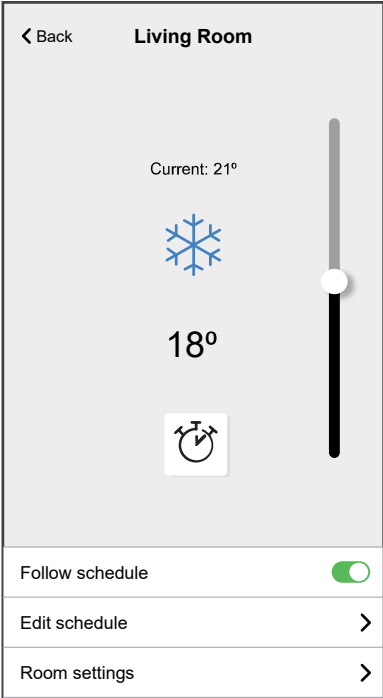
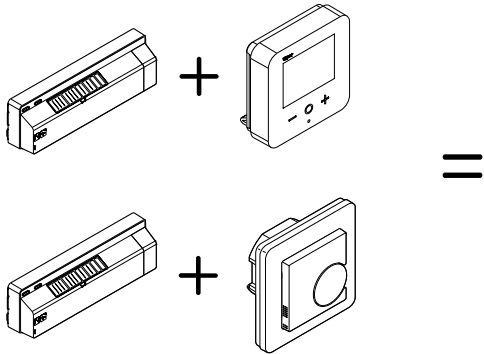

### Compatible third party devices

Third party climate devices, that are compatible with the Wiser System, show up in the Wiser Home app like a regular Wiser device.

They will also merge into a Climate Control like, e.g. a Wiser Radiator Thermostat.



## Voice Control

Integrate third-party voice control such as Alexa, Google Assistant into the app for increased functionality.

### Amazon Alexa

Amazon Alexa® (Alexa) is an intelligent personal assistant developed by Amazon®, and is capable of voice interaction.

Wiser works with Alexa to allow you to regulate the temperature of each room in your system by using a wake-word and an instruction.

The wake-work is “**Alexa**” followed by an instruction such as “**Increase temperature.**”

Currently, Amazon has made interaction and communication with Alexa only available in English and German.

### Changes made with Alexa

If Alexa is asked to increase the temperature by 2°C, then Alexa will add 2°C to your setpoint. If the ambient temperature is already >2°C above the current setpoint then the actual temperature will not change and Wiser will not turn the heating ON.

**Example:** If the current setpoint is 16°C, the current room temperature is 19°C and you ask Alexa to increase the temperature by 2°C - the current setpoint will change to 18°C but the heating will not start because the room temperature is already higher than 18°C.

Everything you tell Alexa to do related to Wiser Room Thermostats and Radiator Thermostats will last only for one hour, or until the next scheduled setpoint change if that change is to occur in under an hour. After that it goes back to its original setting, and you must tell Alexa to do it again.

If a Device is following a Schedule, any setting changed by Alexa will last until the next event in the Schedule. If the Device is running in manual mode, any command to Alexa will remain in place until the next command or manual setting.

### Common Wiser Commands for Alexa

Alexa requires explicit instructions. You must inform Alexa of the room to which you wish to address followed by an instruction, such as “increase temperature.” If no specific room is mentioned, Alexa will ask you which room you want to address, and then will increase the setpoint temperature by 1°C only based on the room reply from you.

If you want the setpoint temperature to increase by 4°C in the living room, you must explicitly state to Alexa to “**Increase the temperature in the living room by 4°C.**”

Listed below are common Wiser commands used with Alexa:

- Discover Devices: “Alexa, discover devices”
- Reduce Temperature: “Alexa, decrease the upstairs by 4 degrees”
- Increase Temperature: “Alexa, increase the upstairs by 3 degrees”
- Set Temperature: “Alexa, set the upstairs to 20 degrees”
- Get Temperature: “Alexa, what is the upstairs temperature?”
- Get Set Point: “Alexa, what is the upstairs set to?”

**NOTE:** Alexa considers the Room names and lights as the Devices.

Listed below are common Wiser Smart Plugs commands used with Alexa:

- Turn Off the Lights in the plug named bedside lamps: “Alexa, turn OFF the bedside lamps.”
- Turn ON the Lights in the plug named bedside lamps: “Alexa, turn ON the bedside lamps.”

Suggestions when using Alexa:

- Simple room names are recommended, such as “living room.”
- You cannot turn Heating ON or Off using Alexa.
- You cannot increase/decrease the temperature from Off. When a room is set to Off, you can adjust the room to a specific temperature.

## Google Home

Google Home is a brand of smart speakers that work similarly to Amazon Echo. Google’s intelligent PA, Google Assistant, is equivalent to Amazon’s Alexa. Google Home is also available on all Android devices and does not require the use of the ‘Smart Speakers’.

The user can speak a profusion of commands to request information, or ask the Google Assistant to perform an action such as play music, video playback, report news, access home automation. All of this can all be controlled from a Google Home device.

## Changes made with Google Home

All changes made through a voice command related to room thermostats and radiator thermostats are valid for one hour, or until the next scheduled event. The user cannot change this action. This also applies for boosts initiated from the radiator thermostat.

The reason for not implementing permanent changes to Wiser temperature is that a voice command can easily be forgotten, resulting in the heating accidentally being left ON for long periods of time, such as when users exit their home.

**NOTE:** When a command is given to increase/ decrease the temperature but no temperature setpoint is given, Google Home defaults the new setpoint temperature to the prior setpoint  $\pm 3$  degrees. This value is controlled by Google Home and differs from a normal Wiser boost, which defaults the new setpoint to  $\pm 2$  degrees above/below the current ambient temperature.

**NOTE:** Commands for turning the heating “ON/ OFF” are currently unavailable on Google Home. This is done intentionally as “OFF” cannot be reconciled with the notion of a temporary operation, and conversely, the notion of an “ON” setpoint does not exist on the Wiser system.

**NOTE:** If the Wiser Plug is following a schedule everything you tell Google Home to do related to Wiser Plugs will last until the next event in the Wiser Plug schedule. If the Wiser Plug is running in Manual Mode, everything you tell Google Home to do will remain in place until the next command either from Google Home or from the Wiser Home App.

## Common Wiser commands for Google Home

Listed below are common Wiser commands used with Google Home:

- Inquiry: “OK Google, is the light in bedroom ON?”
- Room Temperature: “OK Google, how warm is (room name)?”
- Set Temperature: “OK Google, set (room name) to XX degrees”
- Increase Temperature: “OK Google, increase setpoint by XX degrees”

Listed below are common Wiser Smart Plug commands used with Google Home:

- Table lamp command: “OK Google, turn ON/ OFF the Table lamp”

## Insights

The Insights feature gives you multiple features in a single place. This includes energy saving, system activity, heating time and access to your heat report.

To navigate to Insights from the Home screen:

1. Tap **Insights** (A)

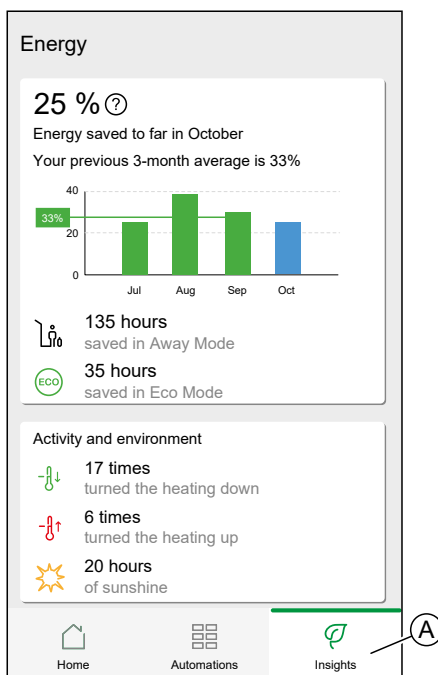

**NOTE:** If you have an energy device installed, like a PowerTag E, the Energy Center, page 119 will be displayed.

## Energy overview

We estimate how much energy you would have otherwise used, compare it against what you have used and show this as a percentage saving.

As the month progresses you can keep track of your savings by simply opening the app. Your energy savings are updated hourly so fluctuations are normal.

The system uses a smart algorithm to only count the time when Wiser's smart features were actively saving you energy.

Tap the **Question Mark** (A) for more details.

### Heating hours (B):

This section shows how much heating time you have used, relative to outdoor temperatures.

The temperatures are updated every hour. Each green bar displays the daily heating duration for the past 30 days. The length of the bars represents how many times your rooms called for heat during each day.

**NOTE:** The blue bar indicates the current month and will change to green once the month is finished.

New users will not see any green bars until you begin using your heating.

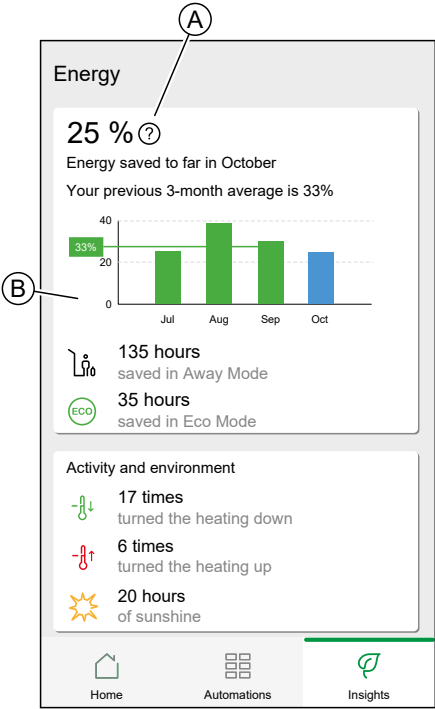

## Activity and environment

(A) Shows interesting facts about how you use your heating system as well as other interesting things that have been happening in your environment within the current month.

These numbers are updated hourly. Number of times you turned your heating down is counted by a manual boost or boost down. Number of times you turned your heating up is counted by a boost up or manual adjustment to the temperature. Number of hours of sunshine is calculated as number of hours when the cloud coverage was less than 50%.

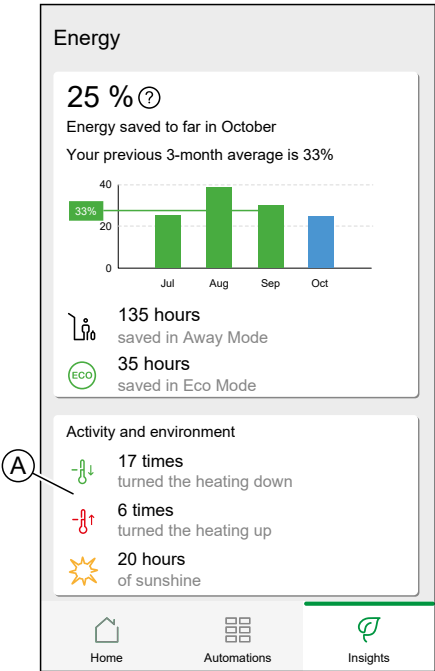

## Weather and Heating

(A) The weather can have a big impact on how your heating system performs. We take into account the thermal efficiency of your home and the outdoor temperature, so we can save you as much as possible.

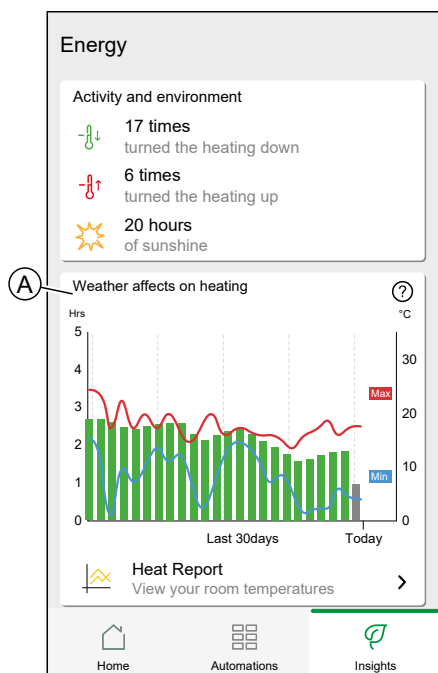

### Heating time

The green bars show an estimate of how many hours your heating was on each day. Incomplete and missing heating hours are both represented by grey bars.

### Weather

The maximum and minimum temperatures for each day are shown by red and blue lines. Missing weather temperatures are represented by dotted lines.

### Heat report

The performance of your heating system can be monitored with the Heat Report.

It enables the viewing of historical room, set (target), outdoor temperatures and allows for room-by room comparison over time, to ensure that the system performs according to scheduled and manual operations.

Wiser records room, set and outdoor temperatures on a continual basis and makes the data available in the Heat Report. The report is updated daily and a given day's temperature data is available the next day. It is possible to view the report on the basis of day, week and month.

To navigate to the Heat report:

1. Tap **Heat Report (A)**.

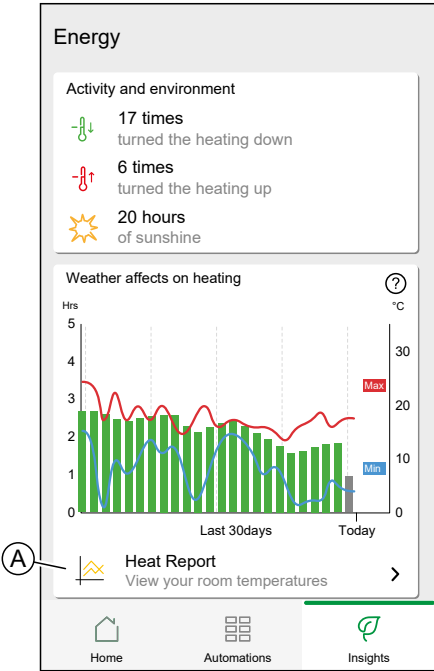

2. Heat Report:

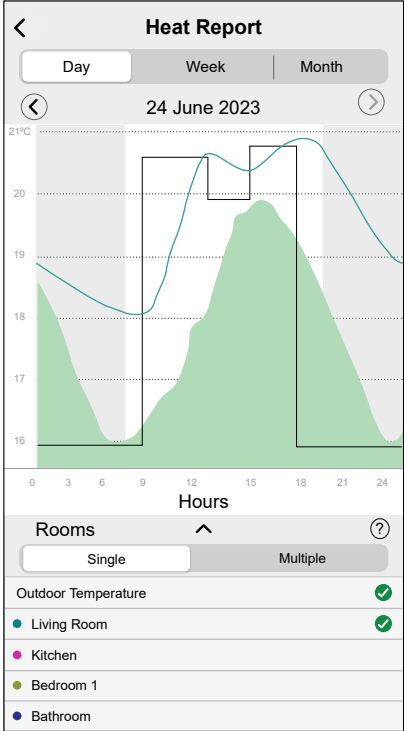

**Single-room view**

When accessed for the first time, the report opens from the single-room view.

This view defaults to display today's room temperature for the first room, as it appears on the Home screen of the app. It also displays the set temperature for the room (always illustrated by a black line).

The outdoor temperature is not displayed by default, but you can choose to view it by selecting it from room selector.

When viewing a single room, it is possible to see how long it takes for the room to heat up or cool down to the set temperature; the black line shows the set (target) temperature, i.e. Wiser's heating schedule for the room (if in Auto mode) or the manually selected set temperature (if in Manual mode). This line indicates the room temperature that Wiser is regulating to at all times.

**NOTE:** The Single room view always displays the set (target) temperature line for a given room. Temporary changes to the set temperature like manual boosts and temperature overrides are also visible on this line.

## Multi-room view

The multi-room view allows for simultaneous viewing and comparing of up to 16 rooms. The outdoor temperature can also be selected/ deselected in this view.

**NOTE:** If only one room is selected in the multi-room view, the black line denoting the set temperature will appear.

## Monthly view

The monthly view provides a summary of room temperature fluctuations during a given calendar month. All daily temperatures in this view are averaged out due to the screen size.

The outdoor temperature in this view is displayed as a green band indicating the daily min/max temperatures and the range in which the daily temperatures have fluctuated throughout the month.

## Temperature Display

The room name and temperature will appear when a temperature line is tapped. Any area outside the line can be tapped to make them disappear again. It is possible to tap on any point of a temperature line, including the outline of the green outdoor temperature area. Temperature lines can be tapped in all three views (Day/Week/Month).

## Missing Temperature Data

Temperature data may be missing from the system at times. This could be due to power failures, no internet connectivity, flat device batteries or poor RF signal. Missing data is denoted by a dotted line connecting the two points between which data is unavailable.

If data is missing for a given date or date range, the question mark on the ROOMS bar is replaced by . If data for the date/ range becomes available at a later time, or if the view is changed to another date/range, with no missing data, the question mark will reappear.

## Energy

If you have an energy device installed, like a PowerTag E, the Energy Center will be available.

In the Energy Center, you can monitor your power grid live, get a detailed history of your grid and get information on energy savings.

**IMPORTANT:** The wiser system supports the configuration with the following power source combinations, when the power tag is installed.

- Grid
- Grid and Solar
- Grid and Solar and Battery and Solar (combo).

To navigate to the Energy Center:

1. Tap  Energy.

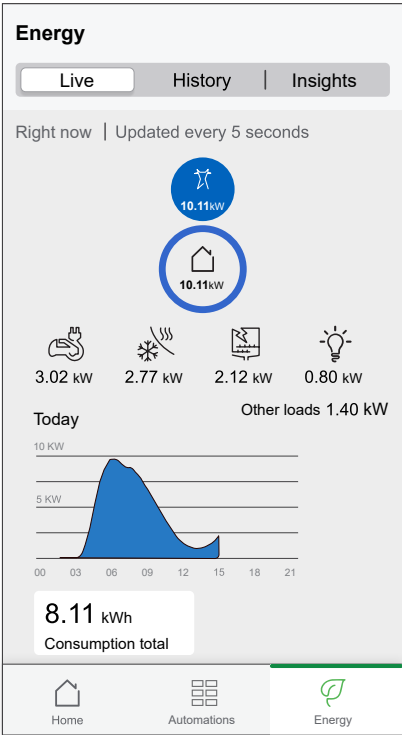

**NOTE:** If you do not have any energy devices installed, like a PowerTag E, Insights, page 115 will be displayed.

**NOTE:** You can find the detailed information in the Device User Guide of the respective device, page 10.

## Live

Provides live data of the grid consumption and live status of where the power is coming from:

- Grid to Home: Import ((Home consuming power from Grid)
- Home to Grid: Export (Excess power of Solar production fed to Grid)

## Import

Displays how much power you are importing, a breakdown into consumption categories and a consumption time line.



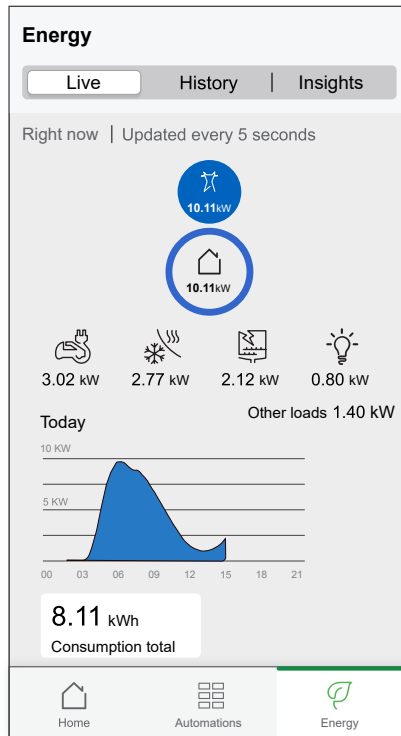

## Import and Export (Applicable for Grid with On Grid solar system)

Displays how much power you are importing or exporting, a breakdown into consumption categories and a consumption time line.

The grid consumption with loads is represented in blue and the excess power of battery and solar is represented in green.

**NOTE:** Scroll down in the app to view the complete graph.

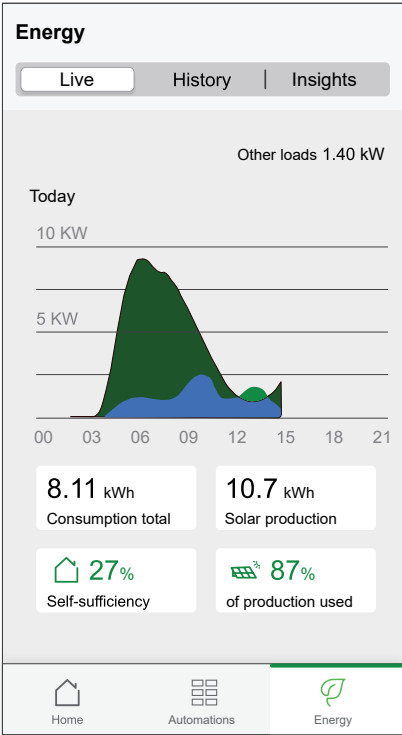
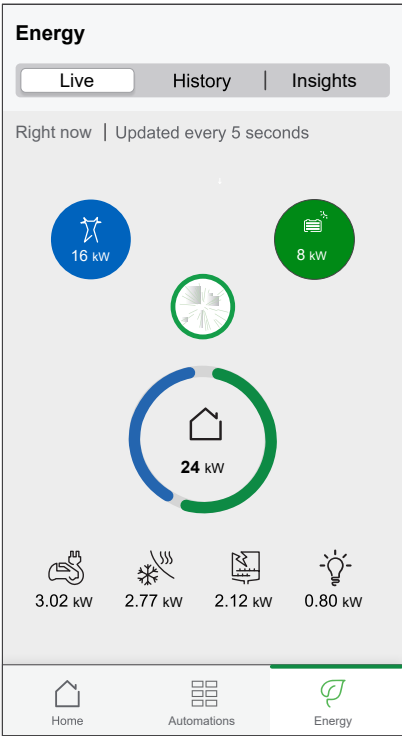

## History

Provides history of power consumed by loads. If there is an existing On Grid solar system, the app provides history of imported and exported energy.

1. On the  page, tap **History**.

- You can change the displayed timeframe (hours, days, months and years), by tapping (A).

**NOTE:** The Grid import is shown in blue and the excess energy of solar and battery is shown in green.

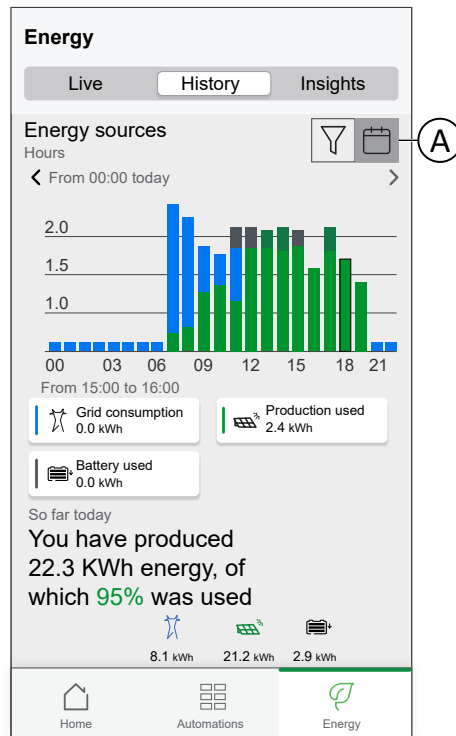

- You can tap  and select **Load consumption** to view the energy consumed by individual loads.
- Tap (A) and select a required time frame.

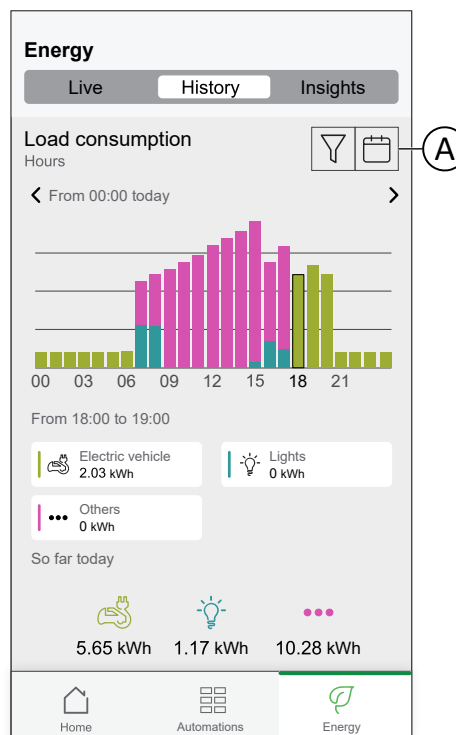

# Insights

The Insights provides information on the annual bill for the tariff set. It helps to keep track of your energy.

**NOTE:** The option to set a tariff is only available if you have an Energy device installed in your home. For more information, please refer to the Device User Guide of the respective device, page 10.

1. For a more detailed overview, tap (A)

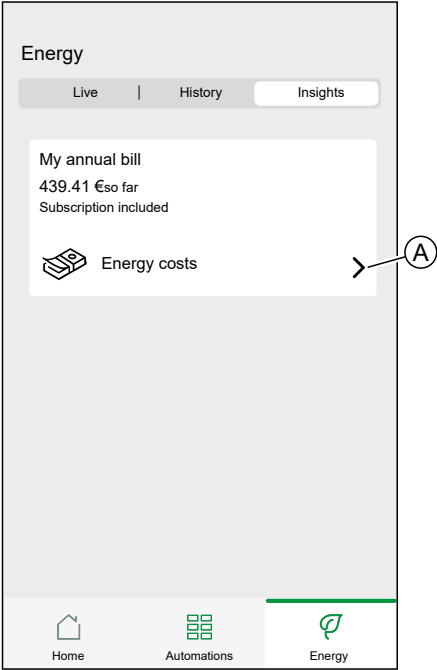

2. You can change the displayed timeframe (hours, days, months and years).

**IMPORTANT:** If you have installed PowerTag on solar or solar with battery **My savings** is available to view savings and earning history. .

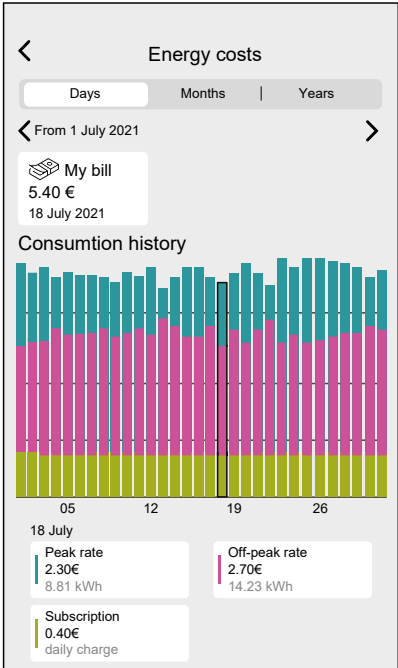





# Additional Information

## About Signal Strength

Zigbee signal strength or RSSI (Received Signal Strength Indicator) indicates the signal quality between your devices and the Wiser Hub. The Closer the RSSI value is to 0, the better the signal. For example, an RSSI of -50dBm is a good signal, while an RSSI of -80dBm indicates poor signal.

## Signal Strength Indicator

There is four different levels of signal strength:

-  Good Signal (between 0 & -54dBm)
-  Normal Signal (between -54 & -79dBm)
-  Poor Signal (<-79dBm)
-  No Signal (device is offline)

## Cause of Poor Signal

Connectivity issues can be caused by various factors, such as:

- **Distance between the Wiser Hub and devices** - the signal becomes weaker as the devices move farther apart.
- **Physical Obstructions** - doors, walls, furniture, household appliances, especially with metal surfaces, and other electronic devices can weaken the Zigbee signal.

## Troubleshooting

1. Place the Wiser Hub into open space.
2. Make sure you check if all powered devices are switched on and working normally.
3. If possible, move the Wiser Hub closer to the device with signal issues.
4. Try to remove any physical obstructions between the Wiser Hub and the device with poor or no signal.
5. For battery-powered devices, check the battery level and replace the batteries if necessary.

## Signal Extender

If you are still experiencing connectivity issues, we recommend adding Wiser smart plug to your system. It has a built-in signal range extender that boosts the signal between your devices and Wiser Hub.

### Discover Extenders:

For Spain: <https://www.se.com/es/es/product/CCTFR6501/wiser-smart-plug-zwischenstecker/>

For Portuguese: <https://www.se.com/pt/pt/product/CCTFR6501/wiser-smart-plug-zwischenstecker/>

## Help & Support

If you require further assistance, visit our Wiser Support Pages.

### Help & Support:

For Spain, Visit: <https://www.se.com/es/es/work/support/>

For Portugal, Visit: <https://www.se.com/pt/pt/work/support/>

## Changing home Wi-Fi login information

If you have made changes to your home Wi-Fi®, you need to apply those changes to the hub.

The Wiser app will detect that the connection to the hub is lost and suggest solutions.

To change the Wi-Fi® information in the hub:

1. Tap **I've changed my Wi-Fi router** (A).

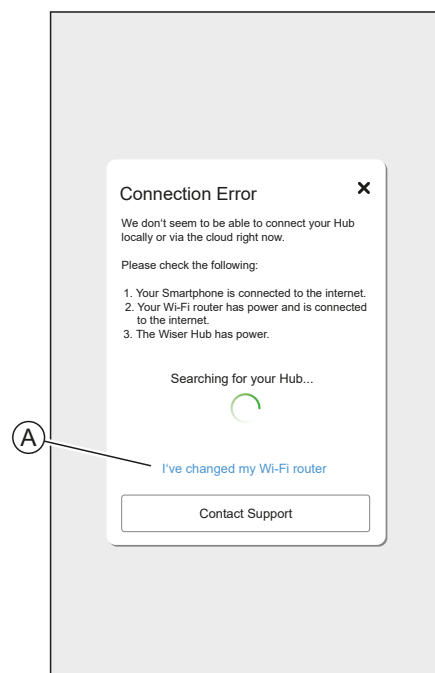



The app will guide you through the process of selecting a Wi-Fi® network and entering the password.

# Troubleshooting

This topic explains the solutions to problems with the system, devices and configuration settings.

## HUB

Symptom	Possible cause	Solution
When adding a device, the device is rejected or will not join.	The device may not be supported by the system.	Only use devices listed in List of Wiser Devices, page 10.
The device is not able to connect with the Hub/Hub <sup>R</sup> . After pressing 3 times, the device LED blinks amber for 30 s. 	Pairing mode has changed.	Press the Reset button on the device 3 times then hold for 20 s, until the LED blinks red. The device should reboot into the correct mode. 

If you face any issues in commissioning the device, refer to the troubleshooting section of the specific device user guide.

Refer to List of Wiser Devices, page 10 for the links to Device user guide for each devices.

---

# Decommissioning a Wiser System

To remove a device from your Home or prepare the Home for a new user, follow these steps.

- Remove all Devices from the System.
- Reset all Devices to the factory settings.
- Reset the Hub to the factory settings.

**NOTE:** Before an IoT device is permanently removed from your network, a full factory reset must be done to erase all data.

## Removing a device

Possible reasons:

- The Device needs to be replaced.
- The Device is no longer needed in the Wiser System.

Steps:

- Remove the Device from the Wiser System.

Details about this process can be found in Chapter

- Reset the Device to the factory settings.

Find the details of resetting the Device in the Device User Guide of the respective Device: [List of Wiser Devices](#), page 10

## Resetting the Wiser System

Possible reasons:

- You are moving out of the house and want to prepare it for the next owner.
- Ownership of the Wiser System is to be transferred to another user.

Steps:

- Reset the Hub. Refer to [Resetting to factory defaults, page 47](#) for Wiser Hub 2nd Generation and [Resetting to factory defaults, page 49](#) for Wiser HubR 2nd Generation.
- Delete your Account.



## eSetup App

eSetup for Electricians App is the dedicated app for Electricians to configure Smart Home and Smart panel devices.

No need for PC or complex tools to configure smart systems – everything can be done via smartphone, thanks to eSetup for Electricians App

With eSetup for Electricians App you can,

- Commissioning of Wiser products with step by step guidance
- See the complete installation in DEMO Mode (no need of actual devices)
- Define the system and settings of the devices
- Verify and test the installation

Get connected to Bluetooth or Wifi to the product directly. This dedicated application for Electricians is a commissioning tool for Wiser devices in residential and SmartLink, Powertag devices in Small Buildings.

**NOTE:** Not all the wiser devices can be configured using the eSetup app. The app offer the configuration for devices such as Light and Shutter Devices, Wiser Home Touch, Evlink Home Smart, Wiser IP Module.

## Using the eSetup app

With the eSetup app, you can configure Devices without the need of an internet connection.

Your smartphone will connect to the Device directly.

You can set the Name of the Device and assign it to a Room. Other settings are depending on the individual Devices.

You can test the Devices.

To configure a Device:

1. Choose the Device type.
  - Light and Shutter Devices
  - Wiser Home Touch
  - Wiser IP Module
2. Choose the specific Device type, e.g. rotary dimmer.
3. Connect the Device to the app by setting it into pairing mode.

The app will show you how to set the Device into pairing mode.
4. Set the Name for the Device.
5. Assign the Device to a Room.
6. Test the Device.

# Compliance

## Compliance information for Green Premium products

Find and download comprehensive information about Green Premium products, including RoHS compliance and REACH declarations as well as Product Environmental Profile (PEP) and End-of-Life instructions (EOLI).

<https://checkaproduct.se.com/>



## General information about Green Premium products

Click the link below to read about Schneider Electric's Green Premium product strategy.

<https://www.schneider-electric.com/en/work/support/green-premium/>



## Trademarks

This guide makes reference to system and brand names that are trademarks of their relevant owners.

- Zigbee® is a registered trademark of the Connectivity Standards Alliance.
- Apple® and App Store® are brand names or registered trademarks of Apple Inc.
- Google Play™ Store and Android™ are brand names or registered trademarks of Google Inc.
- Wi-Fi® is a registered trademark of Wi-Fi Alliance®.
- Wiser™ is a trademark and the property of Schneider Electric, its subsidiaries and affiliated companies.

Other brands and registered trademarks are the property of their respective owners.



Printed in:  
Schneider Electric  
35 rue Joseph Monier  
92500 Rueil Malmaison - France  
+ 33 (0) 1 41 29 70 00

Schneider Electric  
35 rue Joseph Monier  
92500 Rueil Malmaison  
France

+ 33 (0) 1 41 29 70 00

[www.se.com](http://www.se.com)

As standards, specifications, and design change from time to time,  
please ask for confirmation of the information given in this publication.

© 2023 – 2024 Schneider Electric. All rights reserved.

SUG\_Wiser\_Home\_Iberic\_WH-01