

# Exxact – Connected Wireless Switch 1-gang/ 2-gang

## Device user guide

Information about features and functionality of the device.

02/2023



# Legal Information

The Schneider Electric brand and any trademarks of Schneider Electric SE and its subsidiaries referred to in this guide are the property of Schneider Electric SE or its subsidiaries. All other brands may be trademarks of their respective owners.

This guide and its content are protected under applicable copyright laws and furnished for informational use only. No part of this guide may be reproduced or transmitted in any form or by any means (electronic, mechanical, photocopying, recording, or otherwise), for any purpose, without the prior written permission of Schneider Electric.

Schneider Electric does not grant any right or license for commercial use of the guide or its content, except for a non-exclusive and personal license to consult it on an "as is" basis. Schneider Electric products and equipment should be installed, operated, serviced, and maintained only by qualified personnel.

As standards, specifications, and designs change from time to time, information contained in this guide may be subject to change without notice.

To the extent permitted by applicable law, no responsibility or liability is assumed by Schneider Electric and its subsidiaries for any errors or omissions in the informational content of this material or consequences arising out of or resulting from the use of the information contained herein.

---

# Table of Contents

Safety information .....	4
Exxact – Connected Wireless Switch 1-gang/2-gang .....	5
For your safety .....	5
About the device .....	5
Installing the device .....	6
Pairing the device with Wiser Gateway .....	6
Pairing device manually .....	6
Pairing device with auto scan .....	8
Configuring the device .....	9
Changing the device icon .....	9
Renaming the device .....	10
Changing the device location .....	10
Removing the device .....	11
Resetting the device .....	11
Using the device .....	12
Lighting group .....	13
Shutter group .....	16
Moments .....	19
Replacing the battery .....	24
LED indications .....	24
Troubleshooting .....	25
Technical Data .....	25
Compliance .....	26
Compliance information for Green Premium products .....	26
Trademarks .....	26

# Safety information

## Important information

Read these instructions carefully and look at the equipment to become familiar with the device before trying to install, operate, service, or maintain it. The following special messages may appear throughout this manual or on the equipment to warn of potential hazards or to call attention to information that clarifies or simplifies a procedure.



The addition of either symbol to a “Danger” or “Warning” safety label indicates that an electrical hazard exists which will result in personal injury if the instructions are not followed.



This is the safety alert symbol. It is used to alert you to potential personal injury hazards. Obey all safety messages that accompany this symbol to avoid possible injury or death.

### **DANGER**

**DANGER** indicates a hazardous situation which, if not avoided, **will result in** death or serious injury.

**Failure to follow these instructions will result in death or serious injury.**

### **WARNING**

**WARNING** indicates a hazardous situation which, if not avoided, **could result in** death or serious injury.

### **CAUTION**

**CAUTION** indicates a hazardous situation which, if not avoided, **could result in** minor or moderate injury.

### **NOTICE**

NOTICE is used to address practices not related to physical injury.

# Exxact – Connected Wireless Switch 1-gang/2-gang



WDE002906



WDE002924

## For your safety

### **⚠ DANGER**

#### **HAZARD OF ELECTRIC SHOCK, EXPLOSION, OR ARC FLASH**

While installing the device on a wall box or an existing switch outlet combination, always isolate the 230 V AC cables by applying an adhesive silver foil on the fixing plate.

**Failure to follow these instructions will result in death or serious injury.**

## About the device

The Connected Wireless Switch 1-gang/2-gang (hereinafter referred to as **Wireless Switch / Freelocate Switch**) is a battery-powered wireless switch that is used to control a group of Zigbee devices (such as light and shutter) within the same Zigbee network. The device can be configured through the Wiser app.

#### **Features of the Wireless Switch:**

- Control a group (such as lighting and shutter control).
- Trigger/activate a moment (such as Movie Night, Good Night Moment).
- Low battery notification.

#### **NOTE:**

- This device user guide shows pairing, configuring and other features of Wireless Switch 2-gang. The same applies for Wireless Switch 1-gang.
- Construction materials may cause interference which affect Gateway-to-device and device-to-device distances. In the open air, there is no interference, so the distance can be much longer.

## Installing the device

Refer to the installation instruction supplied with this product.  
See [Connected Wireless Switch 1-gang/2-gang](#).

## Pairing the device with Wiser Gateway

Using the Wiser app, first pair your device with the **Wiser Gateway** to access and control the device. You can either add the device manually or do an auto-scan to pair it.

## Pairing device manually

To pair the device manually:

**NOTE:** Remember to insert the battery to turn on the device.

1. On the Home page, tap **+**.
2. Tap , select **Wiser Hub** on the slide-up menu and tap **Done**.
3. Select any one of the options to add device (A):
  - **Add Device with Install Code**
  - **Add Device without Install Code**

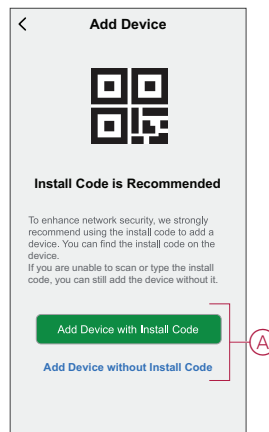

- To pair the device with an Install Code, tap **Add Device with Install Code** to display the slide-up menu. Select any one of the options (B):
  - Scan Install Code** - You can scan the device for the Install Code
  - Enter Install Code Manually** - You can manually enter the install code from the device

After scanning or entering the install code, proceed to **Step 6**.

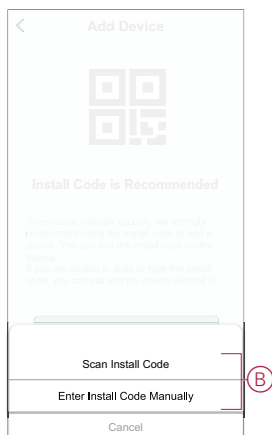

**TIP:** It is recommended to add the device with Install Code for security.

- To pair the device without Install Code, tap **Add Device without Install Code**.
- Short press the top right push button 3 times.

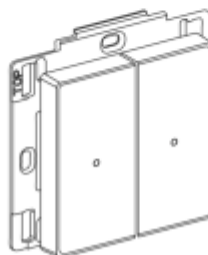
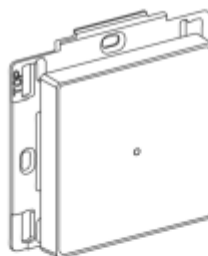

Make sure that the LED blinks orange.

7. In the app, select **Confirm that the LED is blinking (C)** and tap **Start configuration**.

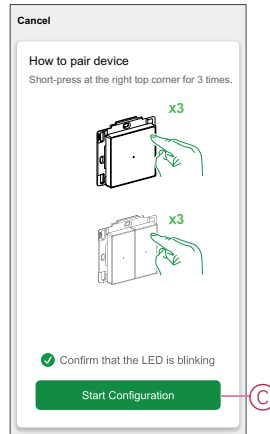

8. After a few seconds, a solid green LED indicates that the device has been successfully paired to the Gateway.

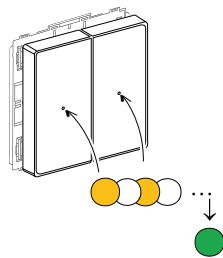

9. Once the device is added in the app, tap **Done**.

## Pairing device with auto scan

Pairing the device with auto scan automatically discovers the device when the corresponding device is powered on.

**NOTE:** Remember to insert the battery to turn on the device.

1. Remove the rockers using a screwdriver to see the LED.
  2. On the Home page, tap **+**.
  3. Tap **Auto scan > Confirm**.
  4. Enable permissions to **Access location** and **Wi-Fi** for scanning device and tap **Start scanning**.
- NOTE:** If you have multiple hubs, do Step 5 or proceed to Step 6.
5. Tap **Select hub** and select the Wiser hub from the slide-up menu.
  6. Short press the top right push button 3 times and wait for a few seconds until the device search is completed.

**TIP:** If you want to pair multiple devices, perform step 5 on each device and wait for a few seconds.

7. Tap **Next** (A) and select **Freelocate Switch**.

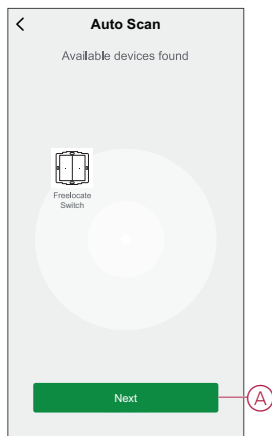



8. Tap **Done** once the device is paired successfully.

## Configuring the device

### Changing the device icon

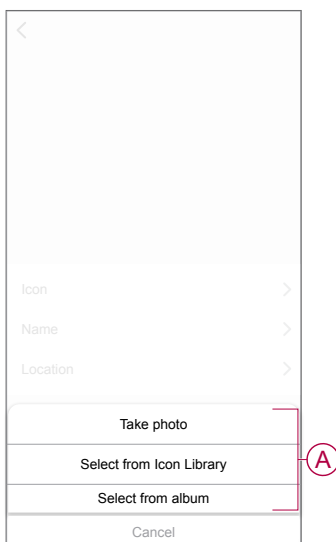

You can change the device icon using the Wisier app.

1. On the **Home** page, select the device for which you wish to change the icon.
2. At the top-right corner of the screen, tap .
3. Tap edit  next to the device name.
4. Tap **Icon** to view the menu.
5. In the slide-up menu, select any one of the following (A) to change the device icon:
  - **Take photo** - allows you to click a photo from the mobile camera.
  - **Select from Icon Library** - allows you to select an icon from the app library.
  - **Select from Album** - allows you to select a photo from the mobile gallery.



## Renaming the device

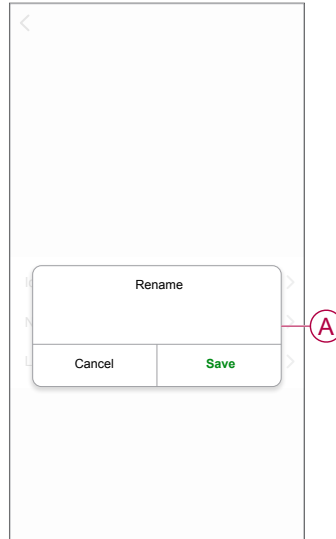

You can rename the device using the Wiser app.

1. On the **Home** page, select the device for which you wish to rename.
2. At the top-right corner of the screen, tap .
3. Tap edit  next to the device name.
4. Tap **Name**, enter the new name (A) and then tap **Save**.



## Changing the device location

You can change the device location using the Wiser app.

1. On the **Home** page, select the device for which you wish to change the location.
2. At the top-right corner of the screen, tap .
3. Tap edit  next to the device name.
4. Tap **Location**.
5. Select the desired location from the list (A) and then tap **Save**.

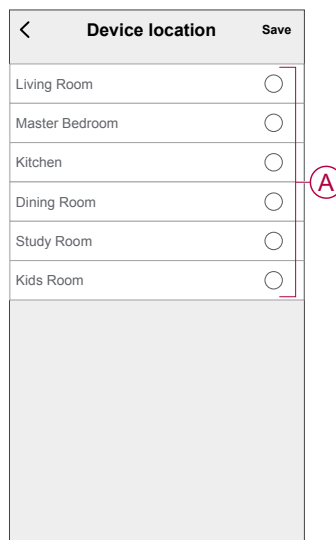

## Removing the device

Using the Wiser app, you can remove a device from the device list.

1. On the **Home** page, tap **All devices > Wireless Switch**.
2. Tap  to display more details.
3. Tap **Remove and Factory Reset Device (A)** and short press the top-right push button 3 times to activate the device.

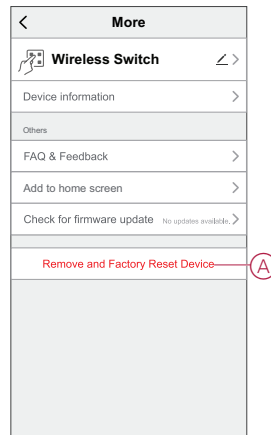

**TIP:** On the home page you can tap and hold the **Wireless Switch** to remove the device.

**NOTE:** By removing the device, you will reset the device. If you still have a problem with the reset, refer to [resetting the device](#), page 11.

## Resetting the device

You can reset the **Wireless Switch** to factory default manually.

To reset the Wireless Switch:

1. Short press the top-right push button 3 times (< 0.5 s) and then press and hold the push button (>10 s).
2. After 10 s, LED starts blinking red, then release the push button.

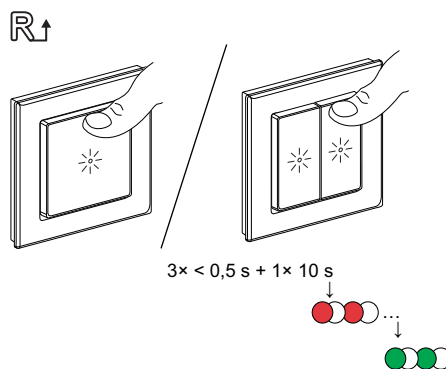

The wireless switch restarts and blinks green for a few seconds.

**NOTE:**

- After reset, the LED turns off to save the battery.
- All configuration data, user data, and network data are deleted.

## Using the device

The control panel of the Wireless Switch allows you to add lighting group, shutter group and moment to each push button.

On the Wireless Switch control panel, you can see the following:

- Battery level (A)
- Top left key (B)
- Top right key (C)
- Bottom left key (D)
- Bottom right key (E)

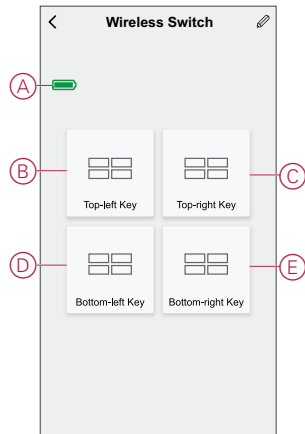

**NOTE:** The app assigns both top and bottom keys to a lighting and shutter group, while any one key is assigned to a moment.

### Functions of the Wireless Switch push button:

Group	Devices	Push button function
Lighting group	Switch	<ul style="list-style-type: none"> <li>• Turn on: Single press top key</li> <li>• Turn off: Single press bottom key</li> </ul>
	Dimmer	<ul style="list-style-type: none"> <li>• Turn on: Single press top key</li> <li>• Turn off: Single press bottom key</li> <li>• Increase brightness: Long press top key</li> <li>• Decrease brightness: Long press bottom key</li> </ul>

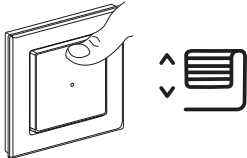
Shutter group	Shutter	<ul style="list-style-type: none"> <li>• Open: Long press top key</li> <li>• Stop opening: Single press top/bottom key</li> <li>• Close: Long press bottom key</li> <li>• Stop closing: Single press top/bottom key</li> </ul> 
Moment	Triggers the devices that are added in a moment	<ul style="list-style-type: none"> <li>• Turn on: Single press the key</li> </ul> <p><b>NOTE:</b> You cannot turn off a moment. To go back to it's previous state, you need to create another moment, page 19 for that.</p>

## Lighting group

Using the Wiser app, you can create lighting groups and assign them to one or more wireless switch push buttons.

**TIP:** A lighting group can be assigned to left top/bottom keys or the right top/bottom keys or both.

## Adding a lighting group

To add a lighting group to the top and bottom left key:

1. On the Home page, tap **All devices > Connected Wireless Switch**.
2. On the control panel page, tap **Top left key > Lighting Group > +**.
3. Tap **Edit name** , enter the group name (A) and tap **Save**.

**TIP:** You can choose the cover image that represents your group by tapping .

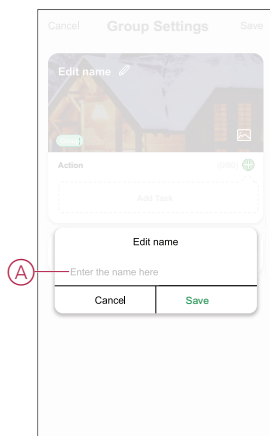

4. Tap **Add Task** to select any device from the list and tap **Next**.

**NOTE:** You can add one or more actions using .

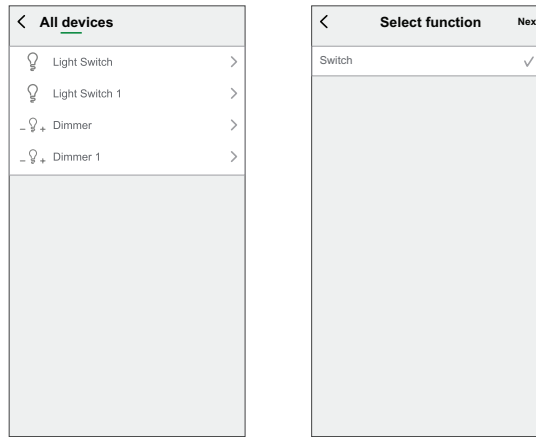

5. Once all the actions are set, tap **Save**.

6. On the **Lighting Group** page, select the light group (B) you want to assign to the push button.

7. Short press the top right push button 3 times to activate the device and tap **Sure** (C) on the app.

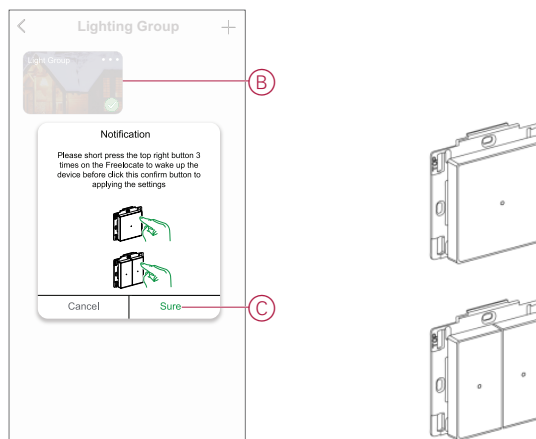

The lighting group is now added to the top and bottom left key (D).

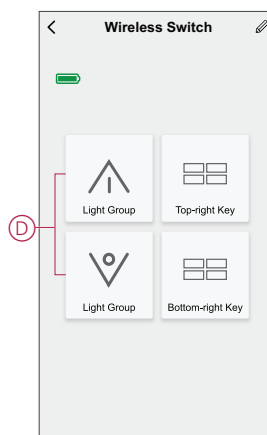

**NOTE:** If you add a shutter/moment group to the top/bottom left key, then the app removes the lighting group from the top/bottom left key.

## Editing a lighting group

1. Navigate to **Connected Wireless Switch > Top left key > Lighting Group**.
2. Locate the lighting group you want to edit and tap **•••**.
3. On the **Edit** page, you can tap each item to change the settings and tap **Save**.

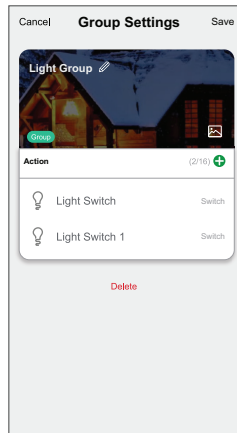

### TIP:

- You can add one or more actions using .
- To delete an existing action, slide the each item towards left and tap **Delete**.

## Unbinding a lighting group

Unbinding the lighting group allows you to remove the lighting group from the assigned keys without deleting the lighting group.

1. Go to the control panel and tap **Top left key**.
2. Tap **Unbind**.
3. Short press the top right push button 3 times on the **Wireless Switch** to activate the device and tap **Sure** on the app notification.

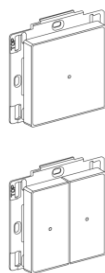

The lighting group is now removed from the top and bottom left key.

## Deleting a lighting group

1. Navigate to **Wireless Switch > Top left key > Lighting Group**.
2. Locate the lighting group you want to delete and tap **•••**.

3. Tap **Delete** (A).

**NOTE:** Deleting a lighting group will unbind the lighting group from the keys.

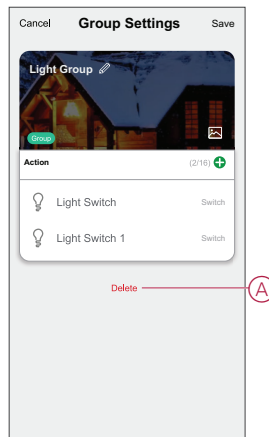

## Shutter group

Using the Wiser app, you can create shutter groups and assign them to one or more wireless switch push buttons.

**TIP:** A shutter group can be assigned to the left top/bottom keys, the right top/bottom keys or both.

## Adding a shutter group

To add a shutter group to the top and bottom right key:

1. On the **Home** page, tap **All devices** > **Connected Wireless Switch**.
2. On the control panel page, tap **Top right key** > **Shutter Group** > **+**.
3. Tap **Edit name** , enter the group name (A) and tap **Save**.

**TIP:** You can choose the cover image that represents your group by tapping .

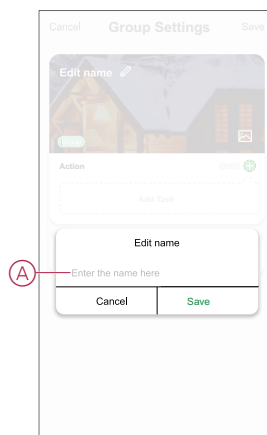

4. Tap **Add Task** to select any device from the list and tap **Next**.

**NOTE:** You can add one or more actions using .

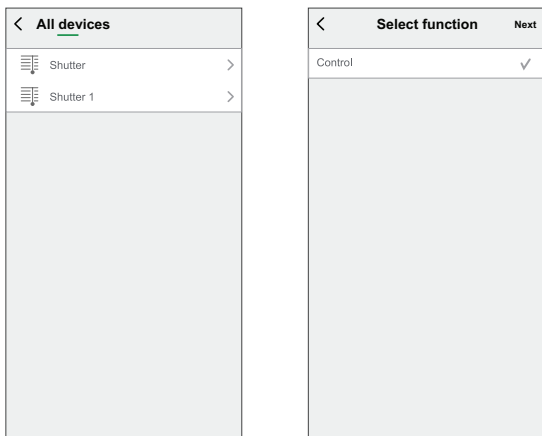

5. Once all the actions are set, tap **Save**.
6. On the **Shutter Group** page, select the shutter group (B) you want to assign to the push button.
7. Short press the top right push button 3 times on the **Wireless Switch** to activate the device and tap **Sure** on the app.

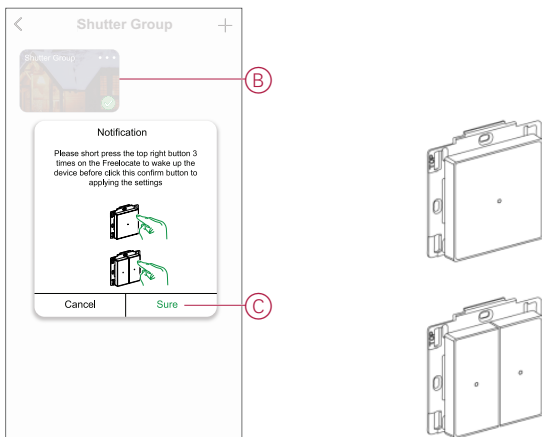

The shutter group is now added to the top and bottom right key (D).

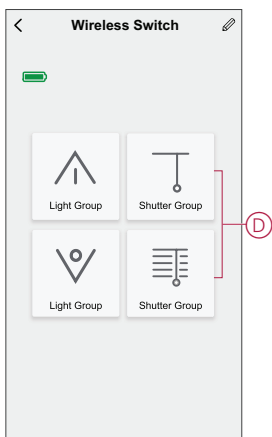

**NOTE:** If you add a lighting/moment group to the top/bottom right key, then the app removes the shutter group from the top/bottom right key.

## Editing a shutter group

1. Navigate to **Wireless Switch > Top right key > Shutter Group**.
2. Locate the shutter group you want to edit and tap ●●●.
3. On the **Edit** page, you can tap each item to change the settings and tap **Save**.

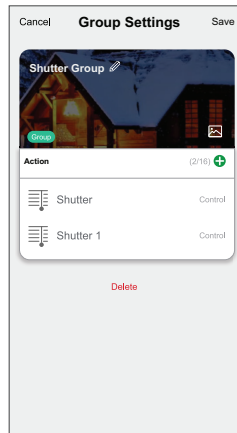

### TIP:

- You can add one or more actions using .
- To delete an existing action, slide the each item towards left and tap **Delete**.

## Unbinding a shutter group

Unbinding the shutter group allows you to remove the shutter group from the assigned keys without deleting the shutter group.

1. Go to the control panel and tap **Top right key**.
2. Tap **Unbind**.
3. Short press the top right push button 3 times on the **Wireless Switch** to activate the device and tap **Sure** on the app notification.

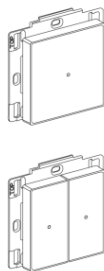

The shutter group is now removed from the top and bottom right keys.

## Deleting a shutter group

1. Navigate to **Wireless Switch > Top right key > Shutter Group**.
2. Locate the shutter group you want to delete and tap ●●●.

3. Tap **Delete** (A).

**NOTE:** Deleting the shutter group will unbind the shutter group from the keys.

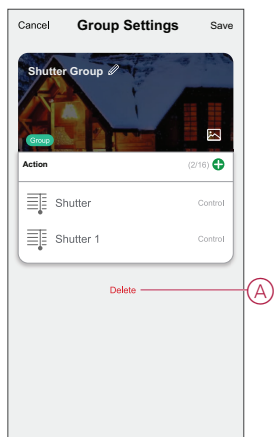



## Moments

A Moment allows you to group multiple actions that are usually performed together. Using the Wiser app, you can create moments based on your needs (such as movie night) and configure them to the Wireless Switch push buttons.

**TIP:** A moment can be assigned to any of the four keys individually.

## Creating a moment

To create a moment:

1. On the **Home** page, tap .
2. Go to **Moment** > **+** to create a moment.
3. Tap **Edit name** , enter the group name (A) and tap **Save**.

**TIP:** You can choose the cover image that represents your moment by tapping .

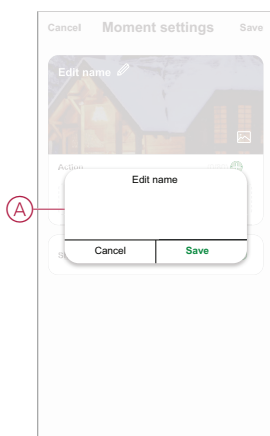

4. In the **Action** section, tap **Add task** (B) to open the slide-up menu.

5. In the **Add task** menu, you can do either or all of the following actions (C):
  - Run the device - Select the devices that you want in a moment.
  - Delay - Set the delay time.

**NOTE:** You can add one or more actions using .

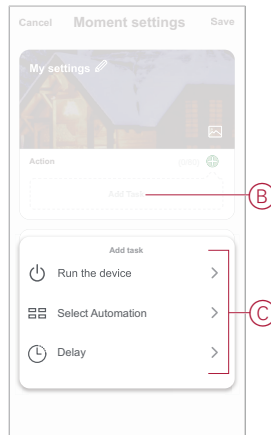

6. Tap **Run the device** and select the devices and its function you want to add and tap **Next**.
 

**EXAMPLE:** If you want to open a curtain, then tap **Curtain Switch > Control > Open** and tap **Save**.
7. Once all the actions are set, tap **Save**.

**TIP:** You can navigate to **Connected Wireless Switch > Top right key > Moment** and tap **+** to create a moment.

## Adding a moment to the wireless switch

Using the Wiser app, you can add a moment to the Wireless Switch push buttons. To add a moment to the Wireless Switch key(s):

1. On the **Home** page, tap **All devices > Connected Wireless Switch**.
2. On the control panel page, tap **Top right key > Moment**.
3. Select a moment from the list of created moments (A).

- Short press the top right push button 3 times on the **Wireless Switch** to activate the device and tap **Sure (B)** on the app.

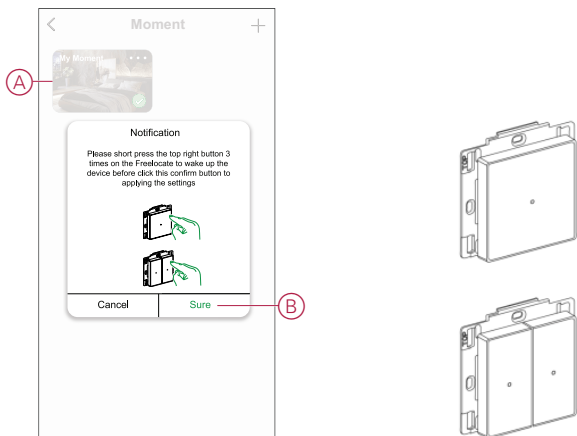

The moment is now added to the **Top right key (C)**.

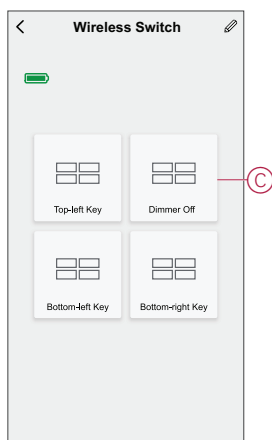

**NOTE:** If you add a lighting/shutter group to the bottom right key, then the app removes the moment from the top right key.

## Editing a moment

- Navigate to **Wireless Switch > Top right key > Moment**.
- Locate the moment you want to edit and tap ●●●.

3. On the **Edit** page, you can tap each item to change the settings and tap **Save**.

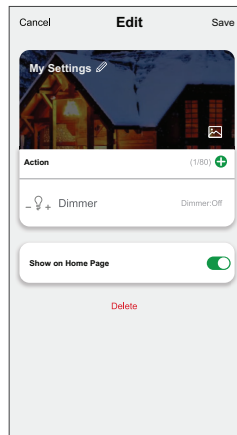

**TIP:**

- You can add one or more actions using .
- To delete an existing action, slide the each item towards left and tap **Delete**.

## Unbinding a moment

Unbinding the moment allows you to remove the moment from the assigned keys without deleting the moment.

1. In control panel, tap and hold **Top right key**.
2. Select the moment and then tap **Unbind**.
3. Short press the top right push button 3 times on the **Wireless Switch** to activate the device and tap **Sure** on the app notification.

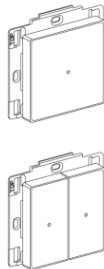

The moment is now removed from the top right key.

## Deleting a moment

1. Navigate to **Wireless Switch > Top right key > Moment**.
2. Locate the moment that you want to delete and tap **...**.

3. Tap **Delete** (A).

**NOTE:** Deleting the lighting group will unbind the lighting group from the keys.

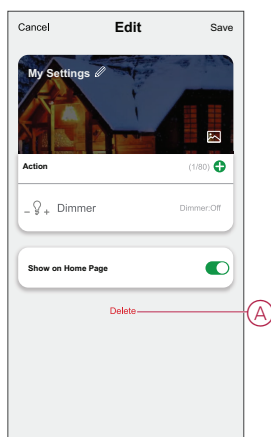

## Replacing the battery

Replace the device battery when the level is low or critically low. The battery level can be seen in the app.

Follow the steps to replace the battery from the device:

### ⚠ WARNING

#### CHEMICAL BURN HAZARD

Keep batteries out of reach of children. If swallowed, seek immediate medical attention.

**Failure to follow these instructions can result in death, serious injury, or equipment damage.**

### NOTICE

#### EQUIPMENT DAMAGE

The device is locked on the fixing plate with retaining claws. Never pull the device before sliding it upwards.

**Failure to follow these instructions can result in equipment damage.**

1. Remove the device from the fixing plate by sliding it upwards.
2. Rotate the device by 180° to access the battery cover.
3. Press and hold the battery cover with your thumb.
4. Slide the battery cover with another thumb to remove.
5. Remove the old battery and press any push button on the device for a few seconds.

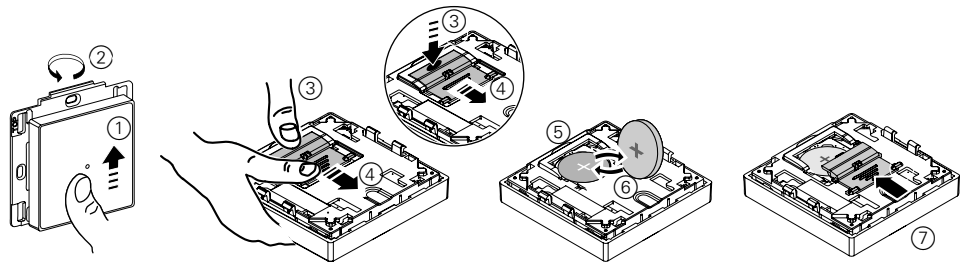

**NOTE:** Dispose the used batteries, as per statutory regulations.

6. Insert the battery with plus (+) symbol facing outward
7. Secure the battery cover.





## LED indications

### Pairing the device

User Action	LED Indication	Status
Press the top right push button 3 times	LED blinks orange, once per second. 	Pairing mode is active for 30 seconds. When pairing is completed, LED displays solid green for a few seconds, before turning Off. 

## Resetting the device

User Action	LED Indication	Status
Press the push button 3 times and hold it down once for > 10 s.	LED blinks red, once per second. 	The device is in reset mode. The device then restarts and the LED starts blinking green, before turning Off. 

## Battery level

LED Indication	Status
LED blinks red once, when a push button is pressed. 	The battery is low (< 10%), Replace the Wireless Switch battery, page 24. <b>NOTE:</b> A notification pop-up will appear on the app.

## Troubleshooting

Symptom	Possible cause	Solution
LED blinks red.	The Wireless Switch battery is low or drained.	Replace the Wireless Switch battery, page 24. <b>NOTE:</b> A notification pop-up will appear on the app.
The Wireless Switch displays offline in the app.	The Wireless Switch battery is low or drained.	Replace the Wireless Switch battery, page 24.
	The Wireless Switch is disconnected from the network.	Press any push button on the Wireless Switch. <b>NOTE:</b> The first press does not trigger Wireless Switch operation.

## Technical Data

Battery	CR2032
Battery life	Up to 5 years (depending on frequency of use and quality of battery)
IP rating	IP20
Operating frequency	2405-2480 MHz
Max. radio-frequency power transmitted	<10 mW
Operating temperature	-5 °C to 45 °C
Relative humidity	5% to 95%
Communication protocol	Zigbee 3.0

---

# Compliance

## Compliance information for Green Premium products

Find and download comprehensive information about Green Premium products, including RoHS compliance and REACH declarations as well as Product Environmental Profile (PEP) and End-of-Life instructions (EOLI).

## General information about Green Premium products

Click the link below to read about Schneider Electric's Green Premium product strategy.

<https://www.schneider-electric.com/en/work/support/green-premium/>

## Find compliance information for a Green Premium product

Click the link below to search for a product's compliance information (RoHS, REACH, PEP and EOLI).

**NOTE:** You will need the product reference number or product range to perform the search.

<https://www.reach.schneider-electric.com/CheckProduct.aspx?cskey=ot7n66yt63o1xblflyfj>

## Trademarks

This guide makes reference to system and brand names that are trademarks of their relevant owners.

- Zigbee® is a registered trademark of the Connectivity Standards Alliance.
- Apple® and App Store® are brand names or registered trademarks of Apple Inc.
- Google Play™ Store and Android™ are brand names or registered trademarks of Google Inc.
- Wi-Fi® is a registered trademark of Wi-Fi Alliance®.
- Wiser™ is a trademark and the property of Schneider Electric, its subsidiaries and affiliated companies.

Other brands and registered trademarks are the property of their respective owners.



Schneider Electric  
35 rue Joseph Monier  
92500 Rueil Malmaison  
France

+ 33 (0) 1 41 29 70 00

[www.se.com](http://www.se.com)

As standards, specifications, and design change from time to time,  
please ask for confirmation of the information given in this publication.

© 2023 – Schneider Electric. All rights reserved.

DUG\_Exxact FLS\_WSE-00