

# Exxact – Connected Wireless Switch 1-gang/ 2-gang

## Wiser Home Device user guide

Information about features and functionality of the device.

10/2025



# Legal Information

The information provided in this document contains general descriptions, technical characteristics and/or recommendations related to products/solutions.

This document is not intended as a substitute for a detailed study or operational and site-specific development or schematic plan. It is not to be used for determining suitability or reliability of the products/solutions for specific user applications. It is the duty of any such user to perform or have any professional expert of its choice (integrator, specifier or the like) perform the appropriate and comprehensive risk analysis, evaluation and testing of the products/solutions with respect to the relevant specific application or use thereof.

The Schneider Electric brand and any trademarks of Schneider Electric SE and its subsidiaries referred to in this document are the property of Schneider Electric SE or its subsidiaries. All other brands may be trademarks of their respective owner.

This document and its content are protected under applicable copyright laws and provided for informative use only. No part of this document may be reproduced or transmitted in any form or by any means (electronic, mechanical, photocopying, recording, or otherwise), for any purpose, without the prior written permission of Schneider Electric.

Schneider Electric does not grant any right or license for commercial use of the document or its content, except for a non-exclusive and personal license to consult it on an "as is" basis.

Schneider Electric reserves the right to make changes or updates with respect to or in the content of this document or the format thereof, at any time without notice.

**To the extent permitted by applicable law, no responsibility or liability is assumed by Schneider Electric and its subsidiaries for any errors or omissions in the informational content of this document, as well as any non-intended use or misuse of the content thereof.**

---

# Table of Contents

Safety Information.....	4
About the Document.....	5
Exxact – Connected Wireless Switch 1-gang/2-gang .....	8
About the device.....	8
Installing the device .....	8
Changing the device from 1-gang to 2-gang.....	9
Quick Home Connect.....	10
Pairing Wireless Switch with Devices.....	11
Using the Wireless switch in Quick Home Connect .....	18
Resetting the Device in Quick Home Connect .....	19
LED Indications in Quick Home Connect.....	20
Troubleshooting in Quick Home Connect .....	20
Pairing the device with the Wiser Hub .....	21
Configuring the device .....	25
Setting the device location .....	25
Renaming the device .....	26
Identifying the device .....	27
Removing the device from the system .....	28
Resetting the device.....	28
Using the device.....	29
Assigning an Action to the Wireless switch.....	29
Controlling the device with Push Buttons .....	32
Assigning a Moment to the Wireless switch.....	32
Removing configured Action/Moment .....	34
Replacing the battery.....	35
LED indications .....	36
Troubleshooting .....	36
Technical Data .....	36

# Safety Information

## Important Information

Read these instructions carefully and look at the equipment to become familiar with the device before trying to install, operate, service, or maintain it. The following special messages may appear throughout this manual or on the equipment to warn of potential hazards or to call attention to information that clarifies or simplifies a procedure.



The addition of either symbol to a “Danger” or “Warning” safety label indicates that an electrical hazard exists which will result in personal injury if the instructions are not followed.



This is the safety alert symbol. It is used to alert you to potential personal injury hazards. Obey all safety messages that accompany this symbol to avoid possible injury or death.

<b>⚡⚠ DANGER</b>
<b>DANGER</b> indicates a hazardous situation which, if not avoided, <b>will result in</b> death or serious injury. <b>Failure to follow these instructions will result in death or serious injury.</b>
<b>⚠ WARNING</b>
<b>WARNING</b> indicates a hazardous situation which, if not avoided, <b>could result in</b> death or serious injury.
<b>⚠ CAUTION</b>
<b>CAUTION</b> indicates a hazardous situation which, if not avoided, <b>could result in</b> minor or moderate injury.
<b>NOTICE</b>
NOTICE is used to address practices not related to physical injury.

# About the Document

## Document Scope

This document provides detailed information on the Exxact – Connected Wireless Switch 1-gang/2-gang, covering its features, installation, configuration, and operation. It explains how to pair the device with various Zigbee devices and the Wiser Hub, assign actions or moments. Explains how to operate the Wireless switch via push buttons, configure settings through the Wiser Home app, and replace the battery. It also includes troubleshooting tips, LED indications, resetting procedure, and technical specifications.

## Validity Note

The characteristics of the products described in this document are intended to match the characteristics that are available on [www.se.com](http://www.se.com). As part of our corporate strategy for constant improvement, we may revise the content over time to enhance clarity and accuracy. If you see a difference between the characteristics in this document and the characteristics on [www.se.com](http://www.se.com), consider [www.se.com](http://www.se.com) to contain the latest information.

## For your safety

### **DANGER**

#### **HAZARD OF ELECTRIC SHOCK, EXPLOSION, OR ARC FLASH**

While installing the device on a wall box or an existing switch outlet combination, always isolate the 230 V AC cables by applying an adhesive silver foil on the fixing plate.

**Failure to follow these instructions will result in death or serious injury.**

## General Cybersecurity Information

In recent years, the growing number of networked machines and production plants has seen a corresponding increase in the potential for cyber threats, such as unauthorized access, data breaches, and operational disruptions. You must, therefore, consider all possible cybersecurity measures to help protect assets and systems against such threats.

To help keep your Schneider Electric products secure and protected, it is in your best interest to implement the cybersecurity best practices as described in the [Cybersecurity Best Practices](#) document.

Schneider Electric provides additional information and assistance:

- [Subscribe to the Schneider Electric security newsletter.](#)
- [Visit the Cybersecurity Support Portal web page to:](#)
  - [Find Security Notifications.](#)
  - [Report vulnerabilities and incidents.](#)
- [Visit the Schneider Electric Cybersecurity and Data Protection Posture web page to:](#)
  - [Access the cybersecurity posture.](#)
  - [Learn more about cybersecurity in the cybersecurity academy.](#)
  - [Explore the cybersecurity services from Schneider Electric.](#)

## Environmental Data

Find and download comprehensive environmental data about your products, including RoHS compliance and REACH declarations as well as Product Environmental Profile (PEP), End-of-Life instructions (EOLI) and much more.

<https://www.se.com/myschneider>



### **General information about Schneider Environmental Data Program**

Click the link below to read about Schneider Electric's Environmental Data Program.

<https://www.se.com/ww/en/about-us/sustainability/environmental-data-program/>



## Declaration of Conformity

Hereby, Schneider Electric Industries SAS, declares that this product is in compliance with the essential requirements and other relevant provisions of RADIO EQUIPMENT DIRECTIVE 2014/53/EU.

Declaration of conformity can be downloaded on:

- <https://www.go2se.com/ref=WDE002906>
- <https://www.go2se.com/ref=WDE002924>

## Available Languages of the Document

The document is available in these languages:

- English
- Swedish
- Finnish

## Information on Non-Inclusive or Insensitive Terminology

As a responsible, inclusive company, Schneider Electric is constantly updating its communications and products that contain non-inclusive or insensitive terminology. However, despite these efforts, our content may still contain terms that are deemed inappropriate by some customers.

## Trademarks

- Wiser™ is a trademark and the property of Schneider Electric, its subsidiaries and affiliated companies.
- Zigbee® is a registered trademark of the Connectivity Standards Alliance.
- Apple® and App Store® are brand names or registered trademarks of Apple Inc.
- Google Play™ Store and Android™ are brand names or registered trademarks of Google Inc.
- Wi-Fi® is a registered trademark of Wi-Fi Alliance®.
- Amazon Alexa™ is a trademark of AMAZON TECHNOLOGIES, INC.
- Google Home™ is a trademark of Google INC.
- QR Code is a registered trademark of DENSO WAVE INCORPORATED in Japan and other countries.

Other brands and registered trademarks are the property of their respective owners.

# Exxact – Connected Wireless Switch 1-gang/2-gang



WDE002906



WDE002924

## About the device

The Connected Wireless Switch 1-gang/2-gang (hereinafter referred to as **Wireless switch**) is a battery-powered Wireless switch that is used to control a group of Zigbee devices (such as light/shutter) within the same Zigbee network.

The Wireless switch can be configured through the Wiser Home app.

### Advantage of using a Wireless switch:

- Easy to use and user-friendly interface: also good for children (placed lower on the wall) and for the elderly who may not be so familiar with smart phones.
- Easy to mount on the wall: no wiring required.

### Features of a Wireless switch:

- Add various actions (such as lighting/shutter control) to the Wireless switch.
- Add moments to the Wireless switch (such as Movie Night Moment/Good Night Moment).
- Low battery notification.

**NOTE:** This device user guide shows pairing, configuring and other features of Wireless switch 2-gang. The same applies for Wireless switch 1-gang.

## Installing the device

Refer to the installation instruction supplied with this product.  
See Connected Wireless Switch 1-gang/2-gang.

## Changing the device from 1-gang to 2-gang

You can change the Wireless switch mode from 1-gang to 2-gang before you pair your device to the **Hub**.

**NOTE:** The Wireless switch is in 1-gang mode by default.

Follow the steps to change the mode:

1. Remove the 1-gang rocker from the module.

<b>NOTICE</b>
<p><b>MODULE DAMAGE</b></p> <p>The module is locked into the rocker. Use a screwdriver and carefully remove the rocker from the module.</p> <p><b>Failure to follow these instructions can result in equipment damage.</b></p>

2. Mount the 2-gang rocker on the module.
3. Insert the module into the frame from the front and ensure that it clicks into place.
4. Press and hold the top right and bottom left push button simultaneously for 10 seconds until the LED starts blinking red.

The red LED indicates the switching process. The Wireless switch is now changed to 2-gang mode.

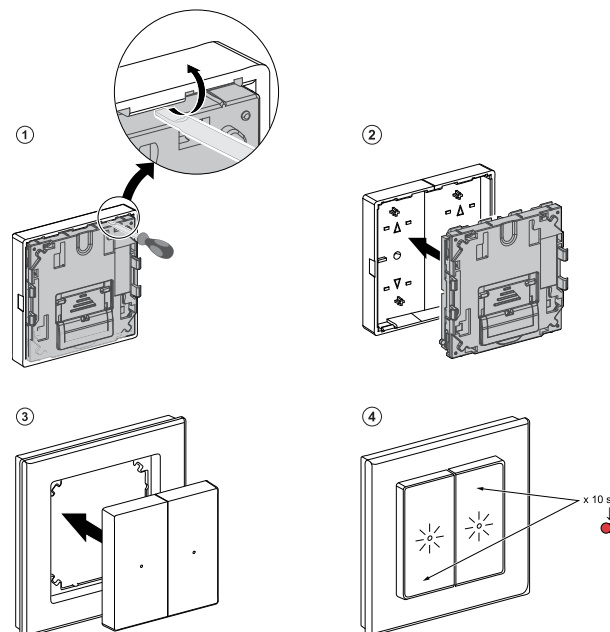

**NOTE:** To change the mode back to 1-gang, reset the Wireless switch to factory default mode. Refer to [resetting the device](#), page 28 and replace with 1-gang rocker.

## Quick Home Connect

Quick Home Connect is a wireless connectivity solution for Zigbee devices without the need for a Hub or smartphone application. Quick Home Connect is your starting point for wireless home automation. It performs functions like switching, dimming and shutter control using the Connected Wireless Switch (hereinafter referred to as Wireless switch) via a Zigbee network.

The **Wireless switch** is a battery-powered wireless push-button switch that is used to control Zigbee devices (such as dimmer, shutter, switch, and socket) within the same Zigbee network.

## Limitations

- Quick Home Connect serves only as a room control solution.
- With a 1-gang Wireless switch, you cannot mix lighting and shutter control. However, with a 2-gang Wireless switch, you can assign one gang for dimming/switching and the other for shutter control, or vice versa.
- This solution does not support remote control, smartphone app usage, or scheduling features.

## Pairing Wireless Switch with Devices

The following topics explain the pairing information for the micro module light switch, micro module shades control, multiwire micro module dimmer, rotary dimmer, push-button dimmer, socket outlet, relay switch, and blind control switches.

### Micro Module Light Switch (Puck)

1. Short press the upper push button 5 times in quick succession on the Wireless switch.

The status LED blinks green.

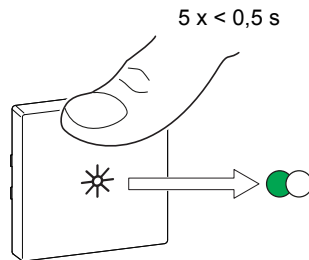

- 2.

#### **⚠ WARNING**

##### **HAZARD OF ELECTRIC SHOCK**

- Observe the regulations for working on live parts.
- Only actuate the device buttons using insulated auxiliary equipment that meets the requirements of EN 60900.

**Failure to follow these instructions can result in death, serious injury, or equipment damage.**

Follow either of the options to pair the Puck:

- Short press the Setup/Reset button 5 times in quick succession on the Puck.
- Short press the mechanical push button 5 times in quick succession.

The status LED blinks green on the Puck.

**NOTE:** If the Puck is located behind the mechanical push button, the status LED is not visible.

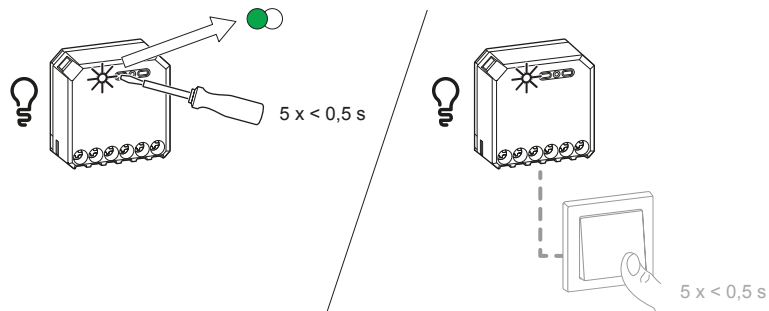

The light connected to the Puck blinks for a few times. The status LED stops blinking green on the Wireless switch and the Puck. The Puck can now be controlled by the Wireless switch.

## Micro Module Shades Control (Puck)

1. Short press the upper push button 5 times in quick succession on the Wireless switch.  
The status LED blinks green.

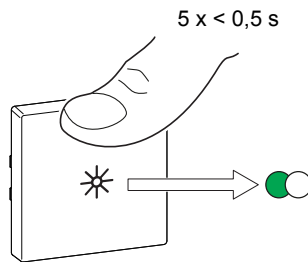

2.

### ⚠ WARNING

#### HAZARD OF ELECTRIC SHOCK

- Observe the regulations for working on live parts.
- Only actuate the device buttons using insulated auxiliary equipment that meets the requirements of EN 60900.

**Failure to follow these instructions can result in death, serious injury, or equipment damage.**

Follow either of the options to pair the Puck:

- Short press the Setup/Reset button 5 times in quick succession on the Puck.
- Short press the right mechanical push button for 5 times in quick succession.

The status LED blinks green on the Puck.

**NOTE:** If the Puck is located behind the mechanical double push button, the status LED is not visible.

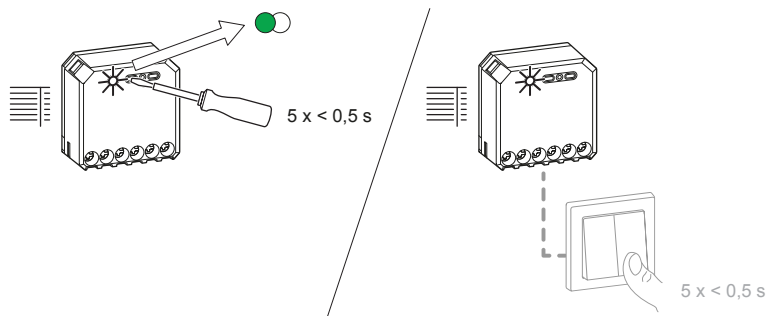

The shutter moves up and down for a few times. The status LED stops blinking green on the Wireless switch and the Puck. The Puck can now be controlled by the Wireless switch.

## Multiwire Micro Module Dimmer

**Prerequisites:** While connecting the dimmer to the mechanical push buttons, make sure that the terminal 1 of the dimmer is wired to the left mechanical push button, and terminal 2 of the dimmer is wired to the right mechanical push button.

1. Short press the upper push button 5 times in quick succession on the Wireless switch.

The status LED blinks green.

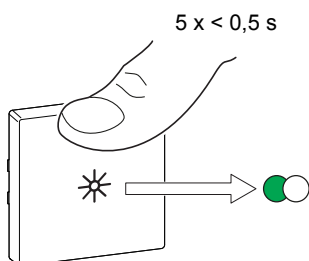

- 2.

## ⚠ WARNING

### HAZARD OF ELECTRIC SHOCK

- Observe the regulations for working on live parts.
- Only actuate the device buttons using insulated auxiliary equipment that meets the requirements of EN 60900.

**Failure to follow these instructions can result in death, serious injury, or equipment damage.**

Follow either of the options to pair the Dimmer:

- Short press the Setup/Reset button 5 times in quick succession on the Dimmer.
- Short press the left push button (Wired to terminal 1) 5 times in quick succession.

The status LED blinks green on the Dimmer.

**NOTE:** If the Dimmer is located behind the mechanical push button, the status LED is not visible.

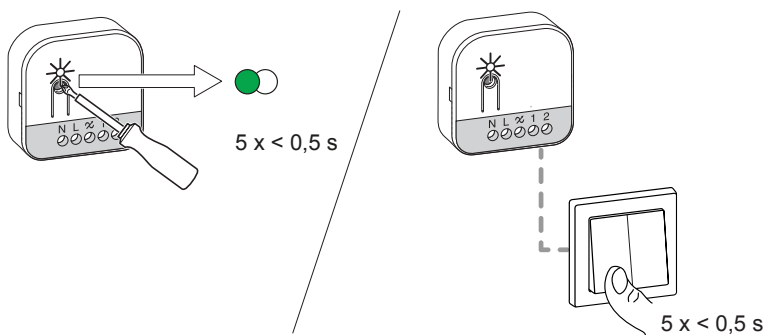

The light connected to the Dimmer blinks for a few times. The status LED stops blinking green on the Wireless switch and the Dimmer. The Dimmer can now be controlled by the Wireless switch.

## Rotary Dimmer

1. Short press the upper push button 5 times in quick succession on the Wireless switch.

The status LED blinks green.

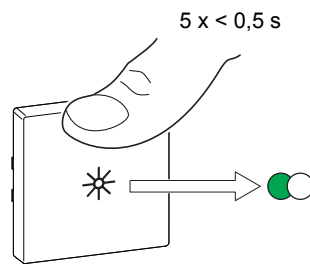

2. Remove the knob and short press the push button 5 times in quick succession.

The status LED blinks green.

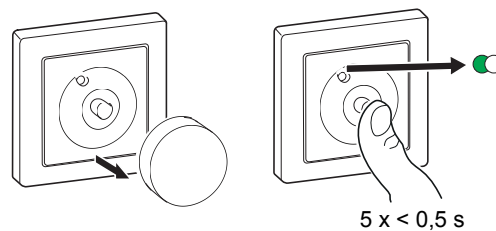

The light connected to the Rotary Dimmer blinks for a few times. The status LED stops blinking green on the Wireless switch and the Rotary Dimmer. The Rotary Dimmer can now be controlled by the Wireless switch.

## Push-button Dimmer

1. Short press the upper push button 5 times in quick succession on the Wireless switch.

The status LED blinks green.

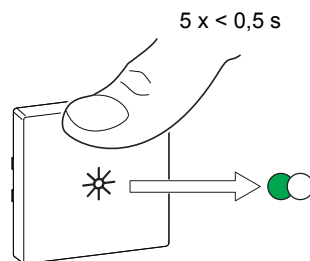

2. Short press the push-button of the Dimmer 5 times in quick succession.

The status LED blinks green.

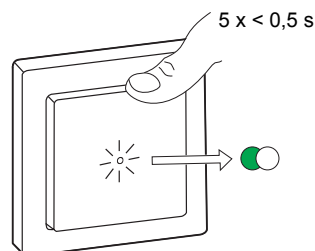

The light connected to the Push-button Dimmer blinks for a few times. The status LED stops blinking green on the Wireless switch and the Push-button Dimmer. The Push-button Dimmer can now be controlled by the Wireless switch.

## Socket Outlet

1. Short press the upper push button 5 times in quick succession on the Wireless switch.

The status LED blinks green.

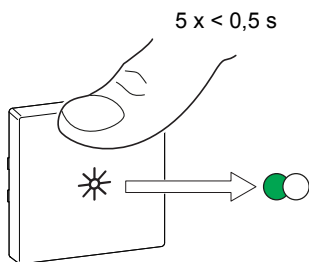

2. Short press the push-button of the Socket Outlet 5 times in quick succession.

The status LED blinks green.

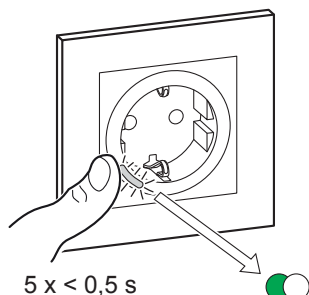

Upon successful pairing, the green LED on the Wireless switch and the Socket Outlet will stop blinking.

## Relay Switch

1. Short press the upper push button 5 times in quick succession on the Wireless switch.

The status LED blinks green.

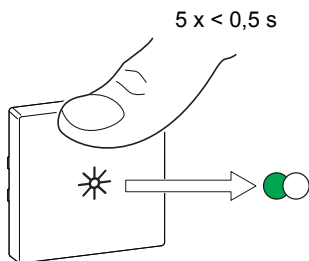

2. Short press the push-button of the Relay Switch 5 times in quick succession.

The status LED blinks green.

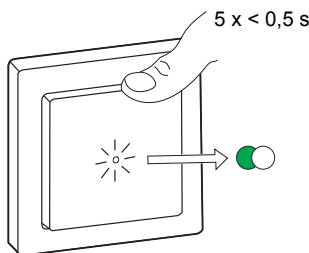

The light connected to the Relay Switch blinks for a few times. The status LED stops blinking green on the Wireless switch and the Relay Switch. The Relay Switch can now be controlled by the Wireless switch.

## Blind Control Switches

You can pair 2-gang or 1-gang Wireless switch with 2 Blind control switches as per your need.

### Pairing 1-gang with 1 or 2 Blind Control Switches

**NOTE:** If you want to pair a 1-gang Wireless switch with one blind control switch, follow the steps up to step 2. To continue with a second blind control switch, follow the next steps.

1. Short press the upper push button 5 times in quick succession on the Wireless switch.

The status LED blinks green.

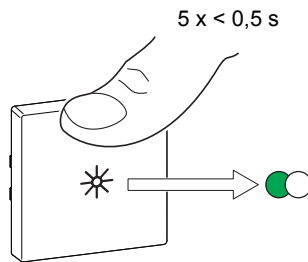

2. Short press the first blind control switch 5 times in quick succession.

The status LED blinks green.

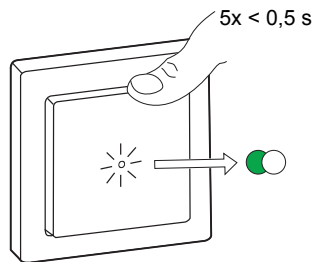

The shutter will move up and down a few times during the pairing process. The status LED stops blinking green on the Wireless switch, and the blind control switch indicates that the pairing is successful.

**IMPORTANT:** Check if the pairing was successful before you continue with the same channel.

3. Repeat step 1.
4. Repeat step 2 on the second blind control switch.  
The shutter will move up and down a few times during the pairing process. The status LED stops blinking green on the Wireless switch, and the blind control switch indicates that the pairing is successful.
5. Set up the shutter calibration manually. For more information, refer to shutter calibration without wiser app.

### Pairing 2-gang with 2 Blind Control Switches

To pair the 2-gang Wireless switch with 2 blind control switches, you must change your Wireless switch to 2-gang operation. Refer to .

**NOTE:** Do not remove the rocker of the blind control switches.

1. Short press the right upper push button 5 times in quick succession on the Wireless switch.

The status LED blinks green.

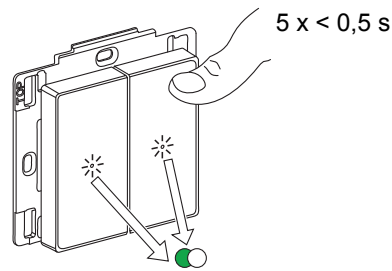

2. Short press the first blind control switch 5 times in quick succession.

The status LED blinks green.

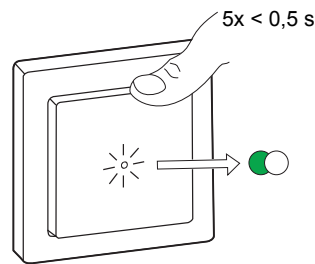

The shutter will move up and down a few times during the pairing process. The status LED stops blinking green on the Wireless switch, and the blind control switch indicates that the pairing is successful.

**IMPORTANT:** Check if the pairing was successful before you continue with the left channel.

3. Short press the top-left push button 5 times in quick succession on the Wireless switch.

The status LED blinks green.

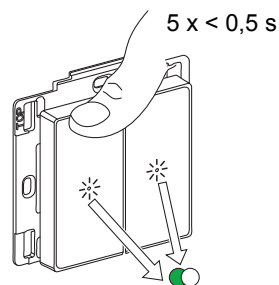

4. Repeat step 2 on the second blind control switch.

The shutter will move up and down a few times during the pairing process. The status LED stops blinking green on the Wireless switch, and the blind control switch indicates that the pairing is successful.

5. Set up the shutter calibration manually. For more information, refer to shutter calibration without wiser app.

## Using the Wireless switch in Quick Home Connect

### Operating a Dimmer

You can switch the dimmer on/off and adjust its brightness using the paired Wireless switch.

- Short press the top or bottom of the Wireless switch ( $< 0,5$  s) to turn on/off the connected load (A).
- Long press the top or bottom of the Wireless switch ( $> 0,5$  s) to increase or decrease the brightness of the connected load (B).

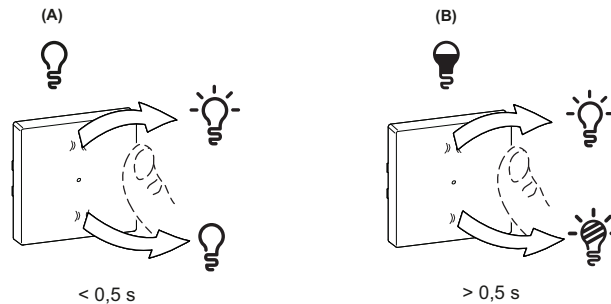

### Operating a Relay Switch

You can turn the light on/off using the paired Wireless switch. Short press the top or bottom of the Wireless switch ( $< 0,5$  s) to turn on/off the light.

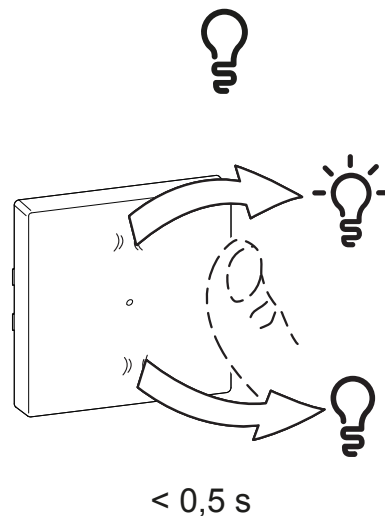

### Operating a Shades Control

You can operate the shades control using the Wireless switch.

- Long press the Wireless switch ( $> 0,5$  s) to move the shades control up or down.
  - Press to open the shades control (A)
  - Press to close the shades control (B)

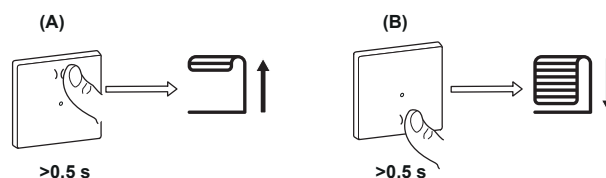

- Short press the top or bottom of the Wireless switch (< 0,5 s) to stop the moving shades control (C).
- Short press the top or bottom of the Wireless switch (< 0,5 s) to adjust the slat position (D).

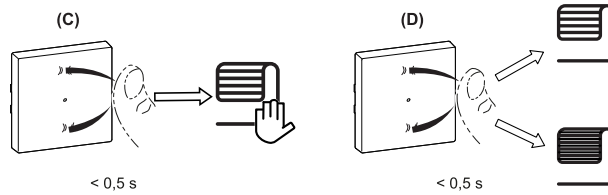

## Operating a Socket Outlet

Short press the top or bottom of the Wireless switch (< 0,5 s) to turn ON/OFF the socket.

The LED blinks red indicating that the socket outlet is turned On.

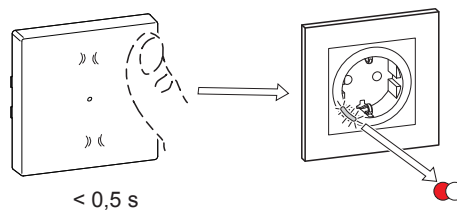

## Resetting the Device in Quick Home Connect

It is necessary to reset the devices in the following scenarios:



- Unpair the device in Quick Home Connect:
- Refer to
  - Resetting the Wireless switch
  - Resetting the Micro module light switch
  - Resetting the Micro Module shades control
  - Resetting the Multiwire micro module dimmer
  - Resetting the Rotary dimmer
  - Resetting the Push-button dimmer
  - Resetting the Socket outlet
  - Resetting the Relay switch
  - Resetting the Blind control switch

When reset is done successfully. The Wireless switch and device returns to factory default.

- Integrating into Wiser System
  - If you wish to integrate the devices into Wiser System, reset all the devices in Quick Home Connect and pair it to Wiser Hub, for more information refer to pairing the device with Wiser Hub.

## LED Indications in Quick Home Connect

### Pairing the device in Quick Home Connect

User Action	LED Indication	Status
Press the push button 5 times in quick succession.	LED blinks green, once per second. 	Pairing mode is active for 60 seconds. When pairing is completed, LED stops blinking. 

## Troubleshooting in Quick Home Connect

Symptom	Possible cause	Solution
LED displays amber on the device.	Pairing not completed and returned to factory default.	<p>Pair the Wireless switch and the device again.</p> <p>Refer to</p> <ul style="list-style-type: none"> <li>• Micro module light switch, page 11</li> <li>• Micro module shades control, page 12</li> <li>• Multiwire micro module dimmer, page 12</li> <li>• Rotary dimmer, page 14</li> <li>• Push-button dimmer, page 14</li> <li>• Socket outlet, page 15</li> <li>• Relay switch, page 15</li> <li>• Blind control switches, page 16</li> </ul>
Wireless switch not able to control the device reliably.	The Wireless switch and the device are too far away from each other.	Place the Wireless switch in a position closer to the device.
	The Wireless switch lost pairing.	<p>Pair the device again.</p> <p>Refer to</p> <ul style="list-style-type: none"> <li>• Micro module light switch, page 11</li> <li>• Micro module shades control, page 12</li> <li>• Multiwire micro module dimmer, page 12</li> <li>• Rotary dimmer, page 14</li> <li>• Push-button dimmer, page 14</li> <li>• Socket outlet, page 15</li> <li>• Relay switch, page 15</li> <li>• Blind control switches, page 16</li> </ul>
	The Wireless switch battery is discharged.	Replace the battery of the Wireless switch



Scenario	Procedure
Control multiple devices with one Wireless switch.	To control multiple devices with a single Wireless switch, start by pairing it with one device. Then, use the same Wireless switch to pair with additional devices. <b>NOTE:</b> You can pair up to 7 devices to a single Wireless switch.
1-gang Wireless switch with devices (relay switch, dimmer, shutter control, or socket outlet).	Pair the Wireless switch with any of the devices (relay switch, dimmer, shutter control, or socket outlet).
2-gang Wireless switch with devices (relay switch, dimmer, shutter control, or socket outlet).	Pair either left or right Wireless switch with any of the devices (relay switch, dimmer, shutter control, or socket outlet). You can also pair another rocker of the Wireless switch with another device.

## Pairing the device with the Wiser Hub

You can pair your Wireless switch with the **Wiser Hub** to access and control it.

**NOTE:** You can change the Wireless switch from 1-gang to 2-gang during commissioning. If the Wireless switch is already configured to 1-gang and you want to change it to 2-gang, then reset the device (1-gang), refer to [Resetting the device](#) and commission it again with 2-gang.

To Pair the Wireless switch:

1. On the **Home** screen, tap .
2. Tap **Devices** >  > **Appliances** > **1-gang Connected Wireless Switch / 2-gang Connected Wireless Switch**.

**TIP:** You can also navigate by tapping **Control** >  > **Appliances** > **1-gang Connected Wireless Switch / 2-gang Connected Wireless Switch**.

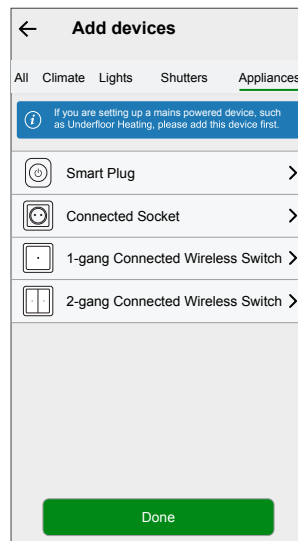

**TIP:** For 1-gang/2-gang Wireless switch, 2/4 push buttons are available for operation.

3. Tap **Scan QR code** and allow the Wiser Home app to access your camera. Then, scan the QR code located on the device.

**NOTE:** If you are unable to find the correct QR code, tap **I can't find the correct QR code** to pair the device manually and proceed to step 4.

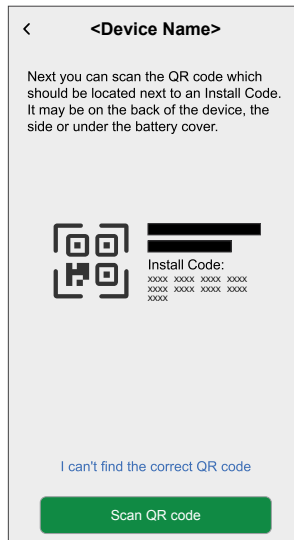

If the QR code is incorrect, a message **Incorrect QR code scanned** will appear. Tap **I can't scan the QR code** and choose one of the following options:

- **(A):** Enter the MAC Address and Install Code, then tap **Connect**. The app will verify if the MAC address and Install code are valid.
- **(B):** Tap this option if you are unable to find the MAC address and Install code.

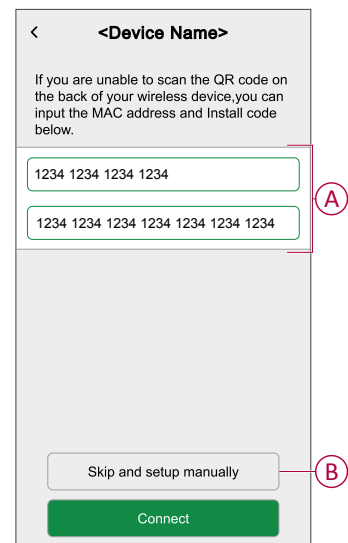

- 4. Tap **Next** and short press the top-right push button 3 times and make sure that the LED blinks amber.

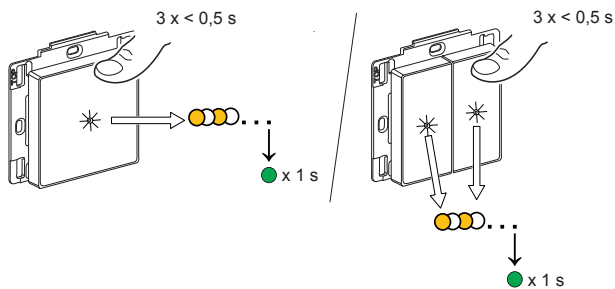

Wait for a few seconds until the LED turns green and the app confirms that the device is joined.

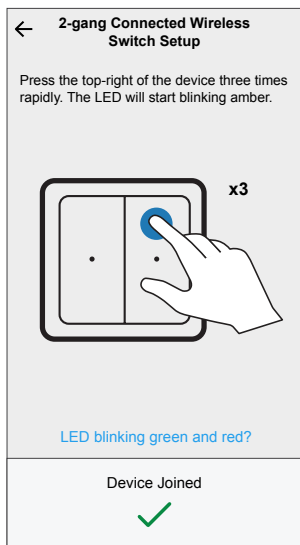

**NOTE:** If the LED is blinking green and red, see the instructions by tapping **LED blinking green and red?** or refer to the Troubleshooting, page 36 topic.

5. Tap **Next** to enter the name of the device and assign the device to a new room or an existing room. Then, tap **Submit**.

After you pair the device, a success screen appears with the following options:

- **+ Add New Device:** Tap to continue pairing more devices.
- **Start Using Your Device:** Tap to start using the paired device.

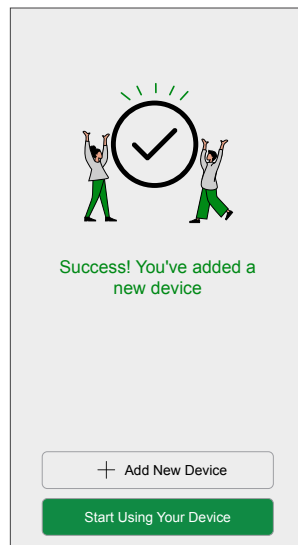

**NOTE:** The success screen appears only if you are logged in as a **Home Owner**.

The Wireless switch is now listed on the **Control** tab under the **All** and **Room** tabs.

**Hint:**

- If the Wireless switch is configured as 2-gang, and you wish to switch it to 1-gang, you must reset the device and pair it again as a 1-gang.
- If the Wireless switch is configured as 1-gang, and you wish to switch it to 2-gang, you must reset the device and pair it again as a 2-gang.

For more information, refer to [Resetting the device](#), page 28.

## Configuring the device

The **Device Details** screen allows you to configure the device settings according to your preferences.

1. On the **Home** screen, tap .
2. Tap **Devices > Appliances > 1-gang Connected Wireless Switch / 2-gang Connected Wireless Switch**.

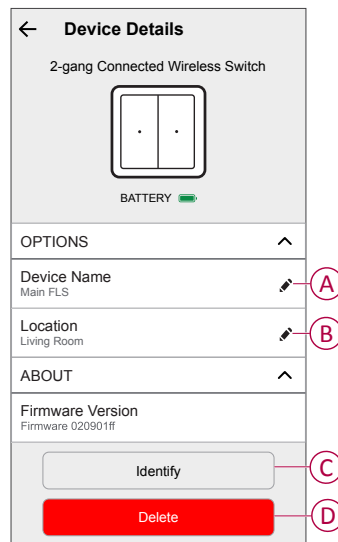

<b>A</b>	<b>Device Name:</b> Tap to change the name of the device. For more information, refer to <a href="#">Renaming the device</a> , page 26.
<b>B</b>	<b>Location:</b> Tap to assign the Device to any room (such as living room, bedroom, kitchen etc). Refer to <a href="#">Setting the device location</a> , page 25 for more details on how to set the location.
<b>C</b>	<b>Identify:</b> Tap to identify the device. The status LED blinks red and connected lighting devices blinks on/off, upon successful identification of the switch. Tap <b>OK</b> when you finish identifying the device. For more information, refer to <a href="#">Identifying the device</a> , page 27.
<b>D</b>	<b>Delete:</b> Tap to remove the device from the system. <b>NOTE:</b> <ul style="list-style-type: none"> <li>• Removing the device will also reset the Wireless switch. After reset, the LED turns amber indicating that the Wireless switch is ready for pairing.</li> <li>• If there is a problem while pairing or resetting the switch, refer to <a href="#">Resetting the device</a>, page 28.</li> </ul>

## Setting the device location

You can add your Wireless Switch to any room (such as bedroom, living room, dining room etc.).

To add a Wireless Switch to a room:

1. On the **Home** screen, tap .

2. Tap **Devices > 2-gang Connected Wireless Switch > Location (A)** to assign the Wireless Switch to an existing room or a new room (B) and tap **Submit**.

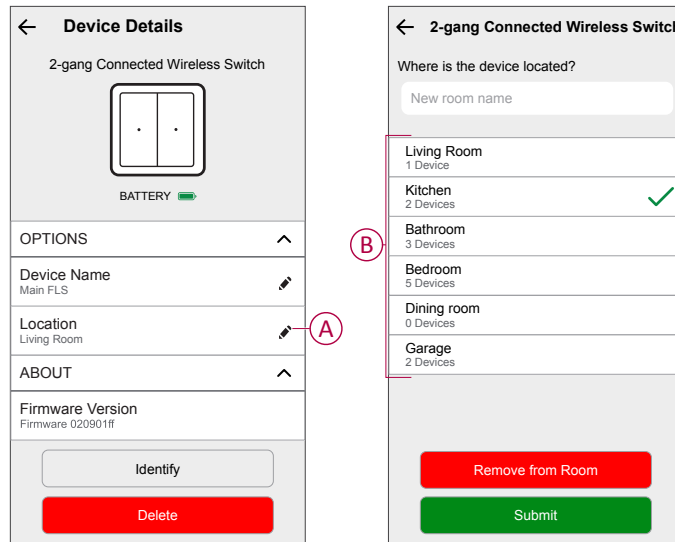

## Renaming the device

1. On the **Home** screen, tap .
2. Tap **Devices > 2-gang Connected Wireless Switch > Device Name (A)** to enter a new name.

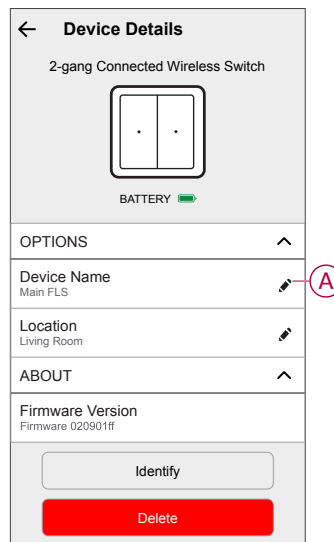

## Identifying the device

Using the Wiser Home app, you can identify a Wireless switch from the other available devices in the room.

To identify the Wireless switch:

1. Short press the top-right push button 3 times in quick succession.  
The Wireless switch wakes up for a minute and the status LED blinks green 5 times and then stops.

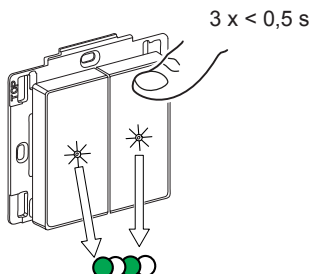

2. On the **Home** screen, tap  > **Devices** > **2-gang Connected Wireless Switch** > **Identify (A)**.

The status LED blinks green upon successful identification of the Wireless switch.

**NOTE:** It can take up to a minute for the Wireless switch to indicate the status LED.

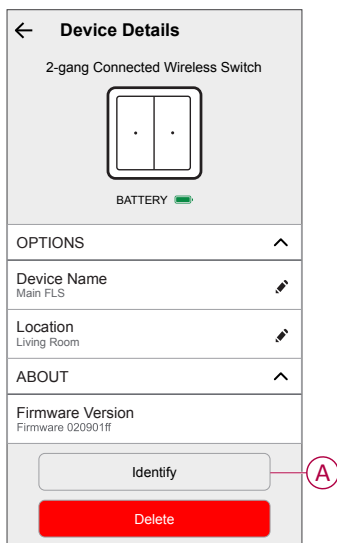

3. Tap **OK** when you have finished identifying the Wireless switch.

## Removing the device from the system

You can remove the Wireless switch from the Wiser system.

1. On the **Home** screen, tap .
2. Tap **Devices > 2-gang Connected Wireless Switch > Delete (A)**.

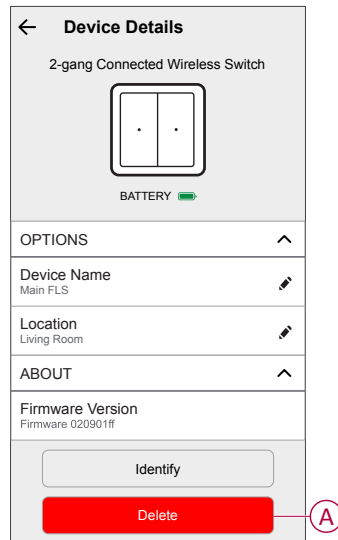

**NOTE:** By removing the device, it is reset to factory default.

**TIP:** If the device is still in the system, reset the device manually. Refer to reset the device, page 28.

## Resetting the device

You can reset the Wireless switch to factory default manually under the following conditions:

- When the Hub is replaced.
- When Switching from 1-gang to 2-gang or vice versa.

To reset the Wireless switch:

1. Short press the top-right push button 3 times ( $< 0.5$  s) and then press and hold the push button ( $> 10$  s).

After 10 s, the status LED blinks red.

2. Release the push button.
  - The status LED stops blinking upon successful reset of the device.
  - The Wireless switch restarts and blinks green for few seconds. After reset, the status LED turns off.

**NOTE:** All configuration data, user data, and network data are deleted.

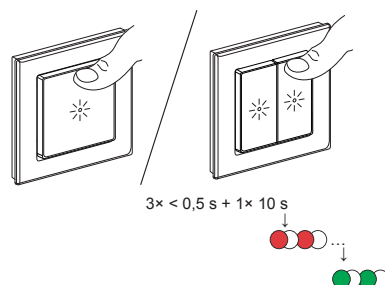

## Using the device

The Device Control Screen allows you to configure an Action/Moment to the Wireless switch and control various settings.

On the **Control** tab, select the Wireless switch.

The Device Control Screen displays the following options:

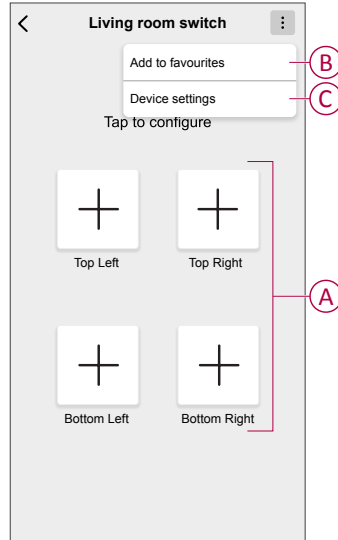

<b>A</b>	Tap to configure an Action/Moment to the Wireless switch, such as turning on/off the lights, moving the shutter up or down, or any combination. For more information, refer to the following topics: <ul style="list-style-type: none"> <li>• Assigning an Action to the Wireless switch, page 29</li> <li>• Assigning a Moment to the Wireless switch, page 32</li> </ul>
<b>B</b>	Tap to add the device to the <b>Favourite devices</b> section on the <b>Home</b> screen. To know more about <b>Favourite</b> , refer to <b>Managing Favourites</b> in the respective System User Guide.
<b>C</b>	Tap to open the <b>Device Settings</b> screen and configure the settings. For more information, refer to <b>Configuring the device</b> , page 25.

## Assigning an Action to the Wireless switch

You can configure an Action to the Wireless switch (such as turning on/off the lights, moving the shutter up or down or any combination).

To configure an Action to the Wireless switch:

1. On the **Control** tab, tap **All devices** or the room tab where the Wireless switch is located.

2. Tap any key and select **Action**.

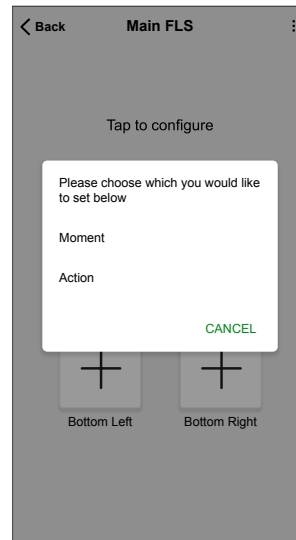
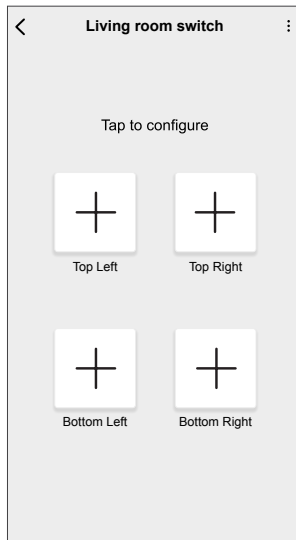

3. Select the device and tap **Select Action**.

4. On the **Configure Device** screen, select the **Light Switch**.

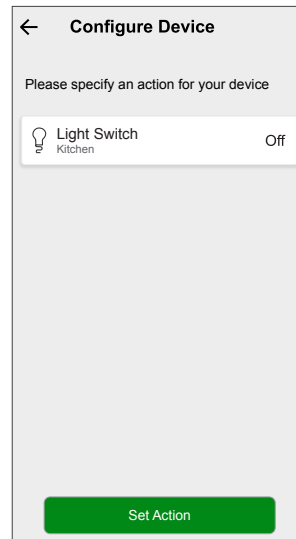
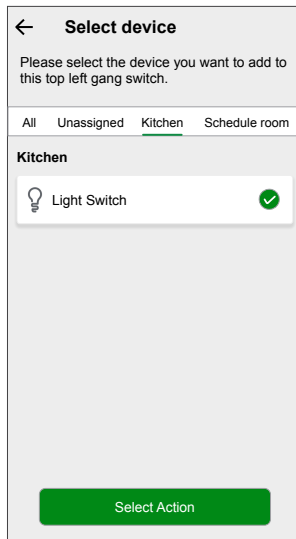

5. Tap  to turn on the light and tap **Set > Set Action**.

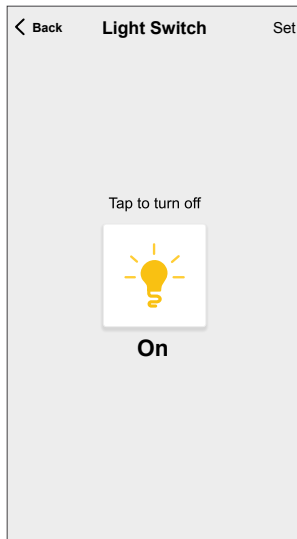

In the next screen, ✓ shows that the Action is successfully configured. The **Top Left** key is configured with **Light Switch: On**.

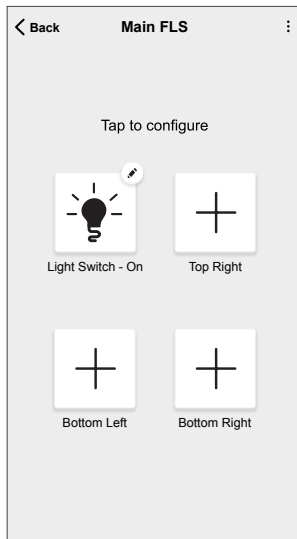

**TIP:** When assigning a push button to control a dimmer or a shutter, it is important to know that you can set a specific percentage for brightness or shutter position. For example, if you configure a dimmer to 50%, short pressing the push button will turn on the light directly at 50% brightness. Similarly, for shutters, you can set a position to 30% open. When you short press the push button, the shutter will automatically move to that position.

**NOTE:** Pressing and holding the push button cannot dim the light or open/close the shutter. Only short press actions are supported in the Wireless switch.

## Controlling the device with Push Buttons

After assigning an Action/Moment to the Wireless switch, you can operate it by pressing the push buttons.

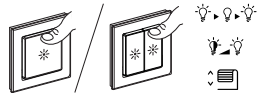

### Light

Short press the assigned push button on the Wireless switch (< 0,5 s) to turn the light on/off, or set it to a specific brightness level ( for dimmers only).

### Shutter

Short press the assigned push button on the Wireless switch (< 0,5 s) to open/ close the shutter to the configured percentage.

### Moment

Short press the assigned push button to activate a Moment.

**TIP:** You can configure the Wireless switch push buttons with Action/Moment using the app.

## Assigning a Moment to the Wireless switch

A Moment allows you to group multiple actions that are usually done together. You can configure a Moment to the Wireless switch (such as Good Night Moment: Fan on, light dimming 50%, shutter close).

**TIP:** A moment can be assigned to any of the four keys individually.

To configure a Moment to the Wireless switch:

1. On the **Control** tab, tap **All** devices or the room tab where the Wireless switch is located.
2. Tap any key and select **Moment**.

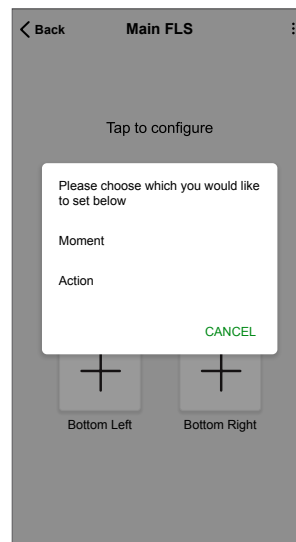
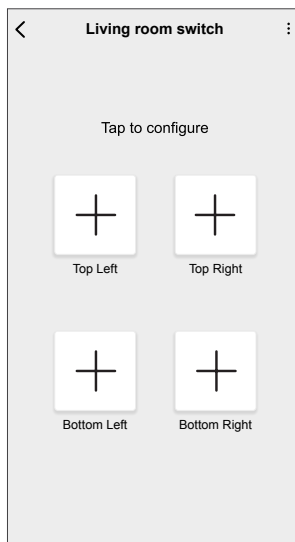

3. Select a Moment which you want to add to the key and tap **Select Moment**.

In the next screen, ✓ shows the Moment is successfully configured.

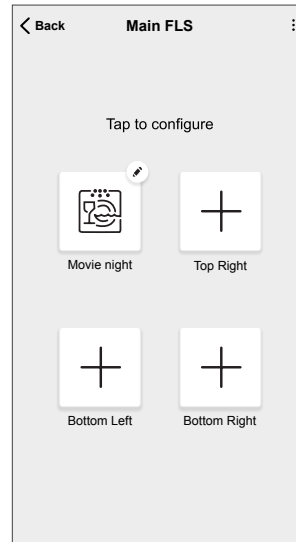
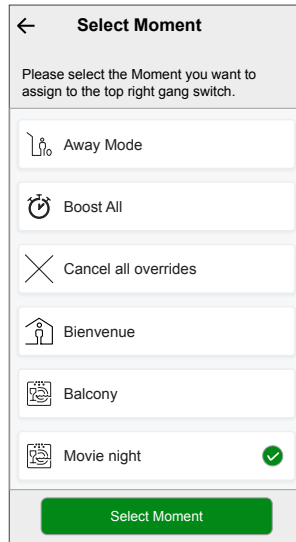

## Removing configured Action/Moment

You can remove the configured Action or Moment from the Wireless switch key.

To remove the configured Action/Moment:

1. On the **Control** tab, tap **All** devices or the room tab where the Wireless switch is located.
2. Tap the key with the Action/Moment you want to remove, and then tap **Delete** > **YES, I'M SURE** to remove it from the Wireless switch key.

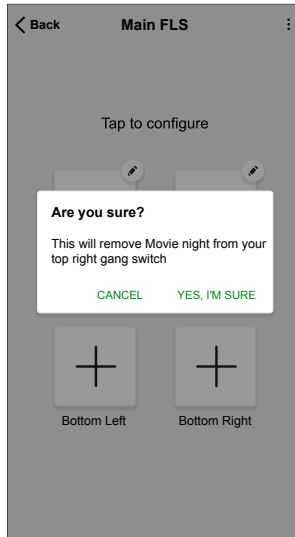

## Replacing the battery

Replace the device battery when the level is low or critically low. The battery level can be seen in the app.

Follow the steps to replace the battery from the device:

### ⚠ WARNING

#### CHEMICAL BURN HAZARD

Keep batteries out of reach of children. If swallowed, seek immediate medical attention.

**Failure to follow these instructions can result in death, serious injury, or equipment damage.**

### NOTICE

#### EQUIPMENT DAMAGE

The device is locked on the fixing plate with retaining claws. Never pull the device before sliding it upwards.

**Failure to follow these instructions can result in equipment damage.**

**NOTE:** The battery lid is designed with lock system.

1. Remove the device from the fixing plate by sliding it upwards.
2. Rotate the device by 180° to access the battery cover.
3. Press and hold the battery cover with your thumb.
4. Slide the battery cover with another thumb to remove.
5. Remove the old battery, then press any push button on the device for a few seconds to reboot it and delete the internal low battery flag.

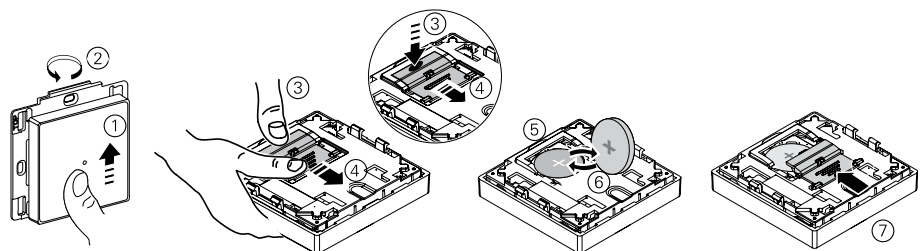

**NOTE:** Dispose the used batteries, as per statutory regulations.

6. Insert the battery with plus (+) symbol facing outward
7. Secure the battery cover.





## LED indications

### Pairing the device

User Action	LED Indication	Status
Press the top-right push button 3 times.	LED blinks orange, once per second. 	Pairing mode is active for 30 seconds. When pairing is completed, LED displays solid green for a few seconds, before turning off. 



### Resetting the device

User Action	LED Indication	Status
Press the push button 3 times and hold it down once for > 10 s.	LED blinks red, once per second. 	The device is in reset mode. The device then restarts and the LED starts blinking green, before turning off. 

### Battery level

LED Indication	Status
LED blinks red once, when a push button is pressed. 	The battery is low (< 10%). Replace the Wireless switch battery, page 35. <b>NOTE:</b> A notification pop-up will appear on the app.

## Troubleshooting

Symptom	Possible cause	Solution
LED blinks red.	The Wireless switch battery is low or drained.	Replace the Wireless switch battery, page 35. <b>NOTE:</b> A notification pop-up will appear in the app.
The Wireless switch displays offline in the app.	The Wireless switch battery is low or drained.	Replace the Wireless switch battery, page 35.
	The Wireless switch is disconnected from the network.	Press any push button on the Wireless switch. <b>NOTE:</b> The first press does not trigger Wireless switch operation.
The device is not able to connect with the Hub. After pressing top-right push button 3 times, the device LED blinks red/green for 30 s. 	Pairing mode has changed to Bluetooth mode.	Press the top-right push button on the device 3 times, hold it for 20 s until the LED blinks red, and the device reboots into the correct mode (Zigbee mode). 

## Technical Data

Battery	CR2032
Battery life	Up to 5 years (depending on frequency of use and quality of battery)
IP rating	IP20
Operating frequency	2405-2480 MHz
Max. radio-frequency power transmitted	<10 mW
Operating temperature	-5 °C to 45 °C

Relative humidity	5% to 95%
Communication protocol	Zigbee 3.0

Schneider Electric  
35 rue Joseph Monier  
92500 Rueil Malmaison  
France

+ 33 (0) 1 41 29 70 00

[www.se.com](http://www.se.com)

As standards, specifications, and design change from time to time, please ask for confirmation of the information given in this publication.

© 2025 – 2025 Schneider Electric. All rights reserved.

DUG\_Exxact\_Wireless Switch\_WH-04