

Installation Instructions

REGISTERED DESIGN • REGISTERED PATENT

Product Range

TPHBM3	LED Highbay, 150 W, 5000 K, IP65, c/w flex and plug, with 110° Lens
--------	---

Installation Requirements

DANGER

RISK OF ELECTRIC SHOCK, EXPLOSION OR ARC FLASH

- This product must only be installed and serviced by appropriately qualified and/or licenced electrical personnel.
- Isolate the electrical supply before doing any work on this product.
- Ensure that the product has been correctly installed and tested for safe operation before reconnecting the electrical supply.

Failure to follow these instructions will result in death or serious injury.

CAUTION

RISK OF BURN INJURIES

During and after use, the product may be hot. Do not touch the product until it has completely cooled down.

Failure to follow these instructions can result in minor injuries or equipment damage.

- The product is Class 1.
- Check whether the product has been damaged during transport. Do not operate/install any product which appears damaged in any way. Return the complete product to the place of purchase for inspection, repair or replacement.
- Take care not to pull any electrical wires during unpacking as this may damage the connections.
- There are no serviceable parts inside the product.

Installation Instructions

Option 1: Ceiling installation using mounting hook

- ① Isolate mains power.
- ② Select suitable location for installation.
NOTE: Do not use the power cable to support the weight of the Highbay during and/or after mounting.
- ③ Attach enclosed mounting hook (A) (if not fitted) and screw to a torque setting of 8.5 Nm.
- ④ Ensure mounting method (B) is of suitable weight rating to be able to support the Highbay.
- ⑤ Attach safety chain shown at (C).
- ⑥ Connect mains power to the Highbay.

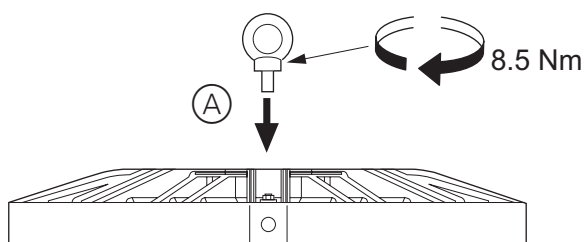

Example of a Highbay installation

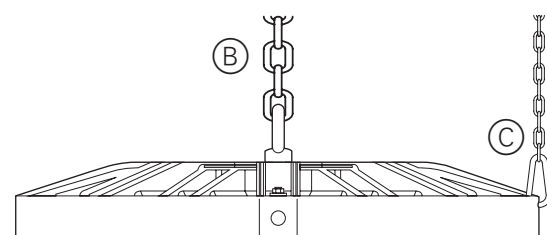

Option 2: Ceiling, wall or floor installation using mounting bracket

- ① Isolate mains power.
- ② Select suitable location for installation.
NOTE: Location must provide a minimum of 1 m between Highbay lens and any surface.
- ③ Attach enclosed mounting bracket (A) (if not fitted).
- ④ Ensure mounting point (B) is of suitable weight rating to be able to support the Highbay.
- ⑤ Fasten the bracket to the mounting point via the three holes provided (C).
- ⑥ Adjust the highbay to the desired angle.
- ⑦ Connect mains power to the Highbay.

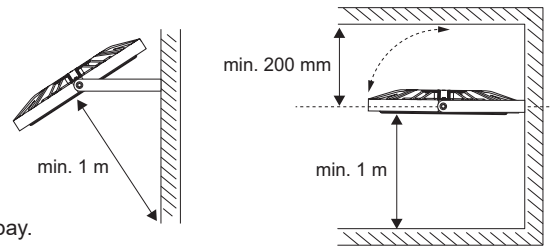
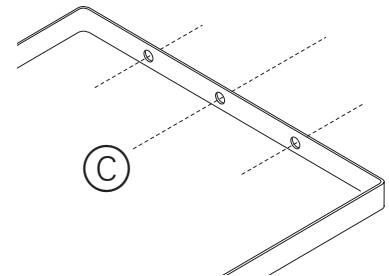
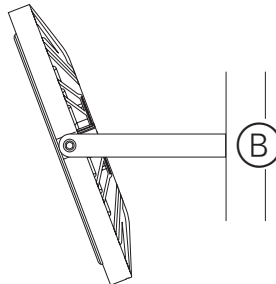
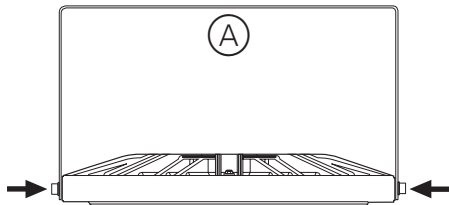

Product Specification

Parameter	TPHBM3
Voltage Rating	240 V a.c. 50 Hz
Total Power Consumption	150 W
Lumens	15,000 lm
Colour Temperature	5000 K
Colour Rendering Index	>70
IP Rating	IP65
Lifespan	30,000 hrs
Beam Angle	110°
Weight	5.2 kg
Operating Temperature	-10 °C to +45 °C
Operating Humidity	+10 to +95% RH, non-condensing
Storage Temperature	-10 °C to +60 °C
Storage Humidity	+10 to +95% RH, non-condensing
Dimensions (mm)	380 mm diameter 99.5 mm height (with mounting hook) 220 mm height (with mounting bracket)
Cord Length	2 m

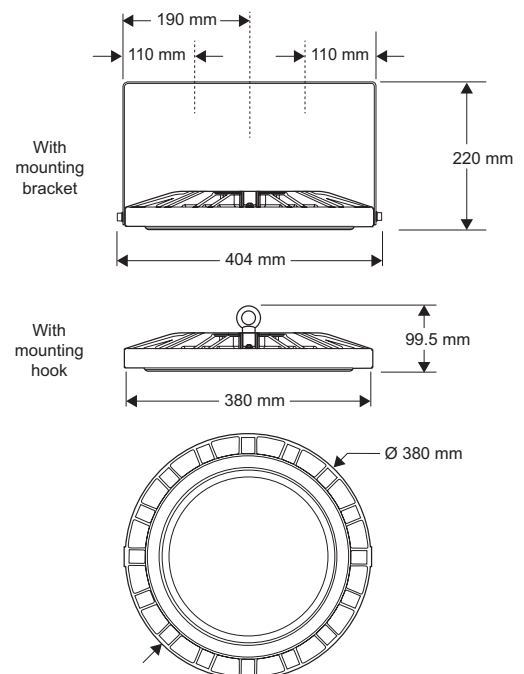

Warranty

For warranty information refer to www.clipsal.com/warranty

CLIPSAL®

by Schneider Electric

New Zealand

Schneider Electric (NZ) Ltd

38 Business Parade South, Highbrook,
East Tamaki, Manukau 2013
P.O. Box 259370 Botany, Manukau 2163
Telephone +64 9-829 0490

After hours service hotline:
0800 735 4357 (New Zealand only)

Customer Care NZ: **0800 652 999**

Email: sales@nz.schneider-electric.com

Australia

Schneider Electric (Australia) Pty Ltd

Customer Care Australia: **1300 369 233**

Email: customercare.au@schneider-electric.com

www.schneider-electric.com

F2841/00

clipsal.com



Schneider Electric reserves the right to change specifications, modify designs and discontinue items without incurring obligation and whilst every effort is made to ensure that descriptions, specifications and other information in this catalogue are correct, no warranty is given in respect thereof and the company shall not be liable for any error therein.

© Schneider Electric 2017

This material is copyright under Australian and international laws. Except as permitted under the relevant law, no part of this work may be reproduced by any process without prior written permission of and acknowledgement to Schneider Electric. Schneider Electric acknowledges that the Australian Standard Certified Product logo is a trademark of SAI Global.

October 2017