

---

# Telemecanique Sensors Algılama Bileşenleri Panorama 2024



# Telemecanique Sensors

TM

Telemecanique Sensors markası, fabrika otomasyon ve emniyet sensörleri üretiminde 90 yıllık geçmişe sahiptir. Telemecanique'in kapsamlı serileri, piyasadaki en güvenilir ve dayanıklı ürünlerdir, dolayısıyla piyasanın lideridir.



3 değere bağlı ürün tasarlar **Sadelik, Yakınlık ve Uzmanlık** –  
Hedefimiz, temel değerlerine ve makine performanslarına odaklanmalarını sağlayarak  
müşterilerimizin hayatını kolaylaştırmaktır!

Tüm sensör ürünlerimizi keşfetmek için internet sayfamızı ziyaret edin  
[www.telemecaniquesensors.com/tr](http://www.telemecaniquesensors.com/tr)

Telemecanique Sensors, paketlenme segmenti için otomatik montaj hatlarına yerleştirilmek üzere genişletilmiş XU uygulamaya özel foto-elektrik sensör serisini sunar. Çeşitli teknik özellikleri, yüksek performansları ve akıllı yönetim kabiliyetleri ile geniş bir yelpazedeki özel ihtiyaçları karşılamak üzere tasarlanmıştır.



## Uygulamaya özel sensör serisi

- > Kontrast algılama
- > Koyu ve ışığı emen cisimlerin algılanması
- > Güvenilir algılama
- > Basit renklerden komplike renk uygulamalarına kadar renk algılama
- > Reflektör veya reflektörsüz şeffaf nesne algılama



Lazer



Kırmızı Işık



Beyaz Işık



Mavi Işık



RGB

5 farklı ışık kaynağı

### Gövde, bağlantı tipi ve boyutunu seçin

- > Plastik veya metal
- > Kablolı veya konnektörlü
- > Minyatür, sub minyatür veya kompakt



IO-Link aracılığıyla akıllı sensör işlevlerini etkinleştirin



### Akıllı cihazlar IO-Link protokolü üzerinden iletişim kurar

- > Yeni IO-Link sensörünüzü kolayca kurun: cihaz tanımlama dosyasının (IODD) otomatik olarak okunması ve sensör çıkış modunun otomatik olarak algılanması
- > Otomatik parametre ayarları: algılama parametrelerini yapılandırın
- > Optimize edilmiş kullanım ve bakım için gerçek zamanlı bilgilerle genişletilmiş diyagnostik



## Spot Işık

## Fotoelektrik Sensör XUM XUB XUN

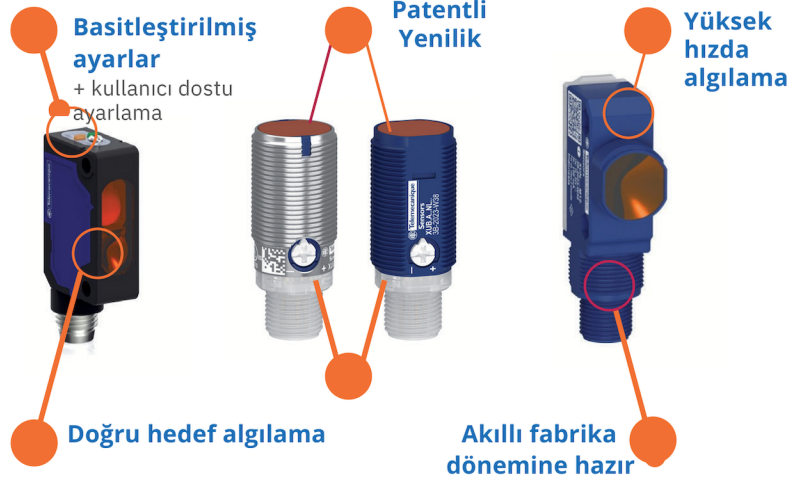

\*" Karşılıklı" sensörlerin üzerine yerleştirilen ve 30 metreye kadar ulaşan küçük reflektör, kullanıcının sensörleri 4 dakikadan daha kısa sürede hizalamasını sağlar (daha önce 15 dakika idi). Bu da kurulum süresini 3 kat azaltmaktadır!

# Basınç Şalterleri: XM Serisi



XMLP Elektronik Verici	Hidrolik yağlar, hava, tatlı su		Analog çıkış		
	-30...+85° C		4...20 mA	0...10 V	0.5...4.5 V
M12 4 pin (erkek)	Bar	psi			
	-1	-14.5	XMLPM00GD21F	XMLPM00GD71F	XMLPM00GD11F
	1	14.5	XMLP001GD21F	XMLP001GD71F	XMLP001GD11F
	6	87	XMLP006GD21F	XMLP006GD71F	XMLP006GD11F
	10	145	XMLP010BD21F	XMLP010BD71F	XMLP010BD11F
	16	232	XMLP016BD21F	XMLP016BD71F	XMLP016BD11F
	25	362	XMLP025BD21F	XMLP025BD71F	XMLP025BD11F
	40	580	XMLP040BD21F	XMLP040BD71F	XMLP040BD11F
	60	870	XMLP060BD21F	XMLP060BD71F	XMLP060BD11F
	100	1450	XMLP100BD21F	XMLP100BD71F	XMLP100BD11F
	160	2320	XMLP160BD21F	XMLP160BD71F	XMLP160BD11F
	250	3625	XMLP250BD21F	XMLP250BD71F	XMLP250BD11F
	400	5800	XMLP400BD21F	XMLP400BD71F	XMLP400BD11F
G 1/4A (erkek)	600	8700	XMLP600BD21F	XMLP600BD71F	XMLP600BD11F

ZMLP Ekran ve Anahtar	4-20mA analog + ayırık çıkış		2 ayırık çıkış	
	NA/NK Programlanabilir		NA/NK Programlanabilir	
M12 4 pin (erkek)	Pencere	Histeresiz	Sabit Histeresiz	
PNP	ZMLPA1P2SW	ZMLPA1P2SH	ZMLPA2P0SH	

Sadece 4-20mA analog çıkışlı transmitterlerle kullanılabilir.

Hızlı Sabitleme Braketi

Yatay Plan

Dükey Plan veya Boru

XMLPZLH01

XMLPZLV01

Kablo bağlantısı XM	Konnektörler (dişi)		PUR hazır kablolu konnektörler (dişi) (3)			PUR Jumper kabloları		
	M12	düz	düz	dirsekli	dirsekli PNP LED	M12 (dişi)	düz	dirsekli
(1)	4 pin	XZCC12FDM40B	XZCP1141L2	XZCP1241L2	XZCP1340L2	M12 (erkek)	düz	düz
(2)	4 pin	XZCC12FDP40B	XZCP1141L5	XZCP1241L5	XZCP1340L5	4 pin	1m	XZCR1511041C1
(1)	5 pin	XZCC12FDM50B	XZCP1141L10	XZCP1241L10	XZCP1340L10	2 m	XZCR1511041C2	XZCR1512041C1

(1) Çelik halka (2) Plastik halka

(3) Bir PVC kabloda, P harfinin ardından V harfi gelir, örneğin: XZCPxxxxx, XZCPVxxxxx olur.



# Basınç şalterleri: XM Serisi

Seçin



XMLA / XMLB Elektromekanik Vidalı terminal	Hidrolik yağlar, hava, tatlı su, deniz suyu sıcaklığı: 70°C'ye kadar						
	1 K/A tek kutuplu kontak sabit diferansiyel			1 K/A tek kutuplu kontak ayarlanabilir diferansiyel			
Bar	psi	ISO M20	Pg13	DIN konnektörü	ISO M20	Pg13	DIN konnektörü
-1	-14.5	XMLAM01V2S12	XMLAM01V2S11	XMLAM01V2C11	XMLBM02V2S12	XMLBM02V2S11	XMLBM02V2C11
2.5	36.3	XMLA002A2S12	XMLA002A2S11	XMLA002A2C11	XMLB002A2S12	XMLB002A2S11	XMLB002A2C11
4	58	XMLA004A2S12	XMLA004A2S11	XMLA004A2C11	XMLB004A2S12	XMLB004A2S11	XMLB004A2C11
10	145	XMLA010A2S12	XMLA010A2S11	XMLA010A2C11	XMLB010A2S12	XMLB010A2S11	XMLB010A2C11
20	290	XMLA020A2S12	XMLA020A2S11	XMLA020A2C11	XMLB020A2S12	XMLB020A2S11	XMLB020A2C11
35	508	XMLA035A2S12	XMLA035A2S11	XMLA035A2C11	XMLB035A2S12	XMLB035A2S11	XMLB035A2C11

Hidrolik yağlar / Sıcaklık: 160°C'ye kadar							
Bar	psi	ISO M20	Pg13	DIN konnektörü	ISO M20	Pg13	DIN konnektörü
1	14.5	XMLA001R2S12	XMLA001R2S11	XMLA001R2C11	XMLB001R2S12	XMLB001R2S11	XMLB001R2C11
70	1015	XMLA070D2S12	XMLA070D2S11	XMLA070D2C11	XMLB070D2S12	XMLB070D2S11	XMLB070D2C11
160	2320	XMLA160D2S12	XMLA160D2S11	XMLA160D2C11	XMLB160D2S12	XMLB160D2S11	XMLB160D2C11
300	4350	XMLA300D2S12	XMLA300D2S11	XMLA300D2C11	XMLB300D2S12	XMLB300D2S11	XMLB300D2C11
500	7250	XMLA500D2S12	XMLA500D2S11	XMLA500D2C11	XMLB500D2S12	XMLB500D2S11	XMLB500D2C11

XMLR Elektronik + Ekran	Hidrolik yağlar, hava, tatlı su, soğutma sıvıları			
	-20... +80° C			
M12 4 pin veya 5 pin	Analog çıkış		Analog + 2 ayrı çıkış	
	Bar	psi	4...20 mA	0...10 V
-1	-14.5	XMLRM01G0T25	XMLRM01G0T75	XMLRM01G2P25
1	14.5	XMLR001G0T25	XMLR001G0T75	XMLR001G2P25
2.5	35.2	XMLR2D5G0T25	XMLR2D5G0T75	XMLR010G2P25
10	145	XMLR010G0T25	XMLR010G0T75	XMLR016G2P25
16	232	XMLR016G0T25	XMLR016G0T75	XMLR040G2P25
25	362	XMLR025G0T25	XMLR025G0T75	XMLR250M2P25
40	580	XMLR040G0T25	XMLR040G0T75	XMLR400M2P25
100	1450	XMLR100M0T25	XMLR100M0T75	
160	2320	XMLR160M0T25	XMLR160M0T75	
250	3625	XMLR250M0T25	XMLR250M0T75	
400	5800	XMLR400M0T25	XMLR400M0T75	
600	8700	XMLR600M0T25	XMLR600M0T75	

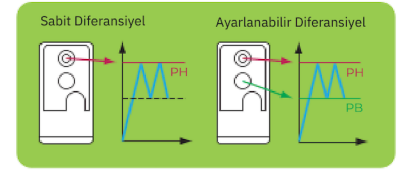

XMLR	Hidrolik yağlar, hava, tatlı su, soğutma sıvıları			
	-20... +80° C			
M12 4 pin veya 5 pin	Analog + 2 ayrı çıkış		2 ayrı çıkış	
	Bar	psi	4...20 mA	0...10 V
-1	-14.5	XMLRM01G1P25	XMLRM01G1P75	XMLRM01G2P05
1	14.5	XMLR001G1P25	XMLR001G1P75	XMLR001G2P05
2.5	35.2	XMLR2D5G1P25	XMLR2D5G1P75	XMLR2D5G2P05
10	145	XMLR010G1P25	XMLR010G1P75	XMLR010G2P05
16	232	XMLR016G1P25	XMLR016G1P75	XMLR016G2P05
25	362	XMLR025G1P25	XMLR025G1P75	XMLR025G2P05
40	580	XMLR040G1P25	XMLR040G1P75	XMLR040G2P05
100	1450	XMLR100M1P25	XMLR100M1P75	XMLR100M2P05
160	2320	XMLR160M1P25	XMLR160M1P75	XMLR160M2P05
250	3625	XMLR250M1P25	XMLR250M1P75	XMLR250M2P05
400	5800	XMLR400M1P25	XMLR400M1P75	XMLR400M2P05
600	8700	XMLR600M1P25	XMLR600M1P75	XMLR600M2P05



Kablo Bağlantısı XM	Konnektörler (dişi)			PUR hazır kablolu konnektörler (dişi) (3)				PUR Jumper kabloları				
	M12	düz	dirsekli	M12	düz	dirsekli	dirsekli PNP LED	M12 (dişi)	düz	dirsekli		
(1)	4 pin	XZCC12FDM40B	XZCC12FCM40B	4 pin	2 m	XZCP1141L2	XZCP1241L2	XZCP1340L2	M12 (dişi)	düz	dirsekli	
(2)	4 pin	XZCC12FDP40B	XZCC12FCP40B		5 m	XZCP1141L5	XZCP1241L5	XZCP1340L5	M12 (erkek)	düz	düz	
(1)	5 pin	XZCC12FDM50B	XZCC12FCM50B		10 m	XZCP1141L1	XZCP1241L10	XZCP1340L10	4 pin	1 m	XZCR1511041C1	XZCR1512041C1
										2 m	XZCR1511041C2	XZCR1512041C2

(1) Çelik halka (2) Plastik halka

(3) Bir PVC kabлда, P harfinin ardından V harfi gelir, örneğin: XZCPxxxxx, XZCPVxxxxx olur.

# Nihayet şalterleri: XC Serisi

Seçin: 1 > 2 > 3 > 4 > Referans

Gövde Kafa Kontak Bağlantı



Model	Malzeme	Kafa	Kontak	1	2	3	4	5	6
XCKD	Metal	NA+NK Ani hareketli	M16	XCKD2110P16	XCKD2102P16	XCKD2121P16	XCKD2106P16	XCKD2118P16	XCKD2145P16
		Pg11	XCKD2110G11	XCKD2102G11	XCKD2121G11	XCKD2106G11	XCKD2118G11	XCKD2145G11	
		M12 5P	XCKD2110M12	XCKD2102M12	XCKD2121M12	XCKD2106M12	XCKD2118M12	XCKD2145M12	
XCKP	Plastik	NA+NK Ani hareketli	M16	XCKP2110P16	XCKP2102P16	XCKP2121P16	XCKP2106P16	XCKP2118P16	XCKP2145P16
		Pg11	XCKP2110G11	XCKP2102G11	XCKP2121G11	XCKP2106G11	XCKP2118G11	XCKP2145G11	
		M12 4P	XCKP2110M12	XCKP2102M12	XCKP2121M12	XCKP2106M12	XCKP2118M12	XCKP2145M12	
XCKT	Plastik	NA+NK Ani hareketli	M16	XCKT2110P16	XCKT2102P16	XCKT2121P16	XCKT2106P16	XCKT2118P16	XCKT2145P16
		Pg11	XCKT2110G11	XCKT2102G11	XCKT2121G11	XCKT2106G11	XCKT2118G11	XCKT2145G11	

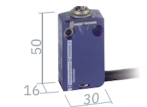

Model	Malzeme	Kafa	Kontak	1	2	3	4	5	6	
XCMD	Metal	NA+NK Ani	1 m	XCMD2110L1	XCMD2102L1	XCMD2124L1	XCMD21F0L1	XCMD21F2L1	XCMD2115L1	XCMD2116L1
		NA+NK Yavaş	1 m	XCMD2510L1	XCMD2502L1	XCMD2524L1	XCMD25F0L1	XCMD25F2L1	XCMD2515L1	XCMD2516L1
		NA+NK Ani	M12 5P	XCMD2110C12	XCMD2102C12	XCMD2124C12	XCMD21F0C12	XCMD21F2C12	XCMD2115C12	XCMD2116C12
		1K/A Ani hareketli	M12 4P	XCMD2110M12	XCMD2102M12	XCMD2124M12	XCMD21F0M12	XCMD21F2M12	XCMD2115M12	XCMD2116M12



Model	Malzeme	Kafa	Kontak	1	2	3	4	5	6		
XCSM	Metal	Emniyet Kontaktları	3m Kablo	Operator Tipi	Metal uçlu pim	Çelik makaralı pim	2NK + NA Ani	1m Kablo	Operator Tipi	Metal uçlu pim	Çelik makaralı pim
			2m Kablo	XCSM3710L1	XCSM3702L1	XCSM4110L1		XCSM4102L1			
			5m Kablo	XCSM3710L2	XCSM3702L2	XCSM4110L2		XCSM4102L2			
		2NK+NA Yavaş	2m Kablo	XCSM3710L5	XCSM3702L5	XCSM4110L5	XCSM4102L5				
			5m Kablo	XCSM3710L5	XCSM3702L5	XCSM4110L5	XCSM4102L5				
			5m Kablo	XCSM3710L5	XCSM3702L5	XCSM4110L5	XCSM4102L5				



Model	Malzeme	Kafa	Kontak	1	2	3	4	5
XCKM	Metal	NA+NK Ani	M20	XCKM110H29	XCKM102H29	XCKM121H29	XCKM115H29	XCKM106H29
		Pg11	XCKM110	XCKM102	XCKM121	XCKM115	XCKM106	
XCKL	Metal	NA+NK Ani	CG	XCKL110	XCKL102	XCKL121	XCKL115	XCKL106



Model	Malzeme	Kafa	Kontak	1	2	3	4	5	
XCKJ	Metal	NA+NK Ani	M20	XCKJ161H29	XCKJ167H29	XCKJ10511H29	XCKJ10513H29	XCKJ10541H29	XCKJ1059H29
		Pg13	XCKJ161	XCKJ167	XCKJ10511	XCKJ10513	XCKJ10541	XCKJ10559	
		1/2NPT	XCKJ161H7	XCKJ167H7	XCKJ10511H7	XCKJ10513H7	XCKJ10541H7	XCKJ10559H7	
		M12 5P	XCKJ161D	XCKJ167D	XCKJ10511D	XCKJ10513D	XCKJ10541D	XCKJ10559D	

(1) Plastik makara (2) Çelik makara



Model	Malzeme	Kafa	Kontak	1	2	3	Aksesuarlar
XCSA	Metal	NK+ZNA Yavaş hareketli	M20	XCSA502	XCSA702	XCSA802	XCSZ01
			Pg13	XCSA501	XCSA701	XCSA801	XCSZ03
			1/2NPT	XCSA503	XCSA703	XCSA803	



Model	Malzeme	Kafa	Kontak	1	2	3	4	Aksesuarlar	
XCSPA	Plastik	NK+NA Yavaş	M16	XCSPA592	XCSPA792	XCSPA892	XCSPA992	XCSPA492	XCSZ11
			Pg11	XCSPA591	XCSPA791	XCSPA891	XCSPA991	XCSPA491	XCSZ13
			1/2NPT	XCSPA593	XCSPA793	XCSPA893	XCSPA993	XCSPA493	

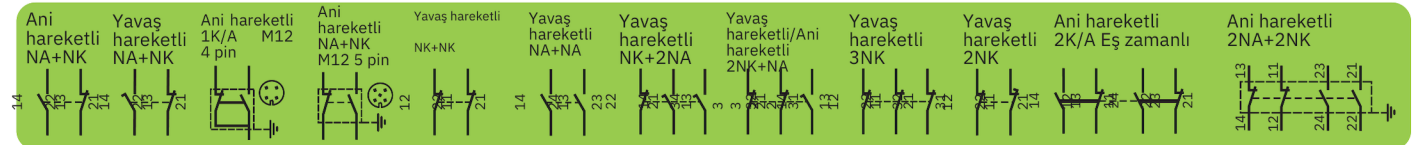

Model	Kablo	Konnectörler (dişi)
M16	ISO kablo rakoru için dişli M16x1,5	
M20	ISO kablo rakoru için dişli M20x1,5	
Pg11	N°11 kablo rakoru için dişli	
Pg13	N°13 kablo rakoru için dişli	
1/2NPT	1/2" NPT için dişli	
PF1/2	PF1/2" için dişli	
M12 5P	Konnectör M12, 5 pin	
M12 4P	Konnectör M12, 4 pin	
CG	Kablo rakorlu dişli	

(1) Bir PVC kabloda, P harfinin ardından V harfi gelir, örneğin: XZCPxxxxx, XZCPVxxxxx olur

# Nihayet şalterleri: XC Serisi

**XCKP / XCKD / XCKT**  
Plastik / Metal / Plastik

(1) Plastik makara

	NA+NK Ani	NA+2NK Ani	NA+NK Yavaş	NK+NK Yavaş	NK+NK Ani	NA+NA Yavaş
XCKP	ZCP21	ZCP39	ZCP25	ZCP27	ZCP29	ZCP28
XCKD	ZCD21	ZCD39	ZCD25	ZCD27	ZCD29	ZCD28

Kablo girişi	M16	M20	Pg11	Pg13.5	1/2 NPT	PF1/2
XCKP	ZCEP16	ZCEP20	ZCEG11	ZCEG13	ZCEN12	ZCEP12
XCKD	ZDEP16	ZDEP20	ZDEG11	ZDEG13	ZDEN12	ZDEF12

	NA+NK Ani	XCKT	NK+NK Ani
M12	ZCP21M12	M16	ZCT21P16
4P	ZCD21M12	Pg11	ZCT21G11
M12			NA+NK Yavaş
5P		M16	ZCT25P16
		Pg11	ZCT25G11

**XCMD**  
Metal

(1) Plastik makara (2) Çelik makara

	NA+NK Ani hareketli	NA+NK Yavaş hareketli	2NA+2NK Ani hareketli	NA+NK Ani	1K/A Ani
ZCMD21					
ZCMD25					
ZCMD4D					
ZCMD21C12				M12 5P	
ZCMD21M12					M12 4P

1 m	ZCMC21L1	ZCMD21L1	ZCMC25L1	ZCMD25L1	ZCMC4DL1	ZCMD41L1
2 m	ZCMC21L2	ZCMD21L2	ZCMC25L2	ZCMD25L2	ZCMC4DL2	ZCMD41L2
5 m	ZCMC21L5	ZCMD21L5	ZCMC25L5	ZCMD25L5	ZCMC4DL5	ZCMD41L5

**XCKM / XCKL**  
Metal

(1) Plastik makara (2) Çelik makara

XCKM/XCKL	NA+NK Ani hareketli	NA+NK Yavaş hareketli
3xPg11	ZCKM1	ZCKM5
3xM20	ZCKM1H29	ZCKM5H29
PE 1/2		ZCKL1
NPT		ZCKL1H7
		ZCKL5
		ZCKL5H7

XCKS	NA+NK Ani hareketli	NA+NK Yavaş hareketli
Pg13	ZCKS1	ZCKS5
M20	ZCKS1H29	ZCKS5H29

XCKJ	NA+NK Ani	NA+NK Yavaş	2K/A Eş zamanlı Ani
Pg13	ZCKJ1	ZCKJ5	ZCKJ2
M20	ZCKJ1H29	ZCKJ5H29	ZCKJ2H29
1/2 NPT	ZCKJ1H7	ZCKJ5H7	ZCKJ2H7
M12 5P	ZCKJ1D	ZCKJ5D	-

**XCKJ**  
Metal

(1) Plastik makara (2) Çelik makara

XCKS	Plastik
ZCKD01	ZCKD02
ZCKD05	
ZCKY31	ZCKY39
ZCKY41	ZCKY41



# Endüktifler: XS Serisi

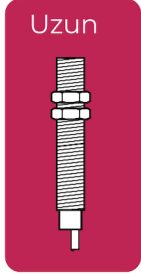

	Algilama mesafesi	M8		M12		
		1.5 mm	2.5 mm	2 mm	4 mm	
DC3	PNP	kablo	XS508B1PAL2	XS108B3PAL2	XS512B1PAL2	XS112B3PAL2
		konnektör	XS508B1PAM8	XS108B3PAM8	XS512B1PAM12	XS112B3PAM12
	NPN	kablo	XS508B1NAL2	XS108B3NAL2	XS512B1NAL2	XS112B3NAL2
		konnektör	XS508B1NAM8	XS108B3NAM8	XS512B1NAM12	XS112B3NAM12
DC2	kablo	XS508BSCAL2	XS608B3CAL2	XS512BSDAL2	XS612B3DAL2	
	konnektör	XS508BSCAL01M12	XS608B3CAL01M12	XS512BSDAM12	XS612B3DAM12	
DC3	PNP	kablo	XS508BLPAL2	XS608B1PAL2	XS512BLPAL2	XS612B1PAL2
		konnektör	XS508BLPAM12	XS608B1PAM12	XS512BLPAM12	XS612B1PAM12
	NPN	kablo	XS508BLNAL2	XS608B1NAL2	XS512BLNAL2	XS612B1NAL2
		konnektör	XS508BLNAM12	XS608B1NAM12	XS512BLNAM12	XS612B1NAM12
DC2	kablo	XS508B1DAL2	XS608B1DAM12	XS512B1DAL2	XS612B1DAL2	
	konnektör	XS508B1DAM12	XS608B1DAL2	XS512B1DAM12	XS612B1DAM12	
AC/DC	kablo			XS512B1MAL2	XS612B1MAL2	
	konnektör			XS512B1MAU20	XS612B1MAU20	
Çıkış fonksiyonu	NA		A	A	A	A
	NK		B	B	B	B
	NA+NK					(yalnızca kısa) C

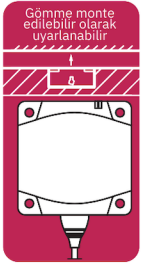
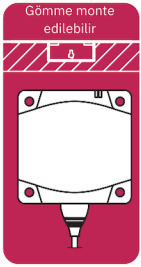

	Algilama mesafesi	U 8x22x8 mm	U 15x32x8 mm	U 26x26x13 mm	U 40x40x15 mm	
		2.5 mm	5 mm	10 mm	15 mm	
DC3	PNP	kablo	XS7J1A1PAL2	XS7F1A1PAL2	XS7E1A1PAL2	XS7C1A1PAL2
		konnektör	XS7J1A1PAL01M8	XS7F1A1PAL01M8	XS7E1A1PAM8	XS7C1A1PAM8
	NPN	kablo	XS7J1A1NAL2	XS7F1A1NAL2	XS7E1A1NAL2	XS7C1A1NAL2
		konnektör	XS7J1A1NAL01M8	XS7F1A1NAL01M8	XS7E1A1NAM8	XS7C1A1NAM8
DC2	kablo	XS7J1A1DAL2	XS7F1A1DAL2	XS7E1A1DAL2	XS7C1A1DAL2	
	konnektör	XS7J1A1DAL01M8	XS7F1A1DAL01M8	XS7E1A1DAM8	XS7C1A1DAM8	
DC3	PNP	kablo			XS8E1A1PAL2	XS8C1A1PAL2
		konnektör			XS8E1A1PAM8	XS8C1A1PAM8
	NPN	kablo			XS8E1A1NAL2	XS8C1A1NAL2
		konnektör			XS8E1A1NAM8	XS8C1A1NAM8
AC/DC	kablo			XS8E1A1MAL2	XS8C1A1MAL2	
	konnektör			XS8E1A1MAL01U20	XS8C1A1MAL01U20	
Çıkış fonksiyonu	NA		A	A	A	
	NK		B	B	B	



## Kablo

### Bağlantısı XS

M8	PUR hazır kablolu konnektörler (dışı)			
	(1) düz	dirsekli		
3 pin	2 m	XZCP0566L2	XZCP0666L2	
	5 m	XZCP0566L5	XZCP0666L5	
	10 m	XZCP0566L10	XZCP0666L10	
1/2"	3 pin	5 m	XZCP1865L5	XZCP1965L5

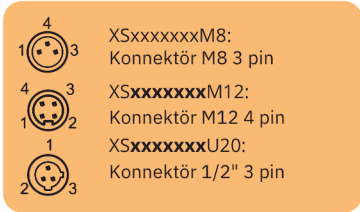

(1) Bir PVC kabloda, P harfinin ardından V harfi gelir, örneğin: XZCPxxxxx, XZCPVxxxxx olur.

# Endüktifler: XS Serisi

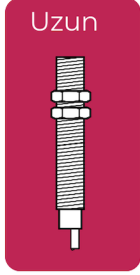
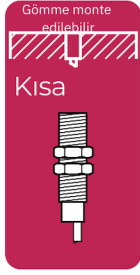

			M18		M30	
Algılama mesafesi			5 mm	8 mm	10 mm	15 mm
DC3	PNP	kablo	XS518B1PAL2	XS118B3PAL2	XS530B1PAL2	XS130B3PAL2
		konnektör	XS518B1PAM12	XS118B3PAM12	XS530B1PAM12	XS130B3PAM12
	NPN	kablo	XS518B1NAL2	XS118B3NAL2	XS530B1NAL2	XS130B3NAL2
		konnektör	XS518B1NAM12	XS118B3NAM12	XS530B1NAM12	XS130B3NAM12
DC2	kablo	XS518BSDAL2	XS618B3DAL2	XS530BSDAL2	XS630B3DAL2	
	konnektör	XS518BSDAM12	XS618B3DAM12	XS530BSDAM12	XS630B3DAM12	
DC3	PNP	kablo	XS518BLPAL2	XS618B1PAL2	XS530BLPAL2	XS630B1PAL2
		konnektör	XS518BLPAM12	XS618B1PAM12	XS530BLPAM12	XS630B1PAM12
	NPN	kablo	XS518BLNAL2	XS618B1NAL2	XS530BLNAL2	XS630B1NAL2
		konnektör	XS518BLNAM12	XS618B1NAM12	XS530BLNAM12	XS630B1NAM12
DC2	kablo	XS518B1DAL2	XS618B1DAL2	XS530B1DAL2	XS630B1DAL2	
	konnektör	XS518B1DAM12	XS618B1DAM12	XS530B1DAM12	XS630B1DAM12	
AC/DC	kablo	XS518B1MAL2	XS618B1MAL2	XS530B1MAL2	XS630B1MAL2	
	konnektör	XS518B1MAU20	XS618B1MAU20	XS530B1MAU20	XS630B1MAU20	
Çıkış fonksiyonu	NA		A	A	A	A
	NK		B	B	B	B
	NA+NK		(yalnızca kısa) C		(yalnızca kısa) C	

## Aksesuarlar



M8	XSZB108
M12	XSZB112
M18	XSZB118
M30	XSZB130

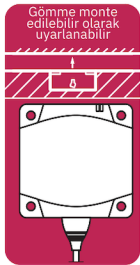
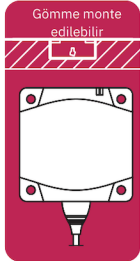

			U 80x80x26 mm	
Algılama mesafesi			40 mm	
DC3	PNP	kablo	XS7D1A1PAL2	
		konnektör	XS7D1A1PAM12	
	NPN	kablo	XS7D1A1NAL2	
		konnektör	XS7D1A1NAM12	
DC2	kablo	XS7D1A1DAL2		
	konnektör	XS7D1A1DAM12		
DC3	PNP	kablo	XS8D1A1PAL2	
		konnektör	XS8D1A1PAM12	
	NPN	kablo	XS8D1A1NAL2	
		konnektör	XS8D1A1NAM12	
AC/DC	kablo	XS8D1A1MAL2		
	konnektör	XS8D1A1MAU20		
Çıkış fonksiyonu	NA		A	
	NK		B	

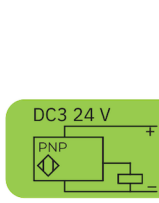
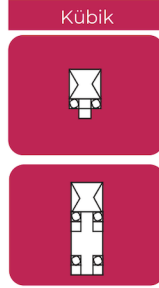

			U 40x40x17 mm		20 mm	40 mm
DC4	PNP	NA+NK	XS8C2A1PCM12	XS8C2A4PCM12		
	NPN	NA+NK	XS8C2A1NCM12	XS8C2A4NCM12		
DC2		NA	XS8C2A1DAM12	XS8C2A4DAM12		
	AC/DC	NA	XS8C2A1MAU20	XS8C2A4MAU20		
DC4	PNP	NA+NK	XS8C4A1PCP20	XS8C4A4PCP20		
	NPN	NA+NK	XS8C4A1NCP20	XS8C4A4NCP20		
DC2		NA veya NK	XS8C4A1DPP20	XS8C4A4DPP20		
	AC/DC	NA veya NK	XS8C4A1MPP20	XS8C4A4MPP20		
Bağlantı türünü seçin	M20		P20	P20		
	PG13		C13	C13		
	1/2" NPT		N12	N12		

DC3 24 V

DC4 24 V

AC/DC 24...240 V

DC2 24 V

Aksesuarlar

For 26x26 XSZBE00 XSZBE90

For 40x40 XSZBC00 XSZBC90

# Rotasyon izleme: XSAV Serisi

Seçin : 1 > 2 >

Hız Çıkış Tipi

Referans



			Algılama mesafesi		Düşük Hız	Yüksek Hız
			10 mm		10 mm	10 mm
M30	Gömme	kablo	Çıkış tipi	DC3-PNP	XSAV11373	XSAV12373
				AC/DC	XSAV11801	XSAV12801

## Kablo bağlantısı XS

		PUR hazır kablolu konnektörler (dışı)		
M12		düz(1)	dirsekli	dirsekli PNP LED
4 pin	2 m	XZCP1141L2	XZCP1241L2	XZCP1340L2
	5 m	XZCP1141L5	XZCP1241L5	XZCP1340L5
	10 m	XZCP1141L10	XZCP1241L10	XZCP1340L10

		Konnektörler (dışı)	
M12		düz	dirsekli
4 pin	(2)	XZCC12FDM40B	XZCC12FCM40B
	(3)	XZCC12FDP40B	XZCC12FCP40B

(1) Bir PVC kabloda, P harfinin ardından V harfi gelir, örneğin: XZCPxxxxx, XZCPVxxxxx olur

(2) Çelik halka (3) Plastik halka



# Fotoelektrik: XU Serisi

XU minyatür, silindir ve hibrit\* model

Seçin

Gövde boyutu ve sistem



Algılama mesafesi					M18 metal	M18 plastik	Hibrit	Minyatür		
Cisimden yansımaya (T/R)	1 m	DC4	PNP	kablo	XUB5BPXNL2	XUB5APXNL2	XUN5APXNL2	1.9 m	XUM5APXBL2	
				konnektör 4P*	XUB5BPXNM12	XUB5APXNM12	XUN5APXNM12		XUM5APXBM8	
				NPN	kablo	XUB5BNXNL2	XUB5ANXNL2		XUN5ANXNL2	XUM5ANXBL2
					konnektör 4P	XUB5BNXNM12	XUB5ANXNM12		XUN5ANXNM12	XUM5ANXBM8
Referans 12 ile bitiyorsa konnektör 4P M12, eğer referans 8 ile bitiyorsa konnektör 4P M8	0.5 m	DC4	PNP	Io-Link	XUB5BPYNM12	XUB5APYNM12		1.1 m	XUM6APXBL2	
				kablo					XUM6APXBM8	
				konnektör 4P					XUM6ANXBL2	
				NPN	kablo					XUM6ANXBM8
konnektör 4P					XUM6ANXBM8					
Arka Plan Bastırma Arka Plan Bastırma	0.3 m	DC4	PNP	kablo	XUB8BPXNL2*	XUB8APXNL2*	XUN8APXNL2*	0.3 m	XUM8APXBL2	
				konnektör 4P	XUB8BPXNM12*	XUB8APXNM12*	XUN8APXNM12*		XUM8APXBM8	
				NPN	kablo	XUB8BNXNL2*	XUB8ANXNL2*		XUN8ANXNL2*	XUM8ANXBL2
					konnektör 4P	XUB8BNXNM12*	XUB8ANXNM12*		XUN8ANXNM12*	XUM8ANXBM8
Io-Link	XUB8BPYNM12*	XUB8APYNM12*								
	Polarize Reflektörlü (T/R)	7 m	DC4	PNP	kablo	XUB9BPXNL2	XUB9APXNL2	XUN9APXNL2	8 m	XUM9APXBL2
					konnektör 4P	XUB9BPXNM12	XUB9APXNM12	XUN9APXNM12		XUM9APXBM8
					NPN	kablo	XUB9BNXNL2	XUB9ANXNL2		XUN9ANXNL2
konnektör 4P						XUB9BNXNM12	XUB9ANXNM12	XUN9ANXNM12		XUM9ANXBM8
Io-Link	XUB9BPYNM12	XUB9APYNM12								
	Aksesuar: Reflektör			XUZC50	XUZC50	XUZC50	XUZC50			
Karşılıklı alıcı (R)	30 m	DC4	PNP	kablo	XUB2BPXNL2R	XUB2APXNL2R	XUN2APXNL2R	30 m	XUM2APXBL2R	
				konnektör 4P	XUB2BPXNM12R	XUB2APXNM12R	XUN2APXNM12R		XUM2APXBM8R	
				NPN	kablo	XUB2BNXNL2R	XUB2ANXNL2R		XUN2ANXNL2R	XUM2ANXBL2R
					konnektör 4P	XUB2BNXNM12R	XUB2ANXNM12R		XUN2ANXNM12R	XUM2ANXBM8R
Io-Link	XUB2BPYNM12R	XUB2APYNM12R								
	Verici	kablo	XUB2BKXNL2T	XUB2BKXNL2T	XUN2AKXNL2T	XUM2AKXNL2T				
konnektör 4P		XUB2BKXNM12T	XUB2BKXNM12T	XUN2AKXNM12T	XUM2AKXNM12T					
Karşılıklı (T) (R)	30 m	DC4	PNP	kablo	XUB2BPXNL2	XUB2APXNL2	XUN2APXNL2	30 m	XUM2APXBL2	
				konnektör 4P	XUB2BPXNM12	XUB2APXNM12	XUN2APXNM12		XUM2APXBM8	
				NPN	kablo	XUB2BNXNL2	XUB2ANXNL2		XUN2ANXNL2	XUM2ANXBL2
					konnektör 4P	XUB2BNXNM12	XUB2ANXNM12		XUN2ANXNM12	XUM2ANXBM8
Io-Link	XUB2BPYNM12R	XUB2APYNM12R								

\*Ürün 2024'ün 4. çeyreğinde satışa sunulacak

Çok modlu		DC3	PNP	kablo	XUB0BPSNL2	XUB0APSNL2	XUM0APXBL2
Arkaplan bastırma (BGS)	Cisimden Yansımaya (D)	NPN	konnektör 4P	XUB0BPSNM12	XUB0APSNM12	XUM0APXBM8	
			kablo	XUB0BNSNL2	XUB0ANSNL2	XUM0ANSAL2	
PReflektörlü (P)	TKarşılıklı	NPN	konnektör 4P	XUB0BNSNM12	XUB0ANSNM12	XUM0ANSAM8	
			Algılama mesafesi	Arkaplan Bastırma: 0.12m	Cisimden yansımaya:	APB: 0.1 m   D: 0.4 m	
Verici	Çıkış fonksiyonu	DC	NA veya NK	Reflektörlü: 3 m	0.3 m Karşılıklı: 20 m	R: 3 m   K: 10 m	
			kablo	XUB0BKSNL2T	XUB0AKSNL2T	XUM0AKSAL2T	
konnektör 4P	XUB0BKSNM12T	XUB0AKSNM12T	XUM0AKSAM8T				

# Fotoelektrik: XU Serisi

		Algılama mesafesi		Kompakt 50x50 mm		Kompakt 92x71 mm				
Cisimden Yansımaya (T/R)	1 m	DC3	PNP	kablo	XUK5APANL2	2.1 m	DC3	PNP	terminaller	XUX5APANL16
				konnektör	XUK5APANM12				konnektör 4P	XUX5APANM12
		NPN	4P kablo	XUK5ANANL2	NPN	terminaller	XUX5ANANL16			
			konnektör	XUK5ANANM12	konnektör 4P	XUX5ANANM12				
AC/DC	Röle	4P kablo	XUK5ARCNL2	AC/DC	Röle	terminaller	XUX5ARCNT16			
Çıkış fonksiyonu		NA		A		A		A		
		NK		B		B		B		
Polarize Reflektörlü (T/R)	5 m	DC3	PNP	kablo	XUK9APANL2	11 m	DC3	PNP	terminaller	XUX9APANL16
				konnektör 4P	XUK9APANM12				konnektör 4P	XUX9APANM12
		NPN	kablo	XUK9ANANL2	NPN	terminaller	XUX9ANANL16			
			konnektör 4P	XUK9ANANM12	konnektör 4P	XUX9ANANM12				
AC/DC	Röle	kablo	XUK9ARCNL2	AC/DC	Röle	terminaller	XUX9ARCNT16			
Aksesuar: Reflektör				XUZC50				XUZC50		
Reflektörlü (T/R)	7 m	DC3	PNP	kablo	XUK1APANL2	14 m	DC3	PNP	terminaller	XUX1APANL16
				konnektör 4P	XUK1APANM12				konnektör 4P	XUX1APANM12
		NPN	kablo	XUK1ANANL2	NPN	terminaller	XUX1ANANL16			
			konnektör 4P	XUK1ANANM12	konnektör 4P	XUX1ANANM12				
AC/DC	Röle	kablo	XUK1ARCNL2	AC/DC	Röle	terminaller	XUX1ARCNT16			
Aksesuar: Reflektör kablo				XUZC50				XUZC50		
Karşılıklı (T) (R)	30 m	DC3	PNP	kablo	XUK2APANL2R	40 m	DC3	PNP	terminaller	XUX2APANL16R
				konnektör 4P	XUK2APANM12R				konnektör 4P	XUX2APANM12R
		NPN	kablo	XUK2ANANL2R	NPN	terminaller	XUX2ANANL16R			
			konnektör 4P	XUK2ANANM12R	konnektör 4P	XUX2ANANM12R				
AC/DC	Röle	kablo	XUK2AKSNL2T	AC/DC	Röle	terminaller	XUX0AKSAT16T			
Aksesuar: Verici				XUK2AKSNM12T				XUX0AKSAM12T		
				XUK2ARCNL2R				XUX2ARCNT16R		
				XUK2ARCNL2T				XUX0ARCTT16T		

Çok modlu		DC3 PNP/NPN		kablo		XUK0AKSAL2		DC3 PNP/NPN		terminaller		XUX0AKSAT16	
Background suppression (BGS)	Cisimden Yansımaya	Polarised reflex (P)	Karşılıklı (TB)	konnektör	XUK0AKSAM12	konnektör 4P	XUX0AKSAM12	konnektör 4P	XUX0AKSAM12	terminaller	XUX0ARCTT16		
				AC/DC	Röle	4P kablo	XUK0ARCTL2	AC/DC	Röle	terminaller	XUX0ARCTT16		
				Arka Plan Bastırma: 0.28 m		Cisimden Yansımaya: 0.8 m		Arka Plan Bastırma: 1.3 m		Cisimden Yansımaya: 2 m		Polarize reflektörlü: 11 m	
Aksesuar: Verici		DC		kablo	XUK0AKSAL2T	DC		terminaller	XUX0AKSAT16T				
		AC/DC		konnektör	XUK0AKSAM12T	AC/DC		konnektör 4P	XUX0AKSAM12T				
		AC/DC		4P kablo	XUK0ARCTL2T	AC/DC		terminaller	XUX0ARCTT16T				

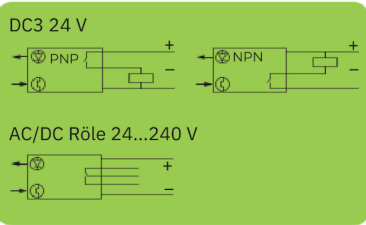

PUR hazır kablolu konnektörler (dişi)				Konnektörler (dişi)			
M12		düz (1)	dirsekli	dirsekli PNP LED	M12	düz	dirsekli
4 pin	2 m	XZCP1141L2	XZCP1241L2	XZCP1340L2	4 pin (2)	XZCC12FDM40B	XZCC12FCM40B
	5 m	XZCP1141L5	XZCP1241L5	XZCP1340L5	4 pin (3)	XZCC12FDP40B	XZCC12FCP40B
	10 m	XZCP1141L10	XZCP1241L10	XZCP1340L10			

(1) Bir PVC kabloda, P harfinin ardından V harfi gelir, örneğin: XZCPxxxxx, XZCPVxxxxx olur.

(2) Çelik halka (3) Plastik halka

# XU Uygulamaya Özel Fotoelektrik Sensör

Gövde boyutu ve Teknoloji

Seçim



## Renk sensörü



Işık tipi	Algılama Mesafesi	Elektriksel kablolama	Çıkış Fonksiyonu	Bağlantı Tipi	Kompakt	Minyatür	Sub Minyatür
Beyaz	60 mm	DC5	PNP/NPN /IO-LINK	M12 5-Pin	XUKCBSAYM12		
	150 mm				XUKCBLAYM12		

RGB LED	12 mm	DC4	PNP/NPN/IO-LINK	M8 4-Pin		XUMRACAYM8	
---------	-------	-----	-----------------	----------	--	------------	--

## Kontrast sensörü



RGB	12 mm	DC4	PNP/NPN/IO-LINK	M8 4-Pin		XUMRAGAYM8	
				M12 4-Pin, 150 mm		XUMRAGAYP015	
Beyaz LED	12 mm	DC4	PNP/NPN/IO-LINK	M8 4-Pin		XUMRAWAYM8	
				M12 4-Pin, 150 mm		XUMRAWAYP015	
Lazer	250 mm	DC4	PNP/NPN/IO-LINK	M8 4-Pin		XUM5ALAYM8	
				M12 4-Pin, 150 mm		XUM5ALAYP015	
				Kablo, 2 m, 4 telli		XUM5ALAYL2	

## Şeffaf nesne



Kırmızı LED	2000 mm	DC4	PNP/NPN/IO-LINK	M8 4-Pin		XUMTARAYM8	
				M12 4-Pin, 150 mm		XUMTARAYP015	
				Kablo, 2 m, 4 telli		XUMTARAYL2	

Aksesuar: Reflektör						XUZC50	XUZC50
---------------------	--	--	--	--	--	--------	--------

Mavi Işık	50 mm	DC4	PNP	M8 4-Pin, 200 mm			XUT7ABXP02
				Kablo, 2 m, 4-telli			XUT7ABPXL2
	80 mm	DC4	PNP	M8 4-Pin		XUM7ABPXM8	
				Kablo, 2 m, 4-telli		XUM7ABPXL2	
	100 mm	DC4	PNP/NPN/IO-LINK	M8 4-Pin, 200 mm			XUT8ABAYP02
				Kablo, 2 m, 4-telli			XUT8ABAYL2
	200 mm	DC4	PNP/NPN/IO-LINK	M8 4-Pin		XUM8ABAYM8	
				M12 4-Pin, 150		XUM8ABAYP015	
	1200 mm	DC4	PNP	M12 4-Pin	XUK8ABPXM12		

## Lazer



Cisimden Yansıma	250 mm	DC4	PNP/NPN/IO-LINK	M8 4-Pin		XUM5ALAYM8	
				M12 4-Pin, 150		XUM5ALAYP015	
				Kablo, 2 m, 4-Telli		XUM5ALAYL2	

BGS	70 mm	DC4	PNP/NPN/IO-LINK	M8 4-Pin, 200 mm			XUT8ALAYP02
				Kablo, 2 m, 4-telli			XUT8ALAYL2

	150 mm	DC4	PNP/NPN/IO-LINK	M8 4-Pin		XUM8ALAYM8	
				M12 4-Pin, 200		XUM8ALAYP015	

Reflektörlü	10000 mm	DC4	PNP/NPN/IO-LINK	M8 4-Pin		XUM8ALAYL2	
				M12 4-Pin, 200		XUM9ALAYM8	

	3000 mm	DC4	PNP	M8 4-Pin, 200 mm			XUT9ALXP02
				Kablo, 2 m, 4-Telli			XUT9ALPXL2

Aksesuar: Reflektör yüksek hassasiyet						XUZC50HP	XUZC50HP
---------------------------------------	--	--	--	--	--	----------	----------

Standart	50 mm	DC4	PNP	M8 4-Pin, 200 mm			XUT7ABXP02
				Kablo, 2 m, 4-Telli			XUT7ABPXL2

	80 mm	DC4	PNP	M8 4-Pin		XUM7ABPXM8	
				Kablo, 2 m, 4-Telli		XUM7ABPXL2	

Öğretme modu	100 mm	DC4	PNP/NPN/IO-LINK	M8 4-Pin, 200 mm			XUT8ABAYP02
				Kablo, 2 m, 4-Telli			XUT8ABAYL2

	200 mm	DC4	PNP/NPN/IO-LINK	M8 4-Pin		XUM8ABAYM8	
				M12 4-Pin, 150		XUM8ABAYP015	

	1200 mm	DC4	PNP	M12 4-Pin	XUK8ABPXM12		
--	---------	-----	-----	-----------	-------------	--	--

## BGS Mavi Işık



# Aksesuarlar



XZ (...) M8:  
Konnektör M8 4 pin  
XZ (...) M12:  
Konnektör M12 4 pin

## Reflektörler

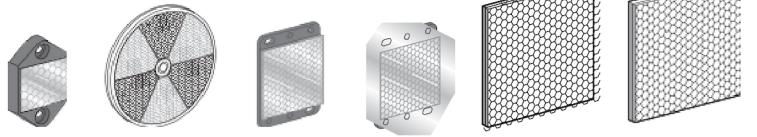

XUZY24

XUZY80

XUZY50

XUZY50HP

XUZY100

XUZY50CR

## Kablo bağlantısı XU



### PUR hazır kablolu konnektörler (dişi)

M12		düz (1)	dirsekli	dirsekli PNP LED
4 pin	2 m	XZCP1141L2	XZCP1241L2	XZCP1340L2
	5 m	XZCP1141L5	XZCP1241L5	XZCP1340L5
	10 m	XZCP1141L10	XZCP1241L10	XZCP1340L10

(1) Bir PVC kabloda, P harfinin ardından V harfi gelir.  
Örnek: XZCP1141L2, XZCPV1141L2 olur

## Kablo bağlantısı XU



### PUR hazır kablolu konnektörler (dişi)

M8		(1) düz	dirsekli
4 pin	2 m	XZCP0941L2	XZCP1041L2
	5 m	XZCP0941L5	XZCP1041L5
	10 m	XZCP0941L10	XZCP1041L10

(1) Bir PVC kabloda, P harfinin ardından V harfi gelir.  
Örnek: XZCP0941L2, XZCPV0941L2 olur.



## XUZARM

Kırlangıç kuyruğu kelepçesi  
2x M3 vidayla birlikte verilir

### Şunlarla uyumludur:

XUM\*A\*AYM8  
XUM\*A\*AYP015  
XUM\*A\*AYL2  
XUM7ABPX\*\*



## XUZARS

Kırlangıç kuyruğu kelepçesi  
2x M3 vidayla birlikte verilir

### Şunlarla uyumludur:

XUT7ABPX\*\*  
XUT8A\*AY\*\*  
XUT9ABPX\*\*



## XUZARK

Kırlangıç kuyruğu kelepçesi  
1x M3 vidayla birlikte verilir

### Şunlarla uyumludur:

XUKCB\*AYM12  
XUK8ABPX12



## XUZASS

Kırlangıç kuyruğu kelepçesi  
2x M3 vidayla birlikte verilir

### Şunlarla uyumludur:

XUT7ABPX\*\*  
XUT8A\*AY\*\*  
XUT9ABPX\*\*

## Diğer sabitlemeler

### Tek braket



	standart	küresel mafsallı ile
XUB	XUZA118 (paslanmaz çelik)	XUZA218(plastik)
XUM	XUZA50	-
XUK	XUZA51	-
XUX	XUZ2000	-



# Ultrasonik: XX Serisi

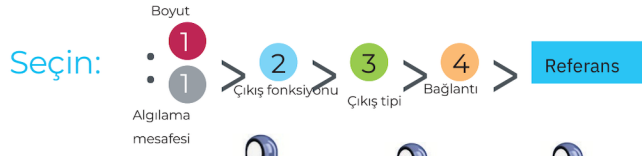

			M12		M18		M18 plastik (2)	M18 pirinç (2)	M18 paslanmaz (2)	M18 metal
Algılama mesafesi			0.05 m	0.1 m	0.15 m	0.5 m Ayarlanabilir (1)	1 m Ayarla. (1)	1 m Ayarla. (1)	1 m Ayarlanabilir (1)	0.05 m
Konnektörler/Kablolar			M8 4 pin	M8 3 pin	M12 4 pin	M12 4 pin	M12 5 pin	M12 5 pin	M12 5 pin	M12 4 pin
NA	DC4	PNP/NPN	XX512A1KAM8		XX518A1KAM12					
		DC3	PNP		XX512A2PAM8		XX518A3PAM12			XXV18B1PAM12
		NPN		XX512A2NAM8		XX518A3NAM12			XXV18B1NAM12	
NA veya NK	DC3	PNP					XXS18P1PM12	XXS18B1PM12	XXS18S1PM12	
							XXA18P1PM12	XXA18B1PM12	XXA18S1PM12	
Analog		4...20 mA				XX918A3C2M12	XXS18P1AM12	XXS18B1AM12	XXS18S1AM12	
							XXA18P1AM12	XXA18B1AM12	XXA18S1AM12	
		0...10 V				XX918A3F1M12	XXS18P1VM12	XXS18B1VM12	XXS18S1VM12	
							XXA18P1VM12	XXA18B1VM12	XXA18S1VM12	

(1) XXZPB100 ile ayarlanabilir

(2) Yazılım tarafından XXZBOX01 ile yapılandırılabilir

S = düz A = açılı



			M30 plastik (2)				M30 pirinç (2)			M30 paslanmaz (2)		
Algılama mesafesi			1 m Ayarlanabilir (1)	2 m Ayarlanabilir (1)	4 m Ayarlanabilir (1)	8 m Ayarlanabilir (3)	1 m Ayarlanabilir (1)	2 m Ayarlanabilir (1)	4 m Ayarlanabilir (1)	1 m Ayarlanabilir (1)	2 m Ayarlanabilir (1)	4 m Ayarlanabilir (1)
Konnektörler			M12 5-pin	M12 5-pin	M12 5-pin	M12 5-pin	M12 5-pin	M12 5-pin	M12 5-pin	M12 5-pin	M12 5-pin	M12 5-pin
NA veya NK	DC3	PNP	XXS30P1PM12	XXS30P2PM12	XXS30P4PM12		XXS30B1PM12	XXS30B2PM12	XXS30B4PM12	XXS30S1PM12	XXS30S2PM12	XXS30S4PM12
			XXA30P1PM12	XXA30P2PM12			XXA30B1PM12	XXA30B2PM12		XXA30S1PM12	XXA30S2PM12	
	DC4	2 x PNP				XXS30P8PPM12						
			2 x NPN				XXS30P8NNM12					
Analog	DC3	4...20mA	XXS30P1AM12	XXS30P2AM12	XXS30P4AM12		XXS30B1AM12	XXS30B2AM12	XXS30B4AM12	XXS30S1AM12	XXS30S2AM12	XXS30S4AM12
			XXA30P1AM12	XXA30P2AM12			XXA30B1AM12	XXA30B2AM12		XXA30S1AM12	XXA30S2AM12	
	DC3	0...10V	XXS30P1VM12	XXS30P2VM12	XXS30P4VM12		XXS30B1VM12	XXS30B2VM12	XXS30B4VM12	XXS30S1VM12	XXS30S2VM12	XXS30S4VM12
							XXA30B1VM12	XXA30B2VM12		XXA30S1VM12	XXA30S2VM12	
Analog + NA veya NK	DC4	4...20 mA + PNP				XXS30P8APM12						
			0...10V + PNP				XXS30P8VPM12					

(1) XXZPB100 ile ayarlanabilir

(2) Yazılım tarafından XXZBOX01 ile yapılandırılabilir

(3) Ürüne entegre buton S = düz A = açılı



			Düz 7.6x19x33	Düz 16x30x74	Düz 60x30x18 + M18	
Algılama mesafesi			0.1 m	0.25 m	0.5 m Ayarlanabilir	0.5 m Ayarlanabilir
Konnektörler			M12 4 pin	M12 4 pin	M12 4 pin	M12 4 pin
NA	DC3	PNP	XX7F1A2PAL01M12	XX7K1A2PAM12		XX7V1A1PAM12 (1)
		NPN	XX7F1A2NAL01M12	XX7K1A2NAM12		XX7V1A1NAM12 (1)
Analog		4...20 mA				XX9V1A1C2M12 (1)
			0...10 V			

(1) XXZPB100 ile ayarlanabilir

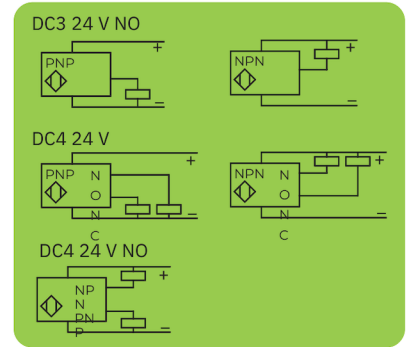

XUZ 2001	M12	XUZB2012
XUZ 2003	M18	XUZB2003
	M30	XUZB2030

XX7K için	Düz	XXZ3074F
Kranklı		XXZ3074S

M12	XXZ12
M18	XUZ A118
M30	XXZ30
XX7F	XXZ1933





# Çatallar: XUV Serisi

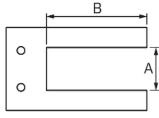

			A: 50 mm / B: 60 mm	A: 80 mm / B: 60 mm	A: 120 mm / B: 120 mm	A: 180 mm / B: 120 mm
DC3	PNP	M8 3 pin	XUVR0605P AIM8	XUVR0608P AIM8	XUVR1212P AIM8	XUVR1218P AIM8
	NPN	M8 3 pin	XUVR0605N AIM8	XUVR0608N AIM8	XUVR1212N AIM8	XUVR1218N AIM8
Çıkış fonksiyonu	NA		A	A	A	A
	NK		B	B	B	B

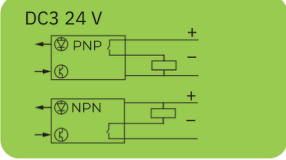

## Kablo

### bağlantısı

M8	PUR hazır kablolu konnektörler (dişi) (1)	Konnektörler (dişi)	
		düz	dirsekli
3 pin	2 m	XZCP0566L2	XZCP0666L2
	5 m	XZCP0566L5	XZCP0666L5
	10 m	XZCP0566L10	XZCP0666L10
4 pin	2 m	XZCP0941L2	XZCP1041L2
	5 m	XZCP0941L5	XZCP1041L5
	10 m	XZCP0941L10	XZCP1041L10
M12	PUR hazır kablolu konnektörler (dişi) (1)	Konnektörler	
		düz	dirsekli
		2 m	XZCP1141L2
4 pin	5 m	XZCP1141L5	XZCP1241L5
	10 m	XZCP1141L10	XZCP1241L10
	M12	PUR hazır kablolu konnektörler (dişi) (1)	Konnektörler
düz (erkek)			dirsekli
4 pin			XZCC12MDM40B
5 pin	XZCC12MDM50B	XZCC12MCM50B	

(1) Bir PVC kabloda, P harfinin ardından V harfi gelir, örneğin: XZCPxxxxx, XZCPVxxxxx olur.

# RFID Sistemleri: XG Serisi

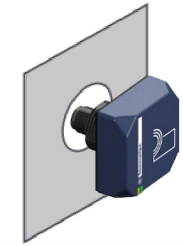
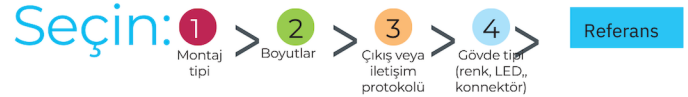

Panel montajı (1)

Kompakt 40x40mm Algılama mesafesi		
18-70mm		
1 darbeli PNP çıkışı Mavi gövde, konnektör	Modbus RTU	
arka tarafta	Uzak ışıklı beyaz gövde, arkada konnektör	Stand alone
XGCS491B201	XGCS49LB201	XGCS490B201

(1) ZB5AZ905 ve XGSZCNFAC ile uyumludur



Vida montajı

Kompakt 40x40mm	Kompakt 80x80mm	
Algılama mesafesi 18-	Algılama mesafesi 2	
70mm	Modbus RTU	Modbus TCP & Ethernet/IP
	100mm	
Mavi gövde, konnektörler ve kablo yanında		
XGCS4901201	XGCS8901201	XGCS850C201



Aksesuarlar

XGSZCNFAC	Konfigürasyon seti	XZCC12MDB50R	M12 konnektör
XGSZCNF01	Yapılandırma etiketi	XZCPV11V2L2/5/10	M12 kablolu konnektör
XGHB90E341	Kart formatlı	XZCPV12V2L2/5/10	M12 kablolu konnektör
XGHBPB3345	Anahtar formatlı		

Not: Sensör çözümlerimizin tamamı için [www.tesensors.com/tr](http://www.tesensors.com/tr) adresini ziyaret edin.

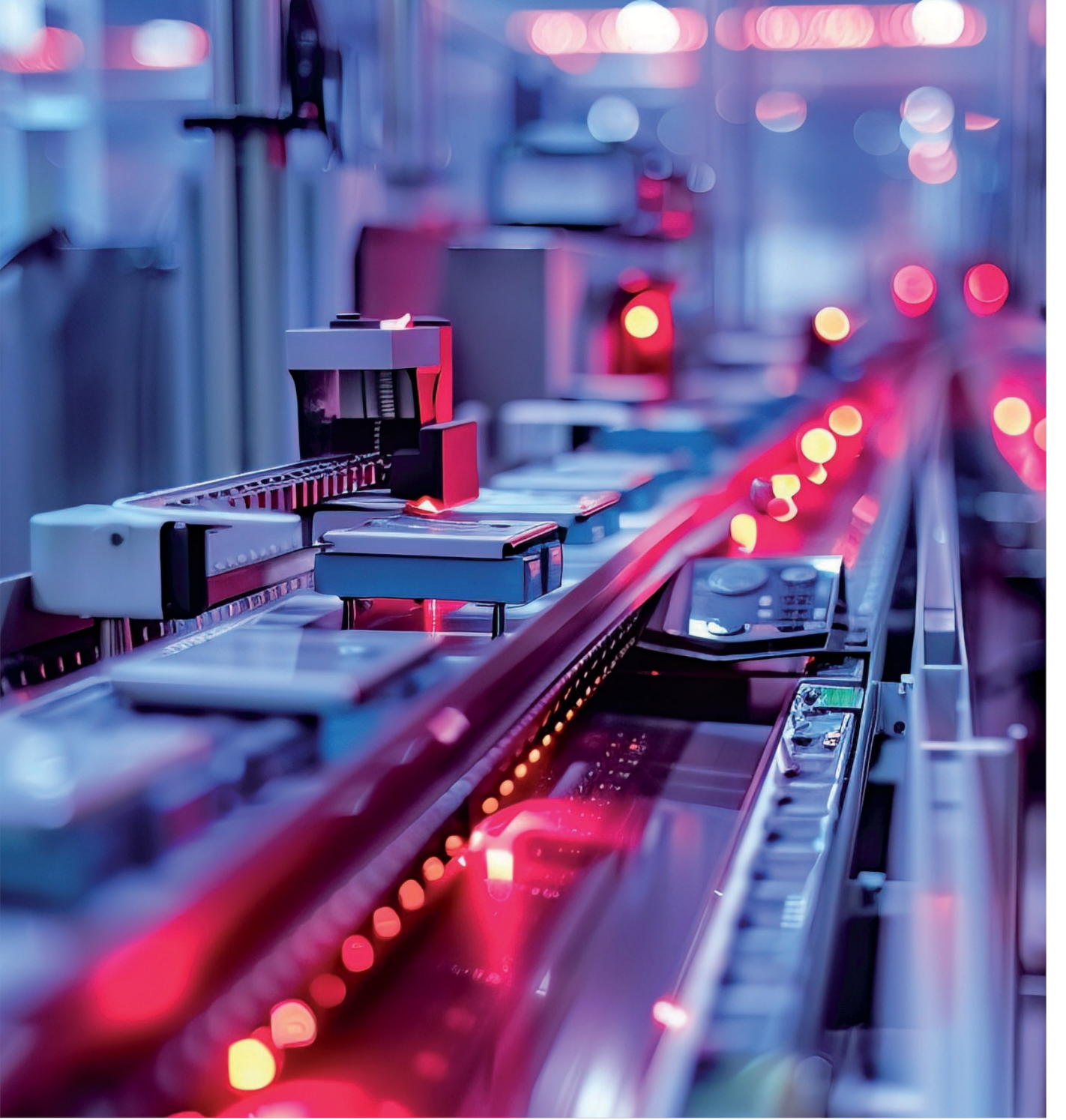

Tüm sensör serimizi keşfetmek için ziyaret edeceğimiz adresimiz: [www.telemecaniquesensors.com/tr](http://www.telemecaniquesensors.com/tr)

TESE Turkey  
Barbaros Mah. Kardelen Sok.  
Palladium Tower No:2 Kat:13  
Ataşehir/Türkiye  
Müşteri Destek Merkezi 0800 621 25 47  
[www.telemecaniquesensors.com/tr](http://www.telemecaniquesensors.com/tr)

Bu belgede verilen bilgiler, burada yer alan ürünlerin performansına ilişkin genel açıklamaları ve/veya teknik özellikleri içermektedir. Standartlar, teknik özellikler ve tasarım zaman zaman değiştiğinden, lütfen bu yayında verilen bilgilerin teyidini isteyiniz. Ne TMSS France, ne de iştirakleri veya diğer bağlı şirketleri, bu belgede yer alan bilgilerin yanlış kullanımından sorumlu veya bunlarla yükümlü değildir.

TelemecaniqueTM Sensors, TMSS Fransa tarafından lisans altında kullanılan Schneider Electric Industries SAS'in ticari markasıdır. Bu belgede atıfta bulunulan diğer markalar veya ticari markalar TMSS Fransa'nın veya duruma göre iştiraklerinin veya diğer bağlı şirketlerinin mülkiyetindedir. Diğer tüm markalar, ilgili sahiplerinin ticari markalarıdır.  
© 2024, TMSS France, Tüm Hakları Saklıdır