

Capital Cost Analysis of Immersive Liquid-Cooled vs. Air-Cooled Large Data Centers

White Paper 282

Version 1

by Robert Bungler
Wendy Torell
Victor Avelar

Executive summary

There are several known benefits of choosing liquid cooling over traditional air cooling including energy savings. Capital cost, however, is viewed as a common obstacle. In this paper, we first demonstrate that at a like-for-like rack density of 10 kW in a 2 MW data center, the data center capex is roughly equal for both a traditional air-cooled data center and a chassis-based immersive liquid cooled data center. Because high density compaction is a key benefit of liquid cooling, we also quantify the capex difference when liquid cooling is deployed at 20 kW/rack and 40 kW/rack for the same capacity data center. The result is 10% and 14% capex savings, respectively.

RATE THIS PAPER



Introduction

Liquid-cooled IT equipment is not new. It's been around for decades. We tend to hear about it for niche solutions – such as for high performance computing (HPC) and gaming. But today, there are some key trends and drivers that make it an appealing solution for the more mainstream IT audience. White Paper 279, [Five Reasons to Adopt Liquid Cooling](#) explains these reasons.

There are some clear benefits of liquid cooling over traditional air cooling. These include:

- **Reduced need for water** – Local municipalities are putting pressure on the data center industry in geographies with water resource constraints. Air cooling uses high volume of water for evaporative cooling, which is commonly used to achieve PUEs of <1.2.
- **Space savings** – Liquid cooling allows for significant compaction of the IT, which provides companies more placement options across the globe, including space constrained regions like Asia.
- **Energy savings** – The Green Grid has published a report about energy impact that showed up to 48% energy savings due to improved efficiency ([White Paper 70](#)).

Capex is less understood, however, and is often viewed as a common obstacle to liquid cooling adoption. In this paper, we analyze a 2 MW data center using both traditional air-cooled technology (air-cooled chiller) and liquid cooled technology (chassis-based immersive). We walk through different density scenarios for the liquid cooled technology, to show the impact it has on cost.

Figure 1 shows the results of the capex analysis overall. It demonstrates that for like densities (10kW/rack), the data center cost of an air-cooled and liquid-cooled data center are roughly equal. But as described above, liquid cooling also enables compaction of the IT, and with compaction, there is an opportunity for a capex savings. When compared to the traditional data center at 10 kW/rack, a 2x compaction (20 kW/rack) results in a first cost savings of 10%. When 4x compaction is assumed (40 kW/rack), savings goes up to 14%.

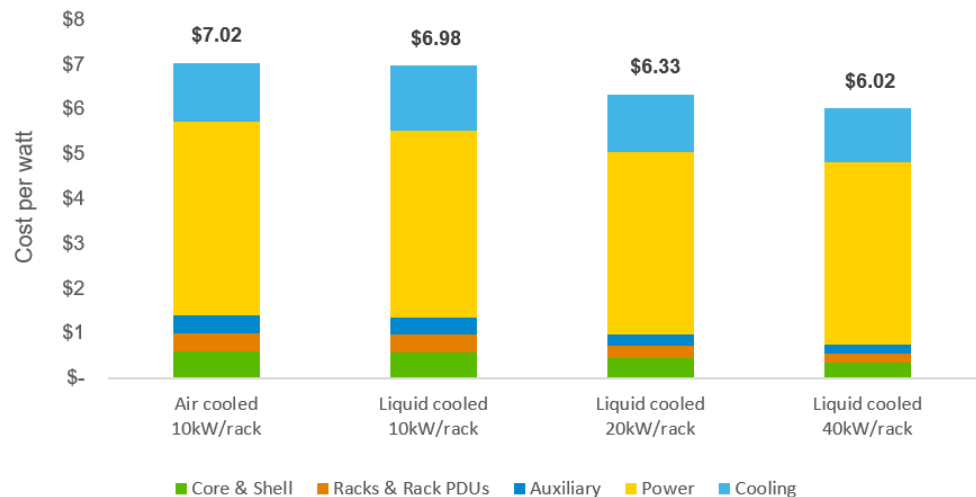

Figure 1
Capex overview

In the remaining sections of this paper, we will explain the architectures compared, describe the methodology, assumptions and data used in the analysis, and walk through waterfall diagrams to demonstrate where the cost differences exist.

Air-cooled architecture

The baseline case for this capital cost analysis is an air-cooled data center, using a packaged chiller. This architecture features:

- Redundant packaged air-cooled chillers
- Redundant pump package
- Redundant chilled water computer room air handling units (CRAH) for the IT space and facility spaces
- Hot aisle containment system with ducted plenum back to CRAHs
- No raised floor

This architecture was chosen as the baseline for comparison because it is a cost-effective design and very common for medium to large sized data centers. White paper 59, [The Different Technologies for Cooling Data Centers](#) describes this architecture in greater detail, as well as other common designs. **Figure 2** is a high-level diagram of this architecture.

Figure 2
Air-cooled architecture

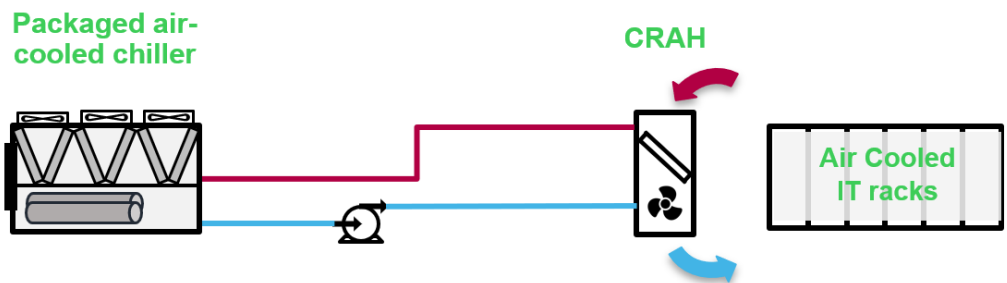

Liquid cooled architecture

For this analysis, we chose chassis-based immersive liquid cooling because it fits the familiar data center rack architecture and removes nearly all the heat via liquid. **Figure 3** is a high-level diagram of this liquid cooling approach. White Paper 265, [Liquid Cooling Technologies for Data Centers and Edge Applications](#) explains the architectures that exist, and the differences between them.

Figure 3
Chassis-based immersive cooling

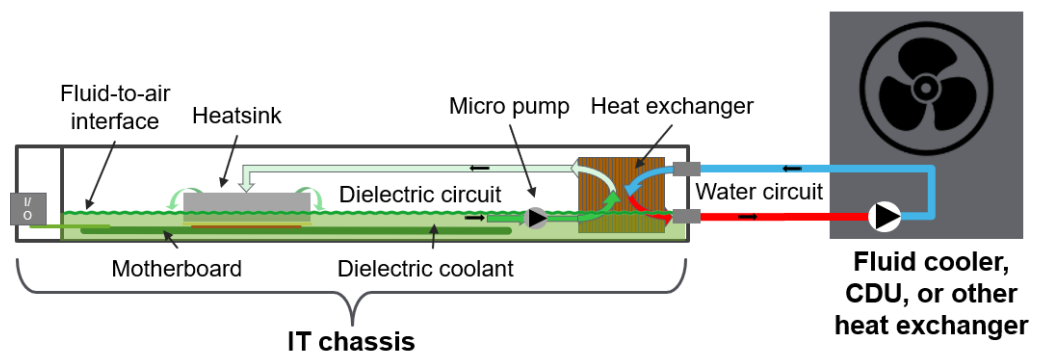

The facility infrastructure is greatly simplified with chassis-based immersive cooling since the IT equipment can use warm water for cooling. We assumed 40°C (104°F) as the inlet temperature, which allows for 100% free cooling in many climates. **Figure 4** is a high-level diagram of the architecture we analyzed.

Figure 4
Liquid cooled architecture

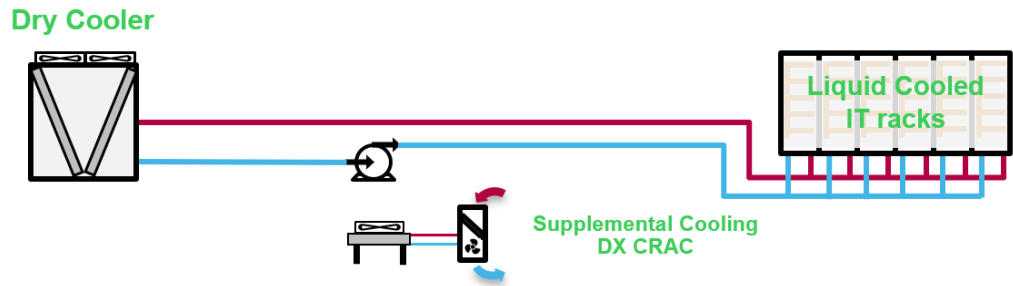

In this architecture, although most of the heat is rejected via the warm water loop, supplemental cooling is still required for electrical rooms, as well as removing IT equipment heat not captured in the warm water. This will maintain the facility air temperature suitable for people and ensure equipment temperature limits are not exceeded, for example, batteries and breakers.

Capex analysis with same density

We first analyzed the cost differences of a 2 MW data center at 10 kW/rack, for both the air-cooled architecture and liquid-cooled. **Table 1** provides the key assumptions of the architectures being compared.

Table 1
Architecture assumptions

	Air cooled packaged chiller	Chassis-based immersive liquid cooled
Core & Shell cost	\$90/sq ft (\$969/sq m)	
Power redundancy	2N power dist / 2N UPS / N+1 Generator	
IT equipment cost	Server cost not included	
Cooling redundancy	N+1 chiller, CRAH, & pumps	N+1 (DX CRAC / dry cooler / pumps)
IT design capacity (kW)	2,000	1,880
Non-cooling server capacity (kW)	1,820	1,820
IT equipment fan savings	N/A	9% *
Micro-pump penalty	N/A	3%
Rack heat loss to air	N/A	5.5%
Adiabatic cooling	Yes	No
Floor type	Hard floor	Hard floor
Containment	HACS	None
Chilled / Condenser water setpoint	20/30°C (68/86°F)	40/47.75°C (104/117.95°F)
Glycol %	25%	25%
IT room supply air setpoint	24°C (75.2°F)	23.8°C (74.84°F)
IT room supply air delta T	14°C (25.2°F)	9.8°C (17.64°F)
Electrical room supply air setpoint	24.6°C (76.28°F)	24.6°C (76.28°F)
Electrical room supply air delta T	8.4°C (15.12°F)	8.4°C (15.12°F)
Rack density (kW/rack)	10	9.4
Rack U height	42	42
Quantity of racks	200	200
Racks per pod	40	40

* A server fan energy value of 9% of overall server energy is conservative. Fan energy values of 15 – 20% have been measured, especially on high intensity compute equipment such as GPUs.

Before we present the findings, there are two important considerations we need to describe, as they (1) impact the ability to show an apples-to-apples comparison, and (2) explain the cost assumption for the emerging liquid cooled technology.

Normalizing data center cost per watt – Communicating the cost to build a data center is traditionally done as cost per IT watt capacity. For example, if a data center can host up to 2 MW of IT load, and it cost \$20 million USD to build, then its cost is \$10/watt. Costs can vary greatly based on redundancy or architecture choices.

When comparing an air-cooled architecture to liquid cooled architectures, we were faced with a challenge when calculating cost per IT watt. For the same amount of compute, liquid cooling has a lower overall IT load. Internal IT fans of air-cooled servers consume more power than the internal micro-pumps for chassis-based immersion, for the same IT compute load. To compensate for this, **we defined the IT load as “non-cooling server capacity”** and used that for the denominator in the cost/watt calculations. This is shown in our assumptions (**Table 1**) as well as total IT design capacity for both air-cooled and chassis-based immersion.

Chassis-based immersion cost assumptions – For this liquid cooling architecture, there is technology and associated costs added to the IT equipment to enable liquid cooling. For the purposes of this analysis, we aggregated all the costs that would be incurred inside the server as well as the rack. This includes: dielectric fluid, micro pumps, tubing, heat exchanger(s), liquid heat sinks, dripless connectors, sealed chassis, and rack water manifold. Note that for chassis level immersion, there is a savings for air heat sinks and fans, so the cost in this study is the assumed delta. Chassis level immersive technology is not fully mature, so costs can vary quite a bit from one-off proof of concept, to future optimized supply chain. We conducted a sensitivity analysis on these costs and estimate the range to be ~\$1.10/watt on the high side and ~\$0.50/watt on the low side. For this study, we chose \$0.77/watt at 10kW / rack as a conservative value that should be achievable in any at-scale deployment. Note that this value improves as density goes up from the baseline of 10 kW/rack. Our study considers savings such as fewer rack manifolds and chassis per kW of IT when there is compaction.

Findings

Many cost studies on liquid cooling consider overall TCO as well as compaction. This makes it difficult to understand where the savings occur or where costs shift. This study focuses only on capex and first looks at like-for-like rack density then shows two more scenarios of increasing densities.

The waterfall chart in **Figure 5** shows the main categories of costs and their change. The costs are inclusive of equipment, installation, design, and project costs. At 10 kW per rack this shows that a 100% chassis immersed data center would cost roughly the same as a traditional air-cooled data center.

Figure 5

Cost/watt difference of air-cooled vs liquid-cooled data center, both at 10 kW/rack

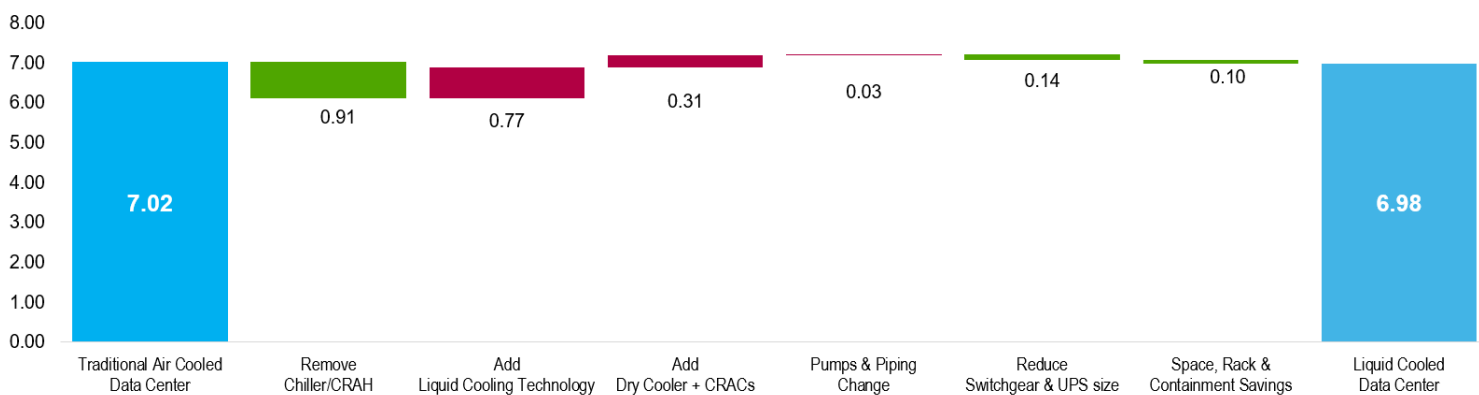

Chiller/CRAH – \$0.91/W savings. This represents the removal of the air-cooled chillers and computer room air handlers (CRAHs).

Liquid cooling technology – \$0.77/W premium. This premium represents the increase in costs at the server and rack level. As mentioned previously, this includes the sealed chassis, dielectric fluid, liquid heat sinks, tubing, micro pumps, heat exchanger, dripless connectors, and rack manifold.

Dry coolers & CRACs – \$0.31/W premium. This architecture can reject heat directly to a dry cooler, without the aid of compressors. This cost adder includes N+1 dry coolers, as well as additional DX computer room air conditioners (CRACs) to remove the heat that the warm fluid cannot. Note that other architectures are possible, such as downsizing the chiller and using CRAHs, which might provide benefits for larger facilities.

Pumps & piping change – \$0.03/W premium. This small cost increase considers changes from the chilled water (CW) piping to warm water piping for liquid cooled servers. Additional piping needs to be run down the rows of racks with take-off valves for each rack. This is nearly offset from the savings of no piping insulation. A benefit for liquid cooling is that much of the piping does not need to be insulated. With water temperatures at 40°C (104°F), there is little to no chance of condensation. The pumping system is N+1 and the water loop design provides for maintenance of sections of racks.

Readers familiar with liquid cooling deployments may note that we have not mentioned a “CDU”. A cooling distribution unit (CDU) is a device that separates the Facility Cooling System (FCS) from the Technical Cooling System (TCS), which is the water supplied to the racks. CDUs provide several functions, such as:

- ensuring water to racks is the right chemistry and cleanliness. This is important for many cold plate deployments and where the FCS is of poor quality.
- providing warm water loop to racks in mixed facility, when connecting to a CW loop.
- maintaining a lower water pressure than FCS, especially needed in multi-story piping systems.

It is analogous to a transformer in an electrical design, providing separation of two systems for multiple purposes. We did not include CDUs in our architecture because the layout is single story, the water loop is dedicated to liquid cooling, and chassis immersion heat exchangers are quite robust and can accept facility quality water. As a rule of thumb, CDUs will add about \$0.10 to \$0.20 per watt of capex.

Reduce UPS & switchgear size – \$0.14/W savings. Removal of the chiller system and CRACs reduces the amount switchgear provisioned for cooling. Additionally, since the IT load is slightly lower due to the change from IT fans to micropumps, fewer UPSs and batteries are needed.

Space, rack & containment savings – \$0.10/W savings. Although there is no compaction of the IT white space, facility space is saved by the reduction of cooling system switchgear and UPS systems. Savings include other associated costs linked to space, like fire suppression, lighting, etc. Additionally, liquid cooling does not require any air containment, so this is removed.

The impact of compaction

As we discussed in the introduction, one of the known benefits of liquid cooling is the ability to compact the IT equipment and save space. But beyond space savings, this compaction allows for less IT racks and less rack PDUs. In this section, we quantify the total capex of a data center with 2x compaction and one with 4x compaction, using chassis-immersive liquid cooling, and compare those scenarios to our baseline of the air-cooled data center at 10 kW described earlier.

Table 2 provides the new assumptions for rack density, and number of racks, given this compaction. All other assumptions remain the same as the original liquid cooled scenario in **Table 1**.

Table 2
Assumption variables that change for compaction scenarios

	Chassis-based immersive liquid cooled at 2x compaction	Chassis-based immersive liquid cooled at 4x compaction
Rack density (kW/rack)	18.8	37.6
Rack U height	42	42
Quantity of racks	100	50
Racks per pod	20	10
Number of pods	5	5

Findings at 2x compaction

We started first with a 2x compaction, meaning the density per rack for liquid cooling is 20 kW/rack vs. the 10 kW/rack for the air-cooled architecture. **Figure 6** illustrates the capex savings of 10%.

Figure 6
Cost/watt difference of air-cooled vs liquid-cooled data center, accounting for 2x compaction (20 kW/rack) for liquid cooling

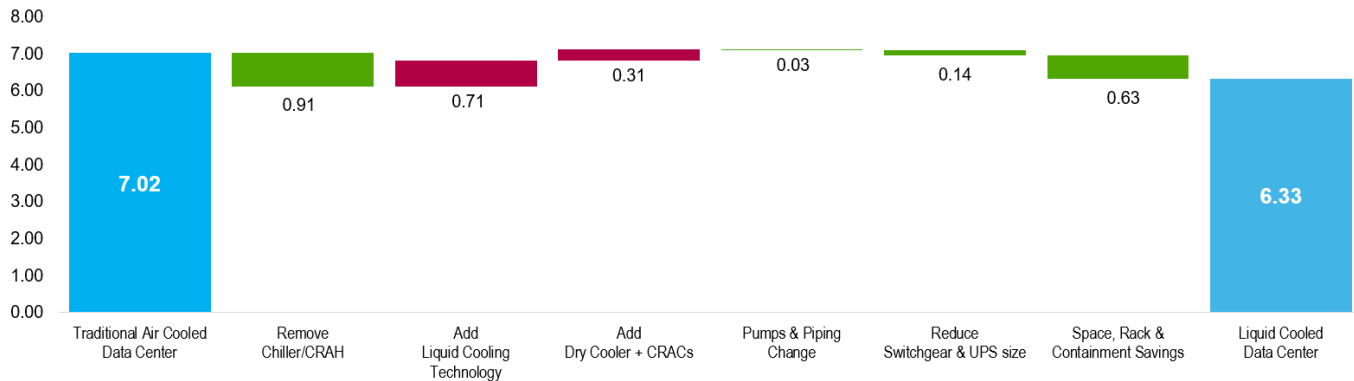

Chiller/CRAH – \$0.91/W savings. This savings is identical to the 10 kW/rack scenario and represents the removal of chillers and CRAH units.

Liquid cooling technology – \$0.71/W premium. This is a smaller cost increase than the 10 kW/rack scenario. There is an improvement to this cost when increasing rack density since fewer rack manifolds are needed.

Dry coolers & CRACs – \$0.31/W premium. This is the same as at 10 kW/rack, as the total IT load and associated losses are the same.

Pumps & piping change – \$0.03/W savings. Although piping is required down each row and to the rack compared to the air-cooled scenario, as the IT space contracts & rack kW increases, less piping and valves are required compared to the 10 kW/rack scenario. Note that generally the pipe diameter increases as density

increases, but the price difference between the pipes isn't as significant as the decrease in the number of racks.

Reduce UPS & switchgear size – \$0.14/W savings. This is the same as the 10kW scenario, as rack density doesn't impact the UPS and switchgear sizing.

Space, rack & containment savings – \$0.63/W savings. This significant savings is comprised core & shell savings, fewer rack and rack PDUs and less structure over the racks for cabling supports. Savings are also achieved in fire suppression and lighting as the IT space gets smaller.

Findings at 4x compaction

The next compaction scenario we compared was 4x compaction, or 40 kW/rack for the liquid-cooled architecture, compared to 10 kW/rack for air-cooled. As compaction increases, the capex savings increases. **Figure 7** illustrates the resulting capex savings of 14%.

Figure 7
Cost/watt difference of air-cooled vs liquid cooled data center, accounting for 4x compaction (40 kW/rack) for liquid cooling

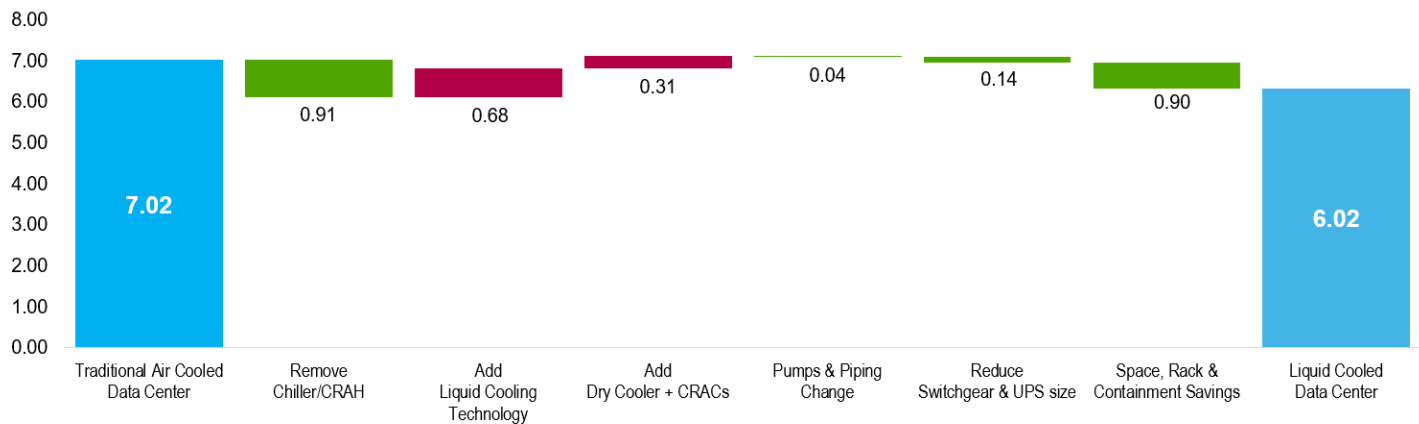

Chiller/CRAH – \$0.91/W savings. This savings is again identical to the 10 kW/rack and 20 kW/rack scenarios and represents the removal of chillers and CRAH units.

Liquid cooling technology – \$0.68/W premium. This is a smaller cost increase than the 20 kW/rack scenario. There is an improvement to this cost when increasing rack density. Fewer rack manifolds are needed, which improves the overall cost / watt in this category.

Dry coolers & CRACs – \$0.31/W premium. This is the same as at 10 kW/rack and 20 kW/rack scenarios, as the total IT load and associated losses are the same.

Pumps & piping change – \$0.04/W savings. This is a slightly higher savings than the 20 kW/rack scenario as the IT space shrinks and fewer racks are supplied water.

Reduce UPS & switchgear size – \$0.14/W savings. This is the same as the 10 kW/rack and 20 kW/rack scenarios.

Space, rack & containment savings – \$0.90/W savings. An additional \$0.27/W is saved over the 20 kW per rack design. This significant savings is comprised core & shell savings, fewer rack and rack PDUs, and less structure over the racks for

cabling supports. Savings are also achieved in fire suppression and lighting as the IT space gets smaller.

Conclusion

Liquid cooling has been around for some time now, but recently has gained interest for more mainstream data center applications. While the energy savings are clear, some are concerned about the capital cost implications. This paper demonstrates that deploying chassis-based immersive liquid cooling is similar in capital cost to air cooling when deploying at equivalent rack densities and can save up to 14% when compacting the IT equipment (and therefore the racks) by a factor of four.

Although chassis-based immersive cooling is not a mature technology, these costs are representative of a near-term deployment at scale. Additional savings can be expected as the technology and manufacturing efficiencies improve.

About the authors

Robert Bunger is a Program Director within the CTO office at Schneider Electric. In his 21 years at Schneider Electric, Robert has held management positions in customer service, technical sales, offer management, business development & industry associations. While with APC / Schneider Electric, he has lived and worked in the US, Europe, and China. Prior to joining APC, he was a commissioned officer in the US Navy Submarine force. Robert has a BS in Computer Science from the US Naval Academy and MS EE from Rensselaer Polytechnic Institute.

Wendy Torell is a Senior Research Analyst at Schneider Electric's Data Center Science Center. In this role, she researches best practices in data center design and operation, publishes white papers & articles, and develops TradeOff Tools to help clients optimize the availability, efficiency, and cost of their data center environments. She also consults with clients on availability science approaches and design practices to help them meet their data center performance objectives. She received her bachelor's of Mechanical Engineering degree from Union College in Schenectady, NY and her MBA from University of Rhode Island. Wendy is an ASQ Certified Reliability Engineer.

Victor Avelar is the Director and Senior Research Analyst at Schneider Electric's Data Center Science Center. He is responsible for data center design and operations research, and consults with clients on risk assessment and design practices to optimize the availability and efficiency of their data center environments. Victor holds a bachelor's degree in mechanical engineering from Rensselaer Polytechnic Institute and an MBA from Babson College. He is a member of AFCOM.

RATE THIS PAPER 



 [Liquid Cooling Technologies for Data Centers and Edge Applications](#)
White Paper 265

 [Five Reasons to Adopt Liquid Cooling](#)
White Paper 279

 [Browse all white papers](#)
whitepapers.apc.com

 [Data Center Capital Cost Calculator](#)
TradeOff Tool 4

 [Browse all TradeOff Tools™](#)
tools.apc.com

Contact us

For feedback and comments about the content of this white paper:

Data Center Science Center
dcsc@schneider-electric.com

If you are a customer and have questions specific to your data center project:

Contact your Schneider Electric representative at
www.apc.com/support/contact/index.cfm

Appendix

Drawings

The appendix contains the high-level floor layouts and piping diagrams that were used as the basis for the cost analysis. The detail may be difficult to read at this page size, so feel free to reach out to the Data Center Science Center at dcsc@se.com if you are interested in the raw drawing files.

The layout drawings included are:

- Air-cooled layout at 10 kW/rack – Page 12
- Liquid-cooled layout at 10 kW/rack – Page 13
- Liquid-cooled layout at 20 kW/rack – Page 14
- Liquid-cooled layout at 40 kW/rack – Page 15

The piping diagrams included are:

- Air-cooled layout at 10 kW/rack – Page 16
- Liquid-cooled layout at 10 kW/rack – Page 17
- Liquid-cooled layout at 20 kW/rack – Page 18
- Liquid-cooled layout at 40 kW/rack – Page 19

Air-cooled floor layout, 10kW per rack

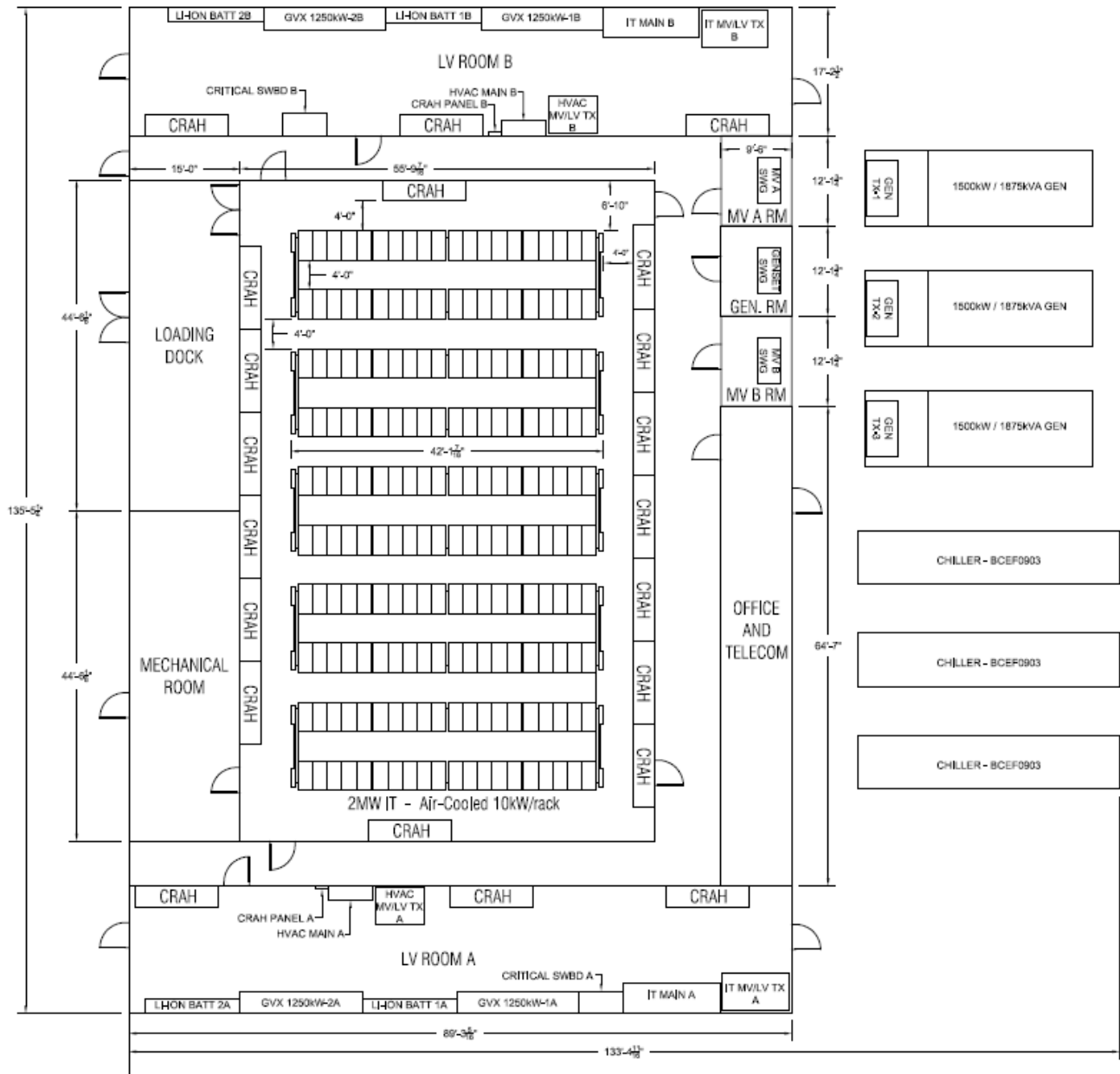

Chassis immersion floor layout, 10kW per rack

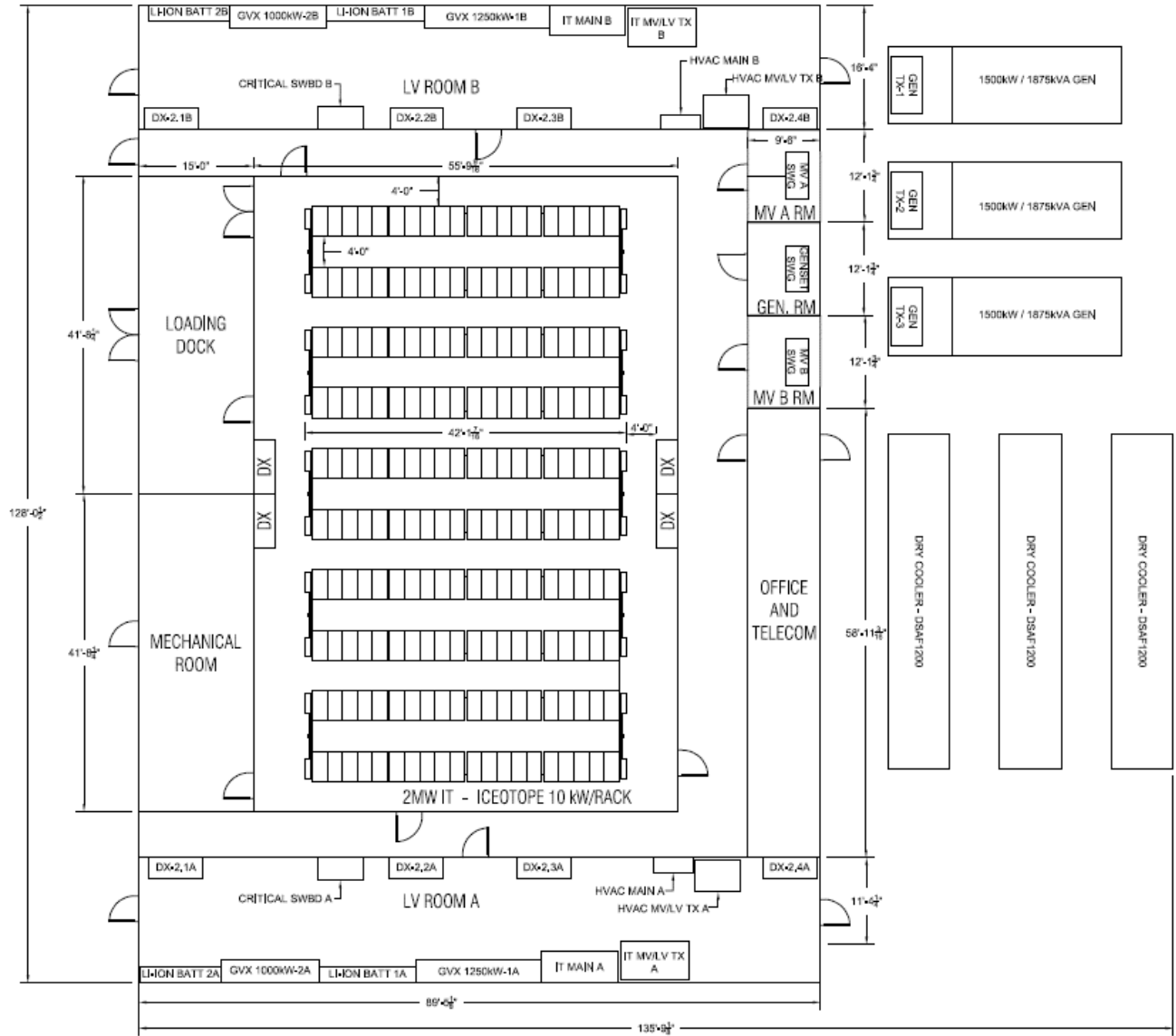

Chassis immersion floor layout, 20kW per rack

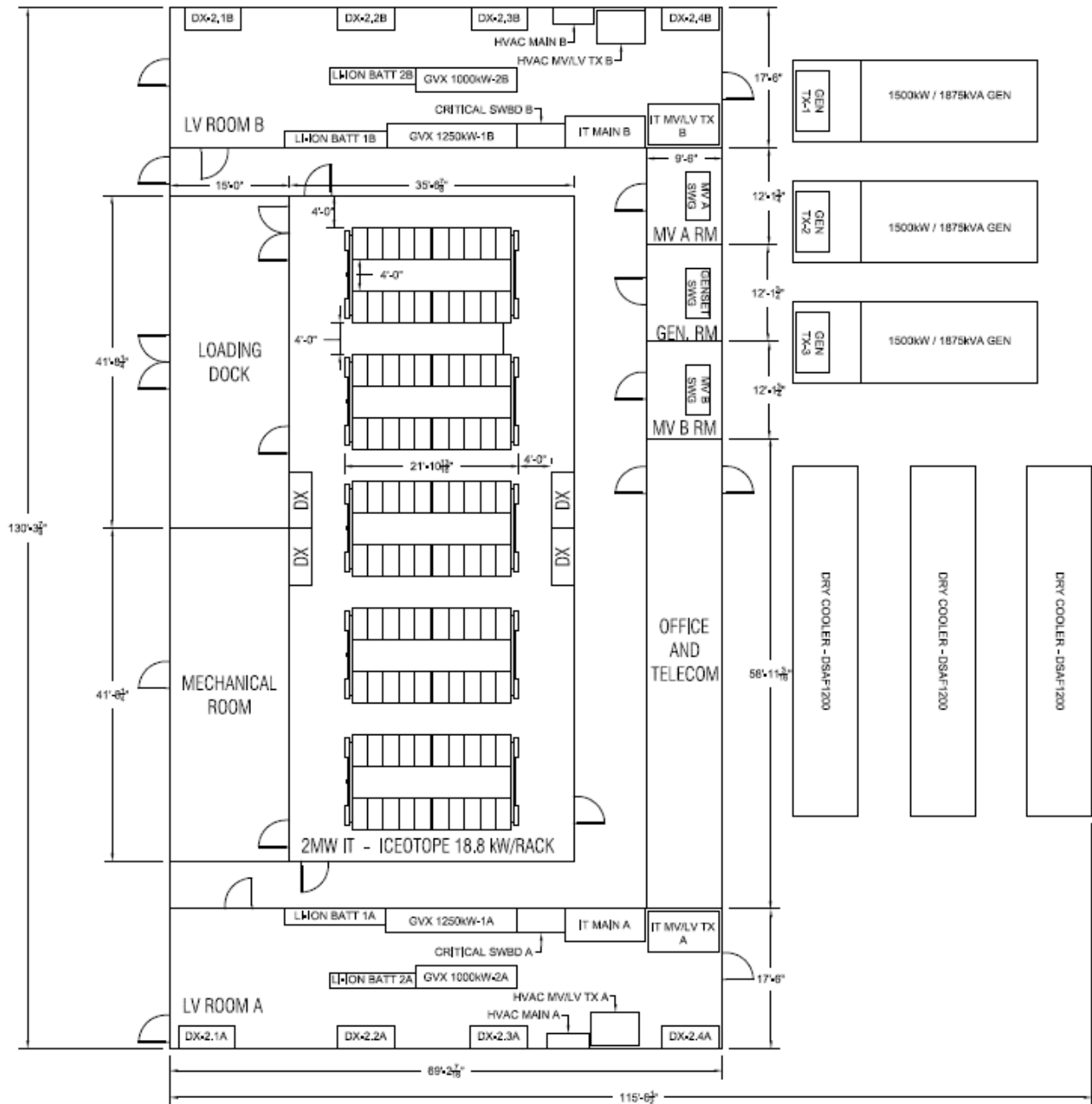

Chassis immersion floor layout, 40kW per rack

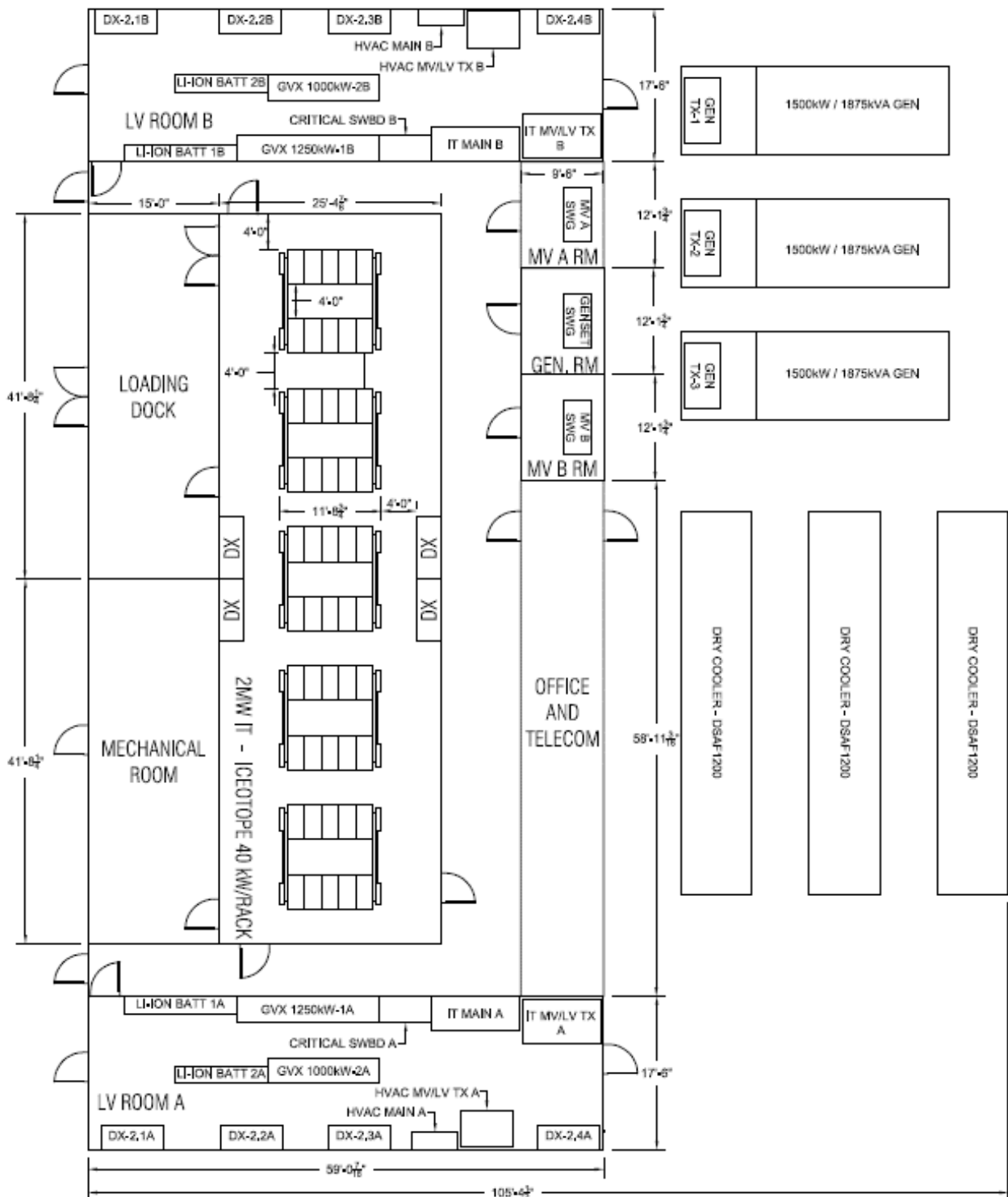

Air-cooled piping diagram, 10kW per rack

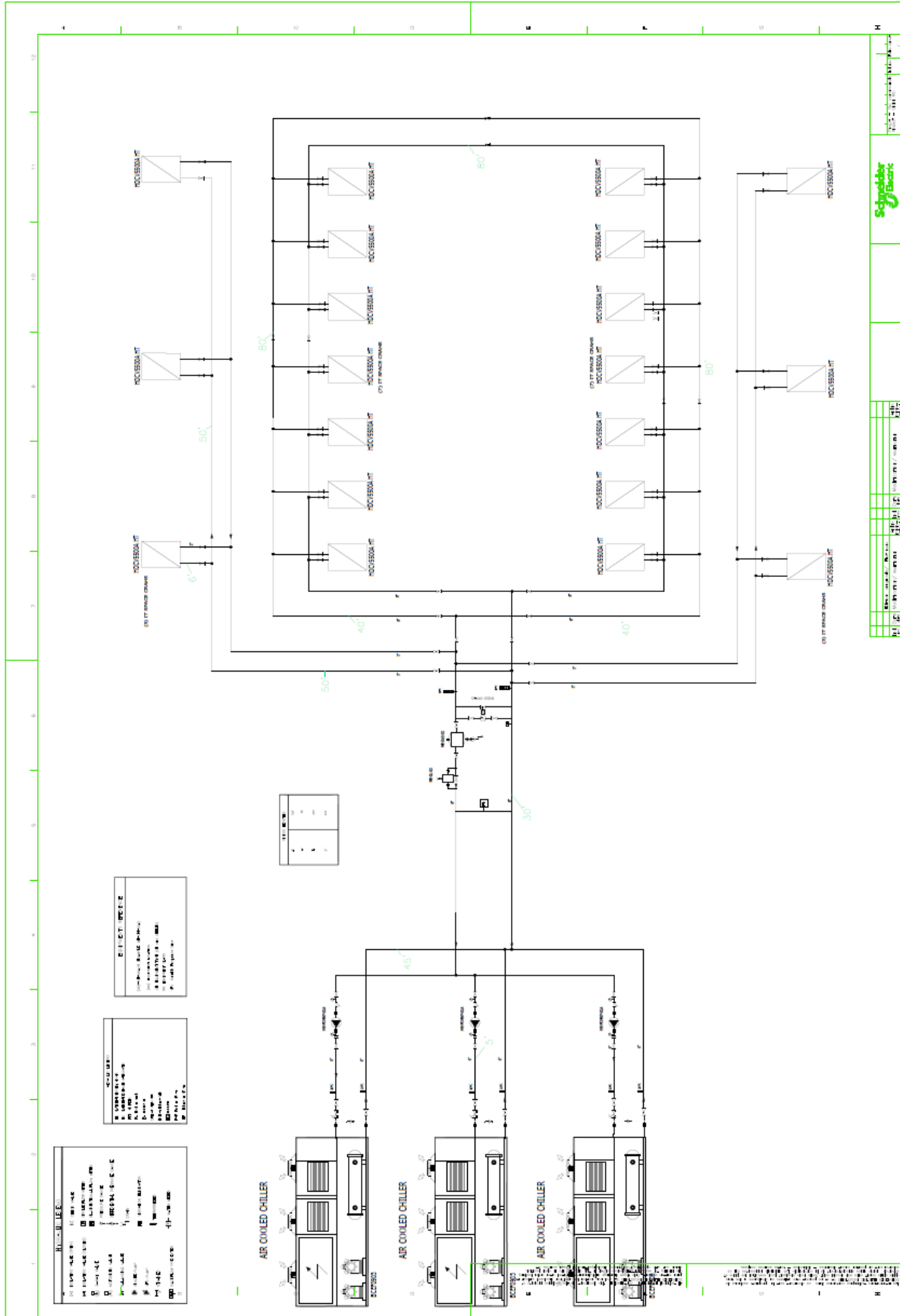

Chassis immersion piping diagram, 10kW per rack

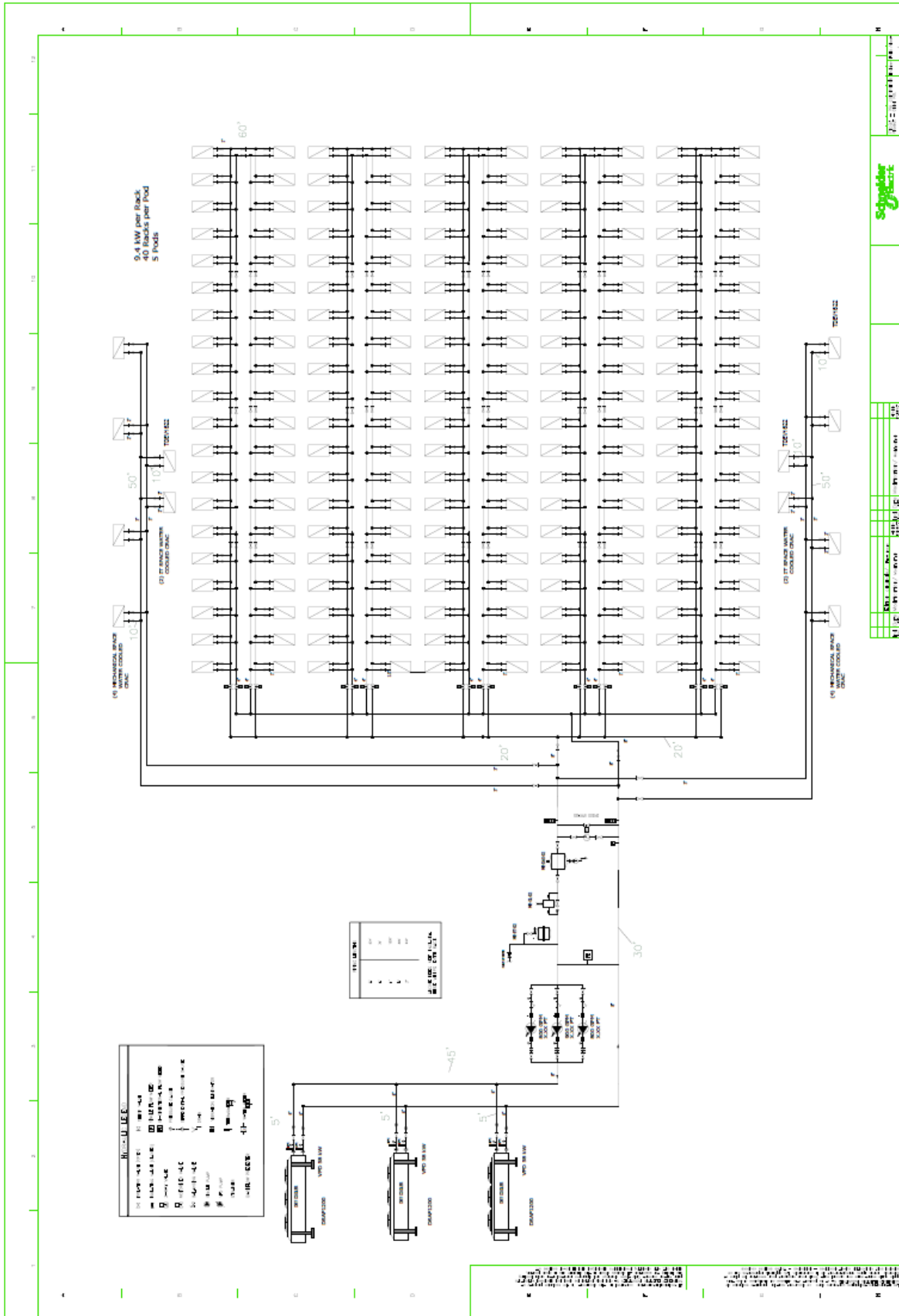

Schneider Electric
 2011-2012
 10kW per rack
 40 racks per pod
 5 Pods

Chassis immersion piping diagram, 20kW per rack

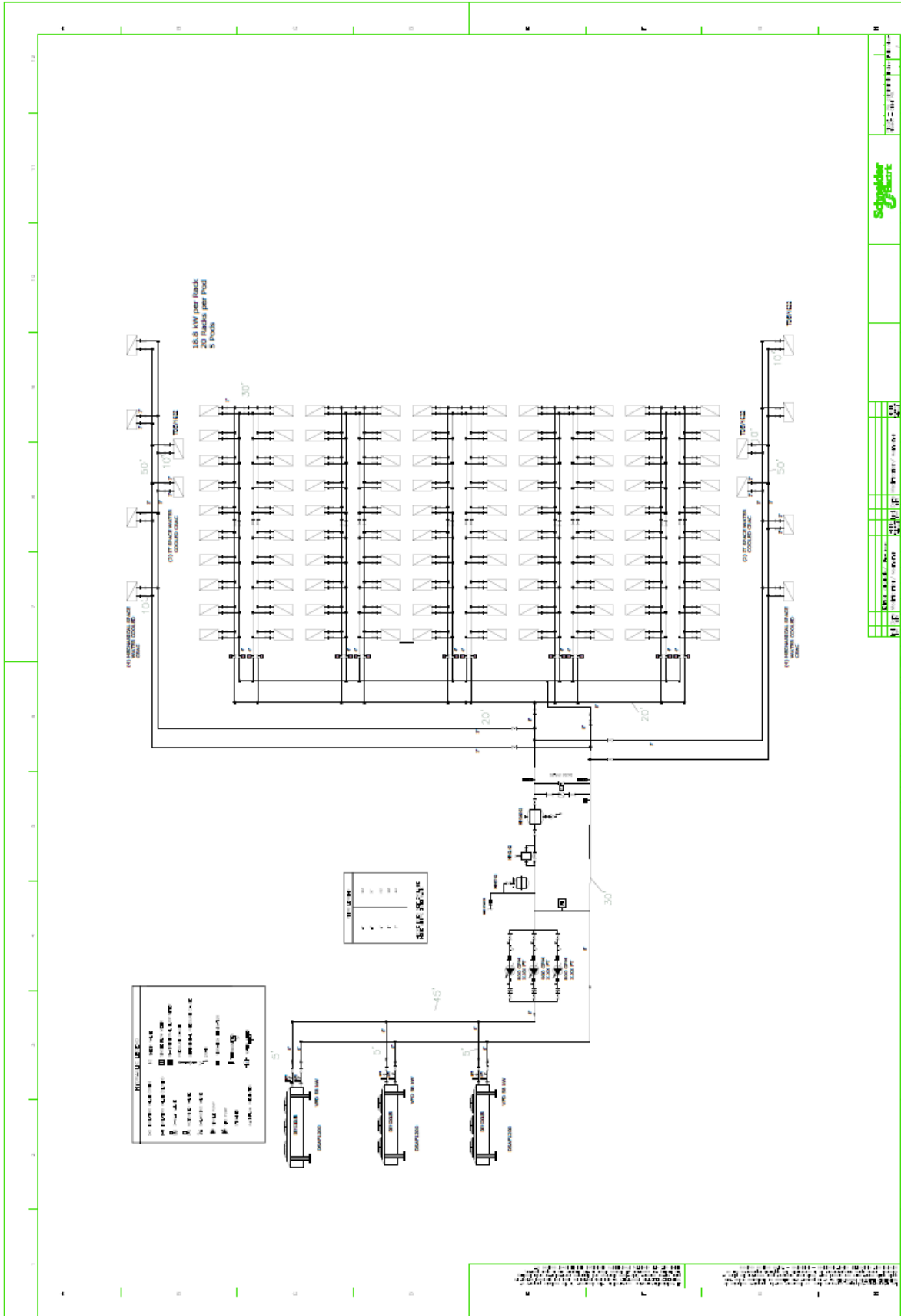

Chassis immersion piping diagram, 40kW per rack

