

LEFT SIDE VIEW

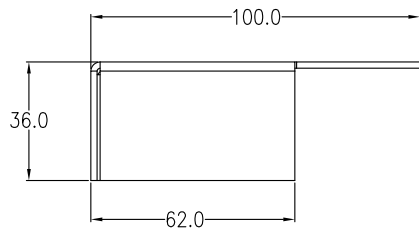

FRONT VIEW

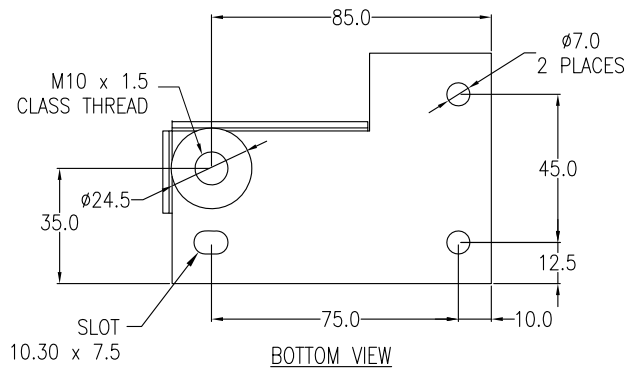

BOTTOM VIEW

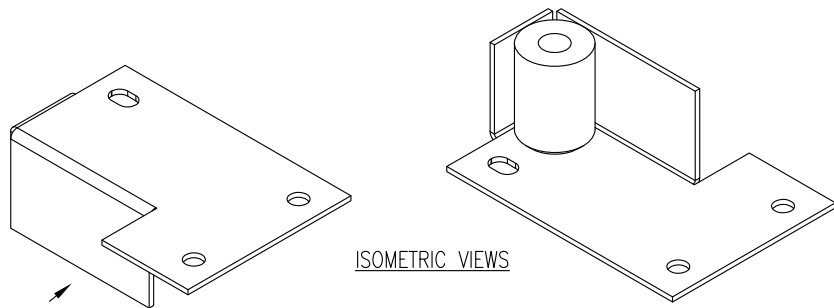

ISOMETRIC VIEWS

CHANNEL MOUNTING BRACKET KIT (AR7709)

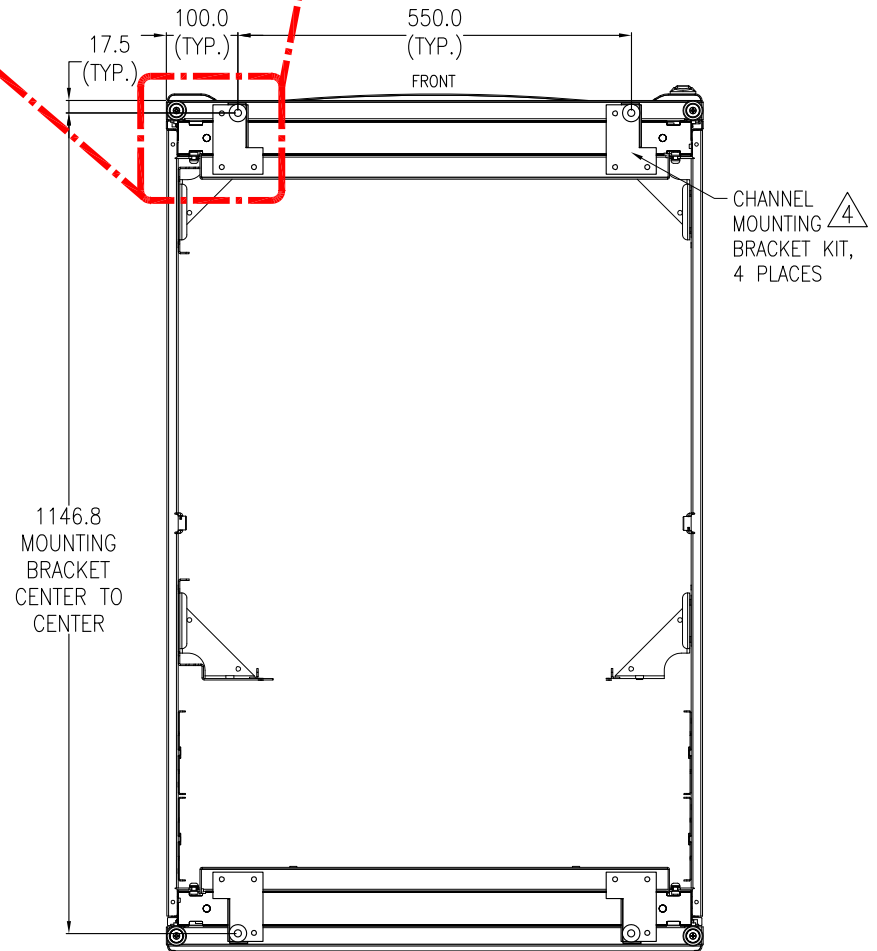
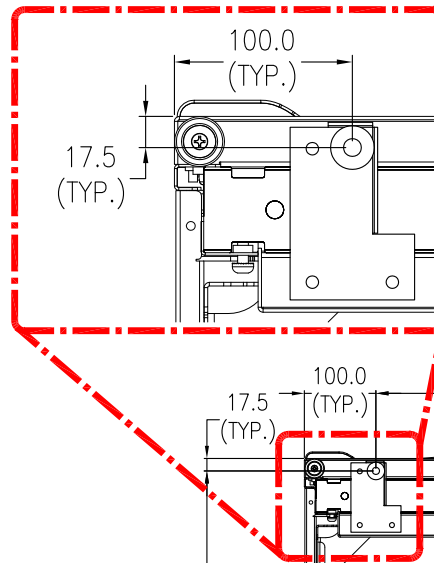

1146.8
MOUNTING
BRACKET
CENTER TO
CENTER

BOTTOM VIEW (AR3355)

WITH CHANNEL MOUNTING BRACKET KIT (AR7709)

NOTES:

1. INSTALLATION MUST COMPLY WITH ALL APPLICABLE NATIONAL AND LOCAL CODES.
2. ALL DIMENSIONS ARE MILLIMETERS.
3. PLEASE REFER TO INSTALLATION MANUAL: 990-2912 FOR CHANNEL BRACKET INSTALLATION DETAILS.
- △4. CHANNEL MOUNTING BRACKET KIT (SKU# AR7709) IS OPTIONAL AND HAS TO BE ORDERED SEPARATELY.
5. FOR ADDITIONAL DIMENSIONS FOR THE RACK, PLEASE REFER TO SUBMITTAL DRAWING AR3355.

THIS DRAWING AND SPECIFICATIONS HEREIN ARE THE PROPERTY OF SCHNEIDER ELECTRIC AND SHALL NOT BE COPIED, REPRODUCED OR USED IN WHOLE OR IN PART, AS THE BASIS FOR THE MANUFACTURE OR SALE OF ITEMS WITHOUT WRITTEN PERMISSION FROM SCHNEIDER ELECTRIC. THIS DRAWING IS BASED UPON LATEST AVAILABLE INFORMATION AND IS SUBJECT TO CHANGE WITHOUT NOTICE.



TITLE:
NetShelter SX, 45U
AR3355 BOTTOM VIEW
750mm WIDE x 1200mm DEEP
w/ AR7709 CHANNEL MOUNTING BRACKET KIT

DWG NO: AR3355-AR7709

REV. 0

DRAWN: S CUNHA 10FEB2015

ENGINEER: R JIN 10FEB2015

APPROVED: J SUN 10FEB2015

THIRD
ANGLE
PROJ

PROJECT: SUBMITTAL DRAWING SHEET: 1 OF 1