

# The Role of Isolation Transformers in Data Center UPS Systems

## White Paper 98

Revision 0

by Neil Rasmussen

### > Executive summary

Most modern UPS systems do not include the internal transformers that were present in earlier designs. This evolution has increased efficiency while decreasing the weight, size, and raw materials consumption of UPS systems. In the new transformerless UPS designs, the transformers are optional and can be placed in the best location to achieve a required purpose. In older designs, transformers were typically installed in permanent positions where they provided no benefit, reduced system efficiency, or were not optimally located.

This paper considers the function of transformers in UPS systems, when and how transformers should be used, and how the absence of internal transformers in newer UPS designs frequently improves data center design and performance.

### Contents

*Click on a section to jump to it*

Introduction	2
The role of transformers in UPS systems	2
Transformer arrangements in practical UPS systems	10
Transformer-based legacy UPS designs	21
Transformer options within a UPS product	24
Conclusion	25
Resources	26

## Introduction

Every data center power system includes transformers. Isolation transformers have historically had a number of different roles in the power architecture of data centers:

- Voltage stepdown from medium-voltage mains supply to the utilization voltage
- Within a UPS, to act as an integral part of the power conversion circuits
- To create a local ground-bonded neutral
- Within power distribution units or a UPS, to reduce harmonic currents
- To provide taps to accommodate abnormally high or low mains voltage
- To eliminate ground loops with multiple generators or mains sources
- Within power distribution units, for stepdown from the data center distribution voltage of 480V or 600V to 208V (North America only)
- Within power distribution units, to provide additional utilization voltages (e.g., 120V in North America and 100V in Japan)

“ In almost all cases where a transformer is needed, the transformerless UPS design is superior because it allows the transformer to be installed in a more optimal part of the power path ”

UPS systems have historically had one or more permanently installed internal isolation transformers to provide one or more of the above functions, depending on the design of the data center power system. Newer UPS systems do not require power transformers as part of their circuits, improving efficiency and reducing weight, size, and cost. Instead, transformers are added to a transformerless UPS as needed to achieve a desired function. This paper will show why, in most data center power system designs, transformerless UPSs provide the same function and performance as older UPSs with internal transformers. Nevertheless, there are many cases where a transformer is required and must be either internal to the UPS or added externally. Even older UPS systems with internal transformers require additional external transformers in many cases. Most importantly, this paper explains why in almost all cases where a transformer is needed, the transformerless UPS design is superior because it allows the transformer to be installed in a more optimal part of the power path.

First, this paper explains why older UPSs have transformers and the circumstances under which transformerless UPSs behave differently. Second, different transformer arrangements will be reviewed and the preferred arrangements will be described. This paper focuses on the use of transformers specifically in relation to UPS systems.

## The role of transformers in UPS systems

It is widely believed that internal transformers were originally provided in UPS systems in order to provide galvanic isolation between the UPS input and output. **This is false.** The reason internal transformers were used in early UPS systems is because they were inherently required due to the power inverter technology used in the UPS design.

The first UPS products were developed over 40 years ago and used a ground-referenced battery system. The grounded electronics and battery configuration required these systems to have two transformers for isolation from the mains – one on the input rectifier, and one in the output inverter. Later improvements in these designs, where the battery bus was moved to the neutral wire or electrically floated, eliminated one of the transformers, typically removing the rectifier transformer. Taking advantage of high-voltage, high-speed power semiconductors that did not exist 15 years ago, most recent UPS designs use newer designs that eliminate **both** the input and output transformer.

In some data center power system designs, no transformers are needed in conjunction with the UPS; but there are many situations where transformers must, or are advised to be, installed in combination with the UPS. This paper will explain that there are 92 different possible combinations of transformers used with a single UPS system, with many more combinations possible with parallel or other redundancy configurations. It is not possible to consider the use of transformers in a UPS system without understanding the important differences between the different options.

The configuration of a UPS system falls into three basic categories, differentiated by the presence of a static bypass and how it is connected. These three categories are commonly called **single mains**, **dual mains**, and **single mains without bypass**. They are schematically illustrated in **Figure 1**.

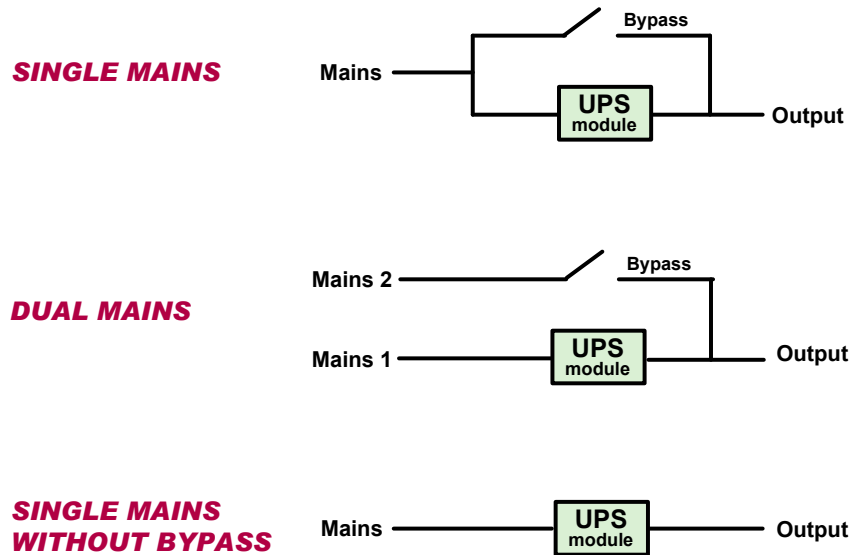

**Figure 1**

Three basic configurations of mains and bypass for a UPS system

In the **single mains** configuration, one mains connection supplies both the bypass and UPS module which are connected together at the UPS. This is the most common arrangement, and is the only arrangement supported in many small UPS systems. It is found in most smaller data center installations and also found in many large data center installations. The main benefits of this system are the simplicity and low cost of installation and the fact that many complexities relating to circulating currents and grounding are eliminated. The downside of this system is that the actual mains supply system cannot be taken down for maintenance without disrupting power to the critical load, although some of these disadvantages can be overcome with wraparound breakers on the mains.

The **dual mains** configuration is required when the bypass is fed from a second mains that is different from the mains feeding the UPS rectifier input. The difference in the mains can range from minor (e.g., they are fed from different breakers on the same panel) to major (e.g., they come from completely independent sources with different ground systems and even different voltages). There are a variety of data center redundancy architectures that specify this type of configuration (see *White Paper 75, Comparing UPS System Design Configurations*). Another reason for the dual mains configuration is to allow either of the two mains to be taken down for maintenance while providing power to the critical load. Note that this configuration can be used, but is not required, when a generator is used, since the generator is typically connected to the mains bus upstream of the UPS with an automatic transfer switch (ATS) so that it can provide power to other loads, such as chillers, in addition to the UPS. The dual mains configuration is required in some data center architectures, and is chosen by preference in many larger data centers in order to allow for concurrent

maintenance and/or to slightly improve the overall system reliability by preventing the wiring and breaker upstream of the UPS from being a single failure point for the power system.

The final configuration, **single mains without bypass**, is mainly used in environments where the mains power quality is considered to be extremely poor, to the point where it has been determined that it is not desired to ever power the critical load from the mains via a bypass. This can occur in industrial situations, shipboard, or on small islands, where the mains frequency (50 or 60Hz) is not the same as the IT load frequency, or in stressed electrical grids in developing nations. In some countries (the United States, for example) this is an extremely uncommon approach, but in others (India, for example) it is quite common and may be the majority of installs in some regions.

Note: A complete analysis comparing the three configurations above would involve tradeoffs in price, complexity, reliability, maintainability, and power quality; such an analysis is beyond the scope of this paper. This paper will focus on how to use transformers in each configuration.

The three configurations described above can include one or more transformers in the power path. **Figure 2** shows the possible locations of transformers in the three UPS configurations.

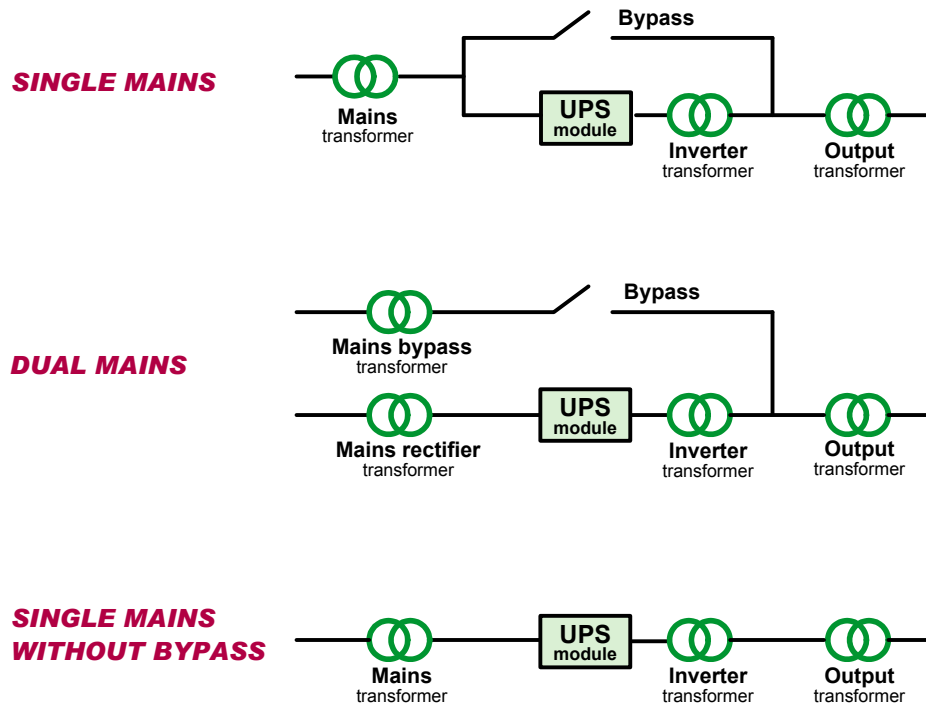

**Figure 2**

*Possible location of isolation transformers in the three basic UPS system configurations*

The basic configurations shown in **Figure 2** – various combinations of UPS modules, transformers, and bypass – are referred to in this paper as “UPS systems”. Likewise, “UPS module” refers to the power converters and energy storage component of the UPS system that together provide uninterruptible power. A “UPS product” refers to a device in an enclosure that contains at least a UPS module, but may also contain various transformers and bypass devices. Because the UPS products sold in the market vary greatly in what is included in the “product” (bypass and transformer options), this paper will primarily use the more specific terms “UPS system” and “UPS module”.

UPS products are often described as either “transformer-based” or “transformerless”. This distinction refers to the presence or absence of an inverter transformer in the UPS product enclosure. The various transformers shown in **Figure 2** other than the inverter transformer

are all options that are either optional within a UPS product or can be installed externally to the UPS enclosure. This issue is very important to the following discussion and must be further clarified: the distinction between a transformerless UPS product and a transformer-based UPS product is the presence of the inverter transformer. All of the other transformers that might be used in a UPS system are optional and can be used with either a transformer-based or a transformerless UPS product.

Note that in any installation there are upstream transformers providing power to the UPS system and other loads. The mains, bypass, and rectifier transformers in the diagrams in **Figure 2** represent transformers that are specifically dedicated to the UPS system; they are separate from the transformers that step the voltage down from medium voltage.

In each of these three UPS system configurations any combination of transformers may be present – from none to all. For the single mains configuration, there are 8 possible transformer arrangements; for dual mains there are 16 arrangements, and for single mains without bypass there are 8 arrangements, for a total of 32 possible arrangements. Furthermore, the mains transformers and output transformers can be located either locally or remotely from the UPS, which affects the grounding system. This adds an additional 60 variations, for a total of 92 ways transformers can be installed with a single UPS. Virtually all of the 92 transformer installation variations have been used in real installations. However, not all transformer arrangements are logical, and there are a few that offer a superior combination of performance, economy, and efficiency. To understand when the use of a transformer is required or why various transformer locations exist for the three UPS configurations, we first must consider the effect of transformers on the neutral and ground wiring.

“Virtually all of the 92 transformer arrangements have been used in real installations. However, not all arrangements are logical, and there are a few that offer a superior combination of performance, economy, and efficiency.”

## Characteristics of transformers

There are different types of transformers, but in this paper a transformer refers to a “delta-wye” configuration, which is the type used in almost all UPS applications. Delta-wye transformers have a number of characteristics, both good and bad, that impact their use in UPS systems:

- |   |                                    |
|---|------------------------------------|
| <ol style="list-style-type: none"> <li>1. Isolation of the output neutral from the source</li> <li>2. Voltage change (for example, 480V to 208V)</li> <li>3. Impedance that limits fault current or acts as a noise filter</li> <li>4. Blocking the 3rd, 9th, 15th, and other multiples-of-three harmonic currents</li> </ol> | <p><b>Good characteristics</b></p> |
| <ol style="list-style-type: none"> <li>5. Weight, cost, consumption of natural materials, and taking up space</li> <li>6. Electrical losses and contribution to data center inefficiency</li> </ol>   | <p><b>Bad characteristics</b></p>  |

The first four are benefits, and the last two are undesirable penalties. Because the last two penalties are severe, transformers should only be used when the beneficial characteristics are useful to the mission of the data center.

**Voltage change** This is necessary in applications where the mains voltage is not the same as the voltage used by the IT equipment. This is a common condition in North America where the mains voltage is 480 or 600V in larger data centers. In most of the world, the 400/230V three-phase mains voltage is the same voltage used by the IT load equipment, so this function is not required.

**Impedance** This is generally secondary and unimportant in the modern data center. Most designs do not require additional impedance, and if it were required it would be more effective to create it with a power inductor (sometimes called a “choke”), which is smaller, lighter, and more efficient than a transformer.

 *Related resource*  
**White Paper 26**  
*Hazards of Harmonics and Neutral Overloads*

**Blocking harmonics** This was historically a useful function to prevent the harmonic currents created by the UPS from affecting the mains, and to prevent IT-load harmonic currents from affecting the mains via the UPS bypass. However, two major changes have changed this situation: both the modern UPS and modern IT loads are “power factor corrected”, which means their harmonic current generation has been dramatically reduced to the point where no additional filtering is necessary. Therefore, the use of transformers to reduce harmonic currents is no longer a necessary function in the modern data center. This subject is discussed in detail in White Paper 26, *Hazards of Harmonics and Neutral Overloads*.

The first three beneficial characteristics therefore have limited or obsolete value, which leaves the fourth characteristic – isolation of the neutral from the source – which is by far the most important.

**Isolation of neutral from the source** This is the most important characteristic of a transformer – it is this characteristic that causes transformers to be useful, necessary, or even legally mandated under certain conditions. The remainder of this paper will focus on this attribute of transformers and how it impacts the use of UPSs in data centers. Because isolation of the neutral is the key to determining the role of transformers, we must understand this function.

“ Isolation of the neutral from the source is the most important characteristic of a transformer – it is this characteristic that causes transformers to be useful, necessary, or even legally mandated. ”

## Transformer isolation

Transformers are typically represented by the overlapping double-circle symbol shown in **Figure 2**, which will be used to represent transformers in this paper. However, this symbol is a simplification of the actual wiring diagram of a transformer, which is shown in **Figure 3** and is important to understand for the remainder of this paper.

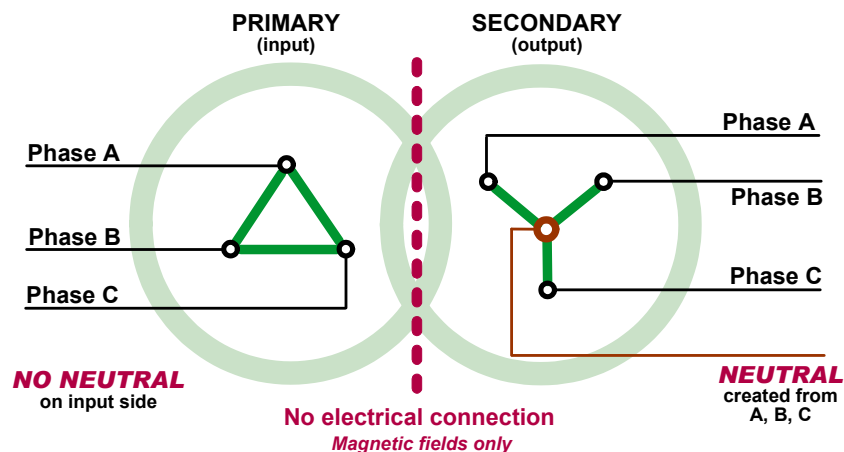

**Figure 3**

*Wiring diagram showing input and output connections to a power isolation (“delta-wye”) transformer*

The primary, or input, is on the left and three power phases are applied to the transformer windings (green lines) that are connected in the “delta” configuration as shown by the triangular shape.

The secondary, or output, is connected in the “wye” (Y-shaped) configuration and consists of three power phases and a centerpoint, or neutral, connection<sup>1</sup>. There is no electrical connection between the input and output; the power is transferred through magnetic fields

<sup>1</sup> The example shown is a “delta-wye” transformer. Although other types such as delta-delta, wye-delta, or wye-wye are possible, the delta-wye transformer shown has special advantages and is used almost exclusively in data center applications. The technical reasons for this can be found in many textbooks on power systems and are not discussed here.



## > Ground system types

### **TN-S** Terra neutral

#### separate

The supply neutral is a separate wire from the ground wire and is connected to the ground at a single point. Both the neutral and the ground are distributed to the loads. All neutral and ground wires lead to the central bonding point

### **TN-C** Terra neutral

#### common

The supply neutral is grounded at the supply. A single wire provides both the neutral and ground function

### **TT** Terra terra

The supply neutral is grounded. A local ground is created near the load to provide chassis grounding

### **IT** Insulated terra

The supply neutral floats with respect to ground. A local ground is created near the load to provide chassis grounding

### **IT-HRG** Isolated terra with high-resistance ground

The supply neutral is a separate wire from the ground wire and is connected to ground at a single point through a large power resistor. Phase to ground faults are current limited by the ground resistor. Protective controls are required to warn operators or trip breakers when faults are detected

between the input and output. What is important to note is that there is *no neutral connection* on the input. Even if the supply circuit has a neutral connection, it is not used with a delta-wye transformer. The transformer “makes” a new neutral on the output – a new neutral that has no electrical connection to any neutral on the input. In fact, the whole output circuit is at an indeterminate voltage with respect to the input or ground, which is referred to as “floating”. Since IT load equipment is grounded, it is never appropriate to supply floating power at an indeterminate voltage because this could cause insulation failure and other hazards. Therefore, the new neutral on the output of the transformer is connected to ground in virtually all data center applications.

When an isolation transformer has a grounded neutral, its output circuit is often referred to as a “separately derived source”. Grounding the output neutral can be achieved by directly connecting the neutral to the nearest grounded metal (equipment enclosures, ground rods, water pipes<sup>2</sup> or ground wire known to be grounded), or it can be connected to an existing neutral wire known to be grounded, or it can be connected to ground through a grounding resistor (this is only used on high power busses and not on final distribution to the IT loads). All three of these techniques are used in data centers and will be referred to in the next sections.

Considering the above isolation properties of a transformer, we can now describe the key beneficial – and sometimes necessary – functions resulting from isolation:

- Changing different mains grounding systems to the system required by data center IT equipment
- Creating a new neutral connection when the mains neutral has serious power quality problems or the neutral is subject to disconnection when upstream 4-pole circuit breakers are used (as required in some countries)
- Combining two sources without the need to connect their neutral wires together
- Preventing circulating currents that could cause Residual Current Detectors (RCD) or other safety systems to activate unnecessarily

Since these functions must be understood in order to understand how and why transformers are used and where to apply them, each function will be briefly explained.

The first function of changing a mains grounding system in a data center to the grounding system required by IT equipment is clearly an essential function. IT equipment in a data center is always operated from a TN-S grounding system (see sidebar “Ground System Types” for description of grounding nomenclature). In some cases, the mains provides a TN-S system so no change is required. Generally, TT or IT grounding systems require conversion to TN-S by use of a transformer before they can be utilized by IT equipment. This grounding conversion can occur before the UPS or after the UPS. In some countries such as the USA and Great Britain, TN-C grounding systems are common and are converted to TN-S without a transformer.

The second function, of creating a new neutral when the mains neutral has serious power quality problem, is used when the provided mains neutral is shared with other customers, is generated a distance from the data center, or is deemed unreliable to the point where it might either be interrupted or become disconnected from earth. In developed countries and in most large new buildings, the TN-S neutral source is within the customer premises and typically close to the data center. In this case the quality of the neutral would be considered excellent and the second function is redundant. But in other situations the neutral to ground bond may be outdoors, possibly distant, shared, and part of a degraded or overloaded distribution

<sup>2</sup> The use of water pipes to establish system grounding is not permitted in all countries; consult local regulations.

system. Under these conditions the neutral may have significant offset or noise voltage with respect to ground, or worse it might lose its ground connection or become interrupted. This problem is made worse in tropical climates where it can be difficult to maintain low impedance metal-to-metal bonds over time. If a mains source under a loss of neutral condition were passed directly to the IT equipment, massive equipment failures could occur due to the higher voltage. These problems are common in developing countries and are the reason why a data center power system design often requires additional power transformers when deployed in emerging markets.

The third function, combining sources without the need to connect the neutrals, is a function that is unique to emergency power systems that have backup sources, such as commonly used in a data center. A data center may be fed from a combination of multiple mains services and generators that are combined with switches to assure power continuity to the critical load. The bypass path within a UPS is itself an alternate power path from the UPS module that is essentially “combined” at the output of the UPS. Whenever two sources are combined through a switching arrangement, a situation may arise where there are two input neutral connections and a single output neutral connection. This leads to the problem of how to connect a single output neutral given two input neutrals as shown in **Figure 4**.

**Figure 4**

*Problem: How to create a single output neutral, given two input source neutrals?*

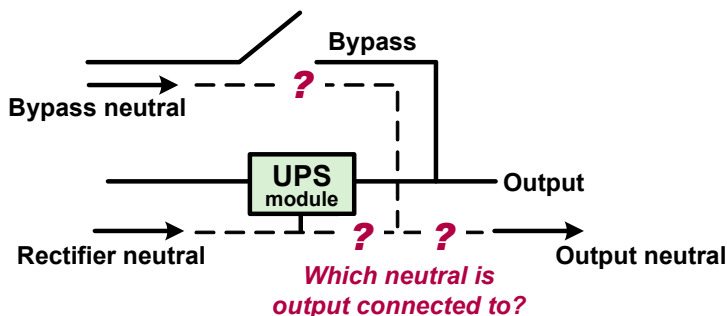

Since switching between neutrals supplying an IT load creates a momentary open-neutral condition which can be hazardous or destructive, the neutral to the critical load should never be switched. This means if two alternate sources are combined in the UPS, they must have their neutral wires permanently connected to each other. However, connecting the input neutrals together to the output neutral can create circulating currents between the input neutrals as shown in **Figure 5**.

**Figure 5**

*Circulating current created by connecting two separate input neutral wires to create a single output neutral*

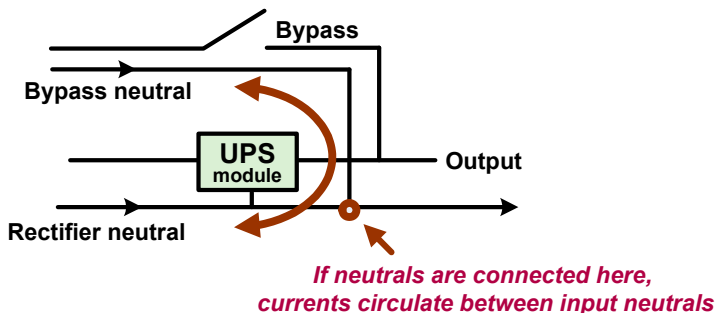

While these circulating currents are a minor nuisance when the bypass and rectifier come from the same source, this can be a hazard if the two input neutrals come from different sources. The connection of two independently derived neutral sources together is universally not permitted by law. The insertion of a transformer in series with one of the two sources solves this problem. Whenever a dual mains UPS is supplied by separately derived neutral sources, a transformer is required. Note that some dual mains systems have the two inputs supplied by sources with a commonly derived neutral and these don't require a transformer.



The fourth function, preventing circulating currents that could cause RCDs or other safety systems to activate unnecessarily, is also related to the situation where sources are combined such as in a dual mains configuration. Circulating currents between neutrals always occur when separately derived neutrals are connected to each other, but as pointed out in the previous paragraph, this is not permitted by law so a problem should not be created. But circulating currents can also occur even when a UPS is supplied from two inputs that are derived from the same neutral. Therefore, in any system where both a rectifier and bypass neutral connection are provided to the UPS, any RCD protection on the supply circuits will activate unnecessarily. An isolation transformer located in either the rectifier supply, the UPS module output, or the bypass is needed to prevent RCD activation.

At first it seems that if the rectifier input neutral connection could be omitted, the circulating current problem should be solved. In fact, all UPS systems designed for dual mains are designed to operate without a rectifier neutral connection; the UPS input rectifiers draw power between the input phases and do not require a neutral connection to function. As long as the rectifier source is known to be grounded, the rectifier neutral need not be provided. Since there is no longer any rectifier neutral connection, it seems that circulating current should not be possible. Unfortunately, although this it is widely believed that the absence of a neutral connection on the rectifier eliminates circulating currents, it is not true.

**Figure 6**

*Circulating current can still exist even if the rectifier input neutral is not connected*

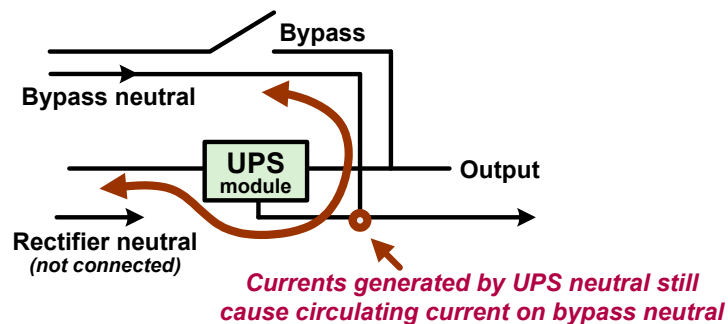

**Figure 6** shows the dual mains UPS system configuration with the rectifier supply neutral not connected. The red line shows the flow of circulating current which still exists but flows through the UPS module instead of the rectifier neutral. Any UPS inverter module that has an output neutral will inject current onto the output neutral bus in excess of any neutral current required by the load. This “excess” neutral current is a side-effect of inverter operation and is caused by reactive loads, non-linear loads, and imbalances in the load currents. This “excess” neutral current is not consumed by the IT loads and returns to the mains via the bypass neutral. This current may appear small under normal conditions but can become large under various loads or mains voltage imbalances. If the bypass mains supply includes RCD protection (mandated in some conditions in some countries), then these protective devices will sense this neutral current as an unexpected current and misinterpret it as a ground fault, possibly shutting down the system. This leads to a very important principle of data center power system design: **In DUAL MAINS systems with RCD protection, there must ALWAYS be a transformer present somewhere in one of the mains paths.** Removing the rectifier neutral connection is NOT sufficient to prevent circulating currents.

“ In Dual Mains systems with RCD protection, there must ALWAYS be a transformer in one of the mains paths. Removing the rectifier neutral connection is NOT sufficient to prevent circulating currents ”

It should be clear at this point that the dual mains configuration has, by far, the most complex issues relating to grounding and transformer use. Many mistakes are made in the application of transformers and the appropriate grounding of dual mains systems, mistakes which often result in intermittent problems and unexpected downtime. These problems are simplified in single mains systems (with or without bypass). Often a dual mains system is chosen without consideration of these complexities, and a single mains system might have been a better choice because there are fewer things that can go wrong in the design and the installation.

The single mains configuration can be a reliable and cost-effective choice because the theoretical reliability advantages of a dual mains configuration are not always realized in practice. This is why the single mains configuration is often used even in very large ultra-high availability data centers, especially when redundancy is achieved by dual path or N+1 UPS configurations.

### Paralleling and other redundancy configurations

The previous descriptions of transformer applications in the three basic UPS configurations assume that the UPS system includes a single UPS module. However, it is common for data center power systems to be comprised of a number of UPS systems, which in turn can be comprised of a number of UPS modules, which can all be arranged in many different configurations to achieve redundancy. The various commonly used approaches for obtaining redundancy are described in White Paper 75, *Comparing UPS System Design Configurations*. In addition to the redundancy function, UPS systems are often paralleled as a means to increase power capacity.

The discussions of grounding and transformer use in this paper apply without modification to parallel UPS systems comprised of multiple parallel UPS modules, where a single bypass is used. Example of such a UPS systems with internal UPS module paralleling would be the APC Symmetra. However, there are configurations of data center systems that include parallel or cascade configurations of complete UPS systems, introducing many more possible points of system grounding and possible transformer locations. Most of the principles of applying transformers described in this paper still apply to these systems, but such systems often create special challenges for grounding and for residual current detection.

Given the basic understanding of the application of transformers as provided in this paper, it is possible to determine the optimal approach to using transformers in specific redundancy or paralleling situations. However, a complete discussion of transformer options for the numerous paralleling and redundancy configurations is beyond the scope of this paper.

We will now consider each of the three basic UPS configurations and show the preferred transformer arrangements based on the situation.

As stated earlier in this paper, 92 different arrangements of transformers are possible with a single UPS, even before redundancy configurations are considered. Instead of attempting to describe and compare each of these arrangements, this paper will describe the functions of the transformers in the three previously identified generic configurations of single mains, dual mains, and single mains without bypass. The functions and benefits of the different transformers will be described within each of these three configurations. From this, the preferred arrangements of transformers will be deduced and described.

### Transformer options for the “single mains” configuration

The single mains system is the most common UPS configuration, used in over 50% of all UPS installations. In smaller systems (below 100kW), it is even more dominant, making up approximately 90% of all installations. The advantage of this system is that it is relatively simple to design and install, yet it provides a bypass that gives a variety of redundancy and maintenance benefits. Small UPS systems below 10 kW typically only have a single input and must be used in the single mains configuration. UPS systems over 10 kW usually provide for dual mains input but are converted to single mains by simply connecting the two mains inputs together. The majority of UPS systems shipped with dual mains input connections actually end up configured for single mains input.

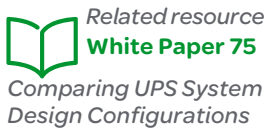

## Transformer arrangements in practical UPS systems

In the single mains configuration, transformers can be located in three positions as shown in **Figure 7**. Any combination of these transformers, including none or all three, might exist in a UPS installation.

**Figure 7**

Possible transformer locations in the “single mains” UPS configuration

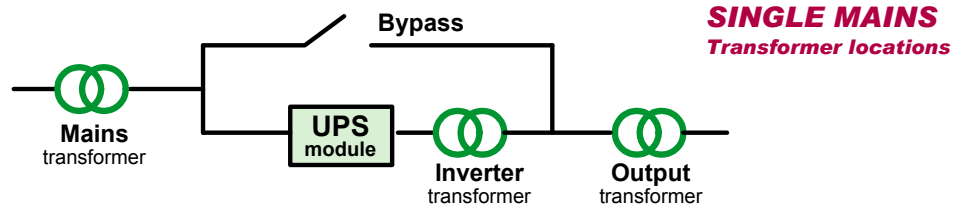

While **Figure 7** accurately represents the flow of power, it does not completely describe the grounding system because the physical location of the transformers must also be considered. The inverter transformer, if present, is always integral to the UPS, but the mains and output transformers can be either located at the UPS or remotely located. **Table 1** describes the function of each transformer, when it is needed, and the issues related to its physical location (local vs. remote).

**Table 1**

Characteristics of the three SINGLE MAINS transformer locations

Transformer location	Functions provided	When needed	Local / remote issues
<b>Mains</b>	<ul style="list-style-type: none"> <li>• Change mains voltage</li> <li>• Change grounding system to TN-S</li> <li>• Isolate UPS and the output from poor quality mains neutral</li> </ul>	<ul style="list-style-type: none"> <li>• Mains voltage must be changed to match the UPS voltage</li> <li>• Mains grounding system not compatible with the load AND there is no output transformer</li> </ul>	<ul style="list-style-type: none"> <li>• If transformer is local to the UPS, a high quality TN-S grounding system is created at the UPS output</li> <li>• Locating this transformer remotely from the UPS requires that the TN-S grounding system is created at the transformer location, which is not ideal</li> </ul>
<b>Inverter</b>	<ul style="list-style-type: none"> <li>• This transformer provides no functions in the single mains configuration, but may be present due to the design of the UPS</li> </ul>	<ul style="list-style-type: none"> <li>• Never needed in this configuration</li> </ul>	<ul style="list-style-type: none"> <li>• On older UPSs, this transformer may be integral to the UPS design and cannot be removed, but it is not providing any useful function</li> </ul>
<b>Output</b>	<ul style="list-style-type: none"> <li>• Change the UPS output voltage</li> <li>• Change the grounding system to TN-S, if the UPS is not using TN-S</li> <li>• Improve the quality of the TN-S grounding system if the input transformer is not present or is remotely located</li> </ul>	<ul style="list-style-type: none"> <li>• UPS voltage must be changed to match the IT load voltage</li> <li>• UPS grounding system is not compatible with the IT load AND there is no input transformer</li> <li>• Input grounding system is compatible with the IT load but the quality of the neutral circuit is poor OR the input transformer, if present, is remotely located</li> </ul>	<ul style="list-style-type: none"> <li>• If the IT loads are far from the UPS, locating the transformer remotely (closer to the IT loads) has the advantage of creating the TN-S ground near the IT load, improving the quality of the grounding system</li> </ul>

The following observations can be made from a study of the functions of the transformers in the single mains UPS configuration:

“ There is no advantage to using a transformer-based UPS in the single mains configuration ”

- If voltages must be changed, transformers must be installed. For example, if the mains voltage is 600 V, the UPS voltage is 480 V, and the IT load voltage is 208 V, then both input and output transformers are required. This is a fundamental requirement and is the first issue to be considered in determining where to put a transformer.
- If the mains and/or UPS ground system are not TN-S, then transformers must be installed. For example, if the mains grounding system is TT, and UPS grounding system is IT-HRG, then both input and output transformers must be installed. This is a fundamental requirement, but some aspects of this problem are under the control of the system designer. For example, a designer could ensure that a high quality TN-S grounding system is provided at the data center, so no ground system changes are required.
- The inverter transformer provides no function or benefit to the single mains UPS system. Since the presence of the inverter transformer defines the difference between a transformer-based UPS and a transformerless UPS, it follows that **there is no advantage to using a transformer-based UPS in the single mains configuration.**

As stated earlier in this paper, there are 8 possible transformer arrangements in a single mains UPS configuration. When remote vs. local location options for the mains and output transformers are considered, the number of options grows to 18. While there is not one combination that emerges as the universal best solution, some of these variations can be eliminated as sub-optimal, and a few emerge as clearly superior. The analysis of all 18 of these options is not presented in this paper, but can be derived from the information presented in this section. **Tables 2a-2c** below summarize the preferred transformer options for the single mains UPS configuration, with guidance as to where each approach is used.

**Table 2a**

*SINGLE MAINS preferred transformer option 1:  
Local input transformer*

SINGLE MAINS	
Local input transformer	
<b>Application:</b> Small data centers where the mains ground system is poor or not TN-S, or the mains voltage is not the same as the IT load voltage	
Features	Notes
<b>Mains ground systems:</b> TN-S, TT, IT-HRG, TN-C <b>Input voltages:</b> UPS and load voltage must match <b>Power range:</b> Up to 1MW, but limited in North America to less than 100kVA due to mains and UPS being 480V or 600V above this power rating <b>Efficiency:</b> High <b>IT load neutral bond:</b> Established at the UPS output	<ul style="list-style-type: none"> <li>• If the input transformer is local to the UPS, then its neutral connection is not connected to ground at the transformer, but brought to the UPS where neutral is connected to ground at the UPS output (preferred method)</li> <li>• If the input transformer is remote from the UPS, then the neutral may be required to be connected to ground at the transformer, and the UPS neutral must be connected to this neutral and cannot be connected to ground at the UPS</li> </ul>

**Table 2b**

*SINGLE MAINS transformer option 2:  
No transformers*

<p><b>SINGLE MAINS</b>  No transformers</p>	
<p><b>Application:</b> Small data centers with high quality TN-S mains ground system, where mains and UPS and IT load voltage are all the same (400/230V, 380/220V, 208/120V, or 200/100V)</p>	
Features	Notes
<p><b>Mains ground systems:</b> TN-S only  <b>Input voltages:</b> Same as IT load  <b>Power range:</b> Up to 1MW, but limited in North America to less than 100kVA due to mains and UPS being 480V or 600V above this power rating  <b>Efficiency:</b> Highest  <b>IT load neutral bond:</b> Established at the TN-S source</p>	<ul style="list-style-type: none"> <li>• The use of a UPS with a built-in inverter transformer offers no benefits over a transformerless UPS in this arrangement, because the output neutral must be derived from the TN-S source due to presence of the bypass</li> </ul>

**Table 2c**

*SINGLE MAINS transformer option 3:  
Remote output transformer(s)*

<p><b>SINGLE MAINS</b>  Remote output transformer(s)</p>	
<p><b>Application:</b> Large data centers</p>	
Features	Notes
<p><b>Mains ground systems:</b> TN-S, TT, IT-HRG, TN-C  <b>Input voltages:</b> Mains and UPS voltage must match  <b>Power range:</b> Any, but not the most cost effective alternative in smaller data centers  <b>Efficiency:</b> High, but lower if multiple output transformers are used  <b>IT load neutral bond:</b> Established at the output transformer</p>	<ul style="list-style-type: none"> <li>• The UPS must be rated to operate with the specified mains ground system. Not all UPS can operate with an IT-HRG ground system, and some UPS require an input neutral connection</li> <li>• There is no neutral connection between the UPS and the output transformer(s) in this system</li> <li>• The output transformer may be a single transformer or its function may be divided among many PDU transformers</li> </ul>

Another option for large data centers is to add an input transformer to the “single mains with remote output transformer” arrangement, to allow for use with very poor mains grounding systems or a mains supply with an incompatible grounding system, but this would be an uncommon situation.

The single mains configuration has fewer options and is simpler to design for and deploy than the dual mains system described in the next section. In practice, this means there are fewer

design and installation mistakes made. This configuration will remain the most common, and should be considered for both large and small data centers.

### Transformer options for the “dual mains” configuration

The dual mains configuration is used in many, but not all, larger installations. **Figure 8** shows four options for transformer location in a dual mains system

**Figure 8**

Possible transformer locations for the DUAL MAINS configuration

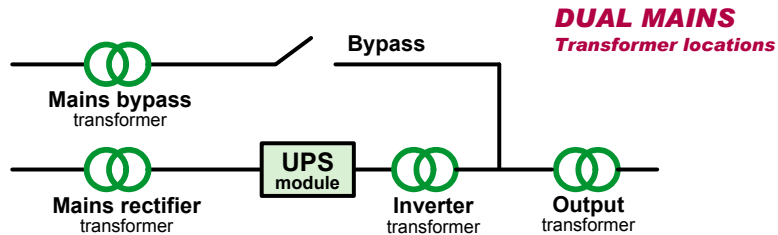

There are two core reasons that the dual mains system is used. The dual mains approach must be used when the system architecture prescribes that the rectifier and the bypass supplies come from different sources – for example, separate utility substations or in highly specialized redundancy architectures. This requirement is actually quite uncommon and is restricted to architectures designed for extreme redundancy. Note that in most systems with alternate supplies, such as diesel generators or secondary utility mains supplies, an automated transfer switch is provided upstream of the UPS because there are other loads in addition to the UPS – such as cooling plants – that must be backed up.

The second reason the dual mains design is used is to allow for concurrent maintenance of the distribution wiring and breakers feeding the UPS. If the breakers and wiring supplying the two mains inputs are separate, either can be shut down without shutting down the critical load, which will be powered from the remaining path during the maintenance. While this is a common reason for specifying this arrangement, there are alternative ways to allow for concurrent maintenance without using this approach, such as a dual power path architecture or concurrently maintainable parallel breakers.

The diagram in **Figure 8** accurately represents the flow of power but does not completely describe the grounding system, because the physical location of the transformers must also be considered. The inverter transformer, if present, is always integral to the UPS, but the rectifier, bypass, and output transformers can be either located at the UPS or remotely located. **Table 3** describes the function of each transformer, when it is needed, and issues related to its physical location (local vs. remote).



**Table 3**

Characteristics of the four DUAL MAINS transformer locations

Transformer location	Functions provided	When needed	Local / remote considerations
<b>Bypass</b>	<ul style="list-style-type: none"> <li>• Isolates the bypass neutral from currents generated by the inverter</li> <li>• Changes bypass mains voltage</li> <li>• Changes bypass grounding system to TN-S</li> <li>• Isolates bypass from poor quality neutral</li> <li>• Protects the UPS from open neutral conditions caused by upstream transfer switches or breakers</li> </ul>	<ul style="list-style-type: none"> <li>• The bypass voltage must be changed to match the UPS voltage</li> <li>• The bypass grounding system is not compatible with the load AND there is no output transformer</li> <li>• RCD protection is used on the mains supplies AND neither a rectifier or local inverter transformer is present</li> <li>• 4-pole breakers are used on the supply to the bypass (open neutral can occur)</li> </ul>	<ul style="list-style-type: none"> <li>• The output neutral of the UPS is always the same as the bypass neutral, unless there is an output transformer present</li> <li>• If this transformer is local to the UPS, and either a rectifier or inverter transformer is provided, or the rectifier is capable of operating without an input neutral connection, a high quality TN-S grounding system is created at the UPS output</li> <li>• Locating this transformer remotely from the UPS requires that the TN-S grounding system is created at the transformer location, which is not ideal</li> </ul>
<b>Rectifier</b>	<ul style="list-style-type: none"> <li>• Change rectifier mains voltage</li> </ul>	<ul style="list-style-type: none"> <li>• Isolates the UPS input from an incompatible mains grounding system</li> <li>• Mains to UPS voltage change is required</li> </ul>	<ul style="list-style-type: none"> <li>• This transformer does not completely protect the UPS from open neutral conditions caused by upstream transfer switches because the UPS neutral normally is derived from the bypass input</li> </ul>
<b>Inverter</b>	<ul style="list-style-type: none"> <li>• Isolates the bypass neutral from currents generated by the inverter</li> </ul>	<ul style="list-style-type: none"> <li>• The bypass is from a separately derived source and no rectifier transformer is present</li> </ul>	<ul style="list-style-type: none"> <li>• This transformer provides the same neutral isolation as a rectifier transformer, but cannot perform a voltage change</li> <li>• The load power always flows through this transformer, so isolation between mains inputs is better provided in the bypass path since it increases system efficiency</li> </ul>
<b>Output</b>	<ul style="list-style-type: none"> <li>• Change the UPS output voltage</li> <li>• Change the grounding system to TN-S, if the UPS is not using TN-S</li> <li>• Improve the quality of the TN-S grounding system if the input transformer is not present or is remotely located</li> </ul>	<ul style="list-style-type: none"> <li>• The UPS voltage must be changed to match the IT load voltage</li> <li>• The UPS grounding system is not compatible with the IT load AND there is no input transformer</li> <li>• The input grounding system is compatible with the IT load but the quality of the neutral circuit is poor OR the input transformer, if present, is remotely located</li> </ul>	<ul style="list-style-type: none"> <li>• If the IT loads are far from the UPS, locating the transformer remotely from the UPS and closer to the IT loads, has the advantage of creating the TN-S ground near the IT load, improving the quality of the grounding system</li> </ul>

The following observations can be made from a study of the functions of the transformers in the dual mains UPS configuration:

“ In many cases there is no advantage to using a transformer-based UPS in a Dual Mains configuration ”

- If voltages must be changed, transformers must be installed. For example, if the mains voltage is 600 V, the UPS voltage is 480 V, and the IT load voltage is 208 V, then all three – bypass, rectifier, and output transformers – are required. This is a fundamental requirement and is the first issue to be considered in determining where to put a transformer.
- If the mains and/or UPS ground system are not TN-S, then transformers must be installed. For example, if the mains grounding systems is TT, and UPS grounding system is IT-HRG, then all three – bypass, rectifier, and output transformers – must be

installed. This is a fundamental requirement, but some aspects of this problem are under the control of the system designer. For example, an architect could ensure that a high quality TN-S grounding system is provided at the data center, so no ground system changes are required.

- The inverter transformer provides the function of breaking the neutral connection between the rectifier and bypass inputs, but this function is also provided by either a rectifier or bypass transformer. The inverter transformer function is redundant if either a rectifier or bypass transformer is installed for another purpose. Since the presence of the inverter transformer defines the difference between a transformer-based UPS and a transformerless UPS, it follows that **in many cases there is no advantage to using a transformer-based UPS in the dual mains configuration.**

As stated earlier in this paper, there are 16 possible combinations of transformer arrangements in this system. When remote vs. local location options for the mains and output transformers are considered, the number of options grows to 56. While there is not one combination that emerges as the universal “best solution”, some of these variations can be eliminated as sub-optimal, and a few emerge as clearly superior. An analysis of all 56 of these options is not covered in this paper, but can be derived from the information presented in this section. **Tables 4a-4d** below summarize the preferred transformer options for the dual mains UPS system, with guidance as to where each approach is used.

**Table 4a**

*DUAL MAINS transformer option 1:  
Local bypass transformer and remote transformer(s)*

<p><b>DUAL MAINS</b></p> <p>Local bypass transformer Remote output transformer(s)</p>	
<p><b>Application:</b> Large data centers</p>	
<p><b>Features</b></p>	<p><b>Notes</b></p>
<p><b>Mains ground systems:</b> TN-S, TT, IT-HRG, TN-C, inverter and bypass grounding systems can be independent</p> <p><b>Input voltages:</b> Mains and UPS voltage must match</p> <p><b>Power range:</b> Any, but impractical below 100kW</p> <p><b>Efficiency:</b> High, but lower if multiple output transformers are used</p> <p><b>IT load neutral bond:</b> Established at the output transformer</p>	<ul style="list-style-type: none"> <li>• Equivalent functionality can be provided by moving the bypass transformer to either the rectifier or inverter locations but efficiency is degraded</li> <li>• The UPS must be rated to operate with the specified mains ground system. Not all UPS can operate with an IT-HRG ground system, and some UPS require an input neutral connection</li> <li>• There is no neutral connection between the UPS and the output transformer(s) in this system.</li> <li>• The output transformer may be a single transformer or its function may be divided among many PDU transformers</li> </ul>

**Table 4b**

DUAL MAINS transformer option 2:  
Local bypass transformer, rectifier transformer, and remote output transformer(s)

<p style="text-align: center; margin: 0;"><b>DUAL MAINS</b></p> <p style="margin: 0;">Local bypass transformer Rectifier transformer Remote output transformer(s)</p>	
<p><b>Application:</b> Large data centers with poor mains ground system, different mains and UPS grounding systems, or different mains and UPS voltage</p>	
<b>Features</b>	<b>Notes</b>
<p><b>Mains ground systems:</b> TN-S, TT, IT-HRG, TN-C, inverter, bypass, and UPS grounding systems can be independent</p> <p><b>Input voltages:</b> Any combination</p> <p><b>Power range:</b> Any, but impractical below 100kW</p> <p><b>Efficiency:</b> Lowest, and even lower if multiple output transformers are used</p> <p><b>IT load neutral bond:</b> Established at the output transformer</p>	<ul style="list-style-type: none"> <li>• There is no neutral connection between the UPS and the output transformer(s) in this system</li> <li>• The output transformer may be a single transformer or its function may be divided among many PDU transformers</li> <li>• A transformer-based UPS with a transformer in the inverter location provides no additional functionality and degrades efficiency.</li> </ul>

**Table 4c**

DUAL MAINS transformer option 3:  
No transformers

<p style="text-align: center; margin: 0;"><b>DUAL MAINS</b></p> <p style="margin: 0;">No transformers</p>	
<p><b>Application:</b> Small data centers with high quality TN-S mains ground system, where mains and UPS and IT load voltage are all the same (400/230V, 380/220V, 208/120V, or 200/100V) and RCD is not required</p>	
<b>Features</b>	<b>Notes</b>
<p><b>Mains ground systems:</b> TN-S only, bypass and mains common</p> <p><b>Input voltages:</b> Same as IT load</p> <p><b>Power range:</b> Up to 1MW, but limited in North America to &lt; 100kVA due to mains and UPS being 480V or 600V above this power rating</p> <p><b>Efficiency:</b> Highest efficiency</p> <p><b>IT load neutral bond:</b> Established at the TN-S source</p>	<ul style="list-style-type: none"> <li>• Both the bypass and the rectifier must be TN-S and both neutrals must be derived from a common ground connection</li> <li>• RCD protection on the bypass and rectifier inputs cannot be used in this configuration, because the inverter will inject some current into the bypass neutral</li> </ul>

**Table 4d**

DUAL MAINS transformer option 4:  
Local bypass transformer

<b>DUAL MAINS</b>  Local bypass transformer	
<b>Application:</b> Small data centers with high quality TN-S mains ground system, where mains and UPS and IT load voltage are all the same (400/230V, 380/220V, 208/120V, or 200/100V) and RCD protection is required or the bypass is separately derived	
Features	Notes
<p><b>Mains ground systems:</b> TN-S on rectifier input, bypass can be any type</p> <p><b>Input voltages:</b> Mains, UPS and load voltage must match</p> <p><b>Power range:</b> Up to 1MW, but limited in North America to &lt; 100kVA due to mains and UPS being 480V or 600V above this power rating</p> <p><b>Efficiency:</b> High</p> <p><b>IT load neutral bond:</b> Established at the bypass transformer</p>	<ul style="list-style-type: none"> <li>• This method is used if the bypass and inverter supplies are separately derived (separate neutral bonding connections), or RCD protection is used</li> <li>• The transformer could have been placed in the rectifier or inverter location to achieve RCD compatibility, but this would reduce the UPS mode efficiency</li> <li>• If the input transformer is remote from the UPS, then the neutral may be required to be connected to ground at the transformer, and the UPS neutral must be connected to this neutral and cannot be connected to ground at the UPS</li> </ul>

Note that none of the preferred arrangements have a transformer in the inverter location. Most transformer-based UPSs have the transformer in the inverter location, yet this is the least useful place to have a transformer. This again reinforces the key finding of this paper: that the historical transformer-based UPS is obsolete because its transformer is in the wrong location. The better solution is to use a UPS where the location of the transformer (if any are needed) can be established in the optimal location during the system design.

“The historical transformer-based UPS is obsolete because its transformer is in the wrong location”

The most important characteristic of the dual mains design is that there are many options and the interactions between the options and other equipment such as RCD and circuit breakers is quite complex. The successful installation of a dual mains system requires not only a careful tradeoff analysis and design, but also requires care during installation. These factors are further compounded in designs of paralleled systems or complex redundancy configurations. Unfortunately, design and installation errors are much more common in the dual mains design than in the single mains designs, reducing system reliability and performance. These factors are not always considered when a dual mains design is specified.

### Transformer options for “single mains without bypass”

The single mains without bypass configuration is commonly used when the quality of the input mains power or the mains grounding system is poor, degraded, or shared with industrial loads. The diagram of the “without bypass” configuration, with the possible transformer locations, is shown in **Figure 9**.

**Figure 9**

Possible transformer locations in the SINGLE MAINS WITHOUT BYPASS configuration



When the mains power is of very poor quality or the grounding system is unstable, it can be undesirable to ever expose the IT load to the mains via a bypass, so no bypass is provided in this system. This configuration is almost exclusively used in developing nations, where poor power can be quite common. In developed countries with stable power grids, the bypass is a valuable feature and either the single mains or the dual mains systems predominate; the “without bypass” configuration is quite rare.

An inspection of the diagrams reveals that a single mains configuration **with** bypass appears to become equivalent to the **without** bypass diagram if the bypass function is disabled. It is commonly assumed that a system can be installed with a bypass and then toggled back and forth between the “with” and “without” bypass configurations. *This mode of installation is only viable if either an input or an output transformer is present.* The reason is that if the bypass is wired, the neutral of the inverter output transformer cannot be connected to ground if the bypass neutral is already grounded. If the only transformer present is the inverter transformer, and the output is separately derived by connecting the inverter transformer neutral to ground, then the bypass must not be wired and cannot be used. This limitation applies to mechanical “wrap-around” bypass as well as to automatic “static” bypass.

The inverter transformer, if present, is always integral to the UPS, but the mains and output transformers can be either located at the UPS or remotely located. **Table 5** describes the function of each transformer, when it is needed, and the issues related to its physical location (local vs. remote).

**Table 5**

*Characteristics of the different transformer locations for a SINGLE MAINS WITHOUT BYPASS system*

Transformer Location	Functions provided	When needed	Local vs. remote issues
<b>Mains</b>	<ul style="list-style-type: none"> <li>• Change mains voltage</li> <li>• Change grounding system to TN-S</li> <li>• Isolates UPS AND the output from poor quality mains neutral</li> </ul>	<ul style="list-style-type: none"> <li>• The mains voltage must be changed to match the UPS voltage</li> <li>• The mains grounding system is not compatible with the load AND there is no output transformer</li> </ul>	<ul style="list-style-type: none"> <li>• If this transformer is local to the UPS, a high quality TN-S grounding system is created at the UPS output</li> <li>• Locating this transformer remotely from the UPS requires that the TN-S grounding system is created at the transformer location, which is not ideal</li> </ul>
<b>Inverter</b>	<ul style="list-style-type: none"> <li>• Isolates the output from poor quality neutral</li> </ul>	<ul style="list-style-type: none"> <li>• The system output neutral must be separated from the input neutral AND there is neither a mains nor output transformer</li> </ul>	<ul style="list-style-type: none"> <li>• The neutral of this transformer can be connected to ground because there is no bypass, creating a separately derived source</li> <li>• On older UPS, this transformer may be integral to the UPS design and cannot be removed</li> </ul>
<b>Output</b>	<ul style="list-style-type: none"> <li>• Change the UPS output voltage</li> <li>• Change the grounding system to TN-S, if the UPS is not using TN-S</li> <li>• Improve the quality of the TN-S grounding system if the input transformer is not present or is remotely located</li> </ul>	<ul style="list-style-type: none"> <li>• The UPS voltage must be changed to match the IT load voltage</li> <li>• The UPS grounding system is not compatible with the IT load AND there is no input transformer</li> <li>• The input grounding system is compatible with the IT load but the quality of the neutral circuit is poor OR the input transformer, if present, is remotely located</li> </ul>	<ul style="list-style-type: none"> <li>• If the IT loads are far from the UPS, locating the transformer remotely, closer to the IT loads, has the advantage of creating the TN-S ground near the IT load, improving the quality of the grounding system</li> </ul>

As stated earlier in this paper, there are 8 possible combinations of transformer arrangements in this system. When remote vs. local location options for the mains and output transformers are considered, the number of options grows to 18. While there is not one combination that emerges as the universal “best solution”, some of these variations can be eliminated as sub-optimal, and a few emerge as clearly superior. An analysis of all 18 of these variations is not presented in this paper, but can be derived from the information presented in this section. **Table 6a** and **Table 6b** summarize the preferred transformer options for the single mains without bypass configuration, with guidance as to where each approach is used.

**Table 6a**

*SINGLE MAINS WITHOUT BYPASS preferred option 1:  
Local input transformer and remote output transformer(s)*

<p><b>SINGLE MAINS WITHOUT BYPASS</b></p> <p>Local input transformer Remote output transformer(s)</p>	
<p><b>Application:</b> Large data centers with poor mains power quality and poor mains ground system, where UPS and IT load voltage are different</p>	
<p><b>Features</b></p>	<p><b>Notes</b></p>
<p><b>Mains ground systems:</b> TN-S, TT, IT-HRG, TN-C</p> <p><b>Input voltages:</b> Any</p> <p><b>Power range:</b> Any, but impractical for smaller data centers</p> <p><b>Efficiency:</b> High, but lower if multiple output transformers are used</p> <p><b>IT load neutral bond:</b> Established at the output transformer</p>	<ul style="list-style-type: none"> <li>• Above 100 kVA an output transformer is required in North America to convert 480 V UPS voltage to the IT load voltage</li> <li>• There is no neutral connection between the UPS and the output transformer(s) in this system</li> <li>• The output transformer may be a single transformer or its function may be divided among many PDU transformers</li> </ul>



**Table 6b**

*SINGLE MAINS WITHOUT BYPASS preferred option 2:  
Local input transformer*

<b>SINGLE MAINS WITHOUT BYPASS</b> Local input transformer	
<b>Application:</b> Large or small data centers with poor mains power quality and poor mains ground system, where UPS and IT load voltage are the same (400/230V, 380/220V, 208/120V, or 200/100V)	
Features	Notes
<b>Mains ground systems:</b> TN-S, TT, IT-HRG, TN-C Input voltages: Any <b>Power range:</b> Any, but limited in North America to less than 100 kVA due to UPS being 480 V or 600 V above this power rating <b>Efficiency:</b> Highest efficiency <b>IT load neutral bond:</b> Established at the UPS output	<ul style="list-style-type: none"> <li>• If the input transformer is local to the UPS, then its neutral connection is not connected to ground at the transformer, but brought to the UPS where neutral is connected to ground at the UPS output (preferred method)</li> <li>• If the input transformer is remote from the UPS, then the neutral may be required to be connected to ground at the transformer, and the UPS neutral must be connected to this neutral and cannot be connected to ground at the UPS</li> </ul>

The use of this configuration, single mains without bypass, is common in countries with very poor power. However, in most cases where it is used, the single mains configuration with a bypass would be a better choice. The reason why many customers choose not to use the bypass is because it potentially subjects the load to raw mains power. This is true even with transformer-based UPS systems, because they don't isolate the bypass. This is a problem because **in the older transformer-based UPSs, the transformer is in the wrong location.** If the transformer is moved to the input, instead of at the inverter output, then it can protect both the UPS and the bypass path (this is described in more detail in the next section).

A major problem with the single mains without bypass configuration is that the load fault current is always limited to the UPS inverter output current, which is typically much lower than the mains available short-circuit current. This can cause difficulty clearing breakers downstream of the UPS, and can result in a total load drop when a downstream fault does not clear, or even if it does not clear quickly. In contrast, in a configuration *with* a bypass, output faults activate the bypass and the mains current is available to help clear output faults.

When designers and users understand all the options, the use of the single mains without bypass configuration can be expected to decline in use. The single mains *with* bypass, when combined with an input transformer, is the same cost, weight, and efficiency but preserves the additional option of using the bypass, which can be beneficial. In general, there are common historical configurations using transformer-based UPSs that will be replaced by newer configurations. This will be described in the next section.

## Transformer-based legacy UPS designs

A transformer-based UPS is defined as a UPS with an integrated transformer in the inverter output location. **This paper has shown that none of the 8 preferred UPS/transformer arrangements have a transformer in the inverter output location.** Note that some transformer-based UPS systems, as well as transformerless ones, may have additional optional transformers. Nevertheless, because older UPS systems have inverter transformers, there are arrangements in common use that were originally utilized to take advantage of the

integral UPS transformer. In this section, we will review these arrangements, explain why they are not optimal, and what transformer arrangements should be used instead.

“None of the 8 preferred UPS/transformer arrangements have a transformer in the inverter output location”

Transformer-based UPSs have the transformer after the output of the inverter and before the bypass connection to the UPS output. **This is the least useful place that a transformer can be located in a UPS** for these reasons:

- It does not protect the UPS input
- It does not isolate the rectifier ground system from the mains
- It is always dissipating heat because it is handling the full load power
- It can't allow the output neutral to be isolated from the input due to the presence of the bypass

It is important to understand that the transformer exists in this location *because it was required as part of the UPS inverter circuits*, and was not added to solve these other problems. It does provide one key function, of isolating the inverter from the output, but this function can also be provided by transformers placed in other, and better, locations. Even though transformer-based UPSs have the transformer in a sub-optimal location, the transformer is part of the circuitry and not optional, so many early data center designs took advantage of it. There are two main designs that take advantage of the integral transformer in a transformer-based UPS, which are summarized in **Table 7a** and **Table 7b** along with recommended improved replacement designs.

**Table 7a**

Legacy DUAL MAINS configuration with inverter transformer

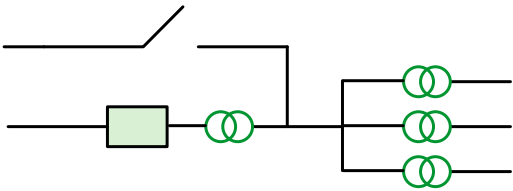
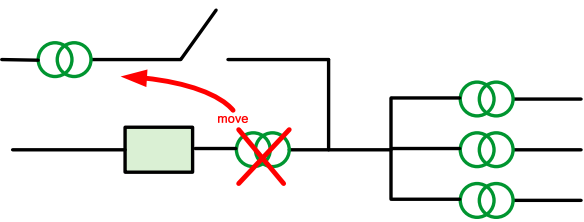
 <p><b>DUAL MAINS</b> Inverter transformer Remote output transformer(s)</p>	
<p><b>Application:</b> <b>Not recommended for new designs.</b> Was commonly used in large data centers</p>	
<p><b>Features</b></p>	<p><b>Notes</b></p>
<p><b>Mains ground systems:</b> TN-S, TT, IT-HRG, TN-C  <b>Input voltages:</b> Mains and UPS voltages must match  <b>Power range:</b> Any, but impractical for smaller data centers  <b>Efficiency:</b> High, but lower if multiple output transformers are used  <b>IT load neutral bond:</b> Established at the output transformer</p>	<ul style="list-style-type: none"> <li>• The UPS rectifier must be rated to operate with the specified mains ground system. Not all UPS can operate with an IT-HRG ground system, and some UPS require an input neutral connection</li> <li>• There is no neutral connection between the UPS and the output transformer(s) in this system</li> <li>• The output transformer may be a single transformer or its function may be divided among many PDU transformers</li> </ul>
<p><i>Recommended replacement:</i></p> <p><b>DUAL MAINS</b> Bypass transformer Remote output transformer(s)</p>	
<p><b>Advantages of replacement</b></p>	<p><b>Notes</b></p>
<p><b>Higher efficiency:</b> moving the transformer to the bypass path improves efficiency because the load power is not normally creating losses in the transformer</p>	<ul style="list-style-type: none"> <li>• The bypass transformer may be available as an option of the UPS</li> <li>• The neutral of the inverter output, if any, is now connected to the rectifier input neutral, instead of the bypass input neutral</li> <li>• The IT load neutral is still established at the output transformer</li> <li>• Compatibility with RCD is preserved</li> </ul>

It is important to recognize that in the above situation the legacy inverter transformer was providing a function of isolating the inverter from the bypass neutral. In this case it is better to locate the transformer in the bypass path for the reasons provided. However, as stated in the earlier sections describing the single mains and dual mains recommended systems, not all installations require isolation between the inverter and the bypass neutral. In designing a new facility, the recommended designs described in the earlier sections should be considered first; the examples here are only to show how a few popular legacy designs should be improved.

**Table 7b**

Legacy SINGLE MAINS configuration with inverter transformer

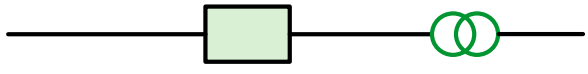
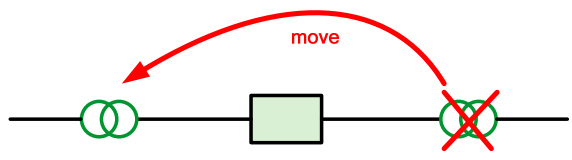
 <p><b>SINGLE MAINS</b> No bypass Inverter transformer</p>	
<p><b>Application:</b> <b>Not recommended for new designs.</b> Was used for large or small data centers with poor mains power quality and poor mains ground system, where UPS and IT load voltage are the same (400/230V, 208/120V, or 200/100V).</p>	
Features	Notes
<p><b>Mains ground systems:</b> TN-S, TT, IT-HRG, TN-C</p> <p><b>Input voltages:</b> Mains, UPS, and IT load voltage must match</p> <p><b>Power range:</b> Any, but limited in North America to &lt; 100kVA due to UPS being 480V or 600V above this power rating</p> <p><b>Efficiency:</b> High efficiency</p> <p><b>IT load neutral bond:</b> Established at the UPS output</p>	<ul style="list-style-type: none"> <li>The UPS rectifier input must be rated to operate with the specified mains ground system</li> <li>Not all UPSs can operate with an IT-HRG ground system, and some UPS require an input neutral connection</li> <li>In very poor mains ground system, the rectifier is exposed to various hazards</li> </ul>
<p><i>Recommended replacement:</i></p> <p><b>SINGLE MAINS</b> No bypass Input transformer</p>	
Advantages of replacement	Notes
<p><b>Protection of UPS from mains faults:</b> moving the transformer to the input isolates the UPS rectifier from ground or neutral faults on the mains</p> <p><b>Ground system compatibility:</b> The UPS is always operated from the TN-S output of the transformer, independent of the mains ground system</p> <p><b>Voltage adjustment:</b> The input transformer can include taps to allow adaptation of the UPS to chronic high or low mains voltage</p> <p><b>Voltage conversion:</b> The input transformer can step the mains voltage up or down</p>	<ul style="list-style-type: none"> <li>Any UPS can be used, without regard for the mains grounding system</li> <li>The input transformer may be available as an option of the UPS</li> <li>The neutral of the inverter output, if any, is still bonded to ground</li> <li>The input transformer neutral is not bonded to ground at the transformer but is connected to the UPS output neutral</li> </ul>

The above two tables represent the most common ways that transformer-based UPSs were used in earlier system designs. There are other variations of these designs, but in each case the historic location of the transformer is not optimal, and moving the inverter transformer to the input, the bypass, or eliminating it is a better solution.

## Transformer options within a UPS product

This paper has shown that there are a number of preferred designs that include a local input transformer that might be located on the bypass, the rectifier, or on the combined mains. To simplify design and deployment, UPS manufacturers should offer such input transformers as readily available, pre-engineered UPS options.

Some preferred designs include a remote output transformer. Such transformers are best placed within PDU units or at the IT room and are not appropriate options for a UPS system, unless needed for a voltage change.

## Conclusion

Many UPS installations include transformers. This is true whether the UPS is transformer-based or transformerless. Transformers have important functions in a UPS installation including changing voltage, interfacing between ground systems, eliminating neutral loops, and protecting from various types of faults. Although most modern UPSs are transformerless, transformers are still often, but not always, necessary in the system design. There are many system designs where transformers are needed or even legally required.

Transformer-based UPS systems almost never have the transformer located in the optimal location to achieve design goals. Transformerless UPS systems remove the transformer and allow the flexibility of omitting it or moving it to the best location for an intended purpose, optimizing the design.

This paper has identified over 50 different arrangements of transformers that can be used with UPS systems. Of these, 10 are identified as the preferred solutions for data center designs, the specific choice depending on the preferences and constraints of the design as described in this paper. Larger-power UPS systems are found to have different preferred transformer arrangements than smaller-power UPS. Some preferred arrangements are needed to satisfy severe power conditions and degraded mains grounding. All of the preferred arrangements are best satisfied by using transformers in conjunction with a transformerless UPS.



### About the author

**Neil Rasmussen** is a Senior VP of Innovation for Schneider Electric. He establishes the technology direction for the world's largest R&D budget devoted to power, cooling, and rack infrastructure for critical networks.

Neil holds 19 patents related to high-efficiency and high-density data center power and cooling infrastructure, and has published over 50 white papers related to power and cooling systems, many published in more than 10 languages, most recently with a focus on the improvement of energy efficiency. He is an internationally recognized keynote speaker on the subject of high-efficiency data centers. Neil is currently working to advance the science of high-efficiency, high-density, scalable data center infrastructure solutions and is a principal architect of the APC InfraStruXure system.

Prior to founding APC in 1981, Neil received his bachelors and masters degrees from MIT in electrical engineering, where he did his thesis on the analysis of a 200MW power supply for a tokamak fusion reactor. From 1979 to 1981 he worked at MIT Lincoln Laboratories on flywheel energy storage systems and solar electric power systems.



## Resources



Browse all  
white papers  
[whitepapers.apc.com](http://whitepapers.apc.com)



**Electrical Efficiency Measurement  
for Data Centers**  
White Paper 154



**Selecting an Industry Standard Metric  
for Data Center Efficiency**  
White Paper 157



**Electrical Efficiency Modeling  
for Data Centers**  
White Paper 113



**Implementing Energy Efficient  
Data Centers**  
White Paper 114



**Guidance for Calculation of  
Efficiency (PUE) in Data Centers**  
White Paper 158



Browse all  
TradeOff Tools™  
[tools.apc.com](http://tools.apc.com)



**Data Center Efficiency Calculator**  
TradeOff Tool 6



**Data Center Carbon Calculator**  
TradeOff Tool 7



## Contact us

For feedback and comments about the content of this white paper:

Data Center Science Center  
[DCSC@Schneider-Electric.com](mailto:DCSC@Schneider-Electric.com)

If you are a customer and have questions specific to your data center project:

Contact your **Schneider Electric** representative