

MOUNTING SUPPORT – DUCT LIGHTING (W/O LIGHTS)

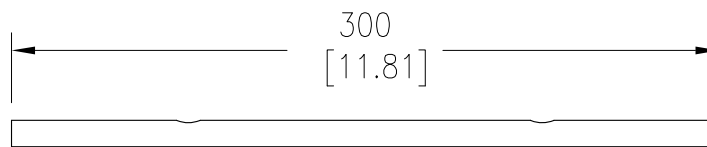

FRONT VIEW

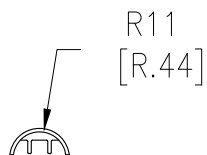
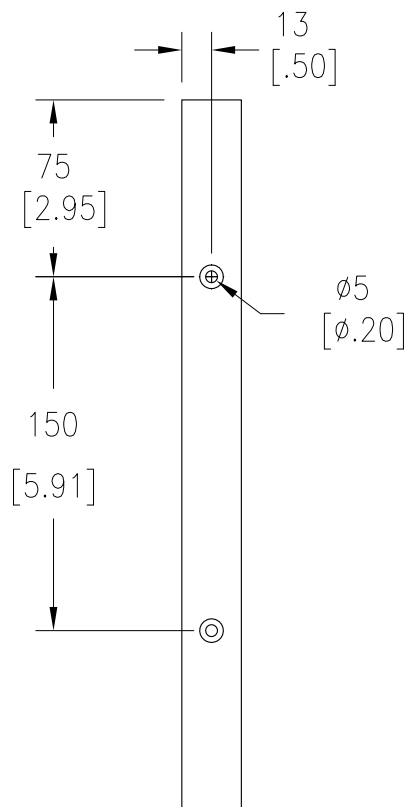

TOP VIEW

LEFT SIDE VIEW

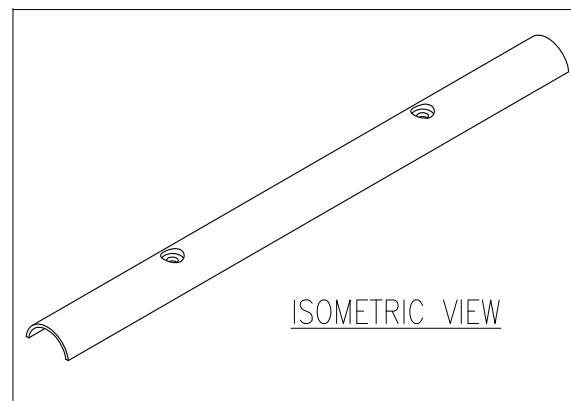

NOTES:

1. COMPLY WITH ALL APPLICABLE NATIONAL AND LOCAL ELECTRICAL REGULATIONS.
2. REFER TO PRODUCT DOCUMENTATION FOR ADDITIONAL DETAILS PRIOR TO INSTALLATION AND SITE PREPARATION WORK.
3. ALL DIMENSIONS ARE IN MILLIMETERS [INCHES].
4. NET WEIGHT (ALL BRACKETS INCLUDED) IS 1.52kg [3.35lbs]

THIS DRAWING AND SPECIFICATIONS HEREIN ARE THE PROPERTY OF SCHNEIDER ELECTRIC AND SHALL NOT BE COPIED, REPRODUCED OR USED IN WHOLE OR IN PART, AS THE BASIS FOR THE MANUFACTURE OR SALE OF ITEMS WITHOUT WRITTEN PERMISSION FROM SCHNEIDER ELECTRIC. THIS DRAWING IS BASED UPON LATEST AVAILABLE INFORMATION AND IS SUBJECT TO CHANGE WITHOUT NOTICE.



TITLE:
Eco-Aisle (TM) Aisle Containment System
MOUNTING SUPPORT-DUCT LIGHTING (WO LIGHTS)
ALUMINIUM WIRING COVER
PROJECT: SUBMITTAL DRAWINGS SHEET 1 OF 2

DWG NO:	ACDC2302	REV.	0
DRAWN BY:	K.NAGENDRA	03-JUL-13	FIRST
ENGINEER:	RUSTIN SHI/MARK MENG	03-JUL-13	ANGLE
APPROVED BY:	AARON GRAFF	03-JUL-13	PROJ

MOUNTING SUPPORT- DUCT LIGHTING (W/O LIGHTS)

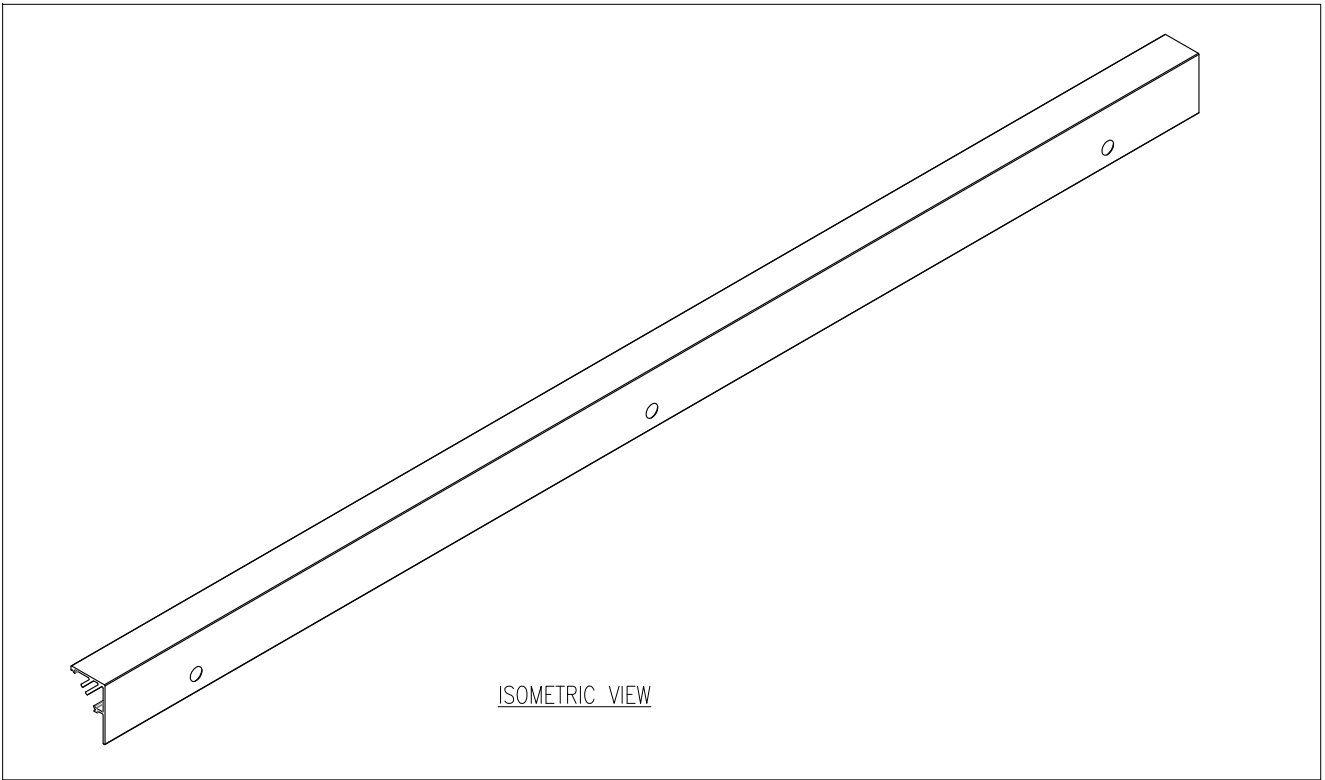
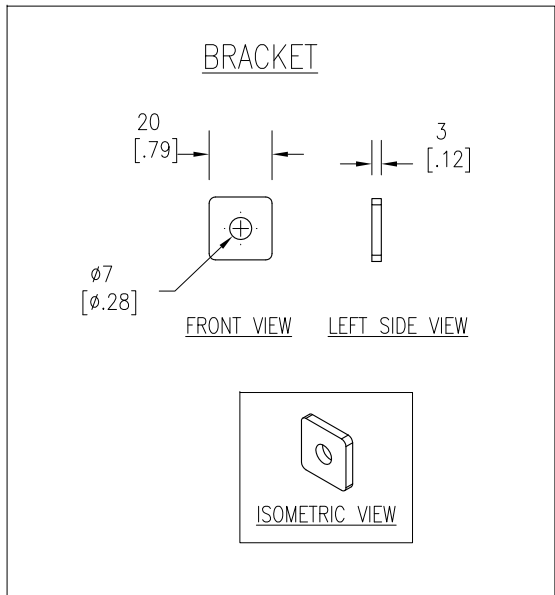
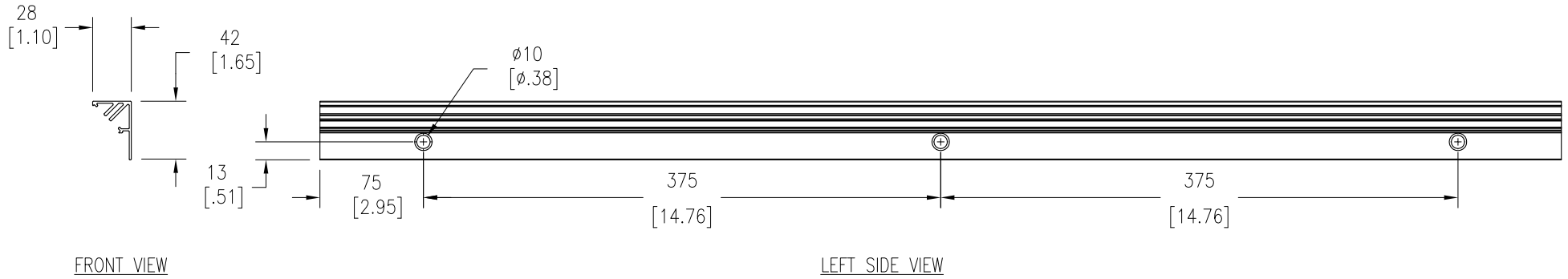

NOTES:

1. COMPLY WITH ALL APPLICABLE NATIONAL AND LOCAL ELECTRICAL REGULATIONS.
2. REFER TO PRODUCT DOCUMENTATION FOR ADDITIONAL DETAILS PRIOR TO INSTALLATION AND SITE PREPARATION WORK.
3. ALL DIMENSIONS ARE IN MILLIMETERS [INCHES].

THIS DRAWING AND SPECIFICATIONS HEREIN ARE THE PROPERTY OF SCHNEIDER ELECTRIC AND SHALL NOT BE COPIED, REPRODUCED OR USED IN WHOLE OR IN PART, AS THE BASIS FOR THE MANUFACTURE OR SALE OF ITEMS WITHOUT WRITTEN PERMISSION FROM SCHNEIDER ELECTRIC. THIS DRAWING IS BASED UPON LATEST AVAILABLE INFORMATION AND IS SUBJECT TO CHANGE WITHOUT NOTICE.



TITLE:
Eco-Aisle (TM) Aisle Containment System
MOUNTING SUPPORT-DUCT LIGHTING (WO LIGHTS)
LIGHT MTG RAIL & BRKT
PROJECT: SUBMITTAL DRAWINGS SHEET 2 OF 2

DWG NO:	ACDC2302	REV.	0
DRAWN BY:	K.NAGENDRA	03-JUL-13	FIRST
ENGINEER:	RUSTIN SHI/MARK MENG	03-JUL-13	ANGLE
APPROVED BY:	AARON GRAFF	03-JUL-13	PROJ