

THIS DRAWING AND SPECIFICATIONS HEREIN ARE THE PROPERTY OF SCHNEIDER ELECTRIC AND SHALL NOT BE COPIED, REPRODUCED OR USED IN WHOLE OR IN PART, AS THE BASIS FOR THE MANUFACTURE OR SALE OF ITEMS WITHOUT WRITTEN PERMISSION FROM SCHNEIDER ELECTRIC. THIS DRAWING IS BASED UPON LATEST AVAILABLE INFORMATION AND IS SUBJECT TO CHANGE WITHOUT NOTICE.

JOINTS AND OTHER CONSTRUCTION SHOULD BE CHECKED BY LOCAL EXPERT TO CONFIRM THAT SPECIFICATIONS MEET ALL LOCAL BUILDING CODES

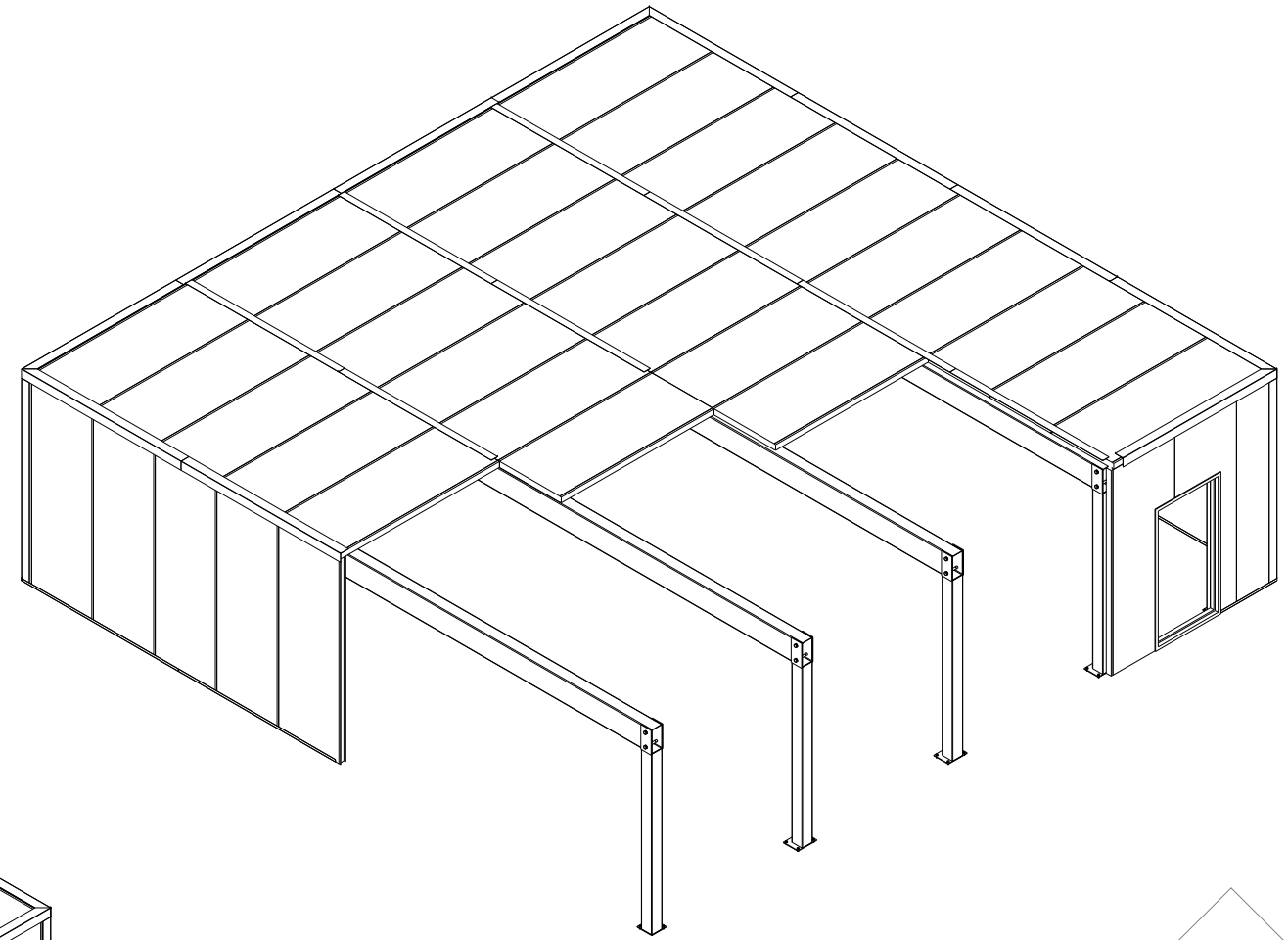
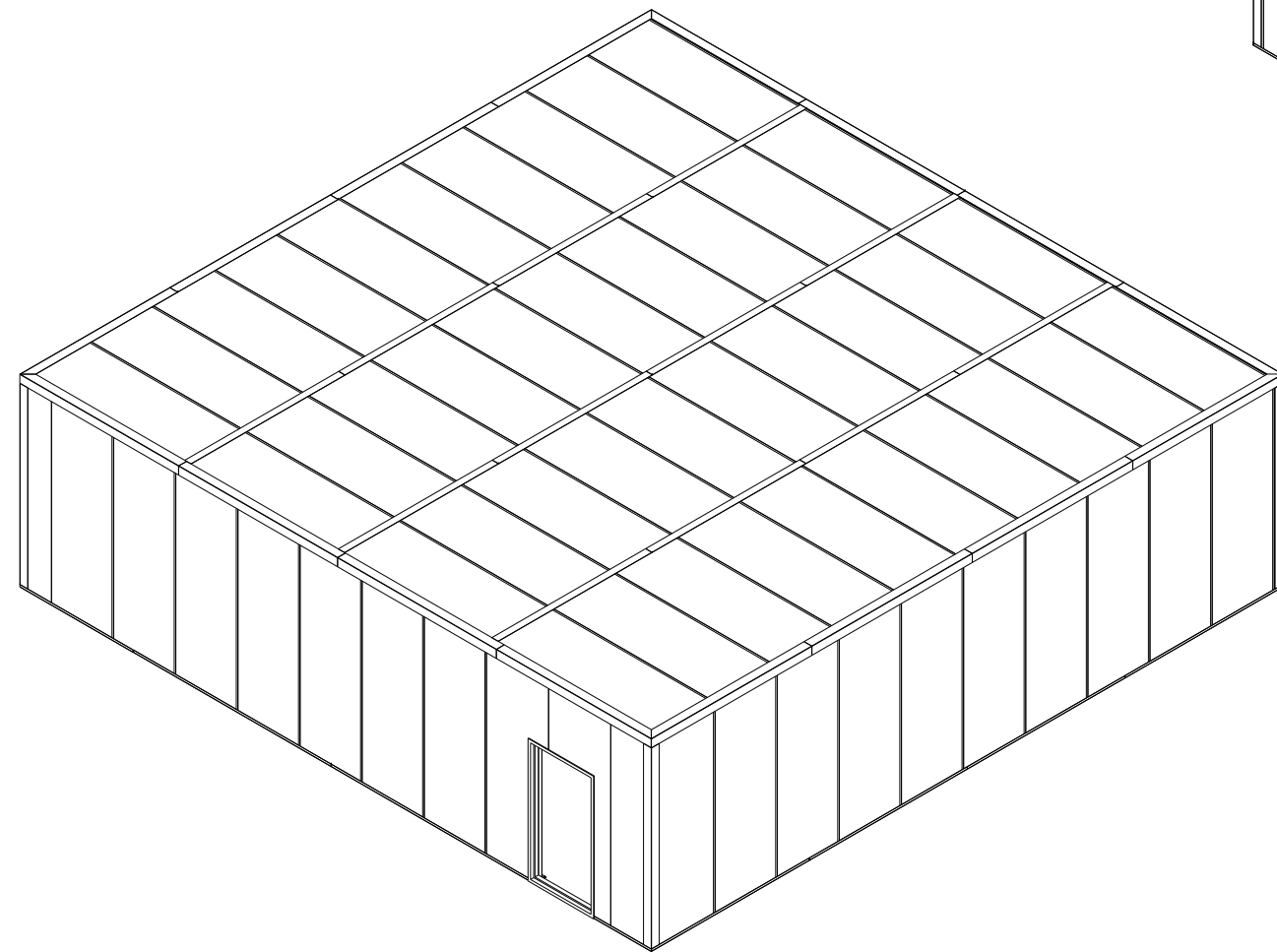

NOT FOR CONSTRUCTION

SMART SHELTER ROOM

SIZE B



VERSION: 01 DATE: 12.04.2017	TABLE OF CONTENTS	
CODE	DRAWING TITLE	DESCRIPTION
SSRB.S03.A01.1	ELEVATIONS	EXTERNAL VIEWS AND DIMENSIONS OF THE ROOM
SSRB.S02.A01.1	INTERNAL LAYOUT	INTERNAL VIEWS AND DIMENSIONS OF THE ROOM
SSRB.S02.B01.1	APC BD 80 IT LAYOUT	IMPLEMENTATION EXAMPLE OF AN IT ROOM FROM APC DESIGN PORTAL BASE DESIGN 80
SSRB.S02.C01.1	APC BD 12 IT LAYOUT	IMPLEMENTATION EXAMPLE OF AN IT ROOM FROM APC DESIGN PORTAL BASE DESIGN 12

QA System
 Drawn by
ALEIX NOGUERAS
 Designed by
ALEIX NOGUERAS
 Check by
BILL BUNGAYAO
 Authorised by
BILL BUNGAYAO



C. Coto, 9
 08830 Sant Boi de Llobregat
 Barcelona (Spain)
 T: +34 934 751 481
 F: +34 933 772 880
www.schneider-electric.com

9701 Windsch Rd, Suite 300
 West Chester Township
 OH 45069-3807
 United States
 T: +1 513 644 0560

Project SMARTSHELTER ROOM		Customer Logo	
Drawing Title SIZE B COVER		Drawing Code	
Project Ref.	Units	Scale	Sheet Size A3
			Date 12-04-2017

THIS DRAWING AND SPECIFICATIONS HEREIN ARE THE PROPERTY OF SCHNEIDER ELECTRIC AND SHALL NOT BE COPIED, REPRODUCED OR USED IN WHOLE OR IN PART, AS THE BASIS FOR THE MANUFACTURE OR SALE OF ITEMS WITHOUT WRITTEN PERMISSION FROM SCHNEIDER ELECTRIC. THIS DRAWING IS BASED UPON LATEST AVAILABLE INFORMATION AND IS SUBJECT TO CHANGE WITHOUT NOTICE.

JOINTS AND OTHER CONSTRUCTION SHOULD BE CHECKED BY LOCAL EXPERT TO CONFIRM THAT SPECIFICATIONS MEET ALL LOCAL BUILDING CODES

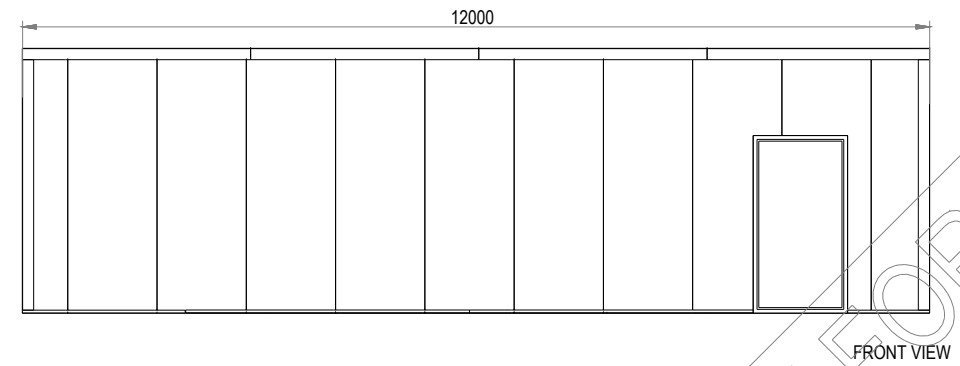
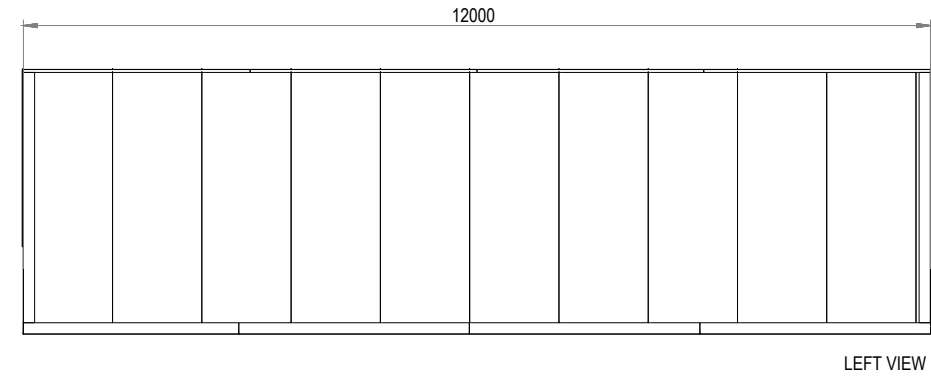
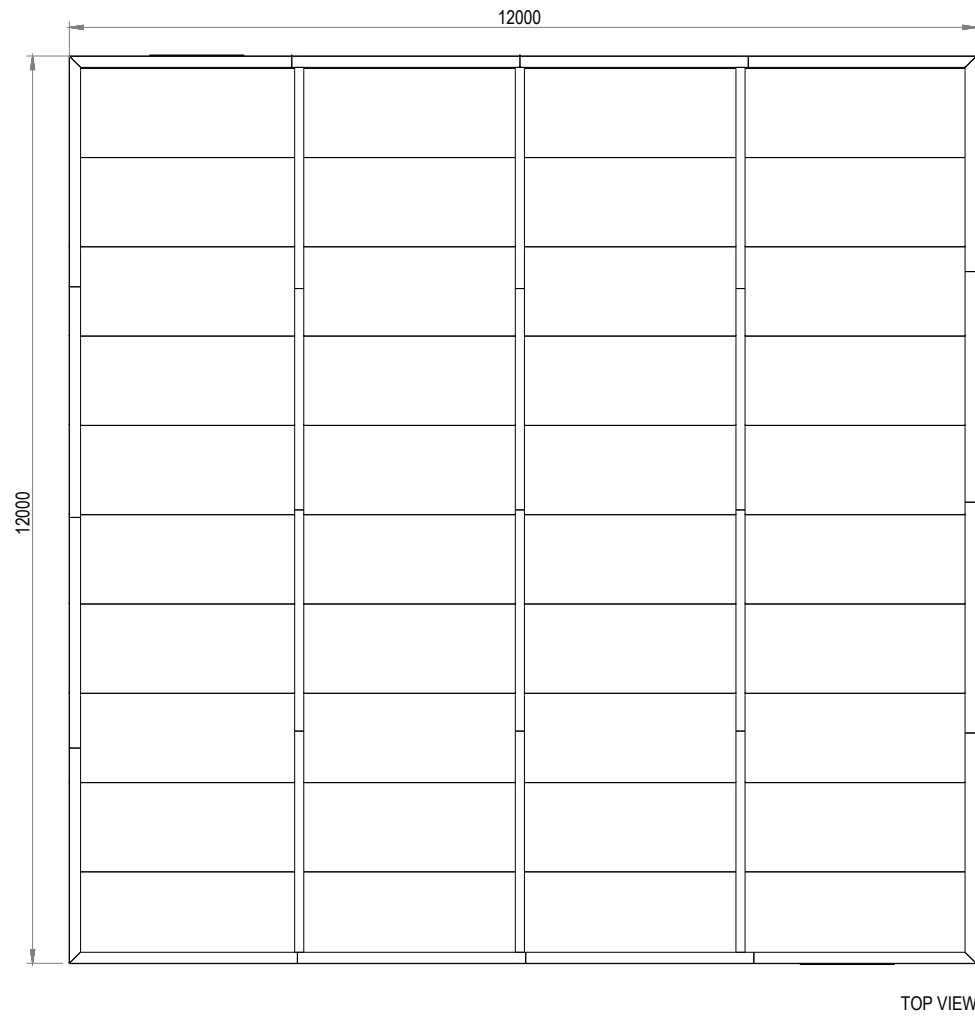

NOT FOR CONSTRUCTION

Rev.	Date	Description	Rev.	Date	Description
1	13.04.2017	DRAWING CREATED			

QA System
 Drawn by
 ALEIX NOGUERAS
 Designed by
 ALEIX NOGUERAS
 Check by
 BILL BUNGAYAY
 Authorised by
 BILL BUNGAYAY

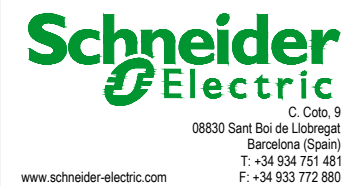

C. Coto, 9
 08830 Sant Boi de Llobregat
 Barcelona (Spain)
 T: +34 934 751 481
 F: +34 933 772 880

Project SMARTSHELTER ROOM		Customer Logo	
Drawing Title SIZE B ELEVATIONS		Drawing Code SSRB.S03.A01.1	
Project Ref.	Units mm	Scale 1:100	Sheet Size A3
			Date 12-04-2017

THIS DRAWING AND SPECIFICATIONS HEREIN ARE THE PROPERTY OF SCHNEIDER ELECTRIC AND SHALL NOT BE COPIED, REPRODUCED OR USED IN WHOLE OR IN PART, AS THE BASIS FOR THE MANUFACTURE OR SALE OF ITEMS WITHOUT WRITTEN PERMISSION FROM SCHNEIDER ELECTRIC. THIS DRAWING IS BASED UPON LATEST AVAILABLE INFORMATION AND IS SUBJECT TO CHANGE WITHOUT NOTICE.

JOINTS AND OTHER CONSTRUCTION SHOULD BE CHECKED BY LOCAL EXPERT TO CONFIRM THAT SPECIFICATIONS MEET ALL LOCAL BUILDING CODES

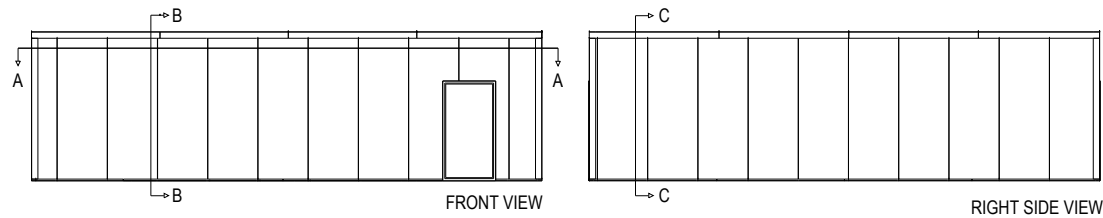
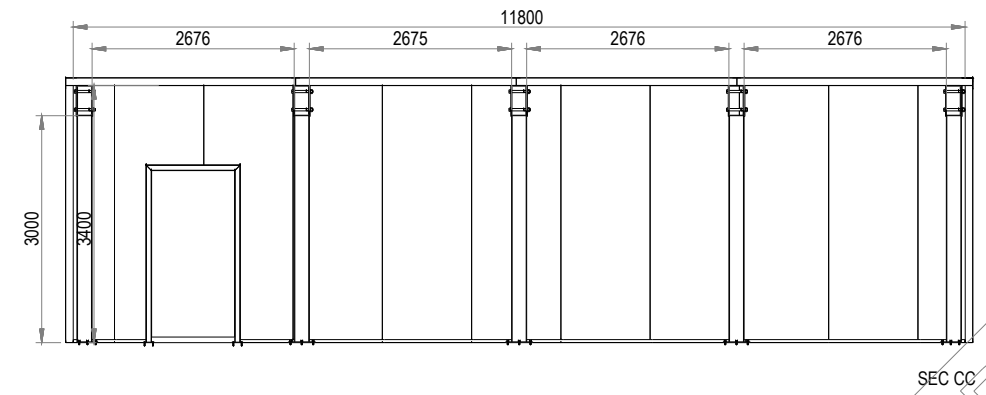
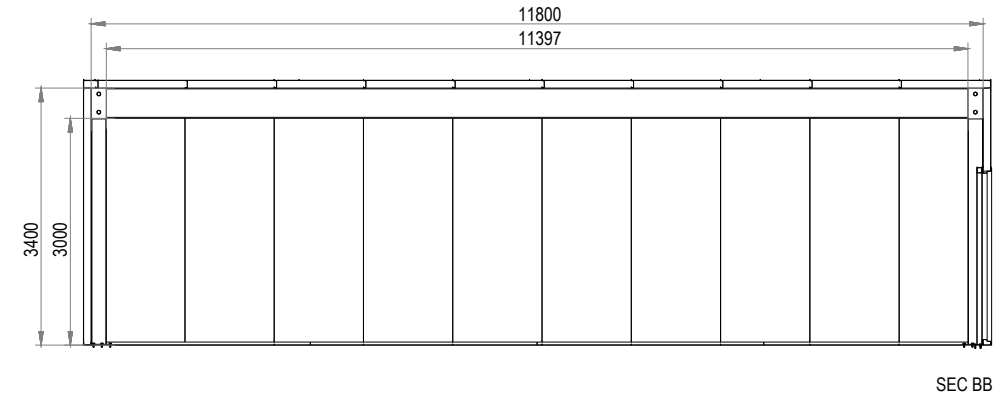
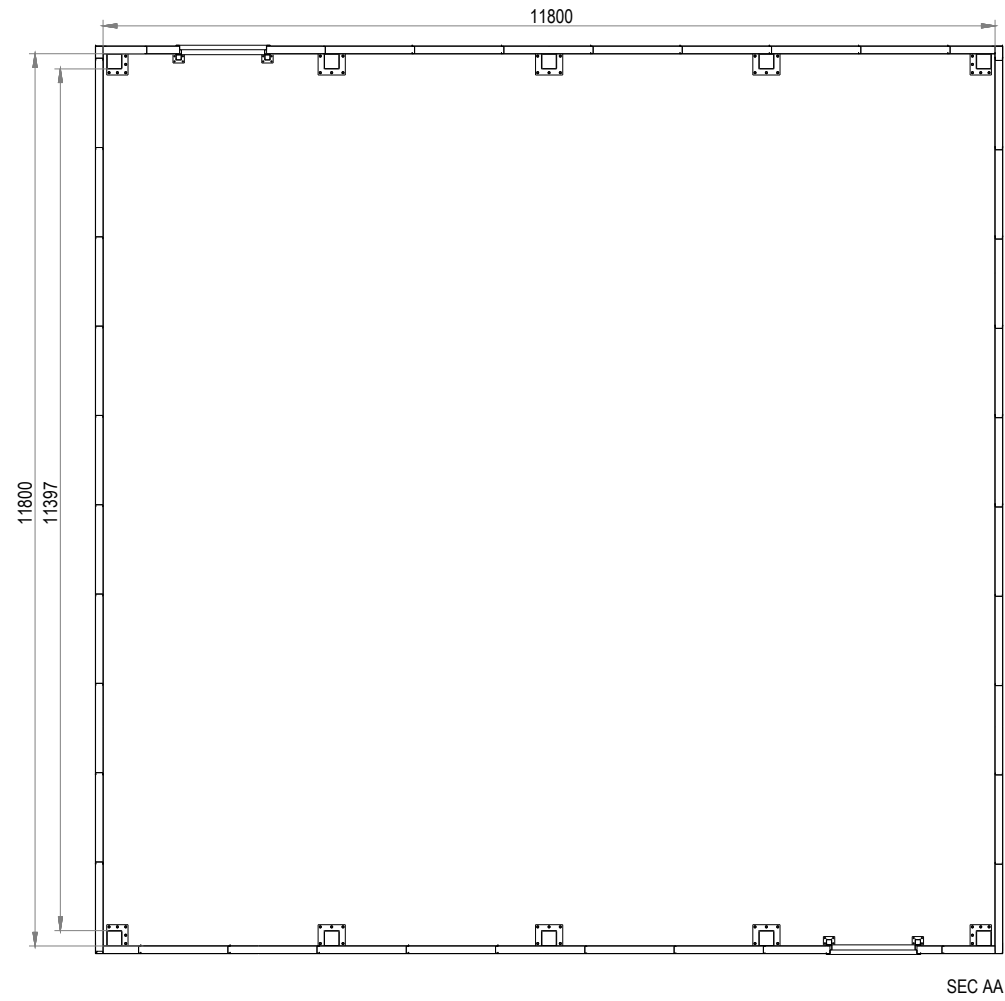

NOT FOR CONSTRUCTION

Rev.	Date	Description	Rev.	Date	Description
1	13.04.2017	DRAWING CREATED			

QA System
 Drawn by
 ALEIX NOGUERAS
 Designed by
 ALEIX NOGUERAS
 Check by
 BILL BUNGAYAO
 Authorised by
 BILL BUNGAYAO



C. Coto, 9
 08830 Sant Boi de Llobregat
 Barcelona (Spain)
 T: +34 934 751 481
 F: +34 933 772 880

9701 Windsch Rd, Suite 300
 West Chester Township
 OH 45069-3807
 United States
 T: +1 513 644 0560

Project SMARTSHELTER ROOM		Customer Logo	
Drawing Title SIZE B INTERNAL LAYOUT		Drawing Code SSRB.S02.A01.1	
Project Ref.	Units mm	Scale 1:100	Sheet Size A3
			Date 12-04-2017

THIS DRAWING AND SPECIFICATIONS HEREIN ARE THE PROPERTY OF SCHNEIDER ELECTRIC AND SHALL NOT BE COPIED, REPRODUCED OR USED IN WHOLE OR IN PART, AS THE BASIS FOR THE MANUFACTURE OR SALE OF ITEMS WITHOUT WRITTEN PERMISSION FROM SCHNEIDER ELECTRIC. THIS DRAWING IS BASED UPON LATEST AVAILABLE INFORMATION AND IS SUBJECT TO CHANGE WITHOUT NOTICE.

JOINTS AND OTHER CONSTRUCTION SHOULD BE CHECKED BY LOCAL EXPERT TO CONFIRM THAT SPECIFICATIONS MEET ALL LOCAL BUILDING CODES

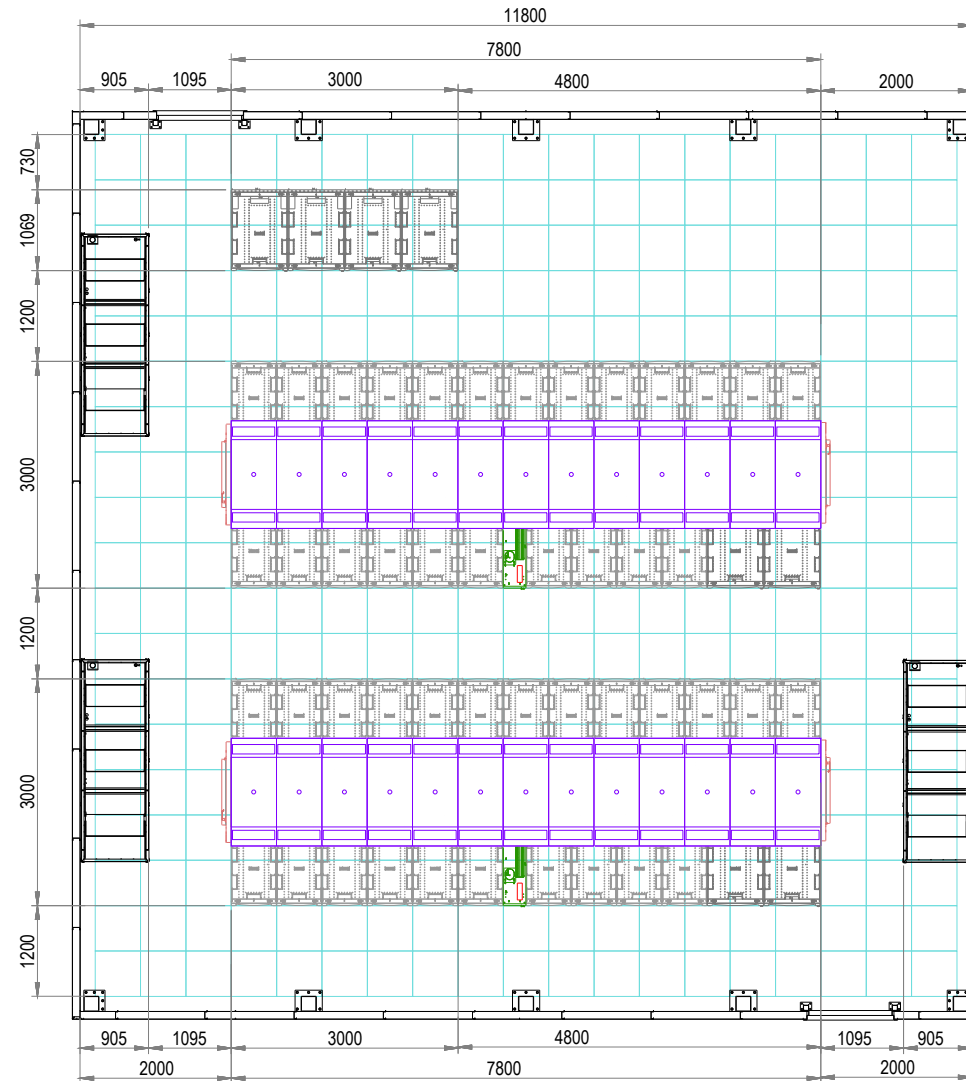

SEC AA

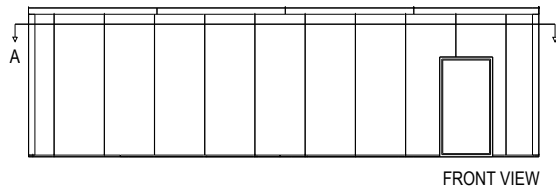

NOT FOR CONSTRUCTION

Rev.	Date	Description	Rev.	Date	Description
1	13.04.2017	DRAWING CREATED			

QA System
 Drawn by
 ALEIX NOGUERAS
 Designed by
 ALEIX NOGUERAS
 Check by
 BILL BUNGAYAO
 Authorised by
 BILL BUNGAYAO

Schneider
Electric

C. Coto, 9
 08830 Sant Boi de Llobregat
 Barcelona (Spain)
 T: +34 934 751 481
 F: +34 933 772 880
www.schneider-electric.com

9701 Windsch Rd. Suite 300
 West Chester Township
 OH 45069-3807
 United States
 T: +1 513 644 0560

Project SMARTSHELTER ROOM		Customer Logo	
Drawing Title SIZE B APC BASE DESIGN 80 IT LAYOUT		Drawing Code SSRB.S02.B01.1	
Project Ref.	Units mm	Scale 1:100	Sheet Size A3
			Date 12-04-2017

THIS DRAWING AND SPECIFICATIONS HEREIN ARE THE PROPERTY OF SCHNEIDER ELECTRIC AND SHALL NOT BE COPIED, REPRODUCED OR USED IN WHOLE OR IN PART, AS THE BASIS FOR THE MANUFACTURE OR SALE OF ITEMS WITHOUT WRITTEN PERMISSION FROM SCHNEIDER ELECTRIC. THIS DRAWING IS BASED UPON LATEST AVAILABLE INFORMATION AND IS SUBJECT TO CHANGE WITHOUT NOTICE.

JOINTS AND OTHER CONSTRUCTION SHOULD BE CHECKED BY LOCAL EXPERT TO CONFIRM THAT SPECIFICATIONS MEET ALL LOCAL BUILDING CODES

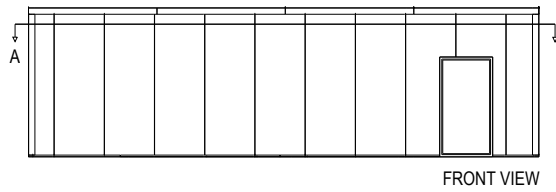
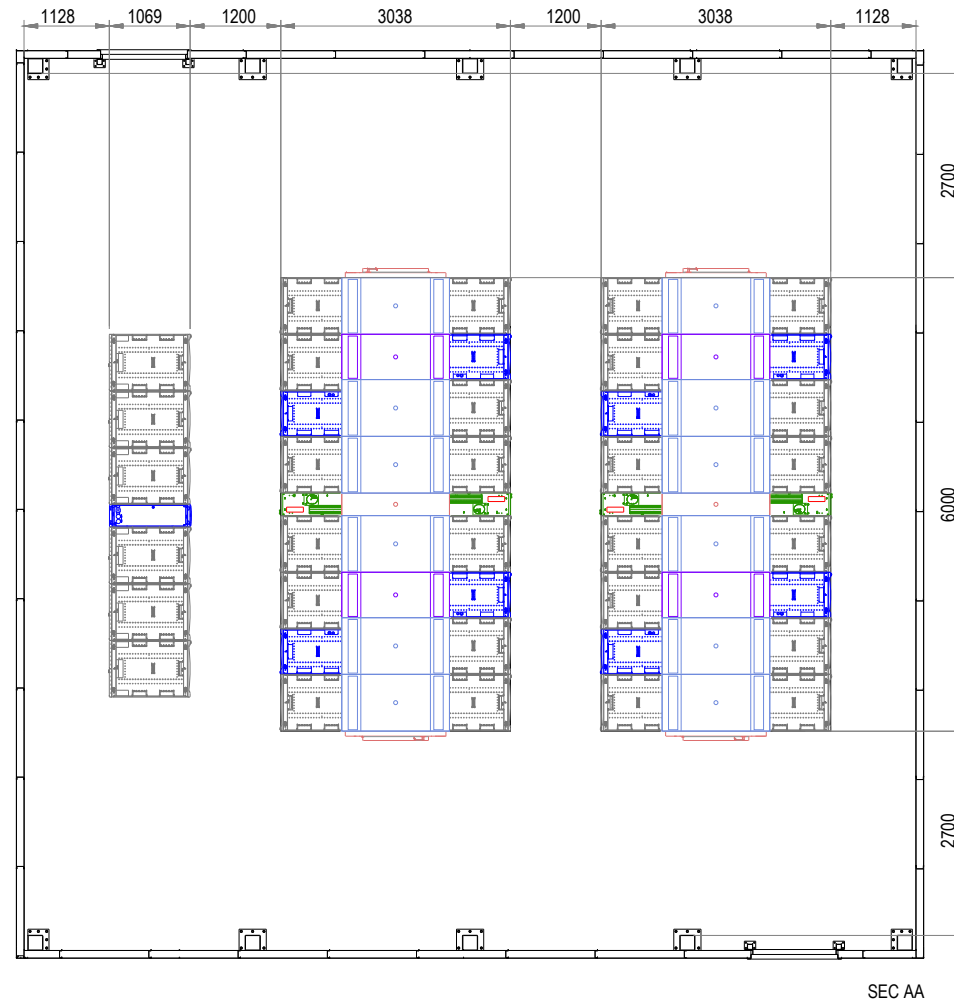

NOT FOR CONSTRUCTION

Rev.	Date	Description	Rev.	Date	Description
1	13.04.2017	DRAWING CREATED			

QA System
 Drawn by
 ALEIX NOGUERAS
 Designed by
 ALEIX NOGUERAS
 Check by
 BILL BUNGAYAO
 Authorised by
 BILL BUNGAYAO

Schneider

Electric

C. Coto, 9
 08830 Sant Boi de Llobregat
 Barcelona (Spain)
 T: +34 934 751 481
 F: +34 933 772 880
www.schneider-electric.com

9701 Windsch Rd, Suite 300
 West Chester Township
 OH 45069-3807
 United States
 T: +1 513 644 0560

Project SMARTSHELTER ROOM		Customer Logo	
Drawing Title SIZE B APC BASE DESIGN 12 IT LAYOUT		Drawing Code SSRB.S02.C01.1	
Project Ref.		Units mm	Scale 1:100
		Sheet Size A3	Date 12-04-2017