

Galaxy VM

160-200 kVA 400 V

Technical Specifications

GVMSB160KHS, GVMSB200KHS, GVMPB160KHS, GVMPB200KHS

9/2021



Legal Information

The Schneider Electric brand and any trademarks of Schneider Electric SE and its subsidiaries referred to in this guide are the property of Schneider Electric SE or its subsidiaries. All other brands may be trademarks of their respective owners.

This guide and its content are protected under applicable copyright laws and furnished for informational use only. No part of this guide may be reproduced or transmitted in any form or by any means (electronic, mechanical, photocopying, recording, or otherwise), for any purpose, without the prior written permission of Schneider Electric.

Schneider Electric does not grant any right or license for commercial use of the guide or its content, except for a non-exclusive and personal license to consult it on an "as is" basis. Schneider Electric products and equipment should be installed, operated, serviced, and maintained only by qualified personnel.

As standards, specifications, and designs change from time to time, information contained in this guide may be subject to change without notice.

To the extent permitted by applicable law, no responsibility or liability is assumed by Schneider Electric and its subsidiaries for any errors or omissions in the informational content of this material or consequences arising out of or resulting from the use of the information contained herein.

Table of Contents

Important Safety Instructions — SAVE THESE	
INSTRUCTIONS	5
Safety Precautions	6
Technical Data	8
Galaxy VM System Overview	8
UPS	8
Battery Options	8
Model List	10
Overview of Configurations	11
Input Power Factor	13
Input Voltage Window	13
Inverter Short-Circuit Capabilities (Bypass not Available)	14
Efficiency	16
Batteries	18
Modular Battery Specifications	18
Typical Battery Runtimes	18
End of Discharge Voltage	19
Battery Voltage Range	19
Derating Due to Load Power Factor	20
Battery Gassing Rates for Modular Battery Cabinets	20
Electrolyte Values for Modular Battery Cabinets	20
Compliance	20
Communication and Management	21
Overview of Input Contacts and Output Relays	21
EPO Connections	22
Facility Planning	23
Input Specifications	23
Bypass Specifications	23
Output Specifications	24
Battery Specifications	24
Requirements for a Third Party Battery Solution	25
Guidance for Organizing Battery Cables	25
Recommended Cable Sizes	25
Required Upstream Breakers	26
Torque Specifications	26
Physical	27
Weights and Dimensions	27
Shipping Weights and Dimensions	28
Clearance	29
Environment	30
Heat Dissipation	30
Drawings	32
Single System Single Mains with Modular Battery Cabinet	33
Single System Dual Mains with Modular Battery Cabinet	34
Options	35
Hardware Options	35
Battery Options	35

Configuration Options	35
Limited Factory Warranty.....	36

Important Safety Instructions — SAVE THESE INSTRUCTIONS

Read these instructions carefully and look at the equipment to become familiar with it before trying to install, operate, service or maintain it. The following safety messages may appear throughout this manual or on the equipment to warn of potential hazards or to call attention to information that clarifies or simplifies a procedure.



The addition of this symbol to a “Danger” or “Warning” safety message indicates that an electrical hazard exists which will result in personal injury if the instructions are not followed.



This is the safety alert symbol. It is used to alert you to potential personal injury hazards. Obey all safety messages with this symbol to avoid possible injury or death.

DANGER

DANGER indicates a hazardous situation which, if not avoided, **will result in death or serious injury.**

Failure to follow these instructions will result in death or serious injury.

WARNING

WARNING indicates a hazardous situation which, if not avoided, **could result in death or serious injury.**

Failure to follow these instructions can result in death, serious injury, or equipment damage.

CAUTION

CAUTION indicates a hazardous situation which, if not avoided, **could result in minor or moderate injury.**

Failure to follow these instructions can result in injury or equipment damage.

NOTICE

NOTICE is used to address practices not related to physical injury. The safety alert symbol shall not be used with this type of safety message.

Failure to follow these instructions can result in equipment damage.

Please Note

Electrical equipment should only be installed, operated, serviced, and maintained by qualified personnel. No responsibility is assumed by Schneider Electric for any consequences arising out of the use of this material.

A qualified person is one who has skills and knowledge related to the construction, installation, and operation of electrical equipment and has received safety training to recognize and avoid the hazards involved.

Safety Precautions

⚠ DANGER

HAZARD OF ELECTRIC SHOCK, EXPLOSION, OR ARC FLASH

- The product must be installed according to the specifications and requirements as defined by Schneider Electric. It concerns in particular the external and internal protections (upstream circuit breakers, battery circuit breakers, cabling, etc.) and environmental requirements. No responsibility is assumed by Schneider Electric if these requirements are not respected.
- After the UPS system has been electrically wired, do not start up the system. Start-up must only be performed by Schneider Electric.

Failure to follow these instructions will result in death or serious injury.

⚠ DANGER

HAZARD OF ELECTRIC SHOCK, EXPLOSION, OR ARC FLASH

The UPS System must be installed according to local and national regulations. Install the UPS according to:

- IEC 60364 (including 60364-4-41- protection against electric shock, 60364-4-42 - protection against thermal effect, and 60364-4-43 - protection against overcurrent), **or**
- NEC NFPA 70

depending on which one of the standards apply in your local area.

Failure to follow these instructions will result in death or serious injury.

⚠ DANGER

HAZARD OF ELECTRIC SHOCK, EXPLOSION, OR ARC FLASH

- Install the UPS system in a temperature controlled area free of conductive contaminants and humidity.
- Install the UPS system on a non-flammable, level, and solid surface (e.g. concrete) that can support the weight of the system.

Failure to follow these instructions will result in death or serious injury.

⚠ DANGER

HAZARD OF ELECTRIC SHOCK, EXPLOSION, OR ARC FLASH

The UPS is not designed for and must therefore not be installed in the following unusual operating environments:

- Damaging fumes
- Explosive mixtures of dust or gases, corrosive gases, or conductive or radiant heat from other sources
- Moisture, abrasive dust, steam or in an excessively damp environment
- Fungus, insects, vermin
- Salt-laden air or contaminated cooling refrigerant
- Pollution degree higher than 2 according to IEC 60664-1
- Exposure to abnormal vibrations, shocks, and tilting
- Exposure to direct sunlight, heat sources, or strong electromagnetic fields

Failure to follow these instructions will result in death or serious injury.

NOTICE

RISK OF OVERHEATING

Respect the clearance requirements around the UPS system and do not cover the product's ventilation openings when the UPS system is in operation.

Failure to follow these instructions can result in equipment damage.

NOTICE

RISK OF EQUIPMENT DAMAGE

Do not connect the UPS output to regenerative load systems including photovoltaic systems and speed drives.

Failure to follow these instructions can result in equipment damage.

Technical Data

Galaxy VM System Overview

UPS

Front View of UPS

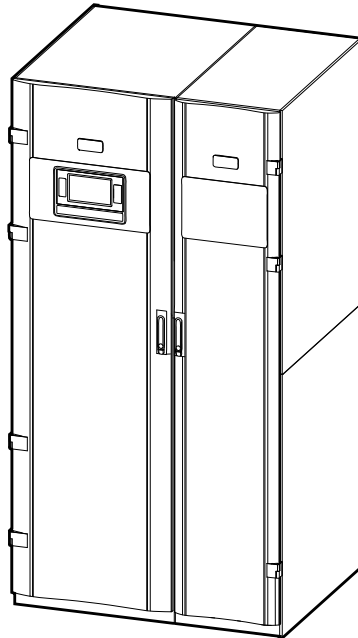

The UPS is the core in each Galaxy VM System and consists of two cabinets:

- To the right an I/O cabinet for field wiring and containing disconnection devices.
- To the left a power cabinet containing power electronics and the user interface.

Battery Options

Modular Battery Cabinets

The modular battery cabinet is available in two sizes:

Narrow Modular Battery Cabinet

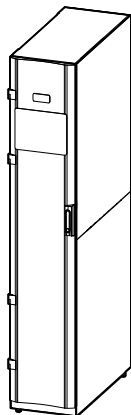

Wide Modular Battery Cabinet

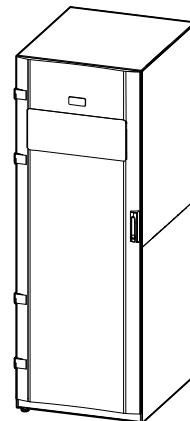

Classic Battery Cabinets

Narrow Classic Battery Cabinet

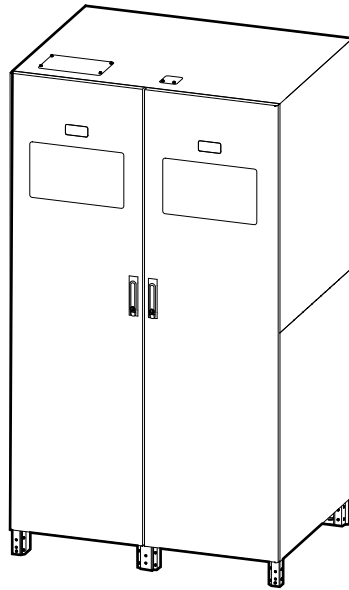

Battery Breaker Box

The battery breaker box provides protection in installations with customer-specific battery solutions.

Battery Breaker Box

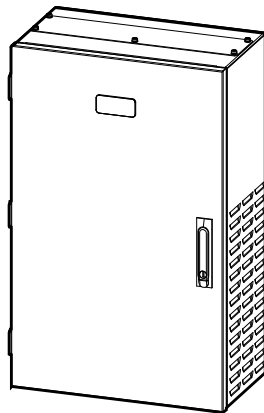

Model List

UPS Model List

- 160 kVA UPS (GVMSB160KHS)
- 200 kVA UPS (GVMSB200KHS)
- 160 kVA parallel UPS (GVMPB160KHS)
- 200 kVA parallel UPS (GVMPB200KHS)

Modular Battery Cabinets Model List

- Modular battery cabinet wide up to 12 battery module strings (GVMMODBCW)
- Modular battery cabinet narrow up to 6 battery module strings (GVMMODBCN)

Classic Battery Cabinet Model List

Solutions available in Europe, Middle East, and Africa:

- Classic battery cabinet wide empty (GVMCBCABWEL)

Battery Breaker Box

- Galaxy VM Battery Breaker Box 630 A (GVMBBB630EL)

System Bypass Cabinet

- Galaxy VM System Bypass Cabinet (GVMSBC640KHEL)

Overview of Configurations

UIB	Unit input switch
SSIB	Static switch input switch
BB	Battery breaker
MBB	Maintenance bypass breaker
UOB	Unit output switch
SIB	System isolation breaker

Single System

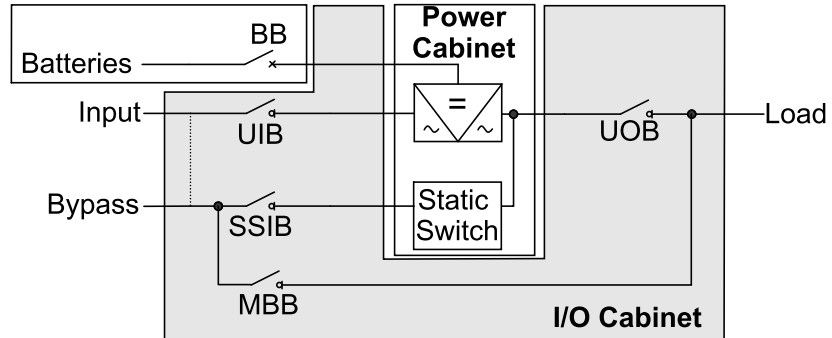

1+1 Redundant Parallel System

NOTICE

HAZARD OF EQUIPMENT DAMAGE

The cable length for bypass cables and output cables must be the same for all parallel UPS units to ensure correct load sharing in bypass operation. In parallel systems with single mains all input cables must be the same length.

Failure to follow these instructions can result in equipment damage.

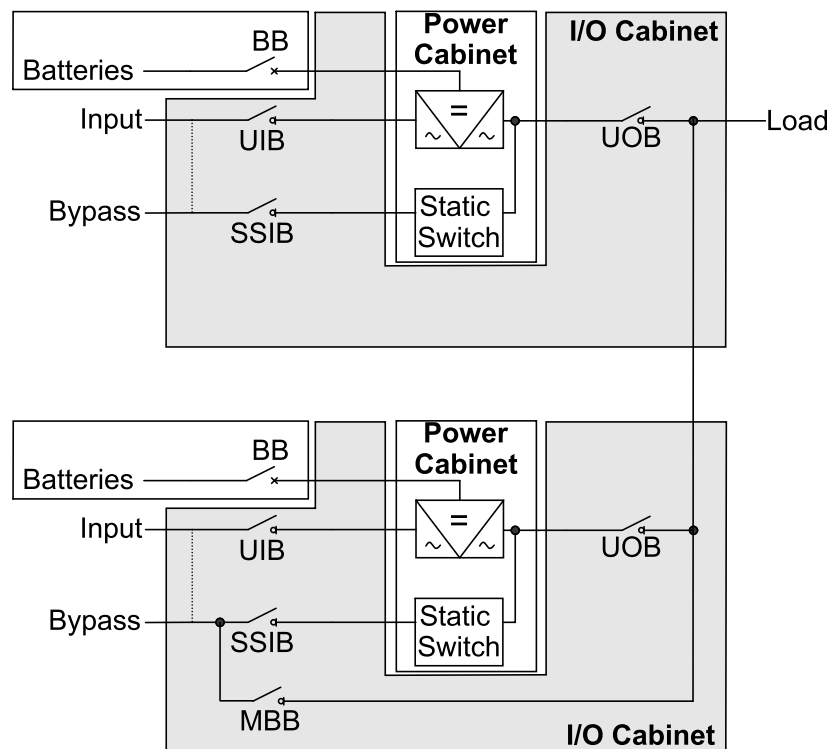

Parallel System

NOTICE

HAZARD OF EQUIPMENT DAMAGE

The cable length for bypass cables and output cables must be the same for all parallel UPS units to ensure correct load sharing in bypass operation. In parallel systems with single mains all input cables must be the same length.

Failure to follow these instructions can result in equipment damage.

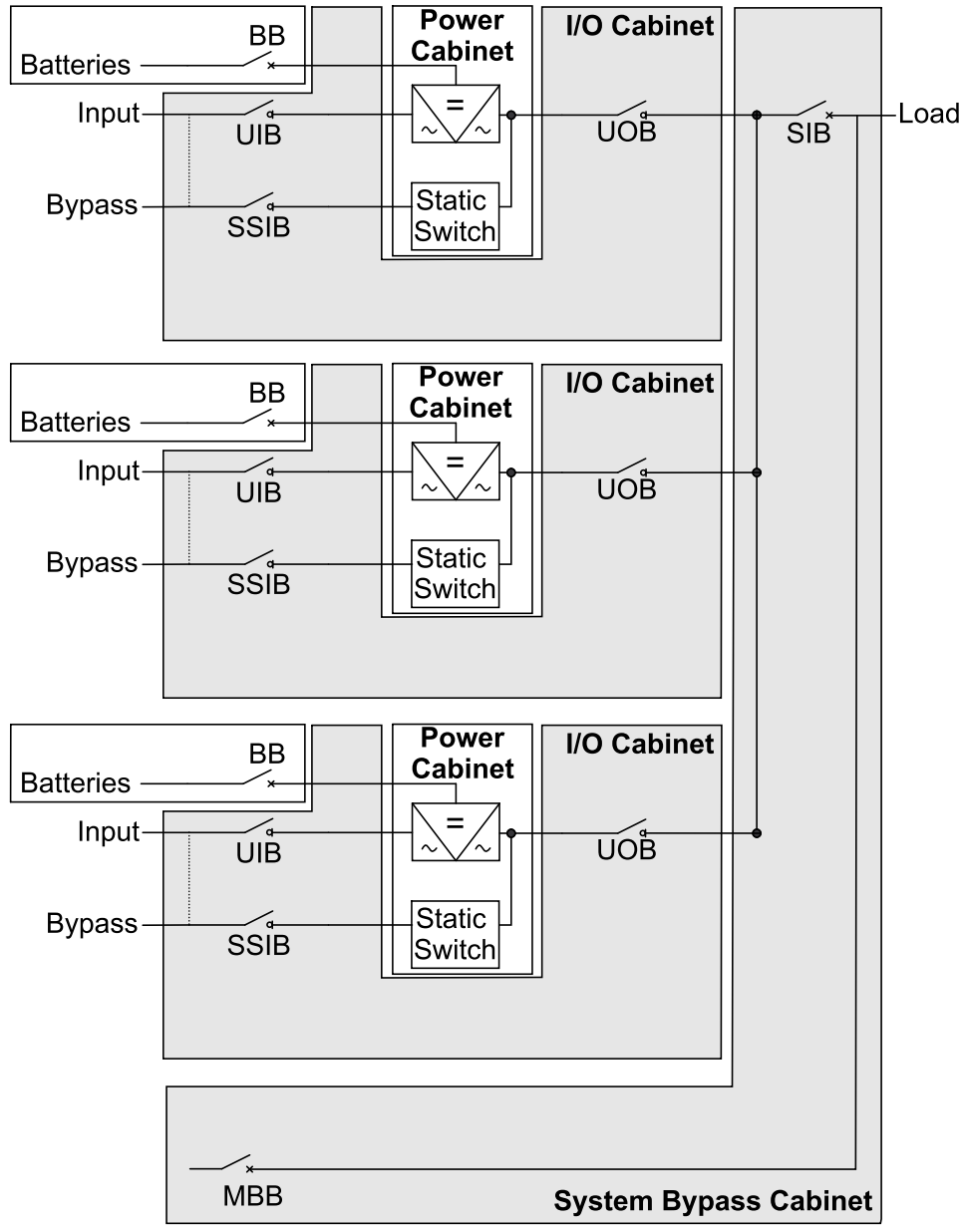

Input Power Factor

Power factor is given for a 400 V normal AC source for linear and non-linear loads.

	160 kVA	200 kVA
25% load	0.97	0.97
50% load	0.99	0.99
75% load	0.99	0.99
100% load	0.99	0.99

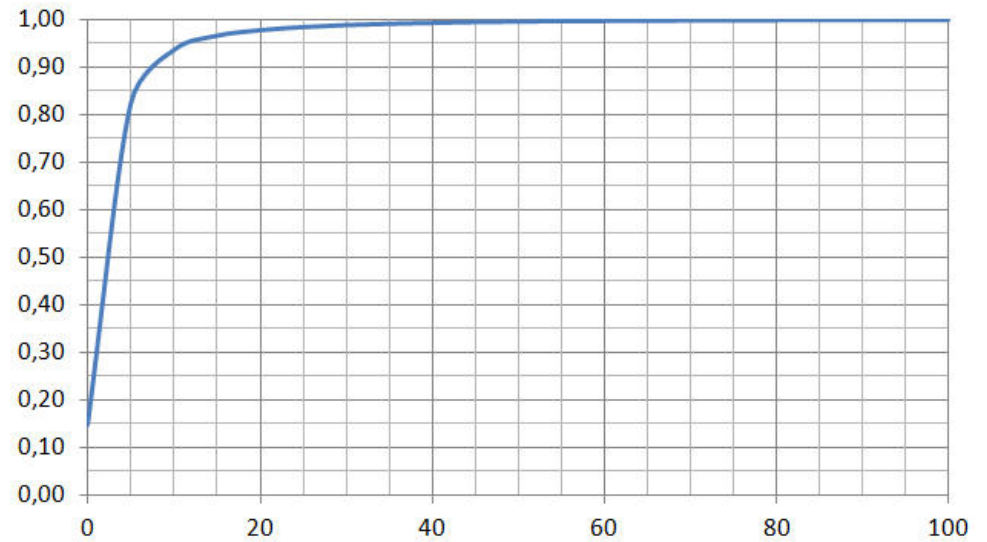

Input Voltage Window

380 V Systems

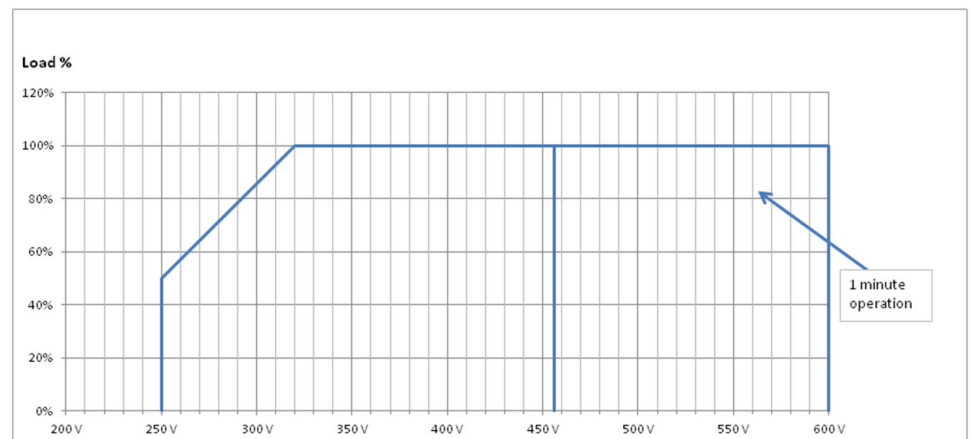

400 V Systems

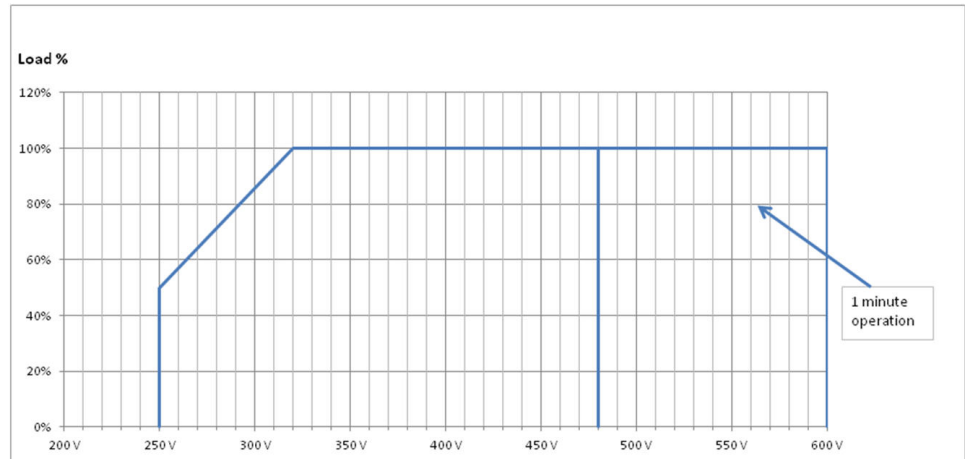

415 V Systems

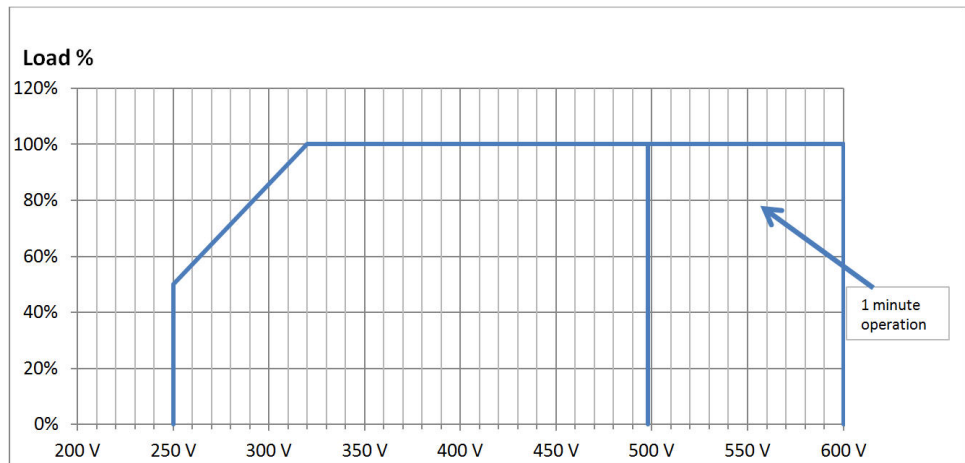

Inverter Short-Circuit Capabilities (Bypass not Available)

IK1 – Short-Circuit between a Phase and Neutral

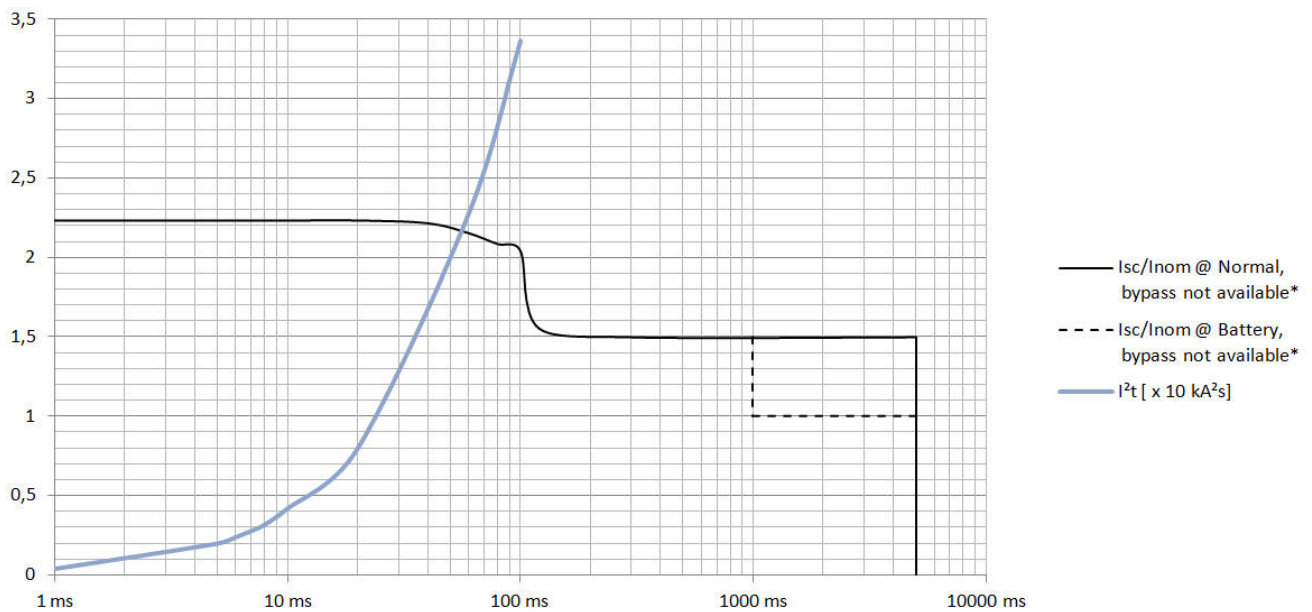

* I_{sc} = Inverter short-circuit current RMS, I_{nom} = Inverter nominal current RMS

IK2 – Short-Circuit between Two Phases

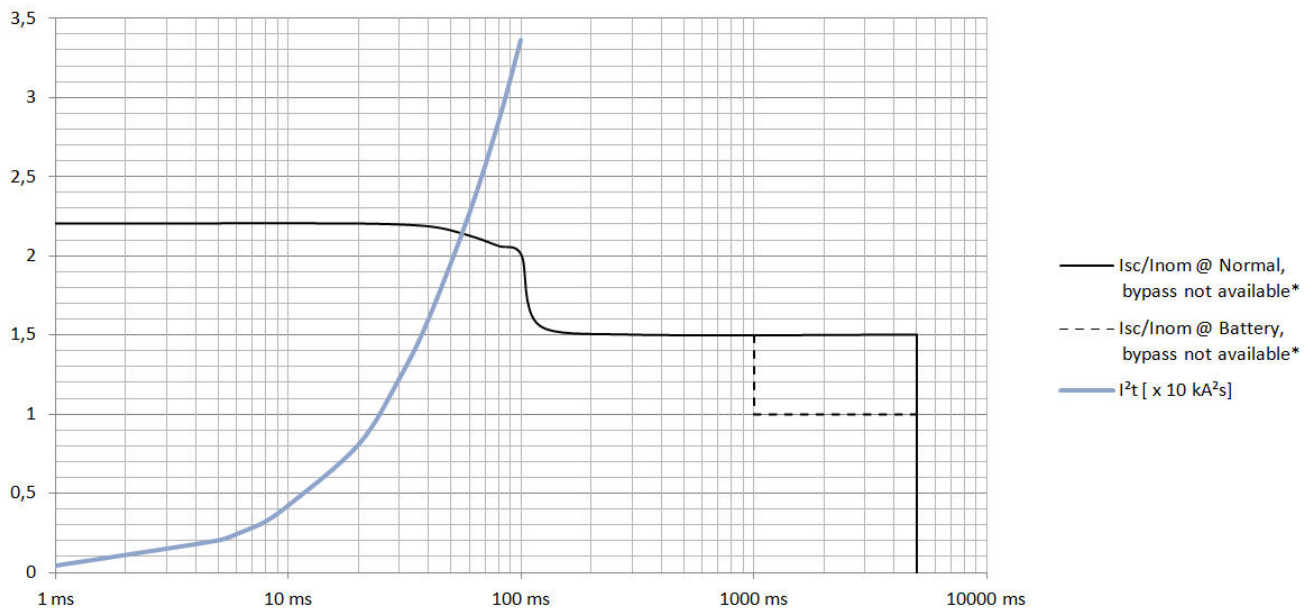

* I_{sc} = Inverter short-circuit current RMS, I_{nom} = Inverter nominal current RMS

IK3 – Short-Circuit between All Three Phases

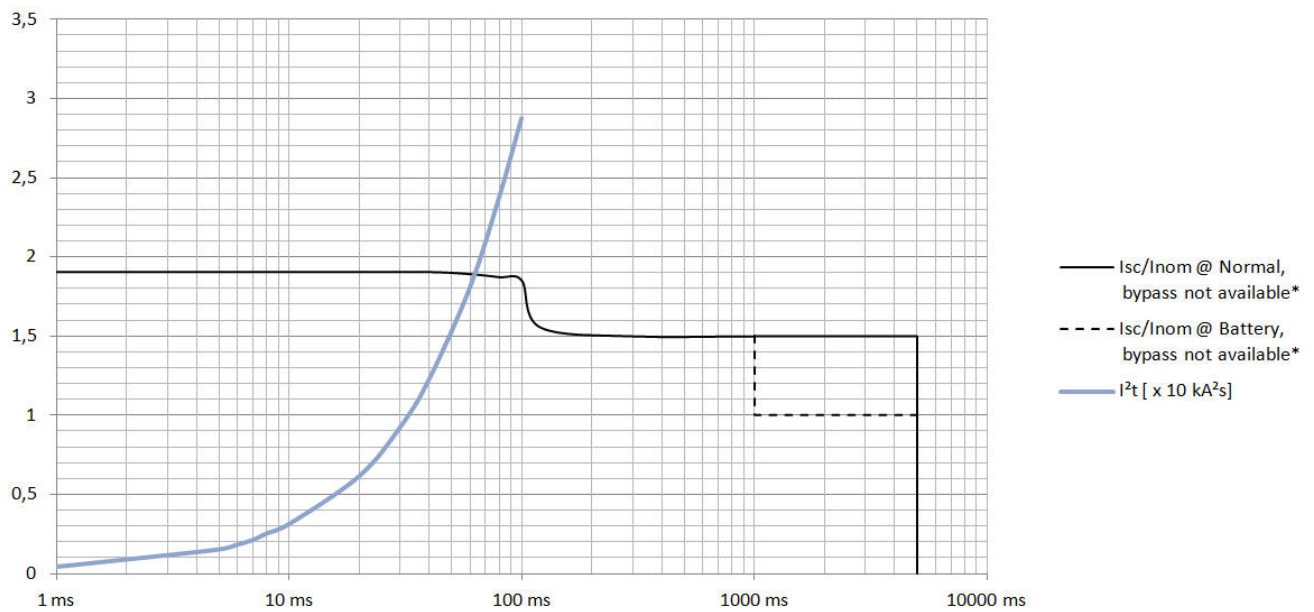

* I_{sc} = Inverter short-circuit current RMS, I_{nom} = Inverter nominal current RMS

Efficiency

Efficiency in Normal Operation

The table below provides average system efficiencies with a balanced linear load, and a power factor of 0.9.

	160 kVA				200 kVA			
	380 V	400 V	415	440	380 V	400 V	415	440
25% load	95.7	95.7	95.7	95.7	95.8	95.9	95.8	95.8
50% load	96.3	96.4	96.5	96.4	96.3	96.4	96.5	96.4
75% load	96.1	96.3	96.3	96.4	96.0	96.2	96.4	96.4
100% load	95.7	95.9	96.1	96.2	95.6	95.7	96.0	96.2

Efficiency in EConversion Mode

	160 kVA				200 kVA			
	380 V	400 V	415	440	380 V	400 V	415	440
25% load	97.5	97.3	97.3	97.2	97.7	97.6	97.6	97.5
50% load	98.6	98.5	98.5	98.4	98.7	98.6	98.6	98.6
75% load	98.9	98.9	98.8	98.8	99.0	99.0	99.0	98.9
100% load	99.0	99.0	99.0	99.0	99.0	99.0	99.0	99.0

Efficiency in ECO Mode

	160 kVA				200 kVA			
	380 V	400 V	415	440	380 V	400 V	415	440
25% load	98.2	98.3	98.3	98.3	98.6	98.6	98.6	98.5
50% load	99.0	98.9	99.0	99.0	99.1	99.1	99.1	99.1
75% load	99.1	99.2	99.2	99.3	99.2	99.2	99.3	99.3
100% load	99.2	99.3	99.3	99.3	99.2	99.3	99.3	99.4

Efficiency in Battery Operation

	160 kVA				200 kVA			
	380 V	400 V	415	440	380 V	400 V	415	440
25% load	96.8	96.8	96.8	96.8	96.8	96.8	96.8	96.8
50% load	96.5	96.5	96.5	96.5	96.5	96.5	96.5	96.5
75% load	96.4	96.4	96.4	96.4	96.4	96.4	96.4	96.4
100% load	96.0	96.0	96.0	96.0	96.0	96.0	96.0	96.0

Efficiency Curves Normal Operation at 400 V

160 kVA

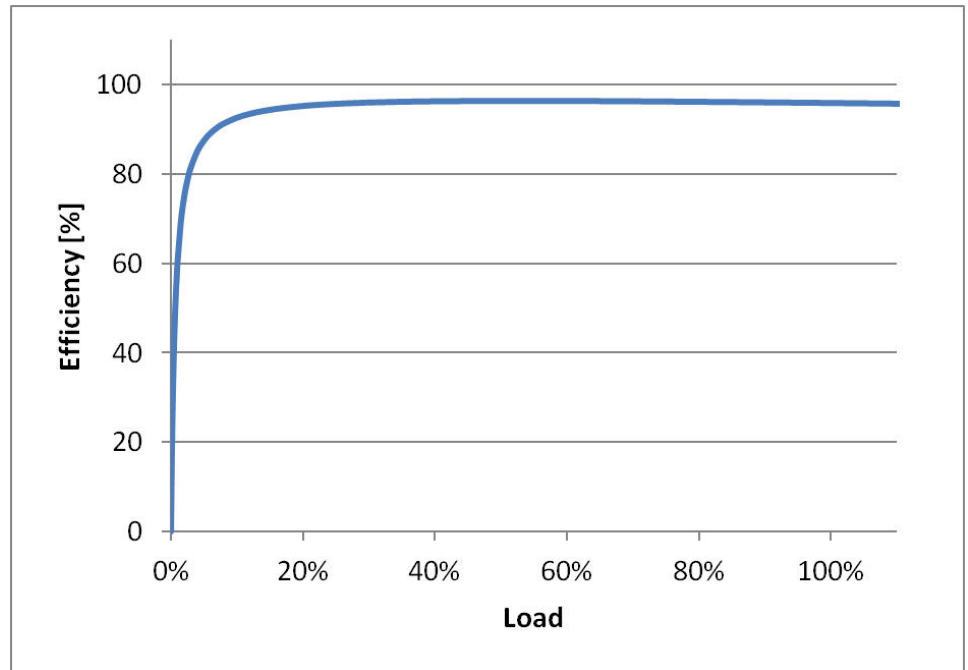

200 kVA

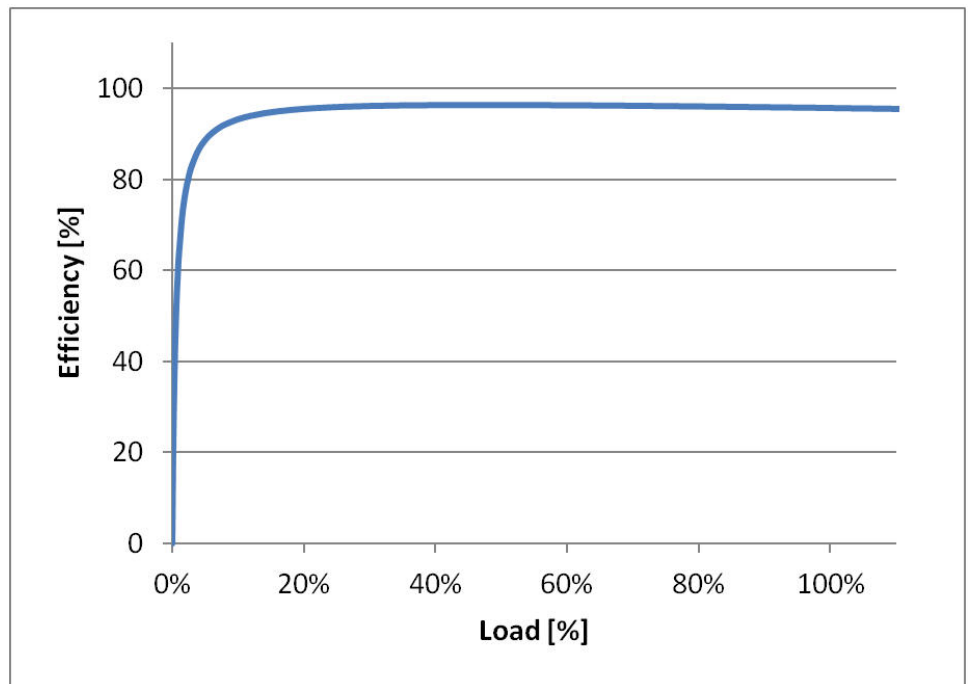

Batteries

Modular Battery Specifications

Battery	Capacity	Type	Recommended Operating Temperature	Life	Block Quantity
PXL12090	C20: 9 Ah	VRLA	25 °C +/- 3 °C	5 years	40 blocks/string ¹
HRL 1234W F2FR	C20: 9 Ah ²	VRLA	25 °C +/- 3 °C	8 years	40 blocks/string ¹

Typical Battery Runtimes

NOTE: The battery runtimes are intended as a guide only.

Typical Battery Runtimes in Minutes for Systems with Modular Battery Cabinets

Modular Battery Cabinets	Number of Battery Modules	160 kVA	200 kVA
(1) GVMMODBCW	9	5.6	NA
	10	6.7	NA
	11	7.8	5.4
	12	8.8	6.2
(1) GVMMODBCW (1) GVMMODBCN	13	9.9	7.1
	14	11	7.9
	15	12	8.8
	16	13	9.7
	17	14.5	10.5
	18	15.5	11.5
(2) GVMMODBCW	24	22.5	17
(2) GVMMODBCW (1) GVMMODBCN	30	30	22.5
(3) GVMMODBCW	36	38	28.5
(3) GVMMODBCW (1) GVMMODBCN	42	46	34.5
(4) GVMMODBCW	48	54	41
(4) GVMMODBCW (1) GVMMODBCN	54	62.5	47.5
(5) GVMMODBCW	60	71	54
(5) GVMMODBCW (1) GVMMODBCN	66	79.5	60.5
(6) GVMMODBCW	72	88.5	67.5
(6) GVMMODBCW (1) GVMMODBCN	78	97.5	74
(7) GVMMODBCW	84	105	81
(7) GVMMODBCW (1) GVMMODBCN	90	115	88
(8) GVMMODBCW	96	125	95.5

1. Narrow modular battery cabinets can contain 6 parallel strings and wide modular battery cabinets can contain 12 parallel strings
2. 34 W - approximately 9 Ah

End of Discharge Voltage

The voltage is 1.6 to 1.75 per cell depending on discharge ratio.

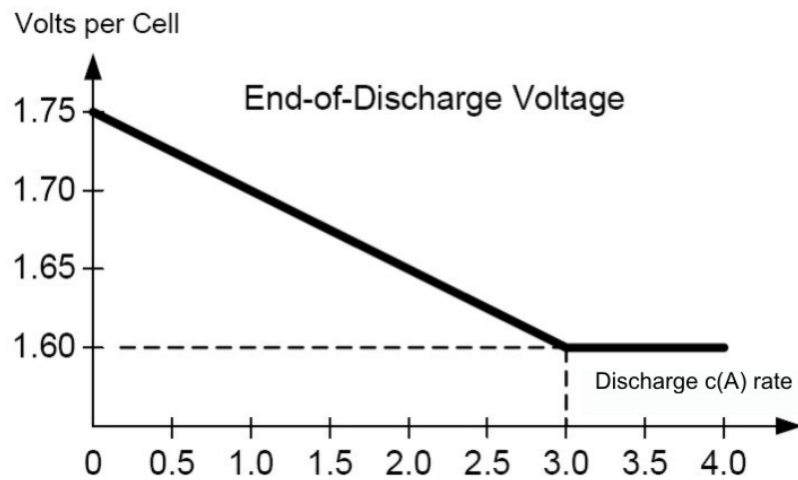

Battery Voltage Range

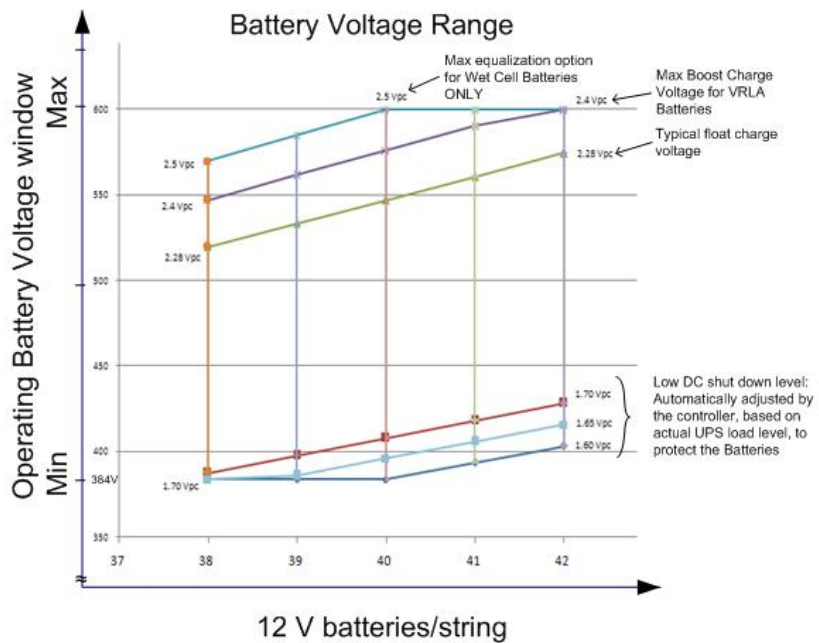

Derating Due to Load Power Factor

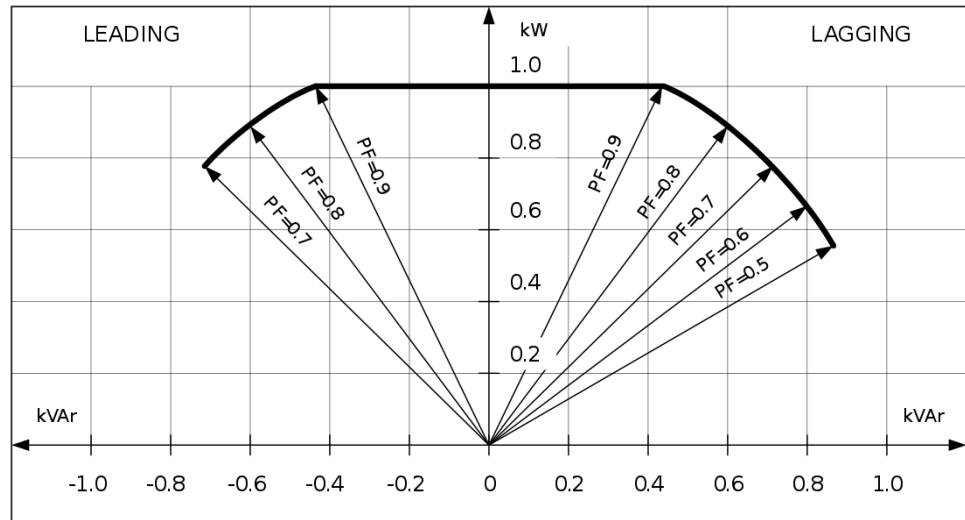

Battery Gassing Rates for Modular Battery Cabinets

Gassing Rate	Single Cartridge	Single Shelf Narrow Modular Battery Cabinet (2 Cartridges)	Single Shelf Wide Modular Battery Cabinet (4 Cartridges)
Typical cc/hr (ml/hr)	18 (18)	36 (36)	73 (73)
Maximum cc/hr (ml/hr)	59 (59)	119 (119)	238 (238)

Electrolyte Values for Modular Battery Cabinets

	Single Cartridge	Single Shelf Narrow Modular Battery Cabinet (2 Cartridges)	Single Shelf Wide Modular Battery Cabinet (4 Cartridges)
Electrolyte Volume L (gal)	3.66 (0.967)	7.32 (1.93)	14.6 (3.86)
Electrolyte Weight kg (lbs)	4.89 (10.08)	9.78 (21.5)	19.6 (43.1)
Sulfuric Acid Weight kg (lbs)	2.13 (4.69)	4.26 (9.38)	8.52 (18.8)

Compliance

Safety	IEC 62040-1: 2008-06, 1st edition Uninterruptible Power Systems (UPS) - Part 1: General and safety requirements for UPS IEC 62040-1: 2013-01, 1st edition amendment 1
EMC/EMI/RFI	IEC 62040-2: 2016, 3rd edition Uninterruptible Power Systems (UPS) - Part 2: Electromagnetic compatibility (EMC) requirements
Performance	IEC 62040-3: 2011-03, 2nd edition Uninterruptible Power Systems (UPS) - Part 3: Method of specifying the performance and test requirements
Environmental	IEC 62040-4: 2013-04, 1st edition Uninterruptible Power Systems (UPS) - Part 4: Environmental aspects – Requirements and reporting
Markings	CE, C-Tick
Transportation	ISTA 2B
Seismic	OSHPD, IBC2012 and CBC2013 to Sds=2.02g

Communication and Management

Local Area Network	100 Mbps
Extensions	2 x Rhodes 2 NMC Cards (optional)
MODBUS	MODBUS (SCADA & ION-E)
Relay Outputs	12 of which 6 are configurable
Dry Contact Inputs	12 of which 6 are configurable
Standard Control Panel	7" Touch Screen Display
Audible alarm	Yes
Emergency Power Off (EPO)	Options: <ul style="list-style-type: none"> • Normally Open • Normally Closed • External 24 VDC SELV
External switchgear	Yes
External Synchronization	Yes all 3 phases
Transformer compensation	Yes
Battery Monitoring	Available for modular battery cabinets

Overview of Input Contacts and Output Relays

Input Contacts

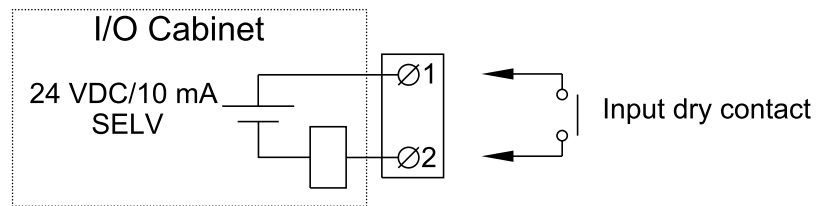

Name	Description	Location
IN 1 (Contact 1)	Configurable input contact	640-3640 terminal J5502
IN 2 (Contact 2)	Configurable input contact	640-3640 terminal J5503
IN 3 (Contact 3)	Configurable input contact	640-3640 terminal J5504
IN 4 (Contact 4)	Configurable input contact	640-3640 terminal J5505
IN 5 (Contact 5)	Configurable input contact	640-3640 terminal J5510
IN 6 (Contact 6)	Configurable input contact	640-3640 terminal J5509
IN 7	Transformer temperature switch	640-3640 terminal J5508
IN 9	Forced external synchronization input	640-3640 terminal J5506
IN 10	External synchronization requested input	640-3640 terminal J5511
IN 11	Use static bypass standby	640-3640 terminal J5512

Output Relays

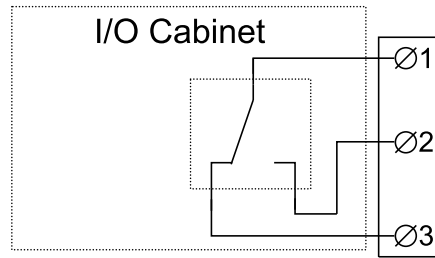

Output relay connection

Max 5 A/250 VAC

Max 5 A/24 VDC

Name	Description	Location
OUT 1 (Relay 1)	Configurable output relay	640–3635 terminal J4939
OUT 2 (Relay 2)	Configurable output relay	640–3635 terminal J4940
OUT 3 (Relay 3)	Configurable output relay	640–3635 terminal J4941
OUT 4	Forced external synchronization output	640–3640 terminal J5520
OUT 5	Reserved for future use	640–3640 terminal J5521
OUT 6	External synchronization requested output	640–3640 terminal J5522
OUT 7	UPS in inverter ON	640–3640 terminal J5523
OUT 8 (Relay 4)	Configurable output relay	640–3640 terminal J5524
OUT 9 (Relay 5)	Configurable output relay	640–3640 terminal J5525
OUT 10 (Relay 6)	Configurable output relay	640–3640 terminal J5528

EPO Connections

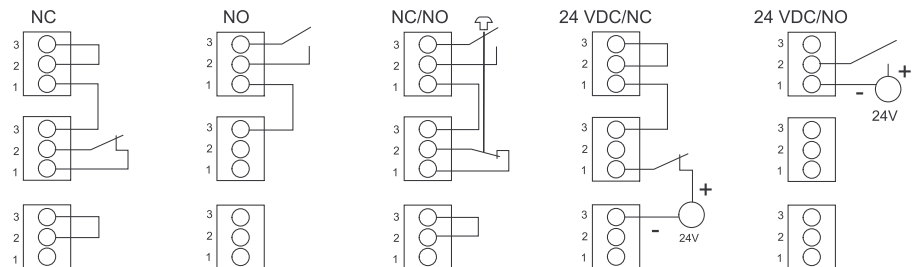

Facility Planning

Input Specifications

	160 kVA				200 kVA			
Input Voltage (V)	380	400	415	440	380	400	415	440
Connections	4-wire (L1, L2, L3, PE)							
Voltage range (V)	320–600 ³							
Frequency range (Hz)	40 - 70							
Nominal input current (A)	230	219	211	199	288	273	263	250
Maximum input current (A)	278	262	253	238	345	328	316	298
Input current limitation (A)	278				347			
Input power factor	> 0.99 at load > 40% > 0.97 at load > 25%							
Total harmonic distortion (THDI)	<3% at 100% load <4% at 50% load <6% at 25% load							
Maximum input short-circuit withstand (kA) I _{cc}	Rated conditional short-circuit current I _{cc} : 65 kA Rated peak withstand current I _{pk} : I _{cc} x 2.2 Device: Refer to Required Upstream Breakers, page 26							
Protection	Built-in backfeed contactor							
Ramp-in	Adaptive 1 - 40 sec							

Bypass Specifications

NOTE: Bypass is inoperable when the system is configured as a frequency converter.

	160 kVA				200 kVA			
Bypass Voltage (V)	380	400	415	440	380	400	415	440
Connections	5-wire (L1, L2, L3, N, PE) 4-wire (L1, L2, L3, PE)							
Voltage range (V)	342–457							
Frequency (Hz)	50 or 60							
Frequency range (Hz)	Programmable: +/-0.1, +/-3, +/-10. Default is +/-3.							
Nominal bypass current (A)	243	231	223	210	304	289	278	262
Thyristor I ² t (kA*s ²)	305.8 ⁴							
Protection	Built-in backfeed contactor							

3. The system can operate at 600 V for 1 minute.
4. If this value is exceeded, the thyristors can short.

Output Specifications

	160 kVA				200 kVA			
Output Voltage (V)	380	400	415	440	380	400	415	440
Connections	5-wire (L1, L2, L3, N, PE) 4-wire (L1, L2, L3, PE)							
Overload capacity ⁵	150% for 1 minute (normal operation) at 40 °C 125% for 10 minutes (normal operation) at 40 °C 150% for 1 second (battery operation) at 40 °C 125% for 1 minute (battery operation) at 40 °C 1000% for 100 ms (bypass operation) at 40 °C							
Output voltage tolerance	Symmetric load (0–100%): +/- 1% static +/- 5% after 2 ms +/- 1% after 50 ms							
Output power factor	0.9							
Nominal output current (A)	243	231	223	210	304	289	278	263
Total harmonic distortion (THDU)	<2% at 100% linear load <3% at 100% non-linear load							
Output frequency (Hz)	50/60 (sync to bypass) 50/60 Hz +/-0.1% (free-running)							
Slew rate (Hz/sec)	Programmable: 0.25, 0.5, 1, 2, 4, 6							
Output performance classification (according to IEC/EN62040-3)	Double-conversion: VFI-SS-111							
Load crest factor	Up to 3 (THDU < 5%)							
Load power factor	0.7 leading to 0.5 lagging without derating							

Battery Specifications

	160 kVA	200 kVA
Connections	DC+, DC-, PE	
Charging power in % of output power	40% charge ≤ 80% load 20% charge ≤ 100% load	
Nominal battery voltage (VDC)	480	
Nominal float voltage (VDC)	545	
End of discharge voltage (full load) (VDC)	384	
End of discharge voltage (no load) (VDC)	420	
Battery current at full load and nominal battery voltage (A)	314	393
Battery current at full load and minimum battery voltage (A)	393	491
Recharge time to 90% charge	< 20 hours for a 4 hour battery bank	
Temperature compensation	-3.3 mV per °C for T ≥ 25 °C 0 mV per °C for T < 25 °C	
Ripple current	< 5% C20 (5 minutes backup time)	
Battery test	Programmable: Manual/automatic	
Deep discharge protection	Yes	

5. Overload capabilities are not available when the system is configured as a frequency converter

	160 kVA	200 kVA
Recharge according to battery temperature	Yes	
Cold start	Yes	

Requirements for a Third Party Battery Solution

Battery breaker boxes from Schneider Electric are recommended for the battery interface. Please contact Schneider Electric for more information.

NOTE: The battery breaker box is not covered by the DNV type approval.

Guidance for Organizing Battery Cables

NOTE: For 3rd party batteries, use only high rate batteries for UPS applications.

NOTE: When the battery bank is placed remotely, the organizing of the cables is important to reduce voltage drop and inductance. The distance between the battery bank and the UPS must not exceed 200 m (656 ft). Contact Schneider Electric for installations with a longer distance.

NOTE: To minimize the risk of electromagnetic radiation, it is highly recommended to follow the below guidance and to use grounded metallic tray supports.

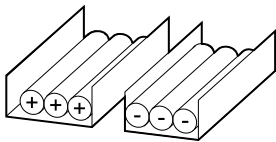
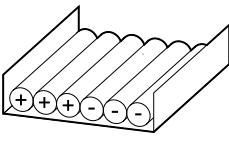
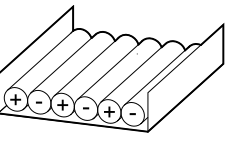
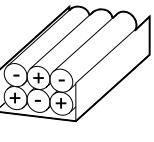
Cable Length				
<30 m	Not recommended	Acceptable	Recommended	Recommended
31–75 m	Not recommended	Not recommended	Acceptable	Recommended
76–150 m	Not recommended	Not recommended	Acceptable	Recommended
151–200 m	Not recommended	Not recommended	Not recommended	Recommended

Recommended Cable Sizes

Cable sizes in this manual are based on table 52–C2 of IEC 60364–5–52 with the following assertions:

- 90 °C conductors
- An ambient temperature of 30 °C
- Use of copper conductors

If the ambient temperature is greater than 30 °C, larger conductors are to be selected in accordance with the correction factors of the IEC.

160 kVA System

Installation Method	B1 (mm) ²	B2 (mm) ²	C (mm) ²
Input	2 x 70 mm ²	2 x 95 mm ²	2 x 50 mm ²
Bypass	2 x 70 mm ²	2 x 70 mm ²	1 x 95 mm ²
Output	2 x 70 mm ²	2 x 70 mm ²	1 x 95 mm ²
Battery	2 x 70 mm ²	3 x 70 mm ²	2 x 70 mm ²

200 kVA System

Installation Method	B1 (mm) ²	B2 (mm) ²	C (mm) ²
Input	2 x 95 mm ²	2 x 120 mm ²	2 x 70 mm ²
Bypass	2 x 70 mm ²	2 x 95 mm ²	1 x 120 mm ²
Output	2 x 70 mm ²	2 x 95 mm ²	1 x 120 mm ²
Battery	2 x 120 mm ²	3 x 95 mm ²	2 x 95 mm ²

Required Upstream Breakers

⚠ DANGER

HAZARD OF ELECTRIC SHOCK, EXPLOSION OR ARC FLASH

The specified upstream breakers below are required to obtain the conditional short-circuit current rating, I_{cc} at 65 kA symmetrical rms.

Failure to follow these instructions will result in death or serious injury.

	160 kVA		200 kVA	
	Input	Bypass ⁶	Input	Bypass ⁶
Breaker	NSX400H Mic2.3	NSX400H Mic2.3	NSX400H Mic2.3	NSX400H Mic2.3
Rating (A)	400	400	400	400
I _o (A)	280	250	360	320
I _r (x I _o)	1	1	1	1
I _{sd} (X I _r)	1.5–10	8	1.5–10	8

Torque Specifications

Bolt size	Torque
M4	1.7 Nm (1.25 lb-ft)
M5	2.5 Nm (1.84 lb-ft)
M6	5 Nm (3.69 lb-ft)
M8	17.5 Nm (12.91 lb-ft)
M10	30 Nm (22 lb-ft)
M12	50 Nm (36.87 lb-ft)
M14	75 Nm (55.31 lb-ft)

6. Only applicable to dual mains systems.

Physical

Weights and Dimensions

UPS Weights and Dimensions

	Weight kg	Height mm	Width mm	Depth mm
160 kVA UPS (GVMSB160KHS) Power cabinet I/O cabinet	469 230	1970	1052	854
200 kVA UPS (GVMSB200KHS) Power cabinet I/O cabinet	494 230	1970	1052	854
160 kVA parallel UPS (GVMPB160KHS) Power cabinet I/O cabinet	469 230	1970	1052	854
200 kVA parallel UPS (GVMPB200KHS) Power cabinet I/O cabinet	494 230	1970	1052	854

Modular Battery Cabinet Weights and Dimensions

	Weight kg	Height mm	Width mm	Depth mm
Modular battery cabinet wide up to 12 battery module strings (GVMMODBCW)	210 ⁷	1970	700	854
Modular battery cabinet narrow up to 6 battery module strings (GVMMODBCN)	139 ⁷	1970	370	854

Classic Battery Cabinet Weights and Dimensions

	Weight kg	Height mm	Width mm	Depth mm
Classic battery cabinet (GVMCBCABWEL)	175	1970	1100	854

Battery Breaker Box Weights and Dimensions

	Weight kg	Height mm	Width mm	Depth mm
Battery breaker box 630 A (GVMBBB630EL)	40	810	511	291

System Bypass Cabinet Weights and Dimensions

	Weight kg	Height mm	Width mm	Depth mm
System bypass cabinet (GVMSBC640KHEL)	328	1970	712	859

7. The weight is without batteries. Each battery module (GVMMBTU) weights 4 x 30 kg

Shipping Weights and Dimensions

UPS Shipping Weights and Dimensions

	Weight kg	Height mm	Width mm	Depth mm
160 kVA UPS (GVMSB160KHS) Power cabinet I/O cabinet	484.5 260	2156 2150	740 750	1052 1060
200 kVA UPS (GVMSB200KHS) Power cabinet I/O cabinet	510 260	2156 2150	740 750	1052 1060
160 kVA parallel UPS (GVMPB160KHS) Power cabinet I/O cabinet	484.5 260	2156 2150	740 750	1052 1060
200 kVA parallel UPS (GVMPB200KHS) Power cabinet I/O cabinet	510 260	2156 2150	740 750	1052 1060

Modular Battery Cabinet Shipping Weights and Dimensions

	Weight kg	Height mm	Width mm	Depth mm
Modular battery cabinet wide up to 12 battery module strings (GVMMODBCW) ⁸	252	2150	990	1060
Modular battery cabinet narrow up to 6 battery module strings (GVMMODBCN) ⁸	164	2150	750	1060

System Bypass Cabinet Shipping Weights and Dimensions

	Weight kg	Height mm	Width mm	Depth mm
System bypass cabinet (GVMSBC640KHEL)	425	2250	1030	1170

Battery Breaker Box Shipping Weights and Dimensions

	Weight kg	Height mm	Width mm	Depth mm
Battery breaker box 630 A (GVMBBB630EL)	45	820	520	300

Kits Shipping Weights and Dimensions

	Weight kg	Height mm	Width mm	Depth mm
630 A battery breaker kit (GVMBBK630IEC)	10.7	262	377	766
800 A fuse kit (GVMFU800WW)	3.5	127	396	241
Cable kit 0N-9272	2.5	132	396	396
Cable kit 0N-9255	11.5	212	396	396
Cable kit 0N-9281	20.5	282	396	396

8. The weight is without batteries. Each battery module string (GVMMBTU) weights 4 x 31.5 kg

Clearance

NOTE: Clearance dimensions are published for airflow and service access only. Consult with the local safety codes and standards for additional requirements in your local area.

NOTE: The UPS system can be placed up against the wall and there is no requirement for rear or side access.

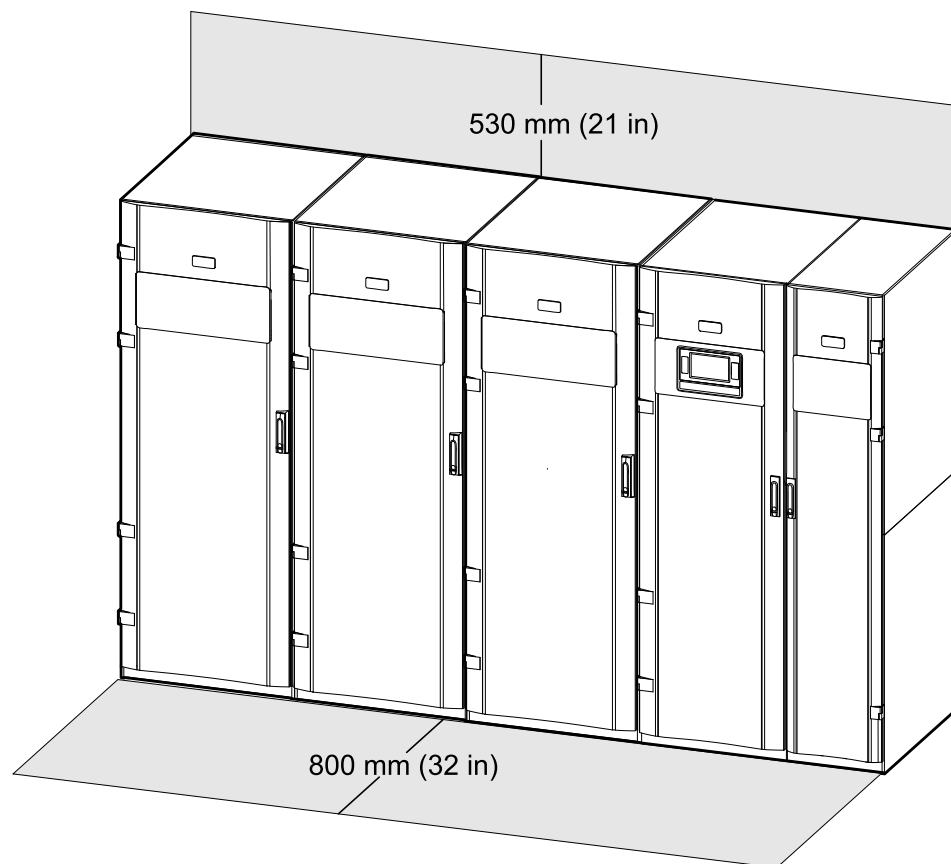

Environment

⚠ DANGER

HAZARD OF ELECTRIC SHOCK, EXPLOSION OR ARC FLASH

- Install the UPS system in a temperature controlled environment free of conductive contaminants and humidity.
- Install the UPS system on a non-flammable, level and solid surface (e.g. concrete) that can support the weight of the system.
- No responsibility is assumed by Schneider Electric if these requirements are not respected.

Failure to follow these instructions will result in death or serious injury.

	Operation	Storage
Temperature	0 °C to 40 °C	-15 °C to 40 °C for systems with batteries -25 °C to 55 °C for systems without batteries
Relative humidity	0-95% non-condensing	0-95% non-condensing
Altitude derating according to IEC 62040-3	1000 m: 1.000 1500 m: 0.975 2000 m: 0.950 2500 m: 0.925 3000 m: 0.900	≤ 5000 m above sea-level (or in an environment with equivalent air pressure)
Audible noise (1 meter from surface)	55 dBA at 70% load and 40 °C 65 dBA at 100% load and 40 °C	
Protection class	IP20	
Color	RAL 9003 White	

Heat Dissipation

NOTE: The maximum air flow through the UPS at highest fan speed is 3600 m³/h.

Heat Dissipation for 160 kVA Systems

Operation Mode	Normal Operation		ECO Mode		ECOversion		Battery Operation	
	W	BTU/hr	W	BTU/hr	W	BTU/hr	W	BTU/hr
Heat dissipation at 100% load	6157	21006	1015	3464	1308	4462	6000	20472
Heat dissipation at 75% load	4149	14158	871	2972	1201	4099	4033	13761
Heat dissipation at 50% load	2689	9174	801	2732	1096	3741	2611	8910
Heat dissipation at 25% load	1618	5519	623	2124	999	3408	1190	4061

Heat Dissipation for 200 kVA Systems

Operation Mode	Normal Operation		ECO Mode		ECOversion		Battery Operation	
	W	BTU/hr	W	BTU/hr	W	BTU/hr	W	BTU/hr
Heat dissipation at 100% load	8088	27595	1269	4329	1818	6204	7500	25590
Heat dissipation at 75% load	5333	18195	1089	3715	1364	4653	5042	17202
Heat dissipation at 50% load	3361	11468	817	2789	1278	4360	3264	11138
Heat dissipation at 25% load	1924	6564	639	2180	1107	3776	1488	5076

Drawings

NOTE: A comprehensive set of drawings is available on www.se.com.

NOTE: These drawings are for reference ONLY – subject to change without notice.

Single System Single Mains with Modular Battery Cabinet

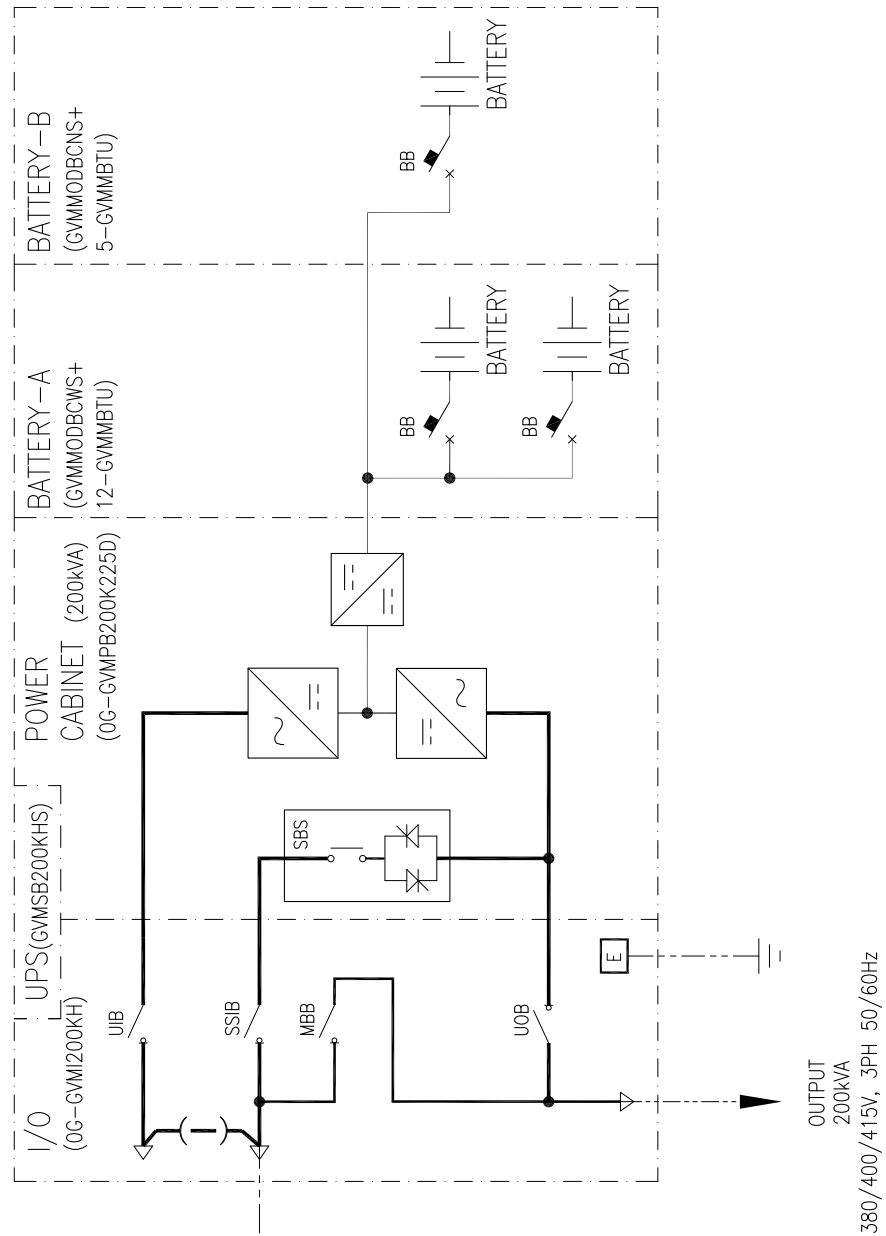

INPUT
 380/400/415V, 40-70HZ
 L1,L2,L3,PE OR
 L1,L2,L3,N,PE
 (PROVIDED BY OTHERS)

Single System Dual Mains with Modular Battery Cabinet

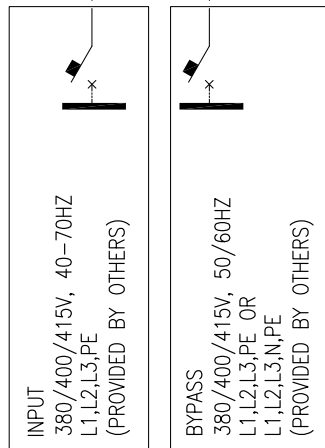
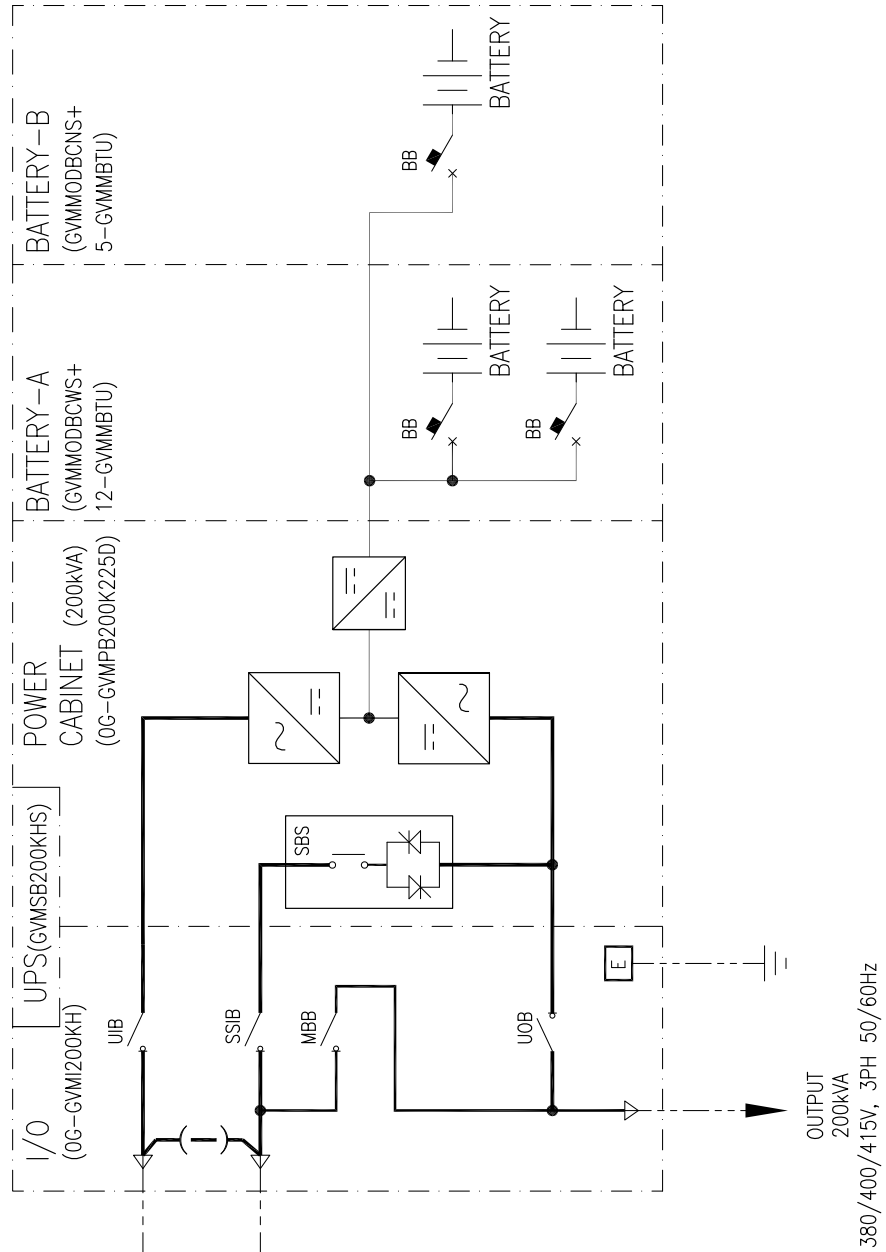

Options

Hardware Options

- Dust filters

Battery Options

- Modular battery cabinets
- Classic battery cabinet

Configuration Options

- Single or dual feed
- Top or bottom feed
- Bypass Connection: Built-in Static Bypass
- Frequency Converter

Limited Factory Warranty

One-Year Factory Warranty

The limited warranty provided by Schneider Electric in this Statement of Limited Factory Warranty applies only to products you purchase for your commercial or industrial use in the ordinary course of your business.

Terms of Warranty

Schneider Electric warrants that the product shall be free from defects in materials and workmanship for a period of one year from the date of product start-up when start-up is performed by Schneider Electric-authorized service personnel and occurs within six months of the Schneider Electric shipment date. This warranty covers repairing or replacing any defective parts including on-site labor and travel. In the event that the product fails to meet the foregoing warranty criteria, the warranty covers repairing or replacing defective parts at the sole discretion of Schneider Electric for a period of one year from the shipment date. For Schneider Electric cooling solutions, this warranty does not cover circuit breaker resetting, loss of refrigerant, consumables, or preventive maintenance items. Repair or replacement of a defective product or part thereof does not extend the original warranty period. Any parts furnished under this warranty may be new or factory-remanufactured.

Non-transferable Warranty

This warranty is extended to the first person, firm, association or corporation (herein referred to by "You" or "Your") for whom the Schneider Electric product specified herein has been purchased. This warranty is not transferable or assignable without the prior written permission of Schneider Electric.

Assignment of Warranties

Schneider Electric will assign you any warranties which are made by manufacturers and suppliers of components of the Schneider Electric product and which are assignable. Any such warranties are assigned "AS IS" and Schneider Electric makes no representation as to the effectiveness or extent of such warranties, assumes no responsibility for any matters which may be warranted by such manufacturers or suppliers and extends no coverage under this Warranty to such components.

Drawings, Descriptions

Schneider Electric warrants for the warranty period and on the terms of the warranty set forth herein that the Schneider Electric product will substantially conform to the descriptions contained in the Schneider Electric Official Published Specifications or any of the drawings certified and agreed to by contract with Schneider Electric if applicable thereto ("Specifications"). It is understood that the Specifications are not warranties of performance and not warranties of fitness for a particular purpose.

Exclusions

Schneider Electric shall not be liable under the warranty if its testing and examination disclose that the alleged defect in the product does not exist or was caused by end user or any third person misuse, negligence, improper installation or testing. Further, Schneider Electric shall not be liable under the warranty for unauthorized attempts to repair or modify wrong or inadequate electrical voltage or connection, inappropriate on-site operation conditions, corrosive atmosphere, repair, installation, start-up by non-Schneider Electric designated personnel, a change in location or operating use, exposure to the elements, Acts of God, fire, theft, or installation contrary to Schneider Electric recommendations or specifications or in any event if the Schneider Electric serial number has been altered, defaced, or removed, or any other cause beyond the range of the intended use.

THERE ARE NO WARRANTIES, EXPRESS OR IMPLIED, BY OPERATION OF LAW OR OTHERWISE, OF PRODUCTS SOLD, SERVICED OR FURNISHED UNDER THIS AGREEMENT OR IN CONNECTION HERewith. SCHNEIDER ELECTRIC DISCLAIMS ALL IMPLIED WARRANTIES OF MERCHANTABILITY, SATISFACTION AND FITNESS FOR A PARTICULAR PURPOSE. SCHNEIDER ELECTRIC EXPRESS WARRANTIES WILL NOT BE ENLARGED, DIMINISHED, OR AFFECTED BY AND NO OBLIGATION OR LIABILITY WILL ARISE OUT OF, SCHNEIDER ELECTRIC RENDERING OF TECHNICAL OR OTHER ADVICE OR SERVICE IN CONNECTION WITH THE PRODUCTS. THE FOREGOING WARRANTIES AND REMEDIES ARE EXCLUSIVE AND IN LIEU OF ALL OTHER WARRANTIES AND REMEDIES. THE WARRANTIES SET FORTH ABOVE CONSTITUTE SCHNEIDER ELECTRIC SOLE LIABILITY AND PURCHASER'S EXCLUSIVE REMEDY FOR ANY BREACH OF SUCH WARRANTIES. SCHNEIDER ELECTRIC WARRANTIES RUN ONLY TO PURCHASER AND ARE NOT EXTENDED TO ANY THIRD PARTIES.

IN NO EVENT SHALL SCHNEIDER ELECTRIC, ITS OFFICERS, DIRECTORS, AFFILIATES OR EMPLOYEES BE LIABLE FOR ANY FORM OF INDIRECT, SPECIAL, CONSEQUENTIAL OR PUNITIVE DAMAGES, ARISING OUT OF THE USE, SERVICE OR INSTALLATION, OF THE PRODUCTS, WHETHER SUCH DAMAGES ARISE IN CONTRACT OR TORT, IRRESPECTIVE OF FAULT, NEGLIGENCE OR STRICT LIABILITY OR WHETHER SCHNEIDER ELECTRIC HAS BEEN ADVISED IN ADVANCE OF THE POSSIBILITY OF SUCH DAMAGES, SPECIFICALLY, SCHNEIDER ELECTRIC IS NOT LIABLE FOR ANY COSTS, SUCH AS LOST PROFITS OR REVENUE, LOSS OF EQUIPMENT, LOSS OF USE OF EQUIPMENT, LOSS OF SOFTWARE, LOSS OF DATA, COSTS OF SUBSTITUANTS, CLAIMS BY THIRD PARTIES, OR OTHERWISE.

NO SALESMAN, EMPLOYEE OR AGENT OF SCHNEIDER ELECTRIC IS AUTHORIZED TO ADD TO OR VARY THE TERMS OF THIS WARRANTY. WARRANTY TERMS MAY BE MODIFIED, IF AT ALL, ONLY IN WRITING SIGNED BY AN SCHNEIDER ELECTRIC OFFICER AND LEGAL DEPARTMENT.

Warranty Claims

Customers with warranty claims issues may access the SCHNEIDER ELECTRIC worldwide customer support network through the SCHNEIDER ELECTRIC web site: <http://www.schneider-electric.com>. Select your country from the country selection pull-down menu. Open the Support tab at the top of the web page to obtain contact information for customer support in your region.

Schneider Electric
35 rue Joseph Monier
92500 Rueil Malmaison
France

+ 33 (0) 1 41 29 70 00



As standards, specifications, and design change from time to time,
please ask for confirmation of the information given in this publication.

© 2014 – 2021 Schneider Electric. All rights reserved.

990-5370J-001