

User Manual Easy UPS On-Line SRVPM3KRILX901

Important Safety Instructions

SAVE THESE INSTRUCTIONS - This manual contains important instructions that should be followed during installation and maintenance of the Easy UPS.



This is the “Read user manual” symbol. Read the user documentation to become familiar with the equipment.

Read these instructions carefully and look at the equipment to become familiar with the device before trying to install, operate it.



The addition of this symbol either to a “Danger” or “Warning” safety label indicates that an electrical hazard exists which will result in personal injury if the instructions are not followed.



This is the safety alert symbol. It is used to alert you to potential personal injury hazards. Obey all safety messages that follow this symbol to avoid possible injury or death.

DANGER

DANGER indicates a hazardous situation which, if not avoided, **will result in** death or serious injury.

WARNING

WARNING indicates a hazardous situation which, if not avoided, **can result in** death or serious injury.

CAUTION

CAUTION indicates a hazardous situation which, if not avoided, **can result in** minor or moderate injury.

NOTICE

NOTICE is used to address practices not related to physical injury.

Product Handling Guidelines



<18 kg
<40 lb



18-32 kg
40-70 lb



32-55 kg
70-120 lb



>55 kg
>120 lb



For Professional Business Applications – Not For Consumer Use

Safety and General Information

Inspect the package contents upon receipt. Notify the carrier and dealer if there is any damages.

- This UPS is for indoor use only.
- Do not operate this unit in direct sunlight, in contact with fluids, or where there is excessive dust or high humidity.
- Do not operate the UPS near open windows or doors.
- Be sure the air vents on the UPS are not blocked. Allow adequate space for proper ventilation.

NOTE: Allow a minimum of 20 cm clearance on all four sides of the UPS.

Battery safety

CAUTION

RISK OF HYDROGEN SULPHIDE GAS AND EXCESSIVE SMOKE

- Replace the battery at least every 5 years or at the end of its service life, whichever is earlier.
- Replace the battery immediately when the UPS indicates battery replacement is necessary.
- Replace batteries with the same number and type of batteries as originally installed in the equipment.
- Replace the battery immediately when the UPS indicates a battery over-temperature condition, or UPS internal over-temperature, or when there is evidence of electrolyte leakage. Power off the UPS, unplug it from the AC input, and disconnect the batteries. Do not operate the UPS until the batteries have been replaced.
- *Replace all battery modules (including the modules in External Battery Packs) which are older than one year, when installing additional battery packs or replacing the battery module(s).

Failure to follow these instructions can result in equipment damage and minor or moderate injury.

- Batteries typically last for two to five years. Environmental factors impact battery life. Elevated ambient temperatures, poor quality utility power, leading to frequent short duration discharges will shorten battery life. Batteries should be replaced before end of life.
- APC by Schneider Electric uses maintenance-free sealed lead-acid batteries. Under normal use and handling, there is no contact with the internal components of the batteries. Over charging, overheating, or other misuse of batteries can result in a discharge of battery electrolyte. Released electrolyte is toxic and may be harmful to the skin and eyes.
- Failed batteries can reach temperatures that exceed the burn thresholds for touchable surfaces.
- Servicing of batteries should be performed or supervised by personnel knowledgeable about batteries and required precautions. Keep unauthorized personnel away from batteries.
- **CAUTION:** Before installing or replacing the batteries, remove jewelry such as wristwatch and rings. High short circuit current through conductive materials could cause severe burns.
- **CAUTION:** Do not dispose of batteries in a fire. The batteries may explode.
- **CAUTION:** Do not open or mutilate batteries. Released material is harmful to the skin and eyes and may be toxic.
- **CAUTION:** A battery can present a risk of electrical shock and high short-circuit current. Contact with any part of a grounded battery can result in electrical shock. The following precautions should be observed when working on batteries:
 - Remove watches, rings, or other metal objects.
 - Use tools with insulated handles.
 - Wear rubber gloves and boots.
 - Do not lay tools or metal parts on top of batteries.
 - Disconnect charging source and load prior to installing or maintaining the battery.
 - Determine if battery is either intentionally or inadvertently grounded. Contact with any part of a grounded battery can result in electric shock and burns by high short-circuit current. The risk of such hazards can be reduced if grounds are removed during installation and maintenance by a skilled person.

Deenergizing safety

- The UPS may present a shock hazard even when disconnected from AC and DC power.
- The AC and DC connectors may be energized by remote or automatic control at any time.
- Before installing or servicing the equipment check that the:
 - Input circuit breaker is in the **OFF** position or the equipment is disconnected from the AC source.
 - Internal batteries and External battery packs are disconnected.

Electrical safety

- Connect the UPS power cable to a wall outlet. Do not use surge protectors or extension cords.
- Do not handle any metallic connectors before the power has been disconnected.
- When grounding cannot be verified, disconnect the equipment from the utility power outlet before installing or connecting to other equipment. Reconnect the power cord only after all connections are made.
- Connection to the branch circuit (mains) must be performed by a qualified electrician.
- The protective earth conductor for the UPS carries the leakage current from the load devices (computer equipment). An insulated ground conductor is to be installed as part of the branch circuit that supplies the UPS. The conductor must have the same size and insulation material as the grounded and ungrounded branch circuit supply conductors. The conductor will be green and with or without a yellow stripe.
- The UPS input ground conductor must be properly bonded to protective earth at the service panel.
- If the UPS input power is supplied by a separately derived system, the ground conductor must be properly bonded at the supply transformer or motor generator set.
- The length of the output cable should not exceed 10 m.
- Leakage current for a pluggable, Type A UPS may exceed 3.5 mA when a separate ground terminal is used.

General information

- Always recycle used batteries.
- Recycle the packaging materials or save them for reuse.
- Select a location sturdy enough for the combined weight of the units.
- Operate the UPS within the specified environmental limits.
- Be sure to deliver the used battery to a recycling facility or ship it to Schneider Electric in the replacement battery packing material.
- The model and serial numbers are located on a small label, top cover, and rear panel.

Radio Frequency Warning



This is a category C2 UPS product. In a residential environment, this product may cause radio interference, in which case the user may be required to take additional measures.

Product Description

The APC by Schneider Electric Easy UPS is a high performance, uninterruptible power supply (UPS). The UPS helps to provide protection for electronic equipment from utility power blackouts, brownouts, sags, and surges and small utility fluctuations and large disturbances. The UPS also provides battery backup power for connected equipment until utility power returns to normal levels or the batteries are fully discharged.

This user manual is available on the APC by Schneider Electric Web site, www.apc.com.

Package Contents

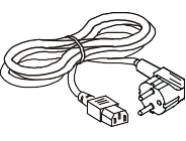
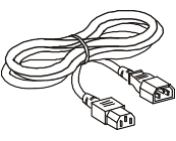
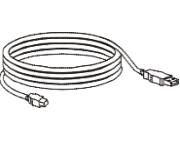
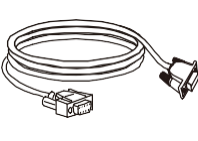
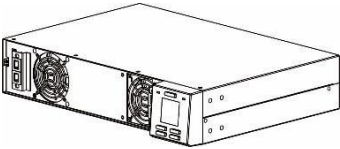
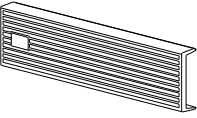
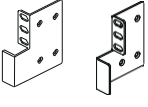
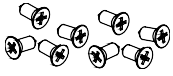
 (1) User manual	 (1) PowerChute™ software download guide	 (1) Utility power cable	 (1) Output cable	 (1) USB cable	 (1) RS-232 cable
 (1) UPS		 (1) Front bezel	 (2) Rack-mount bracket	 (8) Flat head screws	

Optional Accessories

For optional accessories, refer to the APC by Schneider Electric Web site at www.apc.com.

Specifications

For additional specifications refer to the APC by Schneider Electric web site, www.apc.com.

Environment Specifications

NOTICE

RISK OF EQUIPMENT DAMAGE

- UPS must be used indoors only.
- The installation location should be sturdy to withstand the weight of the UPS.
- Do not operate UPS where there is excessive dust or where the temperature or humidity are outside specified limits.

Failure to follow these instructions can result in equipment damage.

Temperature	Operating	0 to 40 °C at rated load 40 to 50 °C with derated load
	Storage	-20 to 60 °C
Elevation	Operating	0 - 3,000 m: normal operation
	Storage	0 - 3,000 m
Pollution Degree		2
Humidity		0 to 95% relative humidity, non-condensing
International Protection Code		IP20

Physical Specifications

UPS model	SRVPM3KRILX901
Dimensions with package Width x Height x Depth	545 mm x 240 mm x 700 mm (22.46 in x 9.44 in x 27.57 in)
Dimensions without package Width x Height x Depth	438 mm x 86 mm x 462 mm (17.24 in x 3.4 in x 18.2 in) D1 = 430 mm (16.9 in), D2 = 522 mm (20.6 in)
Weight with package (Approx.)	14.3 kg (31.52 lbs)
Weight without package(Approx.)	11.2 kg (24.69 lbs)

*Details of D1 and D2

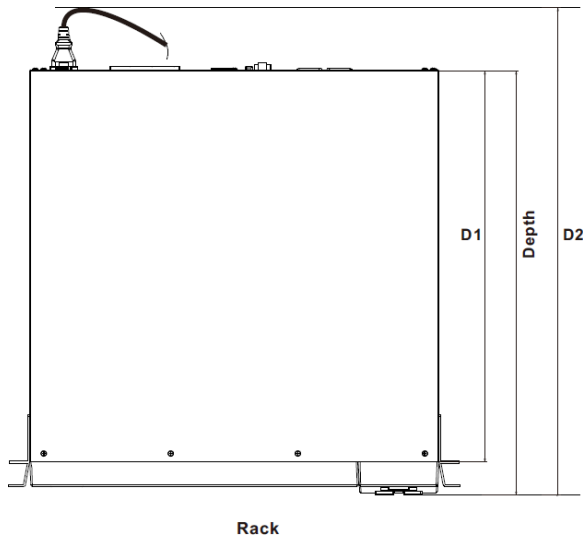

D1 Dimension	D2 Dimension	Depth
430 mm (16.9 in)	522 mm (20.6 in)	462 mm (18.2 in)

Electrical Specifications

NOTICE

RISK OF DAMAGE

Do not use this UPS for a two-phase (Line to Line) input configuration. The UPS needs a neutral connection to work properly. Operation without neutral may damage the unit or connected load.

Failure to follow these instructions can result in equipment damage.

CAUTION: To reduce the risk of fire, connect only to a circuit provided with recommended maximum branch circuit overcurrent protection in accordance with the National Electrical Code, ANSI/NFPA 70 and the Canadian Electrical Code, Part I, C22.1., for North America, IEC/EN 60934 for Europe, 208 V single phase without N in North American, recommended Double - Pole branch circuit over current protection.

Power Module Model	SRVPM3KRILX901	
Input	Voltage	230 VAC Nominal
	Branch Circuit Overcurrent Rating/ Building Circuit Breaker (CB) Current Rating	240 VAC, 20 A
	Frequency	40 – 70 Hz
	Input Voltage Range (100% load)	180 VAC – 285 VAC
	Input Voltage Range (40% load)	110 VAC – 285 VAC
	Input Power Factor (100% resistive load)	≥ 0.95
	Inlet	IEC C20
	Input Power Cord	SCHUKO plug to IEC C19, 1.8 meters
	Input Protection – Circuit Breaker	25 A
Output	UPS Capacity	3 kVA / 2.7 kW @ 220 VAC – 240 VAC 2.1 kVA / 1.89 kW @ 208 VAC
	Nominal Output Voltage	230 VAC
	Other Programmable Voltage	208 VAC*, 220 VAC, 230 VAC, 240 VAC
	External Output Circuit Breaker Current Rating for C13 Receptacles	Europe: NA, NAM: 15 A, UL listed, 2 pole
	Efficiency at rated load	90%
	Output Voltage Regulation	± 1% static
	Output Voltage Distortion	<ul style="list-style-type: none"> • 3% max. for full linear load, • 6% max. for full non-linear load
	Frequency – On Battery	50 ± 0.1 Hz or 60 ± 0.1 Hz
	Frequency – AC Mode	50 ± 3 Hz or 60 ± 3 Hz
	Crest Factor	3:1
	Waveform	Sinewave
	Output Connection	Refer to rear panel features in page 7 & page 8
	Output Power Cord	IEC C13 to C14, 1.5 meters
Bypass	Voltage range 184 VAC to 253 VAC	

NOTE: Selecting 208 Vac output will be derated to 70% of normal capacity.

Battery

Power Module	SRVPM3KRILX901
Battery Pack Model	SRV72RLBPX901
Configuration	External battery
Type	Sealed maintenance free (SMF)
Battery Typical capacity	12 V / 18 Ah
Battery Bank Voltage	72 V
Minimum Battery Bank Capacity	18 Ah
Maximum Battery Bank Capacity	72 Ah
Nominal Voltage	72 V
Recommended Charge Voltage	81.6 V
Maximum Battery Pack Support	4

Front Panel Display

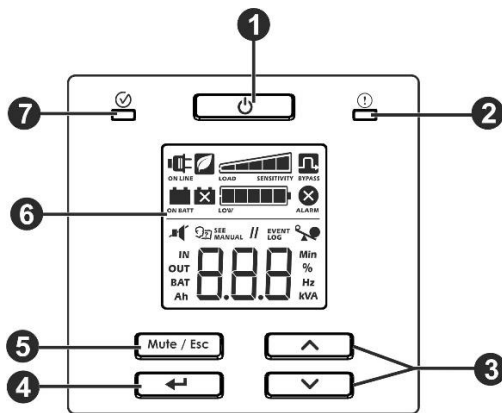

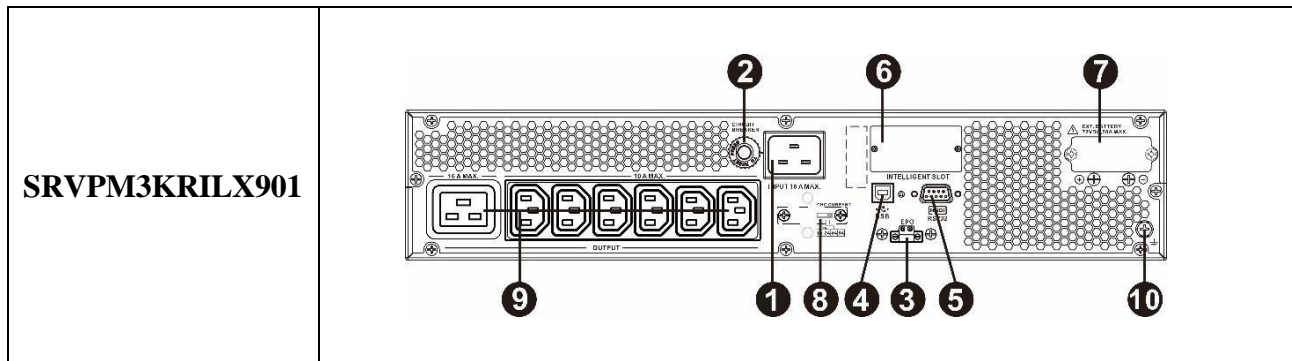

1	UPS POWER ON/OFF button
2	Alarm LED
3	UP/DOWN button
4	ENTER button
5	MUTE/ESC button
6	LCD Display
7	Status LED

Rear Panel Features

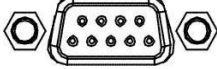

1	AC input	6	Intelligent card slot for management accessories
2	Input circuit breaker	7	Battery connector
3	Emergency Power Off (EPO)	8	Charger Current Select
4	USB port	9	Outlet Group
5	RS-232	10	Ground Screw

Basic Connectors

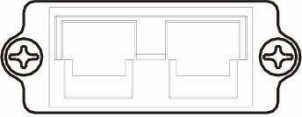
 <p>USB</p>	 <p>Serial port</p>	 <p>Intelligent card slot</p>	<p>Power management software and interface kits can be used with the UPS.</p> <p>Use only interface kits supplied or approved by Schneider Electric.</p>
 <p>Battery connector</p>			<p>This UPS is not equipped with an internal battery. Before turn on the UPS. Connect the battery by connecting a cable to an external battery.</p>

Start UP Settings

Connect the battery

- Connect UPS to the external battery pack with a battery cable. Refer to the following picture for connection.
- Connect the battery pack according to the battery voltage indicated on the rear panel. If the connected battery voltage is incorrect, UPS may be damaged and cannot be repaired. Therefore, be sure to confirm that the battery voltage is in accordance with the UPS specification.

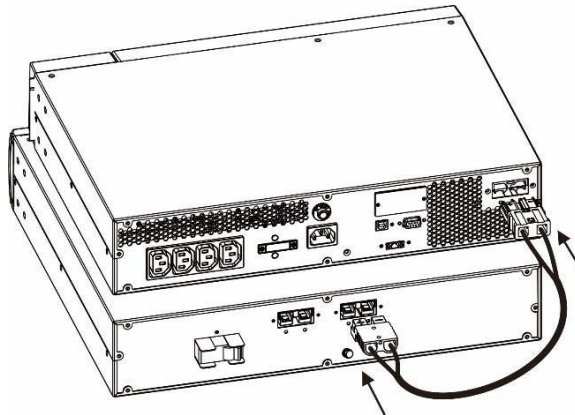

- Before turning on the UPS, check the charger current according to the battery capacity for external battery pack.

WARNING

RISK OF FIRE

Select the correct Charger Current for the number of battery packs connected to the Easy UPS.

Failure to follow these instructions can result in death or serious injury.

Number of battery packs connected to Easy UPS	1	2	3	4
Battery capacity	18 Ah	36 Ah	54 Ah	72 Ah
Charger current setting	2 A	4 A	6 A	6 A

NOTE: Factory default charger current setting is 2A.

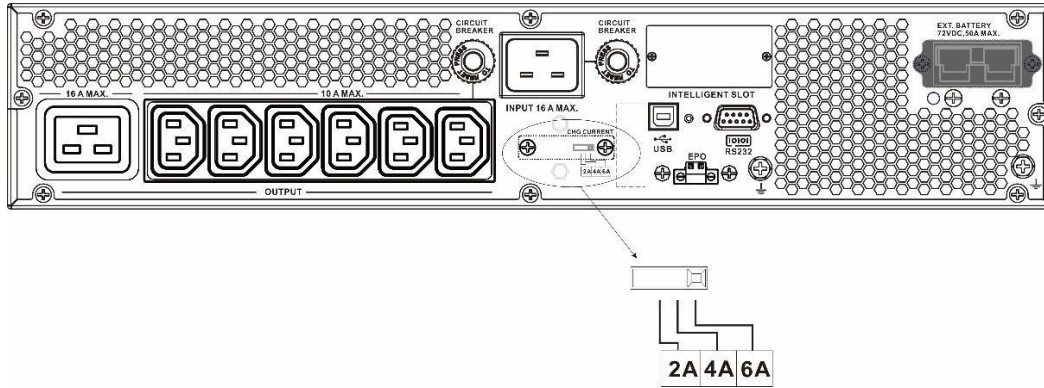

Rack-Mount Installation

⚠ CAUTION

RISK OF FALLING OBJECTS

- The equipment is heavy. Always practice safe lifting techniques adequate for the weight of the equipment.
- Always use the recommended number of screws to secure brackets to the UPS.
- Always use the recommended number of screws to secure the UPS to the rack.
- Always install the UPS at the bottom of the rack.
- Always install the External Battery Pack below the UPS in the rack.

Failure to follow these instructions can result in equipment damage and minor or moderate injury.

- Before installing the UPS and battery pack into the 19 inch rack enclosure, be sure that the rack is already equipped with a shelf.
- Be sure that the installed shelf can withstand the weight of the UPS and/or battery pack. Otherwise, install an optional rail kit accessory which can be purchased separately.

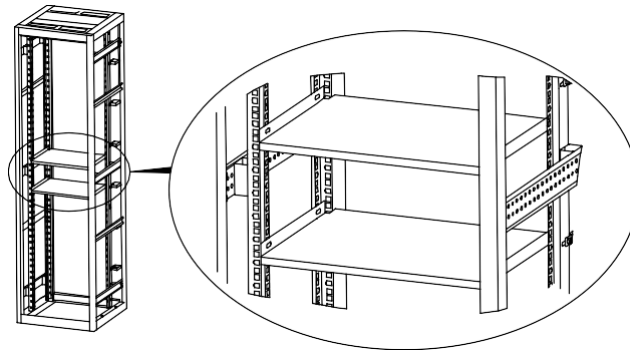

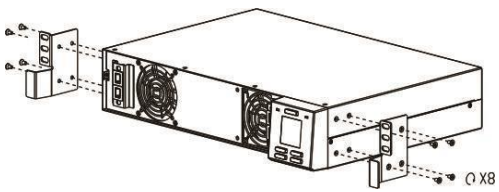
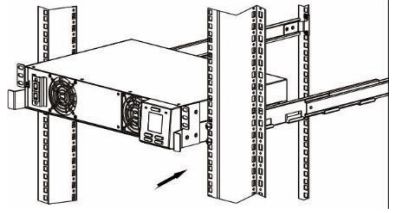
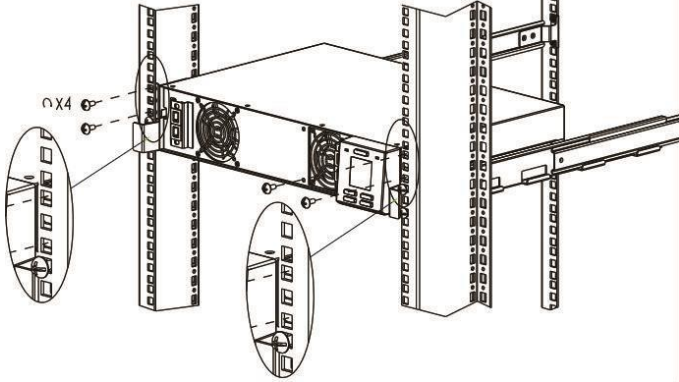
1	Install the rack-mount brackets. 	2 Lift the UPS module and slide it into rack enclosure. 
3	Secure the UPS module to the rack with screws, nuts and washers (not supplied). 	

Connect power and equipment to the UPS

CAUTION

RISK OF ELECTRIC SHOCK

- All electrical work must be performed by a qualified electrician.
- Turn off all power to this equipment before working on the equipment. Practice lockout/tagout procedures.
- Do not wear jewelry when working with electrical equipment.

Failure to follow these instructions can result in equipment damage and minor or moderate injury.

1. Connect load equipment to the UPS. Refer “Rear to Panel Features” on page 7 for details.
Connect load equipment either to the 10A or 16A battery backup outlets in the 3000 VA UPS. Do not use extension cords.
2. Connect input mains cord to the utility power socket and turn on the utility power switch.
3. The UPS display panel will illuminate when utility power is available.

Start the UPS

Press the POWER ON/OFF button located on the front panel of the UPS.

- The battery charges to 90% capacity during the first five hours of normal operation.
- **Do not** expect full battery run capability during this initial charge period.

Cold start the UPS

Use cold start feature to supply power to connected equipment from the UPS batteries.

Press the POWER ON/OFF button. Then, the display panel will illuminate. Press the POWER ON/OFF button again to supply battery power to the connected equipment.

Connect and install management software

Easy UPS SRV models are provided with PowerChute™ management software for unattended operating system shutdown, UPS monitoring, UPS control and energy reporting.

1. Connect the USB cable from the rear of the UPS to the protected device such as a server.
NOTE: A USB driver is required to communicate with PowerChute over USB. For more information, refer to Knowledge Base article FAQ000223363 on the APC by Schneider Electric website(<https://www.apc.com/us/en/faqs/home>).
2. For a server or other device with an operating system, download and install the latest version of the PowerChute Serial Shutdown from www.apc.com/pcss. PowerChute Serial Shutdown supports graceful shutdown in the event of an extended power outage.
NOTE: PowerChute is a 64-bit application and cannot be installed on a 32-bit operating system.
3. A built-in serial port is also available for additional communication options with serial cable.
NOTE: Both RS232 Serial Port and USB Communication Port cannot be used at the same time.

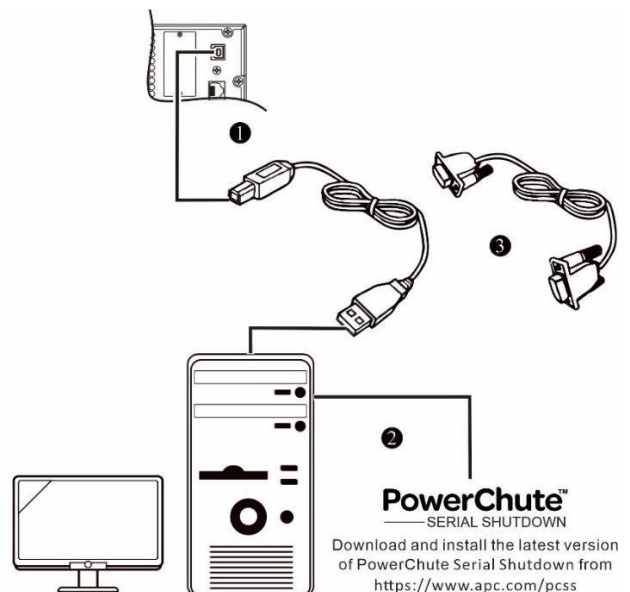

1	Connect the USB cable from the rear of the Easy UPS to the computer.
2	Download and install the latest version of PowerChute Serial Shutdown from https://www.apc.com/pcss .
3	A built-in serial port is also available for additional communication options with serial cable.

Additional communication options are available via the built-in intelligent card slot. Refer to the APC by Schneider Electric Web site, www.apc.com, for more information.

Emergency Power Off

The Emergency Power Off (EPO) function is a feature that will immediately remove power to all connected equipment. When EPO button is pushed, all connected equipment will immediately turn off and UPS transfer to mains STANDBY mode.

Adhere to all national and local electrical codes. Wiring must be performed by a qualified electrician.

The EPO switch is internally powered by the UPS for use with non-powered switches or potential free contacts.

Normally closed (N/C) contacts

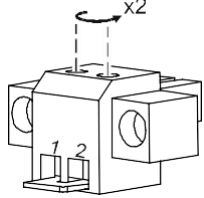
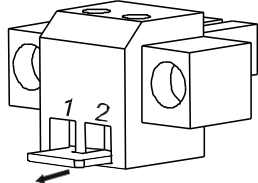
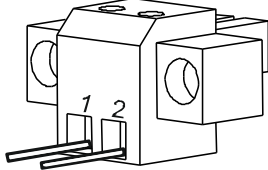
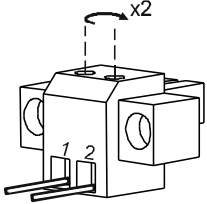
1	Loosen the screws of terminals 1 and 2 in the EPO connector. 	2	Remove the metal link between pins 1 and 2. 
3	Connect N/C relay contacts between pins 1 and 2 of the EPO terminal block. Use 0.5 to 1 mm ² wire. 	4	Secure the EPO connector screws beneath pins 1 and 2. 

NOTE: If the N/C is open, the UPS output will turn off and power will be removed from the load.

Use Class 2 cable (CL2) to connect the Easy UPS to the EPO switch.

NOTICE

RISK OF EQUIPMENT DAMAGE

Do not connect the EPO interface to any circuit other than a unused circuit.

Failure to follow these instructions can result in equipment damage.

The EPO interface is a Safety Extra Low Voltage (SELV) circuit. Connect it only to other SELV circuits. The EPO interface monitors circuits that have no determined voltage potential. Such closure circuits may be provided by a switch or relay properly isolated from the utility. To avoid damage to the UPS, do not connect the EPO interface to any circuit other than a unused circuit.

Use one of the following cable types to connect the UPS to the EPO switch.

- CL2: Class 2 cable for general use.
- CL2P: Plenum cable for use in ducts, plenums, and other spaces used for environmental air.

- CL2R: Riser cable for use in a vertical run in a floor-to-floor shaft.
- CLEX: Limited use cable for use in dwellings and for use in raceways.

Operation





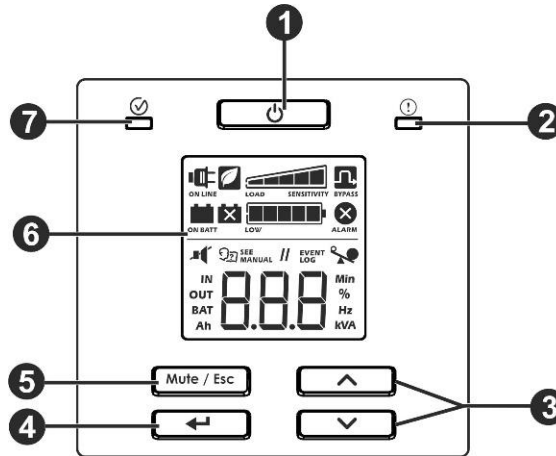





Using The Display

These Easy UPS models are equipped with an intuitive and configurable LCD display. This display complements the software interface as they convey similar information and either may be used to configure the UPS settings. The display consists of the following keys and indicators:



❶	POWER ON/OFF button	<ul style="list-style-type: none"> ● Press this button to turn on the UPS. ● Press and hold this button until a beep is heard to turn off the UPS. ● Press this button to reset alarms.
❷	Alarm LED	This Alarm LED illuminates red when the UPS detects an internal error and blinks red for UPS notifications. See “Alerts and Notifications” on page 14 in this manual.
❸	UP / DOWN button	Press these buttons to scroll up or down through the main menu options and display screens.
❹	ENTER button	Press this button to enter the menu or to select a menu item/value during navigation.
❺	MUTE/ESC button	<ul style="list-style-type: none"> ● To acknowledge audible alarms and suppress them temporarily. ● To exit a sub menu and return to the main menu.
❻	LCD Display	The display interface options are visible on this LCD screen. Press the UP or DOWN button to activate LCD, if the display is not illuminated.
❼	Status LED	<p>The Status LED illuminates green when the power is on. This LED indicates two different states of output power:</p> <ul style="list-style-type: none"> ● Output off: LED blinks. Press Power On/Off button to turn the output power on. ● Output on: LED illuminates green continuously.

LCD Display Icons

 ON LINE	<p>On Line: The UPS is drawing utility power and performing double conversion to supply power to the connected equipment.</p>
 ON BATT	<p>On Battery: The UPS is supplying battery backup power to the connected equipment.</p>
 	<p>Replace Battery: The battery is not connected securely or the battery is nearing the end of its service life and should be replaced.</p>
 BYPASS	<p>Bypass: The UPS is in bypass mode, sending utility power directly to connected equipment. Bypass mode operation is the result of an internal UPS event or an overload condition. Battery operation is not available while the UPS is in bypass mode. See “Alerts and Notifications” on page 14 in this manual.</p>
 ALAF M	<p>System Alarms: An internal error is detected. See “Alerts and Notifications” on page 14 in this manual.</p>
 	<p>Overload: The equipment connected to the UPS is drawing more power than the UPS rating.</p>
 LOW	<p>Battery Charge: The battery charge level is indicated by the number of illuminated bar sections. When all five blocks are illuminated, the battery is fully charged. Each bar represents approximately 20% of the battery charge capacity.</p>
 LOAD SENSITIVITY	<p>Load Level: The load percentage is indicated by the number of illuminated load bar sections. Each bar represents approximately 20% of the maximum load capacity.</p>
 	<p>Mute: An illuminated line through the icon indicates that the audible alarm is disabled.</p>
 	<p>Green Mode: An illuminated icon indicates that the unit is working in Green mode. The connected equipment is receiving the utility input directly as long as the input voltage and frequency are within the configured limits.</p>
 SEE MANUAL	<p>Alarm or notification: The UPS has detected an internal error or the UPS is in configuration mode. See “Alerts and Notifications” on page 14 in this manual.</p>
EVENT LOG	<p>Event: The icon is illuminated when the user is viewing the event log.</p>

Alerts and Notifications

Status Indicators

Continuous beeps, every half second	Low Battery State - The battery is nearing its complete discharge state. The UPS is about to shut down.
	Overload condition - The equipment connected to the UPS is drawing more power than rated.
4 beeps every 30 sec (first beep starts after 4 sec on battery)	On Battery State - The UPS is supplying battery backup power to the connected equipment.
Beeper continuously on	Alarm State - UPS has detected an internal error. See “Alerts and Notifications” in this manual.
Short beep every 2.5 sec	Battery disconnected.
Continuous short beeps for every half second for 1 minute, repeats every 5 hours.	Bad battery (replace the battery)
Two short beeps every 5 sec	Event Bypass State - UPS has detected an internal error. Connected equipment receives utility input power through the bypass relay.

Alerts

Display code	Description	Solution
SC	UPS has experienced a short circuit at the output terminals. Unit will try to auto-recover from this condition.	Check if there is any short circuit at the UPS output terminals. Remove the short circuit, wait for the unit to auto-recover or Press POWER ON/OFF button to start the UPS.
OL	UPS is experiencing an overload condition.	Disconnect nonessential equipment from the UPS to eliminate the overload condition.
dCH	The UPS has detected a DC voltage error. Unit will try to auto-recover from this condition.	If the UPS does not recover automatically, contact APC by Schneider Electric Customer Support.
Hot	Temperature of the unit is rising above the set limits.	Disconnect nonessential equipment from the UPS to reduce the UPS load. Ensure that ambient temperature is within limits. Ensure that adequate clearance is maintained.
CH9	UPS has detected a charger error.	Press POWER ON/OFF button to start the UPS. If the charger error is persists, contact APC by Schneider Electric Customer Support.
Contact APC by Schneider Electric Customer Support for all other alert codes.		

Notifications

Display code	Description	Solution
bdc	Battery is not connected.	Connect battery to the UPS. Refer “Connect the battery” on page 9 for details.

UPS Display Parameters

Operational data displayed in the display panel is given in the table.
Navigate using the button.

Parameter	Units	Indicator Icons
Output voltage	Vac	OUT, V
Output frequency	Hz	OUT, Hz
Input voltage	Vac	IN, V
Input frequency	Hz	IN, Hz
Battery voltage	V DC	BAT, V
Ambient temperature	°C	NUMBER, C
State of battery charge	%	BAT, %
Load level in percentage	%	OUT, %
Load level in kVA	kVA	OUT, kVA
Total Ah capacity of connected battery	Ah	BAT, Ah
Remaining On Battery runtime	Minutes	BAT, Min

Configuration

Configure UPS Parameters

Follow the steps to configure parameters in the UPS:

1. Press the ENTER button.
2. Press the UP/DOWN button to navigate to “Set”.
3. Press the ENTER button.
4. Navigate through the parameters using the UP/DOWN button.
5. Press the ENTER button to edit a parameter. Icons start flashing to indicate the editing.
6. Press the UP/DOWN button to navigate between the options available for the selected parameter.
7. Press the ENTER button to select the option or MUTE/ESC button to abort the editing of current parameter. Flashing of icons stops after this.
8. Press the UP/DOWN button to navigate between parameters.
9. Press the MUTE/ESC button to exit menu navigation.

UPS Settings

Configure UPS settings using the display interface. See “Configure UPS parameters” section to edit the parameters.

Function	Factory Default	User Selectable Options	Description
Output voltage	230 VAC	208, 220, 230, 240 VAC	Allows the user to select output voltage while the UPS is operating online.
Audible alarm	Y (Enable)	Y (Enable) n (Disable)	UPS will mute audible alarms when set to disable or when the MUTE button is pressed.
Green mode/ high efficiency mode	n (Disable)	Y (Enable) n (Disable)	When this mode is enabled, connected equipment receives utility input power through the bypass relay as long as input voltage is within the range of $\pm 5\%$ of configured output voltage and ± 3 Hz of configured output frequency. Inverter is turned off during this mode. If utility power input goes out of range, inverter is turned on. The load is transferred to online mode or battery mode. The power to the connected equipment may be interrupted up to 10 milliseconds.
Minimum battery capacity to restart setting	0%	0%, 15%,50%,90%,	UPS output will not be turned on until the battery is charged to a level such that it can provide the runtime configured by this setting. If configured to 0%, UPS output is turned on immediately after utility power returns.
Low battery state indication setting	2 min	2 min, 5 min, 7min, 10min,	The UPS will emit audible alarm when the actual run time reaches the limit set by the user. The audible alarm will emit only when the UPS is working in battery mode.

Advance Display Navigation

There are five options in main menu and two sub-menu options in UPS display. Press the ENTER button from the Home Screen to access these menu options. Use the UP/ DOWN button to navigate between the menu options.

Menu Option	Description								
SEt	<p>Configure the UPS Use this menu option to configure the UPS parameters. Press the ENTER button to see the configuration options. Refer “Configure UPS parameters” on page 16 for details. Press the MUTE/ESC button to return to the Home Screen.</p>								
LOG	<p>Show Event Log Use this menu option to see the UPS event log. The UPS records the last 10 events and displays the codes in this log. Press the ENTER button to see the log. Use the UP/DOWN button to see the logged events. The DOWN button navigates towards old events and the UP button navigates to new events. Every log entry has a numeric and textual event code. At the end of the log, the word “End” will be displayed. Press the MUTE/ESC button to return to the Home Screen.</p>								
UPS	<p>Show UPS information Use this menu option to see the UPS information. Press the ENTER button to see the rating of the UPS. Press the UP button to see the UPS firmware version. Press the MUTE/ESC button to return to the Home Screen.</p>								
bYP	<p>User Command to bypass Use this menu option to switch the UPS to bypass mode or to online mode. Press ENTER button:</p> <table border="0"> <tr> <td>Put</td> <td>Put: Use to switch the UPS to bypass mode of operation.</td> </tr> <tr> <td>Out</td> <td>Note: Power to the connected equipment will drop, if the mains voltage is not within the threshold limits.</td> </tr> <tr> <td></td> <td>Out: Bring the UPS out of bypass and restore clean power to the connected equipment. The Easy UPS will start a count down on the display while switching to Online mode or coming out of Bypass mode.</td> </tr> </table>	Put	Put: Use to switch the UPS to bypass mode of operation.	Out	Note: Power to the connected equipment will drop, if the mains voltage is not within the threshold limits.		Out: Bring the UPS out of bypass and restore clean power to the connected equipment. The Easy UPS will start a count down on the display while switching to Online mode or coming out of Bypass mode.		
Put	Put: Use to switch the UPS to bypass mode of operation.								
Out	Note: Power to the connected equipment will drop, if the mains voltage is not within the threshold limits.								
	Out: Bring the UPS out of bypass and restore clean power to the connected equipment. The Easy UPS will start a count down on the display while switching to Online mode or coming out of Bypass mode.								
tSt	<p>Execute Battery Self-Test Use this menu option to conduct a self-test and determine the battery status. Press the ENTER button to initiate the test. If the test command is accepted, the UPS will initiate a self-test and will start a count down on the display. Display messages are shown at the end of the test.</p> <table border="0"> <tr> <td>rFd</td> <td>Test refused. The output is off, battery is not charged or battery capacity is lower than 75%.</td> </tr> <tr> <td>FId</td> <td>Test not passed</td> </tr> <tr> <td>PA5</td> <td>Test passed</td> </tr> <tr> <td>Abt</td> <td>Test is aborted due to internal reasons</td> </tr> </table> <p>Press the MUTE/ESC button to return to the Home Screen</p>	rFd	Test refused. The output is off, battery is not charged or battery capacity is lower than 75%.	FId	Test not passed	PA5	Test passed	Abt	Test is aborted due to internal reasons
rFd	Test refused. The output is off, battery is not charged or battery capacity is lower than 75%.								
FId	Test not passed								
PA5	Test passed								
Abt	Test is aborted due to internal reasons								

Troubleshooting

Use the table below to solve minor installation and operation problems. Refer to the APC by Schneider Electric Web site, www.apc.com for assistance with complex UPS problems.

Problem and/or Possible Cause	Solution
UPS will not turn on when utility input is available or there is no power output	
The UPS is not turned on.	Press the POWER ON/OFF button to turn on the UPS.
The UPS is not connected to utility power supply.	Be sure that the power cable from the UPS to the utility power supply is securely connected at both ends. See “Start Up” on page 9 in this manual.
Input thermal circuit breaker on the UPS is tripped.	Press the input thermal circuit breaker RESET button on the rear panel.
UPS, when connected to battery, is not supplying power to the connected equipment	
The UPS is not turned on.	If the UPS has shutdown (the display is not on), follow the procedure “Cold start the UPS” on page 11.
The battery is not connected.	Connect battery to the UPS. See “Start Up” on page 9 in this manual.
Low battery cut off. UPS may have discharged the battery due to utility power outage and turned the output off due to low battery condition.	Wait for the utility power to return and charge the battery. To turn on the output power after utility power returns, press POWER ON/OFF button.
UPS emits an audible beep at long intervals	
The UPS is operating normally on battery.	UPS has detected an internal error. See “Alerts and Notifications” on page 14 in this manual.
Alarm LED is illuminated. The UPS displays an alarm message and emits a constant beep	
The UPS has detected an internal error.	See “Alerts and Notifications” on page 14 in this manual.
No audible sounds from UPS even when the Alert LED is illuminated.	
Audible alarm is disabled.	Change the UPS configuration to enable audible alarms.
UPS is not providing expected backup time.	
The UPS battery is discharged due to a recent power outage.	The batteries require recharging after extended outages. Batteries can wear faster when put into service without proper recharging or when operated at elevated temperatures.
The battery is near the end of its service life.	If the battery is near the end of its service life, consider replacing the battery, even if the replace battery indicator is not illuminated. See “Start Up” on page 9 in this manual.
UPS is not turning off	
POWER OFF button not pressed properly	Press and hold the POWER ON/OFF button until a beep is heard to power off the UPS.
Utility input power is available.	UPS logic power can not be turned off if utility input power is available. To turn off the UPS, turn off utility input power and press POWER ON/OFF button. Release when a beep is heard.

Problem and/or Possible Cause	Solution
UPS is in Bypass mode and the LED is not illuminated red.	
UPS is in green mode.	Disable green mode if not desired.
UPS is configured to stay in the bypass mode.	Change the configuration to exit bypass mode.
UPS is in Bypass mode and the LED is illuminated red.	
UPS is in bypass mode even after over temperature audible alarm is cleared.	Reduce the connected load to <90% to bring the UPS to online mode.
The UPS has experienced an overload condition and transferred to bypass.	<p>Connected equipment exceeds the “maximum load” as defined in specifications on the APC by Schneider Electric Web site, www.apc.com.</p> <p>The audible alarms remain on until the overload condition is corrected. Disconnect nonessential equipment from the UPS to eliminate the overload condition.</p> <p>The UPS continues to supply power as long as it is in bypass mode and the circuit breaker does not trip. The UPS will not provide battery power in the event of a utility voltage interruption.</p>
UPS detected an internal error and transferred to bypass.	See “Alerts and Notifications” on page 14 in this manual.

Transport

1. Shut down and disconnect all connected equipment.
2. Disconnect the unit from mains power.
3. Disconnect all internal and external batteries (if applicable).
4. Follow the shipping instructions outlined in the *Service* section of this manual.

Service

If the unit requires service, do not return it to the dealer. Follow these steps:

1. Review the *Troubleshooting* section of the manual to eliminate common problems.
2. If the problem persists, contact APC by Schneider Electric Customer Support through the APC by Schneider Electric Web site, **www.apc.com**.
 - a. Note the model number and serial number and the date of purchase. The model and serial numbers are located on the top cover of the unit and are available through the LCD display on select models.
 - b. Call Customer Support. A technician will attempt to solve the problem over the phone. If this is not possible, the technician will issue a Returned Material Authorization Number (RMA#).
 - c. If the unit is under warranty, the repairs are free.
 - d. Service procedures and returns may vary internationally. For country specific instructions refer to the APC by Schneider Electric Web site, **www.apc.com**.
3. Pack the unit properly to avoid damage in transit. Never use foam beads for packaging. Damage sustained in transit is not covered under warranty.

Note: Before shipping, always disconnect battery modules in a UPS or external battery pack. The disconnected internal batteries may remain inside the UPS or external battery pack.
4. Write the RMA# provided by Customer Support on the outside of the package.
5. Return the unit by insured, prepaid carrier to the address provided by Customer Support.

Limited Factory Warranty

Schneider Electric IT Corporation (SEIT), warrants its products to be free from defects in materials and workmanship for a period of 2 Years from the date of purchase. The SEIT obligation under this warranty is limited to repairing or replacing, at its own sole option, any such defective products. Repair or replacement of a defective product or part thereof does not extend the original warranty period.

This warranty applies only to the original purchaser who must have properly registered the product within 10 days of purchase. Products may be registered online at warranty.apc.com.

SEIT shall not be liable under the warranty if its testing and examination disclose that the alleged defect in the product does not exist or was caused by end user or any third person misuse, negligence, improper installation, testing, operation or use of the product contrary to SEIT recommendations of specifications. Further, SEIT shall not be liable for defects resulting from: 1) unauthorized attempts to repair or modify the product, 2) incorrect or inadequate electrical voltage or connection, 3) inappropriate on site operation conditions, 4) Acts of God, 5) exposure to the elements, or 6) theft. In no event shall SEIT have any liability under this warranty for any product where the serial number has been altered, defaced, or removed.

EXCEPT AS SET FORTH ABOVE, THERE ARE NO WARRANTIES, EXPRESS OR IMPLIED, BY OPERATION OF LAW OR OTHERWISE, APPLICABLE TO PRODUCTS SOLD, SERVICED OR FURNISHED UNDER THIS AGREEMENT OR IN CONNECTION HEREWITH.

SEIT DISCLAIMS ALL IMPLIED WARRANTIES OF MERCHANTABILITY, SATISFACTION AND FITNESS FOR A PARTICULAR PURPOSE.

SEIT EXPRESS WARRANTIES WILL NOT BE ENLARGED, DIMINISHED, OR AFFECTED BY AND NO OBLIGATION OR LIABILITY WILL ARISE OUT OF, SEIT RENDERING OF TECHNICAL OR OTHER ADVICE OR SERVICE IN CONNECTION WITH THE PRODUCTS.

THE FOREGOING WARRANTIES AND REMEDIES ARE EXCLUSIVE AND IN LIEU OF ALL OTHER WARRANTIES AND REMEDIES. THE WARRANTIES SET FORTH ABOVE CONSTITUTE SEIT'S SOLE LIABILITY AND PURCHASER EXCLUSIVE REMEDY FOR ANY BREACH OF SUCH WARRANTIES. SEIT WARRANTIES EXTEND ONLY TO ORIGINAL PURCHASER AND ARE NOT EXTENDED TO ANY THIRDPARTIES.

IN NO EVENT SHALL SEIT, ITS OFFICERS, DIRECTORS, AFFILIATES OR EMPLOYEES BE LIABLE FOR ANY FORM OF INDIRECT, SPECIAL, CONSEQUENTIAL OR PUNITIVE DAMAGES, ARISING OUT OF THE USE, SERVICE OR INSTALLATION OF THE PRODUCTS, WHETHER SUCH DAMAGES ARISE IN CONTRACT OR TORT, IRRESPECTIVE OF FAULT, NEGLIGENCE OR STRICT LIABILITY OR WHETHER SEIT HAS BEEN ADVISED IN ADVANCE OF THE POSSIBILITY OF SUCH DAMAGES. SPECIFICALLY, SEIT IS NOT LIABLE FOR ANY COSTS, SUCH AS LOST PROFITS OR REVENUE, WHETHER DIRECT OR INDIRECT, LOSS OF EQUIPMENT, LOSS OF USE OF EQUIPMENT, LOSS OF SOFTWARE, LOSS OF DATA, COSTS OF SUBSTITUANTS, CLAIMS BY THIRD PARTIES, OR OTHERWISE.

NOTHING IN THIS LIMITED WARRANTY SHALL SEEK TO EXCLUDE OR LIMIT SEIT LIABILITY FOR DEATH OR PERSONAL INJURY RESULTING FROM ITS NEGLIGENCE OR ITS FRAUDULENT MISREPRESENTATION OF TO THE EXTENT THAT IT CANNOT BE EXCLUDED OR LIMITED BY APPLICABLE LAW.

To obtain service under warranty you must obtain a Returned Material Authorization (RMA) number from customer support. Customers with warranty claims issues may access the SEIT worldwide customer support network through the APC by Schneider Electric Web site: www.apc.com. Select your country from the country selection drop down menu. Open the Support tab at the top of the web page to obtain information for customer support in your region. Products must be returned with transportation charges prepaid and must be accompanied by a brief description of the problem encountered and proof of date and place of purchase.

APC by Schneider Electric Worldwide Customer Support

Customer support for this or any other APC by Schneider Electric product is available at no charge in any of the following ways:

- Visit the APC by Schneider Electric Web site to access documents in the APC by Schneider Electric Knowledge Base and to submit customer support requests.
 - **www.apc.com** (Corporate Headquarters)
Connect to localized APC by Schneider Electric Web sites for specific countries, each of which provides customer support information.
 - **www.apc.com/support/**
Global support searching APC by Schneider Electric Knowledge Base and using e-support.
- Contact the APC by Schneider Electric Customer Support Center by telephone or e-mail.
 - Local, country specific centers: go to **www.apc.com/support/contact** for contact information.

For information on how to obtain local customer support, contact the APC by Schneider Electric representative or other distributor from whom you purchased your APC by Schneider Electric product.