

Device overview

Installation

TwinBus IP
REG Power Supply

Installation Guide

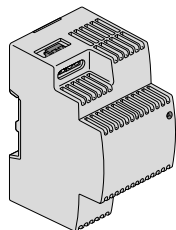

RGE2057100

For your safety

⚠ ⚠ DANGER

HAZARD OF ELECTRIC SHOCK, OR ARC FLASH

Safe electrical installation must be carried out only by skilled professionals. Skilled professionals must prove profound knowledge in the following areas:

- Connecting to installation networks
- Connecting several electrical devices
- Laying electric cables
- Safety standards, local wiring rules and regulations

Failure to follow these instructions will result in death or serious injury.

About this document

In this document you will find all information for safe installation.



For further product information, follow the QR Code.



<https://www.merten.de/profibereich/service/downloads.html>

Scope of supply

REG Power supply, installation guide

Introduction to the TwinBus IP REG Power Supply

The TwinBus IP REG Power Supply (hereinafter referred to as the **power supply**) serves as the power supply for the TwinBus IP System. The power supply can also be used to supply additional TwinBus IP system components.

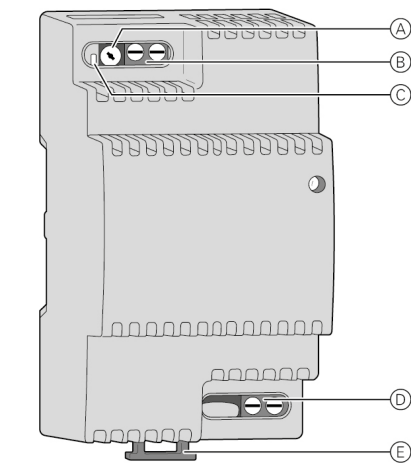

- (A) Setting output voltage 24 V ... 28 V
- (B) Port output +, -
- (C) LED DC = ON
- (D) Port input L, N
- (E) Disassembly clip

The green LED DC = ON indicates that the output voltage is present.

The right place to install

The power supply is mounted on a TH 35/7.5 or TH 35/15 standard DIN rail.

- Do not cover ventilation holes
- Do not exceed the maximum cable length (see table below) between the components of the system

The following table shows the maximum cable length between the power supply, the REG bus filter and the system components.

	Group of cables		
	0.8 mm	0.6 mm	0.5 mm
Power supply - REG Bus filter	< 1 m	< 1 m	< 1 m
REG Bus filter - Door station	80 m	60 m	50 m
REG Bus filter - Video indoor station	80 m	80 m	50 m

If the power supply is used to supply additional system components, the following maximum cable lengths shall be considered.

	Group of cables		
	0.8 mm	0.6 mm	0.5 mm
Power supply - additional Video indoor station	50 m	50 m	50 m
Power supply - Door station	50 m	50 m	50 m

Group 0.8 mm cable:
YR 2x0.8 mm, J-Y(ST)Y 2x2x0.8 mm, A-2Y(L)2Y 2x2x0.8 mm, CAT5e / CAT6 0.8 mm

Group 0.6 mm cable:
A-2Y(L)2Y 2x2x0.6 mm, J-Y(ST)Y 2x2x0.6 mm, CAT5e / CAT6 0.8 mm

Group 0.5 mm cable:
CAT5e / CAT6 0.5 mm
When using a shielded cable, the shield must not be connected.

⚠ ⚠ WARNING

DANGER TO LIFE DUE TO ELECTRIC SHOCK. THE DEVICE CAN BE DAMAGED.

The safety distance according to IEC 60664-1 must be guaranteed.

- Keep a distance of at least 4 mm between the individual wires of the 230 V line and the 24 V SELV wire (A).

Failure to follow these instructions may result in death or serious injury.

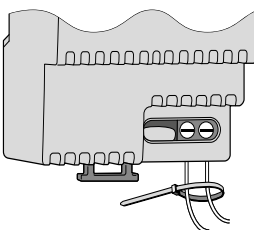
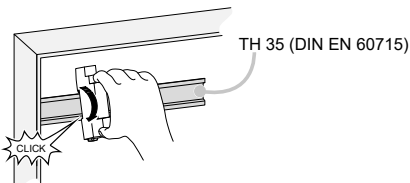

1 Fix the cables input L, N with a cable tie.

Wiring diagrams

As system voltage supply

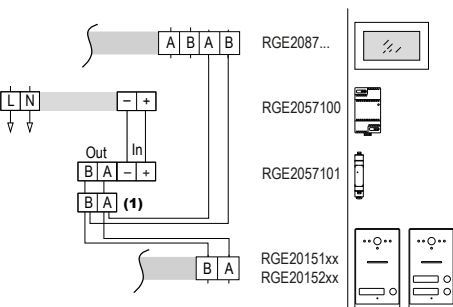

(1) Terminal strip

As power supply for additional video indoor station

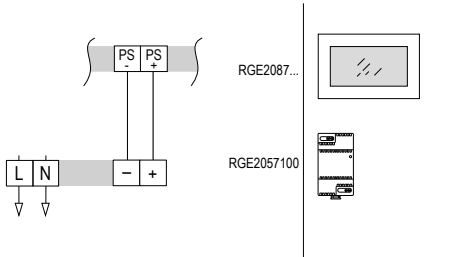

Derating curve

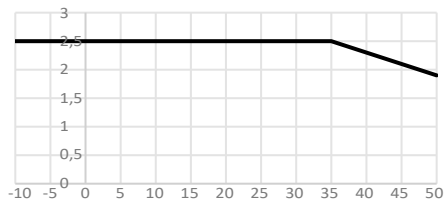

Technical data

Performance data

Input voltage	AC 100 V ... 240 V
Frequency	50 Hz / 60 Hz
Output voltage	SELV DC 24 V ... 28 V
Rated current	2.5 A
Rated power	60 W

Environmental conditions

Ambient temperature	-10 °C ... 50 °C
Humidity (max)	95 %
Maximum height above NN	2000 m

Dimensions and weight

Dimensions (W x H x D)	54 x 95 x 68.5 mm
Space requirement on the DIN rail	3 modules
Weight	210 g

Connection terminal

Clamping range output (conductor diameter)	1x 0.5 mm ... 0.8 mm solid 1x AWG 24 ... AWG 20 solid Copper-clad aluminum conductors must not be used.
--	---

Nominal torque	0.5 Nm
----------------	--------

Housing insulation

Basic insulation to neighboring DIN rail devices

Protection class

The device complies with the IP30 protection class if it is installed in a distribution cabinet with at least IP30.

WEEE



Dispose of the device separately from household waste at an official collection point. Professional recycling protects people and the environment against potential negative effects.

Schneider Electric GmbH c/o Ritto

Fritz-Kotz-Str. 8
51674 Wiehl, Germany
se.com/contact

© 2023 Schneider Electric, all rights reserved