

Ultrasonic Sensor M18 Straight or 90° angled version

Plastic: XX●18P1PM12
Ni-plated Brass: XX●18B1PM12
Stainless steel: XX●18S1PM12

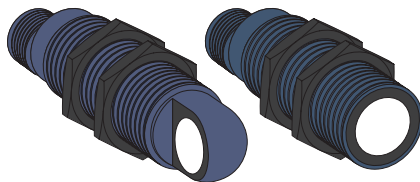

http://qr.tesensors.com/XX0003

LEDs



Dimensions

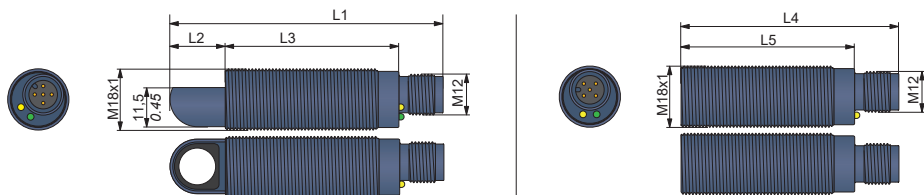

	mm (in.)				
	L1	L2	L3	L4	L5
XX●18B1PM12	80,25 (3.16)	16,25 (0.64)	51 (2.01)	64 (2.52)	51 (2.01)
XX●18S1PM12	80 (3.15)	16,9 (0.67)	50,6 (1.99)	64 (2.52)	52 (2.05)
XX●18P1PM12					

Tightening torque

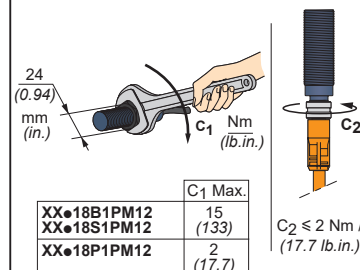

Connectors wiring

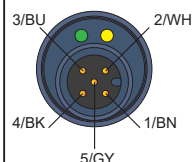

Pin Number	Wire Color	Description
①	BN: Brown	+12...24 Vdc
②	WH: White	Input teach
③	BU: Blue	0 Vdc
④	BK: Black	Output (PNP)
⑤	GY: Grey	Synchronization

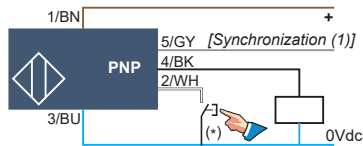

(+): External setting push button or XXZPB100
Note: (1): See synchronization section

Wiring accessory

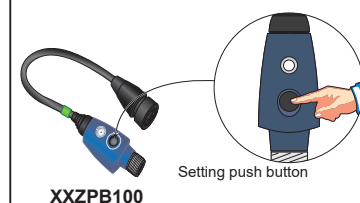

Wiring diagrams

Digital Output (NO or NC)

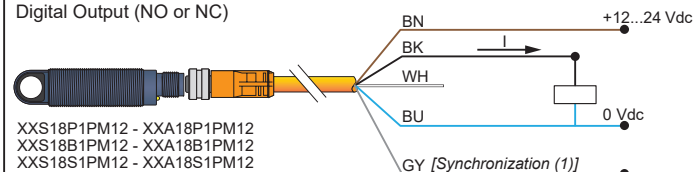

XXS18P1PM12 - XXA18P1PM12
XXS18B1PM12 - XXA18B1PM12
XXS18S1PM12 - XXA18S1PM12

Note: (1): See synchronization section

Sensor setting with teach procedure

A Window mode (1)

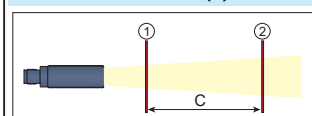

① Near limit ② Far limit

C: Sensing window

(1): For Window mode, the teaching order of the near and far limits can be interchanged.

1 Push and hold the teach button. (Between 3...6 seconds) Release when the green LED is steady. On releasing, the green LED will start flashing.

2 Position object at the near limit. Push and release the teach button quickly. Now the yellow LED will be steady and the green LED will continue flashing.

3 Position object at the far limit. Push and release the teach button quickly to return to normal operation in the window mode.

B Output mode Setting: NO or NC

1 Push and hold the teach button. (Between 6...9 seconds) Release when the yellow LED is steady. Both LEDs flash for approx. 2 seconds and the output switches from NO to NC or NC to NO.

C Sensor reset (2)

1 Push and hold the teach button. (Between 15...21 seconds) Release when both the LEDs are flashing. The sensor is now reset to its default setting. (3).

Note:
(2): If this XX sensor is intended to be used as a replacement for an XXS● or XXA● sensor in your equipment, please read the following message - The original XX sensor may be configured using the XX configuration software. In this case, the software setting will become the default setting. Please confirm with the OEM, sensors vendor or Telemecanique sales representative while replacing the original XXS● or XXA● sensor of your equipment.
(3): Operation mode, near limit, far limit, NO/NC are reset. By default the sensor is in Window mode, full sensing range, NO output.

D Operation mode selection

1 Push and hold the teach button. (Between 9...15 seconds) Release when both LEDs are steady.

2 Press and release as per below information (within 5 seconds) to select the correct operation mode:

- 1x → window mode
- 2x → reflex mode
- 3x → proximity mode
- 4x → pump mode

E Checking the operation mode

1 Push the teach button and release quickly (before 3 seconds). The number of flashes of the green LED indicates the operation mode:

- 1 flash - Window mode
- 2 flashes - Reflex mode
- 3 flashes - Proximity mode
- 4 flashes - Pump / Hysteresis mode

WARNING

UNINTENDED EQUIPMENT OPERATION

Do not use this product to detect objects within the deadband (blind zone) or outside the sensing window.
Failure to follow these instructions can result in death, serious injury, or equipment damage.

Electrical equipment should be installed, operated, serviced, and maintained only by qualified personnel.
No responsibility is assumed by Schneider Electric for any consequences arising out of the use of this material.

© 2018 Schneider Electric. "All Rights Reserved."

Sensor setting with teach procedure

F Reflex mode (4)

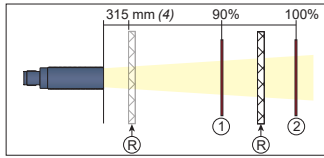

(4): In the reflex mode, the position of the reflector must be at least 315 mm away from the sensor.

1 Put the sensor in reflex mode (See section D).

2 Push and hold the teach button. (Between 3...6 seconds) Release when the green LED is steady. On releasing, the green LED will start flashing.

3 Position the reflector and press and release the teach button quickly. The sensor returns to normal operation.

① Near limit ② Far limit (R) Reflector

G Proximity mode

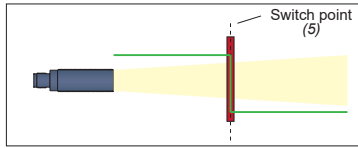

(5): Switch point is at full sensing range by default.

1 Put the sensor in proximity mode (See section D).

2 Push and hold the teach button. (Between 3...6 seconds) Release when the green LED is steady. On releasing, the green LED will start flashing.

3 Position the object and press the teach button once. The sensor returns to normal operation.

H Pump / Hysteresis mode

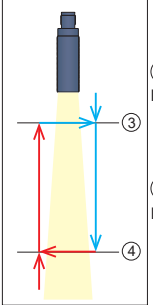

③ Near hysteresis limit

④ Far hysteresis limit

1 Put the sensor in pump mode (See section D).

2 Push and hold the teach button. (Between 3...6 seconds) Release when the green LED is steady. On releasing, the green LED will start flashing.

3 Position the object at the near hysteresis limit and press the teach button once. Now the yellow LED will be steady and the green LED will continue flashing.

4 Position the object at the far hysteresis limit and press the teach button once. The sensor returns to normal operation.

Note:
- To change from Emptying to Filling (or vice versa), follow the same instruction as changing NO↔NC outputs.
- The teaching order of near and far limits can be interchanged.

Tilt angle

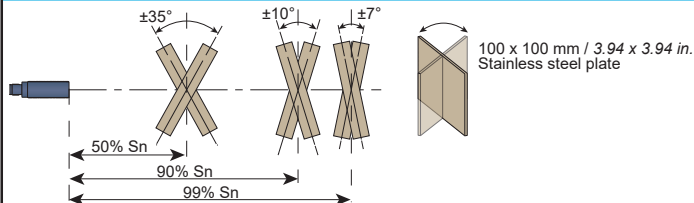

Detection curves for different objects

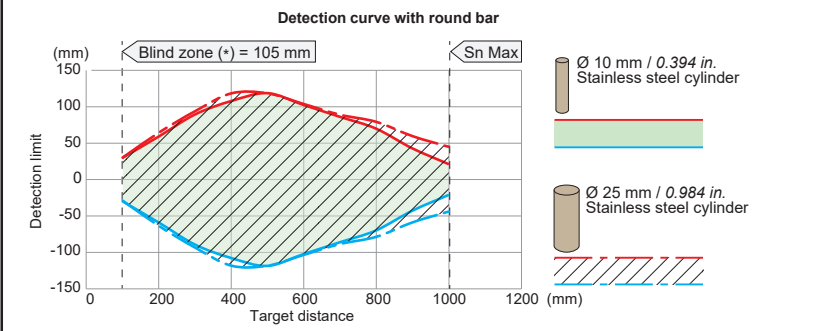
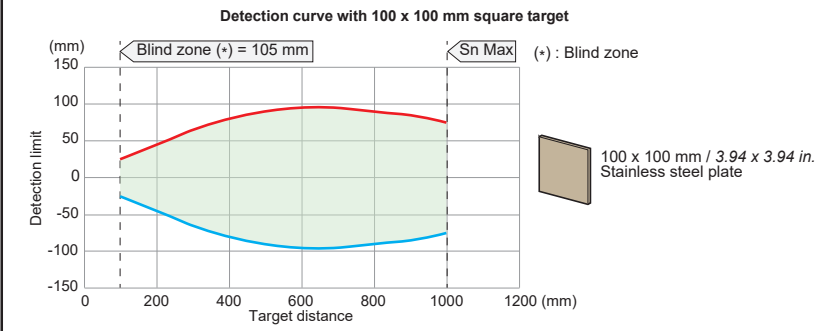

Cabling Accessories

Cables	M12 connectors	
5-pin, 5-wire (for synchronization)	XZCPV11V12L2 (2 m / 6.6 ft) XZCPV11V12L5 (5 m / 16.4 ft) XZCPV11V12L10 (10 m / 32.8 ft)	XZCPV12V12L2 (2 m / 6.6 ft) XZCPV12V12L5 (5 m / 16.4 ft) XZCPV12V12L10 (10 m / 32.8 ft)
5-pin, 4-wire (no synchronization)	XZCP1141L2 (2 m / 6.6 ft) XZCP1141L5 (5 m / 16.4 ft) XZCP1141L10 (10 m / 32.8 ft)	XZCP1241L2 (2 m / 6.6 ft) XZCP1241L5 (5 m / 16.4 ft) XZCP1241L10 (10 m / 32.8 ft)
		XZCC12FDM50B XZCC12FCM50B

Synchronization (side by side application)

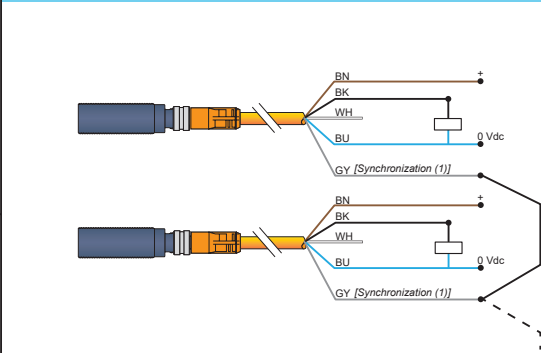

Synchronization operation
To enable synchronization between several sensors, all of the wires of pin no.5 (grey) must be electrically connected together. A maximum of 8 sensors can be synchronized.

Connection with a PLC for synchronization
The sensors are synchronized when the pin no.5 are simultaneously driven by the rising edge of a pulse. More than 8 sensors can be synchronized by using PLC output.

NOTE (1): The pulse must be at a high level of 10 to 24 Vdc and a low level of 0 to 2Vdc. The period of the pulses must be at least 15 ms (cycle time of the sensor).

NOTE (2): When the pin no.5 is at low level or at high level, object sensing is suspended and the sensor output holds the last valid output state before suspension.

Mounting accessory

