

- en** Auxiliary Terminals
- fr** Bornes auxiliaires
- es** Terminales auxiliares
- de** Zubehörklemmen
- it** Terminali ausiliari
- pt** Terminais auxiliares
- ru** Вспомогательные клеммы
- zh** 辅助端子

? → [www.se.com/support](http://www.se.com/support)





<p>Retain instruction sheet for future use.</p> <p><b>PLEASE NOTE</b></p> <ul style="list-style-type: none"> <li>● Electrical equipment should be installed, operated, serviced, and maintained only by qualified personnel.</li> <li>● No responsibility is assumed by Schneider Electric for any consequences arising out of the use of this material.</li> <li>● All pertinent state, regional, and local safety regulations must be observed when installing and using this product.</li> </ul>	<p>Instruction de service à conserver pour usage ultérieur.</p> <p><b>REMARQUE IMPORTANTE</b></p> <ul style="list-style-type: none"> <li>● L'installation, l'utilisation, la réparation et la maintenance des équipements électriques doivent être assurées par du personnel qualifié uniquement.</li> <li>● Schneider Electric décline toute responsabilité quant aux conséquences de l'utilisation de ce matériel.</li> <li>● Toutes les réglementations locales, régionales et nationales pertinentes doivent être respectées lors de l'installation et de l'utilisation de ce produit.</li> </ul>	<p>Guarde la hoja de instrucciones para utilizarla en el futuro.</p> <p><b>TENGA EN CUENTA</b></p> <ul style="list-style-type: none"> <li>● La instalación, utilización, puesta en servicio y mantenimiento de equipos eléctricos deberán ser realizados sólo por personal cualificado.</li> <li>● Schneider Electric no se hace responsable de ninguna de las consecuencias del uso de este material.</li> <li>● Al instalar y utilizar este producto es necesario tener en cuenta todas las regulaciones sobre seguridad correspondientes, ya sean regionales, locales o estatales.</li> </ul>	<p>Bewahren Sie die Kurzanleitung als Referenz für den späteren Gebrauch auf.</p> <p><b>BITTE BEACHTEN</b></p> <ul style="list-style-type: none"> <li>● Elektrische Geräte dürfen nur von Fachpersonal installiert, betrieben, bedient und gewartet werden.</li> <li>● Schneider Electric haftet nicht für Schäden, die durch die Verwendung dieses Materials entstehen.</li> <li>● Bei der Montage und Verwendung dieses Produkts sind alle zutreffenden staatlichen, landesspezifischen, regionalen und lokalen Sicherheitsbestimmungen zu beachten.</li> </ul>
<p>Conservare questo foglio di istruzioni per un utilizzo futuro.</p> <p><b>NOTA</b></p> <ul style="list-style-type: none"> <li>● Manutenzione, riparazione, installazione e uso delle apparecchiature elettriche si devono affidare solo a personale qualificato.</li> <li>● Schneider Electric non si assume alcuna responsabilità per qualsiasi conseguenza derivante dall'uso di questo materiale.</li> <li>● Durante l'installazione e l'uso di questo prodotto è necessario rispettare tutte le normative locali, nazionali o internazionali in materia di sicurezza.</li> </ul>	<p>Guarde a folha de instruções para utilização futura.</p> <p><b>NOTA</b></p> <ul style="list-style-type: none"> <li>● A instalação, utilização e manutenção do equipamento eléctrico devem ser efectuadas exclusivamente por pessoal qualificado.</li> <li>● A Schneider Electric não assume qualquer responsabilidade pelas consequências resultantes da utilização deste material.</li> <li>● Todas as regulamentações de segurança pertinentes, sejam estatais, regionais ou locais, devem ser cumpridas na instalação e utilização deste produto.</li> </ul>	<p>Сохраните эту инструкцию для использования в будущем.</p> <p><b>ОБРАТИТЕ ВНИМАНИЕ</b></p> <ul style="list-style-type: none"> <li>● Установка, эксплуатация, ремонт и обслуживание электрического оборудования может выполняться только квалифицированными электриками.</li> <li>● Компания Schneider Electric не несет никакой ответственности за любые возможные последствия использования данной документации.</li> <li>● Во время установки и использования данного изделия следует соблюдать все действующие государственные, региональные и местные нормы и правила безопасности.</li> </ul>	<p>请保管好此说明书以供将来使用。</p> <p><b>请注意</b></p> <ul style="list-style-type: none"> <li>● 电气设备的安装、操作、维修和维护工作仅限于合格人员执行。</li> <li>● Schneider Electric 不承担由于使用本资料所引起的任何后果。</li> <li>● 在安装和使用本产品时，必须遵守国家、地区和当地的所有相关的安全法规。</li> </ul>





**⚠️ ⚠️ DANGER / DANGER / PELIGRO / GEFAHR / PERICOLO / PERIGO / ОПАСНО / 危險**





<p><b>HAZARD OF ELECTRIC SHOCK, EXPLOSION OR ARC FLASH</b></p> <ul style="list-style-type: none"> <li>● Apply appropriate personal protective equipment (PPE) and follow safe electrical work practices. See NFPA 70E, CSA Z462, NOM-029-STPS or local equivalent.</li> <li>● This equipment must only be installed and serviced by qualified electrical personnel.</li> <li>● Turn off all power supplying this equipment before working on or inside equipment.</li> <li>● Always use a properly rated voltage sensing device to confirm power is off.</li> <li>● Put back all devices, doors, and covers before turning on power to this equipment.</li> <li>● Beware of potential hazards, and carefully inspect the work area for tools and objects that may have been left inside the equipment.</li> </ul> <p><b>Failure to follow these instructions will result in death or serious injury.</b></p>	<p><b>RISQUE D'ÉLECTROCUTION, D'EXPLOSION OU D'ÉCLAIR D'ARC ÉLECTRIQUE</b></p> <ul style="list-style-type: none"> <li>● Portez un équipement de protection individuel (EPI) adapté et respectez les consignes de sécurité électrique courantes. Reportez-vous aux normes NFPA 70E, CSA Z462, NOM-029-STPS ou aux codes locaux en vigueur.</li> <li>● Seul un personnel qualifié doit effectuer l'installation et l'entretien de cet équipement.</li> <li>● Débranchez toutes les sources d'alimentation de cet équipement avant d'effectuer toute opération interne ou externe sur celui-ci.</li> <li>● Utilisez toujours un dispositif de détection de tension ayant une valeur nominale appropriée pour vous assurer que l'alimentation est coupée.</li> <li>● Remplacez tous les dispositifs, les portes et les capots avant de mettre l'équipement sous tension.</li> <li>● Faites attention aux dangers potentiels et inspectez attentivement la zone de travail pour vous assurer qu'aucun outil ou objet n'est resté à l'intérieur de l'équipement.</li> </ul> <p><b>Le fait de ne pas suivre ces instructions entraînera des blessures graves, voire mortelles.</b></p>	<p><b>PELIGRO DE DESCARGA ELÉCTRICA, EXPLOSIÓN O DESTELLO POR ARQUEO</b></p> <ul style="list-style-type: none"> <li>● Utilice equipo de protección personal (EPP) apropiado y siga las prácticas de seguridad eléctricas establecidas. Consulte las normas NFPA 70E, CSA Z462, NOM-029-STPS u otros códigos locales correspondientes.</li> <li>● Solamente el personal eléctrico calificado deberá instalar y prestar servicio de mantenimiento a este equipo.</li> <li>● Desconecte todas las fuentes de alimentación del equipo antes de realizar cualquier trabajo en él.</li> <li>● Siempre utilice un dispositivo detector de tensión nominal adecuado para confirmar la desenergización del equipo.</li> <li>● Vuelva a colocar todos los dispositivos, las puertas y las cubiertas antes de volver a energizar el equipo.</li> <li>● Tenga cuidado con los riesgos potenciales, e inspeccione cuidadosamente la zona de trabajo para comprobar si han quedado herramientas y objetos dentro del equipo.</li> </ul> <p><b>El incumplimiento de estas instrucciones tendrá como resultado la muerte o lesiones graves.</b></p>	<p><b>GEFAHR VON ELEKTRISCHEM SCHLAG, EXPLOSION ODER LICHTBOGEN</b></p> <ul style="list-style-type: none"> <li>● Tragen Sie persönliche Schutzausrüstung (PSA) und befolgen Sie sichere Verfahren im Umgang mit Elektrogeräten. Siehe NFPA 70E, CSA Z462, NOM-029-STPS oder lokale Entsprechung.</li> <li>● Diese Geräte dürfen nur von qualifizierten Elektrikern installiert und gewartet werden.</li> <li>● Schalten Sie vor Arbeiten am bzw. im Innern des Geräts die gesamte Spannungsversorgung ab.</li> <li>● Verwenden Sie für die Prüfung vorhandener Spannung stets einen Spannungsfühler mit zutreffender Bemessungsspannung.</li> <li>● Bringen Sie alle Vorrichtungen, Türen und Abdeckungen wieder an, bevor Sie das Gerät einschalten.</li> <li>● Beachten Sie potenzielle Gefahren, und überprüfen Sie den Arbeitsbereich auf Werkzeuge und andere Gegenstände, die sich möglicherweise noch in der Anlage befinden.</li> </ul> <p><b>Eine Nichtbeachtung dieser Anweisungen hat Tod, schwere Verletzungen oder Schäden an der Ausrüstung zur Folge.</b></p>
<p><b>RISCHIO DI FOLGORAZIONE, ESPLOSIONI O ARCO ELETTRICO</b></p> <ul style="list-style-type: none"> <li>● Utilizzare dispositivi di protezione individuale (DPI) idonei e adottare misure di sicurezza adeguate per lavori elettrici. Vedere le normative NFPA 70E, CSA Z462, NOM-029-STPS o le norme equivalenti nel paese di installazione.</li> <li>● Installazione e manutenzione di questa apparecchiatura si devono affidare solo ad elettricisti qualificati.</li> <li>● Prima di lavorare con l'apparecchiatura o al suo interno isolare completamente l'alimentazione elettrica.</li> <li>● Per verificare che l'alimentazione sia isolata usare sempre un rilevatore di tensione correttamente tarato.</li> <li>● Sostituire dispositivi, sportelli e coperture prima di riaccendere l'alimentazione dell'apparecchiatura.</li> <li>● Prestare attenzione a potenziali pericoli e ispezionare con attenzione l'area di lavoro per assicurarsi di non aver dimenticato utensili o altri oggetti all'interno dell'apparecchiatura.</li> </ul> <p><b>Il mancato rispetto di queste istruzioni provocherà morte o gravi infortuni.</b></p>	<p><b>RISCO DE ELECTROCUSSÃO, DE EXPLOÇÃO, OU DE ARCO ELÉCTRICO</b></p> <ul style="list-style-type: none"> <li>● Utilize equipamento de proteção pessoal (PPE) e siga os métodos de segurança eléctrica. Consulte NFPA 70E, CSA Z462, NOM-029-STPS ou o equivalente local.</li> <li>● A instalação e manutenção deste equipamento só devem ser efectuadas por electricistas qualificados.</li> <li>● Desligue todas as fontes de alimentação deste equipamento antes de trabalhar no equipamento ou no seu interior.</li> <li>● Utilize sempre um dispositivo de detecção da tensão nominal adequada para confirmar se a alimentação está desligada.</li> <li>● Substitua todos os dispositivos, portas e tampas antes de ligar a alimentação deste equipamento.</li> <li>● Esteja atento a potenciais perigos e inspecione cuidadosamente a área de trabalho para se assegurar que não foram deixadas ferramentas e objectos no interior do equipamento.</li> </ul> <p><b>O não cumprimento destas instruções resultará em morte e lesões graves.</b></p>	<p><b>ОПАСНОСТЬ ПОРАЖЕНИЯ ЭЛЕКТРИЧЕСКИМ ТОКОМ, ВЗРЫВА ИЛИ ВОЗНИКНОВЕНИЯ ДУГИ</b></p> <ul style="list-style-type: none"> <li>● Используйте подходящие средства индивидуальной защиты (СИЗ) и соблюдайте технику безопасности при электротехнических работах. См. NFPA 70E, CSA Z462, NOM-029-STPS или местный эквивалентный стандарт.</li> <li>● Данное оборудование могут устанавливать и обслуживать только квалифицированные электрики.</li> <li>● Отключите питание до начала работы снаружи или внутри оборудования.</li> <li>● Всегда пользуйтесь надлежащим датчиком номинального напряжения для определения отсутствия питания.</li> <li>● Установите обратно все устройства, дверцы и крышки перед включением питания данного оборудования.</li> <li>● Избегайте потенциальных опасностей, внимательно осмотрите рабочую область на наличие инструментов и предметов, которые могли остаться внутри оборудования.</li> </ul> <p><b>Несоблюдение данных инструкций приводит к смерти или серьезной травме.</b></p>	<p><b>电击、爆炸或弧闪的危险</b></p> <ul style="list-style-type: none"> <li>● 采用适当的个人防护设备 (PPE) 并遵循电气作业安全守则。请参阅 NFPA 70E, CSA Z462, NOM-029-STPS 或当地对应的标准。</li> <li>● 只有具备相应资质的电气人员才能安装和维修该设备。</li> <li>● 在该设备表面或内部工作之前, 请关闭设备的全部电源。</li> <li>● 确保使用合适的额定电压传感器确认电源已关闭。</li> <li>● 装回所有设备、门和盖, 然后再打开该设备的电源。</li> <li>● 注意潜在危险, 仔细检查作业区, 以免将工具和物件遗忘在设备内部。</li> </ul> <p><b>未按说明操作将导致人身伤亡等严重后果。</b></p>





<p><b>⚠️ WARNING:</b> This product can expose you to chemicals including Diisononyl Phthalate (DINP), which is known to the State of California to cause cancer and Di-isodecyl Phthalate (DIDP) which is known to the State of California to cause birth defects or other reproductive harm. For more information go to <a href="http://www.P65Warnings.ca.gov">www.P65Warnings.ca.gov</a>.</p>	<p><b>⚠️ AVERTISSEMENT :</b> Ce produit peut vous exposer à des agents chimiques, y compris Diisononyl Phthalate (DINP), identifié par l'État de Californie comme pouvant causer le cancer et Di-isodecyl Phthalate (DIDP) pouvant provoquer des malformations congénitales ou autres troubles de l'appareil reproducteur. Pour de plus amples informations, prière de consulter <a href="http://www.P65Warnings.ca.gov">www.P65Warnings.ca.gov</a>.</p>	<p><b>⚠️ ADVERTENCIA:</b> Este producto puede exponerle a sustancias químicas, incluido ftalato de diisononilo (DINP), sustancia de la que el estado de California tiene constancia de que provoca cáncer, y ftalato de diisodocilo (DIDP), sustancia de la que el estado de California tiene constancia de que provoca defectos congénitos u otros daños reproductivos. Para obtener más información, visite <a href="http://www.P65Warnings.ca.gov">www.P65Warnings.ca.gov</a>.</p>	<p><b>⚠️ WARNUNG:</b> Dieses Produkt kann Sie chemischen Substanzen aussetzen, u. a. Diisononylphthalat (DINP), das im US-Bundesstaat Kalifornien als krebserregend eingestuft wird, sowie Diisodecylphthalat (DIDP), das im US-Bundesstaat Kalifornien als Ursache für Geburtsschäden oder andere Einschränkungen der Fortpflanzungsfähigkeit bekannt ist. Weitere Informationen finden Sie auf <a href="http://www.P65Warnings.ca.gov">www.P65Warnings.ca.gov</a>.</p>
<p><b>⚠️ AVVERTIMENTO:</b> Questo prodotto può esporre l'utente a sostanze chimiche compresi lo Ftalato di di-isononile (DINP), considerato dallo Stato della California come causa di tumori e lo Ftalato di isodecile (DIDP) considerato dallo Stato della California come causa di difetti congeniti o altri danni al sistema riproduttivo. Per ulteriori informazioni visitare <a href="http://www.P65Warnings.ca.gov">www.P65Warnings.ca.gov</a>.</p>	<p><b>⚠️ ATENÇÃO:</b> Este produto pode expô-lo a produtos químicos, incluindo ftalato de di-isononilo (DINP), que é reconhecido pelo Estado da Califórnia como causadoras de cancro e ftalato de di-isodocilo (DIDP), que é reconhecido pelo Estado da Califórnia como defeitos congénitos ou outros danos no aparelho reprodutor. Para obter mais informações, visite <a href="http://www.P65Warnings.ca.gov">www.P65Warnings.ca.gov</a>.</p>	<p><b>⚠️ ПРЕДУПРЕЖДЕНИЕ:</b> Пользователь этого изделия может подвергаться воздействию химических веществ, в том числе диизононилфталата (ДИНФ), который, согласно данным, имеющимся в штате Калифорния, вызывает рак, а также диизодецилфталата (ДИДФ), который, согласно данным, имеющимся в штате Калифорния, вызывает врожденные аномалии развития и наносит другой вред репродуктивной системе. Более подробные сведения можно найти на сайте <a href="http://www.P65Warnings.ca.gov">www.P65Warnings.ca.gov</a>.</p>	<p><b>⚠️ 警告:</b> 本产品可能导致您接触到化学物质, 其中包括被加利福尼亚州视为致癌物质的邻苯二甲酸二异壬酯 (DINP) 以及被加利福尼亚州视为可引起先天性缺陷或其他生殖危害的邻苯二甲酸二异癸酯 (DIDP)。有关详细信息, 请访问 <a href="http://www.P65Warnings.ca.gov">www.P65Warnings.ca.gov</a>。</p>





# 1 Related Documents / Documents à consulter / Documentos relacionados / Zugehörige Dokumente / Documenti correlati / Documentos relacionados / Связанные документы / 相关的文件





**en** Visit our website at [www.se.com/docs](http://www.se.com/docs) to download the documents listed below (user guides  or instruction sheets , for fixed  or drawout  circuit breakers) and other documents.



**fr** Visitez notre site web [www.se.com/docs](http://www.se.com/docs) pour télécharger les documents listés ci-dessous (guide utilisateurs  ou instructions de service , pour disjoncteur fixe  ou débrochable ) et d'autres documents.





**es** Visite nuestro sitio web en [www.se.com/docs](http://www.se.com/docs) para descargar los documentos que se enumeran a continuación (manuales de usuario  u hojas de instrucciones  para interruptores automáticos fijos  o extraíbles ) así como otros documentos.





































**de** Besuchen Sie unsere Website unter [www.se.com/docs](http://www.se.com/docs) zum Herunterladen der unten aufgeführten Dokumente. (Benutzerhandbücher  oder Bedienungsanleitungen  für feste  oder ausfahrbare  Leistungsschalter und weitere Dokumente herunterzuladen.

**it** Visitare il nostro sito Web all'indirizzo [www.se.com/docs](http://www.se.com/docs) per scaricare i documenti elencati di seguito (Guide utente  o Fogli di istruzioni ) per sezionatori fissi  o rimovibili  e altri documenti.

**pt** Visite o nosso Website em [www.se.com/docs](http://www.se.com/docs) para transferir os documentos listados abaixo (manuais de utilizador  ou folhas de instruções  para disjuntores fixos  ou retirados ) e outros documentos.

**ru** Посетите наш веб-сайт [www.se.com/docs](http://www.se.com/docs) для загрузки перечисленных ниже документов. (руководства пользователей  или инструкции  по стационарным или выкатным  автоматическим выключателям) и другие публикации.

**zh** 欢迎访问我公司网站 [www.se.com/docs](http://www.se.com/docs) 以下下载下列文档  
以下下载上述文件 (固定式  或抽出式  断路器用户指南  或说明书  和其他文件。

	<b>MasterPacT MTZ1 + MicroLogic X</b>		
	<p><b>en</b> DOCA0100EN <b>fr</b> DOCA0100FR <b>es</b> DOCA0100ES <b>zh</b> DOCA0100ZH</p>  	<p><b>en it</b> <b>fr pt</b> <b>es ru</b> <b>de zh</b></p> <p>NVE35505  </p>	<p><b>en it</b> <b>fr pt</b> <b>es ru</b> <b>de zh</b></p> <p>NVE35506  </p>
	<b>MasterPacT MTZ2/MTZ3 + MicroLogic X</b>		
	<p><b>en</b> DOCA0101EN <b>fr</b> DOCA0101FR <b>es</b> DOCA0101ES <b>zh</b> DOCA0101ZH</p>  	<p><b>en it</b> <b>fr pt</b> <b>es ru</b> <b>de zh</b></p> <p>NVE35469  </p>	<p><b>en it</b> <b>fr pt</b> <b>es ru</b> <b>de zh</b></p> <p>NVE35470  </p>
	<b>MasterPacT MTZ1 + MicroLogic Active</b>		
	<p><b>en</b> DOCA0284EN <b>fr</b> DOCA0284FR <b>es</b> DOCA0284ES <b>zh</b> DOCA0284ZH</p>  	<p><b>en it</b> <b>fr pt</b> <b>es ru</b> <b>de zh</b></p> <p>PKR4242702  </p>	<p><b>en it</b> <b>fr pt</b> <b>es ru</b> <b>de zh</b></p> <p>PKR4242802  </p>
	<b>MasterPacT MTZ2/MTZ3 + MicroLogic Active</b>		
	<p><b>en</b> DOCA0285EN <b>fr</b> DOCA0285FR <b>es</b> DOCA0285ES <b>zh</b> DOCA0285ZH</p>  	<p><b>en it</b> <b>fr pt</b> <b>es ru</b> <b>de zh</b></p> <p>PKR4242002  </p>	<p><b>en it</b> <b>fr pt</b> <b>es ru</b> <b>de zh</b></p> <p>PKR4243502  </p>
	<b>MasterPacT MTZ1 + MicroLogic X</b>		
	<p><b>en</b> 0614IB1702EN <b>fr</b> 0614IB1702FR <b>es</b> 0614IB1702ES <b>zh</b> 0614IB1702ZH</p> 	<p><b>en it</b> <b>fr pt</b> <b>es ru</b> <b>de zh</b></p> <p>QGH70064  </p>	<p><b>en it</b> <b>fr pt</b> <b>es ru</b> <b>de zh</b></p> <p>QGH70065  </p>
<b>MasterPacT MTZ2/MTZ3 + MicroLogic X</b>			
<p><b>en</b> 0614IB1701EN <b>fr</b> 0614IB1701FR <b>es</b> 0614IB1701ES <b>zh</b> 0614IB1701ZH</p> 	<p><b>en it</b> <b>fr pt</b> <b>es ru</b> <b>de zh</b></p> <p>QGH69562  </p>	<p><b>en it</b> <b>fr pt</b> <b>es ru</b> <b>de zh</b></p> <p>QGH69563  </p>	

**2** Required for Installation / Nécessaire pour l'installation / Necesario para la instalación / Erforderliches Material für die Installation / Richiesto per l'installazione / Necessário para a instalação / Инструменты и материалы, необходимые для монтажа / 必备安装工具

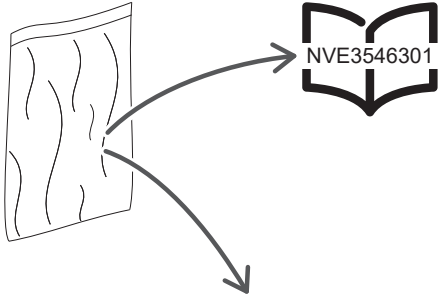

MTZ1/MTZ2/MTZ3		MTZ1		MTZ2/MTZ3	
<b>LV847074SP</b>	<b>LV847075SP</b>	<b>LV833098SP x1</b> <b>LV847071SP x30</b>	<b>LV833099SP x1</b> <b>LV847072SP x 10</b>	<b>LV847849SP x1</b> <b>LV847898SP x30</b>	<b>LV847850SP x1</b> <b>LV847899SP x10</b>
3 Wires Terminal Borne 3 fils Terminal de 3 hilos 3-Draht-Klemme Terminale a 3 cavi Terminal de 3 fios 3-проводная клемма 3 线端子	6 Wires Terminal Borne 6 fils Terminal de 6 hilos 6-Draht-Klemme Terminale a 6 cavi Terminal de 6 fios 6-проводная клемма 6 线端子	3 Wires Terminal Borne 3 fils Terminal de 3 hilos 3-Draht-Klemme Terminale a 3 cavi Terminal de 3 fios 3-проводная клемма 3 线端子	6 Wires Terminal Borne 6 fils Terminal de 6 hilos 6-Draht-Klemme Terminale a 6 cavi Terminal de 6 fios 6-проводная клемма 6 线端子	3 Wires Terminal Borne 3 fils Terminal de 3 hilos 3-Draht-Klemme Terminale a 3 cavi Terminal de 3 fios 3-проводная клемма 3 线端子	6 Wires Terminal Borne 6 fils Terminal de 6 hilos 6-Draht-Klemme Terminale a 6 cavi Terminal de 6 fios 6-проводная клемма 6 线端子

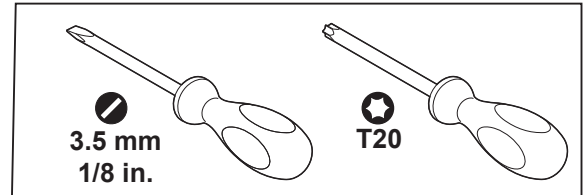

# 3 Before Working on Equipment / Avant de travailler sur cet équipement / Antes de trabajar en el equipo / Vor Eingriffen am Gerät / Prima di operare sull'apparecchiatura / Antes de trabalhar no equipamento / До начала работы с оборудованием / 设备操作前的准备工作

- en** 1. Turn off all power supplying this equipment before working on or inside equipment.  
 2. Use a properly-rated voltage sensing device to confirm power is off.  
 3. Turn off or trip circuit breaker before installation. Make sure the circuit breaker is in the open (O) position and spring is discharged.
- For drawout circuit breaker:**  
 4. Disconnect circuit breaker and make sure the circuit breaker is in the disconnected position.
- NOTE:** Consult the instruction sheet shipped with the circuit breaker.

- fr** 1. Débranchez toutes les sources d'alimentation de cet équipement avant d'effectuer toute opération interne ou externe sur celui-ci.  
 2. Utilisez un dispositif de détection de tension ayant une valeur nominale appropriée pour vous assurer que l'alimentation est coupée.  
 3. Mettez le disjoncteur en position ouverte ou déclenchée avant l'installation. Assurez-vous que le disjoncteur est ouvert (O) et que le ressort est désarmé.
- Pour les disjoncteurs débrochables:**  
 4. Débrochez le disjoncteur et assurez-vous que le disjoncteur est en position débroché.
- NOTA:** Consultez l'instruction de service livrée avec le disjoncteur.

- es** 1. Antes de trabajar con el equipo o en su interior, desactive la alimentación de este.  
 2. Utilice un dispositivo de detección de tensión de capacidad adecuada para confirmar la ausencia de alimentación eléctrica.  
 3. Desconecte o dispare el interruptor automático antes de la instalación. Asegúrese de que el interruptor automático se encuentre en la posición abierta (O) y que el resorte esté descargado.
- Para el interruptor automático extraíble:**  
 4. Desconecte el interruptor automático y asegúrese de que se encuentre en posición desconectada.
- NOTA:** Consulte la hoja de instrucciones suministrada con el interruptor automático.

- de** 1. Schalten Sie vor Arbeiten im oder am Gerät die Spannungszufuhr des Geräts vollständig aus.  
 2. Verwenden Sie ein Spannungsmessgerät mit geeigneter Bemessungsspannung, um sicherzustellen, dass keine Spannung mehr anliegt.  
 3. Schalten bzw. lösen Sie den Leistungsschalter vor der Installation aus. Stellen Sie sicher, dass sich der Leistungsschalter in der geöffneten Position (O) befindet und die Feder entpannt ist.
- Bei ausfahrbaren Leistungsschaltern:**  
 4. Trennen Sie den Leistungsschalter und stellen Sie sicher, dass der Leistungsschalter sich in der Trennstellung befindet.
- HINWEIS:** Ziehen Sie die Bedienungsanleitung zurate, die Sie zusammen mit dem Leistungsschalter erhalten haben.

- it** 1. Mettere fuori tensione questa apparecchiatura prima di intervenire sulla stessa o al suo interno.  
 2. Utilizzare un dispositivo di rilevamento di tensione di capacità adeguata per confermare l'assenza di alimentazione.  
 3. Spegnerne o far scattare il sezionatore prima dell'installazione. Accertarsi che il sezionatore sia in posizione aperta (O) e che la molla d'innescò sia scarica.
- Per il sezionatore rimovibile:**  
 4. Scollegare il sezionatore e assicurarsi che sia in posizione scollegato.
- NOTA:** consultare il foglio di istruzioni che accompagna il sezionatore.

- pt** 1. Desligue toda a alimentação que fornece este equipamento antes de trabalhar no exterior ou interior do equipamento.  
 2. Utilize um dispositivo de detecção de tensão com um valor nominal adequado para confirmar se a alimentação está desligada.  
 3. Desligue ou ligue o disjuntor antes de efectuar a instalação. Certifique-se de que o disjuntor está na posição aberta (O) e que a mola está descarregada.
- Para o disjuntor amovível:**  
 4. Desligue o disjuntor e certifique-se de que está na posição desligada.
- NOTA:** Consulte a folha de instruções fornecida com o disjuntor.

- ru** 1. Перед выполнением работ на оборудовании или внутри него выключите все источники питания оборудования.  
 2. Используйте обладающий соответствующими характеристиками датчик напряжения для проверки отключения электропитания.  
 3. Перед началом монтажа выключите или отключите автоматический выключатель. Убедитесь, что автоматический выключатель находится в разомкнутом (O) положении и что пружина не взведена.
- Для выкатного автоматического выключателя:**  
 4. Отсоедините автоматический выключатель и убедитесь, что он находится в отсоединенном положении.
- ПРИМЕЧАНИЕ.** Обратитесь к инструкции, поставляемой вместе с автоматическим выключателем.

- zh** 1. 在此设备上或其内部 作业之前, 请先关闭该设备的所有电源。  
 2. 使用适当的额定电压传感器确认电源已关闭。  
 3. 进行安装之前, 关闭或者使断路器跳闸。确保断路器处于开路 (O) 位置, 且弹簧已放电。  
**对于抽出式断路器:**  
 4. 断开断路器, 确保其处于断开位置。  
**注:** 参考随同断路器一起发运的说明书。

## MTZ1

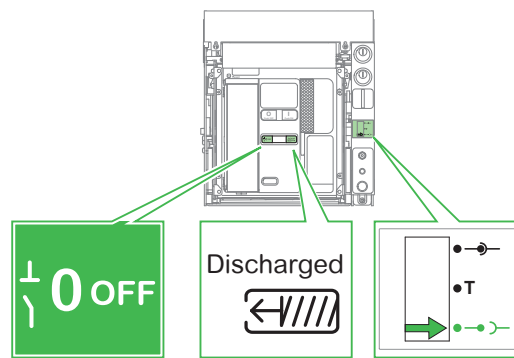
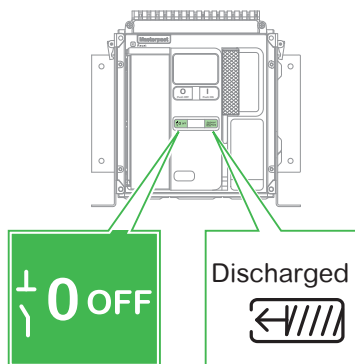

## MTZ2/MTZ3

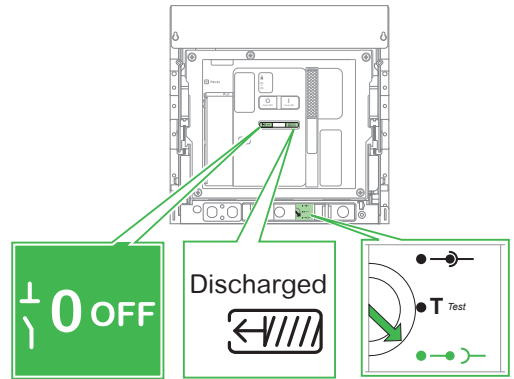
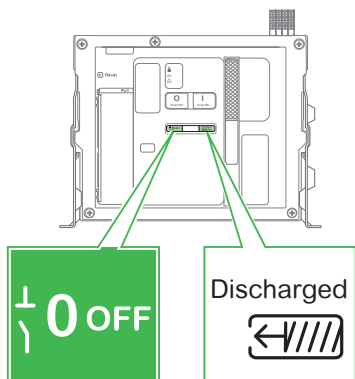

# 4 MasterPact MTZ: Fixed Circuit Breakers / Disjoncteur fixe / Interruptores automáticos fijos / Feste Leistungsschalter / Interruttori fissi / Disjuntores fixos / Стационарные автоматические выключатели / 固定式断路器

## 4.1 MasterPact MTZ1: Terminal Blocks / Borniers / Borneros / Klemmleisten / Morsettiere / Blocos de terminais / Клеммные коробки / 端子板

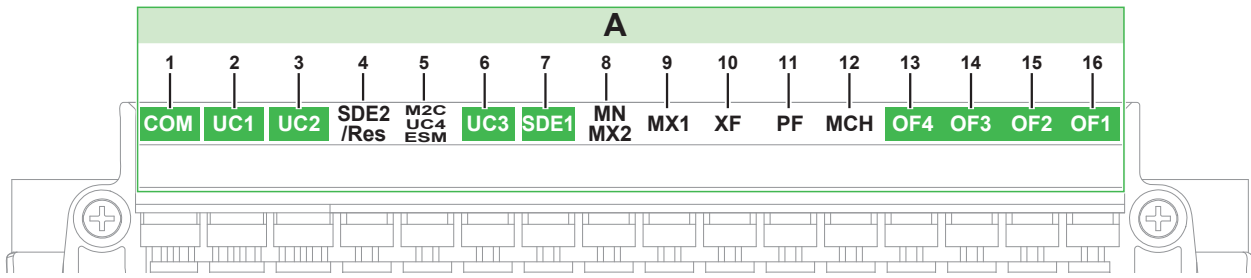

A				
1	24 V $\overline{\text{---}}$ (1) / ULP port	LV847075SP / LV850063SP	9 MX1 / -	LV847074SP
2	UC1 (1)	LV847075SP	10 XF / -	LV847074SP
3	UC2 (1)	LV847075SP	11 PF / -	LV847074SP
4	SDE2 / Res / -	LV847074SP	12 MCH / -	LV847074SP
5	M2C / UC4 / ESM	LV847074SP	13 OF4 (1)	LV847074SP
6	UC3 (2) / -	LV847074SP	14 OF3 (1)	LV847074SP
7	SDE1 (1)	LV847074SP	15 OF2 (1)	LV847074SP
8	MN / MX2 / -	LV847074SP	16 OF1 (1)	LV847074SP

**en** (1) Supplied as standard  
(2) Supplied as standard with 3P circuit breakers only

**es** (1) Suministrados de serie  
(2) Suministrados de serie sólo con interruptores automáticos 3P

**it** (1) Suministrados de serie  
(2) Fornito come standard solo con interruptori 3P

**ru** (1) Suministrados de serie  
(2) Входит в стандартную комплектацию только трехполюсных автоматических выключателей

**fr** (1) Livré en standard  
(2) Livrés en standard avec les disjoncteurs 3P uniquement

**de** (1) Standardmäßig mitgeliefert  
(2) Standardmäßig nur im Lieferumfang den 3P-Leistungsschaltern enthalten

**pt** (1) Standardmäßig mitgeliefert  
(2) Providenciado como standard somente com disjuntores 3P

**zh** (1) 标配  
(2) 标配仅提供 3P 断路器

## 4.2 MasterPact MTZ2/MTZ3: Terminal Blocks / Borniers / Borneros / Klemmleisten / Morsettiere / Blocos de terminais / Клеммные коробки / 端子板

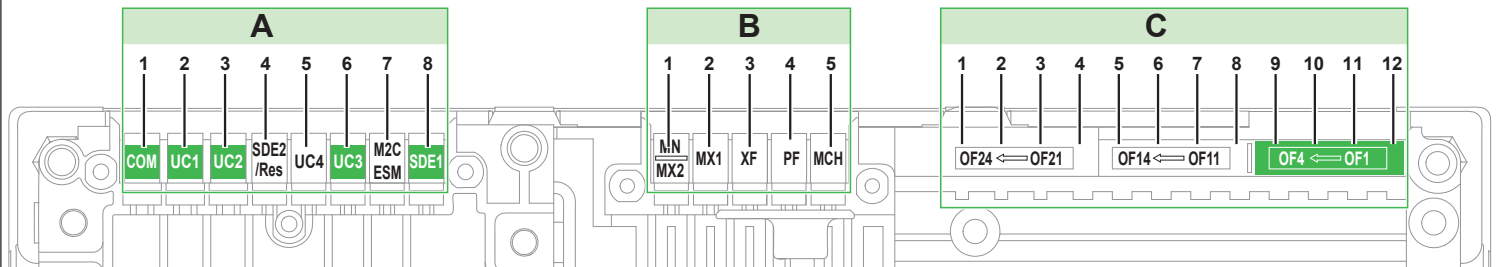

A			
1	24 V $\overline{\text{---}}$ (1) / ULP port	LV847075SP / LV850063SP	
2	UC1 (1)	LV847075SP	
3	UC2 (1)	LV847075SP	
4	SDE2 / Res / -	LV847074SP	
5	UC4 / -	LV847074SP	
6	UC3 (2) / -	LV847074SP	
7	M2C / ESM	LV847074SP	
8	SDE1 (1)	LV847074SP	

B			
1	MN / MX2 / -	LV847074SP	
2	MX1 / -	LV847074SP	
3	XF / -	LV847074SP	
4	PF / -	LV847074SP	
5	MCH / -	LV847074SP	

C			
1	OF24 / -	LV847074SP	
2	OF23 / -	LV847074SP	
3	OF22 / -	LV847074SP	
4	OF21 / -	LV847074SP	
5	OF14 / -	LV847074SP	
6	OF13 / -	LV847074SP	
7	OF12 / -	LV847074SP	
8	OF11 / -	LV847074SP	
9	OF4 (1)	LV847074SP	
10	OF3 (1)	LV847074SP	
11	OF2 (1)	LV847074SP	
12	OF1 (1)	LV847074SP	

**en** (1) Supplied as standard  
(2) Supplied as standard with 3P circuit breakers only

**es** (1) Suministrados de serie  
(2) Suministrados de serie sólo con interruptores automáticos 3P

**it** (1) Suministrados de serie  
(2) Fornito come standard solo con interruptori 3P

**ru** (1) Suministrados de serie  
(2) Входит в стандартную комплектацию только трехполюсных автоматических выключателей

**fr** (1) Livré en standard  
(2) Livrés en standard avec les disjoncteurs 3P uniquement

**de** (1) Standardmäßig mitgeliefert  
(2) Standardmäßig nur im Lieferumfang den 3P-Leistungsschaltern enthalten

**pt** (1) Standardmäßig mitgeliefert  
(2) Providenciado como standard somente com disjuntores 3P

**zh** (1) 标配  
(2) 标配仅提供 3P 断路器

#### 4.3 Installation / Installation / Instalación / Installation / Installazione / Instalação / Установка / 安装

##### MTZ1

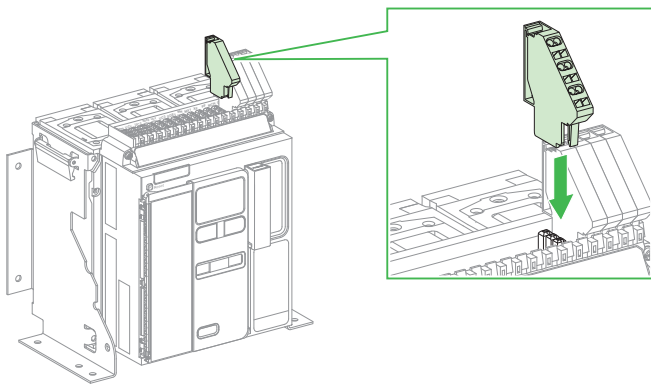

##### MTZ2/MTZ3

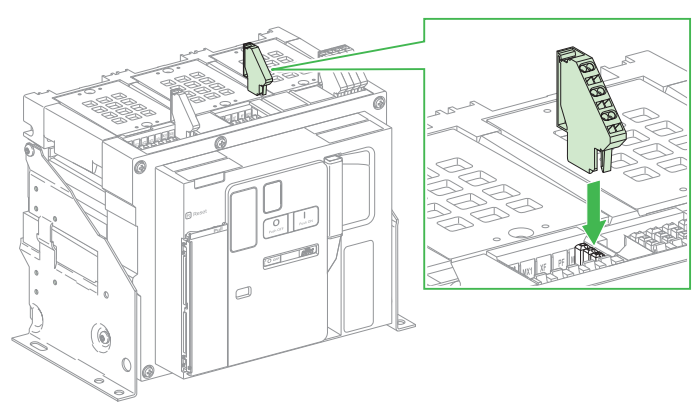

#### 4.4 Wiring / Câblage / Cableado / Verkabelung / Cablaggio / Cablagem / Кабель / 电缆

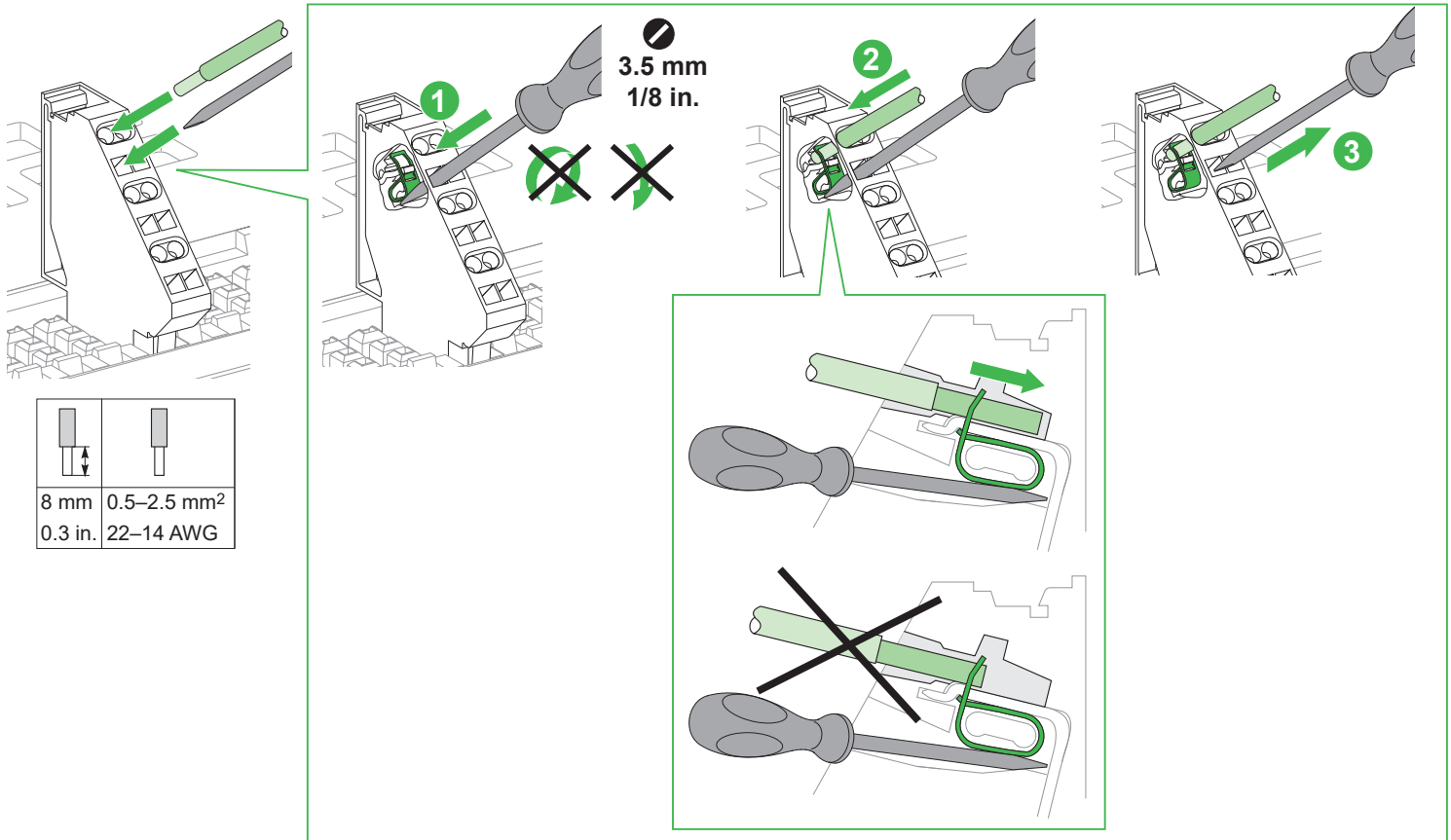

#### 4.5 Removal / Démontage / Extracción / Entfernen / Rimozione / Remoção / Извлечение / 拆卸

**en** Remove in reverse order of installation.

**fr** Démontez dans l'ordre inverse de l'installation.

**es** Realice la extracción en el orden inverso al de la instalación.

**de** Führen Sie die Entfernung in umgekehrter Reihenfolge zur Installation durch.

**it** Per la rimozione procedere nell'ordine inverso dell'installazione.

**pt** Remova pela ordem inversa da instalação.

**ru** Извлечение производят в порядке, обратном порядку установки.

**zh** 拆卸步骤与安装步骤相反。

# 5 MasterPac T MTZ1: Drawout Circuit Breaker / Disjoncteur débrochable / Interruptor automático seccionable / Einschubleistungsschalter / Interruttore estraibile / Disjuntor extraível / Выкатной автоматический выключатель / 抽出式断路器

## 5.1 Terminal Blocks / Borniers / Borneros / Klemmleisten / Morsettiere / Blocos de terminais / Клеммные коробки / 端子板

### 5.1.1 Without EIFE / Sans EIFE / Sin EIFE / Ohne EIFE / Senza EIFE / Sem EIFE / Без EIFE / 不带 EIFE

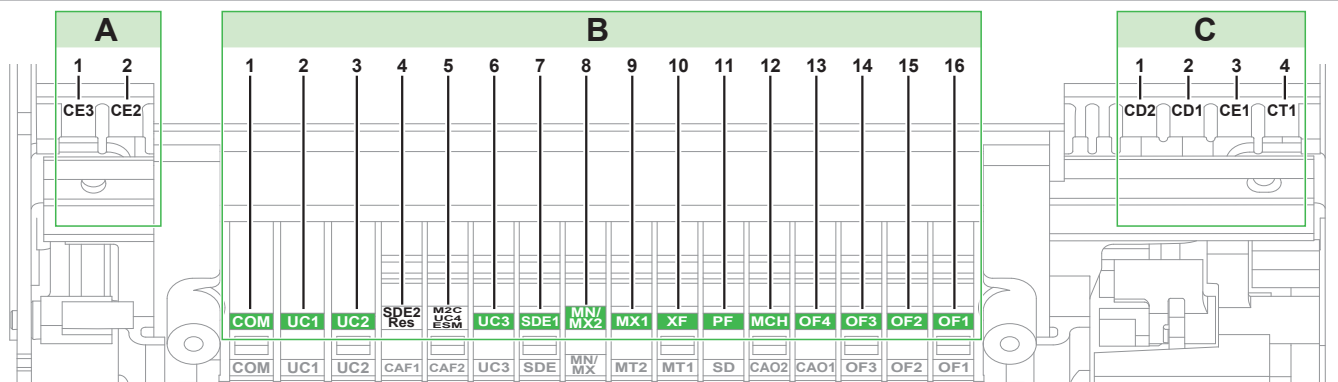

A	
1	CE3 / - LV833170SP / 171SP
2	CE2 / - LV833170SP / 171SP

B					
1	24 V $\overline{---}$ / ULP port	LV833099SP / LV850064SP	9	MX1 (1) / -	LV833098SP
2	UC1 (1)	LV833099SP	10	XF (1) / -	LV833098SP
3	UC2 (1)	LV833099SP	11	PF (1) / -	LV833098SP
4	SDE2 / Res / -	LV833098SP	12	MCH (1) / -	LV833098SP
5	M2C / UC4 / ESM	LV833098SP	13	OF4 (1)	LV833098SP
6	UC3 (2) / -	LV833098SP	14	OF3 (1)	LV833098SP
7	SDE1 (1)	LV833098SP	15	OF2 (1)	LV833098SP
8	MN (1) / MX2 (1) / -	LV833098SP	16	OF1 (1)	LV833098SP

C	
1	CD2 / - LV833170SP / 171SP
2	CD1 / - LV833170SP / 171SP
3	CE1 / - LV833170SP / 171SP
4	CT1 / - LV833170SP / 171SP

- en** (1) Supplied as standard  
(2) Supplied as standard with 3P chassis only

- fr** (1) Livré en standard  
(2) Livré en standard avec les châssis 3P uniquement

- es** (1) Suministrados de serie  
(2) Suministrados de serie sólo con el chasis 3P

- de** (1) Standardmäßig mitgeliefert  
(2) Standardmäßig im Lieferumfang der 3P-Einschubkassette enthalten

- it** (1) Suministrados de serie  
(2) Fornito come standard solo con il telaio 3P

- pt** (1) Standardmäßig mitgeliefert  
(2) Providenciado como standard somente com chassis 3P

- ru** (1) Suministrados de serie  
(2) Поставляется стандартно только с шасси 3P

- zh** (1) 标配  
(2) 仅 3P 抽架的标配

### 5.1.2 With EIFE / Avec EIFE / Con EIFE / Mit EIFE / Con EIFE / Com EIFE / C EIFE / 带 EIFE

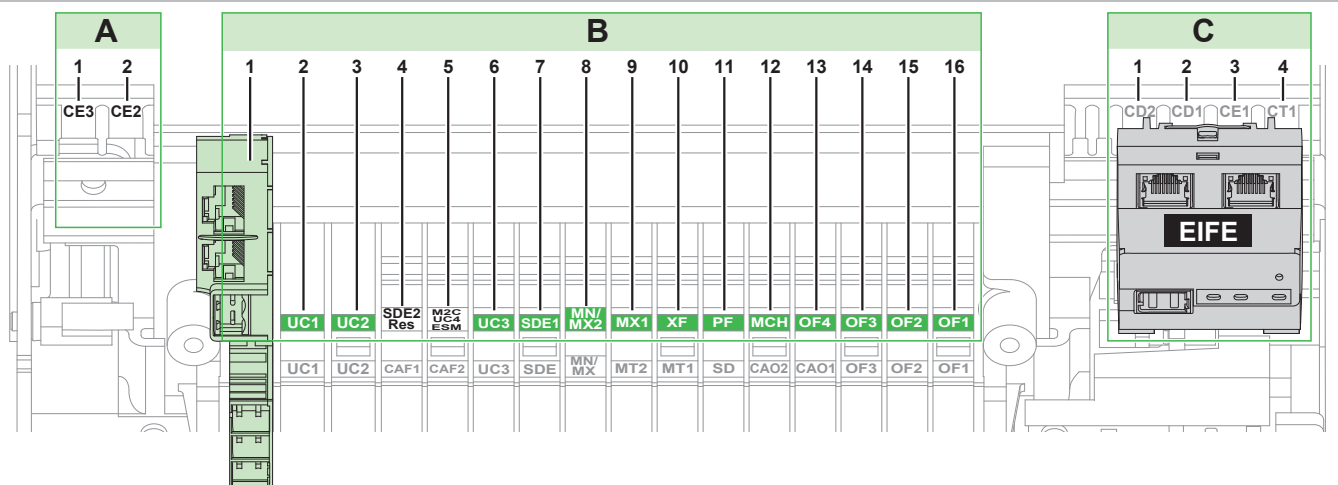

A	
1	CE3 / - LV833170SP / 171SP
2	CE2 / - LV833170SP / 171SP

B					
1	ULP port	LV850064SP	9	MX1 (1) / -	LV833098SP
2	UC1 (1)	LV833099SP	10	XF (1) / -	LV833098SP
3	UC2 (1)	LV833099SP	11	PF (1) / -	LV833098SP
4	SDE2 / Res / -	LV833098SP	12	MCH (1) / -	LV833098SP
5	M2C / UC4 / ESM	LV833098SP	13	OF4 (1)	LV833098SP
6	UC3 (2) / -	LV833098SP	14	OF3 (1)	LV833098SP
7	SDE1 (1)	LV833098SP	15	OF2 (1)	LV833098SP
8	MN (1) / MX2 (1) / -	LV833098SP	16	OF1 (1)	LV833098SP

C	
1	
2	EIFE LV851200SP
3	
4	

- en** (1) Supplied as standard  
(2) Supplied as standard with 3P chassis only

- fr** (1) Livré en standard  
(2) Livré en standard avec les châssis 3P uniquement

- es** (1) Suministrados de serie  
(2) Suministrados de serie sólo con el chasis 3P

- de** (1) Standardmäßig mitgeliefert  
(2) Standardmäßig im Lieferumfang der 3P-Einschubkassette enthalten

- it** (1) Suministrados de serie  
(2) Fornito come standard solo con il telaio 3P

- pt** (1) Standardmäßig mitgeliefert  
(2) Providenciado como standard somente com chassis 3P

- ru** (1) Suministrados de serie  
(2) Поставляется стандартно только с шасси 3P

- zh** (1) 标配  
(2) 仅 3P 抽架的标配



5.2 Auxiliary Terminal Shields Removal / Démontage des capots bornier auxiliaire / Extracción de los cubrebornes auxiliares / Entfernen der Abdeckung der Zubehöranchlussklemmen / Rimozione protezione sulla morsettiere ausiliaria / Remoção das blindagens dos terminais auxiliares / Снятие вспомогательных электроизоляторов клемм / 拆除二次接线端子盖板

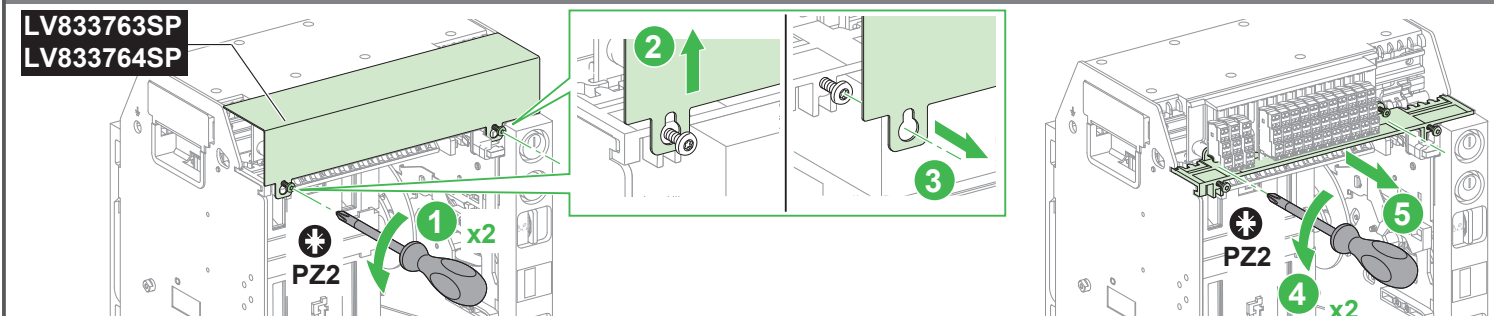

5.3 Installation / Installation / Instalación / Installation / Installazione / Instalação / Установка / 安装

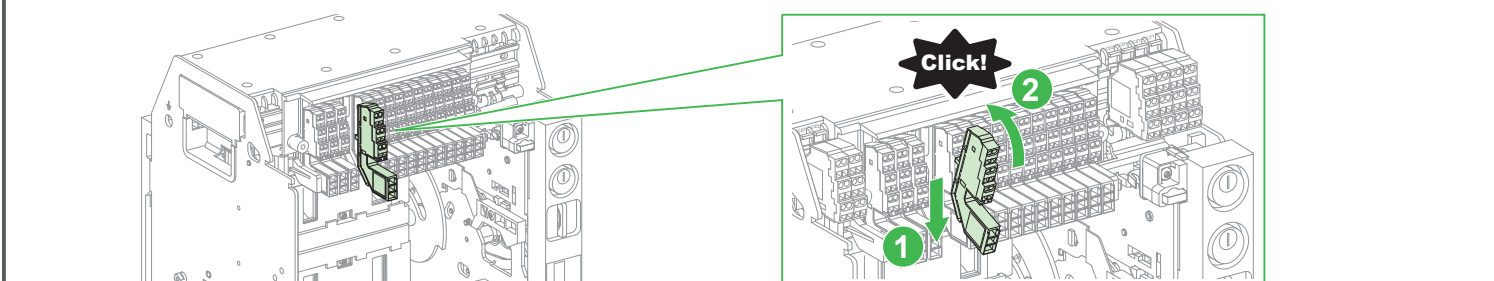

5.4 Wiring / Câblage / Cableado / Verkabelung / Cablaggio / Cablagem / Кабель / 电缆

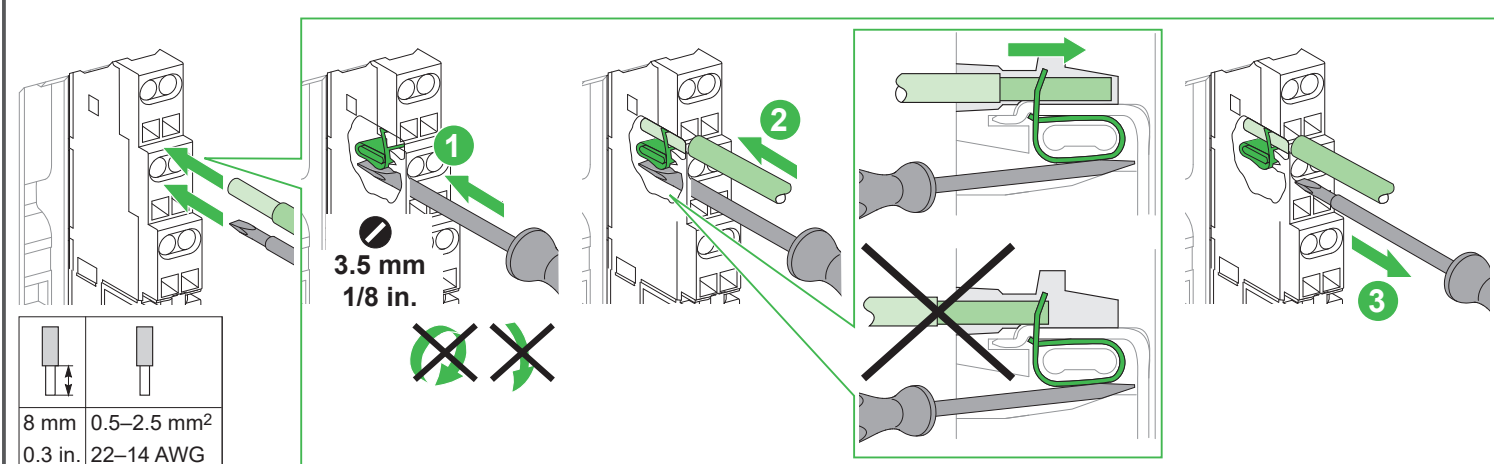

5.5 Auxiliary Terminal Shields Installation / Installation des capots bornier auxiliaire / Instalación de los cubrebornes auxiliares / Installation der Abdeckungen der Zubehöranschlussklemme / Installazione delle schermature dei morsetti ausiliari / Instalação das blindagens do terminal auxiliar / Установка вспомогательных электроизоляторов клемм / 辅助端子屏蔽罩安装

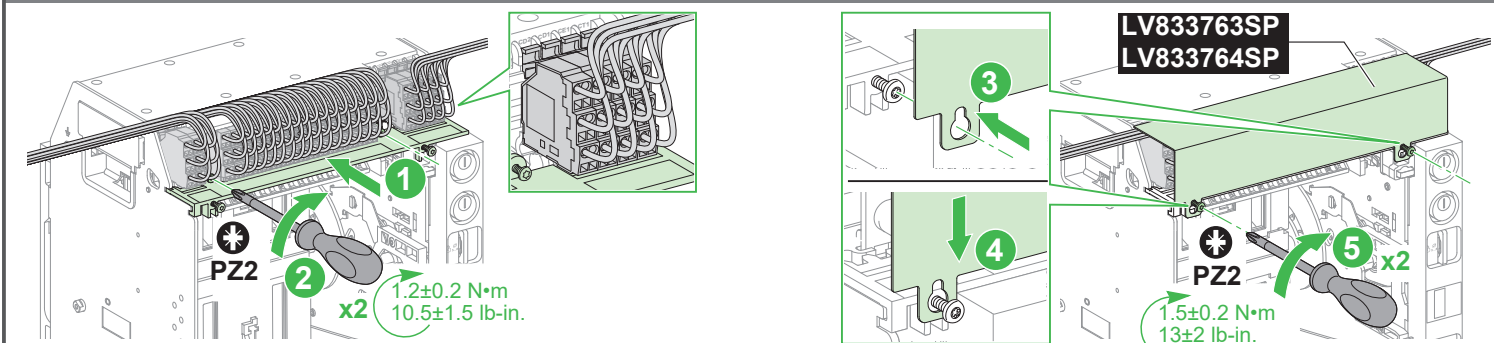

5.6 Removal / Démontage / Extracción / Entfernen / Rimozione / Remoção / Извлечение / 拆卸

- |  |  |   |  |
|--|--|---|--|
| <b>en</b> Remove in reverse order of installation.                           | <b>fr</b> Démontez dans l'ordre inverse de l'installation. | <b>es</b> Realice la extracción en el orden inverso al de la instalación. | <b>de</b> Führen Sie die Entfernung in umgekehrter Reihenfolge zur Installation durch. |
| <b>it</b> Per la rimozione procedere nell'ordine inverso dell'installazione. | <b>pt</b> Remova pela ordem inversa da instalação.         | <b>ru</b> Извлечение производят в порядке, обратном порядку установки.    | <b>zh</b> 拆卸步骤与安装步骤相反。   |

## 6.1 Terminal Blocks / Borniers / Borneros / Klemmleisten / Morsettiere / Blocos de terminais / Клеммные коробки / 端子板

### 6.1.1 Without EIFE / Sans EIFE / Sin EIFE / Ohne EIFE / Senza EIFE / Sem EIFE / Без EIFE / 不带 EIFE

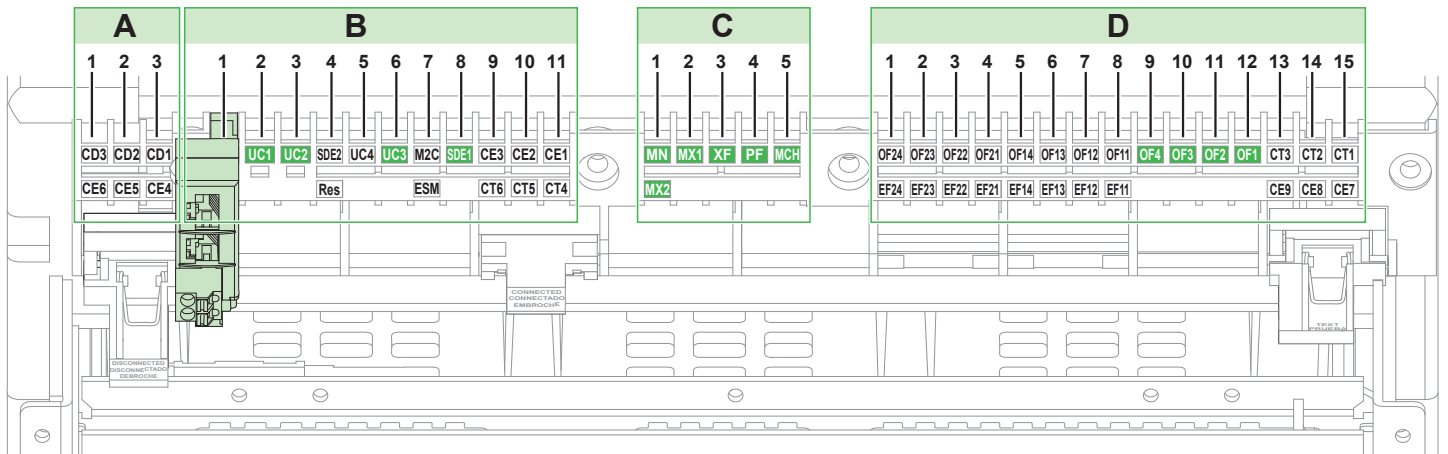

A		B		C		D					
1	CD3 / CE6 / -	LV833170SP / 171SP		MTZ2/MTZ3 + MicroLogic X		1	MN (1) / MX2 (1) / -	LV847849SP			
2	CD2 / CE5 / -	LV833170SP / 171SP		1	ULP port (3)	LV850062SP	2	MX1 (1) / -	LV847849SP		
3	CD1 / CE4 / -	LV833170SP / 171SP		MTZ2/MTZ3 + MicroLogic Active		1	24 V $\overline{\text{---}}$ (3)	LV847075SP	3	XF (1) / -	LV847849SP
		2	UC1 (1)	LV847850SP	2	24 V $\overline{\text{---}}$ (3)	LV847075SP	4	PF (1) / -	LV847849SP	
		3	UC2 (1)	LV847850SP	3	UC1 (1)	LV847850SP	5	MCH (1) / -	LV847849SP	
		4	SDE2 / RES / -	LV847849SP	4	UC2 (1)	LV847850SP				
		5	UC4 / -	LV847849SP	5	SDE2 / RES / -	LV847849SP				
		6	UC3 (2) / -	LV847849SP	6	UC4 / -	LV847849SP				
		7	M2C / ESM	LV847849SP	7	UC3 (2) / -	LV847849SP				
		8	SDE1 (1)	LV847849SP	8	M2C / ESM	LV847849SP				
		9	CE3 / CT6 / -	LV833170SP / 171SP	9	SDE1 (1)	LV847849SP				
		10	CE2 / CT5 / -	LV833170SP / 171SP	10	CE3 / CT6 / -	LV833170SP / 171SP				
		11	CE1 / CT4 / -	LV833170SP / 171SP	11	CE2 / CT5 / -	LV833170SP / 171SP				
					12	CE1 / CT4 / -	LV833170SP / 171SP				
					13	CT3 / CD6 / CE9 / -	LV833170SP / 171SP				
					14	CT2 / CD5 / CE8 / -	LV833170SP / 171SP				
					15	CT1 / CD4 / CE7 / -	LV833170SP / 171SP				

- en** (1) Supplied as standard  
 (2) Supplied as standard with 3P chassis only  
 (3) ● ULP port supplied as standard with chassis for MTZ2/MTZ3 circuit breakers with MicroLogic X control unit only  
 ● 24 V $\overline{\text{---}}$  terminal block supplied as standard with chassis for MTZ2/MTZ3 circuit breakers with MicroLogic Active control unit only

- fr** (1) Livré en standard  
 (2) Livrés en standard avec les châssis 3P uniquement  
 (3) ● Port ULP livré en standard avec les châssis pour les disjoncteurs MTZ2/MTZ3 avec l'unité de contrôle MicroLogic X uniquement  
 ● Bornier 24 V $\overline{\text{---}}$  livré en standard avec les châssis pour les disjoncteurs MTZ2/MTZ3 avec l'unité de contrôle MicroLogic Active uniquement

- es** (1) Suministrados de serie  
 (2) Suministrados de serie sólo con el chasis 3P  
 (3) ● Puerto ULP suministrado de serie con el chasis para interruptores automáticos MTZ2/MTZ3 con unidad de control MicroLogic X únicamente  
 ● Terminales de 24 V $\overline{\text{---}}$  incluido de serie con el chasis para los interruptores automáticos MTZ2/MTZ3 con unidad de control MicroLogic Active únicamente

- de** (1) Standardmäßig mitgeliefert  
 (2) Standardmäßig im Lieferumfang der 3P-Einschubkassette enthalten  
 (3) ● ULP-Schnittstelle, Standardausstattung der Einschubkassette für Leistungsschalter MTZ2/MTZ3 nur mit Steuer- und Auslösegerät MicroLogic X  
 ● Klemmleiste 24 V $\overline{\text{---}}$ , Standardausstattung der Einschubkassette für Leistungsschalter MTZ2/MTZ3 nur mit Steuer- und Auslösegerät MicroLogic Active

- it** (1) Fornito in dotazione  
 (2) Fornito come standard solo con il telaio 3P  
 (3) ● Porta ULP in dotazione con telaio per interruttori MTZ2/MTZ3 solo con unità di controllo MicroLogic X  
 ● Morsettiere 24 V $\overline{\text{---}}$  in dotazione con telaio per interruttori MTZ2/MTZ3 solo con unità di controllo MicroLogic Active

- pt** (1) Fornecido como padrão  
 (2) Providenciado como standard somente com chassis 3P  
 (3) ● Porta ULP fornecida de origem com chassis para disjuntores MTZ2/MTZ3 apenas com uma unidade de controle MicroLogic X  
 ● Bloco de terminais de 24 V fornecido de origem com chassis para disjuntores MTZ2/MTZ3 apenas com unidade de controle MicroLogic Active

- ru** (1) Поставляется стандартно  
 (2) Поставляется стандартно только с шасси 3P  
 (3) ● Порт ULP поставляется в стандартной комплектации с шасси для автоматических выключателей MTZ2/MTZ3 только с блоком управления MicroLogic X  
 ● Клеммный блок 24 V $\overline{\text{---}}$  поставляется в стандартной комплектации с шасси для автоматических выключателей MTZ2/MTZ3 только с активным блоком управления MicroLogic

- zh** (1) 标配  
 (2) 仅 3P 抽架的标配  
 (3) ● ULP 端口作为抽架的标配, 仅适用于配备 MicroLogic X 控制单元的 MTZ2/MTZ3 断路器  
 ● 24 V $\overline{\text{---}}$  接线端子作为抽架的标配, 仅适用于, 配备 MicroLogic Active 控制单元的 MTZ2/MTZ3 断路器

## 6.1.2 With EIFE / Avec EIFE / Con EIFE / Mit EIFE / Con EIFE / Com EIFE / C EIFE / 帶 EIFE

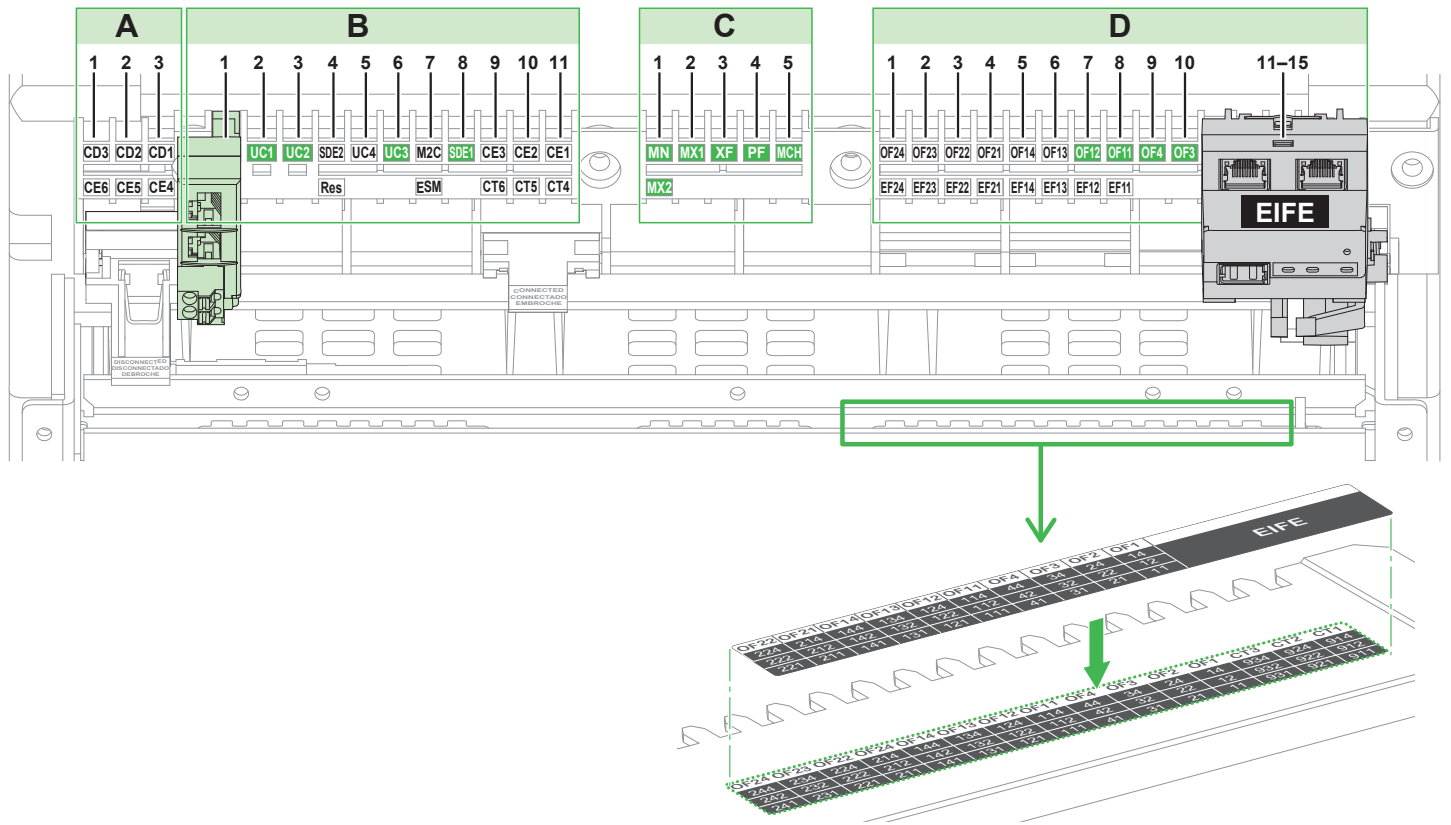

A	
1	CD3 / CE6 / - LV833170SP / 171SP
2	CD2 / CE5 / - LV833170SP / 171SP
3	CD1 / CE4 / - LV833170SP / 171SP

B	
1	ULP port (3) LV850062SP
2	UC1 (1) LV847850SP
3	UC2 (1) LV847850SP
4	SDE2 / Res / - LV847849SP
5	UC4 / - LV847849SP
6	UC3 (2) / - LV847849SP
7	M2C / ESM LV847849SP
8	SDE1 (1) LV847849SP
9	CE3 / CT6 / - LV833170SP / 171SP
10	CE2 / CT5 / - LV833170SP / 171SP
11	CE1 / CT4 / - LV833170SP / 171SP

C	
1	MN (1) / MX2 (1) / - LV847849SP
2	MX1 (1) / - LV847849SP
3	XF (1) / - LV847849SP
4	PF (1) / - LV847849SP
5	MCH (1) / - LV847849SP

D	
1	OF22 / EF24 / - LV847849SP / LV848477SP / 478SP
2	OF21 / EF23 / - LV847849SP / LV848477SP / 478SP
3	OF14 / EF22 / - LV847849SP / LV848477SP / 478SP
4	OF13 / EF21 / - LV847849SP / LV848477SP / 478SP
5	OF12 / EF14 / - LV847849SP / LV848477SP / 478SP
6	OF11 / EF13 / - LV847849SP / LV848477SP / 478SP
7	OF4 (1) LV847849SP
8	OF3 (1) LV847849SP
9	OF2 (1) LV847849SP
10	OF1 (1) LV847849SP
11	
12	
13	EIFE LV851200SP
14	
15	

- en** (1) Supplied as standard  
 (2) Supplied as standard with 3P chassis only  
 (3) Supplied as standard with chassis for MTZ2/MTZ3 circuit breakers only

- fr** (1) Livré en standard  
 (2) Livrés en standard avec les châssis 3P uniquement  
 (3) Livrés en standard avec les châssis pour les disjoncteurs MTZ2/MTZ3 uniquement

- es** (1) Suministrados de serie  
 (2) Suministrados de serie sólo con el chasis 3P  
 (3) Suministrados de serie sólo con el chasis para interruptores automáticos MTZ2/MTZ3

- de** (1) Standardmäßig mitgeliefert  
 (2) Standardmäßig im Lieferumfang der 3P-Einschubkassette enthalten  
 (3) Nur für MTZ2/MTZ3-Leistungsschalter standardmäßig im Lieferumfang der Einschubkassette enthalten

- it** (1) Fornito in dotazione  
 (2) Fornito come standard solo con il telaio 3P  
 (3) Fornito come standard con il telaio solo per interruttori MTZ2/MTZ3

- pt** (1) Fornecido como padrão  
 (2) Providenciado como standard somente com chassis 3P  
 (3) Providenciado como standard com chassis somente para disjuntores MTZ2/MTZ3

- ru** (1) Поставляется стандартно  
 (2) Поставляется стандартно только с шасси 3P  
 (3) Поставляется стандартно с шасси только для автоматических выключателей MTZ2/MTZ3

- zh** (1) 标配  
 (2) 仅 3P 抽架的标配  
 (3) 仅 MTZ2/MTZ3 断路器用抽架的标配

6.2 Auxiliary Terminal Shields Removal / Démontage des capots bornier auxiliaire / Extracción de los cubrebornes auxiliares / Entfernen der Abdeckung der Zubehöranschlussklemmen / Rimozione protezione sulla morsettiere ausiliaria / Remoção das blindagens dos terminais auxiliares / Снятие вспомогательных электроизоляторов клемм / 拆除二次接线端子盖板

LV864942SP  
LV848596SP  
LV848597SP  
LV848598SP

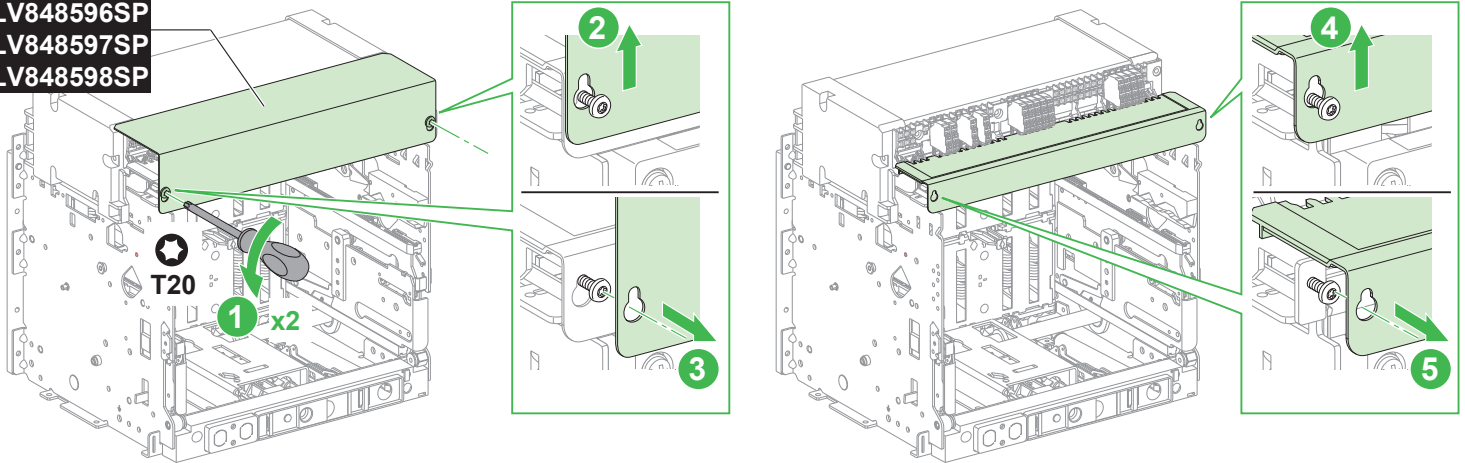

6.3 Installation / Installation / Instalación / Installation / Installazione / Instalação / Установка / 安装

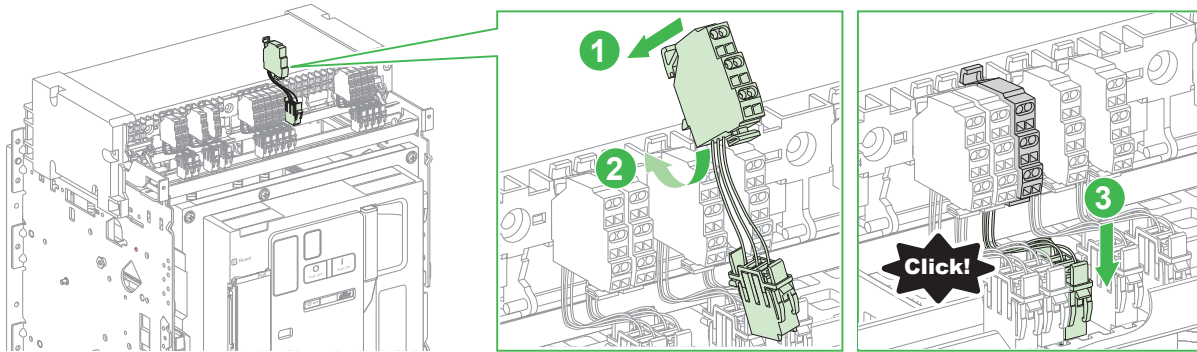

6.4 Wiring / Câblage / Cableado / Verkabelung / Cablaggio / Cablagem / Кабель / 电缆

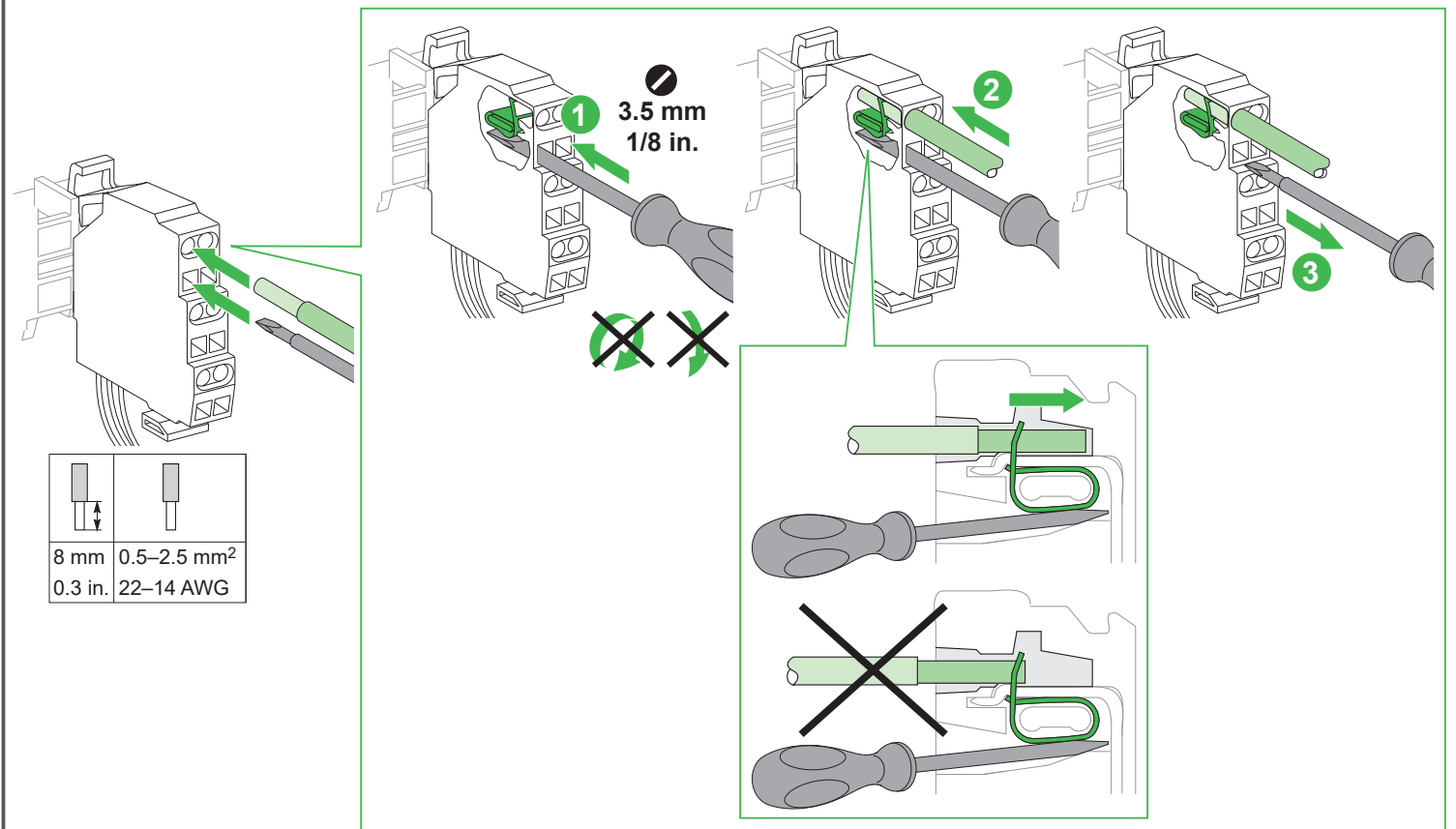

6.5 Auxiliary Terminal Shields Installation / Installation des capots bornier auxiliaire / Instalación de los cubrebornes auxiliares / Installation der Abdeckungen der Zubehöranchlussklemme / Installazione delle schermature dei morsetti ausiliari / Instalação das blindagens do terminal auxiliar / Установка вспомогательных электроизоляторов клемм / 辅助端子屏蔽罩安装

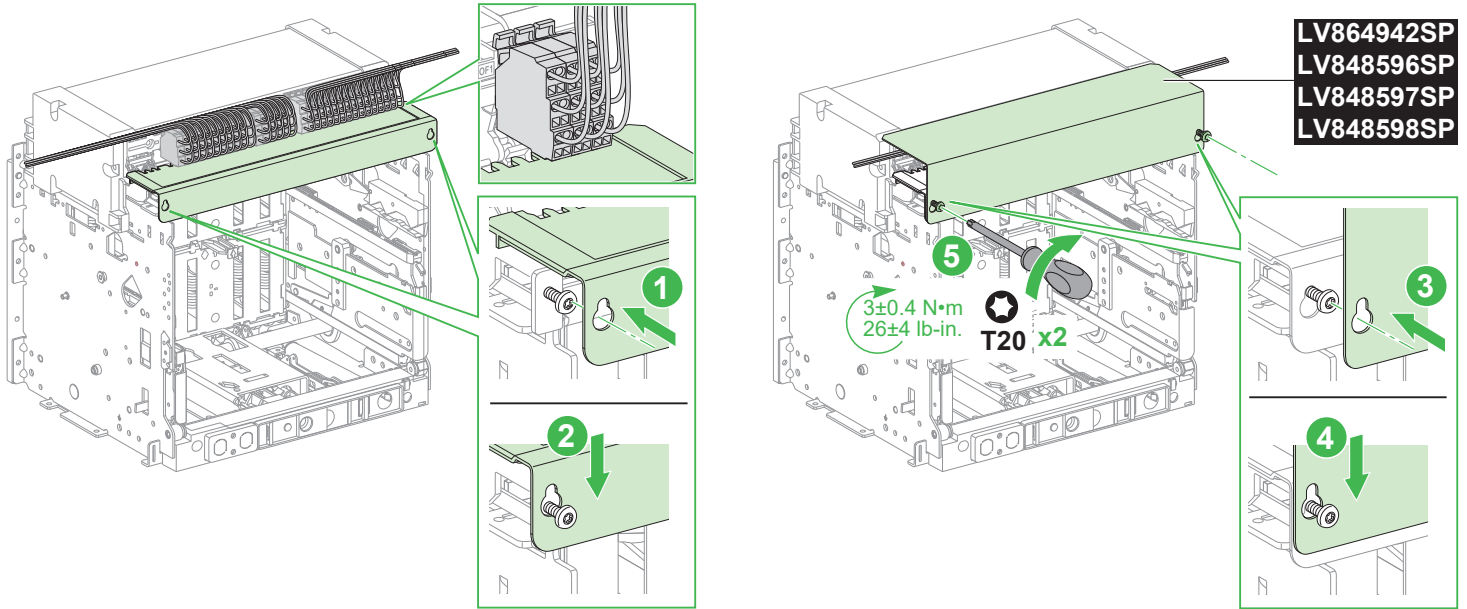

6.6 Removal / Démontage / Extracción / Entfernen / Rimozione / Remoção / Извлечение / 拆卸

- |   |   |   |   |
|---|---|---|---|
| <p><b>en</b> ● Put the circuit breaker in the test position. Check the service instructions supplied with the circuit breaker.</p> <p>● Remove the contact according to the instructions below.</p>     | <p><b>fr</b> ● Mettez le disjoncteur en position test, consultez l'instruction de service livrée avec le disjoncteur.</p> <p>● Démontez le contact en suivant les instructions ci-dessous.</p>          | <p><b>es</b> ● Coloque el interruptor automático en la posición de pruebas. Consulte las instrucciones de servicio suministradas con el interruptor automático.</p> <p>● Extraiga el contacto según las instrucciones siguientes.</p> | <p><b>de</b> ● Bewegen Sie den Leistungsschalter in die Teststellung. Ziehen Sie die Service-Anweisungen zu Rate, die im Lieferumfang des Leistungsschalters enthalten waren</p> <p>● Entfernen Sie den Kontakt wie in den Anweisungen unten angegeben.</p> |
| <p><b>it</b> ● Mettere l'interruttore nella posizione di test. Controllare le istruzioni di servizio fornite con l'interruttore.</p> <p>● Rimuovere il contatto in base alle istruzioni di seguito.</p> | <p><b>pt</b> ● Coloque o disjuntor na posição de teste. Verifique as instruções de assistência fornecidas com o disjuntor.</p> <p>● Retire o contacto de acordo com as instruções indicadas abaixo.</p> | <p><b>ru</b> ● Переведите автоматический выключатель в положение «испытание». Сверьтесь с инструкциями по обслуживанию.</p> <p>● Снимите контакт согласно инструкциям ниже.</p>   | <p><b>zh</b> ● 将断路器置于测试位置。查阅维护说明书</p> <p>● 按照下文说明拆除触点。</p>  |

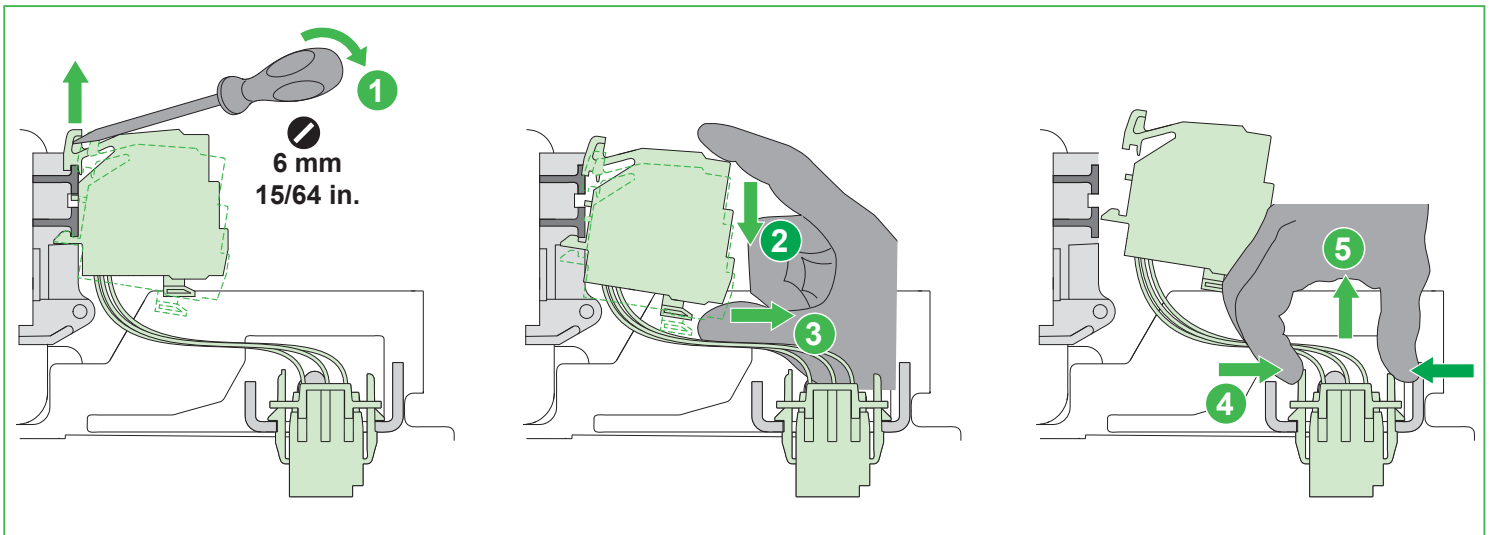

**Schneider Electric Industries SAS**  
35, rue Joseph Monier  
CS 30323  
F - 92506 Rueil Malmaison Cedex  
[www.se.com](http://www.se.com)



<p><b>Schneider Electric Limited</b> Stafford Park 5 Telford, TF3 3BL United Kingdom <a href="http://www.se.com/uk">www.se.com/uk</a></p>	<p><b>UK CA</b></p>
---	-------------------------