

EcoStruxure™
Innovation At Every Level



Green
Premium™

Sustainable
performance,
by design

PowerLogic™ T300

Catalog 2024
Remote Terminal Unit



se.com/PowerLogicT300

Life Is On

Schneider
Electric

Notes



General Contents

General presentation 8

Functions and description 22

Cabinet and Smart RMU Solution 130

Accessories 136

Schneider Electric Service 142

Commercial references 146

Answer the challenges of today, and tomorrow.

Electrical distribution networks must transition to next-generation technology in order to face the challenges of modern grid applications, such as growing energy demand, stricter CO₂ emission limits, and tight constraints on operational expenditure (OpEx).



Grid evolution

Support the integration of distributed energy resources (DER) and electric vehicles (EVs).

Downtime tolerance

Minimize power supply interruptions and manage increasing energy demand.

Quality requirements

Help ensure grid performance meets customer and regulatory needs.

Cost optimization

Maintain aging infrastructure while expanding installations and operations.

Need for efficiency

Manage base and peak load consumption effectively.

Cyber threats

Comply with the latest standards and reduce risks from cyber-attacks.

PowerLogic™ feeder automation solutions can help any distribution network answer these challenges.

The new benchmark in distribution network automation

One modern Feeder RTU to answer your evolving challenges and prepare your business for the future.



PowerLogic™ T300



Developed as per IEC 62443-4-2, PowerLogic™ T300 has been designed with a cyber security package. This shall help reduce exposure to cyber threats and improved operational security. It includes important features such as password management, firmware signature, port hardening, and secured communication compliant to the latest international standards.

Evolve with the grid: manage bidirectional and intermittent power flow

- Detect overcurrent faults including grid with interconnected distributed energy resource units
- Detect broken conductors and voltage loss

Increase availability: improve SAIDI and optimize MV and LV networks

- Detect medium-voltage (MV) faults by current and voltage measurements to reduce outage time
- Reconfigure the network automatically after a MV fault (in centralized, semi centralized or decentralized approaches)
- Reduce low-voltage (LV) outage durations by blown fuse detection

Maintain quality: deliver MV and LV stability

- Accommodate demand growth
- Measure MV and LV voltage accurately for Volt-Var optimization
- Detect neutral cut out at transformer level

Manage costs: reduce installation, operation, and maintenance expenditures

- Optimize investment with modular automation solutions
- Enable remote and local operation and asset management including firmware and configuration update
- Save cost on spare parts, training, and operation of personnel by using a single platform for multiple applications
- Substation asset management based on thermal and environmental monitoring

Deliver efficiency: optimize networks to manage growing consumption

- Monitor transformers and substations to optimize asset management
- Reduce both technical and non-technical losses
- Manage load shedding and peak shaving

Improve Cybersecurity: help defend against malicious software and unauthorized access

- As per IEC 62443, IEC 62351 and IEEE 1686
- SCADA communication and Wi-Fi Access security features

Take the PowerLogic™ T300 further with EcoStruxure™

500 000

EcoStruxure™ has been deployed in almost 500 000 sites with the support of 20 000+ developers, 650 000 service providers and partners, 3 000 utilities, and connects over 2 million assets under management.

EcoStruxure™ ready



Efficient asset management

Greater efficiency with **predictive** maintenance helping to reduce downtime



24/7 connectivity

Real-time data **everywhere anytime** to make better-informed decisions



Increased safety

Proven design and experience combined with fast **embedded arc detection** to enhance people's safety and equipment's protection

EcoStruxure™ is our open, interoperable, IoT-enabled system architecture and platform. EcoStruxure delivers enhanced value around **safety, reliability, efficiency, sustainability, and connectivity** for our customers. EcoStruxure leverages advancements in IoT, mobility, sensing, cloud, analytics, and cybersecurity to deliver Innovation at Every Level. This includes Connected Products, Edge Control, and Apps, Analytics & Services which are supported by Customer Lifecycle Software.

Turn data into action

EcoStruxure™ architecture lets customers maximize the value of data.

Specifically, it helps them:

- Translate data into actionable intelligence and better business decisions
- Take informed decisions to secure uptime and operational efficiency thanks to real-time control platforms
- Gain visibility to their electrical distribution by measuring, collecting, aggregating, and communicating data

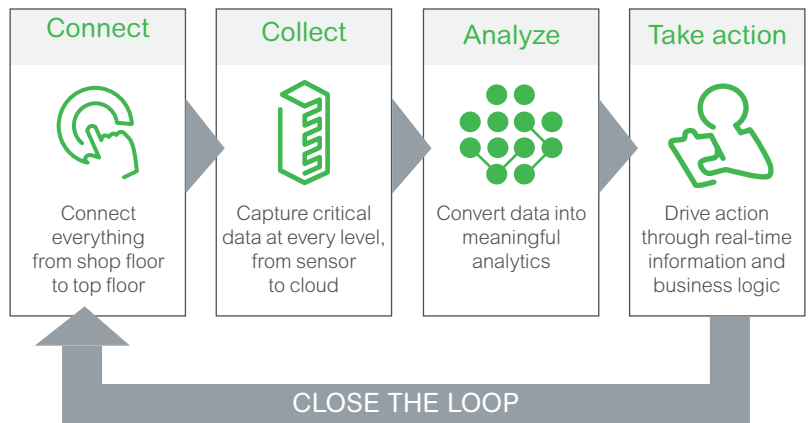

EcoStruxure™ Innovation At Every Level

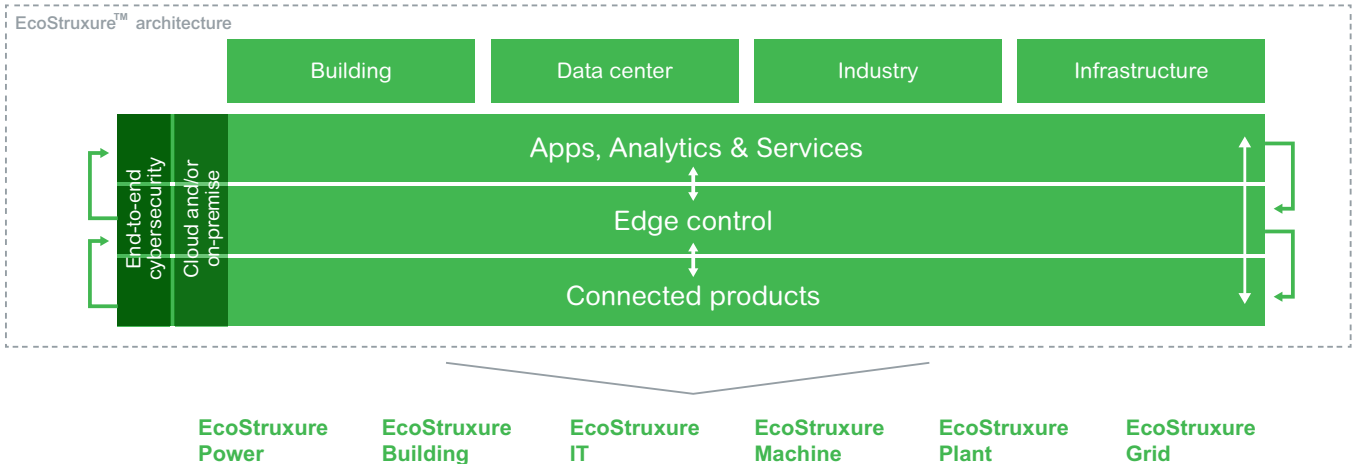

Notes

General presentation

General presentation

Main applications	10
<hr/>	
Applications	12
Network control application	12
PowerLogic™ T300 typical applications	13
<hr/>	
Product overview	14
The modules	15
Configurable solutions	17
Installation and update	18
Lifecycle tools	19
Remote devices management system	20

Utilities

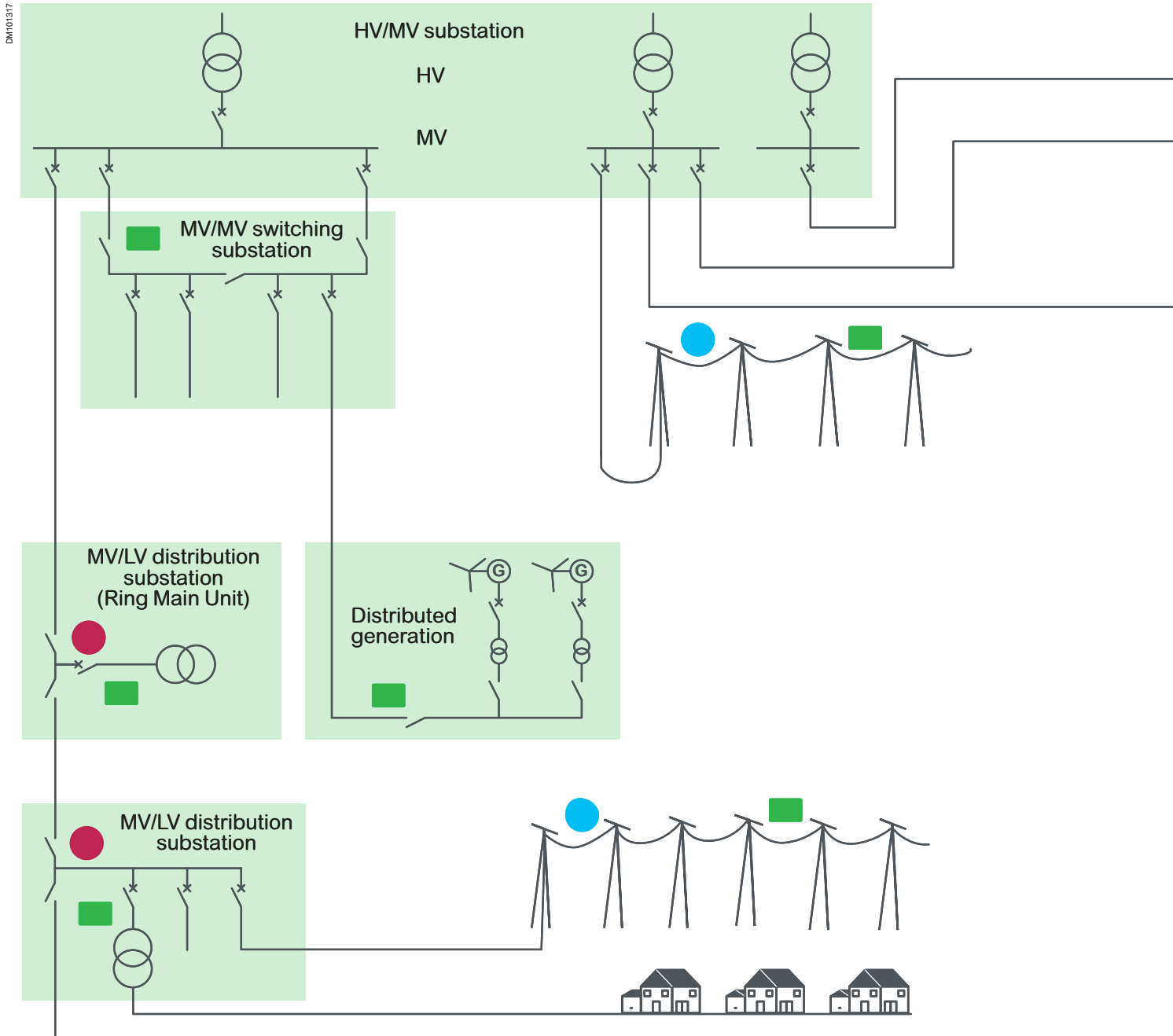

Main applications

Buildings & Industry

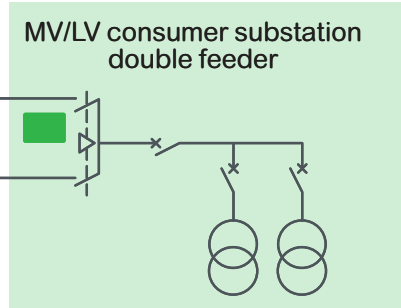

PM104388



PowerLogic™ T300

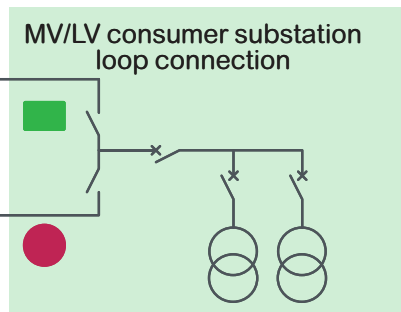

PM108149



PowerLogic™ Flite

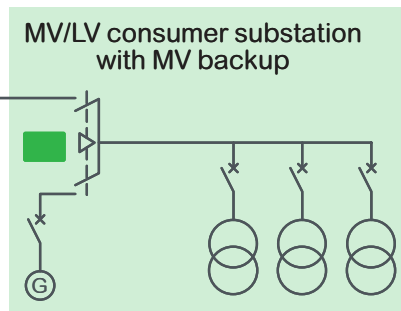

PE415848



PowerLogic™ Flair

Operating an electrical distribution grid is an increasingly complex business. The challenges posed by growing demand, integration of distributed generation resources, and aging infrastructure – to name just a few – each affect overall grid reliability and customer satisfaction.

Grid operators face these challenges in order to boost efficiency, help protect their customers and avoid regulatory scrutiny, but it's not easy.

Deployment of network controls that require large capital expenditures is problematic. Also problematic is the speedy replacement or motorizing of existing, outdated substations.

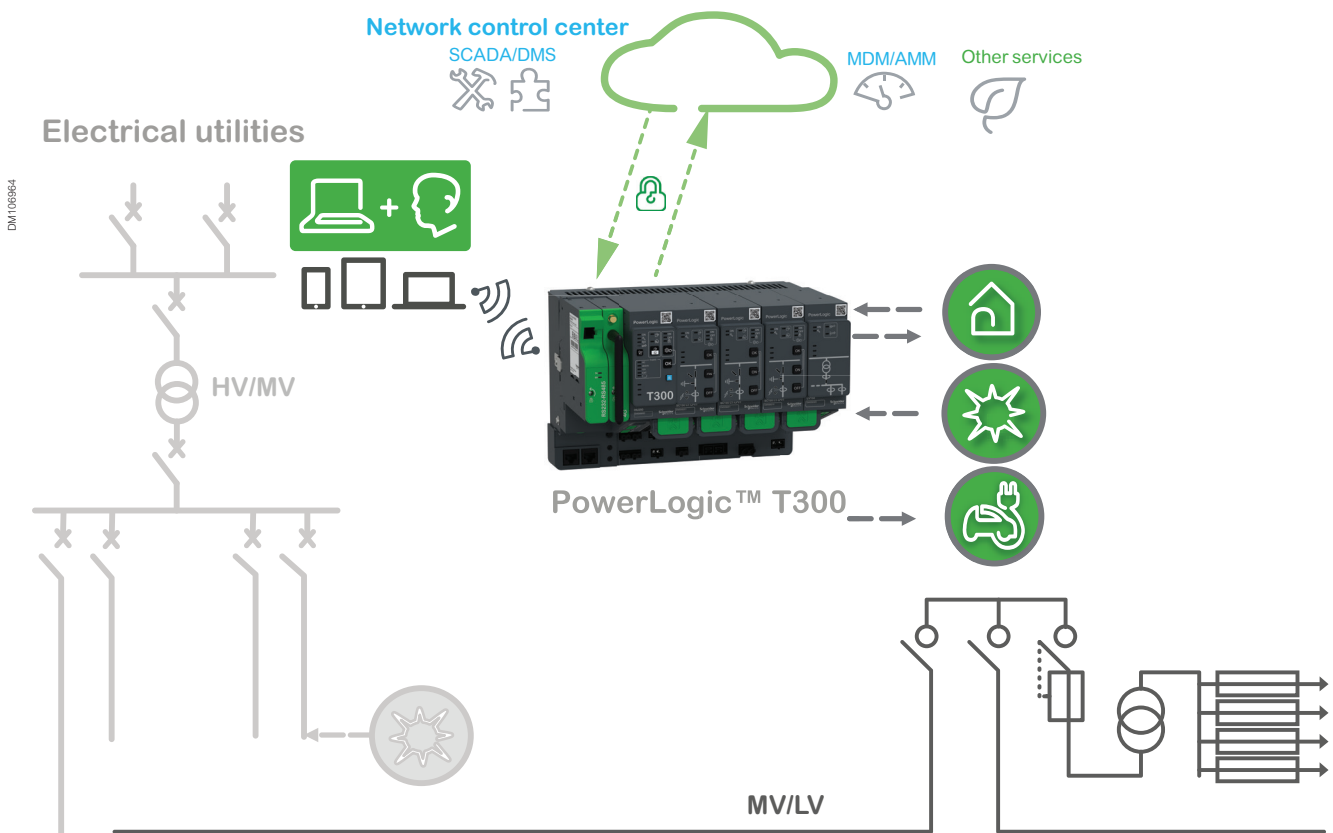

PowerLogic™ T300 keys grid control applications

use:

- Centralized grid control as MV substation controller and power monitor
- Decentralized automation network reconfiguration such as sectionalized or Auto Transfer Source
- Decentralized network reconfiguration with self healing applications
- Reduce outage time and network losses
- Improve Volt var management
- Improve fault management
- Improve power quality
- Cut down maintenance costs
- Optimize investments
- Compliance with latest polices and standards such as cyber security and IEC 61850

PowerLogic™ T300 is a modular platform, hardware, firmware, and an application building block for Medium Voltage and Low Voltage public distribution network management. It offers a single solution for controlling and monitoring, from a simple pole-top device to a large MV/MV or MV/LV substation.

With its flexible approach, PowerLogic™ T300 provides optimized solutions for many controlling or monitoring distribution applications. Typical applications include:

MV/LV kiosks and chamber substations

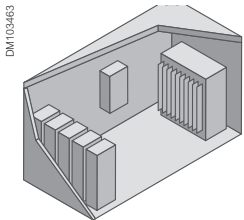

- MV remote control and automatic network reconfiguration capabilities
- MV feeder over-current fault detection
- MV feeder and transformer Circuit-breaker protection
- Broken conductor detection on MV & LV side
- LV monitoring
- Volt Var optimization support
- Thermal and environment condition monitoring

Pole top application Load Break Switch controller

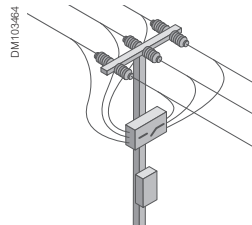

- Load break switch monitoring and control
- Automatic network reconfiguration capabilities
- Over-current fault detection
- MV broken conductor detection
- Volt Var optimization support

Pole top and pad mounted transformer monitoring

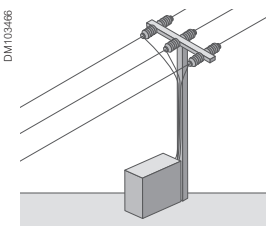

- MV and LV broken conductor detection
- Blown fuse detection
- Thermal transformer monitoring
- LV load flow monitoring
- Volt Var optimization support

LV distribution networks

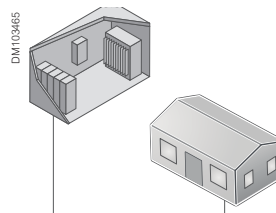

- LV broken conductor detection
- Neutral cutout
- Load monitoring
- Volt Var optimization support

Distributed Energy Resources grid connection monitoring and control

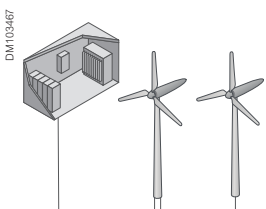

- Protection relay connection as per IEC 61850
- Utilities interface
- MV incomer control
- Directional active overpower detection
- Volt Var optimization support

MV Line and end of line monitoring

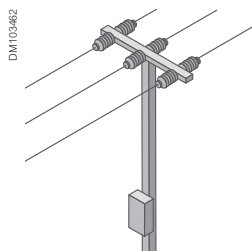

- MV broken conductor detection
- MV fault detection
- Volt Var optimization support

Product overview

Modular architecture

PowerLogic™ T300 is modular and application-oriented.

This open architecture supports different applications, from a single communication gateway to large substation management with third-party devices.

DM107257

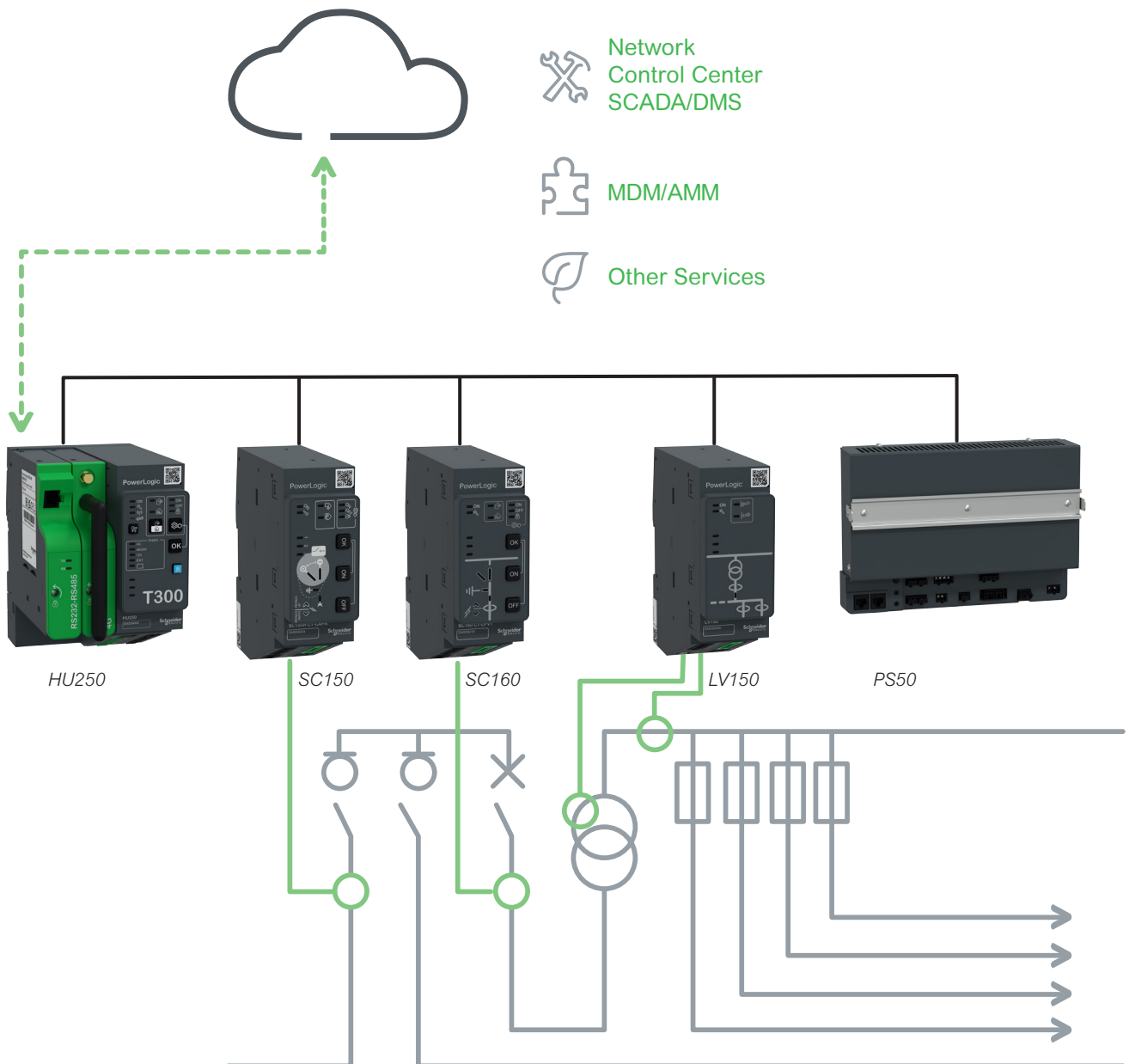

The modules, with their supported applications, are:

PowerLogic™ HU250 – Head Unit communication gateway

- Flexible communication gateway to control center and other customer IT applications
 - Standard and security-focused protocols: IEC 101/104, DNP3, IEC 61850, Modbus
 - Open peer-to-peer communication to support self-healing application
 - Flexible communication media (Ethernet, RS 232, 3G, 4G)
- Flexible local communication (Ethernet, Wi-Fi, ZigBee, RS232)
- Cybersecurity management as per IEC 62443-4-2
- Open to third-party devices with many protocol capabilities
- Built-in webserver for commissioning and maintenance with local and remote access, compatible with PC, tablet and smartphone devices
- Embedded IEC 601131-3 PLC for automation design
- Auto-Transfer-Switch Automation between two switch control modules
- Condition monitoring, thermal and environment with integration of wireless sensors communication

PM104385



PM104382



PowerLogic™ SC150 – Switchgear controller

- Control and monitoring of all switchgear types
- Advanced Fault Passage Indicator (FPI) algorithms:
 - Phase-phase and phase-ground detection ANSI 50/51, 50N/51N
 - Directional phase-phase and phase-ground detection ANSI 67/67N
 - Broken conductor detection (one phase lost) ANSI 47
- MV Voltage monitoring ANSI 27, 59, 59N
- MV Current monitoring ANSI 37
- Directional active overpower detection ANSI 32P
- Large current and voltage measurement capabilities: standard CT for current, LPVT, VT and from capacitor divider and voltage presence indicator (VDS, VPIS) for voltage
- Power measurement as per IEC 61557-12
- Power quality as per IEC 61000-4-30 class S:
- Specific application automation: sectionalizer
- Disturbance recording

PM108159



PowerLogic™ SC160 – Switchgear control, protection unit

PowerLogic™ SC160 is a modular switchgear controller configurable as protection with Circuit Breaker (CB) use or Fault current indicator with Low Break Switch (LBS) use.

- Control and monitoring of all switchgear types
- Protection or fault passage indication function :
 - Phase overcurrent (ANSI 50/51)
 - Ground/earth fault overcurrent (ANSI 50N/51N)
 - Directional phase overcurrent fault (ANSI 67)

Product overview

The modules

- Directional ground/earth fault overcurrent (ANSI 67N)
- Cold load pickup
- Inrush restraint
- MV Voltage monitoring ANSI 27, 47BC, 59, 59N
- MV Current monitoring ANSI 37
- Directional active overpower detection ANSI 32P
- Large current and voltage measurement capabilities: standard CT for current, LPVT, VT and from capacitor divider and voltage presence indicator (VDS, VPIS) for voltage
- Power measurement as per IEC 61557-12
- Power quality as per IEC 61000-4-30 class S
- Specific application automation: sectionalizer
- Disturbance recording

PowerLogic™ LV150 – Transformer and Low Voltage monitoring

- Transformer temperature measurement and monitoring
- Power measurement as per IEC 61557-12
- Broken conductor detection (one phase lost MV or LV) ANSI 47
- LV Voltage monitoring ANSI 27, 59, 59N
- Power quality as per IEC 61000-4-30 class S



Easergy PS50 – Power Supply for control and monitoring solutions

PS50 is specially designed for MV distribution equipment with a harsh environment. PS50 is a backup power supply with full battery management to operate the substation during the power outage:

- Switch control: 48 Vdc or 24 Vdc
- Telecom devices: 12 Vdc
- PowerLogic™ T300 modules: 12 Vdc



Wireless monitoring

- **CL110** for environment monitoring: Temperature and humidity sensors measure condensation, allowing users to detect fast aging conditions
- **TH110** for thermal monitoring: Sensors detect hotspots requiring maintenance at cable connections, enabling users to take preventive action.



Product overview

Configurable solutions

PowerLogic™ T300 is a powerful feeder RTU delivering three configurable solutions to fit your exact needs.

Choose from ready-to-use solutions, tailored integrations, or those for substation retrofits

All PowerLogic™ T300 modules offer DIN rail mounting for flexible RTUs integration design. Many accessories and sensors, available in the catalog, allow fast integration in any kind of application.



PM106098

Ready-to-use solution

A variety of ready-to-use solutions are available off-the-shelf for fast delivery and installation, and are also available for retrofit.

The PowerLogic™ T300 configurator allows you to quickly build your RTU configuration (hardware and software).

You can consult our engineering centers to design or customize a dedicated solution.

Two types of enclosure are available as standard, depending on the installation environment:

- Indoor controller cabinet
- Outdoor controller cabinet, wall mounting or pole mounting



PM106833

Smart seamless integration of RMU and RTU

The smart ring main unit (smart RMU) is an innovative solution that makes it easier for you to answer the evolving challenges of secondary electrical distribution.

Building on our proven RMUs – the RM6, FBX, and Ringmaster, Schneider Electric's smart RMUs are seamlessly integrated with the PowerLogic™ T300.

Customizable to your needs, the smart RMU offers a wide range of basic and advanced capabilities.



PM104388

Open solution

A completely tailored and configured solution can be designed by Schneider or our Partner to build custom or local design.

- New enclosure
- Retrofit in existing cabinet

Product overview

Installation and update

Fast and easy installation and update in one click without dedicated tools.

HU250, SC150 (x3) and LV150

mounted on PS50 with friendly HMI for local operation

2 flexible communication modem boxes

PS50

in background with voltage output and battery connector



Removable connectors

for switchgear interface and sensors

Ethernet jumper

between modules for quick installation and update

PowerLogic™ T300 benefits

- Easy and fast ordering and delivery
- Ease of installation and commissioning
- Very small foot-print for small substations and switchgear cabinets
- Flexible solution adapted to your requirements
- One hardware and software platform for all applications
- Easy on-site updating

PowerLogic™ T300 offers several tools for the different stages of the lifecycle of the product.

Access is possible locally and remotely. Local access can be made by Wi-Fi or cable.

PowerLogic™ T300 is supplied with a standard configuration or a dedicated customer configuration.

Commissioning and maintenance do not require special tools, only a web browser on a PC, tablet or smartphone.

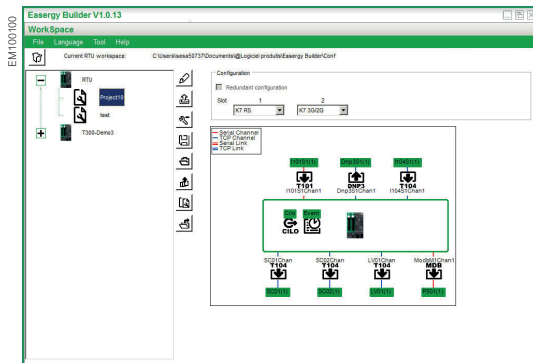

Easergy Builder for engineering teams

Easergy Builder is used by expert engineering teams to modify or design new databases off line:

- Import new automation designed in IEC 61131-3 PLC workshop
- Configure new communication channels
- Integrate new third part IEDs
- Design new databases

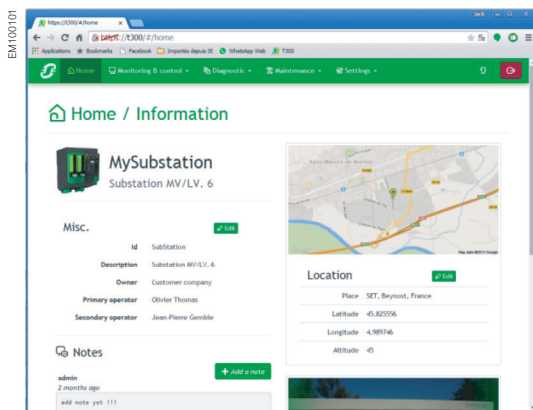

Embedded web server for commissioning, exploitation and maintenance

The operations from the web server, according to the defined level of access, are:

- View the status of the substation: substation view diagram, system view, events log file, measure log file, alarms
- Modify settings: Fault Passage Indicator, automation, communication
- Upload and download firmware and configuration data base
- Modify security access features

Web server

EcoStruxure™ Power Automation System Maintenance

Power Automation System Maintenance Tool provides a vendor agnostic Inventory Baseline Management software, capable to perform maintenance on connected equipment in a heterogenous multi-vendor solution with a focus on Cyber Security.

Tracking maintenance relevant information from IEC 61850 relays.

Centralized cyber security management for modern networks.

Automated System wide disturbance recorder management.

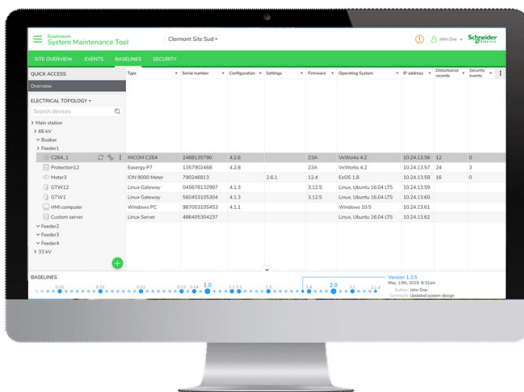
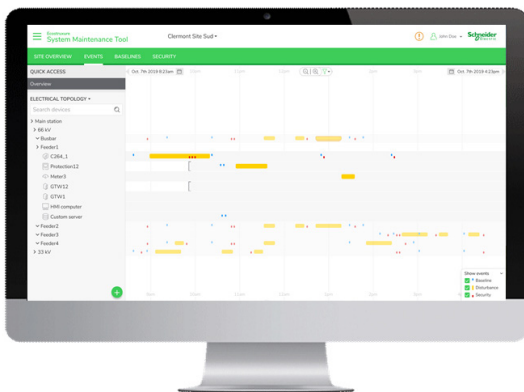

Data Management

- Store & Backup while tracking evolution of Firmware, Configuration, Setting Files and Documentation. **Available Now!**
- Perform System Level Version Baselineing by group multiple artifacts. **Available Now!**
- Monitor Real Time changes firmware & configuration version for connected Devices. (IEC 61850, SNMPV3, DPWS, FTP). **Coming Soon!**
- Manage T300 & C264 firmware and configuration upload. **Coming Soon!**

Cyber Security

- Manage Role-Based Access Configurations for Schneider Electric Devices. **Coming Soon!**
- Collect Syslogs from Schneider Electric Connected Devices. **Coming Soon!**

Disturbance Recorder

- Automatically collect & store disturbance recorder files. **Coming Soon!**

Notes

Functions and description

Functions and description

PowerLogic™ HU250 Head Unit Communication	24
General description	25
Protocols & communication architecture	31
Time synchro & sequence of events	34
Cybersecurity	35
Automation	37
Open Programmable Logic Controller	39
Condition monitoring	40
Communication port characteristics	41
Characteristics	42
Configuration tools	44

PowerLogic™ SC150 Switchgear Controller Unit	48
General description	49
Network monitoring	57
MV Network management	67
MV Power monitoring	68
Characteristics	70

PowerLogic™ SC160 Switchgear Controller unit	74
General description	75
Network monitoring	84
MV Network management	94
MV Power monitoring	95
Characteristics	97

PowerLogic™ LV150 Low Voltage monitoring	102
General description	103
Connection	106
Network monitoring	107
Characteristics	109

Easergy PS50 Power Supply	116
General description	117
Power supply selection guide	119
Battery autonomy	123
Characteristics	126
Installation	128

PowerLogic™ HU250

Head Unit Communication

PowerLogic™ HU250 Head Unit Communication

General description

PowerLogic™ HU250 is a powerful and flexible communication gateway for all PowerLogic™ T300 configurations.

- PowerLogic™ HU250 can also be used as a standalone gateway for third-party IEDs
- Open to any communication system and protocol
- Compliant with Cybersecurity standards
- Advanced configuration tools
- Web server for easy commissioning and maintenance
- Open to IEC 61131 applications
- Easy remote and local firmware updates
- Wi-Fi access security

The PowerLogic™ Head Unit HU250 is the communication module of the PowerLogic™ T300.

PowerLogic™ HU250 manages:

- Cybersecurity management
- Communication with control center
- Communication with other substations (peer-to-peer communication)
- PowerLogic™ T300 modules gateway
- Local network communication with third-party IEDs
- Local and remote configuration access for all modules of PowerLogic™ T300
- Web server with local and remote access
- Automation system with programmable logic control
- Global function as remote/local operation, automation enable/disable
- Condition monitoring

The figure shows an example of the communication architecture and the capabilities of PowerLogic™ T300.

PM1104385

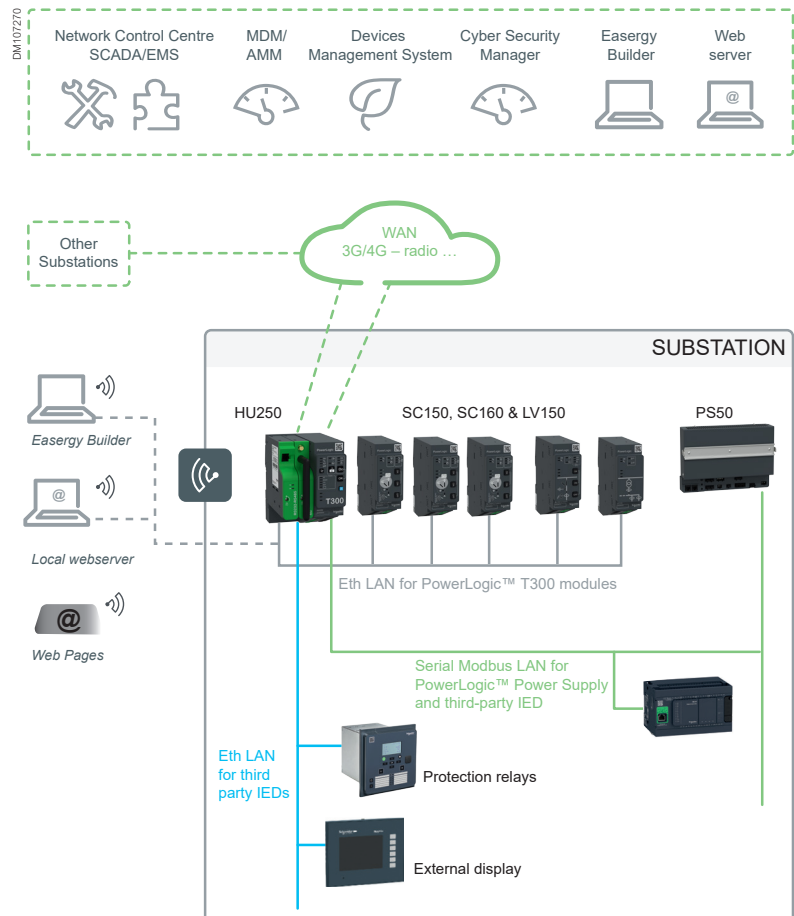

PowerLogic™ HU250 Head Unit Communication

General description

Part Number

Reference	Description
HU250	
EMS59000	PowerLogic™ HU250 Head Unit gateway
EMS59009	PowerLogic™ HU250 Head Unit communication gateway without wireless
EMS59150	Empty modem box for HU250
Modem	
EMS59151	RS232-485 box for HU250
EMS59155	3G/4G EU standard modem box for HU250
EMS59156	Zigbee receiver

Network control centers

This includes several types of remote control center from an entry-level SCADA like PowerLogic™ L500 to advanced ADMS systems.

MDM/AMM

Meter Data Management system/Advanced Meter Management: PowerLogic™ T300 can transfer some data as Low Voltage measurements to the metering system.

Cybersecurity manager

One aspect of improved Cybersecurity is to provide security for all control and data acquisition for the operation of the electrical system.

The Schneider Electric CAE is a security configuration tool to define/configure the security policy of the devices. It allows to create user account with password and allocated role.

Devices management system

PowerLogic™ T300 can also communicate with others services, such as EcoStruxure™ System Maintenance (ESM).

Easergy Builder

Easergy Builder is a PC-based engineering tool for PowerLogic™ T300 customization and design. Easergy Builder can be used locally via Wi-Fi or wired connection, or remotely via the WAN with a cybersecurity compliant connection.

Remote and local webserver

Remote access from a standard browser is available through the WAN network to embedded PowerLogic™ T300 web apps. This application can be used for data consultation, software update, configuration upload and maintenance.

Local access can be achieved via Wi-Fi or wired connection.

Protection relay

The catalogue of Primary Protocol Devices for PowerLogic™ T300 allows an easy integration of Protection Relays through Easergy Builder engineering tool.

External display

The PowerLogic™ T300 can also support an external HMI such as a touch cabinet or an advanced display. This integration requires a dedicated configuration using Easergy Builder and can be incorporated by Schneider Engineering on request.

Extended I/O with PLC

An external Programmable Logic Controller can be used to extend the PowerLogic™ T300 capacity or for dedicated applications.

This integration requires the use of Easergy Builder and can be incorporated by Schneider Engineering center on demand.

PowerLogic™ HU250 Head Unit Communication

General description

Local operator front panel (HMI)

The HU250 gives general information

Local/remote control and status

- Local position: the remote switch control from the remote access is locked
- Remote position: the local switch control from local access (SC150 HMI, Wi-Fi) is locked
- A button on the HU250 enables changing the control status between local and remote. This button can be replaced by an external device

PowerLogic™ T300 status

- HU250 heartbeat status
- T300 equipment status
- Wi-Fi status
- Communication status with modules

LEDs test button

The test button forces all LEDs on PowerLogic™ T300 and the external light indicator to ON in order to control the led.

Power supply status

The HU250 displays the power supply status, transmitted by the power supply via Modbus.

- AC supply ON/OFF
- Voltage output for switchgear motor ON/OFF
- Voltage output for electronics modules ON/OFF
- Voltage output for transmission devices ON/OFF
- Battery status

Free configurable LEDs

Three free LEDs, configurable for multi-purpose status

Automation status and control

The button with validation allows the operator to locally enable/disable the automation for all modules. The operator must simultaneously press the automation and the **OK** button.

- Automation status LEDs: ON/OFF
- Automation locked status
- Automation status and control

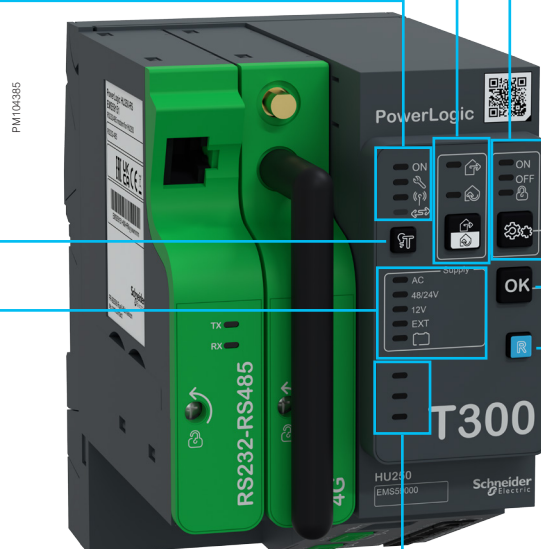

OK button

Reset button

The reset button enables cancelling of all fault current indications on all modules and the automation locked

PowerLogic™ HU250 Head Unit Communication

General description (cont.)

Digital I/O substation monitoring

2 single digital outputs

2 dry relay contacts for multi-purpose control

External fault passage indicator light indicator output

2 dedicated digital outputs allow connecting external light indicator for signaling the fault current outside the substation (5 V-100 mA)

Power supply

- Daisy chain power supply connectors
- Range: 12 Vdc to 48 Vdc \pm 20%

Temperature sensors input (3 PT100)

8 digital inputs

- 6 wet digital inputs compliant with IEC 611131-2 type 3 for multi-purpose monitoring
- 2 digital inputs dedicated for external Local/Remote button (internal or external L/R configurable)

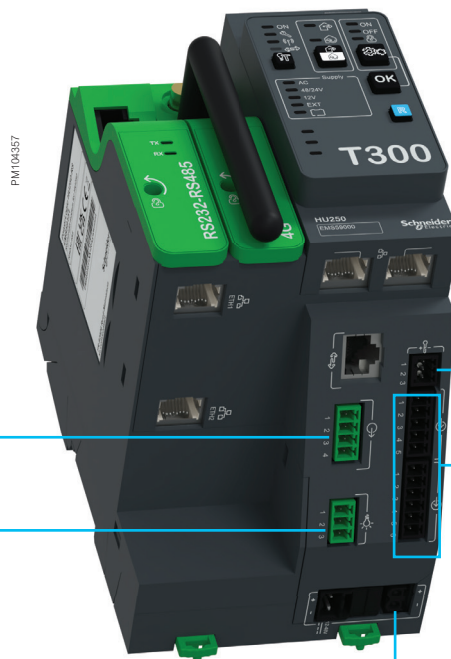

PowerLogic™ HU250 Head Unit Communication

General description (cont.)

Configurable communication ports

Wi-Fi hotspot with control access for local connection

PowerLogic™ T300 incorporates an embedded Wi-Fi hotspot for local connection to:

- Embedded web server via a laptop, tablet or smart phone
- Easergy Builder

Flexible communication ports

These communications ports can accommodate modem boxes. These modem boxes can be added on site and enabled for very flexible updating during the product lifecycle. The modems boxes available are:

- RS232/485 modem box for WAN or LAN communication
- 2G/3G modem box for WAN communication
- 4G European standard modem box with GPS clocks for accurate time synchronization
- ZigBee receiver conforming to IEEE 802.15.4

Ethernet ports

These ports can accommodate one of the following options:

- WAN communication
- LAN communication for third-party IEDs

NOTE: If there are no modem boxes, you need to use empty modem box to protect HU250 connectors.

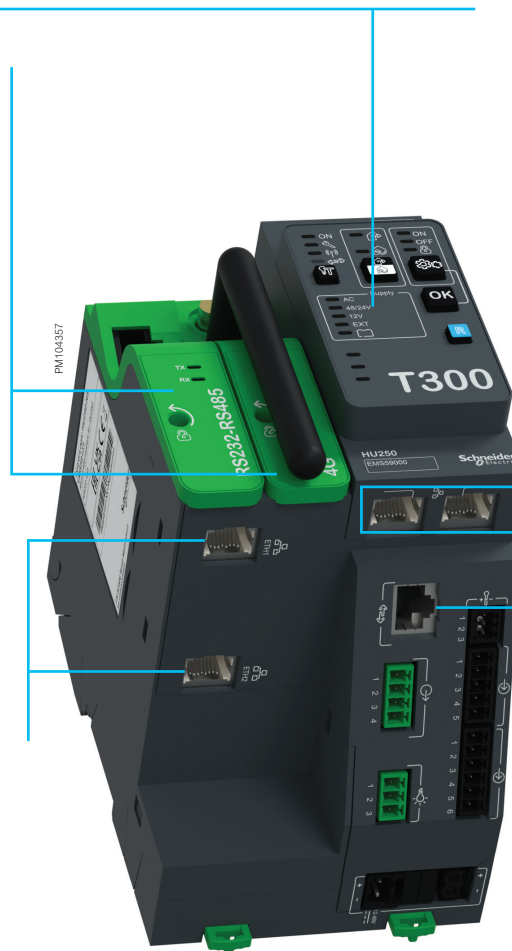

Dedicated dual Ethernet port for PowerLogic™ T300 modules

This Dual Ethernet port daisy-chain is dedicated for communication between PowerLogic™ T300 modules and connection to a laptop with Easergy Builder or an internet browser for connection to a web server.

Serial RS485 Modbus port

This port is used for the connection to the PowerLogic™ communication power supply and can be used for third-party Modbus IEDs

Wi-Fi management with control access

- Wi-Fi activity: Enable/Disable
- Activation mode: From SCADA, Web, HMI Local/Remote button
- SSID visibility: Enable/Disable
- SSID value
- Passphrase value
- Disconnection: Automatic disconnection by timeout

PowerLogic™ HU250 Head Unit Communication

General description (cont.)

HU250 Without wireless

Flexible communication ports

These communications ports can accommodate RS232/485 modem box for WAN or LAN communication. This modem box can be added on site and enabled for very flexible updating during the product lifecycle.

Dedicated dual Ethernet port for PowerLogic™ T300 modules

This Dual Ethernet port daisy-chain is dedicated for communication between PowerLogic™ T300 modules and connection to a laptop with Easergy Builder or an internet browser for connection to a web server.

Ethernet ports

These ports can accommodate one of the following options:

- WAN communication
- LAN communication for third-party IEDs

Serial RS485 Modbus port

This port is used for the connection to the PowerLogic™ communication power supply and can be used for third-party Modbus IEDs

NOTE: If there are no modem boxes, you need to use empty modem box to protect HU250 connectors.

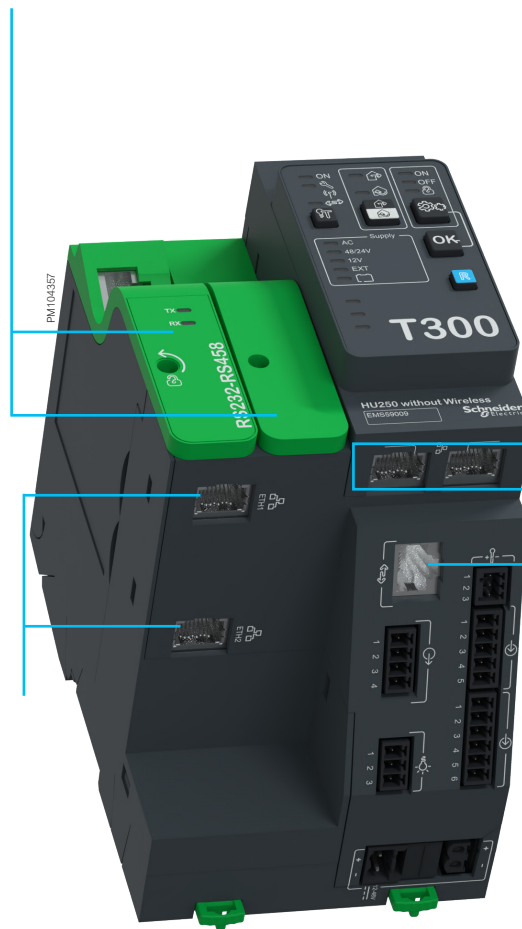

PowerLogic™ HU250 Head Unit Communication

Protocols & communication architecture

HU250 can communicate with peers (SCADA or other devices) on one or N communication channels.

- Each communication channel can have its own channel type and protocol adapted to different usage (DMS, AMM, local automation, etc.)
- Communication channels can be created with Easergy Builder
- The T300 is delivered with default communication channels adapted to standard usage

Protocols

PowerLogic™ T300 communicates with remote SCADA or between substations using open protocols. PowerLogic™ HU250 may also be used as data concentrators for secondary devices.

PowerLogic™ HU250 can manage several communication channels and protocols at the same time.

IEC 60870-5-104 controlling station and controlled station and IEC 60870-5-101 controlling station and controlled station

- UDP (IEC 60870-5-101 only), TCP and Serial (RS232/485)
- Supports secure authentication as per IEC 62351-5
- Redundant connections (IEC 60870-5-104 only (3)) with several controlling station IPs

For more information on the IEC 60870-5 protocol, visit www.iec.ch.

DNP3 master station and outstation

- Supports secure authentication as per IEC 62351-5
- UDP, TCP (including dual end point) and Serial (RS232/485)

For more information on the DNP3 protocol, visit www.dnp.org.

Modbus client and server

- TCP and Serial (RS232/485)

For more information on the Modbus protocol, visit www.modbus.org.

IEC 61850 client and server

- IEC 61850-8-1 ed 2 client and server
- Goose message between IED and HU250

For more information on the IEC 61850 protocol, visit www.iec.ch.

Other protocols

- SFTP for secure file transfer
- HTTPS for secure web server connection
- SNTP for time synchronization
- SNMP client and agent(*)
- Radius and LDAP(*) server
- Webservices with devices management system (ESM)

Zigbee communication

- ZigBee 2.4 GHz (IEEE 802.15.4); support dual application, zigBee pro and green power to connect energy harvesting or self-powered devices.

(*) Please consult us for availability.

PowerLogic™ HU250 Head Unit Communication

Protocols & communication architecture

Channels

The ports used to communicate are configured as communication channels. A channel can support one or more protocols according to the compatibilities with the physical layers.

The possible channel types are:

- Serial (RS232/RS485)
- TCP (Called, Calling or Both) or UDP

For TCP and UDP channels, a remote IP list can be created to limit access to identified peers.

Channel association - Links

Some control centers or IEDs support double channels. The functionality can be different for each protocol. The links are associations of two channels and they are used to identify a double channel. Two modes of channels switching are possible:

- AutoSwitch: used with secondary protocols. When the active channel stops receiving, it switches to the other channel, which becomes active
- SwitchByMaster: used with the primary protocol, the HU250 controls the channel switching. A periodic switching between channels can be defined in order to verify channel state TIME_FORCE_SWITCH

Example of PowerLogic™ T300 communication channel

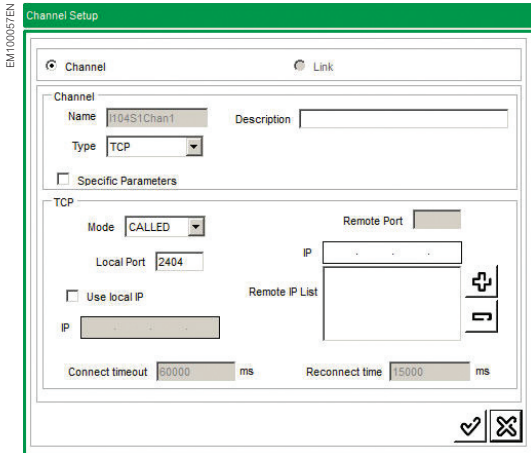
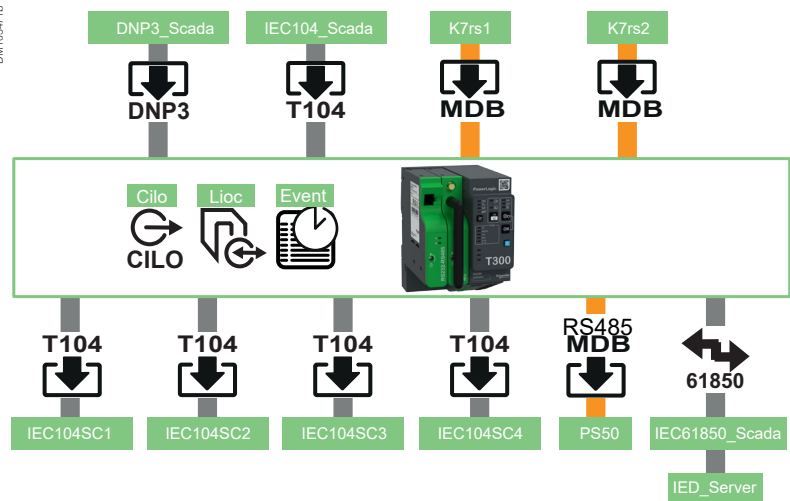

TCP channel configuration from Easergy Builder

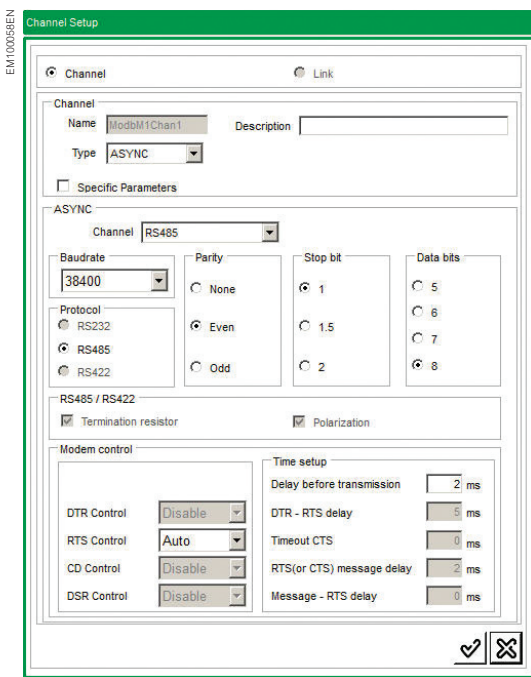

Serial channel configuration from Easergy Builder

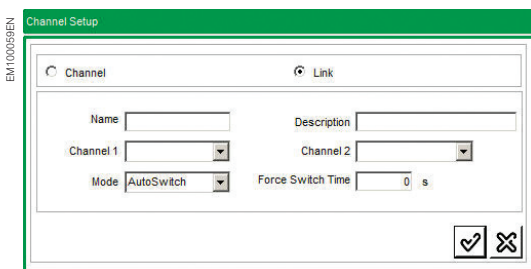

Association of channels

PowerLogic™ HU250 Head Unit Communication

Protocols & communication architecture



One communication channel to one control center

In this case we have one transmission media and one protocol for communicating with only one control center.



Two redundant physical channels to one control center

In this case we have two transmission media (2 channels) and one protocol for communicating with one control center.

The two channels can be grouped to create a redundant physical link with autoswitch mode.

The channel where some data are received is considered active. The HU250 always sends data on the active channel.



Two communication channels to two control centers

Two communication channels can be used for communicating with two control centers. In this case, each channel works separately.

Each communication channel manages its own:

- Protocol and modem
- Event tables
- Mapping protocol

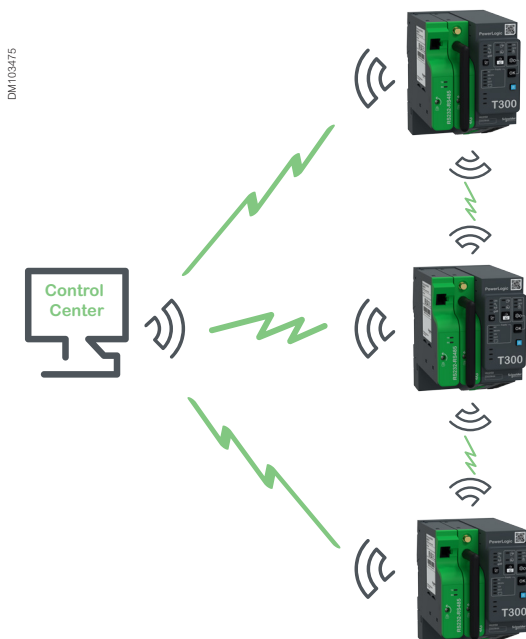

Control center and peer-to-peer communication

Communication channels can be configured for peer-to-peer communication between multiple PowerLogic™ T300 devices.

The main applications are:

- Automatic Change Over between two remote substations
- Self-healing automation between two or more remote substations

PowerLogic™ HU250 Head Unit Communication

Time synchro & sequence of events

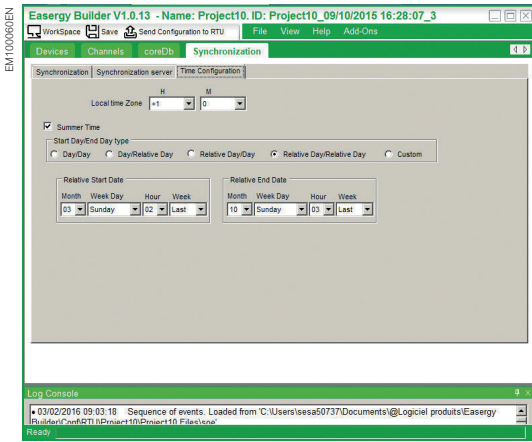

PowerLogic™ T300 can accommodate several kinds of clock synchronization and manages:

- Local time zone
- Summer/winter time

Time synchronization

Proper time-stamping of events and alarms requires that correct time information is provided to the PowerLogic™ T300. The PowerLogic™ T300 time synchronization is managed by PowerLogic™ HU250. Time synchronization can be achieved in numerous ways, depending on the overall system architecture and the required precision.

- **Protocol:** Most data-transmission protocols allow secondary devices to synchronize from a control. The time accuracy depends on the implementation and the communication media
- **SNTP or NTP:** Ethernet communication networks provide SNTP clocks to synchronize devices. PowerLogic™ HU250 can manage a list of SNTP servers: The time accuracy depends on network topology
- **GPS clock** synchronization with 4G modem GPS option.

PowerLogic™ T300 modules time synchronization

PowerLogic™ HU250 operates as a time server to synchronize:

- T300 modules using the Precision Time Protocol (IEEE 1588)
- IEDs in the substation
 - Primary Protocol
 - SNTP server

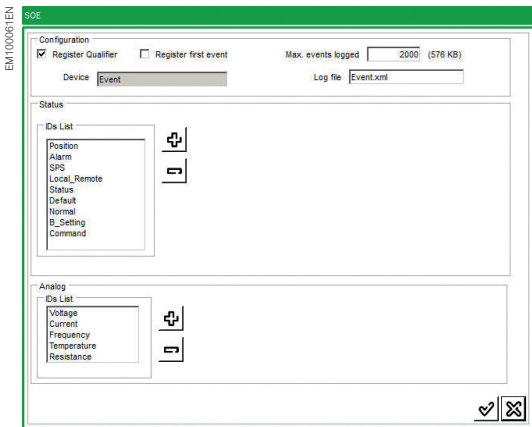

SOE configuration

Sequences Of Events (SOE)

The Sequence Of Events (SOE) records all data changes in log files. Each PowerLogic™ T300 has its own SOE management. The recording mode for each variable can be configured from the HU250 via Easergy Builder.

- Up to 4 log files can be configured
 - These logs can be defined from Easergy Builder
 - The names of these logs are configurable
 - Any data from the database can be assigned to a log file
- The logs files may be downloaded locally from the web server and remotely by SFTP
- SOE time accuracy
- Time resolution: 1 ms
- Discrimination between 2 events: 1 ms
- Event storage capacity
 - Up to 500 000 events can be stored by PowerLogic™ T300
 - The size of logs files is configurable

For all logs, when the storage capacity is reached, the most recent event clears the oldest from the list.

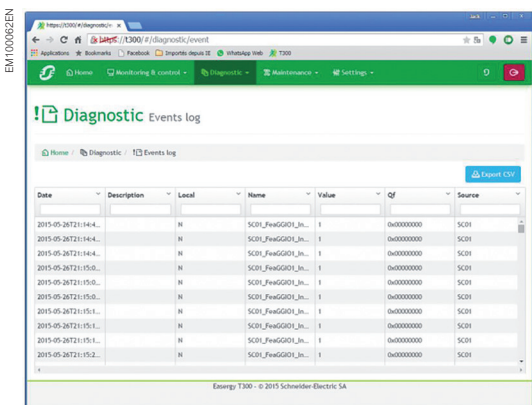

Web server view of SOE

PowerLogic™ HU250 Head Unit Communication Cybersecurity

Cybersecurity features implemented in PowerLogic™ T300 help to mitigate cyber threats as per IEC 62443 standard.

Cybersecurity requirements are designed to meet the international cybersecurity standards and support the security systems necessary to fulfill NERC and IEC 62351 requirements.

Cybersecurity log

PowerLogic™ T300 supports advanced logging and monitoring features for Cybersecurity implementations. Logs are protected against unauthorized access, modification and deletion and are preserved in the security events log.

Port Hardening

All HU250 physical ports (ETH, LAN, WAN) not used by the application can be disabled one by one by configuration from the Web server.

The same rule applies to SC150 and LV150 modules on which the unused LAN ports can be disabled.

At least one of the Ethernet port of HU250 module must be enabled to give the possibility to connect the unit.

Firewall

For each network interface (LAN, WAN, WIFI, PPP), the firewall can be configured :

- To block TCP ports
- To block an IP address (black list)
- To allow an IP address (white list)

PowerLogic™ T300 includes as standard and without external devices, the following cybersecurity features as per IEC 62443-4-2:

- Software integrity with firmware signature on all modules
- Secure communication with TLS using IEC 60870-5, DNP3 and Modbus TCP
- Secure communication between PowerLogic™ T300 and associated webserver tool with local or remote connections using HTTPS, SSH, SFTP
- User identification and authentication as per IEC 62351-8
- User's interface certificate management as per IEC 62351-8
- Communication authentication as per IEC 62351-5 when using DNP3 and IEC 60870-5-104 protocols
- Port hardening management
- IP communication filter
- Security events log storage and transmission according to syslog protocol

Local and remote control access (RBAC)

The device uses Role-Based-Access-Control (RBAC) to provide defined levels of access for users. RBAC is predefined as per IEC 62351-8.

PowerLogic™ T300 is provided with a pre-defined RBAC. It can be customized with the Cybersecurity manager tool CAE or T300 Web server.

Right

Role	DATA BASE	FIRMWARE	WEB Services	BUILDER	TOOLS	LOG & SOE	SECURITY	DATA	RESET
VIEWER			•					•	
OPERATOR	•		•			•		•	
ENGINEER	•	•	•	•	•	•		•	•
INSTALLER	•	•	•	•	•	•		•	•
SECADM			•				•		

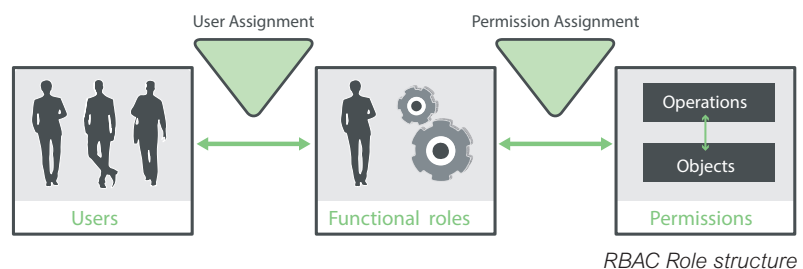

PowerLogic™ HU250 Head Unit Communication Cybersecurity

DM105698

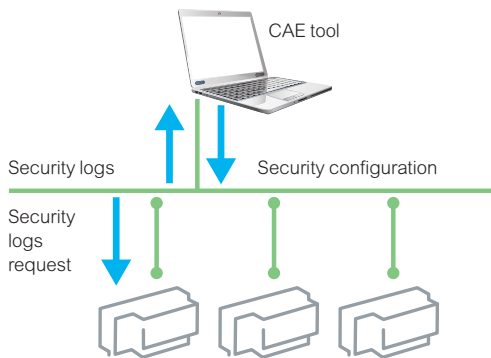

Cybersecurity Administration Expert tool (CAE)

The EcoStruxure Cybersecurity CAE and/or EcoStruxure™ Power Automation System Maintenance is a windows-based tool that allows a central management of Security configuration and access to security logs of each PowerLogic™ T300

Security configuration includes:

- Security policy, including for example: password complexity or password strategy
- Define rules for security logs, choose between various standards
- Roles and permissions: Role Base Access Control (RBAC)
- Users with associated roles.

Local Authentication and Authorization

Local authentication and authorization can be achieved without any external servers. Security configuration is stored locally in each PowerLogic™ T300. Users authentication and authorization using associated role are performed locally (RBAC). CAE is used to update globally the security configuration of all the PowerLogic™ T300 located inside the substation, so that users, associated passwords, and other parameters are consistent on all devices.

Centralized authentication and authorization can be achieved also with one or two Radius and LDAP(*) server, with IEC 62351-8 extension. In order to coordinate the authentication from a unique customer security policy management system.

DM105700

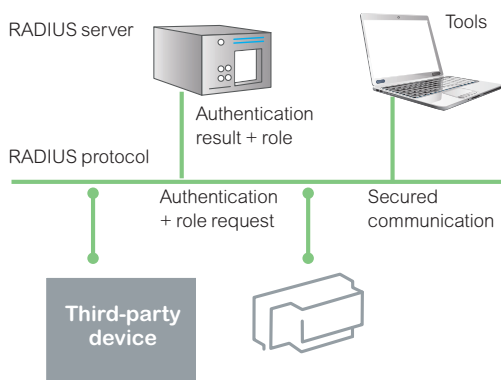

Radius and LDAP(*) Server

This allows to use Unified Account management system shared across heterogenous solutions. The same credentials are used for each PowerLogic™ T300, at tools and also at third party devices.

Radius server is in charge of authenticating users and providing associated role. Then PowerLogic™ T300 allows access based on this role and the internal security configuration (RBAC).

(*) Please consult us for availability.

Ensure power availability for critical buildings when power outages occur on the utility grid

Power availability is a key criterion for any critical buildings. An ATS (Automatic Transfer System) allows a critical load to have increased supply availability by switching between a primary and a backup MV supply.

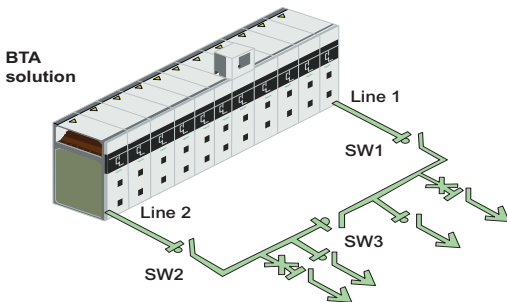
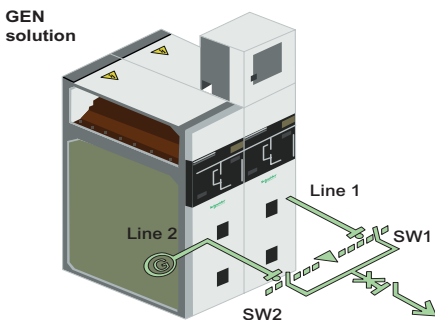
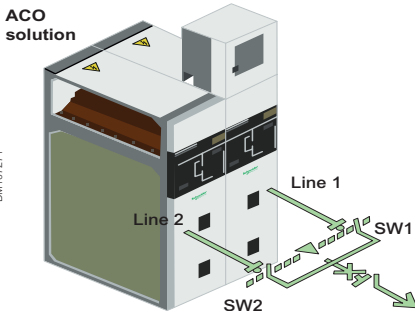

EcoStruxure ATS solution architectures

ACO - Automatic transfer between 2 MV lines
Standard ACO (Auto Change Over) transfers the power source to the alternate supply if the preferred source is lost. It may be set to automatically return to the preferred source when restored.

GEN (Automatic transfer to a GENset) starts the standby generator upon loss of the distribution utility MV power source outage. An option is to combine two separate MV sources coming from the distribution utility, and one standby generator.

BTA (Bus-Tie Automatic transfer) isolates the faulty MV power source and switches both loads to the healthy MV power source, by opening SW1 (or SW2) and closing SW3 (busbar coupling).

PowerLogic™ T300 ATS offer solution description

PowerLogic™ T300 is a modular Remote Terminal Unit (RTU). Its open architecture supports different type of applications, from a single ATS to large substation management with third-party devices.

Auto Transfer Switch application is controlled by the HU250 module and so activated globally for all the SC150 modules of PowerLogic™ T300.

0.3s

Typical time for power recovery with an SM6 MV switchgear.

Preset automation systems

Automatic Transfer of Source (ATS)

Some automation system functions are factory defined and integrated as basic functions of PowerLogic™ T300.

These functions require are no on-site programming, only a configuration using PowerLogic™ T300 configurations tools. They correspond to known operations widely used for the MV substation switch management application.

PowerLogic™ T300 ATS can control 2 different SC150 modules and restore the power supply in less of 300 ms. The conditions of source transfer and transfer lock are configurable. In addition, automation functions are enabled or disabled globally on PowerLogic™ T300 either remotely from the SCADA system or locally.

ATS function can be used with standby generators, but this requires additional custom logic to be defined using Formulas or ISaGRAF®.

ATS requires a voltage presence/absence indication per switch. This can be calculated either from the voltage measurement (sensors) of SC150 or from an external information connected to DI6 digital input on the SC150.

Sectionalizer (SEC)

Sectionalizer automation is controlled by each SC150 module. Each switch managed by a SC150 module can be activated with SEC automation (Refer to SC150 chapter).

PowerLogic™ HU250 Head Unit Communication Automation

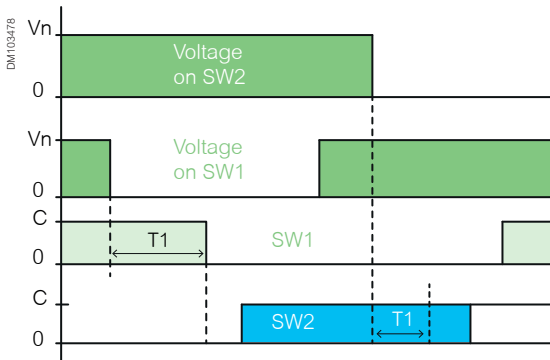

Example of ATS operating diagram

Specific or customized automation control

Some other automations using customizable IEC 61131-3 program are available on demand for customer or system integrator integration.

Customer or system integrator can create a new automation or custom an existing automation control using ISaGRAF® workbench and calculation formulas.

PowerLogic™ HU250 integrates ISaGRAF® runtime to execute the applications generated from ISaGRAF Workbench, and calculation formula to custom your application.

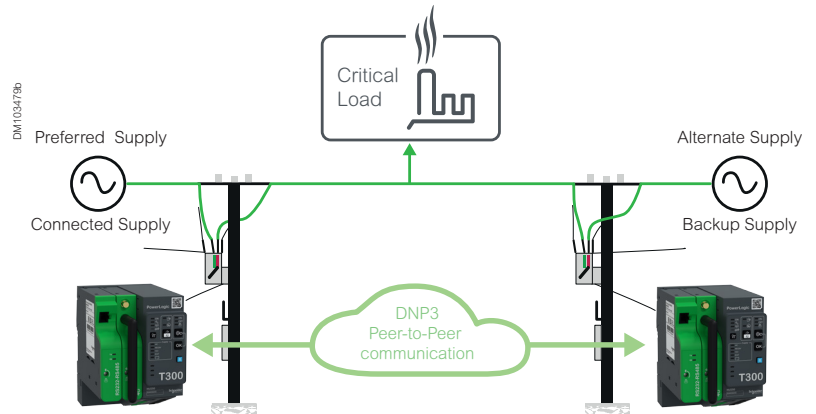
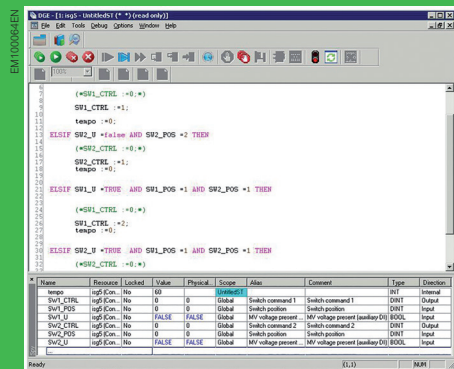

Example of Distributed Automatic Transfer Source using a peer-to-peer communication between two distant underground substations or overhead LBS.

ATS offer description

Functions	ACO	GEN	BTA
Native in PowerLogic™ T300	•		
Using customizable IEC 61131-3 program		•	•
Back to normal source configurable/settable (self return mode)	•	•	•
Block transfer to one source configurable (no return mode)	•		•
Transfer with close transition configurable (parallel coupling mode)	•	•	•
Time slot to back to normal source	•	•	•
Load shedding capability		•	•
GENset test function (temporally start genset)		•	
Transfert lock on downstream current fault detection	•	•	•
Push buttons (ATS ON/OFF, Remote/Local, source forcing,...)	•	•	•
Interlock on digital inputs	2	2	3

PowerLogic™ HU250 Head Unit Communication

Open Programmable Logic Controller

Intelligent loop automation reconfiguration (Self-Healing Grid) ⁽¹⁾

Overhead and pad-mounted designs

Self Healing is a smart, cost-effective way to enhance the reliability of electrical distribution grids. Deployment takes just a few months.

Self-healing is an innovative solution that improves re-energization time and availability in MV distribution networks. In case of fault current, Self-healing solution isolates affected areas and restores service to unaffected areas of the grid.

The entire system is decentralized, designed to function without DMS or to complement it. The control centre is notified of a fault current, but there's no waiting for an operator response. Instead, the PowerLogic™ T300 units communicate automatically to find the fault current, isolate it, and re-energize the unaffected areas of the grid.

SHG is an evolution of the classic loop automation algorithm to an intelligent loop automation that uses peer-to-peer communications to exchange messages between Feeder, Mid-point and Tie devices. This exchange reduces stress on pole-mounted switchgear by helping to avoid or reduce number of unnecessary re-energization.

The loop automation applications consist in a number of PowerLogic™ T300 devices distributed over an open ring topology. Each device in a loop automation scheme operates independently according to its predefined role, each with its own set of operation rules.

⁽¹⁾ Available on project, consult us.

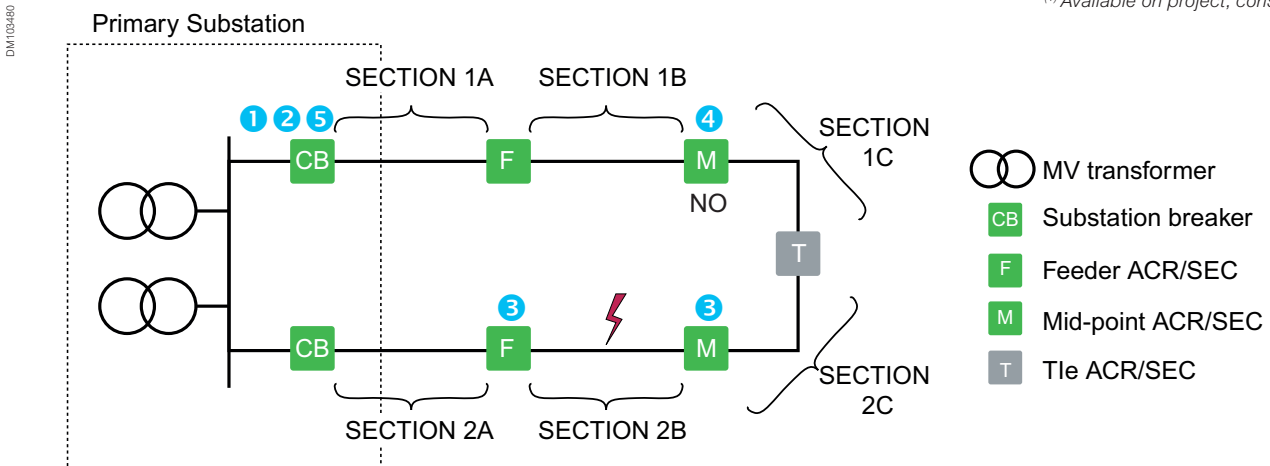

How it works:

- 1 When a fault current occurs, the Circuit Breaker in the primary substation trips and the rest of the feeder up to the normal open point is de-energized.
 - 2 The primary substation's PowerLogic™ T300 unit communicates with its immediate neighbor and so on along the feeder until the fault current is localized.
 - 3 When the affected area is localized, switches in the substations immediately upstream and downstream the section are open to isolate it.
 - 4 The normal open point (NO) is closed to restore supply downstream the section.
 - 5 The primary substation circuit breaker is closed again to restore supply upstream the section.
- The result is the automatic restoration of power to the unaffected area of the network within 30 seconds of an outage.

PowerLogic™ HU250 Head Unit Communication

Condition monitoring

The power connections in the Medium Voltage products are one of the most critical points of the substations especially for those made on site like:

- MV cable connections
- MV bus bar and transformer connections
- LV transformer and switchboard connections

Loose and bad connections cause an increase of resistance in localized points that will lead to thermal runaway until the complete failure of the connections.

Preventive maintenance can be complicated in severe operating conditions also due to limited accessibility and visibility of the contacts.

The continuous thermal monitoring is the most appropriate way to early detect a compromised connection.

PowerLogic™ T300 measures several temperature and environmental parameters to optimize the effective life of customers assets located inside secondary MV/LV substations using **wireless (TH110, CL110) and wired sensors (PT100)**.

These sensors, using Zigbee Green Power communication protocol, are connected to PowerLogic™ T300 that harvest the data for local and remote signaling, data storage for post analyses and local display.

The remote monitoring and alarming enable peace of mind thanks to remote connection to SCADA or Services platform.

Thermal monitoring

PowerLogic™ TH110, self-powered sensor, enables the continuous thermal monitoring of all the critical connections in the MV and LV side of the substation.

TH110 sensors linked to T300 with specific monitoring algorithms allow to detect temperature drifts. Threshold to identify significant drifts are based on the specific installation characteristics, also considering the variable loads.

Algorithms also detect abnormal behaviors by comparing temperatures on the various phases.

Environment



PowerLogic™ CL110

Temperature and humidity sensors measure condensation enabling to detect local conditions where fast aging may occur.

Thermal



PowerLogic™ TH110

Sensors detect hotspots at cable connections, requiring maintenance, enabling users to take preventive action.

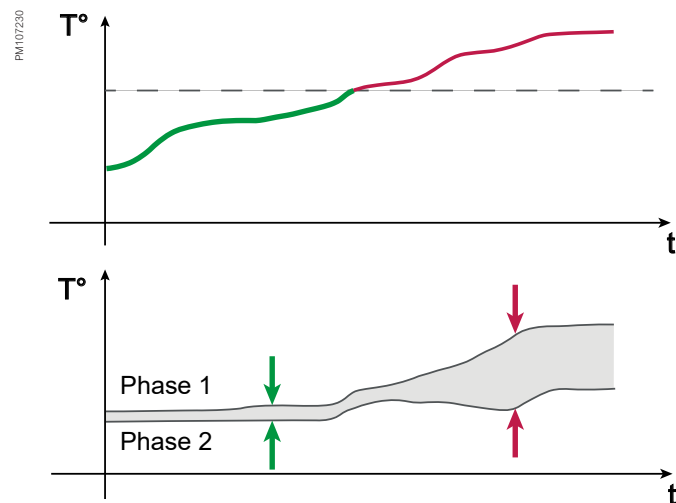

		Pollution	
		PL	PH
Condensation	Co	Degree 0	Degree 1
	CL	Degree 1	Degree 2
	CH	Degree 2	Degree 3
	CH+	Degree 3	

Pollution level as per IEC 62271-30

Environmental monitoring

CL110 wireless sensors located inside the MV switchgear compartment to measure humidity, ambient, and cold point temperature. From these data, PowerLogic™ T300 algorithm determines presence of condensation then calculates current degree of environmental safety among 4 possible, based on measurements and pollution level inputs as per IEC 62271-30.

PowerLogic™ T300 provides alarms for excessively high T°, low T°, and humidity.

PowerLogic™ HU250 Head Unit Communication

Communication port characteristics

Modems box and interface	Technical characteristics
Serial modem box	<ul style="list-style-type: none"> • RJ45 connector The serial modem interface is configurable • RS232 <ul style="list-style-type: none"> – with all control signals for external modems such as radio or PC connection – Maximum flow rate: 115200 bit/s • RS422/RS485 <ul style="list-style-type: none"> – Maximum distance: 1500 m – Maximum flow rate: 38400 bit/s – Adaptation and polarization resistor: configurable for 2 wires – 2 Wires or 4 wires: configurable by the HU250
4G modem box (NOTE: Not available for EMS59009)	<ul style="list-style-type: none"> • 4G modem Box EU standard version <ul style="list-style-type: none"> – Penta Band LTE: 800/900/1800/2100/2600 MHz; FDD-Band (20, 8, 3, 7, 1) – Tri Band UMTS (WCDMA): 900/1800/2100 MHz; FDD-Band (8, 3, 1) – Dual Band GSM/GPRS/EDGE: 900/1800 MHz – GPS clock synchronization option (required additional antenna)
ZigBee receiver (NOTE: Not available for EMS59009)	<ul style="list-style-type: none"> • ZigBee® Green Power protocol at 2.4 GHz (IEEE 802.15.4) • Maximum range: 100 m in free field (300 m with a relay antenna, 25 m inside a cubicle) • Response time: < 30 ms
WAN Ethernet port	<ul style="list-style-type: none"> • 10/100 base T RJ45 • Auto-negotiation • DHCP client • Insulation Port: 4 kVACrms/8 kV surge
LAN Ethernet port	<ul style="list-style-type: none"> • 10/100 base T RJ45 daisy chain • Auto-negotiation • DHCP server • Insulation 2 kVACrms/5 kV surge
Serial port	<ul style="list-style-type: none"> • RS485 connector • Insulation 2 kVACrms/5kV surge
Wi-Fi (NOTE: Not available for EMS59009)	<ul style="list-style-type: none"> • 2.4GHz band IEEE 802.11n. Backwards compatible with IEEE 802.11b/g • Security WPACOMP • DHCP server

PowerLogic™ HU250 Head Unit Communication Characteristics

General characteristics

Dielectric compatibly			
Dielectric	IEC 60255-27	Common mode (CM):	<ul style="list-style-type: none"> Insulation (50 Hz/1 min.): 2 kV Surge (1.2/50 µs): 5 Kv
Electromagnetic compatibility/Immunity			
Electrostatic discharge	IEC 61000-4-2	15 kV in air	
	Level 4/Criteria B	8 kV at contact	
Radiated RF electromagnetic fields	IEC 61000-4-3 Level 4/Criteria A	30 V/m – 27 MHz to 6 GHz	
Fast transients	IEC 61000-4-4 Level 4/Criteria A	Power supply, Ethernet	CM: ±4 kV 5 kHz...100 kHz
		Other circuits	CM: ±2 kV 5 kHz...100 kHz
Surge	IEC 61000-4-5	<ul style="list-style-type: none"> CM: 2 kV - wave 1,2/50 µs DM: 1 kV - wave 1,2/50 µs 	
	Power supply: Level 4/Criteria A Other circuits: Level 3/Criteria A		
Conducted RF disturbances	IEC 61000-4-6	10 Veff	
	Level 3/Criteria A	0.15 MHz to 80 MHz	
Power frequency magnetic field	IEC 61000-4-8	<ul style="list-style-type: none"> 100 A/m – 50 Hz enduring 1000 A/m from 1 to 3 s 	
	Level 5/Criteria B		
Immunity to voltage dips	IEC 61000-4-29 Criteria A	Voltage dip:	<ul style="list-style-type: none"> 24 Vdc: 100 ms 48 Vdc: 500 ms
		Voltage interruption:	<ul style="list-style-type: none"> 24 Vdc: 100 ms 48 Vdc: 500 ms
Pulse magnetic field immunity	IEC 61000-4-9	1000 A/m	
	Level 5/Criteria A		
Conducted common mode disturbance	IEC 61000-4-16 Level 4/Criteria A	CM: 30 V for 15 Hz to 150 kHz 300 V during 1 s	
Damped oscillatory waves	IEC 61000-4-18 Level 3/Criteria A	CM: 100 kHz, 1 MHz, 3 MHz, 10 MHz, 30 MHz - 2 kV	
Emission tests			
Radiated disturbances	CISPR22	Class A (EN5502)	

Criteria A definition: The unit shall continue to operate as intended during and after the test. No degradation of performance or loss of function is allowed below a performance level specified by the manufacturer, when the apparatus is used as intended. The performance level may be replaced by a permissible loss of performance.

Criteria B definition: The unit shall continue to operate as intended after the test. No degradation of performance or loss of function is allowed below a performance level specified by the manufacturer, when the apparatus is used as intended. The performance level may be replaced by a permissible loss of performance. During the test, degradation of performance is however allowed. No change of actual operating state or stored data is allowed.

PowerLogic™ HU250 Head Unit Communication

Characteristics

General characteristics

Environmental conditions		
Operating temperature	IEC 60068-2-1	-40 °C...+70 °C
	IEC 60068-2-2	
Storage temperature	IEC 60068-2-1	-40 °C...+85 °C
	IEC 60068-2-2	
Damp heat, steady state	IEC 60068-2-78	93% RH, 40 °C, RH no condensation, 56 days
Change of temperature	IEC 60068-2-14	-40 °C...+70 °C, 5 °C/min, 10 Cycles, 27 h without condensation
Damp heat, cyclic	IEC 60068-2-30	144 h: 6 cycles of 24h (+55 °C, 93% HR during 9 h; +25 °C, 95% HR during 6 h)
Salt spray test	IEC 60068-2-11	168 h
Product safety standards		
Protection of persons and goods.	IEC 60255-27	
Fire resistance	IEC 60695-2-11	850 °C
Power supply		
Rated supply voltage		12...48 Vdc (+/-20 %)
Power consumption		3 VA

Mechanical characteristics

Degree of protection	IEC 60529	<ul style="list-style-type: none"> • Front panel: IP4x • Module body: IP2x
Robustness	IEC 62262	IK7 2 J
Vibrations	IEC 60068-2-6	10 to 2000 Hz/1 g (peak value) 10 cycles
Bumps	IEC 60068-2-29	10 g/16 ms/1000 Bumps non energized
Shocks	IEC 60068-2-27	10 Gn/11 ms/3 pulses in operation
Weight		0.55 kg
Dimensions (H x W x D)		140 mm x 90 mm x 140 mm

PowerLogic™ HU250 Head Unit Communication Configuration tools

DM103483

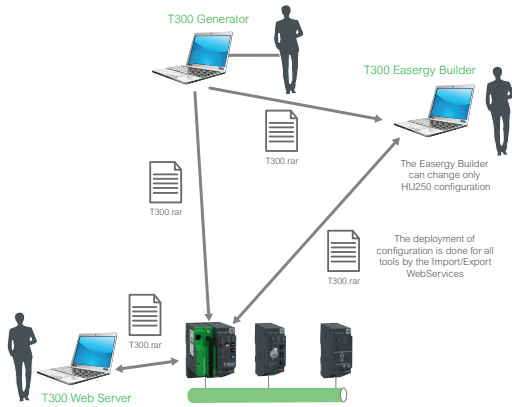

Interaction between the three T300 configuration tools

With the use of these three tools, the user is able to:

- Modify the configuration downloaded to Easergy Builder, in order to adapt/add/modify new advanced functions or unit settings
- Transfer the configuration file to the T300 unit once modified
- Change functional settings directly on the unit from a PC connected to the web server.

These three tools are interactive and can be used to transfer the configuration file from one to another.

PowerLogic™ T300 configuration tools

Three configuration tools are available with T300:

- **T300 Web Server**

Dedicated to the end user for the operation, commissioning, exploitation and maintenance, this tool allows (according to the Cybersecurity access and roles):

- Data consultation
- Substation diagram viewing
- Events consultation
- Firmware updating
- Configuration saving/uploading
- Functional setting of T300

- **Easergy Builder**

Advanced Engineering tool for experts, this tool enables adding/modifying the configuration of the T300 application, for example:

- Adding/modifying communication architecture (protocol, modem, etc.)
- Adding/modifying local network and IEDs and associated variables
- Adding/modifying ISaGRAF® automation applications or PLC programs

- **T300 Generator**

User friendly tool to generate standard T300 configuration file. The file generated can be downloaded directly to T300 using Web server interface or imported into Easergy Builder for deeper customization.

T300 Generator allows to:

- Generate a factory configuration automatically from commercial product reference
- Generate a factory configuration from dialog box
- Customized protocol variables and mapping
- Customized variable description language
- Customized sequences of events files.

PowerLogic™ HU250 Head Unit Communication Configuration tools

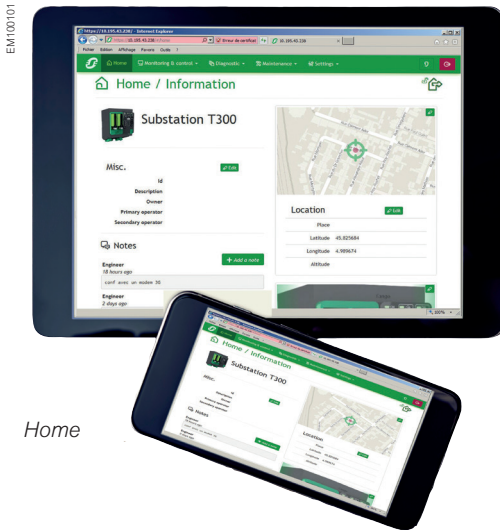

Home

T300 Web Server - Commissioning, operation and maintenance

HU250 includes an embedded Web Server as HMI interface and local supervision of the substation for the user.

Basic configuration, operation and diagnosis are carried out by connecting a laptop, tablet or smartphone to the T300 Web Server. This web server can be accessed:

- Locally via ETH port (laptop directly connected to one of the T300 Ethernet ports)
- Locally via Wi-Fi access
- Remotely via WAN network
- Remotely via 3G, 4G, Ethernet
- The menu on the home page enables the user to select the language
- The web data server's HTML format pages includes different pages and subpages:
 - Home page: local map, GPS coordinates, photos and notes to identify the substation
 - Monitoring and control page: physical view of the system, data view including display of status and analogs, control of commands and set points
 - Diagnostic page: to consult and export.csv file (events log, cybersecurity log, system log, protocol traces and disturbance records)
 - Maintenance page: user settings, clock synchronization, IP configuration settings, device status, firmware version update, configuration download
 - Settings page: setting per module (HU250, SC150, etc.). These settings per module include the configuration of functional parameters for communication, protocol, switch control, measurement and detection, etc.

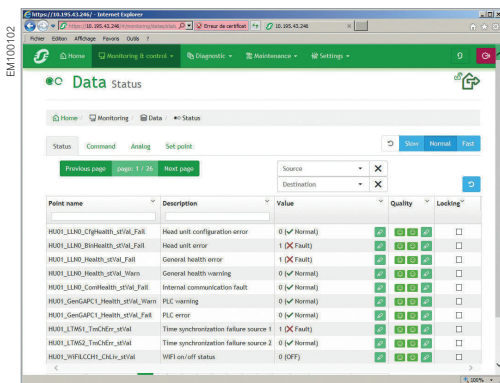

Monitoring/Data/Status

Operation and control

Alongside operation and control of the network from the SCADA system, it is possible to operate the equipment locally or remotely using data pages:

- Displaying status and measurement
- Issuing commands: switches, automation system on/off, MV fault current detector reset and other digital outputs with a selection and confirmation process
- Consultation of archived data
 - On-screen consultation of archive logs
 - Extraction of logs on a PC as a .csv file for analysis

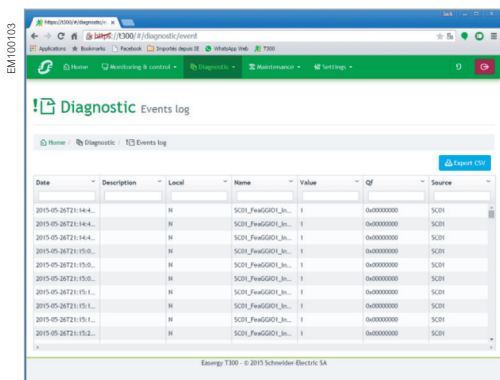

Diagnostic/Events

PowerLogic™ HU250 Head Unit Communication Configuration tools

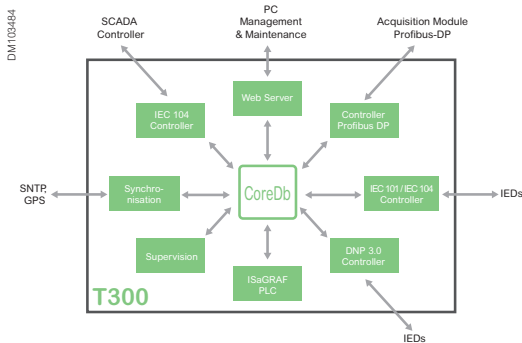

Easergy Builder: Relationship between coreDb and other applications

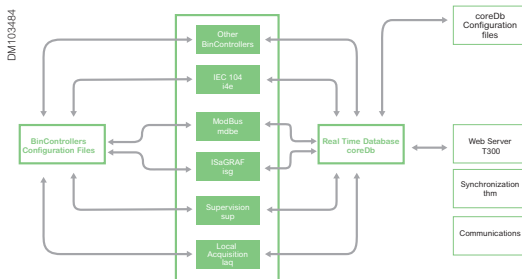

Easergy Builder: Real-time operating system architecture

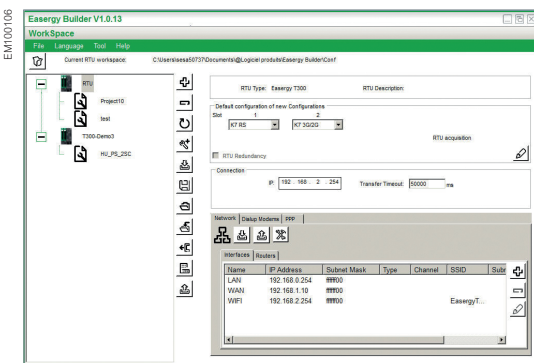

WorkSpace: RTU setting

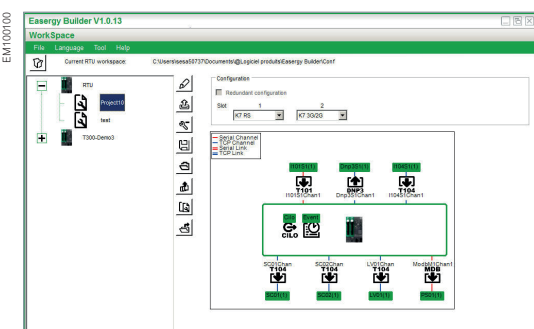

WorkSpace: Device architecture page

Easergy Builder

Easergy Builder is the advanced configuration tool of the PowerLogic™ T300 RTU, reserved for the expert engineering team.

The basic use of PowerLogic™ T300 does not require advanced modifications of the PowerLogic™ T300 configuration.

The web server is sufficient for the user to personalize the system and change basic settings.

Interface

Easergy Builder permits the modification of an existing PowerLogic™ T300 configuration from the main page WorkSpace.

This page includes the following general settings:

- IP parameters for LAN, WAN, Wi-Fi access (IP address, delays, etc.)
- Slot (K7) to be used for the communication (RS232/485 or 3G)

The WorkSpace can manage several PowerLogic™ T300 RTU configurations. The WorkSpace page displays as a diagram the architecture of each PowerLogic™ T300 application (architecture of the different devices included in the configuration).

Each of the following elements (named devices) can be associated with a PowerLogic™ T300 RTU application:

- Primary/secondary protocol setting (IEC 104, DNP3)
- ISaGRAF® project interface
- Supervision setting
- Local acquisition setting (input/output)
- SOE setting (Sequence Of Events)
- CoreDb signals (real-time database), including status, command, analog, setpoint
- Synchronization setting

To personalize the RTU application, Easergy Builder uses four main groups of settings pages:

- Devices: one device for each function (protocol, modem port, SOE, ISaGRAF, input/output)
- Channels: one channel for each internal or external communication link
- CoreDb: database including variables, labels and mapping of the application
- Synchronization: setting to synchronize the unit by SNTP server, GPS, or by the protocol

PowerLogic™ HU250 Head Unit Communication Configuration tools



EcoStruxure™ Power Automation System Maintenance Tool allows to track the evolution of all the configuration & software artifacts throughout the lifecycle.

Device Management

- FW version
- HW version
- Serial number

Baseline Management

- Backup Configuration
- Track evolution of changes with Time
- Track versions of Baseline Vs Real

Mass Firmware & Configuration Update

- Mass firmware upgrades
- Mass configuration downloads
- Mass incremental configuration updates

Central Cyber Security Configuration (CAE embedded)

- Manage RBAC Configurations
- Backup all RBAC Configurations & trace evolution

Access to T300 Web Interface

- Identify devices and connect without needing to remember URLs

PowerLogic™ SC150

Switchgear Controller Unit

PowerLogic™ SC150 Switchgear Controller Unit

General description

All advanced functions for MV line and switchgear management in a compact box

- Switchgear control and monitor
- Advanced fault current detection
- Power measurement
- Power quality
- Sectionalizer automation
- Embedded operator HMI
- Disturbance recording

PM104382



SC150
vertical mounting

PM105841



SC150H horizontal mounting

The SC150 supports the following functions related to one MV cubicle:

- MV switchgear control and monitor
- MV current and voltage measurement
- Fault passage detection and indication
- Local automation
- Power measurement and power quality

MV switchgear control and monitor

The SC150 is compatible with any form of MV switchgear:

- Single or dual control-command to the switch
- Control security by dual relays: select and execute
- Local and remote control with remote or local operating mode
- Motor mechanism voltage control: 12...220 Vdc and 120...220 Vac
- Dummy control simulation available remotely or locally

MV current and voltage measurement

- SC150 is compatible with standard current sensors as per IEC 61869
- Four mountings are possible for acquiring current measurement:
 - 3 phase CTs
 - 1 core balance CT
 - 2 phase CTs + 1 core balance CT
 - 3 phase CTs + 1 core balance CT
- Voltage measurement or indication using different types of sensors:
 - LPVT, as per IEC 61869-7
 - VTs with secondary output 57...220 Vac as per IEC 61869-3
 - VPIS with voltage output, as per IEC 62271-206
 - VDS, as per IEC 61243-5
 - VDIS, as per IEC 62271-213
 - PPACS, as per HN-52-S-63

SC150 Part Number

	Reference	Description
Vertical mounting	EMS59201	SC150-CT-LPVT/VT
	EMS59202	SC150-CT-CAPA
Horizontal mounting	EMS59203	SC150H-CT-LPVT/VT

MV Network Monitoring

Automation systems

The automation systems concerning several switchgear and MV network systems such as Automatic Transfer Source (ATS), self healing, etc., are hosted in HU250.

The sectionalizer automation (SEC) concerning one switchgear is managed by the SC150 module. This automation is factory predefined but configurable on site (setting).

Sectionalizer (SEC): Automatic control for opening the MV switch following detection of a number of fault currents in the source substation reset cycle.

PowerLogic™ SC150 Switchgear Controller Unit

General description

MV Network Monitoring

Fault Passage Indicator (FPI)

The fault current detections are compatible with all existing ground neutral systems with or without presence of distributed generation. The detection is based on international standards of ANSI codes:

- Phase overcurrent fault detection (ANSI 50/51)
- Ground (earth) fault detection (ANSI 50N/51N)
- Broken conductor detection/Negative sequence overvoltage (ANSI 47)
- Directional phase overcurrent fault detection (ANSI 67)
- Directional ground (earth) fault detection (ANSI 67N)

Three ammetric fault detection instances and two directional fault detection instances, each with their specific settings and detection mode, can operate separately or simultaneously.

Each instance includes 2 groups of settings. These 2 groups correspond to 2 sets of thresholds and time delays that are typically linked to 2 upstream protection settings.

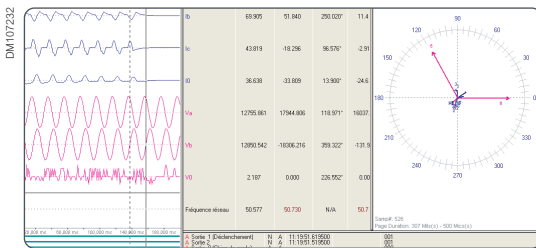

Oscillography analysis such as Wavewin

Post fault recording

Each SC150 has a disturbance recording application in order to understand what has happened on the grid after a network outage. All voltage and current measured, power quality events and events can be recorded with an accurate time tagging.

Depending on the trigger position setting, the stored event can begin before the event and continues afterwards. Records comprise the values sampled from the different signals and the date.

The disturbance file (COMTRADE file as per IEC 60255-24) can be displayed with disturbance viewer as Wavewin - Schneider tool. Files can be transferred locally using a PC connected to the Web server.

Voltage and power monitoring

MV Voltage monitoring enables the PowerLogic™ T300 to detect voltage anomalies on the MV Network. Some standard detections help to detect these anomalies:

- ANSI 27 (Undervoltage detection): detects a voltage drop or an abnormally low voltage on each phase of the MV network (i.e. unbalance network).
- ANSI 32P (Directional active overpower): based on active overpower detection and reverse active power detection, this function can detect overload or abnormal power flow on the network. It allows to detect distributed generation injection on the network.
- ANSI 59 (Overvoltage detection): detects overvoltages on each phase.
- ANSI 59N (Neutral overvoltage detection): detection of abnormal voltages or insulation faults by measuring the residual voltage.
- ANSI 47 (Negative Sequence Overvoltage Detection): detection of unbalance condition resulting from significant negative sequence voltage component in case of broken phase conductor anomaly.

MV Power measurements and power quality

Advanced power measurement and power quality are available on each SC150 in accordance with EN50160 directive:

- Power measurements according to the principles of IEC 61557-12
- Voltage power quality according to the principles of IEC 61000-4-30 class S.

PowerLogic™ SC150 Switchgear Controller Unit

General description

Local operator front panel (HMI)

Display of information by colored LEDs

- Module status
- Alarm status
- Local/remote status (information provided by the HU250 module)
- Automation status: ON/OFF and lock status

3 customizable LEDs

Switch status

- Main switch position (open, closed, intermediate)
- Ground switch position

Overcurrent detection and voltage indications

- Overcurrent detection status with direction
- Voltage presence status



Local operator switch control

The local switch control is allowed when the operating mode on the HU250 is set to local:

- In Local mode: the command from the operator cabinet is confirmed, any order from the remote control center is locked
- In Remote mode: local commands are not permitted, orders from the remote control center are validated
- Switch control: the operator must press the OFF or ON buttons and the OK button.
- The local control can be enabled/disabled by configuration

Automation system activation

The automation system is activated and deactivated globally by pressing the control and validation buttons at the same time on the HU250.

Daisy chain LAN

- Internal Ethernet LAN for PowerLogic™ T300 modules
- Ethernet 10/100 BASE-T

Switchgear status

- 8 singles or duals Wet input (0 V Common)
- compliant to IEC 61131 -2

Switchgear control

2 configurable digital outputs

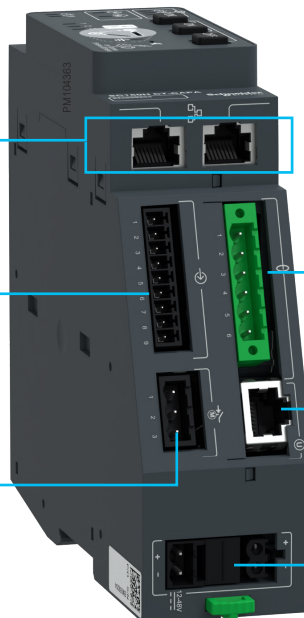

Current acquisition

4 current inputs with standard CT

Voltage acquisition

3 phase acquisition through RJ45 interface and accessory sensors

Daisy chain power supply

12-48 Vdc

PowerLogic™ SC150 Switchgear Controller Unit

General description

Management of different types of switches

- A library of ready-to-use switchgear control is provided and corresponds to all motor mechanism controls:
 - Single point control
 - Double point control
 - Simple mechanical motor (tumbler type)
 - One-latch operating mechanism
 - Two-latch operating mechanism
- The required control settings are configurable

Switchgear operation

- To help the reliability of the operation, the switch command is executed via two serial relays: selection and execution. If only one relay is activated or if the “select relay” does not return to normal position, the switch command is not performed or locked and an alarm is generated
- Dummy control function allows simulating switch command actions on the SC module, locally or remotely via the web pages
- In addition, the voltage motor output on the PS50 power supply can be activated only when one command is under process
- Switchgear can be operated locally or remotely depending on the mode defined by the pushbutton on the front of HU250 module. This mode is copied to all the SC150 modules simultaneously.
In addition, each SC150 module can be configured to use a digital input to provide the local/remote mode for the individual module and so the operation will be as follows:
 - SC150 will respond to remote commands when both the HU250 and the SC150 are in remote mode.
 - SC150 will respond to local commands when either the HU250 or the SC150 are in local mode.

General functional characteristics

Technical	
Clock synchronization	Clock synchronization from HU250 IEEE1588
Time-stamped resolution	Configurable 1 ms; 5 ms; 10 ms

Switchgear control

Switchgear control functions

Logical nodes	Data Object	Description
XSWI	MainXSWI	MV switchgear position status
CSWI	MainCSWI	Switchgear control function
SSWI	MainSSWI	Switchgear supervision
PhXSWI	OpCnt	Number of operations
SCSWI	SimCSWI	Dummy control simulated position control
XSWI	SimXSWI	Dummy control simulated position status
XSWI	EarthXSWI	Ground switch position status
CILO	MainCILO	Switchgear Interlocking
GGIO	FeaGGIO	Other inputs
GAPC	SecGAPC	Sectionalizer (SEC) automatic control

PowerLogic™ SC150 Switchgear Controller Unit

General description

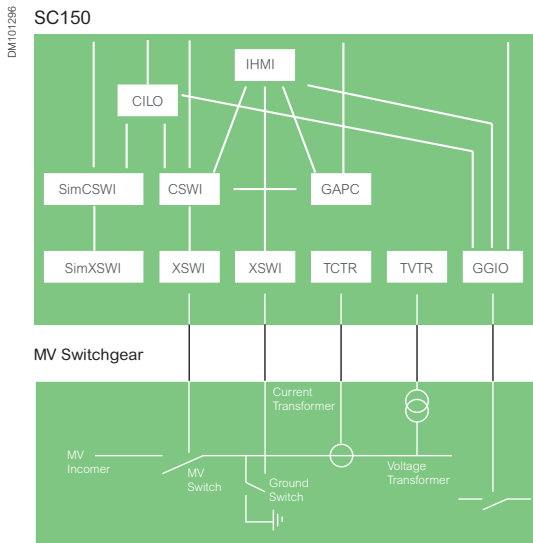

General SC150 Switch Control Scheme IEC 61850

Switchgear control settings

MainCSWI	Type of control point	Pulsing SPC or DPC Latched SPC or DPC SBO (select before operate) SPC or DPC if supported by SCADA protocol
	Pulse operating time	50 ms...20 s in 10 ms step
	Return position time (operation time out)	1 s...30 s in 100 ms step
MainXSWI	Type of status point	Single point status SPS Double point status DPS
	Double-bit intermediate state filtering time delay	1 s...30 s in 100 ms step
EarthXSWI	Type of status point	Single point status SPS Double point status DPS
FeaGGIO	Type of status point	Single point status SPS
	Change memory time	0: disable 5 ms...2 s in 1 ms step
General GGIO setting (SPS and DPS)	Debouncing time	0: disable 5 ms to 30 ms in 1 ms step
	Chatter filtering	Monitoring period: 0: disable - 5 ms...1 min in 1 ms step Maximum number of changes: 1...255 in 1 change step
MainCILO		Digital input 5 dedicated for interlocking: activate /deactivate

PowerLogic™ SC150 Switchgear Controller Unit

General description

Characteristics

Outputs	
Rated motor mechanism voltage	12 Vdc to 127 Vdc/90 Vac to 220 Vac
Rated voltage	250 Vac
Max switching voltage	440 Vac
Rated current	8 A
Limiting continuous current	8 A
Limiting making current, max 4s	15 A
Breaking capacity max	2000 VA
Typical motor control current	16 A for 50 ms and 6 A for 15 s
Input	
8 single or dual wet inputs (0V common) compliant to IEC 61131 -2	
Standard wiring	
2 SPS or 1 DPS	Switch opened Switch closed
1 DPS or 2 SPS or 1SPS	Ground switch closed Ground switch open
1 SPS	Switch interlocking
1 SPS	Voltage presence
2 SPS	Free

Connection example

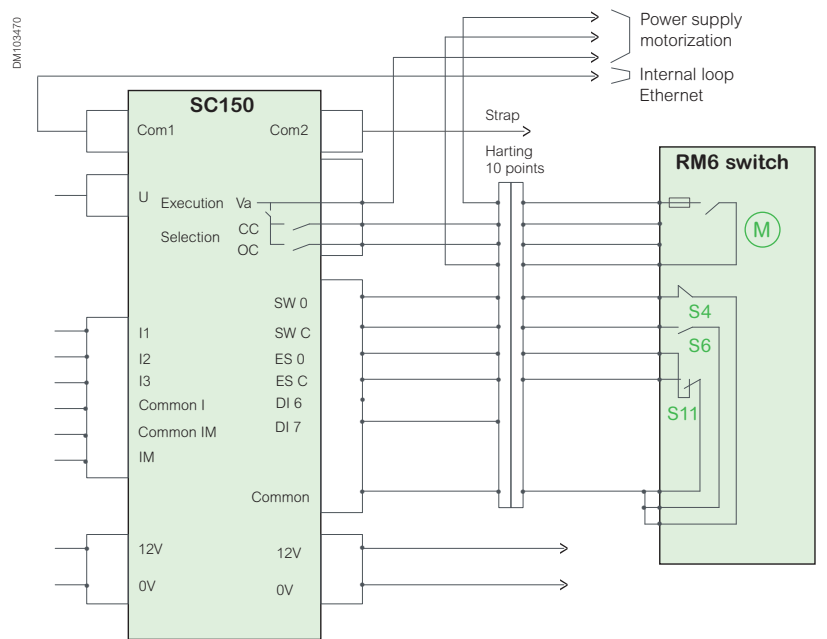

MV switch mechanics control wiring

PowerLogic™ SC150 Switchgear Controller unit

General description

MV current and voltage measurement

Sensor type:	1 phase mounting	2 phases mounting	3 phases mounting
VT			
LPVT		—	
VPIS/VDS/PPACS	—	—	

PowerLogic™ T300

Function unavailable :

- Directional fault current detection: ANSI 67, 67N
- Directional active over power: ANSI 32P
- Voltage monitoring: ANSI 27, 59, 47BC and 59N
- Power measurement
- Power quality

Current sensors mounting

Type A	Type B	Type C	Type D

Function unavailable :

- Sensitive earth fault overcurrent
- Computed earth fault overcurrent
- Phase fault overcurrent
- Directional active overpower
- Power measurement
- Power quality

PowerLogic™ SC150 Switchgear Controller Unit

General description

Voltage and current measurement

Switchgear controller			SC150-CAPA	SC150-LPVT
Part Numbers			EMS59202	EMS59201 EMS59203
Voltage adapters compatibility and part number				
VPI5-VO V3	EMS59577		●	●
VDS LR/LRM/LRP and VDIS	EMS59570			●
VDS HR	EMS59580			●
VT	EMS59572			●
LPVT				●
VDS LR/LRM/LRP	EMS59571		●	
PPACS	EMS59575		●	
Functions available				
Fault Passage Indication				
Phase overcurrent	50/51	PhPTOC	● ⁽⁴⁾	● ⁽⁴⁾
Earth/ground fault overcurrent (computed)	50N/51N	EfPTOC	● ⁽¹⁾	● ⁽¹⁾
Earth/ground fault overcurrent (measured)	50N/51N	SEfPTOC	● ⁽³⁾	● ⁽³⁾
Directional phase overcurrent	67	DPhPTOC	● ⁽²⁾⁽⁴⁾	● ⁽²⁾⁽⁴⁾
Directional earth/ground fault overcurrent Protection (1)	67N	DEfPTOC	● ⁽²⁾	● ⁽²⁾
Directional active overpower	32P			● ⁽¹⁾⁽²⁾
inrush restraint based on H2			●	●
Current and Voltage monitoring				
Phase undercurrent	37	AbsPTUC	● ⁽⁴⁾	● ⁽⁴⁾
Phase undervoltage	27	AbsPTUV	● ⁽²⁾	● ⁽²⁾
Phase overvoltage	59	PrsPTOV	● ⁽²⁾	● ⁽²⁾
Negative sequence overvoltage (Broken conductor)	47 BC	BcPTOV	● ⁽²⁾	● ⁽²⁾
Earth/ground fault overvoltage	59N	FPTOV	● ⁽²⁾	● ⁽²⁾
Measurement functions			MMXU	
Phase & residual RMS current values			● ⁽⁴⁾	● ⁽⁴⁾
Phase RMS voltage values			● ⁽⁴⁾	● ⁽⁴⁾
Phase fault pick-up current			● ⁽⁴⁾	● ⁽⁴⁾
Residual fault pick-up current			●	●
Phase and neutral voltage value			● ⁽²⁾	● ⁽²⁾
Demand value min & max, day, month, year			● ⁽²⁾	● ⁽²⁾
Power measurement according to Power Measurement Class 1 (as per IEC 61557-12)				● ⁽²⁾
Power quality according to Power Quality Class S (as per IEC 61000-4-30)				● ⁽²⁾
Control, monitoring, supervision				
Switchgear control and monitoring			●	●
Switchgear monitoring only			●	●
Programmable switchgear interlocking			●	●
Control with Mobile application			●	●
Local/remote function			●	●
Hit and Run Fcontrol			●	●
Setting groups			2	2
Logs and records				
Sequence of event record			●	●
Disturbance record			●	●
Automation functions associated				
Sectionalizer			⁽⁵⁾	⁽⁵⁾
Automatic Transfer Source (between SC150 modules)			●	●
Condition monitoring (thermal and environmental)			●	●

⁽¹⁾ Require 3 phase CT

⁽¹⁾⁽⁴⁾ not available with CT mounting C

⁽²⁾ Require 3 voltages measurement

⁽⁵⁾ require voltage measurement

⁽³⁾ Require Zero sequence CT: Mounting B, C or D

Voltage acquisition adapter

The different MV sensors used with the SC150 are summarized in Accessories Chapter.

PowerLogic™ SC150 Switchgear Controller Unit

Network monitoring

Advanced Fault Passage Indicator based on IEC 61850 data model and ANSI code

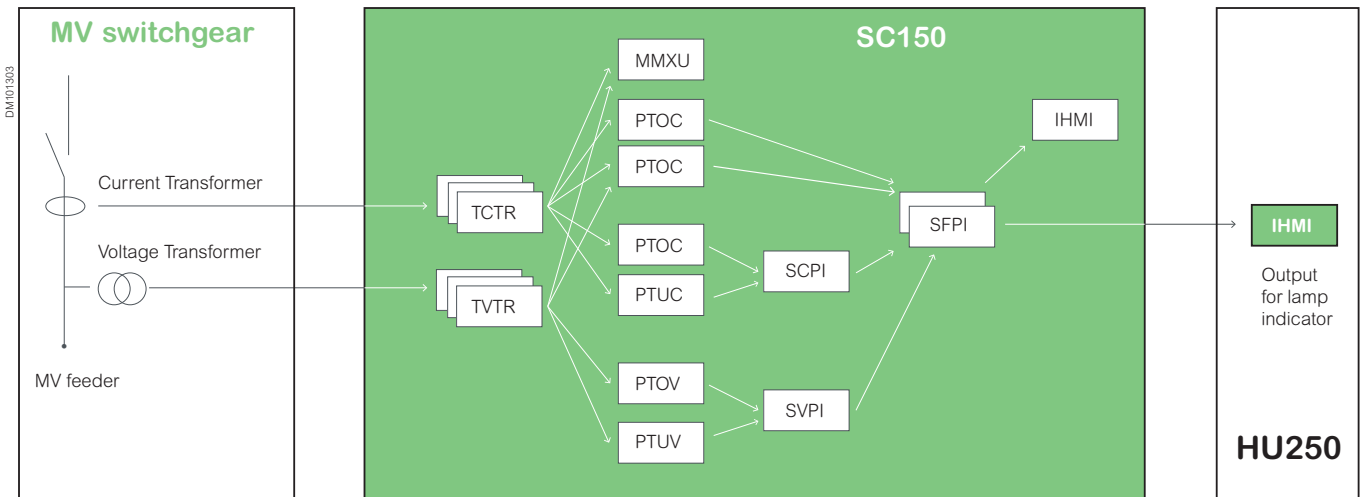

Logical node name:

SFPI

All types of fault currents are tracked

The SC150 offers a complete range of Fault Passage Indicators (FPI) needed to detect a fault current in any kind of neutral system with or without the presence of distributed energy resources on the MV or LV network

The FPI aim is to provide persistent indication of the presence or absence of a fault current and also track all non-permanent faults current in order to facilitate network maintenance and improve the quality of services.

The FPI function includes counters to memorize the type and the number of fault current, to be able to make diagnostics or statistics about the quality of the network.

The following FPI events can be activated and memorized:

- Permanent fault current: fault current confirmed by SVPI or SCPI
- Semi-permanent fault current: removed by the slow cycles of recloser (cycle 2 or cycle 3)
- Transient fault current: the overcurrent fault is self-cleared in the first recloser cycle of the upstream protection.
- Self-extinguishing fault currents: Detected fault currents that appear and disappear on the MV network, without tripping the upstream circuit breaker. This type of fault current is stored in the event log but not indicated by the LEDs on the T300.

Fault current detection confirmation

In order to detect a persistent or non permanent fault current on the network, a fault detection can be configured:

- Unconfirmed
- Confirmed by voltage dip from power supply
- Confirmed by voltage absence
- Confirmed by current absence

PowerLogic™ SC150 Switchgear Controller Unit

Network monitoring

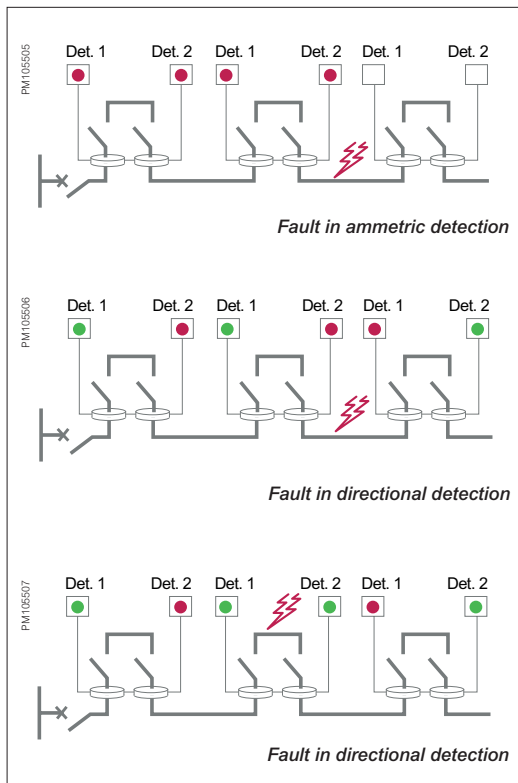

Examples of colors indicating a fault

Inrush filter

A filter for detecting transformer inrush current can be enabled on the T300 to help prevent spurious fault currents being detected on the MV network.

A current peak may occur on power-up of the MV network due to energization of the transformers and saturation of the phase CTs installed on the network. These current peaks may activate the fault current detectors falsely by tripping the configured thresholds.

To avoid this phenomenon, an algorithm is used to discriminate fault currents from transformer inrush currents on network power-up.

The algorithm for detecting the transformer inrush phenomenon is based on an analysis of the ratio between the second harmonic distortion and the fundamental current on the 3 network phase currents. The inrush filter becomes active when a high proportion of second harmonics are detected.

The inrush filter is only possible for ANSI 50/51, ANSI 50N/51N, and ANSI 67 type detection, and for instances 1 and 2 only.

The fault current detection is indicated:

- By two LEDs on each SC150 module
- By a flashing light outside the station
- Remotely to the SCADA system via the communication protocol

FPI reset

All types of fault current are memorized by the system during the outage in order to be able to locate the fault current on the network when it is not energized.

Memorized fault current can be cleared:

- By a timer delay, configurable
- By manual action on the front cabinet of HU250 (general reset for all modules)
- By remote control from the SCADA
- By return of voltage presence (configurable)

MV fault current detector Logical Nodes

The T300 fault detection algorithms are based on the ANSI standards as well as on a certain number of logical nodes (LN, as described in standard IEC 61850) each with their own specific role. These are given for information purposes in the table below.

LN Type Name	LN class	Description
PhPTOC	PTOC	Phase over-current detection (ANSI 50/51)
EfPTOC	PTOC	Ground fault over-current detection (ANSI 50N/51N)
SEfPTOC	PTOC	Sensitive ground fault over-current detection (ANSI 50N/51N)
BcPTOV	POTV	Broken conductor detection (ANSI 47)
DirPhPTOC	PTOC	Directional phase over-current detection (ANSI 67)
DirEfPTOC	PTOC	Directional ground fault over-current detection (ANSI 67N)
AbsPTUC	PTUC	Current absence detection
PrsPTOC	PTOC	Current presence
AbsPTUV	PTUV	MV feeder voltage absence.
PrsPTOV	PTOV	MV feeder voltage presence
SVPI	SVPI	Voltage presence indicator based on inputs from PTOV, PTUV
SCPI	SCPI	Current presence indicator based on inputs from PTOC, PTUC
SFPI	SFPI	Computation of MV fault passage indication based on fault detection on confirmation (SVPI and/or SCPI)

Description

This over-current fault detection is based on the fundamental component of the 3 phase current rms (CT mounting type A and D).

Setting groups

2 setting groups are available.
Each instance has its own settings in each setting group.
A control allows you to change from one setting group to another during operation.

Logical node name:

PhPTOCx

x being the number of the instance

Example of over-current detection

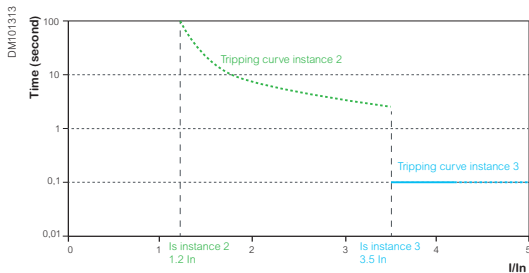

3 instances (fault detection) can run simultaneously with different settings:

- Instance 1: Disabled
- Instance 2: Enabled/IEC standard inverse /A
- Instance 3: Enabled/Definite Time (DT) curve

ANSI 50/51: Phase over-current fault detection

ANSI 50/51 : Over-current characteristics - LN: PHPTOC

Number of instances	3	
Setting groups	2	
Fault indication	<ul style="list-style-type: none"> • General fault current • Phase on fault current: instance 1, 2 or 3 	
Setting (per instance)		
Function activation by instance	<ul style="list-style-type: none"> • Disable • FPI only • FPI & sectionalizer 	
Detection mode	<ul style="list-style-type: none"> • Definite Time: All instance • Indefinite Time (IDMT): Instance 1 and 2 <ul style="list-style-type: none"> – IEC standard inverse/A – IEC very inverse/B – IEC extremely inverse/C – IEEE moderately inverse – IEEE very inverse – IEEE extremely inverse 	
Over-current threshold	DT	From 0.02 I_N ...10 I_N in 1 A step (1 A) From 0.02 I_N ...4 I_N in 1 A step (5 A)
	IDMT	From 0.02 I_N to 1 I_N in 1 A step
Time threshold	DT	0 (Instance 3 only)/0.05...300 s
	IDMT	0.1 s...12.5 s in 1 ms step
Reset time	DT	0 s - 0.05 s - 300 s in 1 ms step
Inrush filter (Instance 1 and 2)	Disabled/Enabled	

PowerLogic™ SC150 Switchgear Controller Unit

Network monitoring

Description:

Ground fault detection is based on residual current values measured by a core balanced current transformer (type C and D) or calculated from 3 phase current transformers (type A and D).

With the mounting type D, we can accommodate two ground fault detections:

- Calculated residual current from 3 phase current transformer
- Measured residual current from core balanced sensors for high sensitivity

Two information are available and managed independently:

- Ground fault
- Sensitive ground fault

Each instance of EF, and the SEF can be enabled/disabled by SCADA commands.

Ground fault and sensitive ground fault overcurrent detection: ANSI 50N/51N

Example of ground detection

3 instances (fault detection) can run simultaneously with different settings:

- Instance n°1: Disabled
- Instance n°2: Enabled/ IEC standard inverse /A
- Instance n°3: Enabled/ Definite Time (DT) curve

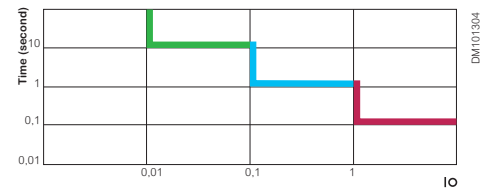

DM101304

Functions		Ground fault	Sensitive ground fault
Number of instances		3	1
Setting group		2	2
Fault current indication		Fault detected on one of 3 instances Cross country fault (instance 3)	Fault detected
Settings			
Function activation	By instance	Disable	
		FPI only	
		FPI & Sectionalizer	
Residual current acquisition	By instance	Io: measured with 1 A core balanced CT	
		Ires: calculated with sum of 3 phases currents	
Detection curve	3 instances	Definite time (DT)	
	Instances 1 and 2	IEC normal inverse time/A	
		IEC very inverse time/B	
		IEC extremely inverse/C	
		IEEE moderately inverse time	
		IEEE very inverse time	
		IEEE extremely inverse	
Over-current pick-up	DT	Io and Ires: 0.008 In or 0.4 A to 1.6 In	
	IDMT	Io and Ires: 0.008 In or 0.4 A to 1 In	
Operation time	DT	Instantaneous (instance 3 only) or 0.05 to 300 s	
	IDMT	0.1...12.5 s	
Reset time		0...300 s	
Inrush restraint		Enable/disable	

PowerLogic™ SC150 Switchgear Controller Unit

Network monitoring

Description:

The directional phase-to-phase short-circuit detection is based on the measurement of 3 phase current (type A and D) and voltage.

It can operate with different types of voltage inputs: refer to the voltage acquisition description.

Directional phase over-current fault detection: ANSI 67

ANSI 67 - Directional phase over-current Characteristics

Number of instances	2 instances can run simultaneously with different settings	
Setting groups	2 groups	
Fault current indication	Phase on fault current detected by instance with direction (forwards or backwards)	
Setting		
Function activation by instance	<ul style="list-style-type: none"> • Disable • FPI only • FPI + sectionalizer 	
Detection mode	<ul style="list-style-type: none"> • Definite Time • Indefinite Time (IDMT): <ul style="list-style-type: none"> – IEC standard inverse/A – IEC very inverse/B – IEC extremely inverse/C – IEEE moderately inverse – IEEE very inverse – IEEE extremely inverse 	
Over-current threshold (by instance)	DT	From $0.02 I_N$ to $4 I_N$ in 1 A steps
	IDMT	From $0.02 I_N$ to $1 I_N$ in 1 A steps
Time threshold (by instance)	DT	0.05 s to 300 s in 1 ms steps
	IDMT	0.1 s to 12.5 s in 1 ms steps
Reset time (by instance)	DT	0 to 300 s in 1 ms steps
Direction of the fault detected	Backward/Forward	
Inrush filter	Disabled/Enabled	
Detection angle	30° ; 45° or 60° (default value 45°)	

Simplified description of the directional phase over-current detection

The phase over-current function in the chosen direction (forwards or backwards) is activated if:

- At least one of the 3 phase currents is higher than the defined threshold (I_s) during the tripping time (T_s)
- The phase shift α between the current and its voltage polarization is ranged between $(\theta_0 + 90^\circ)$ and $(\theta_0 - 90^\circ)$, where θ_0 is the characteristic angle

The presence of 2 instances means that 2 directional phase over-current functions can run simultaneously with different settings and/or direction.

DM1103486

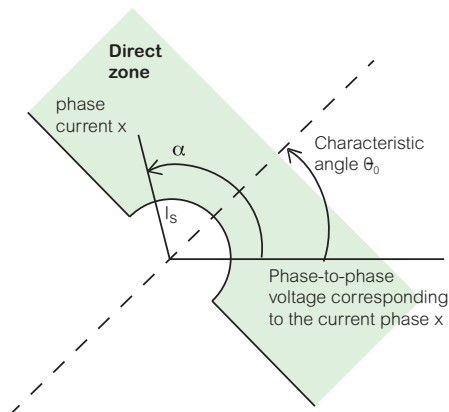

PowerLogic™ SC150 Switchgear Controller Unit

Network monitoring

Description:

The directional ground short-circuit detection is based on the measurement of residual current measured (type C and D) or calculated (type A and D) and the voltage.

It can operate with less accurate voltage sensors (capacitors) than VT or LPVT: refer to voltage acquisition description.

Each instance of EF, and the SEF can be enabled/disabled by SCADA commands.

There are 3 steps to fault detection:

1. The residual voltage must exceed the threshold Minimum residual voltage, during a longer time than Operate delay time threshold.
2. The direction of the fault current is determined by examining the current projected onto the residual voltage.
It is possible also by configuration to only validate faults with a high current peak during this transient phase.
3. The presence of the fault current detected in step 1 is then validated by residual voltage drop.

The presence of 2 instances means that 2 directional phase over-current functions can run simultaneously with different settings and/or direction.

Directional ground fault current detection: ANSI 67N

ANSI 67N - Characteristics

Number of instances	2 instances can run simultaneously with different settings
Setting groups	2
Fault current indication	Phase on fault current by instance with direction (forwards or backwards)

Directional ground over-current setting (by instance): 67

Function activation by instance	<ul style="list-style-type: none"> • Disable • FPI only • FPI + sectionalizer
Residual current acquisition	<ul style="list-style-type: none"> • I_{res} (by summation of the three phases) • I_0 (directly from the core balanced CT)
I_0 (directly from the core balanced CT)	Definite Time
Minimum residual voltage threshold	6...30% V_n in 1% steps
Operate delay time	0.05...300 s in 1 ms steps
Reset delay time	0...300 s in 1 ms steps
Direction of the fault	Backward/Forward
Validation by residual current and voltage peaks	Disabled/Enabled (current and voltage)
Minimum (blocking) operating current	I_{res} : 0.015 I_N to 2.3 I_N in 1 A steps I_0 : 0.01...2.3 I_N in 0.5 A from 0.5...10 A then 1 A steps
Minimum (blocking) operating voltage	6...60% V_n in 1% steps Only when the sensor is different from a VPIS. This threshold is considered only if the validation with sample threshold is enabled

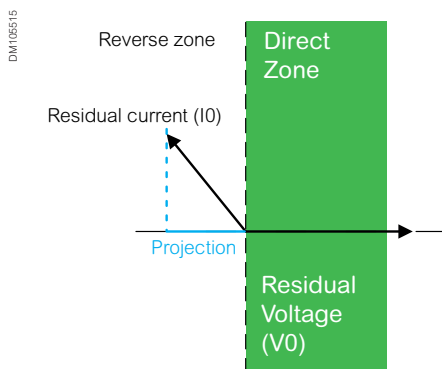

Principle of projecting the residual current onto the residual voltage to determine the direction of the fault current.

PowerLogic™ SC150 Switchgear Controller Unit

Network monitoring

Description:

Directional active overpower is a two-way detection based on:

- Active overpower detection
- Reverse active power detection: to detect overload or abnormal power flow on the distribution network.

This function allows to detect distributed generation injection on the network.

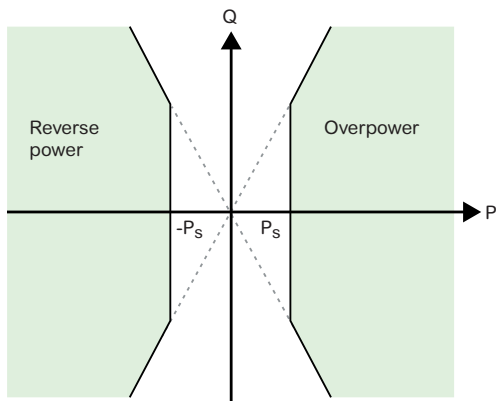

Operating zone

Directional active overpower: ANSI 32P

This function may be used as:

- **Active overpower detection** for MV network energy management to detect overloads (or maximum power) and allow load shedding
- **Reverse active power** to help detect
 - Power injection from distributed production if the measure is done on transformer incomer
 - Abnormal power flow if the measure is done on the feeder (MV line switchgear).

The power sign is determined according to the general feeder or incomer parameter, according to the convention:

For feeder incomer	For feeder outgoing
<ul style="list-style-type: none"> • Power exported by the busbar is positive • Power supplied to the busbar is negative. 	<ul style="list-style-type: none"> • Power supplied to the busbar is positive • Power exported by the busbar is negative

Parameter	Setting
Direction	<ul style="list-style-type: none"> • Forward - to network • Reverse - to busbar
Phase Pick-up	1...120 % of nominal apparent power $S_n = \sqrt{3} \cdot U_{np} \cdot I_n$.
Time delay	0.1...300 s

PowerLogic™ SC150 Switchgear Controller Unit

Network monitoring

Description:

Detection of phase balances resulting from phase inversion or unbalanced supply, detected by the measurement of negative sequence voltage.

It allows detecting a loss of one or two phases on medium voltage network (broken conductor) and sends an alarm to the control center.

Associated with ANSI 47, detection on the LV side with LV150, PowerLogic™ T300 can detect a blown fuse in the substation (forwards and backwards of the MV/LV transformer).

Negative sequence overvoltage – ANSI 47 Voltage broken conductor detection

Voltage broken conductor characteristics

Number of instances	3 instances can run simultaneously with different settings
Setting groups	2
Fault current indication	Fault current detected
Broken conductor setting (by instance)	
Function activation by instance	<ul style="list-style-type: none"> • Disable • FPI only • FPI + sectionalizer
Phase voltage detection threshold	10...100% Vn in 1% step
Operating time delay:	0...300 s in 1 ms step
Fault detection reset	<ul style="list-style-type: none"> • Reset voltage threshold: 2...30% Vn • Reset time delay: 0...300 s in 1 ms step

Description:

Detection of insufficient or unbalanced network voltage to trigger:

Instances 1 et 2 :

- ANSI 27 : Network monitoring (indication)

Instance 3 :

- Network presence for:
 - Fault Passage Indicator validation
 - HMI Network presence indication
 - Automation

Characteristics:

- Measured quantity is phase-to-phase voltage or phase-to-neutral voltage
- Each phase is monitored

Undervoltage - ANSI 27

Characteristics

Number of instances	3
Setting groups	2
Detection mode	Definite time
Reset ratio (hysteresis)	106%
Setting	
Measured voltage	3 phase-ground
Operation mode	On any phase
Us < threshold	10...100% Vn in 1% step
DT time delay	0...300 s in 1 ms step
Reset time delay	0...300 s in 1 ms step

PowerLogic™ SC150 Switchgear Controller Unit

Network monitoring

Description:

Detection of abnormally high network voltage or checking for sufficient voltage to enable:

Instances 1 et 2 :

- ANSI 59 : Network monitoring (indication)

Instance 3 :

- Network presence for:
 - Fault Passage Indicator validation
 - HMI Network presence indication
 - Automation

Characteristics:

- Measured quantity is single phase
- The voltage presence is set when all phases are confirmed
- The overvoltage presence is set when any phase is detected on fault

Overvoltage – ANSI 59

Characteristics

Number of instances	3
Setting groups	2
Detection mode	Definite time
Reset ratio (hysteresis)	93%
Setting	
Measured voltage	Phase-ground
Operation mode	On any phase or on all 3 phases
Us < threshold	20...200% Vn in 1% step
DT time delay	0 ms...300 s in 1 ms step
Reset time delay	0...300 s in 1 ms step

Description:

Detection of abnormal voltage by measuring residual voltage to trigger:

Instances 1, 2 and 3:

- ANSI 59N : Residual voltage detection (indication)

Characteristics:

- Residual voltage can be calculated or measured.

Neutral voltage displacement – ANSI 59N

Characteristics

Number of instances	3
Setting groups	2
Detection mode	Definite time
Reset ratio (hysteresis)	93%
Setting	
Measured voltage	Phase-phase/phase-ground
Us < Threshold	10...200% Un in 1% step (phase-ground)
DT time delay	0...300 s in 1 ms step
Reset time delay	0...300 s in 1 ms step

PowerLogic™ SC150 Switchgear Controller Unit

Network monitoring

Description:

Used to confirm network absence on 3 phases to trigger:

- FPI detection confirmation
- Load shedding or source transfer automation for example.
- Network absence indication

Characteristics:

- Sensitive to the lowest value of the phase currents

Undercurrent – ANSI 37

Characteristics

Number of instances	1 (presence/absence)
Setting groups	1
Reset ratio (hysteresis)	0.2% x I _n
Setting	
I < Threshold (37)	0.002...0.02 I _n in 0.1 %
DT time delay	0 ms to 300 s in 1 ms step

Description:

Used to record measured analog signals, digital input signals and logical states

Depending on the trigger position setting, the stored event can begin before the event and continues afterwards

The record files can be downloaded from T300 Web server

Characteristics:

Records comprise the following information:

- Values sampled from the different signals
- Date

The record is activated by one or more of the following events (for each SC150):

- Actual samples at a rate of 4,800 samples per second for current and/or voltage.
- Any change regarding the following information:
 - Network presence
 - Fault indication (ANSI 50/51, 50N/51N, 67/67N, 47)
 - Voltage event (ANSI 59/59N)
 - Power Quality event
 - Main switch status (DI1 and DI2)
 - Digital inputs (DI3 to DI8)

Disturbance Recording

Characteristics

Recording content	<ul style="list-style-type: none"> • Set-up file: date, channel characteristics, sampling rate • Sample file: recorded signals
Sampling frequency	4,800 samples per second
Analog signals recorded	<ul style="list-style-type: none"> • I_a, I_b, I_c, I₀ (measured) • V_a, V_b, V_c or U_{ab}, U_{bc}, U_{ca}
Logical states recorded	Digital input signals and logical states
Number of recordings stored	Up to 50 (when the maximum number of records is reached, the oldest record is erased)
Total duration of a recording	100...70,000 ms
Maximum recording capacity	140 s maximum with 70 s maximum per record
File format	COMTRADE - IEC 60255-24 Ed. 1...2001
Setting	
Recording duration	100 to 70,000 ms
Trigger position	0 to 100%
Trigger on:	<ul style="list-style-type: none"> • Network presence (any change) • Fault indication (ANSI 50/51, 50N/51N, 67/67N, 47) • Voltage event (ANSI 59 or 59N) • Power Quality event (dip, swell or interruption) • Digital input 1...8 (rise, fall or any change)

The SC150 can directly manage the sectionalizer automation associated with a Load Break Switch (LBS) for overhead line management.

The LBS can be installed in an underground substation or overhead pole top.

Sectionalizer automation

Sectionalizer automation is used on an MV overhead line or an underground to overhead line. It requires a circuit breaker-recloser at the head of the line.

The role of this automation function is to command the opening of the MV switch managed by the SC150 after a defined number of fault current have been detected during successive unsuccessful reclose cycles of the upstream recloser. The sectionalizer automation function therefore converts a switch into a sectionalizing switch.

The disconnection logic is used to isolate the section exhibiting the abnormal operation condition by opening the switch during the voltage sag of the reclose cycle.

Sectionalizer automation can be enabled individually on each SC150 module on the PowerLogic™ T300.

The automation function is enabled or disabled globally on the PowerLogic™ T300 (for all SC150 modules) either remotely from the SCADA system or locally:

- By pressing the "ON" button on the front of the HU250 module
- Via the Web server

Operation

In normal operating conditions the MV network is energized, and the switch is closed.

The automation function sends an open command to the MV switch if:

- Automation is enabled on the channel
- The switch is closed
- The number of detected fault currents reaches the number configured (Reclose cycles number)
- The voltage is absent

The automation cycle is reset at the end of the **Primary CB recloser maximum operation time**.

The detected fault currents counter is reset at the end of this time delay.

Automation remains inactive if the number of detected fault currents counted during this time period does not reach the value defined by setting.

The voltage source used to detect the absence of the MV network during the cycle can be acquired and defined in different ways :

- By voltage measurement sensors
- By digital input
- By the AC power supply (in this case, the T300 must be powered by a low voltage source from the MV line on which the switch is installed)

Blocking Automation

Certain conditions can block the automation function. The automation blocking conditions are associated with any action that makes it impossible to operate the MV switch, namely:

- If the T300 is in local mode and the "Enable local mode to block automation" option is enabled by configuration
- If the switch interlock digital input is enabled and the "External input mode for open commands" blocking option is enabled by configuration
- If the switch position is unknown at the time of the command and the "Block if switch position is unknown or same as command" option is enabled by configuration

DM103487



DM103488

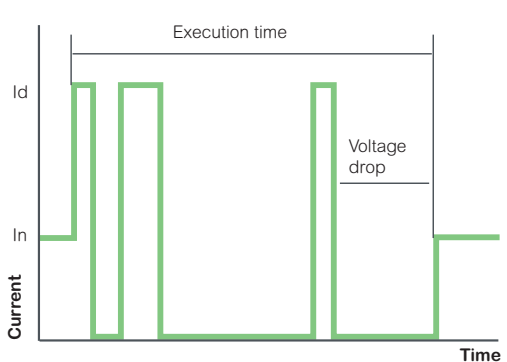

Characteristics

Setting groups	2 groups
Automation indication	<ul style="list-style-type: none"> • Automation on • Automation off • Automation locked

Sectionalizer setting

Sectionalizer active	Enable/Disable
Number of reclose cycles before opening	1...4
Maximum execution time after fault detection	20 s to 5 min in 1 s step
Enable lockout on switch operation failure	Enable/Disable
Direction mode	Forward, backward, both

PowerLogic™ SC150 Switchgear Controller Unit

MV Power monitoring

Power measurement and Power quality

General characteristics

Standards	
Power measurement as per	IEC 61557-12/ PMD/SD/K70/1
Power quality as per	IEC 61000-4-30 class S
General	
Current accuracy	0.5% from 0.1 In to 1.2 In
Voltage accuracy	0.5% from 20% Un to 120% Un
Active power	1%
Active energy accuracy	1%
Frequency range	45 to 67 Hz

Utilities are coming under increasing pressure from both customers and regulatory bodies alike to review the quality of power they are providing (EN50160).

This requires monitoring of their networks for various indices such as number of and duration of outages, dip/swell voltages and system harmonics.

The SC150 offers many high performance capabilities to meter and monitor the MV network with the same current and voltage sensors without the need to add an expensive specialized device.

PowerLogic™ T300 has a large capacity of storage for SCADA transmission and/or local consultation. All recorded measurements are consultable via the web server locally or remotely with trends and diagram or table. The measurement log can be also downloaded in Excel format.

Measured and metered values

	Base	PM option	Power quality option
Instantaneous RMS values			
Current	<ul style="list-style-type: none"> • 3 phase and residual • 3 phase average 		
Voltage	<ul style="list-style-type: none"> • 3 phase and residual • 3 phase average 		
Frequency	•		
Overcurrent pick-up	•		
Last current demand value before fault detection or switch opening	•		
Last voltage demand value before fault detection	•		
Last voltage value before broken conductor fault detection	•		
Active, reactive, apparent power (total & per phase)		Signed	
Power factor (Total & per phase)		Signed	
Energy values			
Active, reactive, apparent energy		Signed	
Configurable accumulation mode		•	
Demand values			
Voltage & current		•	
Active, reactive, apparent power		•	
Synchronization of the measurement window		•	
Demand windows calculation mode		•	
Power quality measurement			
Harmonic distortion – current and voltage (up to H40)			•
Individual harmonics – current and voltage (up to H40)			•
Voltage dip and swell events			•
Events			•
Voltage and current unbalance			•
Voltage magnitude			•
Data recording			
Average current rms Min/max :	1 day, 7 days, 1 month, 1 year		
Demand values:	At 3 months		
Event logs	•		
Alarms	•		
Counter	•		

PowerLogic™ SC150 Switchgear Controller Unit

MV Power monitoring

Measured and metered values setting

Demand value		
Demand computed mode	Block (synchronized on the T300 RTU clock from the HU250)	
Demand value computed period	Demand value computed period 1, 2, 5, 10, 15, 20, 30, 60 minutes	
Minimum and maximum value	By day, 7 days, 1 month, 1 year	
Power quality Voltage setting		
Voltage swell	Threshold	100...150% of Un
Voltage dip	Threshold	5...100% of Un
Voltage dip and swell short duration	DT time delay	10 ms to 60 s (2 instances)
Voltage interruption	Threshold	1...90% of Un
Voltage interruption duration	DT time delay	60...900 s
Current unbalance	Threshold	1...100% of In
	DT time delay	200 ms to 60 s
Voltage unbalance	Threshold	1...100% of In
	DT time delay	200 ms to 60 s

PowerLogic™ SC150 Switchgear Controller unit

Characteristics

General characteristics

Voltage input (with voltage adapter)		
Type of sensor input	<ul style="list-style-type: none"> • LVPT as per IEC 61869-7 • VT as per IEC 61869-3 • Schneider VPIS as per IEC 62271-206 with voltage output • VDS LRP, LRM, LR and HR with voltage output as per IEC 61243-5 • External divider capacitor mounted on the MV cable head 	
Voltage input wiring	Single phase or 3 phases	
Input impedance	SC150 for capacitive adapter interface: 4 MΩ SC150 for LPVT-VT adapter interface: 10 MΩ	
Phase rotation	Yes/no	
Voltage characteristics		
MV voltage range	rated voltage (Un)	3 to 36 KV extended to 59,000 for Single line VT connection
	Frequency	45 to 67Hz
Metering range	0.1 to 4 Un	
Capacitor rated value VPIS, VDS and PPACs	Automatic calibration	
LPVT	Rated value	0 V to 10 V in 0.001 V step
	Magnitude correction	0.5 to 2.0 in 0.00001 step Phase angle: -180° to +180°
VT	Secondary rated value	50 V to 250 V in 0.001 V step
	Magnitude correction	30 to 60 in 0.001 step
Current input		
CT mounting	<ul style="list-style-type: none"> • Type A: I1, I2, I3 • Type B: I1, I3, I0 • Type C: I0 • Type D: I1, I2, I3, I0 	
Primary rated value	Phase CT	50 to 1250 A
	core balance CT	50 to 1250 A

PowerLogic™ SC150 Switchgear Controller unit

Characteristics

Secondary rated value	Phase CT	1 or 5 A
	core balance CT	1 or 5 A
CT inversion		Configurable by CT
Current characteristics		
Measurement range	Phase CT	<ul style="list-style-type: none"> 0.01...20 In (CTs = 1 A) 0.01...7 In (CTs = 5 A)
	Core balance CT	0.01...7 In
Permissible overload		<ul style="list-style-type: none"> 10 A continuous 50 A - 10s per hour 120 A -1s
Input Impedance		1 mΩ
Burden		0.025 VA
Power supply		
Voltage input	12V to 48V dc (-15%, +20%)	
Burden	2 VA; max typical	
Functions		Setting
Phase Pick-up	5...50%	
Residual Pick up	5...50%	
Time delay	25 ms fixed. The 25 ms time delay is aimed at avoiding unwanted Tripping or delay the overcurrent protection functions when they are set to instantaneous.	

PowerLogic™ SC150 Switchgear Controller Unit

Characteristics

Electrical characteristics

Dielectric compatibility			
Dielectric	IEC 60255-27	Common mode (CM):	<ul style="list-style-type: none"> Insulation (50 Hz/1 min.): 2 kV Surge (1.2/50 µs): 5 kV
Electromagnetic compatibility/Immunity			
Electrostatic discharge	IEC 61000-4-2 Level 4/Criteria B	15 kV in air 8 kV at contact	
Radiated RF electromagnetic fields	IEC 61000-4-3 Level 4/Criteria A	30 V/m – 27 MHz to 6 GHz	
Fast transients	IEC 61000-4-4 Level 4/Criteria A	Power supply, Ethernet	CM: ±4 kV 5...100 kHz
		Other circuits	CM: ±2 kV 5...100 kHz
Surge	IEC 61000-4-5 Power supply: Level 4/Criteria A Other circuits: Level 3/Criteria A	<ul style="list-style-type: none"> CM: 2 kV - wave 1.2/50 µs DM: 1 kV - wave 1.2/50 µs 	
Conducted RF disturbances	IEC 61000-4-6 Level 3/Criteria A	10 Veff 0.15...80 MHz	
Power frequency magnetic field	IEC 61000-4-8 Level 5/Criteria B	<ul style="list-style-type: none"> 100 A/m – 50 Hz enduring 1000 A/m from 1...3 s 	
Immunity to voltage dips	IEC 61000-4-29 Criteria A	Voltage dip:	<ul style="list-style-type: none"> 24 Vdc: 100 ms 48 Vdc: 500 ms
		Voltage interruption:	<ul style="list-style-type: none"> 24 Vdc: 100 ms 48 Vdc: 500 ms
Pulse magnetic field immunity	IEC 61000-4-9 Level 5/Criteria A	1000 A/m	
Conducted common mode disturbance	IEC 61000-4-16 Level 4/Criteria A	CM: 30 V for 15 Hz to 150 kHz 300 V during 1 s	
Damped oscillatory waves	IEC 61000-4-18 Level 3/Criteria A	CM: 100 kHz, 1 MHz, 3 MHz, 10 MHz, 30 MHz - 2 kV	
Emission tests			
Radiated disturbances	CISPR22	Class A (EN5502)	

Criteria A definition: The unit shall continue to operate as intended during and after the test. No degradation of performance or loss of function is allowed below a performance level specified by the manufacturer, when the apparatus is used as intended. The performance level may be replaced by a permissible loss of performance.

Criteria B definition: The unit shall continue to operate as intended after the test. No degradation of performance or loss of function is allowed below a performance level specified by the manufacturer, when the apparatus is used as intended. The performance level may be replaced by a permissible loss of performance. During the test, degradation of performance is however allowed. No change of actual operating state or stored data is allowed.

PowerLogic™ SC150 Switchgear Controller Unit

Characteristics

Environmental characteristics

Environmental conditions		
Operating temperature	IEC 60068-2-1	-40...+70 °C
	IEC 60068-2-2	
Storage temperature	IEC 60068-2-1	-40...+85 °C
	IEC 60068-2-2	
Damp heat, steady state	IEC 60068-2-78	93% HR, 40 °C, HR no condensation , 56 days
Change of temperature	IEC 60068-2-14	-40...70 °C, 5 °C/min, 10 Cycles, 27 h without condensation
Damp heat, cyclic	IEC 60068-2-30	144 h: 6 cycles of 24 h (+55 °C, 93% HR during 9 h; +25 °C, 95% HR during 6 h)
Salt spray test	IEC 60068-2-11	168 h
Product safety standards		
Protection of persons and goods	IEC 60255-27	
Fire resistance	IEC 60695-2-11	850 °C
Power supply		
Rated supply voltage		12...48 Vdc (+/-20 %)
Power consumption		< 2 VA

Mechanical characteristics

Degree of protection	IEC 60529	<ul style="list-style-type: none"> • Front cabinet: IP4x • Module body: IP2x
Robustness	IEC 62262	IK7 2 J
Vibrations	IEC 60068-2-6	10 - 2000 Hz/1g (peak value) 10 cycles
Bumps	IEC 60068-2-29	10 g/16 ms/1000 Bumps "non energized"
Shocks	IEC 60068-2-27	10 Gn/11 ms/3 pulses "in operation"
Weight		0.515 kg
Dimensions (H x W x D)		140 mm x 45 mm x 140 mm

PowerLogic™ SC160

Switchgear Controller Unit

PowerLogic™ SC160 Switchgear Controller unit

General description

Advanced functions for MV line and switchgear management in a compact box

- Switchgear control and monitor
- Circuit Breaker protection function
- Fault current detection
- Voltage monitoring
- Power measurement
- Power quality
- Sectionalized automation
- Embedded operator HMI
- Disturbance recording

PowerLogic™ SC160 is a modular switchgear controller configurable as protection with Circuit Breaker (CB) use or Fault current indicator with Low Break Switch (LBS) use. SC160 is a component of PowerLogic™ T300 ecosystem and must be associated HU250.

SC160 modularity allows to use the same module in MV public distribution network and just adapt the application in CB or LBS by simple configuration.

SC160 is a compact module which allows in one module to protect, control and monitor any kinds of MV switchgear:

- MV LBS or CB control and monitor
- MV current and voltage measurement
- Fault Current detection or protection functions configurable
- MV voltage monitoring
- Power measurement and Power quality
- Local automation

The MV switchgear monitoring to be extended to condition based monitoring, thermal and environment with TH110 and CL110 wireless sensors and HU250 ZigBee communication.

MV Network Control and Monitoring

Protection or fault passage indication function

The protection function or fault current detections are:

- Phase overcurrent (ANSI 50/51)
- Ground/earth fault overcurrent (ANSI 50N/51N)
- Directional phase overcurrent fault (ANSI 67)
- Directional ground/earth fault overcurrent (ANSI 67N)
- Cold load pickup
- Inrush restraint

Current and voltage monitoring

MV Current and Voltage monitoring enables the PowerLogic™ T300 to detect anomalies on the MV Network. Some standard detections help to detect these anomalies:

- Undervoltage (ANSI 27)
- Overvoltage (ANSI 59)
- Neutral overvoltage (ANSI 59N)
- Broken Conductor on Negative Sequence Overvoltage (ANSI 47)
- Undercurrent (ANSI 37)
- Voltage and Current unbalanced (power quality option)
- Voltage dip and swell (power quality option)
- Voltage and current Harmonic (individual and THD) (power quality option)
- Overcurrent fault current value memorization



SC160 Part Number

Reference	Description
EMS59210	SC160-CT-VT/LPVT current transformer interface – VTs and LPVT voltage interface

PowerLogic™ SC160 Switchgear Controller unit

General description

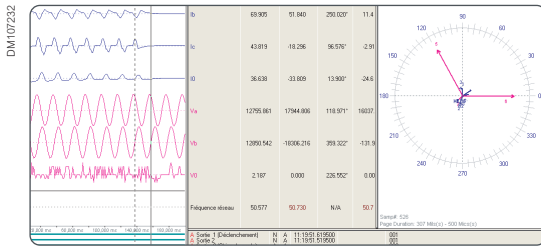

Oscillography analysis such as Wavewin

Post fault recording

Each SC160 has a disturbance recording application in order to understand what has happened on the grid after a network outage. All voltage and current measured, power quality events and events can be recorded with an accurate time tagging.

Depending on the trigger position setting, the stored event can begin before the event and continues afterwards. Records comprise the values sampled from the different signals and the date.

The disturbance file (Contrade file as per IEC 60255-24) can be displayed with disturbance viewer as Wavewin - Schneider tool. Files can be transferred locally using a PC connected to the Web server.

MV Power measurements and power quality

Advanced power measurement and power quality are available on each SC160 in accordance with EN50160 directive:

- Power measurements according to the principles of IEC 61557-12
- Voltage power quality according to the principles of IEC 61000-4-30 class S

PowerLogic™ SC160 Switchgear Controller unit

General description

Local operator front panel (HMI)

Display of information by colored LEDs

- Module status
- Alarm status
- Local/remote status (information provided by the HU250 module or by the SC160 module if DI7 is used for Local status external activation)
- Automation status: ON/OFF and lock status

3 customizable LEDs, according to FPI or protection functions

Switch status

- Main switch position (open, closed, intermediate)
- Ground/earth switch position

TRIP/Fault detection and voltage indications

- Fault detection status with direction
- Voltage presence status

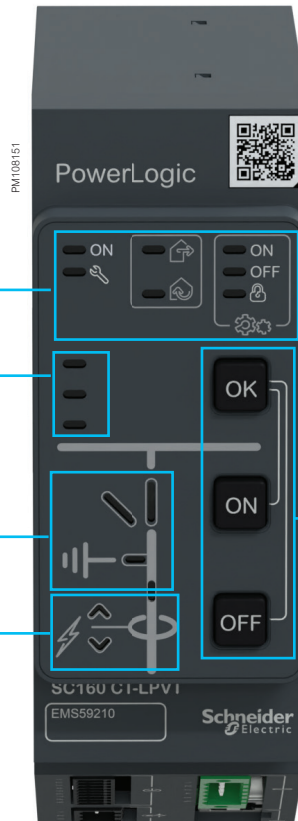

Local operator switch control and trip reset

The local switch control is allowed when the operating mode on the HU250 is set to local:

- In Local mode: the command from the operator cabinet is confirmed, any order from the remote control center is locked
- In Remote mode: local commands are not permitted, orders from the remote control center are validated
- Trip reset: the operator must press OK buttons for 3 seconds
- Switch control: the operator must press the OFF or ON buttons and the OK button.
- The local control can be enabled/disabled by configuration

Automation system activation

The automation system is activated and deactivated globally by pressing the control and validation buttons at the same time on the HU250.

Daisy chain LAN

- Internal Ethernet LAN for PowerLogic™ T300 modules
- Ethernet 10/100 Base

Switchgear status

- 8 singles or duals Wet input (0 V common)
- Compliant to IEC 61131 -2

Switchgear control

2 digital outputs configurable

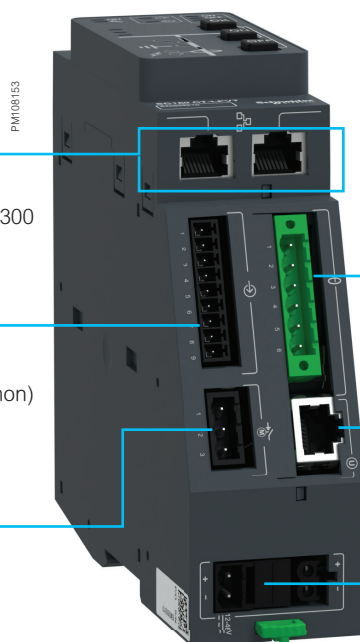

Current acquisition

4 current inputs with standard CT

Voltage acquisition

3 phase acquisition through RJ45 interface and accessory sensors

Daisy chain power supply

12-48 Vdc

PowerLogic™ SC160 Switchgear Controller unit

General description

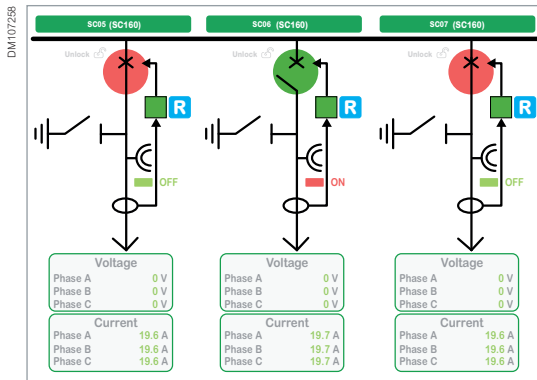

T300 webserver substation webview with SC160 configured as Fault detection with LBS and protection with circuit breaker

Switchgear operation

The switch control settings are used to adapt to a large variety of type of switch. The management of switch position control and command signals is specific to each switch type. A ready-to-configure switchgear control is provided to all motor mechanism control:

- Single or double point fixed width control
- Single or double point latched control
- Simple or double point with status return control

Commands can be issued from a variety of sources. Remote commands are received from control center system via the HU250. Local commands are received via the buttons on the module front panel or via the Web server pages. Commands can also be received via the automation functions. The command execution is controlled by interlock function. It rejects a command if the execution conditions are not fulfilled. Most of these conditions are configurable.

A SC160 configured as protection, the tripping output cannot be blocked.

To help the reliability of the operation, the switch command is executed via two serial relays: selection and execution. These relays are managed by two independent microcontrollers. If only one relay is activated or if the "select relay" does not return to normal position, the switch command is not performed or locked and an alarm is generated.

Switchgear control

Switchgear control functions

Logical nodes	Data Object	Description
XSWI	MainXSWI	MV switchgear position status
CSWI	MainCSWI	Switchgear control function
SSWI	MainSSWI	Switchgear supervision
PhXSWI	OpCnt	Number of operations
SCSWI	SimCSWI	Dummy control simulated position control
XSWI	SimXSWI	Dummy control simulated position status
XSWI	EarthXSWI	Ground switch position status
CILO	MainCILO	Switchgear Interlocking
GGIO	FeaGGIO	Other inputs
GAPC	SecGAPC	Sectionalizer (SEC) automatic control

PowerLogic™ SC160 Switchgear Controller unit

General description

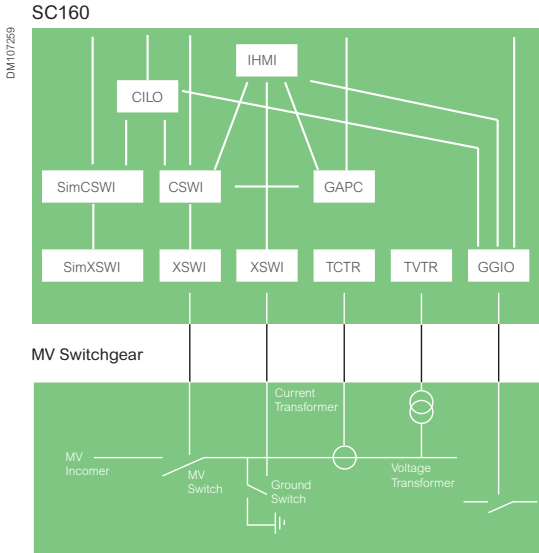

General SC160 Switch Control Scheme IEC 61850

Switchgear control settings

MainCSWI	Type of control point	<ul style="list-style-type: none"> Pulsing SPC or DPC (fixe or on status return) Latched SPC or DPC SBO (Select Before Operate) SPC or DPC if supported by SCADA protocol
	Pulse operating time	<ul style="list-style-type: none"> 50 ms to 20 s in 10 ms step
	Return position time (operation time out)	<ul style="list-style-type: none"> 1...30 s in 100 ms step
MainXSWI	Type of status point	<ul style="list-style-type: none"> Single point status SPS Double point status DPS
	Double-bit intermediate state filtering time delay	<ul style="list-style-type: none"> 1...30 s in 100 ms step
EarthXSWI	Type of status point	<ul style="list-style-type: none"> Single point status SPS Double point status DPS
FeaGGIO	Type of status point	<ul style="list-style-type: none"> Single point status SPS
	Change memory time	<ul style="list-style-type: none"> 0: disable 5 ms to 2 s in 1 ms step
General GGIO setting (SPS and DPS)	Debouncing time	<ul style="list-style-type: none"> 0: disable 5...30 ms in 1 ms step
	Chatter filtering	<ul style="list-style-type: none"> Monitoring period: 0: disable - 5 ms to 1 min in 1 ms step Maximum number of changes: 1...255 in 1 change step
MainCILO		<ul style="list-style-type: none"> Digital input 5 dedicated for interlocking : activate/deactivate

PowerLogic™ SC160 Switchgear Controller unit

General description

The SC160 offers many capabilities to measure and monitor MV current and voltage.

The function available depends on the kind of sensors.

According to the selection table, the function available are:

- Overcurrent fault indication
- Overcurrent protection
- Voltage measurement and monitoring
- Power measurement
- Power quality
- Automation

MV current and voltage measurement

SC160 is compatible with standard current sensors as per IEC 61869-2

The measuring current sensors available in PowerLogic™ T300 catalogue can be used for Fault current detection function. For protection function the current sensors shall be class P according to this standard with 1 A rated secondary current (for example 5P10). The FPI function can be use with CT 5 A at secondary.

Voltage measurement can be performed using three types of sensors:

- LPVT (Low Power VTs) as per IEC 61869-7
- Standard MV/LV VTs with secondary from 57 Vac to 250 Vac as per IEC 61869-3
- Schneider VPIS-V3 (Voltage Presence Indicating System) as per IEC 62271-206 with voltage output. The protection functions are not available with VPIS-V3.

Voltage measurement

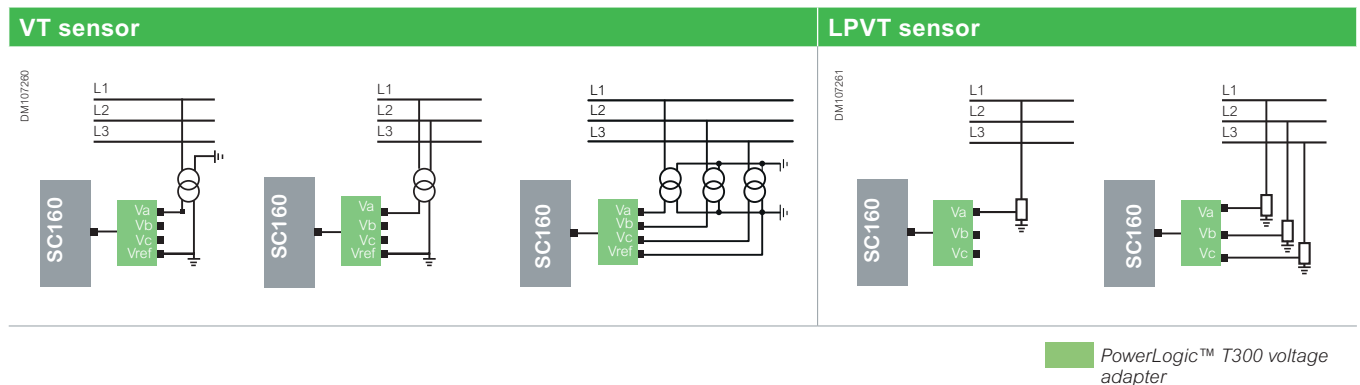

Current sensors mounting

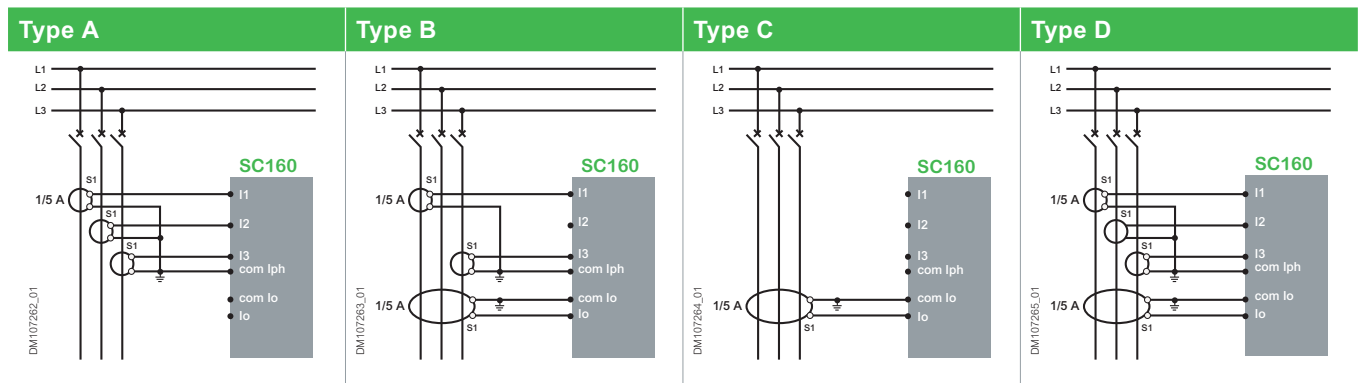

PowerLogic™ SC160 Switchgear Controller unit

General description

Voltage and current measurement

Switchgear controller			SC160 CT-LPVT
Part Numbers			EMS59210
Voltage adapters compatibility and part number			
VPIS V3	EMS59577		●
VDS LR/LRM/LRP	EMS59571		
PPACS	EMS59575		
VT	EMS59572		●
LPVT	EMS59573		●
Functions available			
Protection Functions	ANSI code	IEC 61850 Logical Node	
Phase overcurrent	50/51	PhPTOC	● ⁽⁴⁾⁽⁶⁾
Earth/ground fault overcurrent (computed)	50N/51N	EfPTOC	● ⁽¹⁾⁽⁶⁾
Earth/ground fault overcurrent (measured)	50N/51N	SEfPTOC	● ⁽³⁾⁽⁶⁾
Directional phase overcurrent	67	DPhPTOC	● ⁽²⁾⁽⁴⁾⁽⁶⁾
Directional earth/ground fault overcurrent Protection (1)	67N	DEfPTOC	● ⁽²⁾⁽⁶⁾
Cold load pickup (CLP or CLPU)			● ⁽⁶⁾
Magnetizing inrush detection (H2)	68H2		● ⁽⁶⁾
Fault Passage Indication			
Phase overcurrent	50/51	PhPTOC	● ⁽⁴⁾
Earth/ground fault overcurrent (computed)	50N/51N	EfPTOC	● ⁽¹⁾
Earth/ground fault overcurrent (measured)	50N/51N	SEfPTOC	● ⁽³⁾
Directional phase overcurrent	67	DPhPTOC	● ⁽²⁾⁽⁴⁾
Directional earth/ground fault overcurrent Protection (1)	67N	DEfPTOC	● ⁽²⁾
Directional active overpower	32P		● ⁽¹⁾⁽²⁾
Cold load pickup (CLP or CLPU)			●
Magnetizing inrush restraint configurable (H2)	68H2		●
Current and Voltage monitoring			
Phase undercurrent	37	AbsPTUC	● ⁽⁴⁾
Phase undervoltage	27	AbsPTUV	● ⁽²⁾
Phase overvoltage	59	PrsPTOV	● ⁽²⁾
Negative sequence overvoltage (Broken conductor)	47 BC	BcPTOV	● ⁽²⁾
Earth/ground fault overvoltage	59N	FPTOV	● ⁽²⁾
Measurement functions			MMXU
Phase & residual RMS current values			● ⁽⁴⁾
Phase RMS voltage values			● ⁽⁴⁾
Phase fault pick-up current			● ⁽⁴⁾
Residual fault pick-up current			●
Phase and neutral voltage value			● ⁽²⁾
Demand value min & max, day, month, year			● ⁽²⁾
Power measurement as per IEC 61557-12			● ⁽²⁾
Power quality as per IEC 1000-4-30 class S			● ⁽²⁾
Control, monitoring, supervision			
Switchgear control and monitoring			●
Switchgear tripping management			●
Switchgear monitoring only			●
Programmable switchgear interlocking			●
Control with Mobile application			●
Local/remote function			●
Hit and Run Fcontrol			●
Setting groups			2
Logs and records			
Sequence of event record			●
Disturbance record			●
Automation functions associated			
Sectionalizer			1 ⁽⁵⁾
Automatic Transfer Source (between SC160 modules)			●
Condition monitoring (thermal and environmental)			●

⁽¹⁾ Require 3 phase CT

⁽²⁾ Require 3 voltages measurement

⁽³⁾ Require Zero sequence CT: Mounting B, C or D

⁽⁴⁾ not available with CT mounting C

⁽⁵⁾ require voltage measurement

⁽⁶⁾ not available with VPIS-V3 sensors

Voltage acquisition adapter

The different MV sensors used with the SC160 are summarized in Accessories Chapter.

PowerLogic™ SC160 Switchgear Controller unit

General description

Functional description

A single device for both protection and fault passage indicator application

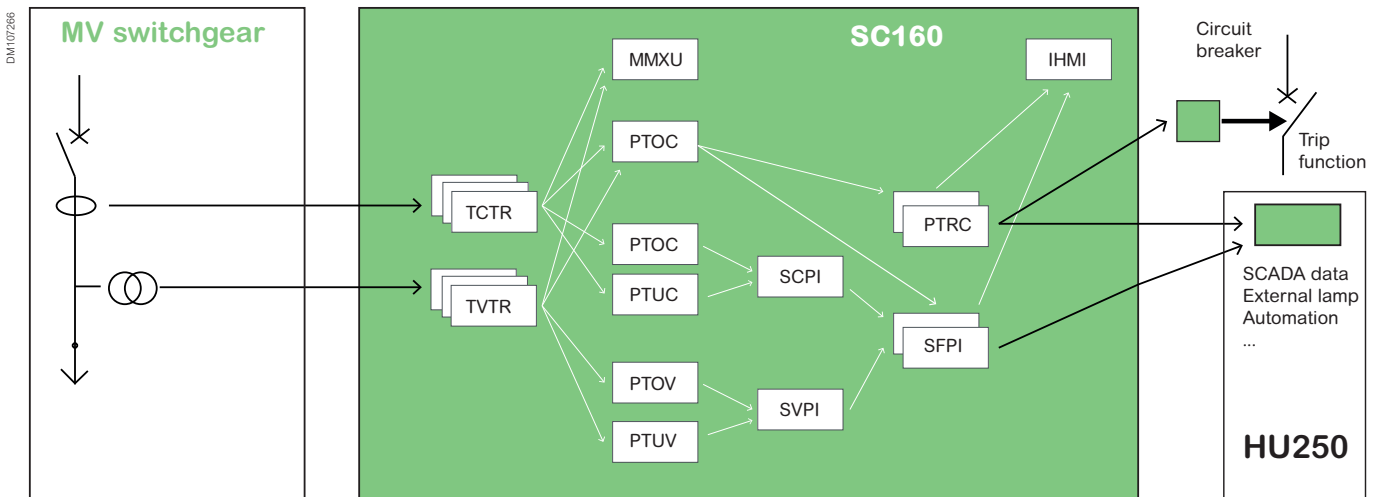

DM1107268

PhPTOC : Phase over-current

Instance 1 enable:

Instance 2 enable:

Instance 3 enable:

EFPTOC : Earth fault

Instance 1 enable:

Instance 2 enable:

Instance 3 enable:

SC160 can be configured as protection with circuit breaker, or overcurrent fault passage indicator with LBS or both functions can be mixed by different stage setting. Three or two directional overcurrent current instances can operate simultaneously with different settings.

Each stage has 2 groups of settings. These 2 groups correspond to 2 sets of thresholds and time delays that are typically linked to 2 upstream protection settings.

A global setting allows to enable or disable the tripping functions. In these different modes, the functions available by stage are:

Tripping enabled

- None
- Indication only (FPI)
- Tripping (CB protection)

Tripping disabled

- None
- Indication only (FPI)
- FPI + Sectionalizer automation

Tripping Lockout Management

The SC160 general tripping function enables tripping lockout by latching the trip output contact and indication until a user reset occurs. This leads to the blocking of the switch closing and related control functions until a user reset occurs. This feature is configured by parameter setting.

PowerLogic™ SC160 Switchgear Controller unit

General description

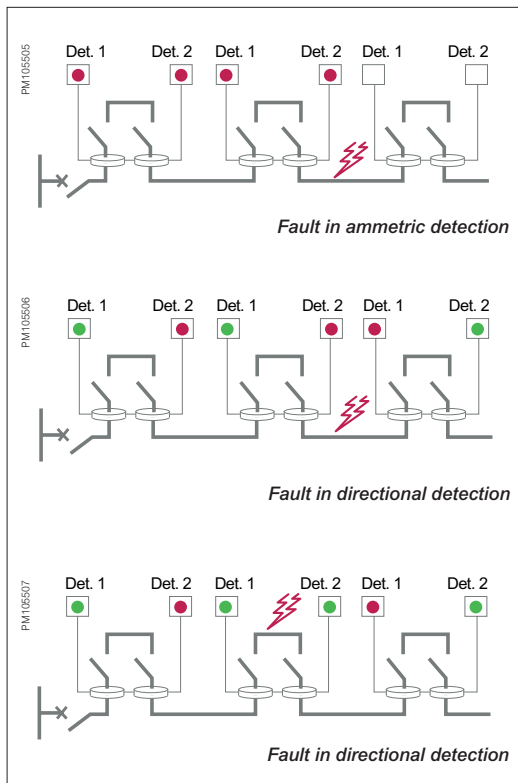

Examples of colors indicating a fault

Several types of fault (FPI) are tracked

The SC160 offers a complete range of Fault Passage Indicators (FPI) needed to detect a fault current with or without the presence of distributed energy resources on the MV or LV network

The FPI aim is to provide persistent indication of the presence or absence of an overcurrent detection and also track all non-permanent faults current in order to facilitate network maintenance and improve the quality of services.

The FPI function includes counters to memorize the type and the number of fault current, to be able to make diagnostics or statistics about the quality of the network.

The following FPI events can be activated and memorized:

- Permanent fault current: fault current confirmed by SVPI or SCPI
- Semi-permanent fault current: removed by the slow cycles of recloser (cycle 2 or cycle 3)
- Transient fault current: removed by the fast cycle (cycle 1)

In order to detect a persistent or non-permanent fault current on the network, a fault detection can be configured:

- Unconfirmed
- Confirmed by voltage dip from power supply
- Confirmed by voltage absence
- Confirmed by current absence

The fault detection is indicated:

- By two LEDs on each SC160 module
- By a flashing light outside the station
- Remotely to the SCADA system via the communication protocol

LN Type Name	LN class	Description
PhPTOC	PTOC	Phase over-current detection (ANSI 50/51)
EfPTOC	PTOC	Ground fault over-current detection (ANSI 50N/51N)
SEfPTOC	PTOC	Sensitive ground fault over-current detection (ANSI 50N/51N)
BcPTOV	POTV	Broken conductor detection (ANSI 47)
DirPhPTOC	PTOC	Directional phase over-current detection (ANSI 67)
DirEfPTOC	PTOC	Directional ground fault over-current detection (ANSI 67N)
AbsPTUC	PTUC	Current absence detection
PrsPTOC	PTOC	Current presence
AbsPTUV	PTUV	MV feeder voltage absence.
PrsPTOV	PTOV	MV feeder voltage presence
SVPI	SVPI	Voltage presence indicator based on inputs from PTOV, PTUV
SCPI	SCPI	Current presence indicator based on inputs from PTOC, PTUC
SFPI	SFPI	Computation of MV fault passage indication based on fault detection on confirmation (SVPI and/or SCPI)

PowerLogic™ SC160 Switchgear Controller unit

Network monitoring

Phase overcurrent - ANSI 50/51

These functions are used to detect short circuit and heavy overloads. The overcurrent function measures the fundamental frequency components of the phase currents. The protection is sensitive to the highest of the three phase currents. Whenever this value exceeds the user's start setting of a particular stage, a start signal is issued. If the detection remains present longer than the operation delay setting, an alarm or a trip signal is issued.

- Two instances ((I> and I>>)) with definite time or inverse time delay.
- One instance (I>>>) with definite time delay
- Cold load pick-up function
- Inrush restraint function
- Two setting groups for each instance
- Associated automation

Functions

Settings

Global SC160 tripping control		Enable	Disable
		TRIP and FPI function	FPI function
Function activation	By instance	none	none
		FPI only	FPI only
			FPI + Sectionalizer
		Tripping	
Detection curve	By instance	Instantaneous	Instantaneous
		Definite time (DT)	Definite time (DT)
	Instances 1 & 2	IEC normal inverse time/A	IEC normal inverse time/A
		IEC very inverse time/B	IEC very inverse time/B
		IEC extremely inverse/C	IEC extremely inverse/C
		IEEE moderately inverse time	IEEE moderately inverse time
		IEEE very inverse time	IEEE very inverse time
		IEEE extremely inverse	IEEE extremely inverse
Definite time (DT) pick-up	By instance	0.1...10.00 In (CTs = 1 A)	0.02...10 In (CTs = 1 A)
			0.02...4 In (CTs = 5 A)
Inverse time (IDMT) pick-up	Instances 1 & 2	0.1...2.4 In (CTs = 1 A)	0.02...2.4 In (CTs = 1 A)
			0.02...1 In (CTs = 5 A)
Operation time	DT	Instantaneous :0	Instantaneous :0
		0.05 to 300 s	0.05...300 s
	IDMT	0.1...12.5 s	0.1...12.5 s
Reset time		0; 50...300 s	0; 50...300 s
Inrush restraint		Enable/disable	Enable/disable
Cold load pick-up		Enable/disable	Enable/disable
Cold load pick-up multiplier		100%...999%	100...999%

PowerLogic™ SC160 Switchgear Controller unit

Network monitoring

Earth /ground fault overcurrent - ANSI 50N/51N

Earth/ground fault protection (ANSI 50N/51N) is based on the measured residual current from core balance CT. or/and calculated residual current from the current phase measurement.

- Two overcurrent faults are available and managed independently:
 - Earth/Ground fault (EF): Three instances
 - Sensitive Earth/Ground fault (SEF): One instance
- Cold load pick-up function
- Inrush restraint function
- Two setting groups for each instance
- Each instance of EF and SEF can be enabled/disabled by SCADA commands

Functions

Settings

Global SC160 tripping control		Enable	Disable
		TRIP and FPI function	FPI function
Function activation	By instance	none	none
		FPI only	FPI only
			FPI + Sectionalizer
		Tripping	
Residual current acquisition	By instance	Io: measured with 1 A core balanced CT	
		Ires: calculated with sum of 3 phases currents	
Detection curve	By instance	Instantaneous	Instantaneous
		Definite time (DT)	Definite time (DT)
	Instances 1 & 2	IEC normal inverse time/A	IEC normal inverse time/A
		IEC very inverse time/B	IEC very inverse time/B
		IEC extremely inverse/C	IEC extremely inverse/C
		IEEE moderately inverse time	IEEE moderately inverse time
		IEEE very inverse time	IEEE very inverse time
		IEEE extremely inverse	IEEE extremely inverse
Definite time (DT) pick-up	By instance	Io: 0.008 In or 0.4 A to 3.5 In (CTs 1 A)	Io: 0.008 In or 0.4 A - 3.5 In (CTs 1 A)
			Io: 0.008 In or 0.4 A - 1.6 In (CTs 5 A)
		Ires: 0.1 In or 2 A to 3.5 In (CTs 1 A)	Ires: 0.1 In or 2 A - 3.5 In (CTs 1 A)
			Ires: 0.1 In or 2 A - 1.6 In (CTs 5 A)
Inverse time (IDMT) pick-up	Instances 1 & 2	Io: 0.008 In or 0.4 A to 1 In (CTs 1 A)	Io: 0.008 In or 0.4 A - 1 In (CTs 1 A)
		Ires: 0.1 In or 2 A to 1 In (CTs 1 A)	Ires: 0.1 In or 2 A - 1 In (CTs 5 A)
Operation time	DT	Instantaneous :0	Instantaneous :0
		0.05...300 s	0.05...300 s
	IDMT	0.1...12.5 s	0.1...12.5 s
Reset time		0; 50...300 s	0; 50...300 s
Inrush restraint		Enable/disable	Enable/disable
Cold load pick-up		Enable/disable	Enable/disable
Cold load pick-up multiplier		100%...999%	100...999%

PowerLogic™ SC160 Switchgear Controller unit

Network monitoring

Directional phase overcurrent – ANSI 67

Phase-to-phase short-circuit protection, with selective tripping according to fault current direction.

It comprises a phase overcurrent function associated with direction detection and picks up if the phase overcurrent function in the chosen direction (line or busbar) is activated for at least one of the 3 phases.

- Two instances ((I> and I>>)) with definite time or inverse time delay.
- Cold load pick-up function.
- Inrush restraint function
- Two setting groups for each instance

Functions

Settings

Global SC160 tripping control		Enable	Disable
		TRIP and FPI function	FPI function
Function activation	Instances 1 & 2	none	none
		FPI only	FPI only
			FPI + Sectionalizer
		Tripping	
Detection curve	Instances 1 & 2	Instantaneous	Instantaneous
		Definite time (DT)	Definite time (DT)
	Instances 1 & 2	IEC normal inverse time/A	IEC normal inverse time/A
		IEC very inverse time/B	IEC very inverse time/B
		IEC extremely inverse/C	IEC extremely inverse/C
		IEEE moderately inverse time	IEEE moderately inverse time
		IEEE very inverse time	IEEE very inverse time
		IEEE extremely inverse	IEEE extremely inverse
Definite time (DT) pick-up	Instances 1 & 2	0.1 In or 2 A to 10 In (CTs = 1 A)	0.02 In or 2 A to 10 In (CTs = 1 A)
Inverse time (IDMT) pick-up	Instances 1 & 2	0.1 In or 2 A to 2.4 In (CTs = 1 A)	0.02 In or 2 A to 1 In (CTs = 1 A)
			0.02 In or 2 A to 1 In (CTs = 5 A)
Operation time	DT	Instantaneous :0	Instantaneous :0
		0.05...300 s	0.05...300 s
	IDMT	0.1...12.5 s	0.1 to 12.5 s
Reset time		0; 50...300 s	0; 50...300 s
Inrush restraint		Enable/disable	Enable/disable
Cold load pick-up		Enable/disable	Enable/disable
Cold load pick-up multiplier		100...999%	100...999%
Characteristic angle (degrees)		30°; 45°; 60°	30°; 45°; 60°
Tripping direction		Backward/Forward	

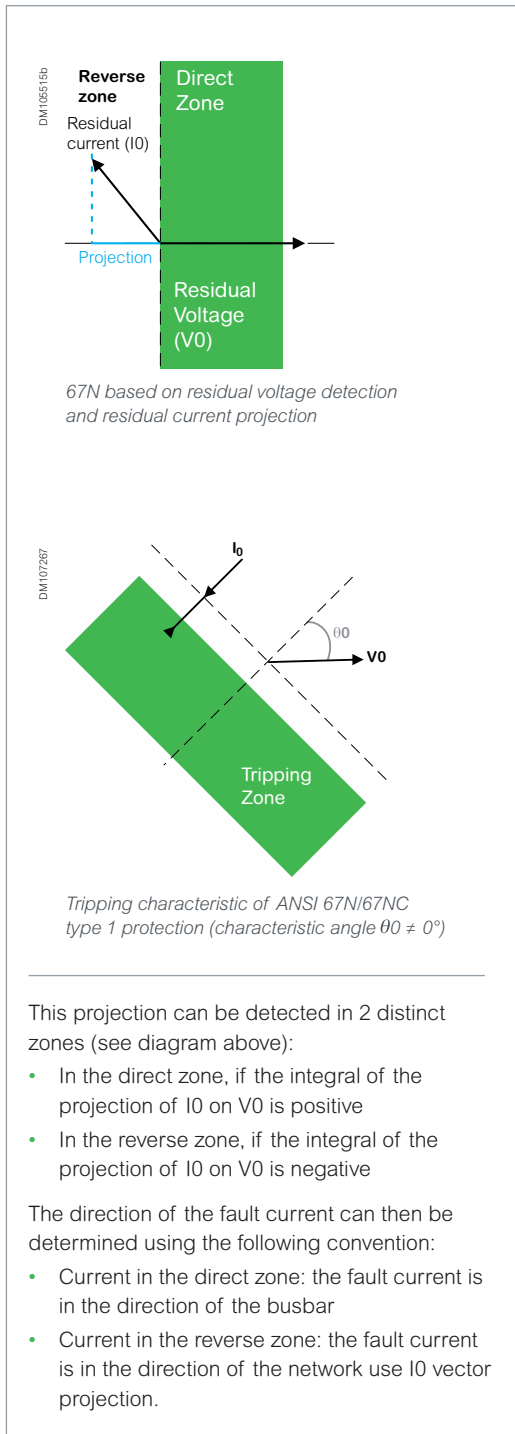

Directional earth/ground fault overcurrent - ANSI 67N

According to the global tripping capability configuration (enable/disable), SC160 uses different ANSI 67N algorithms function for directional earth/ground fault indication or Circuit Breaker tripping capability. Both functions operate with the residual current measured from core balanced CT or computed from the three phases currents. With the current acquisition type D (3 phases CT and core balance CT) both can be selected by instance.

- **Tripping capability enabled**

The protection function (TRIP) and fault indication (FPI) use I_0 vector projection. This projection method is suitable for radial feeders in resistive, isolated or compensated neutral systems.

This function operates with standard CT and voltage sensors (VT and LPVT) as per IEC 61869-3 and IEC 61869-7.

- **Tripping capability disabled**

The fault current detection (FPI) combines a ground fault detection based on V_0 with a fault current direction indication. The fault current detection is considered if the residual voltage exceeds the threshold defined by configuration and the direction is determined by projecting the residual current onto the residual voltage during the transient phase.

This function operates with standard CT and all voltages sensors (VT and LPVT) as per IEC 61869-3 and IEC 61869-7 and capacitor with low accuracy.

Both functions have:

- Two instances with definite time or inverse time delay.
- Cold load pick-up function.
- Inrush restraint function
- Two setting groups for each stage.

PowerLogic™ SC160 Switchgear Controller unit

Network monitoring

Functions

Settings

Global SC160 tripping control		Enable	Disable
Type of detection		67N type 1	67N based on residual voltage
		TRIP and FPI function	FPI function
Function activation	>, >>	none	none
		FPI only	FPI only
			FPI + Sectionalizer
		Tripping	
Residual current acquisition	>, >>	Io: measured with 1 A core balanced CT	
		Ires: calculated with sum of 3 phases currents	
Detection curve	>, >>	Definite time (DT)	Definite time (DT)
Definite time (DT) pick-up	>, >>	Io: 0.008 or 0.4 A to 3.5 In (CTs 1 A)	
		Ires: 0.1 or 0.4 A to 3.5 In (CTs 1 A)	
Minimum residual voltage	>, >>	2...80%	6...30% Un
Operation time	DT	0.05...300 s	0.05...300 s
Reset time			0...300 s
Characteristic angle (degrees)		-45°; 0°; 15°; 30°; 45°; 60°; 90°	
Desensitization area (degrees)		86°; 83°; 76°	
Maximum time of memorization		0 or 0.05 to 300 s	
Residual current and voltage pick-up validation			Enable Disable
Minimum (blocking) operating current			Io: 0.01...2.3 In Ires: 0.015...2.3 In
Minimum (blocking) operating voltage			6...60% Vn
Cold load pick-up		Enable/Disable	Enable/Disable
Cold load pick-up multiplier		100...999%	100...999%
Tripping direction		Backward/ Forward	

PowerLogic™ SC160 Switchgear Controller Unit

Network monitoring

Description:

Directional active overpower is a two-way detection based on:

- Active overpower detection
- Reverse active power detection: to detect overload or abnormal power flow on the distribution network.

This function allows to detect distributed generation injection on the network.

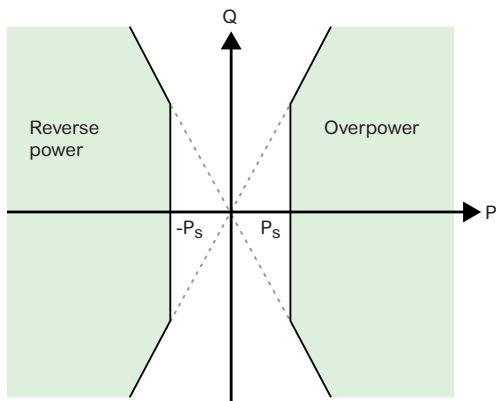

Operating zone

Directional active overpower: ANSI 32P

This function may be used as:

- **Active overpower detection** for MV network energy management to detect overloads (or maximum power) and allow load shedding
- **Reverse active power** to help detect
 - Power injection from distributed production if the measure is done on transformer incomer
 - Abnormal power flow if the measure is done on the feeder (MV line switchgear).

The power sign is determined according to the general feeder or incomer parameter, according to the convention:

For feeder incomer	For feeder outgoing
<ul style="list-style-type: none"> • Power exported by the busbar is positive • Power supplied to the busbar is negative. 	<ul style="list-style-type: none"> • Power supplied to the busbar is positive • Power exported by the busbar is negative

Parameter	Setting
Direction	<ul style="list-style-type: none"> • Forward - to network • Reverse - to busbar
Phase Pick-up	1...120 % of nominal apparent power $S_n = \sqrt{3} \cdot U_{np} \cdot I_n$.
Time delay	0.1...300 s

PowerLogic™ SC160 Switchgear Controller unit

Network monitoring

2nd harmonic detection - ANSI 68 H2

Parameter	Setting
Phase Pick-up	5...50%
Residual Pick-up	5...50%
Time delay	25 ms fixed
<i>The 25 ms time delay is aimed at avoiding unwanted Tripping or delay the overcurrent protection functions when they are set to instantaneous.</i>	

A current peak may occur on power-up of the MV network due to energization of the transformers and saturation of the phase CTs installed on the network. The inrush current may be greater than the overcurrent or earth fault overcurrent settings. To reduce the risk of unwanted tripping, the function identifies an inrush current and provides a signal which can be used for blocking low stage of protections trip or indication.

The algorithm for detecting the transformer inrush phenomenon is based on an analysis of the ratio between the second harmonic distortion and the fundamental current on each current measurement input.

Cold Load Pickup

The Cold Load Pickup Function helps avoid nuisance tripping of the overcurrent protection during energization after a long outage. It is used to increase the protection set point temporarily.

Depending on the installation characteristics, these operations can generate transient inrush currents likely to exceed the protection set points. These transient currents may be due to:

- Simultaneous resetting of all the loads in an installation (air conditioning, heating, etc.)
- The power transformer magnetizing currents
- The motor starting currents

In normal circumstances, the protection settings are defined so as to avoid tripping due to these transient currents. However, if this rule results in inadequate sensitivity levels or delays that are too long, this function can be used to increase or inhibit set points temporarily after energization. This function helps to keep a good level of protection sensitivity, regardless of the constraints affecting energization.

The Cold Load Pickup function is configured for each protection (ANSI 50-51/ ANSI 50-51N/ ANSI 67/ ANSI 67N).

Parameter	Setting
Absence threshold (A)	0.01...1 In
Presence threshold (A)	0.01...1 In
Inhibit mode	Block/Multiply
Operate delay time	0.1...300 s

PowerLogic™ SC160 Switchgear Controller unit

Network monitoring

Description:

Detection of phase balances resulting from phase inversion or unbalanced supply, detected by the measurement of negative sequence voltage.

It allows detecting a loss of one or two phases on medium voltage network (broken conductor) and sends an alarm to the control center.

Negative sequence overvoltage – ANSI 47 Voltage broken conductor detection

Voltage broken conductor characteristics

Number of instances	2 instances can run simultaneously with different settings
Setting groups	2
Fault current indication	Fault current detected

Broken conductor setting (by instance)

Phase voltage detection threshold	10...100% Vn in 1% step
Operating time delay:	0...300 s in 1 ms step
Fault detection reset	<ul style="list-style-type: none"> Reset voltage threshold: 2...30% Vn Reset time delay: 0...300 s in 1 ms step

Description:

Detection of insufficient or unbalanced network voltage to trigger:

Instance 1 and 2:

- ANSI 27: Network monitoring (indication)

Instance 3:

- Network presence for:
 - Fault Passage Indicator validation
 - HMI Network presence indication
 - Automation

Characteristics:

- Measured quantity is phase-to-phase voltage or phase-to-neutral voltage
- Each phase is monitored

Undervoltage – ANSI 27

Characteristics

Number of instance	3
Setting groups	2
Detection mode	Definite time
Reset ratio (hysteresis)	106%

Setting

Measured voltage	3 phase-ground
Operation mode	On any phase
Us < threshold	10...100% Vn in 1% step
DT time delay	0 ms to 300 s in 1 ms step
Reset time delay	0...300 s in 1 ms step

PowerLogic™ SC160 Switchgear Controller unit

Network monitoring

Description:

Detection of abnormally high network voltage or checking for sufficient voltage to enable:

Instance 1 and 2 :

- ANSI 59 : Network monitoring (indication)

Instance 3 :

- Network presence for:
 - Fault Passage Indicator validation
 - HMI Network presence indication
 - Automation

Characteristics:

- Measured quantity is single phase
- The voltage presence is set when all phases are confirmed
- The overvoltage presence is set when any phase is on fault detected

Overvoltage – ANSI 59

Characteristics

Number of instance	3
Setting groups	2
Detection mode	Definite time
Reset ratio (hysteresis)	93%
Setting	
Measured voltage	Phase-ground
Operation mode	On any phase or on all 3 phases
Us < threshold	20...200% Vn in 1% step
DT time delay	0 ms to 300 s in 1 ms step
Reset time delay	0...300 s in 1 ms step

Description:

Detection of abnormal voltage by measuring residual voltage to trigger:

Instance 1, 2 and 3:

- ANSI 59N : Residual voltage detection (indication)

Characteristics:

- Residual voltage can be calculated or measured.

Neutral voltage displacement – ANSI 59N

Characteristics

Number of instance	3
Setting groups	2
Detection mode	Definite time
Reset ratio (hysteresis)	93%
Setting	
Measured voltage	Phase-phase/phase-ground
Us < Threshold	10...200% Un in 1% step (phase-ground)
DT time delay	0 ms to 300 s in 1 ms step
Reset time delay	0 ms to 300 s in 1 ms step

PowerLogic™ SC160 Switchgear Controller unit

Network monitoring

Description:

Used to confirm network absence on 3 phases to trigger:

- FPI detection confirmation
- Load shedding or source transfer automation for example.
- Network absence indication

Characteristics:

- Sensitive to the lowest value of the phase currents

Undercurrent – ANSI 37

Characteristics

Number of instance	1 (presence/absence)
Setting groups	1
Reset ratio (hysteresis)	0.2% x I _n
Setting	
I < Threshold (37)	0.002...0.02 I _n in 0.1 %
DT time delay	0 ms to 300 s in 1 ms step

Description:

Used to record measured analog signals, digital input signals and logical states

Depending on the trigger position setting, the stored event can begin before the event and continues afterwards

The record files can be downloaded from T300 Web server

Characteristics:

Records comprise the following information:

- Values sampled from the different signals
- Date

The record is activated by one or more of the following events (for each SC160):

- Actual samples at a rate of 4,800 samples per second for current and/or voltage.
- Any change regarding the following information:
 - Network presence
 - Fault indication (ANSI 50/51, 50N/51N, 67/67N, 47)
 - Voltage event (ANSI 59/59N)
 - Power Quality event
 - Main switch status (DI1 and DI2)
 - Digital inputs (DI3 to DI8)

Disturbance Recording

Characteristics

Recording content	<ul style="list-style-type: none"> • Set-up file: date, channel characteristics, sampling rate • Sample file: recorded signals
Sampling frequency	4,800 samples per second
Analog signals recorded	<ul style="list-style-type: none"> • I_a, I_b, I_c, I₀ (measured) • V_a, V_b, V_c or U_{ab}, U_{bc}, U_{ca}
Logical states recorded	Digital input signals and logical states
Number of recordings stored	Up to 50 (when the maximum number of records is reached, the oldest record is erased)
Total duration of a recording	100...70,000 ms
Maximum recording capacity	140 s maximum with 70 s maximum per record
File format	COMTRADE - IEC 60255-24 Ed. 1 - 2001
Setting	
Recording duration	100...70,000 ms
Trigger position	0...100%
Trigger on:	<ul style="list-style-type: none"> • Network presence (any change) • Fault indication (ANSI 50/51, 50N/51N, 67/67N, 47) • Voltage event (ANSI 59 or 59N) • Power Quality event (dip, swell or interruption) • Digital input 1...8 (rise, fall or any change)

PowerLogic™ SC160 Switchgear Controller unit

MV Network management

The SC160 can directly manage the sectionalizer automation associated with a Load Break Switch (LBS) for overhead line management. The LBS can be installed in an underground substation or overhead pole top.

Sectionalizer automation

Sectionalizer automation is used on an MV overhead line or an underground to overhead line. It requires a circuit breaker-recloser at the head of the line.

The role of this automation function is to command the opening of the MV switch managed by the SC160 after a defined number of fault currents detected have been detected during an unsuccessful reclose cycle of the upstream recloser. The sectionalizer automation function therefore converts a switch into a sectionalizing switch.

The disconnection logic is used to isolate the section exhibiting the fault condition by opening the switch during the voltage sag of the reclose cycle.

Sectionalizer automation can be enabled individually on each SC160 module on the T300.

The automation function is enabled or disabled globally on the T300 (for all SC160 modules) either remotely from the SCADA system or locally:

- By pressing the "ON" button on the front of the HU250 module
- Via the Web server

Operation

In normal operating conditions the MV network is energized, and the switch is closed.

The automation function sends an open command to the MV switch if:

- Automation is enabled on the channel
- The switch is closed
- The number of fault currents detected counted reaches the number configured (Reclose cycles number)
- The voltage is absent

The automation cycle is reset at the end of the **Primary CB recloser maximum operation time**.

The detected fault currents counter is reset at the end of this time delay.

Automation remains inactive if the number of detected fault currents counted during this time period does not reach the value defined by setting.

The voltage source used to detect the absence of the MV network during the cycle can be acquired and defined in different ways :

- By voltage measurement sensors
- By digital input
- By the AC power supply (in this case, the T300 must be powered by a low voltage source from the MV line on which the switch is installed)

Blocking Automation

Certain conditions can block the automation function. The automation blocking conditions are associated with any action that makes it impossible to operate the MV switch, namely:

- If the T300 is in local mode and the Enable local mode to block automation option is enabled by configuration
- If the switch interlock digital input is enabled and the External input mode for open commands blocking option is enabled by configuration
- If the switch position is unknown at the time of the command and the Block if switch position is unknown or same as command option is enabled by configuration

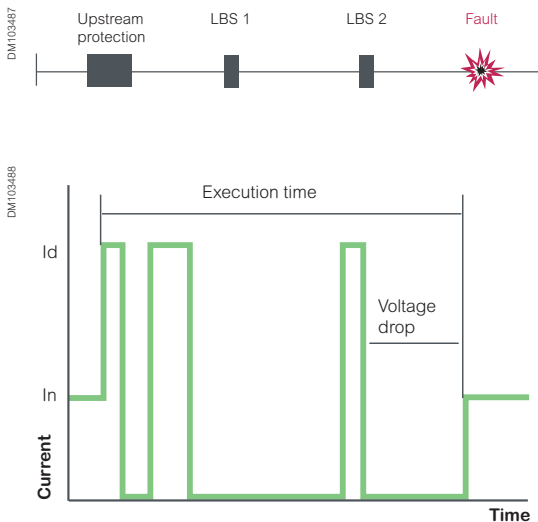

Characteristics

Setting groups	2 groups
Automation indication	<ul style="list-style-type: none"> • Automation on • Automation off • Automation locked

Sectionalizer setting

Sectionalizer active	Enable/Disable
Number of reclose cycles before opening	1...4
Maximum execution time after fault detection	20 s to 5 min in 1 s step
Enable lockout on switch operation failure	Enable/Disable
Direction mode	Forward, backward, both

PowerLogic™ SC160 Switchgear Controller unit

MV Power monitoring

Power measurement and Power quality

General characteristics

Standards	
Power measurement as per	IEC 61557-12/ PMD/SD/K70/1
Power quality as per	IEC 61000-4-30 class S
General	
Current accuracy	0.5% from 0.1 In to 1.2 In
Voltage accuracy	0.5% from 20% Un to 120% Un
Active power	1%
Active energy accuracy	1%
Frequency range	45 to 67 Hz

Utilities are coming under increasing pressure from both customers and regulatory bodies alike to review the quality of power they are providing (EN50160).

This requires monitoring of their networks for various indices such as number of and duration of outages, dip/swell voltages and system harmonics.

The SC160 offers many high performance capabilities to meter and monitor the MV network with the same current and voltage sensors without the need to add an expensive specialized device.

PowerLogic™ T300 has a large capacity of storage for SCADA transmission and/or local consultation. All recorded measurements are consultable via the web server locally or remotely with trends and diagram or table. The measurement log can be also downloaded in Excel format.

Measured and metered values

	Base	PM option	Power quality option
Instantaneous RMS values			
Current	<ul style="list-style-type: none"> • 3 phase and residual • 3 phase average 		
Voltage	<ul style="list-style-type: none"> • 3 phase and residual • 3 phase average 		
Frequency	•		
Overcurrent pick-up	•		
Last current demand value before fault detection or switch opening	•		
Last voltage demand value before fault detection	•		
Last voltage value before broken conductor fault detection	•		
Active, reactive, apparent power (total & per phase)		Signed	
Power factor (Total & per phase)		Signed	
Energy values			
Active, reactive, apparent energy		Signed	
Configurable accumulation mode		•	
Demand values			
Voltage & current		•	
Active, reactive, apparent power		•	
Synchronization of the measurement window		•	
Demand windows calculation mode		•	
Power quality measurement			
Harmonic distortion – current and voltage (up to H40)			•
Individual harmonics – current and voltage (up to H40)			•
Voltage dip and swell events			•
Events			•
Voltage and current unbalance			•
Voltage magnitude			•
Data recording			
Average current rms Min/max :	1 day, 7 days, 1 month, 1 year		
Demand values:	At 3 months		
Event logs	•		
Alarms	•		
Counter	•		

PowerLogic™ SC160 Switchgear Controller unit

MV Power monitoring

Measured and metered values setting

Demand value		
Demand computed mode	Block (synchronized on the T300 RTU clock from the HU250)	
Demand value computed period	Demand value computed period 1, 2, 5, 10, 15, 20, 30, 60 minutes	
Minimum and maximum value	By day, 7 days, 1 month, 1 year	
Power quality Voltage setting		
Voltage swell	Threshold	100...150% of Un
Voltage dip	Threshold	5...100% of Un
Voltage dip and swell short duration	DT time delay	10 ms to 60 s (2 instances)
Voltage interruption	Threshold	1...90% of Un
Voltage interruption duration	DT time delay	60...900 s
Current unbalance	Threshold	1...100% of In
	DT time delay	200 ms to 60 s
Voltage unbalance	Threshold	1...100% of In
	DT time delay	200 ms to 60 s

PowerLogic™ SC160 Switchgear Controller unit

Characteristics

General characteristics

Voltage input (with voltage adapter)		
Type of sensor input	<ul style="list-style-type: none"> LVPT as per IEC 61869-7 VT as per IEC 61869-3 	
Voltage input wiring	3 phases	
Metering range	4 Un	
Input impedance	10 MΩ	
Voltage characteristics		
MV voltage range	rated voltage (Un)	3...36 kV
	Frequency	45...67 Hz
LPVT	Rated value	0...10 V
	Magnitude correction	0.5...2.0 Phase angle: -180°...+180°
VT	Secondary rated value	50...250 V
	Magnitude correction	30...60
Phase rotation	Yes/No	
Current input		
CT mounting	<ul style="list-style-type: none"> Type A: I1, I2, I3 Type B: I1, I3, I0 Type C: I0 Type D: I1, I2, I3, I0 	
Primary rated value	Phase CT	50...1250 A
	core balance CT	10...1250 A
Secondary rated value	Phase CT	1 or 5 A
	core balance CT	1 or 5 A
CT inversion	Configurable by CT	
Current characteristics		
Measurement range	Phase CT	<ul style="list-style-type: none"> 0.01...20 In (CTs = 1 A) 0.01...7 In (CTs = 5 A)
	Core balance CT	0.01...7 In
Permissible overload	<ul style="list-style-type: none"> 10 A continuous 50 A 10s per hour 120A -1s 	
Input Impedance	1 milliohm	
Burden	0.025 VA	

PowerLogic™ SC160 Switchgear Controller unit

Characteristics

Digital output	
Rated motor mechanism voltage	12...127 Vdc/90...220 Vac
Rated voltage	250 Vac
Max switching voltage	440 Vac
Rated current	8 A
Limiting continuous current	8 A
Limiting making current, max 4s	15 A
Breaking capacity max	2000 VA
Typical motor control current	16 A for 50 ms and 6 A for 15 s
Digital input	
8 single or dual wet inputs (0V common) compliant to IEC 61131 -2	
Standard wiring	
2 SPS or 1 DPS	<ul style="list-style-type: none"> • Switch opened • Switch closed
1 DPS or 2 SPS or 1SPS	<ul style="list-style-type: none"> • Ground switch closed • Ground switch open
1 SPS	Switch interlocking
1 SPS	Voltage presence
2 SPS	Free
Power supply	
Voltage input	12...48 Vdc (-15%, +20%)
Burden	3 VA; max typical: 1,5 VA in FPI

PowerLogic™ SC160 Switchgear Controller unit

Characteristics

Electrical characteristics

Dielectric compatibility			
Dielectric	IEC 60255-27	Common mode (CM):	<ul style="list-style-type: none"> Insulation (50 Hz/1 min.): 2 kV Surge (1.2/50 µs): 5 kV
Electromagnetic compatibility/Immunity			
Electrostatic discharge	IEC 61000-4-2	15 kV in air	
	Level 4/Criteria B	8 kV at contact	
Radiated RF electromagnetic fields	IEC 61000-4-3 Level 4/Criteria A	30 V/m – 27 MHz to 6 GHz	
Fast transients	IEC 61000-4-4	Power supply, Ethernet	CM: ±4 kV, 5 kHz – 100 kHz
	Level 4/Criteria A	Other circuits	CM: ±2 kV, 5 kHz – 100 kHz
Surge	IEC 61000-4-5 Power supply: Level 4/Criteria A Other circuits: Level 3/Criteria A	<ul style="list-style-type: none"> CM: 2 kV - wave 1.2/50 µs DM: 1 kV - wave 1.2/50 µ 	
Conducted RF disturbances	IEC 61000-4-6	10 Veff	
	Level 3/Criteria A	0.15...80 MHz	
Power frequency magnetic field	IEC 61000-4-8 Level 5/Criteria B	<ul style="list-style-type: none"> 100 A/m – 50 Hz enduring 1000 A/m from 1...3 s 	
Immunity to voltage dips	IEC 61000-4-29 Criteria A	Voltage dip:	<ul style="list-style-type: none"> 24 Vdc: 100 ms 48 Vdc: 500 ms
		Voltage interruption:	<ul style="list-style-type: none"> 24 Vdc: 100 ms 48 Vdc: 500 ms
Pulse magnetic field immunity	IEC 61000-4-9 Level 5/Criteria A	1000 A/m	
Conducted common mode disturbance	IEC 61000-4-16 Level 4/Criteria A	CM: 30 V for 15 Hz to 150 kHz 300 V during 1 s	
Damped oscillatory waves	IEC 61000-4-18 Level 3/Criteria A	CM: 100 kHz, 1 MHz, 3 MHz, 10 MHz, 30 MHz - 2 kV	
Emission tests			
Radiated disturbances	CISPR22	Class A (EN5502)	

Criteria A definition: The unit shall continue to operate as intended during and after the test. No degradation of performance or loss of function is allowed below a performance level specified by the manufacturer, when the apparatus is used as intended. The performance level may be replaced by a permissible loss of performance.

Criteria B definition: The unit shall continue to operate as intended after the test. No degradation of performance or loss of function is allowed below a performance level specified by the manufacturer, when the apparatus is used as intended. The performance level may be replaced by a permissible loss of performance. During the test, degradation of performance is however allowed. No change of actual operating state or stored data is allowed.

PowerLogic™ SC160 Switchgear Controller unit

Characteristics

Environmental characteristics

Environmental conditions		
Operating temperature	IEC 60068-2-1	-40...+70 °C
	IEC 60068-2-2	
Storage temperature	IEC 60068-2-1	-40...+85 °C
	IEC 60068-2-2	
Damp heat, steady state	IEC 60068-2-78	93% RH, 40°C, RH no condensation , 56 days
Change of temperature	IEC 60068-2-14	-40...+70 °C, 5 °C/min, 10 Cycles, 27 h without condensation
Damp heat, cyclic	IEC 60068-2-30	144 h: 6 cycles of 24 h (+55 °C, 93% HR during 9 h; +25 °C, 95% HR during 6 h)
Salt spray test	IEC 60068-2-11	168 h
Product safety standards		
Protection of persons and goods	IEC 60255-27	
Fire resistance	IEC 60695-2-11	850 °C
Power supply		
Rated supply voltage		12...48 Vdc (+/-20 %)
Power consumption		< 2 VA

Mechanical characteristics

Degree of protection	IEC 60529	<ul style="list-style-type: none"> • Front cabinet: IP4x • Module body: IP2x
Robustness	IEC 62262	IK7 2 J
Vibrations	IEC 60068-2-6	10...2000 Hz/1g (peak value) 10 cycles
Bumps	IEC 60068-2-29	10 g/16 ms/1000 Bumps "non energized"
Shocks	IEC 60068-2-27	10 Gn/11 ms/3 pulses "in operation"
Weight		0.515 kg
Dimensions (H x W x D)		140 mm x 45 mm x 140 mm

Notes

PowerLogic™ LV150

Low Voltage monitoring

PowerLogic™ LV150 Low Voltage monitoring

General description

PowerLogic™ LV150 is the right answer to optimize the Low Voltage (LV) network management and assets. It helps you to:

- Detect LV unbalanced or Phase losses (MV or LV issue)
- Reduce LV outages durations
- Measure energy power flow with LV distributed generation
- Manage the peak load with exhaustive data
- Help improve efficiency and reliability of your network and equipment
- Reduce transformer faults and extend life
- Monitor quality of delivered power according to EN50160 directive
- Avoid potential issues linked to loss of neutral

The PowerLogic™ LV150 is an unmatched low voltage monitoring module designed for the public MV/LV substation. It combines accurate 3-phase energy and power measurements with data logging, power quality analysis, alarming and temperature capabilities not typically available in such a compact RTU.

The PowerLogic™ LV150 is compliant with stringent international standards that enhance its metering accuracy and power quality measurements, as specified by the safety standard requirement for the MV/LV substation.

PowerLogic™ LV150 gives you the energy intelligence and control needed to track performance, stay informed in real time of critical conditions and empower you to make strategic decisions. It will help you increase reliability, maximize the use of resources and improve service. The main functions of LV150 module are:

- Transformer temperature monitoring
- LV incomer power monitoring
- LV incomer power quality monitoring
- LV network voltage fault detection (loss of neutral at transformer level)

Current measurement and monitoring

PowerLogic™ LV150 has a fourth CT for measuring of 3 phases and direct neutral current measurement. In demanding utilities applications, where loads are non-linear and the cable size of the neutral is not the same as those of the phases, measuring neutral current is necessary to avoid overload and loss of neutral. In addition, the LV150 module provides measured and calculated ground current value, not available in meters with 3 CTs.

Voltage measurement and monitoring

The voltage inputs are designed according to over-voltage Category IV as defined in IEC 60255-27 for the MV/LV distribution substation.

- 6KVrms 1min/10KVrms 1s
- 20KV choc (1.2/50 μs)

PowerLogic™ LV150 measures the 3 phases (L-N) and neutral/ground voltage to ensure power metering, power quality and voltage monitoring functions as:

- Broken conductor detection (ANSI 47): detection of one phase loss due to the MV or LV site broken conductor or fuse blown
- Undervoltage (ANSI 27)
- Overvoltage (ANSI 59)



LV150 Part Number

Reference	Description
EMS59300	LV150 module
EMS59574	AC voltage adapter

PowerLogic™ LV150 Low Voltage monitoring

General description

Power measurements

as per IEC 61557-12/PMD/SD/K70/1

- Voltage and current RMS values
- Min/max current RMS on 1 day, 7 days, 1 month 1 year
- Real, apparent and reactive power in four quadrants for knowing the energy power flow with distributed generation
- Energy value received and delivered
- Total Harmonic Distortion (THD) on voltage and current per phase
- Individual harmonics voltage and current including neutral that can harm transformer and cable connection.
- Timestamped demand value to monitor peak demand

Power quality

as per IEC 61000-4-30 class S

- Power quality monitoring with supply magnitude, voltage dip and swell, voltage unbalance and harmonic voltage.
- Voltage unbalance
- Voltage magnitude

Transformer monitoring

- Temperature monitoring and alarm
- Peak load measurement

PowerLogic™ LV150 Low Voltage monitoring

General description

Local operator front panel (HMI)

Display of information by colored LEDs

- Module status
- Alarm status

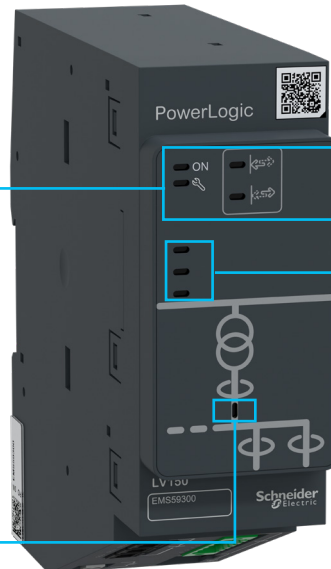

3 customizable LEDs

FPI and voltage indications

- Voltage presence status

Daisy chain LAN

- Internal Ethernet LAN for PowerLogic™ T300 modules
- Ethernet 10/100 BASE-T

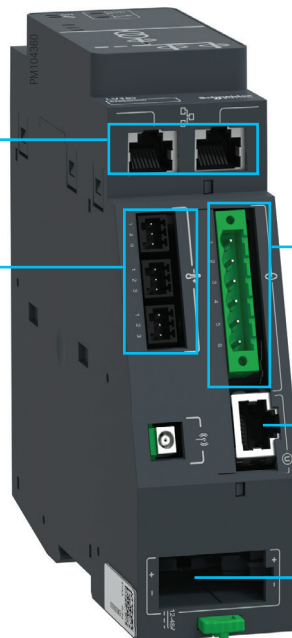

Current acquisition

- 3 phase and neutral acquisition

3 temperature sensors inputs

- Measurement: -55...250 °C (-67...482 °F)
- Resolution: 1 °C (1 °F)
- 3 analog inputs for connection of 3-wires PT100 temperature sensors

Voltage acquisition

- 3 phase and neutral acquisition through a voltage adapter

Daisy chain power supply

- 12...48 Vdc

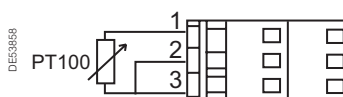

PowerLogic™ LV150 Low Voltage monitoring Connection

- The Low voltage acquisition of 3 phases and neutral is done through an AC resistive divider voltage adapter in order to help provide a high level of voltage insulation
- The LV voltage adapter can be installed in the LV switchboard with its protection and connected to the LV150 by Ethernet RJ45 cable. The maximum length is 4m with cable type (S/STP or S/FTP)
- Nevertheless, the LV150 can be also installed in the LV switchboard and connected to internal Ethernet communication to PowerLogic™ T300 by Ethernet cable

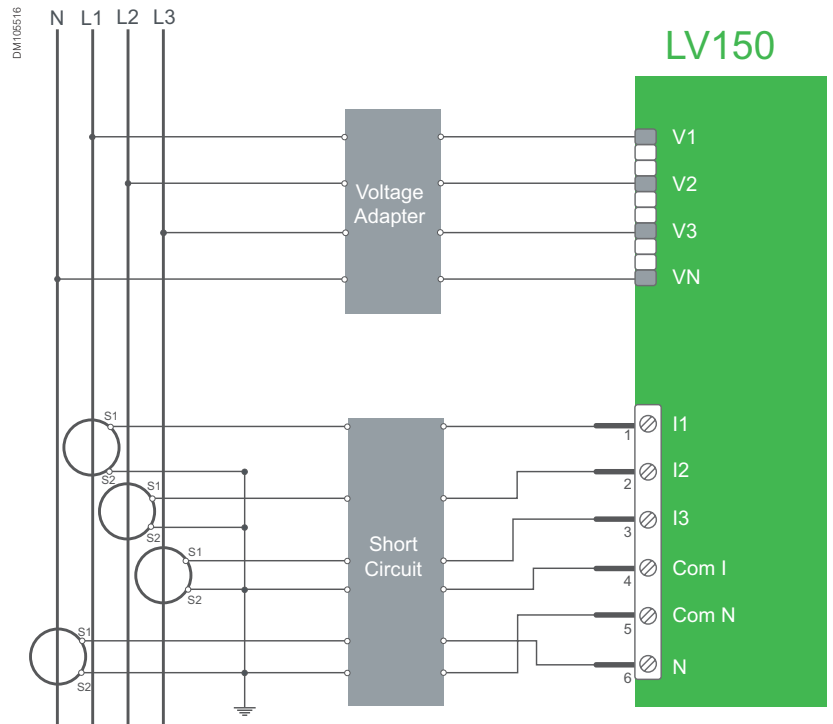

Connection example



Voltage adapter for LV150 (ref: [EMS59574](#))

Ethernet RJ45 cable connected between voltage adapter and LV150

Description	Length (maximum 4 m)	Reference
Cable type S/STP or S/FTP	CCA770 0.6 m	59660
	CCA772 2 m	59661
	CCA774 4 m	59662

PowerLogic™ LV150 Low Voltage monitoring

Network monitoring

Description:

Detection of phase balances resulting from phase inversion or unbalanced supply, detected by the measurement of negative sequence voltage.

It allows detecting a loss of one or two phases on a medium voltage network (broken conductor) and sends an alarm to the control center.

Associated with ANSI 47 detection on the MV side with SC150, PowerLogic™ T300 can detect a blown fuse in the substation (forwards and backwards of MV/LV transformer)

Logical node name:

BcPTOV x

x being the number of the instance

ANSI 47 – Negative sequence overvoltage (Voltage broken conductor detection)

Voltage broken conductor characteristics

Number of instances	2 instances can run simultaneously with different settings
Setting groups	2
Fault indication	Fault detected
Broken conductor setting (by instance)	
Instance activity	<ul style="list-style-type: none"> Instance 1: disabled or enabled Instance 2: disabled or enabled
Phase voltage detection threshold	10...100% Vn in 1% step
Operating time delay:	0...300 s in 1 ms step
Fault detection reset	<ul style="list-style-type: none"> Reset voltage threshold: 2...30% Vn Reset time delay: 0...300 s in 1 ms step

Description:

Detection of insufficient or unbalanced network voltage to trigger:

Instances 1 and 2 :

- ANSI 27 : Network monitoring (indication)

Instance 3 :

- HMI Network presence indication

Characteristics:

- Measured quantity is phase-to-phase voltage or phase-to-neutral voltage.
- Each phase is monitored.

Logical node name:

AbsPTUV x

x being the number of the instance

ANSI 27 – Undervoltage

Characteristics

Number of instances	3
Setting groups	2
Detection mode	Definite time
Reset ratio (hysteresis)	106%
Setting	
Measured voltage	3 phase-ground
Operation mode	On any phase
Us < threshold	10...100% Un in 1% step
DT time delay	0 ms - 300 s in 1 ms step
Reset time delay	0...300 s in 1 ms step

PowerLogic™ LV150

Low Voltage monitoring

Network monitoring

Description:

Detection of abnormally high network voltage or checking for sufficient voltage to enable:

Instances 1 and 2:

- ANSI 59: Network monitoring (indication)

Instance 3:

- HMI Network presence indication

Characteristics:

- Measured quantity is single phase
- Voltage presence is set when voltage presence is confirmed (over the threshold) on all phases
- Overvoltage presence is set when any phase is detected faulty (over the threshold)

Logical node name:

PrsPTOV x

x being the number of the instance

ANSI 59 – Overvoltage

Characteristics

Number of instances	3
Setting groups	2
Detection mode	Definite time
Reset ratio (hysteresis)	93%

Setting

Measured voltage	Phase-ground
Operation mode	On any phase or on all 3 phases
Us < threshold	20...200% Un in 1% step
DT time delay	0 ms to 300 s in 1 ms step
Reset time delay	0...300 s in 1 ms step

Description:

Detection of abnormal voltage by measuring residual voltage to trigger:

Instances 1, 2 and 3:

- ANSI 59N : Residual voltage detection (indication)

Characteristics:

- Residual voltage can be calculated or measured.

Logical node name:

FPTOV x

ANSI 59N – Neutral voltage displacement

Characteristics

Number of instances	3
Setting groups	2
Detection mode	Definite time
Reset ratio (hysteresis)	93%

Setting

Measured voltage	Phase-phase/phase-ground
Us < Threshold	10...200% Un in 1% step (phase-ground)
DT time delay	0 ms to 300 s in 1 ms step
Reset time delay	0 ms to 300 s in 1 ms step

PowerLogic™ LV150

Low Voltage monitoring

Characteristics

Electrical characteristics

Input-voltage (with voltage adapter)	
Voltage measurement range	4 Un
Network	3 phases and neutral
Nominal voltage	L - L : 190...400 Vac
Frequency	45...67Hz
Impedance	10 MΩ
Input-current	
Nb of current inputs	4 current inputs: 3 phases and neutral with different setting for phase and neutral
Primary rated value	50...3000 A
Rated nominal current	1 A or 5 A
Current measurement range	0.01...7 In (rated nominal current)
Permissible overload	<ul style="list-style-type: none"> • 10 A In continuous • 50 A In-10 s per hour • 120 A -1 s
Impedance	1 milliohm
Burden	0.025 VA
Input-analog	
Type	3 analog 3-wires PT100 temperature sensors
Measurement range	-55...250 °C (-67...482 °F)
Resolution	1 °C (1 °F)
Accuracy	1%
Power supply	
Voltage input	12...48 Vdc (-15%, +20%)
Burden	3 VA; max typical: 1,5 VA

PowerLogic™ LV150

Low Voltage monitoring

Characteristics

Utilities are coming under increasing pressure from both customers and regulatory bodies alike to review the quality of power they are providing (EN50160).

This requires monitoring of their networks for various indices such as number of and duration of outages, dip/swell voltages and system harmonics.

The LV150 offers many high performance capabilities to meter and monitor the MV network with the same current and voltage sensors without the need to add an expensive specialized device.

PowerLogic™ T300 has a large capacity of storage for SCADA transmission and/or local consultation. All recorded measurements locally are consultable via the web server locally or remotely. The measurement log can be also downloaded in Excel format.

Logical node name:

MMXU

LV measurement

General characteristics

Power measurement as per	IEC 61557-12/PMD/SD/K70/1
Power quality as per	IEC 6000-4-30 class S
Current accuracy	0.5% from 0.1 In...1.2 In
Voltage accuracy	0.5% from 20% Un...120% Un
Active power	1%
Active energy accuracy	1%
Frequency range	45...67 Hz

Measured and metered values

	PM	Power quality option
Instantaneous RMS values		
Current: true rms	<ul style="list-style-type: none"> 3 phases and neutral 3 phases and neutral average 	% unbalanced
Voltage: true rms	<ul style="list-style-type: none"> 3 phases and neutral 3 phases and neutral average 	% unbalanced
Frequency	•	
Active, reactive, apparent power (total & per phase)	Signed	
Power factor (Total & per phase)	Signed	
Energy values		
Active, reactive, apparent energy	Signed	
Configurable accumulation mode	•	
Demand values		
Voltage & current.	•	
Active, reactive, apparent power	•	
Synchronization of the measurement window	•	
Demand windows calculation mode	Fixed	

PowerLogic™ LV150 Low Voltage monitoring

Characteristics

Measured and metered values

	PM	Power quality option
Other measurements		
Last current demand value before fault detection or switch opening	•	
Last voltage demand value before fault detection	•	
Last voltage value before broken conductor fault detection	•	
Power quality measurement		
Harmonic distortion – current and voltage (up to H40)		•
Individual harmonics – current and voltage (up to H40)		•
Voltage dip and swell events		•
Events		•
Voltage unbalance		•
Voltage magnitude		•
Data recording		
Average current rms Min/max : 1 day, 7 days, 1 month, 1 year	•	
Demand values at 3 months	•	
Event logs	•	
Alarms	•	
Counter	•	

PowerLogic™ LV150

Low Voltage monitoring

Characteristics

Measured and metered values setting

Demand value		
Demand computed mode	Block (synchronized on the T300 RTU clock from the HU250)	
Demand value computed period	Demand value computed period 1, 2, 5, 10, 15, 20, 30, 60 minutes	
Minimum and maximum value	By day, 7 days, 1 month, 1 year	
Power quality Voltage setting		
Voltage swell	Threshold	100...150% of Un in 1% steps
Voltage dip	Threshold	5...100% of Un in 1% steps
Voltage dip and swell short duration	DT time delay	10 ms - 60 s in 1 ms steps (2 instances of setting for short and long detection)
Voltage interruption	Threshold	1...90% of Un in 1% steps
Voltage interruption duration	DT time delay	60...900 s in 1 s steps
Current unbalance	Threshold	1...100% of In in 1% steps
	DT time delay	200 ms - 60 s in 1 ms steps
Voltage unbalance	Threshold	1%...100% of In in 1% steps
	DT time delay	200 ms - 60 s in 1 ms steps

PowerLogic™ LV150

Low Voltage monitoring

Characteristics

General characteristics

Dielectric compatibility			
Dielectric	IEC 60255-27	Common mode (CM):	<ul style="list-style-type: none"> Insulation (50 Hz/1 min.): 2 kV Surge (1.2/50 µs): 5 kV
Electromagnetic compatibility/Immunity			
Electrostatic discharge	IEC 61000-4-2	15 kV in air	
	Level 4/Criteria B	8 kV at contact	
Radiated RF electromagnetic fields	IEC 61000-4-3 Level 4/Criteria A	30 V/m – 27 MHz - 6 GHz	
Fast transients	IEC 61000-4-4	Power supply, Ethernet	CM: ±4 kV 5...100 kHz
	Level 4/Criteria A	Other circuits	CM: ±2 kV 5...100 kHz
Surge	IEC 61000-4-5	<ul style="list-style-type: none"> CM: 2 kV - wave 1.2/50 µs DM: 1 kV - wave 1.2/50 µs 	
	Power supply: Level 4/Criteria A		
	Other circuits: Level 3/Criteria A		
Conducted RF disturbances	IEC 61000-4-6	10 Veff	
	Level 3/Criteria A	0.15 MHz to 80 MHz	
Power frequency magnetic field	IEC 61000-4-8 Level 5/Criteria B	<ul style="list-style-type: none"> 100 A/m – 50 Hz - enduring 1000 A/m from 1...3 s 	
Immunity to voltage dips	IEC 61000-4-29 Criteria A	Voltage dip:	<ul style="list-style-type: none"> 24 Vdc: 100 ms 48 Vdc: 500 ms
		Voltage interruption:	<ul style="list-style-type: none"> 24 Vdc: 100 ms 48 Vdc: 500 ms
Pulse magnetic field immunity	IEC 61000-4-9 Level 5/Criteria A	1000 A/m	
Conducted common mode disturbance	IEC 61000-4-16 Level 4/Criteria A	CM: 30 V for 15 Hz - 150 kHz 300 V during 1 s	
Damped oscillatory waves	IEC 61000-4-18 Level 3/Criteria A	CM: 100 kHz, 1 MHz, 3 MHz, 10 MHz, 30 MHz - 2 kV	
Emission tests			
Radiated disturbances	CISPR22	Class A (EN5502)	

Criteria A definition: The unit shall continue to operate as intended during and after the test. No degradation of performance or loss of function is allowed below a performance level specified by the manufacturer, when the apparatus is used as intended. The performance level may be replaced by a permissible loss of performance.

Criteria B definition: The unit shall continue to operate as intended after the test. No degradation of performance or loss of function is allowed below a performance level specified by the manufacturer, when the apparatus is used as intended. The performance level may be replaced by a permissible loss of performance. During the test, degradation of performance is however allowed. No change of actual operating state or stored data is allowed.

PowerLogic™ LV150

Low Voltage monitoring

Characteristics

General characteristics

Environmental conditions		
Operating temperature	IEC 60068-2-1	-40...+70 °C
	IEC 60068-2-2	
Storage temperature	IEC 60068-2-1	-40...+85 °C
	IEC 60068-2-2	
Damp heat, steady state	IEC 60068-2-78	93% RH, 40 °C, RH no condensation , 56 days
Change of temperature	IEC 60068-2-14	-40...+70 °C, 5 °C/min, 10 Cycles, 27 h without condensation
Damp heat, cyclic	IEC 60068-2-30	144 h: 6 cycles of 24 h (+55 °C, 93% HR during 9 h; +25 °C, 95% HR during 6 h)
Salt spray test	IEC 60068-2-11	168 h
Product safety standards		
Protection of persons and goods	IEC 60255-27	
Fire resistance	IEC 60695-2-11	850 °C
Power supply		
Rated supply voltage		12...48 Vdc (+/-20 %)
Power consumption		< 2 VA

Mechanical characteristics

Degree of protection	IEC 60529	<ul style="list-style-type: none"> • Front cabinet: IP4x • Module body: IP2x
Robustness	IEC 62262	IK7 2 J
Vibrations	IEC 60068-2-6	10...2000 Hz/1g (peak value) 10 cycles
Bumps	IEC 60068-2-29	10 g/16 ms/1000 Bumps "non energized"
Shocks	IEC 60068-2-27	10 Gn/11 ms/3 pulses "in operation"
Weight		0.46 kg
Dimensions (H x W x D)		140 mm x 45 mm x 140 mm

Notes

Easergy PS50 Power Supply

The PowerLogic™ T300 backup power supplies are designed for long power supply interruption and to maintain control and monitoring of the entire MV substation during outages.

High-availability backup power supply range for control and monitoring applications

Designed to supply all components in the substation including switchgear mechanics and motors

- Designed for severe environments with a high level of insulation
- Designed for very long outage times
- Easy maintenance with only one battery



PS50

Easergy PS50 Power supply

The power supply provides backup operating power for long power supply interruptions for:

- MV switchgear motor mechanisms and circuit breaker coils
- Transmission devices (e.g., radio)
- Electronic modules of T300
- Third-party devices such as protection relays, fault passage indicators and other electronic devices

Easergy PS50 power supply model is adapted to various applications and to various sizes of T300:

	PS50
12 V IEDs	36 W
12 V Telecom	18 W
24 V/48 V permanent (IEDs)	10 W
Peak for motor. With battery	300 W

Power available for each voltage output depending on the version

Power supply part numbers

Type	Reference	Description
PS50-24 V	EMS58587	24 V motor for controller
PS50-48 V	EMS58588	48 V motor for controller

Battery part numbers

Type	Reference	Description
BAT24 AH	EMS58582	12 V - 24 Ah; 10 years
BAT38 AH	EMS58583	12 V - 38 Ah; 10 years

() Consult us for availability - Can be replaced by an equivalent product.*

Designed for severe environments:

The Easergy PS50 is ideal for isolated sites that are regularly struck by lightning.

- 10 kV insulation and 20 kV surge
- Prevented against neutral cutout
- High temperature range: -40 °C to 70 °C

And easy maintenance:

- Only an unique battery for easy maintenance and robust lifespan (> 10 years)
- Battery end-of-life monitoring for preventive maintenance

Recommended power supply by application

- PS50 for controller solution
 - High availability due to the separate voltage output for IEDs, telecom and motor
 - High efficiency and high energy backup autonomy
 - PS50 is the power supply in our packaged solution
 - Embedded high insulation

Power supply and battery

- Battery charging and monitoring for long battery life
 - Temperature-compensated charger
 - Charging current limitation
- Prevention against serious discharge
 - Protection against deep discharge
 - Protection against over voltage
- Battery availability check
 - Periodic battery test
 - Battery status indication
 - Capacity indication

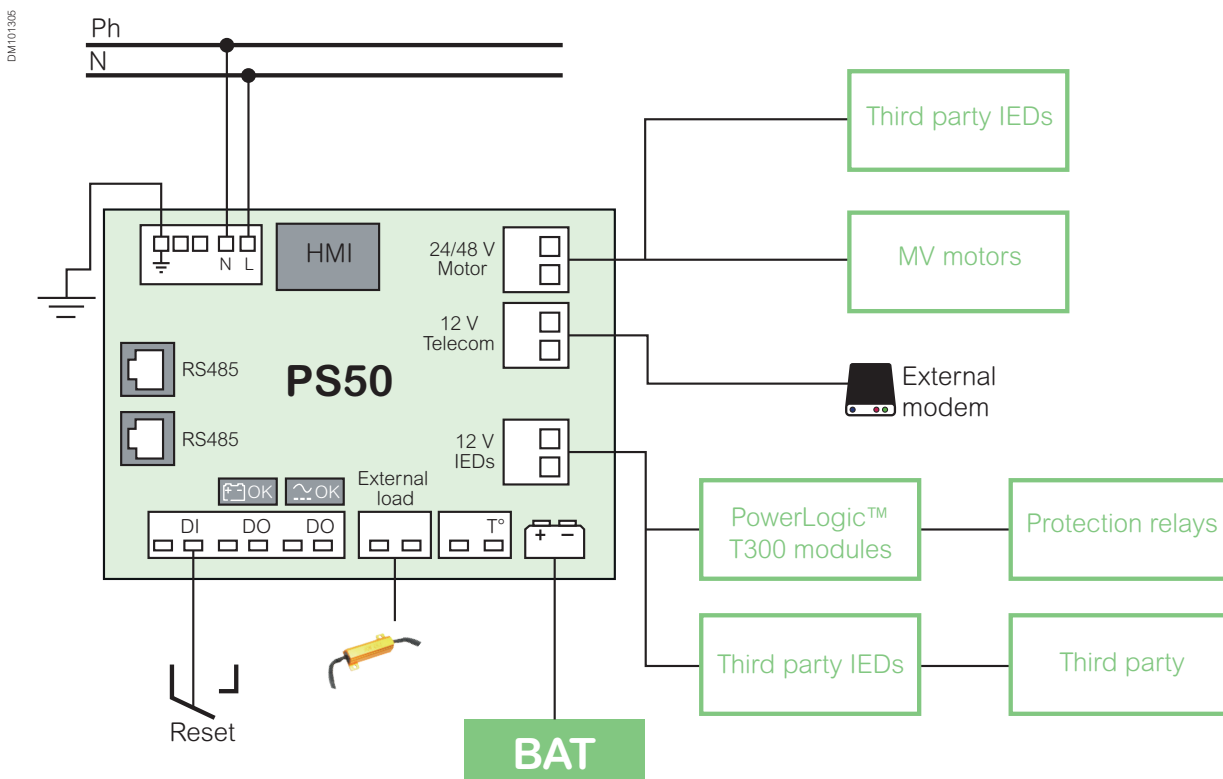

Example of power supply application with PS50

		PS50		
				
Application				
Controller		•		
Monitor		•		
PowerLogic™ T300 module size				
Number of Modules		Up to 16		
Output voltage				
12 Vdc dedicated to IEDs		•		
24 Vdc dedicated to IEDs				
12 Vdc for Telecom devices		•		
24 Vdc or 48 Vdc for switchgear motor		•		
Input voltage				
AC voltage input		110...240 Vac (-15%/+10%) – 50/60 Hz single phase		
DC voltage input		110...240 Vdc (-15%/+10%)		
Over voltage		Up to 440 Vac		
Output characteristics				
12 Vdc IEDs	Rated output power	36 W		
	Rated output voltage	12 V (10.5 V...15 V)		
	Continuous current	3 A		
	Overload limit	8 A		
	Short circuit peak current	13 A - 50 ms		
	Output overvoltage protection	15.5 V		
12 Vdc telecom	Rated output voltage	12 V (10.5...15 V)		
	Rated output power	Without battery	18 W	
	Continuous current		1.5 A	
	Overload limit		8 A	
	Short circuit peak current		13 A - 50 ms	
	Output overvoltage protection		15.5 V	
48 or 24 Vdc motor and IEDs		24 V	48 V	
	Rated output voltage	24 V ± 10%	48 V ± 10%	
	Rated output power	10 W		
	Continuous current	0.4 A	0.2 A	
	Overload limit	3 A	1.5 A	
	Short circuit peak current	40 A	40 A	
	Rated output power	300 W (60s max)		
	Rated output current	30 A - 50 ms then 12 A - 15 s	15 A - 50 ms then 6 A - 15 s	
	Output overvoltage protection	27 V	55 V	

		PS50
		
Voltage output monitoring		
12 Vdc Telecom	The output can be switched off by high load current detection, in order to disconnect a radio locked in permanent transmission (latch up).	Configurable: Enable/Disable Current: 0.2...4 A Duration: 1 s to 5 min
24 V or 48 V output	V output interruption management: activated only for motor control	•
12 Vdc IEDs	Sleep mode management	•
Voltage output protection (all voltage outputs)		
Overload and short circuit		•
Over temperature		•
Over-voltage		•
Battery management		
Number of batteries		1
Charger capacity		Up to 38 Ah
Battery type		Sealed lead maintenance free type
Battery charging control	Rated voltage	10.5...15 V
	Max charging current	Battery type configurable: 38 AH, 24 AH or others <38 AH
	Temperature compensated from internal T° measurement	•
	Charging time	10 h to 24 h
Battery protection	Against serious discharge	•
	Against short circuit	•
	Against reverse polarity connection	•
Battery test	Battery test on internal load (AC and DC method)	•
	Battery test on dedicated external load ^(**)	•
	Automatic periodic tests	•
	Activated by communication	•
Battery monitoring	Detection of battery end of life	•
	Detection of battery connection/disconnection	•
Energy backup management	Sleep mode	•
	Sleep mode timer configurable	•
	Wake-up by network returns	•
	Wake-up by push button	•
	Wake-up by digital input	•
Local HMI (LED on the power supply)		
Power input absence		•
Equipment status		•
48 V/24 V power supply status		•
12 V IED power supply status ON		•
12 V telecom power supply status ON		•
Battery status detected or battery end of life		•
Modbus communication status		•

(**) Consult us for availability

		PS50
		
Auxiliary contact		
Battery status		●
Battery is ON		●
AC supply ON (voltage presence)		●
Relay type - breaking capacity		60 Vdc – 2 A
Voltage output protection (all voltage outputs)		
Overload and short circuit		●
Over temperature		●
Overvoltage		●
Communication and monitoring Protocol		
Communication via Modbus RS485		●
Voltage and current output measurement		
12 V IEDs output	Current measurement	●
	Voltage measurement	●
12 V telecom output	Current measurement	●
	Voltage measurement	●
24/48 V motor output	Current measurement	●
	Voltage measurement	●
Battery voltage output	Current measurement	●
	Voltage measurement	●
Status information		
AC supply voltage presence		●
12 V and 48 V or 24 V output issue		●
Battery monitoring	Battery disconnected	●
	Battery is under charge	●
	Battery is in float mode	●
	Battery is discharging	●
	Battery charge level indicator	●
	Battery status	●
	Serious discharge alarm	●
	Battery low	●
Time-stamped events		100 events
Settings		
AC voltage presence and loss (threshold)		●
Battery monitoring: low voltage threshold		●
Battery monitoring: deep discharge threshold (serious discharge)		●
Battery charger parameter		●
Battery test period		●
Battery nominal capacity		●
Energy backup enable/ Disable		●
Energy backup threshold		●
Energy backup time duration		●

Easergy PS50 Power Supply

Power supply selection guide

		PS50
		
Commands		
Restart 12 V -48 V/24 V (Energy Backup)		•
Mechanical		
Weight		2.75 kg
Dimensions (H x W x D)		190 x 270 x 71 mm
		Vertical
Temperature		
Operating temperature range		-40...+70 °C
Storage temperature range		-40...+70 °C
Battery		
Brand		Yuasa
Voltage/amperage		12 V -24 Ah 12 V -38 Ah
Type		Lead acid
Lifespan		10 years
Storage temperature		-20...+60 °C
Charging temperature		-15...+50 °C
Discharging temperature		-20...+60 °C
Weight		SWL1100: 14 kg SWL750: 9 kg

PowerLogic™ T300 backup power supplies are designed to provide power during a long outage.

The battery autonomy depends on:

- The PowerLogic™ T300 configuration (number of modules)
- The external IED load
- The type of telecom devices and the cycle of communication with the control center
- The characteristics of the MV switchgear motor mechanism and the number of open/close cycles
- The type and capacity of the batteries
- The environment conditions (temperature, battery age, etc.)

In order to extend the battery autonomy in a long power interruption situation, PS50 can enter a sleep mode.

The backup energy thus saved can help provide an additional open/close operation (plus associated communications) of the MV switchgear when power is restored.

The following examples of energy backup duration are based on the following loads:

- Different configuration of PowerLogic™ T300 (number of modules)
- Motor consumption
- Communication consumption

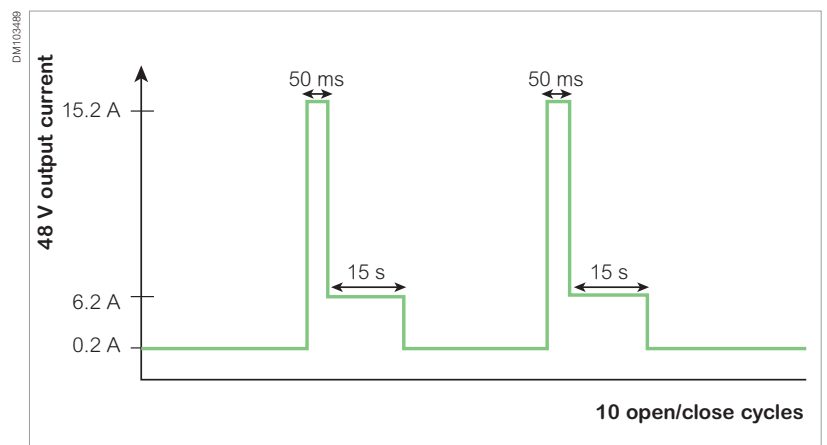

- Telecom consumption

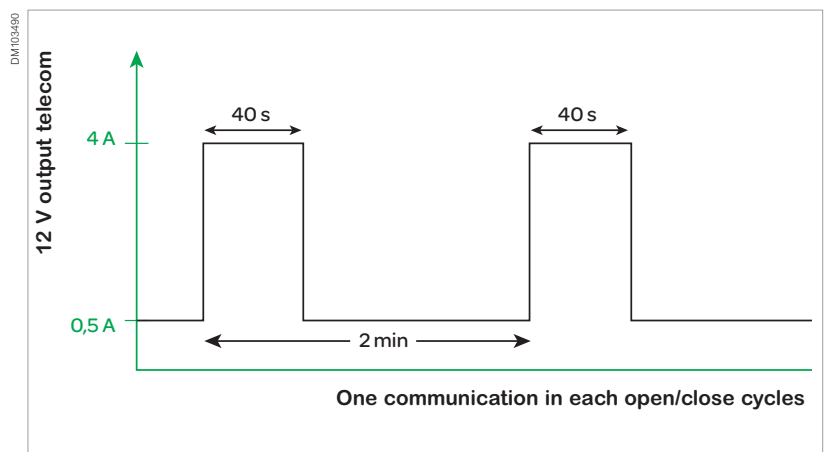

- Temperature: 20 °C

Example of power outage cycle and battery autonomy with PS50

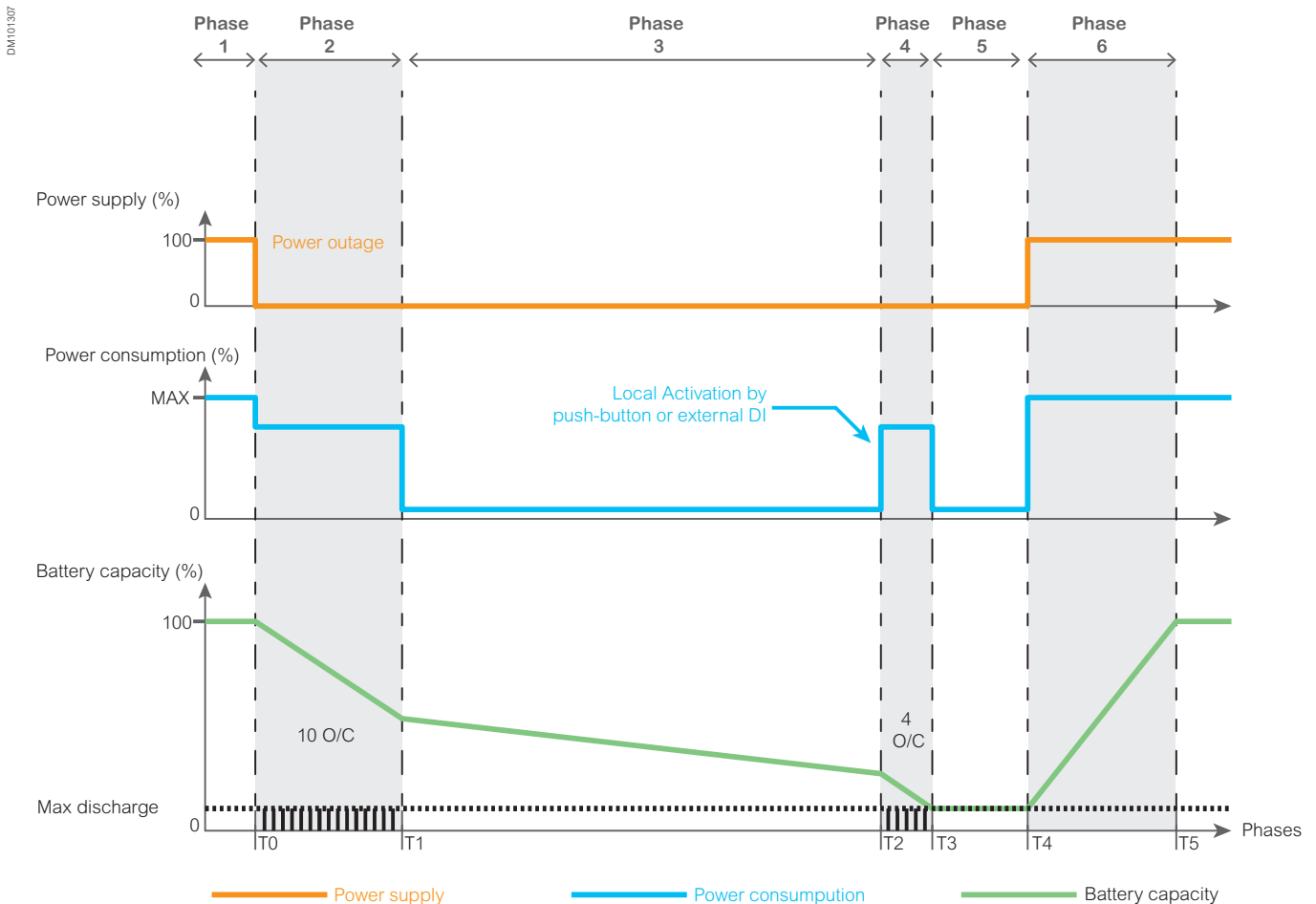

Phase 1

AC supply present and the battery is fully charged

Phase 2: Power outage

- Power supply absent, all loads are supplied from the battery
- Up to 10 open/close (O/C) operations are executed on MV switch motorization during this phase
- One control center radio communication for each O/C cycle

Phase 3: Sleep mode

- After a period of time (configurable), the sleep mode is activated to preserve battery capacity
- The voltage outputs are shut down and low power consumption mode is activated

Phase 4: Wake-up

- The power supply is awakened by pressing the button or via the external digital input
- Up to 4 O/C operations on the motorization are performed during this period
- One control center radio communication in each O/C cycle

Phase 5: Deep sleep

When the minimum discharge threshold is reached, the power supply enters deep sleep mode

Phase 6: AC supply is back

Power supply indicates an abnormal condition until battery capacity is above a certain threshold, the PS50 is again in Power On mode

Easergy PS50 Power Supply

Battery autonomy

Example of PS50 autonomy for each battery type, depending on presence of sleep mode and wake-up mode

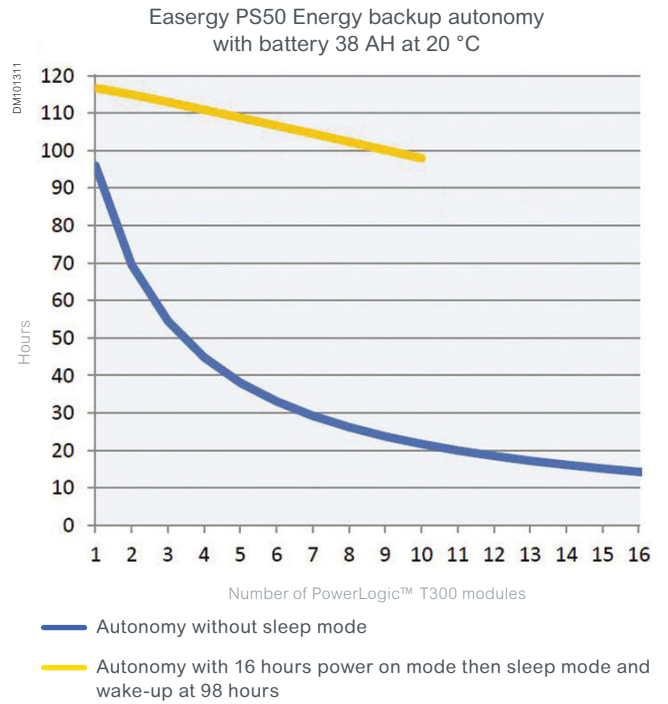
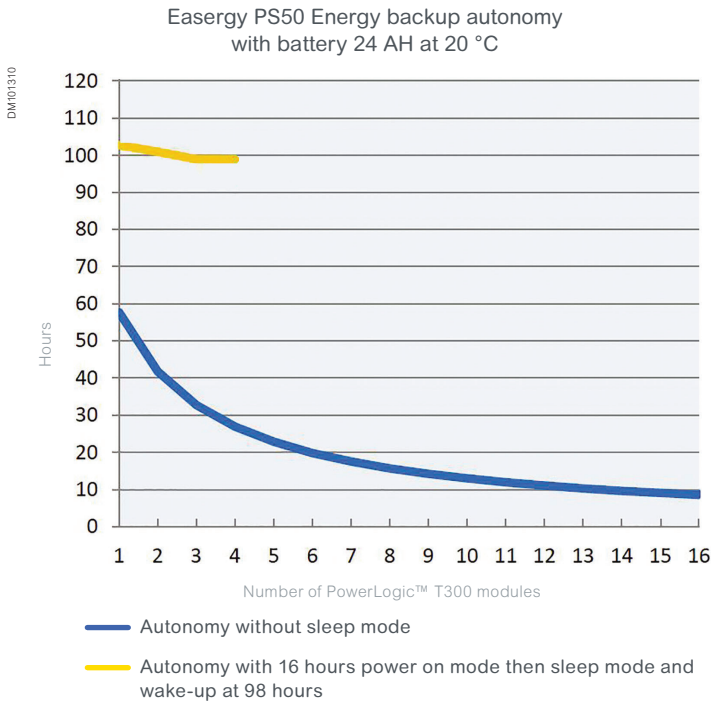

Example of autonomy for PS50 without sleep mode, depending on battery type

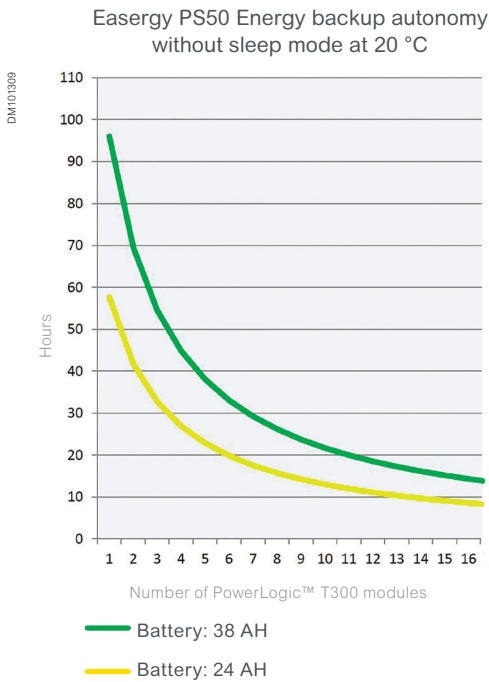

Easergy PS50 Power Supply

Characteristics

General characteristics

Dielectric compatibility			
Dielectric	IEC 60255-27	AC supply inputs	<ul style="list-style-type: none"> CM: Isolation (50 Hz/1 min.): 10 kV CM: Overvoltage (1.2/50 μs): 20 kV DM: Overvoltage (1.2/50 μs): 8 kV
		RS485	<ul style="list-style-type: none"> CM: Isolation (50 Hz/1 min.): 1.5 kV CM: Overvoltage (50 Hz/50 μs): 2.5 kV
		Others	<ul style="list-style-type: none"> CM: Isolation (50 Hz/1 min.): 2 kV CM: Overvoltage (1.2/50 μs): 5 kV DM: Isolation (50 Hz/1 min.): 1 kV DM: Overvoltage (1.2/50 μs): 3 kV
Emission tests			
Radiated disturbances	CISPR22	Class A (EN5502)	
Conducted disturbances	CISPR22	Class A (EN5502)	
Electromagnetic compatibility/Immunity			
Electrostatic discharge	IEC 61000-4-2	15 kV in air	
	Level 4/Criteria B	8 kV at contact	
Radiated RF electromagnetic fields	IEC 61000-4-3	30 V/m – 27 MHz...6 GHz	
Fast transients	IEC 61000-4-4	AC supply	CM: \pm 4 kV (L4) 5 kHz...100 kHz
		Output V, RS485	
Surge	IEC 61000-4-5	AC supply input	<ul style="list-style-type: none"> CM: 4 kV (L4) - wave 1.2/50 μs DM: 2 kV (L4) - wave 1.2/50 μs
		Others	<ul style="list-style-type: none"> CM: 2 kV (L3) - wave 1,2/50 μs DM: 1 kV (L3) - wave 1,2/50 μs
Conducted RF disturbances	IEC 61000-4-6	10 Veff	
	Level 3/Criteria A	0.15 MHz to 80 MHz	
Power frequency magnetic field	IEC 61000-4-8	<ul style="list-style-type: none"> 100 A/m – 50 Hz enduring 1000 A/m from 1...3 s 	
Pulse magnetic field	IEC 61000-4-9	1000 A/m	
	Level 5/Criteria A		
Conducted common mode disturbance	IEC 61000-4-16	CM: 30 V for 15 Hz to 150 kHz 300 V during 1 s	
Damped oscillatory waves	IEC 61000-4-18	CM: 100 kHz, 1 MHz, 3 MHz, 10 MHz, 30 MHz - 2 kV	
	Level 3/Criteria A		

Criteria A definition: The unit shall continue to operate as intended during and after the test. No degradation of performance or loss of function is allowed below a performance level specified by the manufacturer, when the apparatus is used as intended. The performance level may be replaced by a permissible loss of performance.

Criteria B definition: The unit shall continue to operate as intended after the test. No degradation of performance or loss of function is allowed below a performance level specified by the manufacturer, when the apparatus is used as intended. The performance level may be replaced by a permissible loss of performance. During the test, degradation of performance is however allowed. No change of actual operating state or stored data is allowed.

General characteristics

Environmental conditions		
Operating temperature	IEC 60068-2-1 IEC 60068-2-2	-40 °C...+70 °C
Storage temperature	IEC 60068-2-1 IEC 60068-2-2	-40 °C...+70 °C
Damp heat, steady state	IEC 60068-2-78	93% RH, 40 °C, RH no condensation, 56 days
Change of temperature	IEC 60068-2-14	-40 °C...+70 °C, 1 °C/min, 10 cycles, 27 h without condensation
Damp heat, cyclic	IEC 60068-2-30	144 h: 6 cycles of 24 h (+55 °C, 93% HR during 9 h; +25 °C, 95% HR during 6 h)
Salt spray test	IEC 60068-2-11	168 h
Product safety standards		
Protection of persons and goods.	IEC 60255-27	
Insulation resistance	IEC 60255-27	<ul style="list-style-type: none"> • 500 V CM & DM • R>100 MΩ
Fire resistance	IEC 60695-2-11	850°C
Flame retardant	IEC 60695-11-5	<ul style="list-style-type: none"> • Flame application: 5 times 15 s each. • Interval between each application: 15 s or 1 time 30 s
Protective bounding continuity	IEC 60255-27	12 V, <0.1 Ω, 60 s

Mechanical characteristics

Degree of protection	IEC 60529	IP20
Robustness	IEC 62262	IK7 2 J
Vibrations	IEC 60068-2-6	10 to 2000 Hz/1 g (peak value) 10 cycles
Bumps	IEC 60068-2-29	10 g/16 ms/1000 Bumps "non energized"
Shocks	IEC 60068-2-27	10 Gn/11 ms/3 pulses "in operation"
Weight		2.75 kg
Dimensions H/W/D (state of delivery)		190 x 270 x 71 mm

Easergy PS50 Power Supply

Installation

PS50 is DIN rail mounted for easy integration in any MV/LV substation (example: low voltage compartment of the MV switchgear).

PS50 includes on its front face a DIN rail, to which T300 modules can easily be attached.

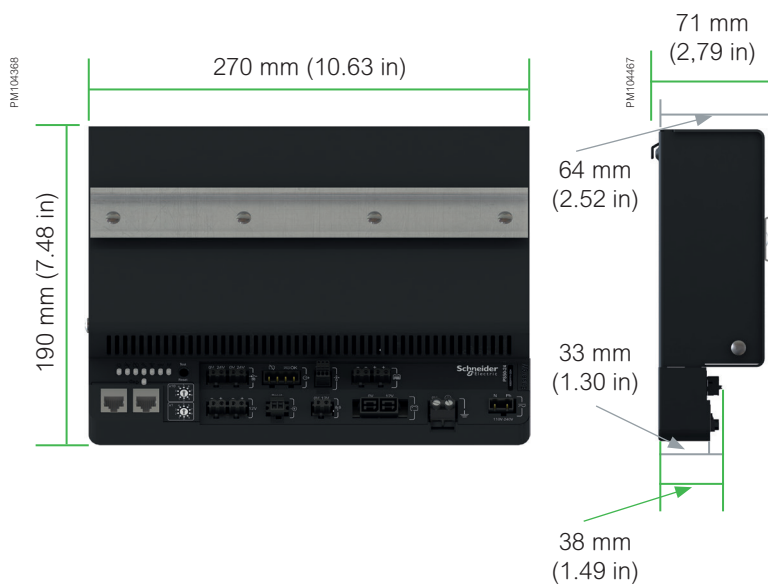

Notes

Cabinet and Smart RMU Solution

Cabinet and Smart RMU Solution

Ready-to-use solution Catalog	132
General description	132
T300-IV1 cabinet	133
T300-OVR cabinet	134
Smart RMU offer	135

Ready-to-use solution Catalog

General description

Information presented on front panels is visible through a window, without opening the door.



Ready-to-use cabinet solution

- A selection of ready-to-use cabinets is available off-the-shelf for fast delivery and installation.
- Cabinets are also modular and flexible in order to offer a just-right solution
- A Product Selector allows you to quickly build your configuration and ordering. Refer to PowerLogic™ T300 web page on Schneider Electric web site.

T300 is offered as a compact Feeder RTU solution standardized in a complete cabinet build and corresponding to the standard requirements of an MV/LV substation. These solutions are modular and can be adapted to the specific requirements.

All configurations can be extended on-site with different PowerLogic™ T300 modules. You can consult our Engineering Centers to design or customize a dedicated solution.

Two types of enclosure are available as standard, depending on the installation environment:

- Indoor controller cabinet
- Outdoor controller cabinet, wall-mounted or pole-mounted



Indoor Vertical version – T300-IV1

Two types of enclosure are offered as standard:

- T300-IV1: Vertical wall-mounted cabinet for indoor applications
- T300-OVR: Vertical wall-mounted cabinet for outdoor applications

Ready-to-use solution Catalog

T300-IV1 cabinet

Modules assembled on a DIN rail including:

- 1 Power Supply PS50
- 1 Front Head Unit HU250
- 1 to 4 modules Switch Controller SC150



Reserved for one LV150 module

1 AC 1Ph+N breaker

1 battery 24 Ah or 38 Ah

10 points terminal switch connectors are mounted to the underside of the enclosure.

A pre-configured flange

is available on the lower part. This flange includes cut-out cable gland plates and so enables installation of any size of cable with any diameter. This flange is IP65 degree of protection.

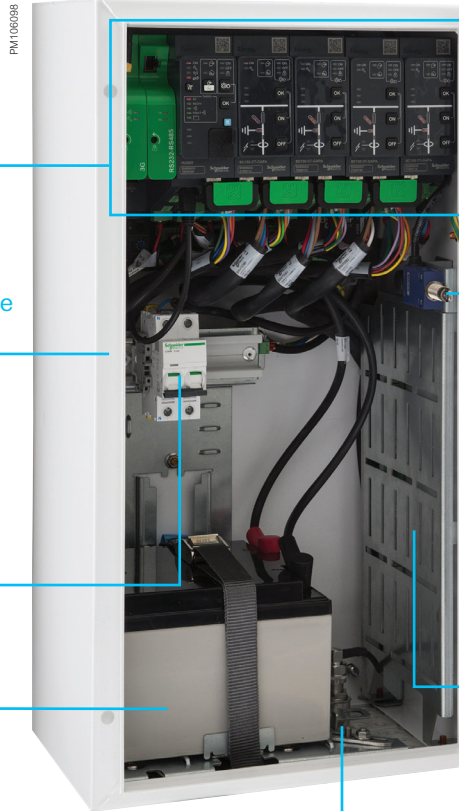

T300-IV1 cabinet
Indoor Vertical version

Optional

Open door contact

Connected internally to a digital input, it enables remote indications of the door status (open/closed).

CTs easy access plug

The connections of the CTs are normally made directly on the SC150 modules themselves. This option enables centralization of the CT connections for the unit's SC150 modules in a more accessible location on the right-hand side of the enclosure.

Transmission plate

A free space for installation of external transmission devices

- Height = 300 mm
- Width = 60 mm
- Depth = 220 mm

This space includes a metallic plate (optional) for the installation of a radio or modem.

Antenna surge arrestor

For GSM/3G or radio purposes, it helps prevent surge and deterioration due to antenna overvoltage.

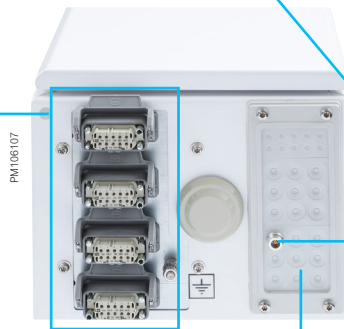

T300-IV1 Characteristics

• **Dimensions**

- Basic enclosure:
H 600 x W 310 x D 250 mm
- Basic enclosure + 10 point connectors:
H 640 x W 310 x D 250 mm

- **Weight:** 40 kg
- **Material:** Metallic
- **Mounting:** Wall-mounted, vertically
- **Protection indices:** IP31 - IK07
- **Paint color reference:** RAL 9003

Ready-to-use solution Catalog

T300-OVR cabinet

Modules assembled on a DIN rail including:

- 1 Power Supply PS50
- 1 Front Head Unit HU250
- 1 to 4 modules Switch Controller SC150

1 AC 1Ph+N breaker



Reserved for one
LV150 module

1 battery 24 Ah or 38 Ah

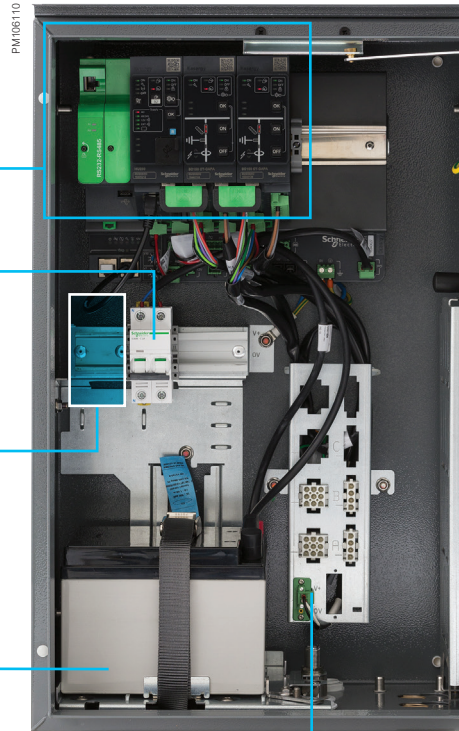

T300-OVR cabinet
Outdoor Vertical version

Optional

Opened door contact

Connected internally to a digital input, it enables remote indications of the door status (open/closed).

Antenna surge arrestor

For GSM/3G or radio purposes, it helps prevent surge and deterioration due to antenna overvoltage.

Ringmaster specific
AMP switch and current
transformer connectors

Connection

- All cable access is located on the lower part of the enclosure
- An adjustable sliding plate at the lower part of the enclosure facilitates entry to the switch and current cables and also locks the cable glands
- All switch and current cable connections are compatible with the Ringmaster standard



T300-OVR Characteristics

- **Dimensions**
Basic enclosure:
H 600 x W 380 x D 275 mm
- **Weight:** 40 kg
- **Material:** Metallic
- **Mounting:**
 - Wall-mounted, vertically
 - The enclosure can be attached to the Ringmaster using the standard T200E mounting kit
- **Protection indices:** IP54 - IK09
- **Paint color reference:** RAL 7012

Ready-to-use solution Catalog

Smart RMU offer

Smart RMU: Best-in-class technologies in one solution

- Built on decades of electrical distribution experience, the smart RMU is robustly engineered to provide superior efficiency – even in the harshest environment.
- Easy to install and operate, a fully SF6-insulated smart RMU is:
- Embedding features to enhance safety, such as rotating arc technology* and visible earthing contact
- Equipped with standard or custom metal enclosure for indoor or outdoor* installation
- Enriched with smart interfaces for self-powered relays, fault passage indicators (FPIs), and sensors
- Compliant with the latest IEC standards for connectivity, automation schemes, and cybersecurity

*Available for Ringmaster and RM6

Sensors for the smart RMU

The smart ring main unit includes a set of fully integrated sensors for voltage, power, current, and temperature monitoring. For faster and simpler on-site assembly, the sensors are pre-installed where possible (due to application some sensors are supplied in kit form).



The Smart RMU solution is available with RM6, FBX and Ringmaster.

Accessories

Accessories

Voltage Adapter	138
Voltage Adapter and Climate sensor	139
CT current transformer	140
Installation accessories	141

Voltage adapters

MV Voltage adapters

The different MV sensors used with the SC150 are summarized in the table below. Each type of voltage sensor requires a specific adapter (available as an option) for connection to the SC150 module:

	Description	Part #
 <p>PM106126</p>	<p>Voltage adapter for VTs</p> <ul style="list-style-type: none"> Voltage inputs <ul style="list-style-type: none"> U rated value: <ul style="list-style-type: none"> LN 22...240 V - LL 38V...400 V Product safety standards <ul style="list-style-type: none"> IEC/EN 61010-1 ed.3, CAT III, 400 V L-N/690 V L-L UL 61010-1 ed.3 and CSA-C22.2 No. 61010-1 ed.3, CAT III, 347 V L-N/600 V L-L IEC/EN 62052-11, protective class II Standard insulation <ul style="list-style-type: none"> Common mode: 2.5 kV (50 Hz, 1 min) 5 kV (1.2/50 μs) Differential mode: 4 kV (1.2/50 μs) IP 30 	<p>EMS59572</p>
 <p>PM106129</p>	<p>VDS Adapter</p> <ul style="list-style-type: none"> Voltage input: LL from 1...30 V max IP: IP 30 	<p>EMS59571</p>
 <p>PM106128</p>	<p>VPIS VO-V3 Adapter</p> <ul style="list-style-type: none"> Voltage input: LL from 1...30 V max IP 30 	<p>EMS59577</p>
 <p>PM106127</p>	<p>PPACS Adapter</p> <ul style="list-style-type: none"> Voltage input: LL from 1...30 V max Cable length: 54 cm IP 30 	<p>EMS59575</p>
 <p>PM106130</p>	<p>LPVT RJ45-RJ45 sensors Hub</p> <ul style="list-style-type: none"> Mounting: Din rail and plastic clamp Size: 90 x 45 x 35 mm IP 30 	<p>EMS59573</p>

Voltage adapter and Climate sensors



LV Voltage adapter

The LV150 voltage measurement requires a specific adapter (available in spare part) for connection to the module. This Voltage adapter helps ensure the insulation level needed in the MV/LV substation.

	Description	Part #
 <p>PM106937</p>	<p>AC Voltage adapter for LV150</p> <ul style="list-style-type: none"> Voltage inputs <ul style="list-style-type: none"> U rated value: <ul style="list-style-type: none"> LN 22...240 V - LL 38...400 V Product safety standards <ul style="list-style-type: none"> IEC/EN 61010-1 ed.3, CAT III, 400 V L-N/690 V L-L UL 61010-1 ed.3 and CSA-C22.2 No. 61010-1 ed.3, CAT III, 347 V L-N/600 V L-L IEC/EN 62052-11, protective class II Standard insulation <ul style="list-style-type: none"> Common mode: 10 kV (50 Hz, 1 s), 6 kV (50 Hz, 1 min) 5 kV (1.2/50 μs) Differential mode: 4 kV (1.2/50 μs) IP 30 	<p>EMS59574</p>

Climate sensors

PowerLogic™ T300 uses climate sensors to measure continuously ambient temperature and humidity for condition monitoring features.

	Description	Part #
 <p>PM106930</p>	<p>Thermal sensor - TH110</p> <ul style="list-style-type: none"> Power supply: Self powered, energy harvested from power circuit Accuracy: +/- 1 °C Range: -25 °C/+115 °C Wireless communication: ZigBee Green Power 2,4 GHz Dimensions: 31 x 31 x 13 mm - 15 g 	<p>EMS59440</p>
 <p>PM106932</p>	<p>Thermal and humidity sensor - CL110</p> <ul style="list-style-type: none"> Powered by battery Accuracy: +/- 1 °C Range: -25 °C/+115 °C Wireless communication: ZigBee Green Power 2,4 GHz Dimensions: 31 x 31 x 13 mm - 40 g 	<p>EMS59443</p>

PM104250



Resonated split core phase CT, class 1 (ref. [EMS58183](#)) or class 3 (ref. [EMS58175](#))

PM104500



Resonated split core balanced CT (ref. [EMS58111](#))

PM106926

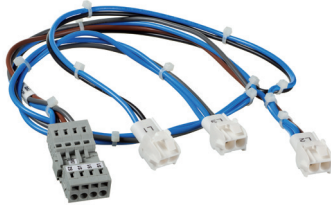

CT AMP connector to screw connector adapter (ref. [EMS58130](#))

PM106347



Current sensors connection cable with AMP connectors (ref. [EMS58132](#) to [EMS58137](#))

PowerLogic™ T300 can be used with standard CT compliant with IEC 61869, part 1 + 2 for the MV measurement (fault current detection and power measurement) and LV measurement.

The current sensors used for measuring can be 1 A or 5 A secondary with security factor limiting the current to 100 A secondary -1s. These current sensors are not compliance with class P needed for protection function.

Accuracy class

It consists in controlling the right adaptation of the CT on the accuracy class aspect.

The total dissipated power of the measurement circuit (T300 + cables) should not be greater than the specified limit of the CT (burden). This limit is for different standard classes. If necessary, the choice of the cable section and the CT should be selected accordingly to fit the requirement.

Refer to the Burden of current input of SC150 and LV150 : impedance input = 1 mΩ.

The following split core CT are designed for retrofit. A large range of CT are available in Schneider Electric Catalogue.

You can consult us for more information and additional split core CT solution.

MV and LV current sensors

MV current sensor characteristics	Phase current sensors	Phase or core balanced current sensors
Standard	IEC 61869-1	
Internal diameter	50 mm	150 mm
External diameter	110 mm	190 mm
Thickness	35 mm	45 mm
Primary CT rating	500 A	
Type of CT	Split-core and closed CT	Split-core CT
Secondary CT rating	1 A	
Accuracy on rated frequency range	Class 3 and Class 1	
Rated frequency	50 or 60 Hz	
Rated frequency range	47...500 Hz	
Security factor	6	
Operating range	5 A...1800 A	
Rated continuous thermal current	600 A	
Rated short-time thermal current (I _{th}) (CT in short-circuit)	25 kA during 1 s	
Secondary voltage without charge for a primary current, varying from 0 to 12.5 kA and varying from 0 to 50 kA	< 1000 V rms < 5000 V peak	
Isolation voltage (wiring included)	4 kV 50 Hz 1 minute in common mode	
Impulse test 1.2/50 μs (wiring included)	5 kV peak in common mode and differential mode	

		Description	Part #
Current sensors kit			
PM104250		<ul style="list-style-type: none"> 3 encapsulated phase split CT class 3, and 1 CTs cable connection with screw connectors 3 encapsulated phase split CT 500/1, class 1, and 1 CTs cable connection with screw connectors 	EMS58171 EMS58182
PM106342		1 encapsulated split core balanced CT, and 1 CT cable connection with screw connectors	EMS58111
MV Switchgear motor connection cable for T300-IVx cubicle			
PM106313		<p>The connection cable for wiring to the MV cubicle is available with several lengths and comprises:</p> <ul style="list-style-type: none"> One 10-pin tamper-proof connector One labelled connection cable: cable cross-section 1.5 mm². 	EMS58791 to EMS58795
PM106315		<p>The cubicle connector is also available without cable.</p> <p><i>Note: the cubicle connector and the connection cable are only supplied with the T300-IVR cabinet.</i></p>	EMS58770
PPACS			
PM107362		<p>The PPACS comprises:</p> <ul style="list-style-type: none"> Three voltage sockets for connection to the capacitive divider of the three separate connectors of each phase cable One Harting connector for the connection to the T300-SC150 via LVCx cable and PPACS adapter. <p><i>For wiring to the MV cubicle, optional PPACS cables are available with several lengths (2 m, 3 m, 5 m, 10 m)</i></p>	EMS58378 EMS58381 to EMS58385
Outdoor light indicator			
PM106322		<ul style="list-style-type: none"> A Red/Green LED outdoor light indicator can be connected to the HU250 module of the T300 to indicate an Ammetric or Directional fault current detection The output is powered to allow the indicator blinking Characteristics: <ul style="list-style-type: none"> Sealed 6 V light indicator: IP54 Connection by 1.5 mm² cable (not supplied) Period of flash 1 s 	59988
PM106323			
Cellular antenna			
PE56302		<p>Depending on the installation and the cabinet, the external antenna for mobile data modem is required in order to have a good transmission coverage.</p> <p>Two versions are available :</p>	
		<ul style="list-style-type: none"> Outdoor version with 5 m cable and type N connector. Must be used with surge arrest 	EMS59160 EMS59518
		<ul style="list-style-type: none"> Indoor version with 5m cable and type SMA connector 	EMS59162
GPS antenna			
PM106744		<p>External GPS antenna for HU250 clock synchronization with modem 4G. Main Characteristics:</p> <ul style="list-style-type: none"> Time synchronization accuracy: 1 ms Frequency: 1575 +/- 3 MHz Bandwidth: min 10 MHz Connector: SMA Cable length: 5 m Mounting: magnetic base 	EMS59161

Schneider Electric Service

Schneider Electric Service

**Peace of mind
throughout your installation life cycle** **144**

**Environmental information with
Green Premium™ ecolabel** **145**

Peace of mind throughout your installation life cycle

How can you cut costs and improve performance at the same time?

When it comes to your electrical distribution infrastructure, the answer is straightforward: get professional expertise.

Life Cycle Services

DBA03843

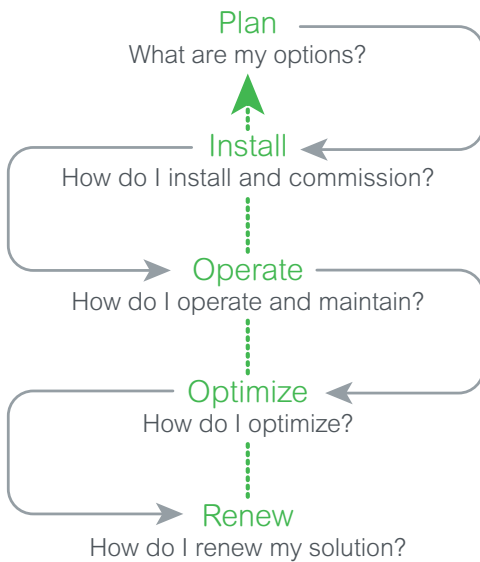

When it comes to your electrical distribution installation, we can help you:

- Increase productivity and reliability
- Mitigate risk and limit downtime
- Keep equipment up to date and extend lifespan
- Cut costs and increase savings
- Improve your return on investment

CONTACT US!

<https://www.se.com/ww/en/work/services/>

Plan

Schneider Electric helps you plan the full design and execution of your solution, looking at how to secure your process and optimize your time:

- **Technical feasibility studies:** Design a solution in your environment
- **Preliminary design:** Accelerate turnaround time to reach a final solution design

Install

Schneider Electric will help you to install efficient, reliable and secured solutions based on your plans.

- **Project management:** Complete your projects on time and within budget
- **Commissioning:** Ensure your actual performance matches the design, through on-site testing and commissioning, and tools and procedures

Operate

Schneider Electric helps you maximize your installation uptime and control your capital expenditure through its service offer.

- **Asset operation solutions:** Provide the information you need to enhance installation performance, and optimize asset maintenance and investment
- **Advantage service plans:** Customize service plans that cover preventive, predictive and corrective maintenance
- **On-site maintenance services:** Deliver extensive knowledge and experience in electrical distribution maintenance
- **Spare parts management:** Ensure spare parts availability and an optimized maintenance budget of your spare parts
- **Technical training:** Build the necessary skills and competencies to properly and efficiently operate your installations

Optimize

Schneider Electric can make recommendations for improved availability, reliability and quality.

- **MP4 electrical assessment of customer installations:** Define an improvement and risk management program

Renew

Schneider Electric extends the life of your system while providing upgrades.

We offer to take full responsibility for the end of life processing of old electrical equipment.

- **ECOFIT™:** Keep up to date and improve the performance of your electrical installations (LV, MV, protection relays, etc.)
- **MV product end of life:** Recycle and recover outdated equipment with end of life services

Environmental information with Green Premium™ ecolabel

Green Premium™

An industry leading portfolio of offers delivering sustainable value



More than 75% of our product sales offer superior transparency on the material content, regulatory information and environmental impact of our products:

- RoHS compliance
- REACh substance information
- Industry leading # of PEP's*
- Circularity instructions



Discover what we mean by green
[Check your products!](#)

The Green Premium program stands for our commitment to deliver customer valued sustainable performance. It has been upgraded with recognized environmental claims and extended to cover all offers including Products, Services and Solutions.

CO₂ and P&L impact through... Resource Performance

Green Premium brings improved resource efficiency throughout an asset's lifecycle. This includes efficient use of energy and natural resources, along with the minimization of CO₂ emissions.

Cost of ownership optimization through... Circular Performance

We're helping our customers optimize the total cost of ownership of their assets. To do this, we provide IoT-enabled solutions, as well as upgrade, repair, retrofit, and remanufacture services.

Peace of mind through... Well-being Performance

Green Premium products are RoHS and REACh compliant. We're going beyond regulatory compliance with step-by-step substitution of certain materials and substances from our products.

Improved sales through... Differentiation

Green Premium delivers strong value propositions through third-party labels and services. By collaborating with third-party organizations we can support our customers in meeting their sustainability goals such as green building certifications.

*PEP: Product Environmental Profile (i.e. Environmental Product Declaration)

Commercial references

Commercial references

Digital configuration and ordering tools	148
<hr/>	
PowerLogic™ T300	149
PowerLogic™ HU250: Head unit and communication interfaces	149
PowerLogic™ SC150: Switchgear controller and option	149
PowerLogic™ LV150: Low Voltage monitoring	150
Easergy PS50: Power supply	150
Cabinet integration	151
Switchgear connection kit	151
<hr/>	
Accessories	152
Voltage sensors and Voltage adapter accessories	152
Current sensors	153
Outdoor indicator light indicator	153
Communication accessories	153
<hr/>	
TOOLS	154
<hr/>	

Digital configuration and ordering tools

PowerLogic™ T300 CONFIGURATOR:
The unique web tool to quickly and easily configure your PowerLogic™ T300 Feeder RTU.

Fast and simple

You will find a detail of PowerLogic™ T300 offer on the Schneider Electric Website.

The commercial reference with description is available on the Product Selector and a webconfigurator allows you to define a configuration for Cabinet, OEM solution and accessories:

<https://www.se.com/ww/en/product-range/62399-PowerLogic™-t300>

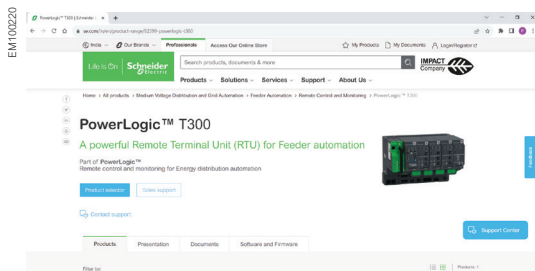

PowerLogic™ T300 home page on se.com

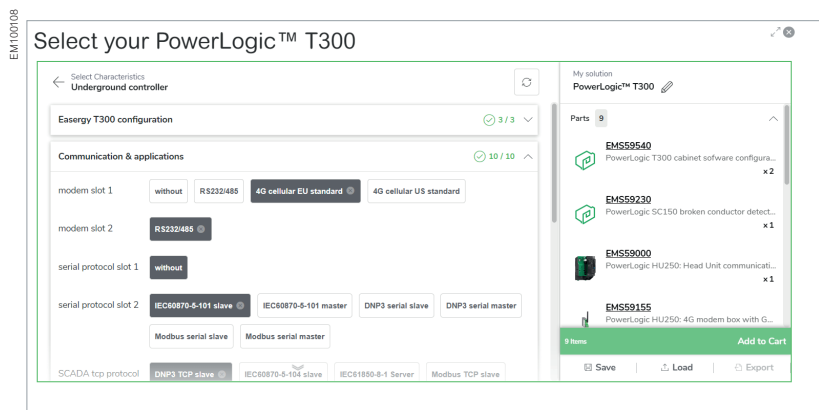
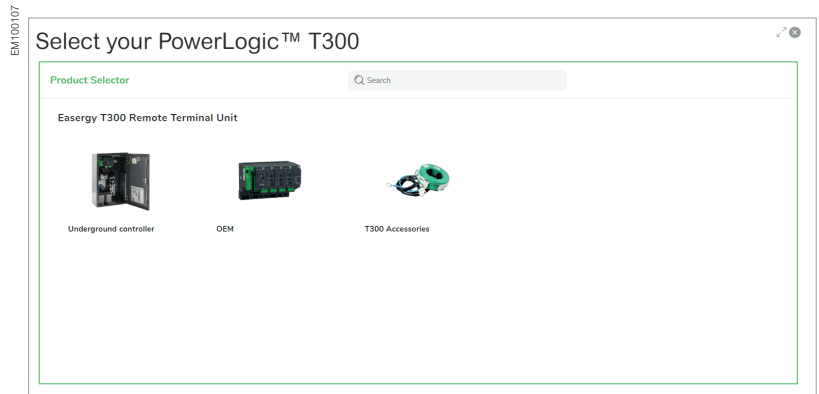

Number of identical T300 configurations ordered

- Please indicate the Part No. (for example: **EMS59000**) to your Schneider Electric correspondent.
- For other variants please contact your Schneider Electric correspondent

The order forms can be used to define T300 accessories.

Check the boxes that match your choices.

PowerLogic™ HU250: Head unit and communication interfaces

Part No.	Qty.	Designation
Model		
EMS59000	<input type="checkbox"/>	PowerLogic™ HU250: Head Unit gateway
EMS59010	<input type="checkbox"/>	HU250 set of connectors
EMS59528	<input type="checkbox"/>	10 Ethernet jumper module LAN connection

PowerLogic™ SC150/160: Switchgear controller and option

Part No.	Qty.	Designation
Module variant		
EMS59201	<input type="checkbox"/>	PowerLogic™ SC150-CT-LPVT/VT: Switch controller with std current CT and LPVT-VT voltage sensors
EMS59202	<input type="checkbox"/>	PowerLogic™ SC150-CT-CAPA :Switch controller with std current CT and VPIS/VDS/PPACS voltage sensors
EMS59220	<input type="checkbox"/>	SC150 set of connectors
EMS59210	<input type="checkbox"/>	SC160-CT-VT/LPVT : current transformer interface – VTs and LPVT voltage interface
Voltage adapter		
EMS59577	<input type="checkbox"/>	VPIS V3 VO RJ45 voltage adapter
EMS59571	<input type="checkbox"/>	VDS RJ45 voltage adapter
EMS59572	<input type="checkbox"/>	AC voltage adapter
EMS59573	<input type="checkbox"/>	LPVT RJ45-RJ45 hub voltage adapter
EMS59575	<input type="checkbox"/>	PPACS voltage adapter

PowerLogic™ LV150: Low Voltage monitoring

Part No.	Qty.	Designation
Module variant		
EMS59300	<input type="checkbox"/>	LV150: Low Voltage Power monitoring
EMS59320	<input type="checkbox"/>	Set of connectors for PowerLogic™ LV150
Voltage adapter		
EMS59574	<input type="checkbox"/>	LV AC voltage adapter

Easergy PS50: Power supply

Part No.	Qty.	Designation
Power supply module		
EMS58587	<input type="checkbox"/>	Easergy PS50-24V: backup power supply 24V output for motor
EMS58588	<input type="checkbox"/>	Easergy PS50-48V: backup power supply 48V output for motor
Battery		
EMS58590	<input type="checkbox"/>	PS50 set of connectors
EMS58582	<input type="checkbox"/>	12V...24 AH 10 years lifespan
EMS58583	<input type="checkbox"/>	12V...38 AH 10 years lifespan
EMS58589	<input type="checkbox"/>	12V...5.5 AH 10 years lifespan

Cabinet integration

(Cannot be ordered separately)



PowerLogic™ T300-IV1



PowerLogic™ T300-OVR

Part No.	Qty.	Designation
Indoor controller cabinet		
EMS59450	<input type="checkbox"/>	PowerLogic™ T300-IV1-1 SW: for 1 SC150
EMS59451	<input type="checkbox"/>	PowerLogic™ T300-IV1-2 SW: for 2 SC150
EMS59452	<input type="checkbox"/>	PowerLogic™ T300-IV1-3 SW: for 3 SC150
EMS59453	<input type="checkbox"/>	PowerLogic™ T300-IV1-4 SW: for 4 SC150
Outdoor controller cabinet (RN2D)		
EMS59470	<input type="checkbox"/>	PowerLogic™ T300-OVR-1 SW: for 1 SC150
EMS59471	<input type="checkbox"/>	PowerLogic™ T300-OVR-2 SW: for 2 SC150
EMS59472	<input type="checkbox"/>	PowerLogic™ T300-OVR-3 SW: for 3 SC150
EMS59473	<input type="checkbox"/>	PowerLogic™ T300-OVR-4 SW: for 4 SC150
Cabinet options		
EMS59510	<input type="checkbox"/>	Cabinet door status
EMS59511	<input type="checkbox"/>	CT terminal block_1sw
EMS59512	<input type="checkbox"/>	CT terminal block_2sw
EMS59513	<input type="checkbox"/>	CT terminal block_3sw
EMS59514	<input type="checkbox"/>	CT terminal block_4sw
EMS59515	<input type="checkbox"/>	Radio kit
EMS59516	<input type="checkbox"/>	Transmission device plate
EMS59517	<input type="checkbox"/>	PPACS terminal block
EMS59518	<input type="checkbox"/>	GPRS antenna connector and surge arrester

Note: Switch motorization cables are not included in the cabinet references

The Part numbers for cabinet and accessories cannot be ordered as standalone references. They can only be ordered as configured products via the **Product Selector** tool:

<https://www.se.com/ww/en/product-range/62399-PowerLogic™-t300>

Switchgear connection kit

Part No.	Qty.	Designation
EMS58770	<input type="checkbox"/>	T300-CP00: Without switch cable
EMS58791	<input type="checkbox"/>	T300-CP03: 3 m MV switch motorization cable
EMS58792	<input type="checkbox"/>	T300-CP05: 5 m MV switch motorization cable
EMS58793	<input type="checkbox"/>	T300-CP10: 10 m MV switch motorization cable
EMS58794	<input type="checkbox"/>	T300-CP15: 15 m MV switch motorization cable

Note: These motorization cables are available only for Indoor controller cabinets

Voltage sensors and Voltage adapter accessories

Part No.	Qty.	Designation
Ethernet cable		
59660	<input type="checkbox"/>	CCA770 L-0.6 m: Voltage adapter RJ45 connection cable
59661	<input type="checkbox"/>	CCA772 L-2 m: Voltage adapter RJ45 connection cable
59662	<input type="checkbox"/>	CCA774 L-4 m: Voltage adapter RJ45 connection cable
LPVT sensors		
03816498N0	<input type="checkbox"/>	LPVT-24kV
VPIS V3 with Voltage Output		
VPI62613	<input type="checkbox"/>	VPIS-VO: VPI62613
VPI62614	<input type="checkbox"/>	VPIS-VO: VPI62614
VPI62615	<input type="checkbox"/>	VPIS-VO: VPI62615
VPI62616	<input type="checkbox"/>	VPIS-VO: VPI62616
VPI62617	<input type="checkbox"/>	VPIS-VO: VPI62617
VPI62618	<input type="checkbox"/>	VPIS-VO: VPI62618
VPI62619	<input type="checkbox"/>	VPIS-VO: VPI62619
PPACS sensors		
EMS58378	<input type="checkbox"/>	PPACS divider capacitor connector
EMS58381	<input type="checkbox"/>	PPACS cable 2 m
EMS58382	<input type="checkbox"/>	PPACS cable 3 m
EMS58383	<input type="checkbox"/>	PPACS cable 5 m
EMS58385	<input type="checkbox"/>	PPACS cable 10 m

Current sensors

Part No.	Qty.	Designation
MV Fault Passage Indicator sensors		
EMS58175	<input type="checkbox"/>	3 split core CT 500/1 class 3...47 mm (to be ordered with one of the CT cable below)
EMS58171	<input type="checkbox"/>	3 split core CT 500/1 class 3...47 mm + CT cable with screw connectors
EMS58111	<input type="checkbox"/>	1 split core balanced CT 500/1 class 3...120 mm + CT cable with screw connectors
EMS58183	<input type="checkbox"/>	3 split core CT 500/1 class 1...47 mm (to be ordered with one of the CT cable below)
EMS58182	<input type="checkbox"/>	3 split core CT 500/1 class 1...47 mm + CT cable with screw connectors
CT cable		
EMS58132	<input type="checkbox"/>	3 Phase cable - 3 meters
EMS58133	<input type="checkbox"/>	3 Phase cable - 5 meters
EMS58135	<input type="checkbox"/>	3 Phase cable - 10 meters
EMS58137	<input type="checkbox"/>	3 Phase cable - 15 meters

Outdoor indicator light indicator

Part No.	Qty.	Designation
59988	<input type="checkbox"/>	Outdoor Fault Passage Indicator light indicator

Communication accessories

Part No.	Qty.	Designation
Antenna		
EMS59160	<input type="checkbox"/>	Outdoor 3G/4G antenna connector type N 5m cable used with surge connector
EMS59162	<input type="checkbox"/>	Indoor 3G/4G antenna connector type SMA 5m cable direct connection to modem box
EMS59518	<input type="checkbox"/>	3G/4G surge connector for external antenna with cable for HU250 connection



TOOLS

www.se.com

This international web site allows you to access all the Schneider Electric solutions and product information via:

- Comprehensive descriptions
- Range datasheets
- A download area
- Product selectors

You can also access information dedicated to your business and contact your Schneider Electric country support.

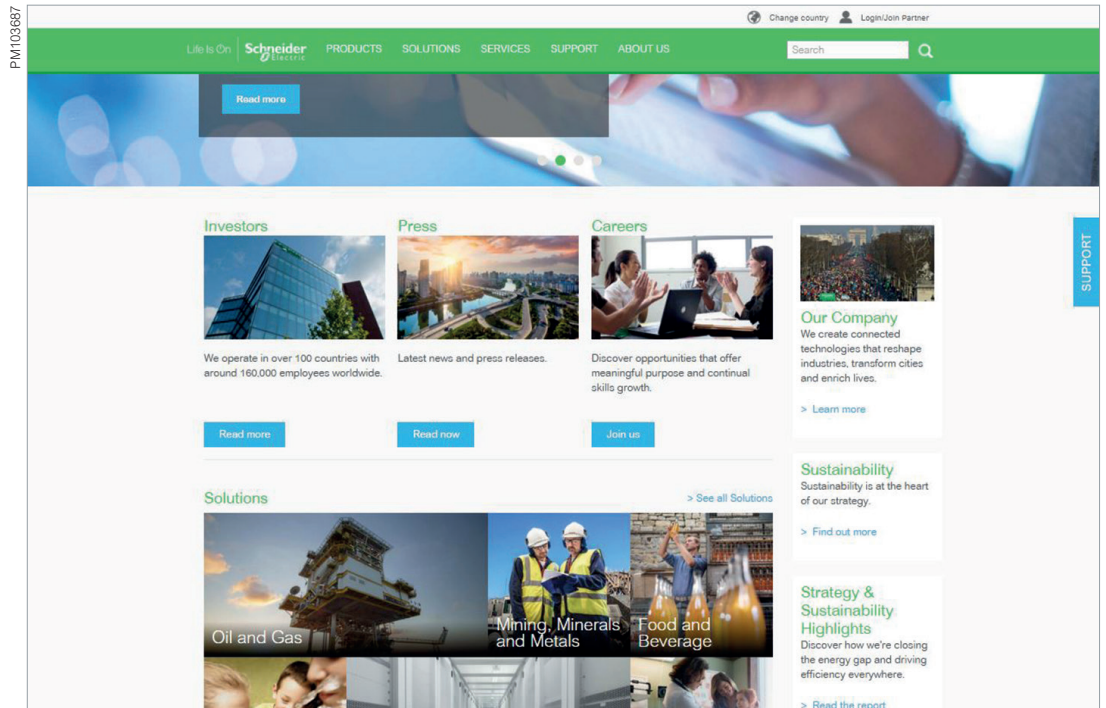



TOOLS

Web selector

This site allows you to access Schneider Electric products in just two clicks via a comprehensive range of datasheets, with direct links to:

- Complete libraries: technical documents, catalogs, FAQs, brochures
- Selection guides from the e-catalog
- Product discovery sites and their animations

You will also find illustrated overviews, news to which you can subscribe, and a list of country contacts

Training

Training allows you to acquire the expertise (installation design, working with power on, etc.) to increase efficiency and improve customer service.

The training catalog includes beginner's courses in electrical distribution, knowledge of MV and LV switchgear, operation and maintenance of installations, and design of LV installations, to give a few examples.



www.se.com

Schneider Electric Industries SAS
35, Rue Joseph Monier
CS 30323
92506 Rueil Malmaison Cedex
France

RCS Nanterre 954 503 439
Capital social 928 298 512 €
www.se.com

May 2024
PowerLogic™ T300
NRJED314621EN

As standards, specifications and designs develop from time to time, please ask for confirmation of the information given in this document.

© 2024 - Schneider Electric. All rights reserved.
All trademarks are owned by Schneider Electric Industries SAS or its affiliated companies.

Over 75 % of Schneider Electric products have been awarded the Green Premium ecolabel.

