

**⚠ ⚠ DANGER**

**HAZARD OF ELECTRIC SHOCK, EXPLOSION, OR ARC FLASH**

- Only appropriately trained persons who are familiar with and understand the contents of this manual and all other pertinent product documentation and who have received safety training to recognize and avoid hazards involved are authorized to work on and with this drive system. Installation, adjustment, repair and maintenance must be performed by qualified personnel.
- The system integrator is responsible for compliance with all local and national electrical code requirements as well as all other applicable regulations with respect to grounding of all equipment.
- Many components of the product, including the printed circuit boards, operate with mains voltage.
- Only use properly rated, electrically insulated tools and measuring equipment.
- Do not touch unshielded components or terminals with voltage present.
- Motors can generate voltage when the shaft is rotated. Prior to performing any type of work on the drive system, block the motor shaft to prevent rotation.
- AC voltage can couple voltage to unused conductors in the motor cable. Insulate both ends of unused conductors of the motor cable.
- Do not short across the DC bus terminals or the DC bus capacitors or the braking resistor terminals.
- Before performing work on the drive system:
  - Disconnect all power, including external control power that may be present.
  - Take into account that the circuit breaker or main switch does not de-energize all circuits.
  - Place a "Do Not Turn On" label on all power switches related to the drive system.
  - Lock all power switches in the open position.
  - Wait 15 minutes to allow the DC bus capacitors to discharge.
  - Follow the instructions given in the chapter "Verifying the Absence of Voltage" in the installation manual of the product.
- Before applying voltage to the drive system:
  - Verify that the work has been completed and that the entire installation cannot cause hazards.
  - If the mains input terminals and the motor output terminals have been grounded and short-circuited, remove the ground and the short circuits on the mains input terminals and the motor output terminals.
  - Verify proper grounding of all equipment.
  - Verify that all protective equipment such as covers, doors, grids is installed and/or closed.

**Failure to follow these instructions will result in death or serious injury.**

Electrical equipment should be installed, operated, serviced, and maintained only by qualified personnel. No responsibility is assumed by Schneider Electric for any consequences arising out of the use of this product.

© 2017 Schneider Electric. All Rights Reserved.

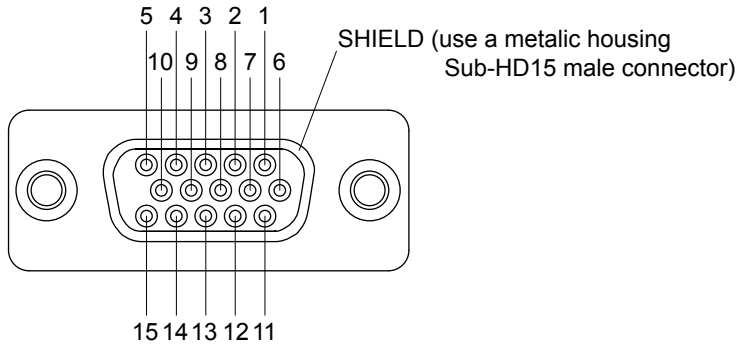

PIN	SIGNAL	FUNCTION	ELECTRICAL CHARACTERISTICS
1	DATA_A+	Data channel A	RS422 / RS485, Rin 121 Ω, 12 Mbit/s max.
2	DATA_A-		
3	ENC+24V_OUT	Encoder Supply 24Vdc	+24Vdc / 100mA
4	DATA_I+	Data channel I	RS422 / RS485, Rin 121 Ω, 12 Mbit/s max.
5	DATA_I-		
6	CLK+	Clock Signal	
7	ENC+12V_OUT	Encoder Supply 12Vdc	+12Vdc / 100mA
8	ENC_0V	Reference potential for encoder supply	-
9	NC	-	-
10	DATA_B+	Data channel B	RS422 / RS485, Rin 121 Ω, 12 Mbit/s max.
11	DATA_B-		
12	TEMP_SENSE+	Temperature Sensor +	Supported sensor: PTC, PT100, PT1000, KTY84, Klixon
13	TEMP_SENSE-	Temperature Sensor -	
14	CLK-	Clock Signal	RS422 / RS485, Rin 121 Ω, 12 Mbit/s max.
15	ENC+5V_OUT	Encoder Supply 5Vdc	+5Vdc / 250mA
SHIELD		Overall cable shielding for signal lines	The shield is connected in the connector via the metallic housing

PIN	TWISTED WIRE PAIR	ABI	SSI	EnDat 2.2	Input/Output
1	1	R	R	R	I**
2					
3	5*	-	-	-	O
4					
5	3	Opt.	-	-	I
6					
7	4	-	R	R	O
8					
9	5*	R	R	R	-
10					
11	-	-	-	-	-
12					
13	2	R	-	-	I
14					
15	6	Opt.	Opt.	Opt.	I
16					
17	4	-	R	R	O
18					
19	5*	-	-	-	O
20					
SHIELD		R	R	R	-

\*: Wired depending on selected supply voltage  
 \*\*: I/O for EnDat 2.2  
 R: Required  
 -: Not required  
 Opt.: Optional

Suggested cable:  
VW3M8221R1000

See *En* - Menu  
in the Programming Manual



1



# ATV900 ATV340 Mounting

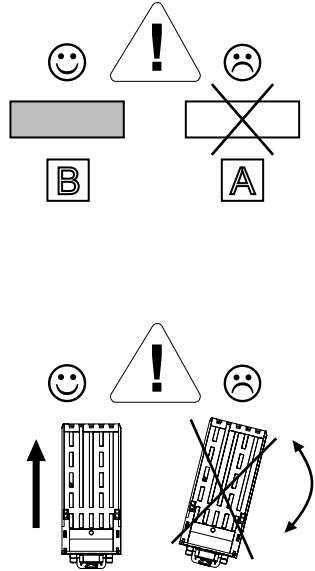
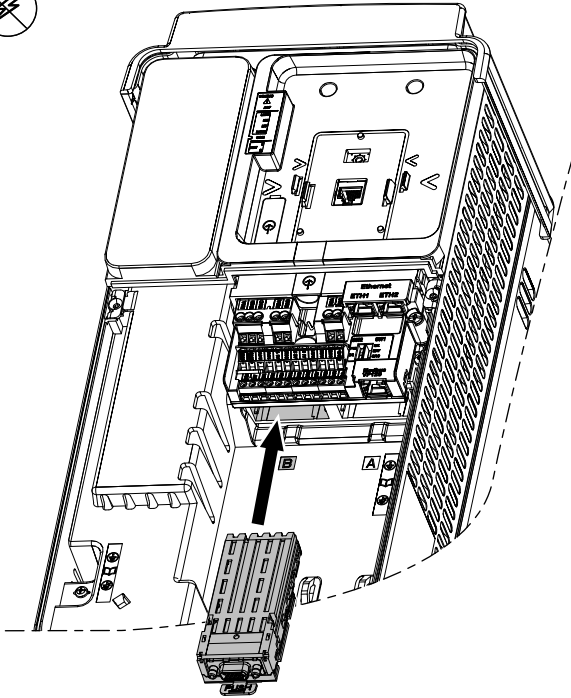

2

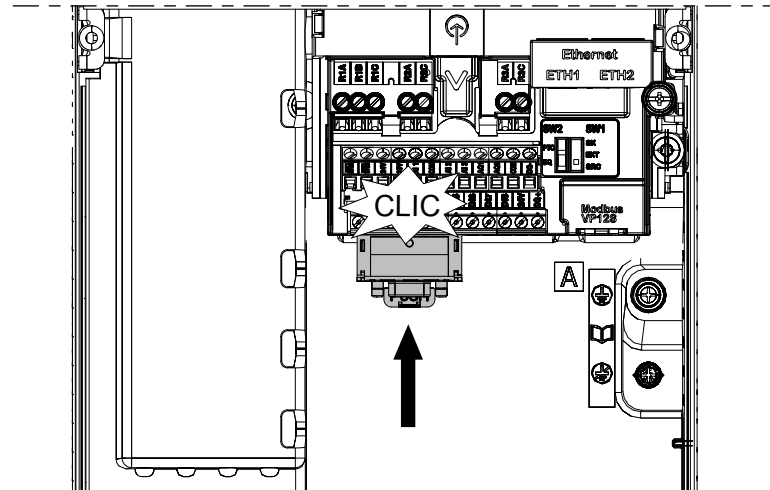

1

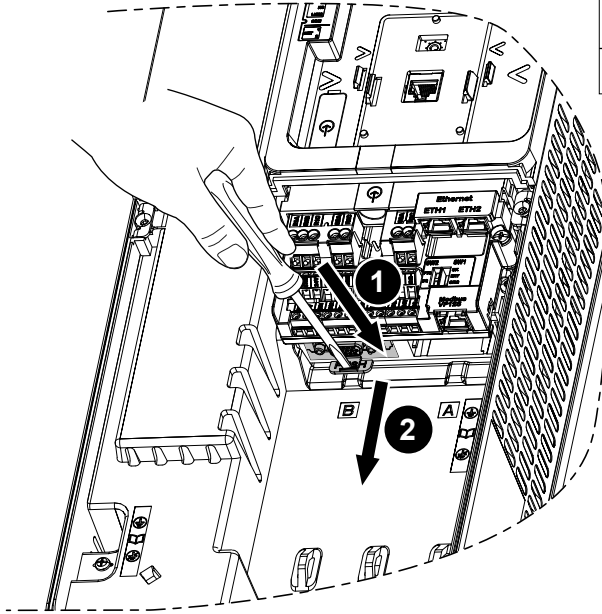

# ATV900 ATV340 Removing

2

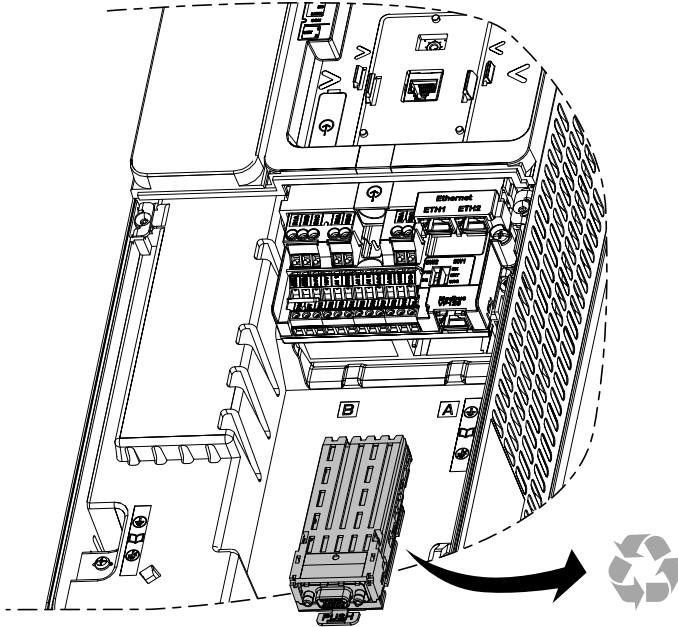

1 

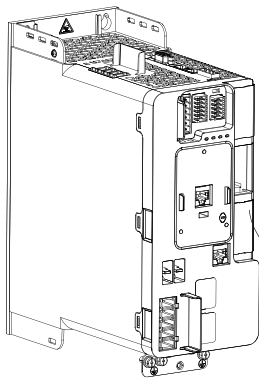

GP-SF

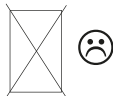

GP-ENC 

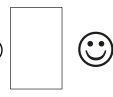

GP-FB 

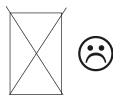

# ATV340

## Mounting

2 

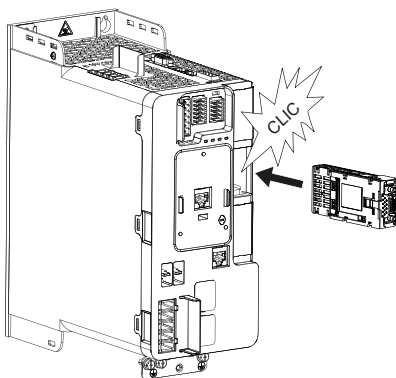
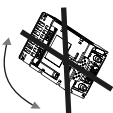

3 

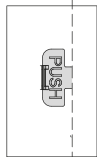
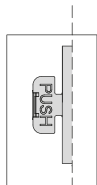

## Removing

1 

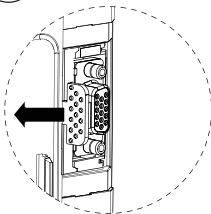

2 

