

# VigiPacT RMH

Earth-leakage monitor

Moniteur de courant de fuite à la terre

Ableitstrommonitor

Dispositivo di controllo della dispersione a terra

Dispositivo de control del diferencial







Monitor de fuga à terra

Монитор тока утечки

接地漏电监控器

- EN** Installation manual
- FR** Notice d'installation
- DE** Montageanleitung
- IT** Manuale d'installazione
- ES** Instrucciones de instalación
- PT** Manual de instalação
- RU** Руководство по установке
- ZH** 安装手册



	<a href="http://www.se.com">www.se.com</a>
	VigiPacT RMH User Guide
	DOCA0108EN
	DOCA0108FR
	DOCA0108ES
	DOCA0108ZH
	VigiPacT Catalogue
	LVPED208009EN_WEB

# Safety instructions / Consignes de sécurité / Sicherheitshinweise / Informazioni di sicurezza / Información de seguridad / Instruções de segurança / Указания по безопасности / 安全说明

<p><b>PLEASE NOTE</b></p> <ul style="list-style-type: none"> <li>■ Electrical equipment should be installed, operated, serviced, and maintained only by qualified personnel.</li> <li>■ No responsibility is assumed by Schneider Electric for any consequences arising out of the use of this material.</li> </ul>	<p><b>REMARQUE IMPORTANTE</b></p> <ul style="list-style-type: none"> <li>■ L'installation, l'utilisation, la réparation et la maintenance des équipements électriques doivent être assurées par du personnel qualifié uniquement.</li> <li>■ Schneider Electric décline toute responsabilité quant aux conséquences de l'utilisation de ce matériel.</li> </ul>	<p><b>BITTE BEACHTEN</b></p> <ul style="list-style-type: none"> <li>■ Elektrische Geräte dürfen nur von Fachpersonal installiert, betrieben, bedient und gewartet werden.</li> <li>■ Schneider Electric haftet nicht für Schäden, die durch die Verwendung dieses Materials entstehen.</li> </ul>	<p><b>NOTA</b></p> <ul style="list-style-type: none"> <li>■ Manutenzione, riparazione, installazione e uso delle apparecchiature elettriche si devono affidare solo a personale qualificato.</li> <li>■ Schneider Electric non si assume alcuna responsabilità per qualsiasi conseguenza derivante dall'uso di questi prodotti.</li> </ul>
---------------------------------------------------------------------------------------------------------------------------------------------------------------------------------------------------------------------------------------------------------------------------------------------------------------------	-----------------------------------------------------------------------------------------------------------------------------------------------------------------------------------------------------------------------------------------------------------------------------------------------------------------------------------------------------------------	---------------------------------------------------------------------------------------------------------------------------------------------------------------------------------------------------------------------------------------------------------------------------------------------------	--------------------------------------------------------------------------------------------------------------------------------------------------------------------------------------------------------------------------------------------------------------------------------------------------------------------------------------------

## **DANGER / DANGER / GEFAHR / PERICOLO**

<p><b>HAZARD OF ELECTRIC SHOCK, EXPLOSION OR ARC FLASH</b></p> <ul style="list-style-type: none"> <li>■ Apply appropriate personal protective equipment (PPE) and follow safe electrical work practices. See NFPA 70E, CSA Z462 or local equivalent.</li> <li>■ This equipment must only be installed and serviced by qualified electrical personnel.</li> <li>■ Turn off all power supplying this equipment before working on or inside equipment. Lock the switchgear in the isolated position.</li> <li>■ Always use a properly rated voltage sensing device to confirm power is off.</li> <li>■ Install safety barriers and display a danger sign.</li> <li>■ Replace all devices, doors, and covers before turning on power to this equipment.</li> </ul> <p><b>Failure to follow these instructions will result in death or serious injury.</b></p>	<p><b>RISQUE D'ÉLECTROCUTION, D'EXPLOSION OU D'ECLAIR D'ARC ELECTRIQUE</b></p> <ul style="list-style-type: none"> <li>■ Portez un équipement de protection personnelle adapté et respectez les consignes de sécurité électrique courantes. Reportez-vous aux normes NFPA 70E, CSA Z462 ou aux textes équivalents applicables dans votre région du monde.</li> <li>■ Seul un personnel qualifié doit effectuer l'installation et l'entretien de cet appareil.</li> <li>■ Débranchez toutes les sources d'alimentation de cet équipement avant d'effectuer toute opération interne ou externe sur celui-ci. Verrouillez l'appareillage en position isolée.</li> <li>■ Utilisez toujours un dispositif de détection de tension ayant une valeur nominale appropriée pour vous assurer que l'alimentation est coupée.</li> <li>■ Installez des barrières de sécurité et affichez un signal de danger.</li> <li>■ Remettez en place tous les équipements, les portes et les capots avant de remettre l'appareil sous tension.</li> </ul> <p><b>Si ces directives ne sont pas respectées, cela entraînera la mort ou des blessures graves.</b></p>	<p><b>GEFAHR VON ELEKTRISCHEM SCHLAG, EXPLOSION ODER LICHTBOGEN</b></p> <ul style="list-style-type: none"> <li>■ Tragen Sie persönliche Schutzausrüstung (PSA) und befolgen Sie sichere Verfahren im Umgang mit Elektrogeräten. Siehe NFPA 70E, CSA Z462 oder lokale Entsprechung.</li> <li>■ Diese Geräte dürfen nur von qualifizierten Elektrikern installiert und gewartet werden.</li> <li>■ Schalten Sie vor Arbeiten am bzw. im Innern des Geräts die gesamte Spannungsversorgung ab. Die Schaltanlage in die Trennstellung bringen.</li> <li>■ Verwenden Sie für die Prüfung vorhandener Spannung stets einen Spannungsfühler mit zutreffender Bemessungsspannung.</li> <li>■ Bringen Sie Sicherheitsbarrieren und einen Warnhinweis an.</li> <li>■ Bringen Sie alle Vorrichtungen, Türen und Abdeckungen wieder an, bevor Sie das Gerät einschalten.</li> </ul> <p><b>Die Nichtbeachtung dieser Anweisungen führt zu Tod oder schweren Verletzungen.</b></p>	<p><b>RISCHIO DI FOLGORAZIONE, ESPLOSIONE O BAGLIORI DA ARCO</b></p> <ul style="list-style-type: none"> <li>■ Utilizzare dispositivi di protezione individuale (DPI) idonei e adottare misure di sicurezza adeguate per lavori elettrici. Vedere le normative NFPA 70E, CSA Z462 o le norme equivalenti nel paese di installazione.</li> <li>■ Installazione e manutenzione di questa apparecchiatura si devono affidare solo ad elettricisti qualificati.</li> <li>■ Prima di lavorare con l'apparecchiatura o al suo interno isolare completamente l'alimentazione elettrica. Bloccare l'interruttore in posizione isolata.</li> <li>■ Per verificare che l'alimentazione sia isolata usare sempre un rivelatore di tensione correttamente tarato.</li> <li>■ Installare barriere di sicurezza e apporre un segnale di pericolo.</li> <li>■ Sostituire dispositivi, sportelli e coperture prima di riaccendere l'alimentazione dell'apparecchiatura.</li> </ul> <p><b>Il mancato rispetto di queste istruzioni provocherà morte o gravi infortuni.</b></p>
-----------------------------------------------------------------------------------------------------------------------------------------------------------------------------------------------------------------------------------------------------------------------------------------------------------------------------------------------------------------------------------------------------------------------------------------------------------------------------------------------------------------------------------------------------------------------------------------------------------------------------------------------------------------------------------------------------------------------------------------------------------------------------------------------------------------------------------------------------------	----------------------------------------------------------------------------------------------------------------------------------------------------------------------------------------------------------------------------------------------------------------------------------------------------------------------------------------------------------------------------------------------------------------------------------------------------------------------------------------------------------------------------------------------------------------------------------------------------------------------------------------------------------------------------------------------------------------------------------------------------------------------------------------------------------------------------------------------------------------------------------------------------------------------------------------------------------------------------------------------------------------------------------------------------------------------------------------------------------------------------------------------	----------------------------------------------------------------------------------------------------------------------------------------------------------------------------------------------------------------------------------------------------------------------------------------------------------------------------------------------------------------------------------------------------------------------------------------------------------------------------------------------------------------------------------------------------------------------------------------------------------------------------------------------------------------------------------------------------------------------------------------------------------------------------------------------------------------------------------------------------------------------------------------------------------------------------------------------------------------------	--------------------------------------------------------------------------------------------------------------------------------------------------------------------------------------------------------------------------------------------------------------------------------------------------------------------------------------------------------------------------------------------------------------------------------------------------------------------------------------------------------------------------------------------------------------------------------------------------------------------------------------------------------------------------------------------------------------------------------------------------------------------------------------------------------------------------------------------------------------------------------------------------------------------------------------------------------------------------------------------------------------------------------------------------------------

**Safety instructions / Consignes de sécurité / Sicherheitshinweise / Informazioni di sicurezza / Información de seguridad / Instruções de segurança / Указания по безопасности / 安全说明**

<p><b>TENGA EN CUENTA</b></p> <ul style="list-style-type: none"> <li>■ La instalación, manejo, puesta en servicio y mantenimiento de equipos eléctricos deberán ser realizados sólo por personal cualificado.</li> <li>■ Schneider Electric no se hace responsable de ninguna de las consecuencias del uso de este material.</li> </ul>	<p><b>NOTA</b></p> <ul style="list-style-type: none"> <li>■ A instalação, utilização e manutenção do equipamento eléctrico devem ser efectuadas exclusivamente por pessoal qualificado.</li> <li>■ A Schneider Electric não assume qualquer responsabilidade pelas consequências resultantes da utilização deste material.</li> </ul>	<p><b>ОБРАТИТЕ ВНИМАНИЕ</b></p> <ul style="list-style-type: none"> <li>■ Установка, эксплуатация, ремонт и обслуживание электрического оборудования может выполняться только квалифицированными электриками.</li> <li>■ Компания Schneider Electric не несет никакой ответственности за любые возможные последствия использования данной</li> </ul>	<p><b>请注意</b></p> <ul style="list-style-type: none"> <li>■ 电气设备的安装、操作、维修和维护工作仅限于合格人员执行。</li> <li>■ Schneider Electric 不承担由于使用本资料所引起的任何后果。</li> </ul>
-----------------------------------------------------------------------------------------------------------------------------------------------------------------------------------------------------------------------------------------------------------------------------------------------------------------------------------------	---------------------------------------------------------------------------------------------------------------------------------------------------------------------------------------------------------------------------------------------------------------------------------------------------------------------------------------	-----------------------------------------------------------------------------------------------------------------------------------------------------------------------------------------------------------------------------------------------------------------------------------------------------------------------------------------------------	------------------------------------------------------------------------------------------------------------------------------------------------------

<p><b>⚠ ⚠ PELIGRO / PERIGO / ОПАСНОСТЬ / 危險</b></p>			
<p><b>PELIGRO DE DESCARGA ELÉCTRICA, EXPLOSIÓN O ARCO ELÉCTRICO</b></p> <ul style="list-style-type: none"> <li>■ Utilice el equipo de protección personal (PPE) adecuado y siga las recomendaciones para el trabajo seguro con dispositivos eléctricos. Consulte NFPA 70E, CSA Z462 o la norma local equivalente.</li> <li>■ Solo el personal de electricidad cualificado podrá instalar, programar y realizar el mantenimiento del equipo.</li> <li>■ Desconecte toda la alimentación de este equipo antes de trabajar en él o en su interior. Bloquee la aparatenta eléctrica en la posición de aislamiento.</li> <li>■ Utilice siempre un dispositivo de detección de tensión de capacidad adecuada para confirmar la ausencia de alimentación eléctrica.</li> <li>■ Instale barreras de seguridad y coloque un cartel de peligro.</li> <li>■ Vuelva a colocar todos los dispositivos, las puertas y las tapas antes de conectar la alimentación de este equipo.</li> </ul> <p><b>El incumplimiento de estas instrucciones podrá causar la muerte o lesiones serias.</b></p>	<p><b>PERIGO DE CHOQUE ELÉCTRICO, EXPLOÇÃO OU ARCO ELÉCTRICO</b></p> <ul style="list-style-type: none"> <li>■ Utilize equipamento de protecção pessoal (PPE) e siga os métodos de segurança eléctrica. Consulte NFPA 70E, CSA Z462 ou o equivalente local.</li> <li>■ A instalação e manutenção deste equipamento só devem ser efectuadas por electricistas qualificados.</li> <li>■ Desligue todas as fontes de alimentação deste equipamento antes de trabalhar no equipamento ou no seu interior. Bloquee a placa de distribuição na posição isolada.</li> <li>■ Utilize sempre um dispositivo de detecção da tensão nominal adequada para confirmar se a alimentação está desligada.</li> <li>■ Instale barreiras de segurança e apresente um sinal de perigo.</li> <li>■ Substitua todos os dispositivos, portas e tampas antes de ligar a alimentação deste equipamento.</li> </ul> <p><b>A não observância destas instruções resultará em morte, ou ferimentos graves.</b></p>	<p><b>ОПАСНОСТЬ ВЗРЫВА, ВСПЫШКИ ДУГИ ИЛИ ПОРАЖЕНИЯ ЭЛЕКТРИЧЕСКИМ ТОКОМ</b></p> <ul style="list-style-type: none"> <li>■ Используйте подходящие средства индивидуальной защиты (СИЗ) и соблюдайте технику безопасности при электротехнических работах. См. NFPA 70E, CSA Z462 или эквивалентные местные требования.</li> <li>■ Это оборудование могут устанавливать и обслуживать только квалифицированные электрики.</li> <li>■ Отключите питание до начала работ снаружи или внутри данного оборудования.</li> <li>■ Всегда убеждайтесь в том, что питание отключено, с помощью устройства измерения напряжения соответствующего диапазона.</li> <li>■ Установите защитные ограждения и предупреждающий знак.</li> <li>■ Перед включением питания данного оборудования установите на место все устройства, дверцы и крышки.</li> </ul> <p><b>Несоблюдение этих инструкций приведет к смерти или серьезной травме.</b></p>	<p><b>电击、爆炸或电弧闪光危险</b></p> <ul style="list-style-type: none"> <li>■ 采用适当的个人防护设备 (PPE) 并遵循电气作业安全守则。请参阅 NFPA 70E, CSA Z462 或当地对应的标准。</li> <li>■ 只有具备相应资质的电气人员才能安装和维修该设备。</li> <li>■ 在该设备表面或内部工作之前, 请关闭设备的全部电源。将开关锁定在隔离位置。</li> <li>■ 确保使用合适的额定电压传感器确认电源已关闭。</li> <li>■ 安装安全栅并显示危险标志。</li> <li>■ 在给设备供电之前, 更换所有的设备, 门框, 盖板。</li> </ul> <p><b>不遵循上述说明将导致人员伤亡。</b></p>

Package contents / Contenu du coffret / Packungsinhalt / Contenuto della confezione /  
Contenido del paquete / Conteúdo da embalagem / Содержимое упаковки / 包装一览

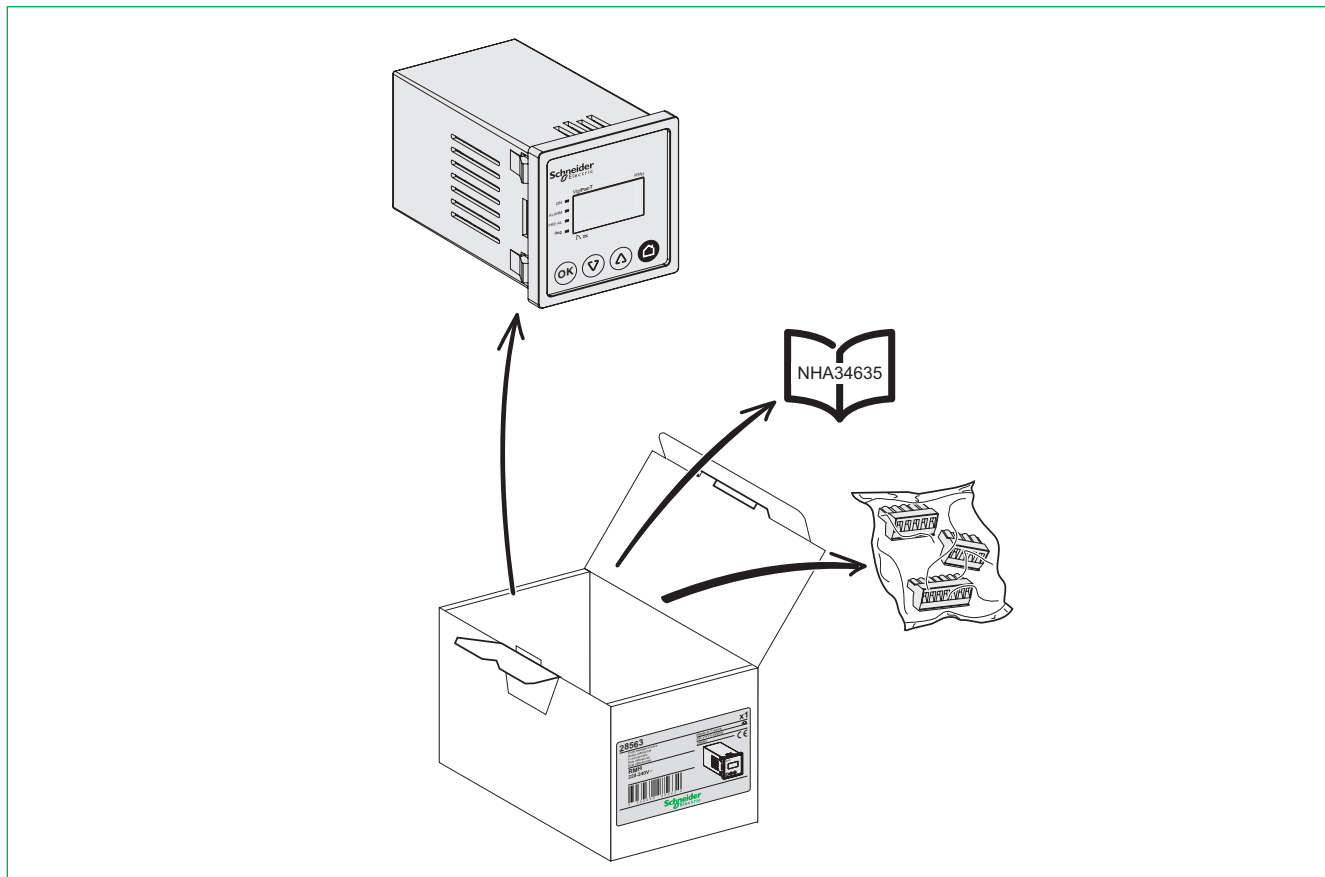

**Manufacturing date / Date de fabrication / Herstellungsdatum / Data di fabbricazione / Fecha de fabricación / Data de fabrico / Дата производства / 制造日期**

<p>The product's manufacture date is coded PP-YYYY-Www-D, where:</p> <ul style="list-style-type: none"> <li>■ PP: plant code</li> <li>■ YYYY: year of manufacture</li> <li>■ Www: week of manufacture</li> <li>■ D: weekday of manufacture (Monday = 1)</li> </ul> <p>Eg: 7Q-2014-W19-3 = product manufactured at plant 7Q on Wednesday 7 May 2014.</p>	<p>La date de fabrication du produit est codée PP-YYYY-Www-D, avec:</p> <ul style="list-style-type: none"> <li>■ PP: code usine</li> <li>■ YYYY: année de fabrication</li> <li>■ Www: semaine de fabrication</li> <li>■ D: jour de fabrication dans la semaine (lundi = 1)</li> </ul> <p>Ex: 7Q-2014-W19-3 = produit fabriqué le mercredi 7 mai 2014 par l'usine 7Q.</p>	<p>Das Herstellungsdatum des Produkts ist folgendermaßen codiert: PP-YYYY-Www-D. Wobei:</p> <ul style="list-style-type: none"> <li>■ PP: Werkscode</li> <li>■ YYYY: Herstellungsjahr</li> <li>■ Www: Herstellungswoche</li> <li>■ D: Herstellungstag (Montag = 1)</li> </ul> <p>Z. B: 7Q-2014-W19-3 = ein Produkt, das in Werk 7Q, am Mittwoch den 7. Mai, im Jahr 2014 gefertigt wurde.</p>	<p>La data di fabbricazione del prodotto è indicata con il codice PP-YYYY-Www-D, dove:</p> <ul style="list-style-type: none"> <li>■ PP: codice stabilimento</li> <li>■ YYYY: anno di fabbricazione</li> <li>■ Www: settimana di fabbricazione</li> <li>■ D: giorno della settimana in cui il prodotto è stato fabbricato (lunedì = 1)</li> </ul> <p>Ad es: 7Q-2014-W19-3 = prodotto fabbricato presso lo stabilimento 7Q mercoledì 7 maggio 2014.</p>
<p>La fecha de fabricación del producto está codificada PP-YYYY-Www-D, donde:</p> <ul style="list-style-type: none"> <li>■ PP: código de la planta</li> <li>■ YYYY: año de fabricación</li> <li>■ Www: semana de fabricación</li> <li>■ D: día de la semana de fabricación (lunes = 1)</li> </ul> <p>Ej: 7Q-2014-W19-3 = producto fabricado en la planta 7Q el miércoles 7 de mayo de 2014.</p>	<p>A data de fabrico do produto está sob a forma de código PP-YYYY-Www-D, onde:</p> <ul style="list-style-type: none"> <li>■ PP: código da fábrica</li> <li>■ YYYY: ano de fabrico</li> <li>■ Www: semana de fabrico</li> <li>■ D: dia da semana de fabrico (Segunda-feira = 1)</li> </ul> <p>Ex: 7Q-2014-W19-3 = produto fabricado na fábrica 7Q na Quarta-feira 7 de Maio de 2014.</p>	<p>Дата производства продукта закодирована в формате PP-YYYY-Www-D, где:</p> <ul style="list-style-type: none"> <li>■ PP: код завода</li> <li>■ YYYY: год производства</li> <li>■ Www: неделя производства</li> <li>■ D: день недели, когда был произведен продукт (понедельник = 1)</li> </ul> <p>Пример: 7Q-2014-W19-3 = продукт произведен на заводе 7Q в среду, 7 мая 2014 года.</p>	<p>产品制造日期采用如下代码 PP-YYYY-Www-D, 其中:</p> <ul style="list-style-type: none"> <li>■ PP: 工厂代码</li> <li>■ YYYY: 制造年份</li> <li>■ Www: 第几周制造</li> <li>■ D: 星期几制造 (星期一 = 1)</li> </ul> <p>例如: 7Q-2014-W19-3 = 产品于 2014 年 5 月 7 日星期三 在 7Q 工厂制造。</p>

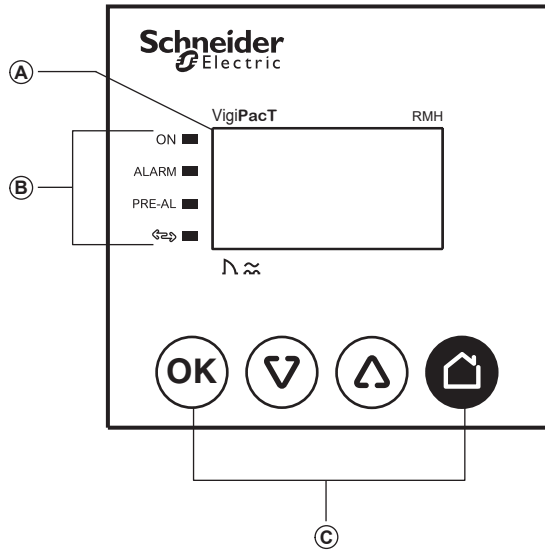

- (EN)** A Display  
 B Status LEDs: On, Alarm, Pre-Alarm, Com  
 C Navigation / Setting buttons
- (FR)** A Affichage  
 B Voyants d'état: En service, Alarme, Préalarme, Communication  
 C Boutons de navigation et de paramétrage
- (DE)** A Anzeige  
 B Status-LEDs: On (Ein), Alarm, Pre-Alarm (Voralarm), Com (Kommunikation)  
 C Navigations-/Einstelltasten
- (IT)** A Display  
 B LED di stato: On, Alarm, Pre-Alarm, Com  
 C Pulsanti di navigazione/impostazione
- (ES)** A Pantalla  
 B LED de estado: Encendido, Alarma, Prealarma, Com  
 C Botones de navegación/ajustes
- (PT)** A Visor  
 B LED de estado: Ligado, Alarma, Pré-alarma, Com  
 C Botões de navegação/definição
- (RU)** A Дисплей  
 B Светодиодные индикаторы состояния: Вкл, Тревога, Предварительная тревога, Com  
 C Кнопки Навигация/Настройки
- (ZH)** A 显示屏  
 B 状态 LED: 开启、报警、预警、通讯  
 C 导航/设置按钮

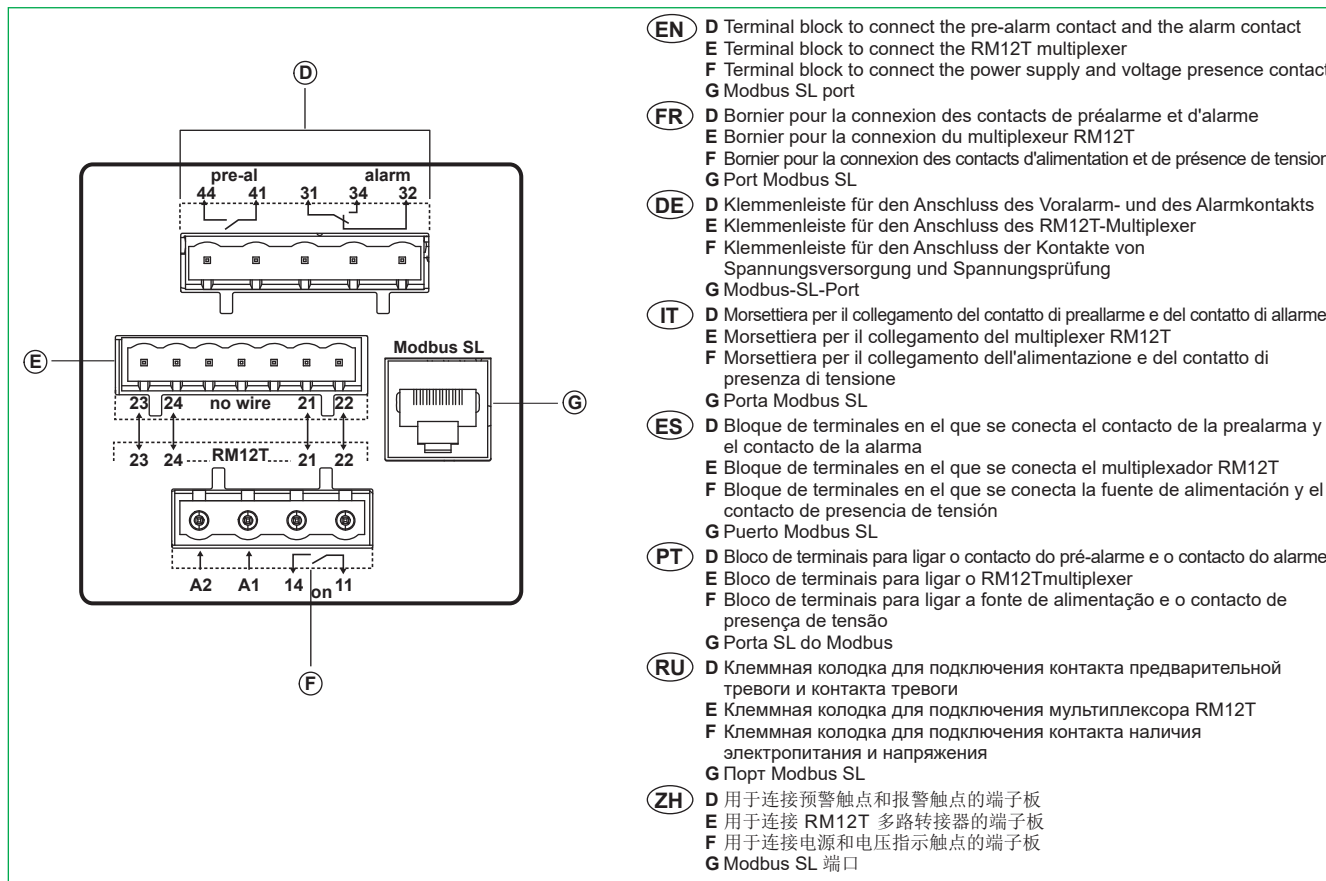

- (EN)** D Terminal block to connect the pre-alarm contact and the alarm contact  
E Terminal block to connect the RM12T multiplexer  
F Terminal block to connect the power supply and voltage presence contact  
G Modbus SL port
- (FR)** D Bornier pour la connexion des contacts de préalarme et d'alarme  
E Bornier pour la connexion du multiplexeur RM12T  
F Bornier pour la connexion des contacts d'alimentation et de présence de tension  
G Port Modbus SL
- (DE)** D Klemmenleiste für den Anschluss des Voralarm- und des Alarmkontakts  
E Klemmenleiste für den Anschluss des RM12T-Multiplexer  
F Klemmenleiste für den Anschluss der Kontakte von Spannungsversorgung und Spannungsprüfung  
G Modbus-SL-Port
- (IT)** D Morsettiere per il collegamento del contatto di preallarme e del contatto di allarme  
E Morsettiere per il collegamento del multiplexeur RM12T  
F Morsettiere per il collegamento dell'alimentazione e del contatto di presenza di tensione  
G Porta Modbus SL
- (ES)** D Bloque de terminales en el que se conecta el contacto de la prealarma y el contacto de la alarma  
E Bloque de terminales en el que se conecta el multiplexador RM12T  
F Bloque de terminales en el que se conecta la fuente de alimentación y el contacto de presencia de tensión  
G Puerto Modbus SL
- (PT)** D Bloco de terminais para ligar o contacto do pré-alarma e o contacto do alarme  
E Bloco de terminais para ligar o RM12Tmultiplexeur  
F Bloco de terminais para ligar a fonte de alimentação e o contacto de presença de tensão  
G Porta SL do Modbus
- (RU)** D Клеммная колодка для подключения контакта предварительной тревоги и контакта тревоги  
E Клеммная колодка для подключения мультиплексора RM12T  
F Клеммная колодка для подключения контакта наличия электропитания и напряжения  
G Порт Modbus SL
- (ZH)** D 用于连接预警触点和报警触点的端子板  
E 用于连接 RM12T 多路转接器的端子板  
F 用于连接电源和电压指示触点的端子板  
G Modbus SL 端口

DB125381

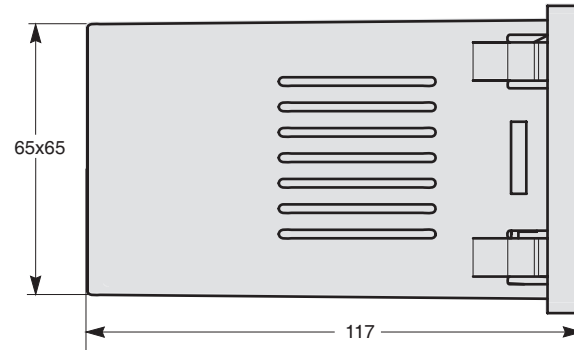
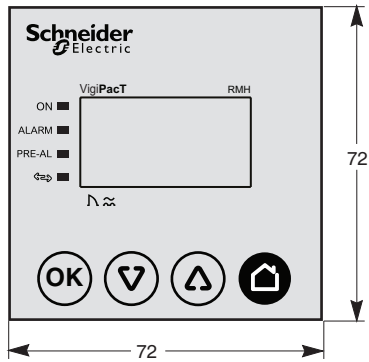

- (EN)** Clearance around the device
- (FR)** Dégagement autour de l'appareil
- (DE)** Abstand um das Gerät
- (IT)** Spazio libero attorno al dispositivo
- (ES)** Espacio libre alrededor del dispositivo
- (PT)** Espaço à volta do dispositivo
- (RU)** Зазор вокруг прибора
- (ZH)** 设备四周的间距

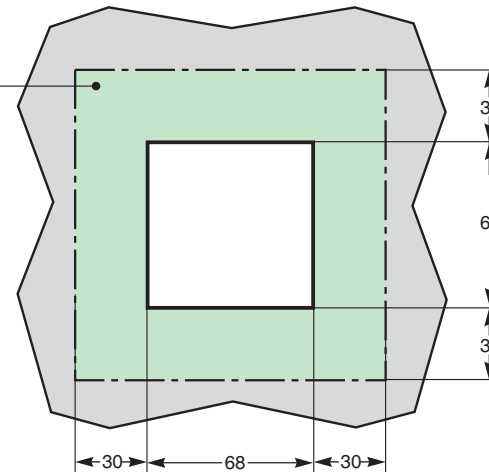



DB124924

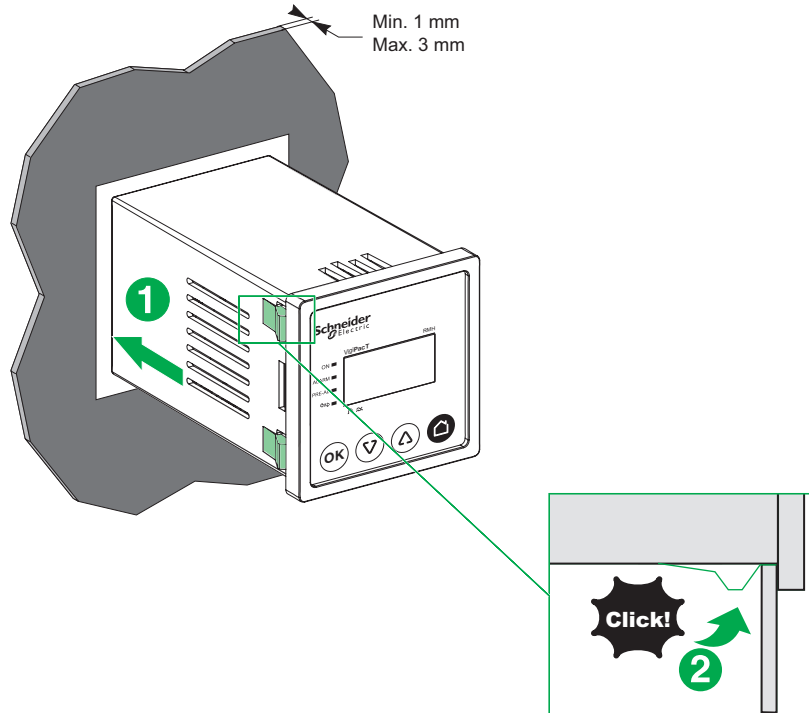

**▲ WARNING / AVERTISSEMENT / WARNUNG / AVVERTIMENTO / ADVERTENCIA / ATENÇÃO /  
ПРЕДУПРЕЖДЕНИЕ / 警告**

<p><b>HAZARD OF ELECTRIC SHOCK</b></p> <ul style="list-style-type: none"> <li>■ The VigiPacT RMH relay must be used solely as a monitoring relay. Do not use it as a protection relay for the safety of people and equipment.</li> <li>■ The terminal blocks behind the VigiPacT RMH may have dangerous voltages. Do not touch these terminal blocks when the VigiPacT RMH is powered up.</li> </ul> <p><b>Failure to follow these instructions can result in death, serious injury, or equipment damage.</b></p>	<p><b>RISQUE D'ELECTROCUTION</b></p> <ul style="list-style-type: none"> <li>■ Le relais VigiPacT RMH doit être utilisé uniquement comme un relais de signalisation. Ne l'utilisez pas comme un relais de protection pour les personnes et les équipements.</li> <li>■ Les borniers présents à l'arrière du VigiPacT RMH peuvent avoir des tensions dangereuses. Ne pas toucher ces borniers lorsque le VigiPacT RMH est sous tension.</li> </ul> <p><b>Si ces directives ne sont pas respectées, cela peut entraîner la mort ou des blessures graves ou des dommages matériels.</b></p>	<p><b>GEFAHR EINES ELEKTRISCHEN SCHLAGS</b></p> <ul style="list-style-type: none"> <li>■ Das Relais VigiPacT RMH darf ausschließlich zur Überwachung eingesetzt werden. Verwenden Sie es keinesfalls als Sicherheitsrelais zum Schutz von Personen und Geräten.</li> <li>■ An den Klemmleisten hinter dem VigiPacT RMH ist möglicherweise eine gefährliche Spannung vorhanden. Berühren Sie diese Klemmleisten nicht, wenn das VigiPacT RMH eingeschaltet ist.</li> </ul> <p><b>Die Nichtbeachtung dieser Anweisungen kann Tod, schwere Verletzungen oder Sachschäden zur Folge haben.</b></p>	<p><b>RISCHIO DI SHOCK ELETTRICO</b></p> <ul style="list-style-type: none"> <li>■ Il relè VigiPacT RMH deve essere utilizzato esclusivamente come relè di monitoraggio. Non utilizzarlo come relè di protezione ai fini della sicurezza di persone e apparecchiature.</li> <li>■ Le morsettiere dietro il VigiPacT RMH possono presentare tensioni pericolose. Non toccare le morsettiere quando il VigiPacT RMH è alimentato.</li> </ul> <p><b>Il mancato rispetto di queste istruzioni può provocare morte, gravi infortuni o danni alle apparecchiature.</b></p>
<p><b>PELIGRO DE DESCARGA ELÉCTRICA</b></p> <ul style="list-style-type: none"> <li>■ El relé VigiPacT RMH solo debe utilizarse como un relé de monitorización. No lo utilice como un relé de protección para la seguridad de la gente y del equipo.</li> <li>■ Los borneros de la parte posterior de VigiPacT RMH pueden tener tensiones peligrosas. No toque estos borneros cuando VigiPacT RMH esté encendido.</li> </ul> <p><b>El incumplimiento de estas instrucciones puede causar la muerte, lesiones serias o daño al equipo.</b></p>	<p><b>RISCO DE CHOQUE ELÉCTRICO</b></p> <ul style="list-style-type: none"> <li>■ O relé VigiPacT RMH deve ser utilizado apenas como relé de sinalização. Não o utilize como relé de proteção para as pessoas e equipamento.</li> <li>■ Os bornes por trás do VigiPacT RMH podem ter tensões perigosas. Não toque nesses bornes quando o VigiPacT RMH está ligando.</li> </ul> <p><b>A não observância destas instruções pode provocar a morte, ferimentos graves, ou danos no equipamento.</b></p>	<p><b>ОПАСНОСТЬ ПОРАЖЕНИЯ ЭЛЕКТРИЧЕСКИМ ТОКОМ</b></p> <ul style="list-style-type: none"> <li>■ Реле VigiPacT RMH разрешается использовать исключительно для контроля. Запрещается использовать данное реле для защиты людей и оборудования.</li> <li>■ Клеммные колодки за VigiPacT RMH могут нести опасное напряжение. Не касайтесь этих клеммных колодок, когда на VigiPacT RMH подано питание.</li> </ul> <p><b>Несоблюдение этих инструкций может привести к смерти, серьезной травме или повреждению оборудования.</b></p>	<p>可能存在电击</p> <ul style="list-style-type: none"> <li>■ VigiPacT RMH 继电器只能用作监控继电器。不可将其用作保护人身和设备安全的保护继电器。</li> <li>■ VigiPacT RMH 后的端子块上可能存在危险电压。VigiPacT RMH 通电后，不要触碰这些端子块。不遵循上述说明可能导致人员伤亡或设备损坏。</li> </ul>

<b>▲ CAUTION / ATTENTION / VORSICHT / ATTENZIONE / ATENCIÓN / CUIDADO / ВНИМАНИЕ / 小心</b>			
<p><b>HAZARD OF BURNING</b> The temperature of the VigiPacT RHM relay housing may reach 80 °C during operation. Switch off its power supply and wait until it has cooled down before handling it. <b>Failure to follow these instructions can result in injury or equipment damage.</b></p>	<p><b>RISQUE DE BRÛLURE</b> La température du boîtier du relais VigiPacT RHM peut atteindre 80 °C en fonctionnement. Coupez son alimentation et attendez qu'il refroidisse avant de le manipuler. <b>Si ces directives ne sont pas respectées, cela peut entraîner des blessures ou des dommages matériels.</b></p>	<p><b>VERBRENNUNGSGEFAHR</b> Die Temperatur des VigiPacT RHM-Relaisgehäuses kann während des Betriebs maximal 80 °C erreichen. Schalten Sie die Stromversorgung aus und warten Sie, bis das Gerät abgekühlt ist, bevor Sie es berühren. <b>Die Nichtbeachtung dieser Anweisungen kann Verletzungen oder Sachschäden zur Folge haben.</b></p>	<p><b>PERICOLO DI USTIONI</b> La temperatura dell'alloggiamento del relé VigiPacT RHM può raggiungere 80 °C durante il funzionamento. Disattivare l'alimentazione e attendere il raffreddamento prima di maneggiarlo. <b>Il mancato rispetto di queste istruzioni può provocare infortuni o danni alle apparecchiature.</b></p>
<p><b>PELIGRO DE QUEMADURAS</b> La temperatura de la carcasa del relé de VigiPacT RHM puede alcanzar los 80 °C durante el funcionamiento. Desconecte su fuente de alimentación y espere a que se enfríe antes de manipularla. <b>El incumplimiento de estas instrucciones puede causar lesiones o daño al equipo.</b></p>	<p><b>RISCO DE QUEIMADURA</b> A temperatura da caixa de relés VigiPacT RHM pode atingir 80 °C durante a operação. Desligue essa fonte de alimentação e aguarde até que arrefeça antes de utilizá-la. <b>A não observância destas instruções pode provocar ferimentos pessoais, ou danos no equipamento.</b></p>	<p><b>ОПАСНОСТЬ ОЖОГА</b> Температура корпуса реле VigiPacT RHM может достигать во время работы 80° С. Перед началом работы отключите его питание и дождитесь, пока корпус остынет. <b>Несоблюдение этих инструкций может привести к травме или повреждению оборудования.</b></p>	<p>烫伤危险 VigiPacT RHM 继电器在工作期间外壳温度可达到 80 °C。如要挪动，应先切断其电源，待其冷却。 不遵循上述说明可能导致人身伤害或设备损坏。</p>

<p><b>PLEASE NOTE</b></p> <ul style="list-style-type: none"> <li>■ Never connect or disconnect a connector while the device is energised.</li> <li>■ Check voltages before connecting.</li> <li>■ Always energise the RM12T multiplexer before the VigiPacT RMH.</li> <li>■ Protection of the VigiPacT RMH:             <ul style="list-style-type: none"> <li>□ Phase + neutral or 2-pole MCB (miniature circuit breaker)</li> <li>□ 1 A fuses</li> </ul> </li> <li>■ Three types of sensors may be connected:             <ul style="list-style-type: none"> <li>□ types A (closed toroid)</li> <li>□ TOA (opened toroid)</li> <li>□ L (rectangular sensor)</li> </ul> </li> <li>■ Connection cable between the VigiPacT RMH and the RM12T multiplexer:             <ul style="list-style-type: none"> <li>□ length: 10 m maximum</li> <li>□ 4 wires (2 twisted pairs)</li> </ul> </li> <li>■ The VigiPacT RMH automatically recognises any new sensor added when it is energised.</li> <li>■ The communication cable used to connect the VigiPacT RMH to the Modbus master must be a shielded cable complying with the standard RS-485 interface.</li> </ul>	<p><b>REMARQUE IMPORTANTE</b></p> <ul style="list-style-type: none"> <li>■ Ne jamais connecter ou déconnecter un connecteur lorsque l'appareil est sous tension.</li> <li>■ Vérifier les tensions avant de procéder au branchement.</li> <li>■ Toujours mettre sous tension le multiplexeur RM12T avant le VigiPacT RMH.</li> <li>■ Protection du VigiPacT RMH:             <ul style="list-style-type: none"> <li>□ Phase + neutre ou MCB bipolaire (Miniature Circuit Breaker, disjoncteur miniature)</li> <li>□ Fusibles 1 A</li> </ul> </li> <li>■ Trois types de capteurs peuvent être connectés:             <ul style="list-style-type: none"> <li>□ types A (tore fermé)</li> <li>□ TOA (tore ouvert)</li> <li>□ L (capteur rectangulaire)</li> </ul> </li> <li>■ Câble de connexion entre le VigiPacT RMH et le multiplexeur RM12T:             <ul style="list-style-type: none"> <li>□ Longueur: 10 m maximum</li> <li>□ 4 fils (2 paires torsadées)</li> </ul> </li> <li>■ Lorsqu'un nouveau capteur est ajouté, le VigiPacT RMH le reconnaît automatiquement lors de sa mise sous tension.</li> <li>■ Un câble de communication blindé compatible avec l'interface RS-485 standard doit être utilisé pour connecter le VigiPacT RMH au maître Modbus.</li> </ul>	<p><b>BITTE BEACHTEN</b></p> <ul style="list-style-type: none"> <li>■ Sie dürfen Steckverbinder weder abziehen noch anschließen, während das Gerät unter Spannung steht.</li> <li>■ Überprüfen Sie die anliegende Spannung, bevor Sie einen Stecker anschließen.</li> <li>■ Der RM12T-Multiplexer muss stets vor dem VigiPacT RMH unter Spannung gesetzt werden.</li> <li>■ Schutz des VigiPacT RMH:             <ul style="list-style-type: none"> <li>□ Phasen- und Nullleiter oder 2-poliger Leistungsschalter (MCB, Miniature Circuit Breaker)</li> <li>□ 1-A-Sicherungen</li> </ul> </li> <li>■ Sie können drei verschiedene Sensortypen anschließen:             <ul style="list-style-type: none"> <li>□ Typ A (geschlossener Ringwandler)</li> <li>□ TOA (geöffneter Ringwandler)</li> <li>□ L (Rechtecksensor)</li> </ul> </li> <li>■ Verbindungskabel zwischen VigiPacT RMH und RM12T-Multiplexer:             <ul style="list-style-type: none"> <li>□ Länge: max. 10 m</li> <li>□ 4-Draht (2 Twisted-Pair-Kabel)</li> </ul> </li> <li>■ Der VigiPacT RMH erkennt automatisch jeden hinzugefügten Sensor, sobald dieser eingeschaltet wird.</li> <li>■ Das für den Anschluss des VigiPacT RMH an den Modbus-Master verwendete Kommunikationskabel muss geschirmt sein und den Anforderungen der RS-485-Standardschnittstelle entsprechen.</li> </ul>	<p><b>NOTA</b></p> <ul style="list-style-type: none"> <li>■ Non collegare o scollegare mai un connettore mentre il dispositivo è alimentato.</li> <li>■ Verificare le tensioni prima di effettuare il collegamento.</li> <li>■ Alimentare sempre il multiplexer RM12T prima del dispositivo VigiPacT RMH.</li> <li>■ Protezione del dispositivo VigiPacT RMH:             <ul style="list-style-type: none"> <li>□ fase + neutro o MCB a 2 poli (sezionatore in miniatura)</li> <li>□ Fusibili 1 A</li> </ul> </li> <li>■ È possibile collegare tre tipi di sensori:             <ul style="list-style-type: none"> <li>□ tipi A (toroide chiuso)</li> <li>□ TOA (toroide aperto)</li> <li>□ L (sensore rettangolare)</li> </ul> </li> <li>■ Cavo di collegamento tra il dispositivo VigiPacT RMH e il multiplexer RM12T:             <ul style="list-style-type: none"> <li>□ lunghezza: max 10 m</li> <li>□ 4 cavi (2 coppie intrecciate)</li> </ul> </li> <li>■ Il dispositivo VigiPacT RMH riconosce automaticamente qualunque nuovo sensore aggiunto, quando data alimentazione.</li> <li>■ Il cavo di comunicazione utilizzato per collegare il dispositivo VigiPacT RMH e il master Modbus deve essere un cavo schermato conforme con l'interfaccia RS-485 standard.</li> </ul>
-----------------------------------------------------------------------------------------------------------------------------------------------------------------------------------------------------------------------------------------------------------------------------------------------------------------------------------------------------------------------------------------------------------------------------------------------------------------------------------------------------------------------------------------------------------------------------------------------------------------------------------------------------------------------------------------------------------------------------------------------------------------------------------------------------------------------------------------------------------------------------------------------------------------------------------------------------------------------------------------------------------------------------------------------------------------------------------------------------------------------------------------------------------------	-------------------------------------------------------------------------------------------------------------------------------------------------------------------------------------------------------------------------------------------------------------------------------------------------------------------------------------------------------------------------------------------------------------------------------------------------------------------------------------------------------------------------------------------------------------------------------------------------------------------------------------------------------------------------------------------------------------------------------------------------------------------------------------------------------------------------------------------------------------------------------------------------------------------------------------------------------------------------------------------------------------------------------------------------------------------------------------------------------------------------------------------------------------------------------------------------------------------------------------------------------------------------------	-----------------------------------------------------------------------------------------------------------------------------------------------------------------------------------------------------------------------------------------------------------------------------------------------------------------------------------------------------------------------------------------------------------------------------------------------------------------------------------------------------------------------------------------------------------------------------------------------------------------------------------------------------------------------------------------------------------------------------------------------------------------------------------------------------------------------------------------------------------------------------------------------------------------------------------------------------------------------------------------------------------------------------------------------------------------------------------------------------------------------------------------------------------------------------------------------------------------------------------------------------------------------------------------------------------------------------------------------------------------	----------------------------------------------------------------------------------------------------------------------------------------------------------------------------------------------------------------------------------------------------------------------------------------------------------------------------------------------------------------------------------------------------------------------------------------------------------------------------------------------------------------------------------------------------------------------------------------------------------------------------------------------------------------------------------------------------------------------------------------------------------------------------------------------------------------------------------------------------------------------------------------------------------------------------------------------------------------------------------------------------------------------------------------------------------------------------------------------------------------------------------------------------------------------------------------------------------------------------------------------------------------------------------------

<p><b>TENGA EN CUENTA</b></p> <ul style="list-style-type: none"> <li>■ Nunca conecte o desconecte un conector si el dispositivo está recibiendo alimentación.</li> <li>■ Compruebe las tensiones antes de realizar la conexión.</li> <li>■ Siempre proporcione alimentación al multiplexador RM12T antes que al VigiPacT RMH.</li> <li>■ Protección del VigiPacT RMH:             <ul style="list-style-type: none"> <li>□ MCB fase + neutro o de 2 polos (disyuntor en miniatura)</li> <li>□ Fusibles de 1 A</li> </ul> </li> <li>■ Pueden conectarse tres tipos de sensores:             <ul style="list-style-type: none"> <li>□ tipo A (toroidal cerrado)</li> <li>□ TOA (toroidal abierto)</li> <li>□ L (sensor rectangular)</li> </ul> </li> <li>■ Cable de conexión entre VigiPacT RMH y el multiplexador RM12T:             <ul style="list-style-type: none"> <li>□ longitud: 10 m máximo</li> <li>□ 4 cables (2 pares trenzados)</li> </ul> </li> <li>■ VigiPacT RMH reconoce automáticamente cualquier sensor nuevo que se añada si está conectado a una fuente de alimentación.</li> <li>■ El cable de comunicación que se ha empleado para conectar el VigiPacT RMH al maestro Modbus debe ser un cable blindado conforme a la interfaz RS-485 estándar.</li> </ul>	<p><b>NOTA</b></p> <ul style="list-style-type: none"> <li>■ Nunca ligue ou desligue um conector enquanto o dispositivo estiver a ser alimentado.</li> <li>■ Verifique as tensões antes de ligar.</li> <li>■ Coloque sempre o multiplexador RM12T a carregar antes do VigiPacT RMH.</li> <li>■ Protecção do VigiPacT RMH:             <ul style="list-style-type: none"> <li>□ Fase + neutro ou MCB de 2 pólos (disjuntor miniatura)</li> <li>□ Fusíveis de 1 A</li> </ul> </li> <li>■ Podem ser ligados três tipos de sensores:             <ul style="list-style-type: none"> <li>□ tipos A (toroidal fechado)</li> <li>□ TOA (toroidal aberto)</li> <li>□ L (sensor rectangular)</li> </ul> </li> <li>■ Cabo de ligação entre os multiplexadores VigiPacT RMH e RM12T:             <ul style="list-style-type: none"> <li>□ comprimento: máximo de 10 m</li> <li>□ 4 fios (2 pares entrelaçados)</li> </ul> </li> <li>■ O VigiPacT RMH reconhece automaticamente qualquer sensor novo adicionado, quando é alimentado.</li> <li>■ O cabo de comunicação utilizado para ligar o VigiPacT RMH ao Modbus master deve estar blindado e em conformidade com a interface RS-485 padrão.</li> </ul>	<p><b>ОБРАТИТЕ ВНИМАНИЕ</b></p> <ul style="list-style-type: none"> <li>■ Ни в коем случае не подключайте и не отключайте разъемы, пока прибор находится под напряжением.</li> <li>■ Перед подключением проверьте напряжения.</li> <li>■ Всегда подавайте питание сначала на мультиплексор RM12T, а только потом на VigiPacT RMH.</li> <li>■ Защита VigiPacT RMH:             <ul style="list-style-type: none"> <li>□ Фаза + нейтраль или 2-полюсный МСВ (миниатюрный автоматический выключатель)</li> <li>□ Предохранители на 1 А</li> </ul> </li> <li>■ Можно подключить датчики трех типов:             <ul style="list-style-type: none"> <li>□ типа А (замкнутый тороидальный)</li> <li>□ TOA (разомкнутый тороидальный)</li> <li>□ L (прямоугольный датчик)</li> </ul> </li> <li>■ Соединительный кабель между VigiPacT RMH и мультиплексором RM12T:             <ul style="list-style-type: none"> <li>□ длина: 10 м максимум</li> <li>□ 4 провода (2 витых пары)</li> </ul> </li> <li>■ VigiPacT RMH автоматически распознает любой новый датчик, подключенный, когда он запитан.</li> <li>■ Коммуникационный кабель, используемый для соединения VigiPacT RMH с главным устройством Modbus, должен быть экранирован в соответствии со стандартом интерфейса RS-485.</li> </ul>	<p><b>请注意</b></p> <ul style="list-style-type: none"> <li>■ 切勿在装置通电期间连接或断开连接器。</li> <li>■ 连接前检查电压。</li> <li>■ 总是先对 RM12T 多路转接器通电，再对 VigiPacT RMH 通电。</li> <li>■ VigiPacT RMH 的保护措施:             <ul style="list-style-type: none"> <li>□ 相位 + 中性线或者 2 极 MCB (微型断路器)</li> <li>□ 1 A 熔断器</li> </ul> </li> <li>■ 可连接三种类型的传感器:             <ul style="list-style-type: none"> <li>□ A 类 (闭式环形互感器)</li> <li>□ TOA (开放式环形互感器)</li> <li>□ L (矩形传感器)</li> </ul> </li> <li>■ VigiPacT RMH 与 RM12T 多路转接器之间的连接线:             <ul style="list-style-type: none"> <li>□ 长度: 最长 10 米</li> <li>□ 4 根线 (2 根双绞线)</li> </ul> </li> <li>■ VigiPacT RMH 通电时自动识别任何新增的传感器。</li> <li>■ 用于将 VigiPacT RMH 连接到 Modbus 主站的通讯电缆必须是符合标准 RS-485 接口的屏蔽电缆。</li> </ul>
----------------------------------------------------------------------------------------------------------------------------------------------------------------------------------------------------------------------------------------------------------------------------------------------------------------------------------------------------------------------------------------------------------------------------------------------------------------------------------------------------------------------------------------------------------------------------------------------------------------------------------------------------------------------------------------------------------------------------------------------------------------------------------------------------------------------------------------------------------------------------------------------------------------------------------------------------------------------------------------------------------------------------------------------------------------------------------------------------------------------------------------------------------------------------------------------------------------------------------------------------------------------------------	------------------------------------------------------------------------------------------------------------------------------------------------------------------------------------------------------------------------------------------------------------------------------------------------------------------------------------------------------------------------------------------------------------------------------------------------------------------------------------------------------------------------------------------------------------------------------------------------------------------------------------------------------------------------------------------------------------------------------------------------------------------------------------------------------------------------------------------------------------------------------------------------------------------------------------------------------------------------------------------------------------------------------------------------------------------------------------------------------------------------------------------------------------------------------------------------	-----------------------------------------------------------------------------------------------------------------------------------------------------------------------------------------------------------------------------------------------------------------------------------------------------------------------------------------------------------------------------------------------------------------------------------------------------------------------------------------------------------------------------------------------------------------------------------------------------------------------------------------------------------------------------------------------------------------------------------------------------------------------------------------------------------------------------------------------------------------------------------------------------------------------------------------------------------------------------------------------------------------------------------------------------------------------------------------------------------------------------------------------------------------------------------------------------------------------------------------------------------------------------------------	--------------------------------------------------------------------------------------------------------------------------------------------------------------------------------------------------------------------------------------------------------------------------------------------------------------------------------------------------------------------------------------------------------------------------------------------------------------------------------------------------------------------------------------------------------------------------------------------------------------------------------------------------------------------------------------------------------------------------------------

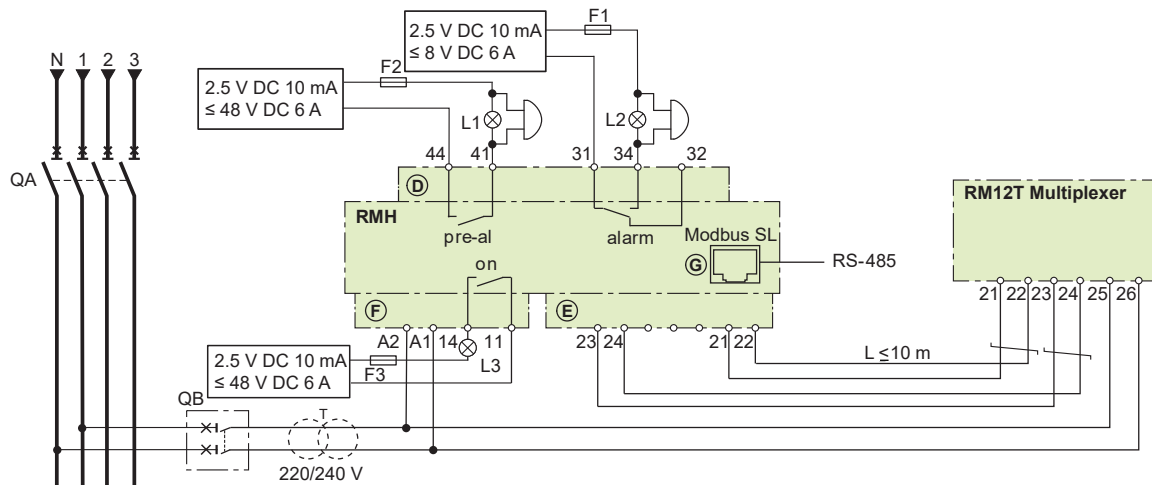

Cable and terminal characteristics

I / O	Voltage max	Current max	Temperature	Section	Type
D	50 V AC 120 V DC	6 A	85 °C	0,75...2.5 mm <sup>2</sup>	
E	5 V DC	0.2 A	85 °C	0,75...2.5 mm <sup>2</sup>	Twisted pair L < 10 m
F (A2, A1)	240 V AC	0.1 A	85 °C	1.5...2.5 mm <sup>2</sup>	
F (11, 14)	240 V AC	6 A	85 °C	1.5...2.5 mm <sup>2</sup>	
G	5 V DC	0.05 A	85 °C	0.33 mm <sup>2</sup>	Standard RJ45 Ethernet shielded cable

**EN** QA: Switchboard incoming circuit breaker for the main circuit  
 QB: Disconnecting device to protect RMH and RM12T power supply circuit  
 F1, F2, F3: Fuses to protect the contact outputs 44, 41, 31, 34, 32, 14 and 11 (calibration according to customer installation).

**FR** QA: Disjoncteur de protection du circuit principal  
 QB: Disjoncteur de protection du relais RMH et du multiplexeur RM12T  
 F1, F2, F3: Fusibles de protection des contacts de sortie 44, 41, 31, 34, 32, 14 et 11 (calibre à définir en fonction de l'application).

<p><b>(DE)</b> QA: Einspeisender Leistungsschalter für den Hauptschaltkreis der Schalttafel                  QB: Trennen des Geräts zum Schutz des RMH- und RM12T-Stromversorgungskreises                  F1, F2, F3: Sicherungen zum Schutz der Kontaktausgänge 44, 41, 31, 34,32, 14 und 11 (Kalibrierung gemäß Kundeninstallation)</p> <p><b>(ES)</b> QA: Interruptor automático de entrada de cuadro eléctrico para el circuito principal                  QB: Desconexión del dispositivo para proteger el circuito de la fuente de alimentación RMH y RM12T                  F1, F2, F3: Fusibles para proteger las salidas de contactos 44, 41, 31, 34,32, 14 y 11 (la calibración se realiza en función de la instalación del cliente).</p> <p><b>(RU)</b> QA: автоматический выключатель подачи электропитания на распределительном щите для главной цепи                  QB: устройство отключения для защиты силовой цепи RMH и RM12T                  F1, F2, F3: предохранители для защиты контактных выводов 44, 41, 31, 34, 32, 14 и 11 (калибровка согласно установке заказчика).</p>	<p><b>(IT)</b> QA: interruttore in entrata quadro per il circuito principale                  QB: dispositivo disconnessione per proteggere circuito di alimentazione RMH e RM12T                  F1, F2, F3: fusibili per proteggere i contatti di uscita 44, 41, 31, 34,32, 14 e 11 (calibrazione in base a installazione del cliente).</p> <p><b>(PT)</b> QA: Disjuntor de entrada da central telefónica do circuito principal                  QB: dispositivo de desconexão para proteger o circuito de fonte de alimentação RMH e RM12T                  F1, F2, F3: Fusíveis para proteger os outputs de contacto 44, 41, 31, 34,32, 14 e 11 (calibração de acordo com a instalação do cliente).</p> <p><b>(ZH)</b> QA: 主电路的配电盘进电断路器                  QB: 断开设备连接, 保护 RMH 和 RM12T 供电电路                  F1, F2, F3: 用于保护触点输出 44、41、31、34、32、14 和 11 的熔断器 (根据客户的具体安装进行校准)。</p>
---------------------------------------------------------------------------------------------------------------------------------------------------------------------------------------------------------------------------------------------------------------------------------------------------------------------------------------------------------------------------------------------------------------------------------------------------------------------------------------------------------------------------------------------------------------------------------------------------------------------------------------------------------------------------------------------------------------------------------------------------------------------------------------------------------------------------------------------------------------------------------------------------------------------------------------------------------------------------------------------------------------------------------------------------------------------------------------------------------------------------------	--------------------------------------------------------------------------------------------------------------------------------------------------------------------------------------------------------------------------------------------------------------------------------------------------------------------------------------------------------------------------------------------------------------------------------------------------------------------------------------------------------------------------------------------------------------------------------------------------------------------------------------------------------------------------------------------------------------------------------------------------------------------------------------------------------------------------------------------------------------------------------------------------------------

**NOTICE / AVIS / HINWEIS / AVVISO / AVISO / AVISO / УВЕДОМЛЕНИЕ / 注意**

<p><b>HAZARD OF PRODUCT DAMAGE</b>                  The power supply A1-A2 must be disconnected before dielectric test.  <b>Failure to follow these instructions can result in equipment damage.</b></p>	<p><b>RISQUE D'ALTERATION DU PRODUIT</b>                  L'alimentation A1-A2 doit être débranchée avant tout essai diélectrique.  <b>Si ces directives ne sont pas respectées, cela peut entraîner des dommages matériels.</b></p>	<p><b>GEFAHR EINER BESCHÄDIGUNG DES GERÄTS</b>                  Die Spannungsversorgung A1-A2 muss vor der dielektrischen Prüfung getrennt werden.  <b>Die Nichtbeachtung dieser Anweisungen kann Sachschäden zur Folge haben.</b></p>	<p><b>RISCHIO DI DANNI AL PRODOTTO</b>                  I contatti di alimentazione A1-A2 devono essere scollegati prima di effettuare un test dielettrico.  <b>Il mancato rispetto di queste istruzioni può provocare danni alle apparecchiature.</b></p>
<p><b>PELIGRO POR DAÑOS EN EL PRODUCTO</b>                  Se debe desconectar la fuente de alimentación A1-A2 antes de realizar la prueba dieléctrica.  <b>El incumplimiento de estas instrucciones puede causar daño al equipo.</b></p>	<p><b>PERIGO DE DANOS NO PRODUTO</b>                  A fonte de alimentação A1-A2 deve ser desligada antes de efectuar o teste dielétrico.  <b>A não observância destas instruções pode provocar danos no equipamento.</b></p>	<p><b>ОПАСНОСТЬ ПОВРЕЖДЕНИЯ ИЗДЕЛИЯ</b>                  Перед проведением испытания на диэлектрическую прочность электропитание A1-A2 необходимо отключить.  <b>Несоблюдение этих инструкций может привести к повреждению оборудования.</b></p>	<p>产品损坏危险                  在绝缘测试前必须断开电源 A1-A2。不遵循上述说明可能导致设备损坏。</p>

# Technical data / Données techniques / Technische Daten / Dati tecnici / Especificaciones técnicas / Dados técnicos / Технические данные / 技术数据

<p><b>EN</b> ■ Ambient operating temperature: -25 °C to +55 °C</p> <p>■ Storage temperature: -55 °C to +85 °C</p> <p>■ Current measurement range: 15 mA to 60 A</p> <p>■ Measurement accuracy: ±10 %</p> <p>■ Maximum consumption: 8 VA</p> <p>■ Type of network to monitor: &lt;1000 V AC; 50 Hz, 60 Hz, and 400 Hz</p> <p>■ Power supply: 220-240 V AC 50/60 Hz -15% / +10%</p> <p>■ 5 % - 95 % RH without condensation</p> <p>■ Indoor use only, altitude &lt; 2000 m.</p> <p>■ Safety standard: IEC 61010-1</p>	<p><b>FR</b> ■ Température ambiante de fonctionnement : -25 °C à +55 °C</p> <p>■ Température de stockage: -55 °C à +85 °C</p> <p>■ Plage de mesure d'intensité: 15 mA à 60 A</p> <p>■ Précision des mesures: ±10 %</p> <p>■ Consommation maximale : 8 VA</p> <p>■ Type de réseau à surveiller: &lt;1000 V CA; 50 Hz, 60 Hz et 400 Hz</p> <p>■ Alimentation: 220/240 V CA 50/60 Hz -15 % / +10 %</p> <p>■ 5 - 95 % HR sans condensation</p> <p>■ Utilisation en intérieur uniquement, à une altitude &lt; 2000 m.</p> <p>■ Norme sécurité : CEI 61010-1</p>	<p><b>DE</b> ■ Umgebungstemperatur während des Betriebs: -25 °C bis +55 °C</p> <p>■ Lagertemperatur: -55 °C bis +85 °C</p> <p>■ Strommessbereich: 15 mA bis 60 A</p> <p>■ Messgenauigkeit: ±10 %</p> <p>■ Max. Leistungsaufnahme: 8 VA</p> <p>■ Typ des zu überwachenden Netzwerks: &lt;1000 V AC / 50 Hz, 60 Hz und 400 Hz</p> <p>■ Spannungsversorgung: 220 / 240 V AC 50/60 Hz -15+10 %</p> <p>■ 5 % - 95 % relative Luftfeuchtigkeit (nicht kondensierend)</p> <p>■ Betrieb nur in Innenräumen, Höhe &lt; 2000 m.</p> <p>■ Sicherheitsstandard: IEC 61010-1</p>	<p><b>IT</b> ■ Temperatura operativa ambiente: da -25 °C a +55 °C</p> <p>■ Temperatura di immagazzinamento: da -55 °C a +85 °C</p> <p>■ Intervallo di misurazione corrente: da 15 mA a 60 A</p> <p>■ Precisione della misurazione: ±10%</p> <p>■ Consumo massimo: 8 VA</p> <p>■ Tipo di rete da controllare: &lt;1000 V CA.; 50 Hz, 60 Hz e 400 Hz</p> <p>■ Alimentazione: 220/240 V CA. 50/60 Hz -15% / +10%</p> <p>■ UR 5 % - 95 % senza condensa</p> <p>■ Solo per uso interno, altitudine &lt; 2000 m.</p> <p>■ Standard di sicurezza IEC 61010-1</p>
<p><b>ES</b> ■ Temperatura ambiente de funcionamiento: de -25 °C a +55 °C</p> <p>■ Temperatura de almacenamiento: de -55 °C a +85 °C</p> <p>■ Rango de medición de corriente: de 15 mA a 60 A</p> <p>■ Precisión de la medida: ±10 %</p> <p>■ Consumo máximo: 8 VA</p> <p>■ Tipo de red que se monitorizará: &lt;1.000 V CA; 50 Hz, 60 Hz y 400 Hz</p> <p>■ Fuente de alimentación: 220/240 V CA 50/60 Hz -15 % / +10 %</p> <p>■ Del 5 % al 95 % de humedad relativa sin condensación</p> <p>■ Sólo para uso en interiores, altitud &lt; 2000 m</p> <p>■ Norma de seguridad: IEC 61010-1</p>	<p><b>PT</b> ■ Temperatura operacional ambiente: -25 °C a +55 °C</p> <p>■ Temperatura de armazenamento: -55 °C a +85 °C</p> <p>■ Intervalo de medição da corrente: 15 mA a 60 A</p> <p>■ Precisão de medida: ±10%</p> <p>■ Consumo máximo: 8 VA</p> <p>■ Tipo de rede a monitorizar: &lt;1000 V CA; 50 Hz, 60 Hz e 400 Hz</p> <p>■ Fonte de alimentação: 220/240 V CA 50/60 Hz -15% / +10%</p> <p>■ HR de 5 % - 95 % sem condensação</p> <p>■ Somente uso interior, altitude &lt; 2000 m.</p> <p>■ Norma de segurança: IEC 61010-1</p>	<p><b>RU</b> ■ Рабочая температура окружающей среды: от -25 до +55 °C</p> <p>■ Температура хранения: от -55 °C до +85 °C</p> <p>■ Диапазон измерения тока: от 15 mA до 60 A</p> <p>■ Точность измерений: ±10%</p> <p>■ Максимальное энергопотребление: 8 ВА</p> <p>■ Тип контролируемой сети: &lt;1000 В перем. тока; 50 Гц, 60 Гц и 400 Гц</p> <p>■ Электропитание: 220/240 В перем. тока 50/60 Гц -15% / +10%</p> <p>■ от 5 до 95% ОВ без конденсации</p> <p>■ Только для использования в помещениях на высоте до 2000 м над уровнем моря.</p> <p>■ Стандарт по безопасности: IEC 61010-1</p>	<p><b>ZH</b> ■ 环境温度: -25 °C 至 +55 °C</p> <p>■ 存储温度: -55 °C 至 +85 °C</p> <p>■ 当前量程: 15 mA 至 60 A</p> <p>■ 测量精度: ±10 %</p> <p>■ 最大功耗: 8 VA</p> <p>■ 被监控网络的类型: &lt;1000 V AC; 50 Hz、60 Hz 和 400 Hz</p> <p>■ 电源: 220/240 V AC 50/60 Hz -15% / +10%</p> <p>■ 5% - 95% RH, 无冷凝</p> <p>■ 仅供室内使用, 海拔低于 2000 米。</p> <p>■ 安全标准: IEC 61010-1</p>

**Schneider Electric Industries SAS**  
35 rue Joseph Monier  
CS 30323  
F - 92506 Rueil Malmaison Cedex  
www.se.com

**Schneider Electric Limited**  
Stafford Park 5  
Telford, TF3 3BL  
United Kingdom  
www.se.com/uk



**Уполномоченный поставщик в РФ:**  
**АО «Шнейдер Электрик»**  
Адрес: 127018, г. Москва, ул.  
Двинцев, д. 12, корп. 1,  
тел. +7 (495) 777 99 88,  
факс: +7 (495) 777 99 94, 8-800-200-6446  
www.se.com/ru



Printed on  
recycled  
paper.