

DCFC24 Single standard Charging Stations User Manual

07/2020

	Description 1 CHAdeMO	Description 2 CCS Combo 2
Certification	EVD1S24T0H	EVD1S24T0B



For the floor standing version (charging station pedestal), add the reference :
EVP1DB1LG Pedestal_24kW DC Charger_Single)

This document contains general descriptions and/or general technical specifications of the products mentioned. It cannot be used to determine the suitability or reliability of these products for specific user applications. It is the responsibility of each user or integrator to conduct the appropriate risk analysis in full, assessing and testing products as regards the application in which they will be used and the execution of this application. Neither Schneider Electric nor any of its affiliated companies or subsidiaries can be held responsible for incorrect use of the information contained in this document. If you have any suggestions for improvements or correction, or have found errors in this publication, please notify us.

No part of this document may be reproduced in any form or by any means, electronic or mechanical, including photocopying, without express written permission from Schneider Electric.

All relevant state, regional, and local safety regulations must be observed when installing and using this product. For reasons of safety and to ensure compliance with documented system data, only the manufacturer should perform repairs to components.

When equipment is used for applications with technical safety requirements, follow the relevant instructions.

Failure to use Schneider Electric software or approved software with our hardware products may result in injury, harm, or improper operation.

Failure to follow this instruction can result in injury or equipment damage.

© 2020 Schneider Electric. All rights reserved.

Table of Contents

1. Safety Information	4
Important Information	4
NOTICE.....	4
IMPORTANT NOTE.....	4
2. About This Manual	5
Aim of This Document	5
Area of Application	5
Related Documents	5
3. General safety instructions	6
4. Overview	7
External view	7
5. Specification	8
Main Supplies	8
6. Operating Instructions	12
Start a Vehicle Charge Session	12
Stop a Vehicle Charge Session	12
Emergency Stop	12
7. Utilization	13
User Identification	14
EV connection	14
EV communication	15
EV charger	15
End of charge	16
Other messages	18
Errors	19
8. Protecting the Environment	21
Recycling Packaging	21
End-of-Life Recycling	21

1. Safety Information

Important Information

NOTICE

Read these instructions carefully, and look at the equipment to become familiar with the device before trying to install, operate, or maintain it. The following special messages may appear throughout this documentation or on the equipment to warn of potential hazards or to call attention to information that clarifies or simplifies a procedure.



The addition of one of these symbols to a “Danger” safety label on a device indicates that an electrical hazard exists, which will result in death or personal injury if the instructions are not followed.



This is the safety alert symbol. It warns you of a risk of physical injury. You must comply strictly with the safety instructions associated with this symbol to avoid injuring yourself or putting your life in danger.

DANGER

DANGER indicates an imminently hazardous situation, which, if not avoided, **will result in** death or serious injury.

WARNING

WARNING indicates a potentially hazardous situation which **could result in** death or serious injury.

CAUTION

CAUTION indicates a potentially hazardous situation which **could result in** minor or moderate injury.

NOTICE

NOTICE indicates practices that do not involve the risk of bodily injury.

IMPORTANT NOTE

Electrical equipment should be installed, serviced, and maintained only by qualified personnel. No responsibility is assumed by Schneider Electric for any consequences arising out of the use of this equipment.

A qualified person is one who has skills and knowledge related to the construction, operation and installation of electrical equipment, and has undertaken safety training in how to identify and avoid the hazards involved.

This device must not be installed or used if you notice that it is damaged.

The manufacturer cannot be held responsible for failure to follow the instructions given in this instruction sheet.

2. About This Manual

Aim of This Document

This document describes how to use the EVlink DC fast charger.

 DANGER
RISK OF ELECTROCUTION Do not replace connector units or plates unless you work for Schneider Electric After-Sales Service. Failure to follow these instructions will result in death or serious injury.

Area of Application

This user manual applies to the following EVlink DC fast charging stations:

- EVD1S24T0H 24kW DC Charger CHAdeMO
- EVD1S24T0B 24kW DC Charger CCS Combo 2

Related Documents

You can download the following documents by searching for the document reference on our website (www.se.com):

Document title	Reference
Installation Guide multi standard	MFR77341
Installation Guide mono standard	MFR77340
Service Notice	MFR77344
User Manual multi standard	MFR77343
User Manual single standard	MFR77342
Maintenance Notice	MFR77345
Badges Management Notice	MFR77346

3. General Safety Instructions

NOTICE

SAVE THIS MANUAL

- To ensure proper and safe operation, please read these user instructions carefully and keep them for future reference.
 - This manual contains important instructions for the DC quick charger that shall be followed during installation, operation and maintenance of the unit.
 - This equipment shall be installed, adjusted, and serviced by qualified electrical personnel familiar with the construction and operation of this type of equipment and associated hazards.
- Failure to follow these instructions may result in death, serious injury or equipment damage.**

⚠ DANGER

RISK OF ELECTRIC SHOCK, INJURY, AND/OR BURNING

- Only qualified, trained and authorized people will repair, replace or adjust this equipment.
 - Make sure the AC input breaker is OFF and measures 0V before the breaker.
 - Do not use this product if the cables (input or output) are frayed, have damaged insulation or any other signs of damage.
 - Do not use this product if the enclosure or the EV connectors are broken, cracked, opened or show any other indication of damage.
 - This equipment employs parts, such as switches and relays, that tend to produce arcs or sparks and therefore, when used in a garage, locate in a room or enclosure provided for the purpose or not less than 500mm (18 inches) above the floor.
- Failure to follow these instructions will result in death or serious injury**

⚠ WARNING

RISK OF DAMAGE TO THE TERMINAL

- Do not use this product if the cables (input or output) are frayed, have damaged insulation or any other signs of damage.
 - Do not use this product if the enclosure or the Electrical Vehicle Supply Equipment (EVSE) connectors are broken, cracked, opened or shows any other indication of damage.
 - Do not use a cord extension set or second cable assembly in addition to the cable assembly for the connection of the EV to the EVSE.
- Failure to follow these instructions can cause damage.**

NOTICE

READ THIS MANUAL

The locking key, supplied with unit, should be kept in a secure and known location by an individual that has read and understands the content of this manual.

- Do not open the front cover at any time while input power is present.
- Do not operate the unit while the cabinet door is opened or unlocked.

Failure to follow these instructions may result in death, serious injury or equipment damage.

4. Overview

External view

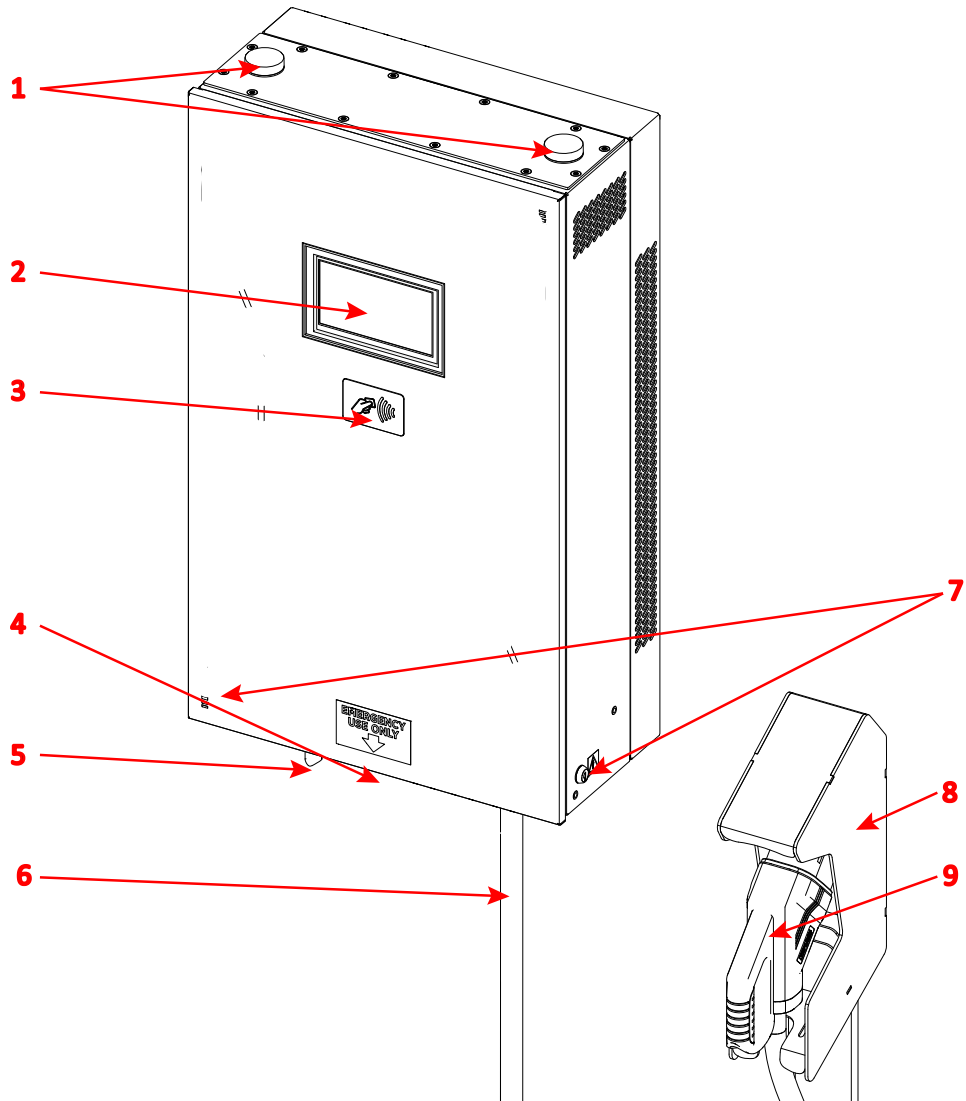

- 1 Antennas
- 2 7" touchscreen display
- 3 RFID reader
- 4 Emergency Stop button
- 5 Input cable
- 6 Output cable
- 7 Key locker
- 8 Connector holster
- 9 Output DC coupler

5. Specification

Main supply

The charging station can be connected to several mains supplies as detailed on following tables.

Mains supplies 3-phase L1/L2/L3 + N + GND			
Mains 3-phase voltage range	V_{AC}	400 V_{AC}	± 10%
Earthed electrical system	TT or TN		
Frequency range	f	50 Hz	± 10%
Nominal input current	I_{AC}	40-32A	Nom
Maximum input current	I_{AC}	45A	Max
Power Factor	PF	0,99	Nom
Efficiency	η	95 %	Max
Harmonic current @ nominal network voltage	THDi	< 13 %	Max

Internal AC input protection			
Inrush current limitation per phase	$I_{INRUSH\ LIMIT}$	< 3 x I_{AC}	Max
Rated Current Fuse (per module)	I_{BREAK} Rating	80A	typ
Breaking capacity of fuses	I_{BREAK} Capacity	80 000A	Max
Max earth leakage current	$I_{LEAKAGE}$	< 3,5 mA	Max
Emergency button connection	Yes		
Overvoltage category (IEC60664-1)	III		
Insulation protection Class (IEC60664-1)	Class I		

DC Output			
Output voltage COMBO 2	V_{DC_max}	530 V_{DC}	Max
	V_{DC_min}	200 V_{DC}	Min
Output voltage CHAdeMO	V_{DC_max}	500 V_{DC}	Max
	V_{DC_min}	150 V_{DC}	Min
Output current	I_{DC_max}	65A	Max
	I_{DC_min}	1,5A	Min
Max Output Power	P_{OUT}	24kW	Max
Connector (charging station side)	Tethered cable		
Vehicle inlet	CCS COMBO 2 or CHAdeMO		
Output cable length	Meters	3.5	-10/+0%

Internal DC output protection			
Hardware and software short circuit protection	Yes		
Software and Hardware over voltage protection	adjustable	+10% max	
Over temperature protection	-	70	°C
Reverse polarity protection	Yes		
DC output Contactor	Yes (2 poles)		
Rated Current Fuse (output)	I_{FUSE}	125	A
Galvanic isolation	$V_{input/output}$	4800	V_{DC}
Max time for DC line discharge < 60V	$T_{<60V}$	1	s

Embedded Insulation device of charger module	
Response time (tan)	< 3sec. for asymmetrical fault < 62sec. for symmetrical fault
Self test time	At power on and every 60s during charge
Internal resistance Ri of the measuring circuit	1.5Mohms permanent 750Kohms continuous measurement 300Kohms during simultaneous switching measurement
Measurement method	Continuous and switching measurement resistor method
Measuring current Im	< 1,4mA at RF=0
Measurement range (Ran)	20Kohms...300Kohms
Relative uncertainty	±15%
Line L+/L- Voltage (Un)	DC 150V...530V
System leakage capacity Ce	≤ 1μF : response value (Ran) and time (tan) are not guaranteed for capacity above 1μF
Parallelization	Warning: Do not connect the insulation monitor device (IMD) in parallel !! Response value (Ran) and time (tan) are not guaranteed.

Radio Frequency characteristics				
The equipment module is designed to provide customers with global network coverage on the connectivity of UMTS/HSPA+, and it is also fully backward compatible with the existing EDGE and GSM/GPRS networks.				
	Frequency band (MHz)		Output power (dBm)	
	Tx	Rx	Min	Max
GSM850/EGSM900 (GMSK)	880-915	925-960	5 ±5dB	33 ±2dB
GSM850/EGSM900 (8-PSK)	880-915	925-960	0 ±5dB	27 ±3dB
DCS1800/PCS1900 (GMSK)	1710-1785	1805-1880	0 ±5dB	30 ±2dB
DCS1800/PCS1900 (8-PSK)	1710-1785	1805-1880	0 ±5dB	26 ±3dB
WCDMA	B1/B2/B4-B6/B8/B19	B1/B2/B4-B6/B8/B19	<-49	24 +1/-3dB
LTE-FDD	B1-B5/B7/B8/B12/ B13/B18-B20/B25/ B26/B28	B1-B5/B7/B8/B12/ B13/B18-B20/B25/ B26/B28	<-39	23 ±2dB
LTE-TDD	B38-B41	B38-B41	<-39	23 ±2dB

RFID reader characteristics	
To start a charge, users must swipe a contactless RFID card across the card reader.	
Frequency bands	13.56 Mhz
Output power	-5dBuA/m@3m

General & dimensions			
External dimensions (mm)	H x W x D	1225 x 507 x 250 mm	
Weight (without bracket)	kg	66kg	Max
Weight (with pedestal)	kg	117kg	Max
Type of installation	Mounting on a wall or on a pedestal with proper fixation point		
Fixation points	8 screws for wall mounting		
Protection type (EN60529)	IP	IP55	
Cooling systems	Heatsink with forced air flow by fans IP55 without air filter		
Noise (1m, all direction)	Db(A)	65dbA (1m)	

Climatic & Environment constraints			
Operating temperature (with derating)	-25°C to +55°C ⁽³⁾		
Storage temperature	-25°C to +60°C		
Relative humidity	RH	10% to 95%	
Installation altitude	Alt	2 000m	Max

Norms & standards	
EC Low voltage EC directive (LVD)	2014/35/EU
EC Electromagnetic Directive (EMC)	2014/30/EU
Radio Equipment Directive (RED)	2014/53/EU
Electric vehicle conductive charging system part 1 General requirement	IEC 61851-1
Electric vehicle conductive charging system part 22 AC Electric vehicle charging station	IEC 61851-22
Electromagnetic compatibility (EMC)	IEC 61851-21-2
Insulation Monitor Device (IMD)	IEC 61557-1 & IEC 61557-8
RoHS	2015/863/EU
Declaration of conformity CE ⁽⁴⁾	Yes - pending

(1) Max output current will be adapted versus maximum carrying current of the vehicle plug.

(2) Output current can be even reduced with the power derating versus temperature.

(3) Potential derating above 35°C.

(4) CE marking affixed on the product attest the conformity of the product with applicable requirements of relevant Community harmonization legislation..

On single standard DC fast charger , you only have one Combo or ChAdeMO connector

Compliance

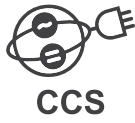

Derating

As a direct correlation exists between the current and ambient temperature a derating curve is provided for all charging station.

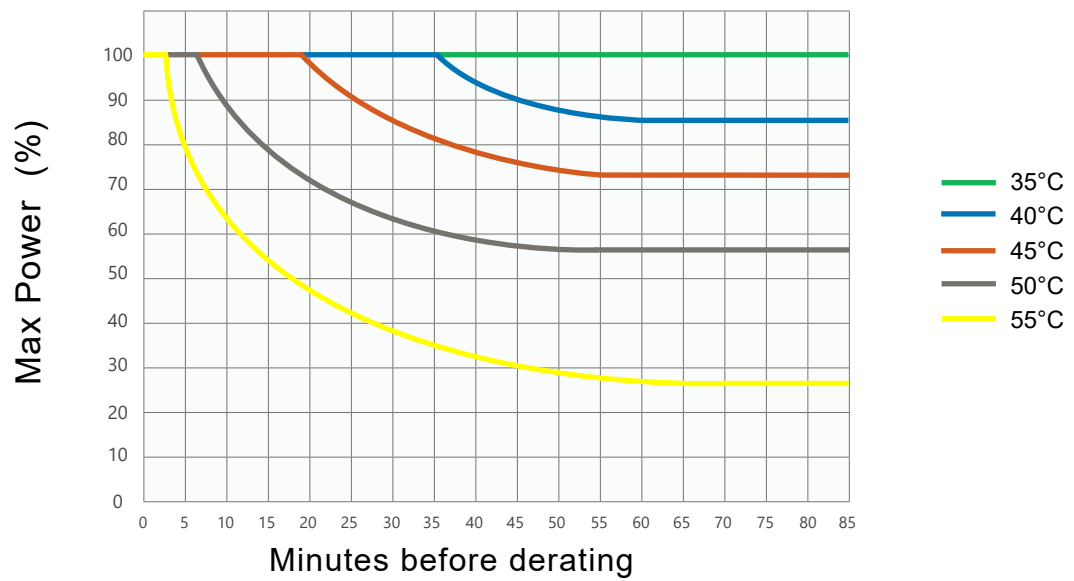

@ $V_{OUT/SORTIE}=370V_{DC}$ & $I_{OUT/SORTIE}=65A$

6. Operating instructions

Start a Vehicle Charge Session in DC mode

Before starting a charge session:

Ensure the unit is properly assembled in accordance with the assembly instructions before it is used

You must have a RFID Card activated on backend server or being connected to backend App.

A) Swipe an activated RFID card once across the card reader

or

B) Remotely start the charge through an application linked to the backend

A) The unit will beep once indicating the card swipe was successful

B) Wait for display indication

The display will show if the charge has been authorized

The display will instruct the user when to plug into the vehicle

Plug the coupler firmly into the vehicle. The latch should click

Observe the display and charging will begin once the car acknowledges the charger

Stop a Vehicle Charge Session

The charger will automatically stop once charging is completed. Fast charging will occur up to 80% of the vehicles battery state of charge. The charger will adjust its output according to the demands of the vehicle, ambient temperatures and other factors.

To stop charging before the end of the charging cycle follow these steps :

A) With the same card that the session was initiated with, swipe over the card reader

or

B) Remotely stop the charge through an application linked to the backend

The display will indicate that the session is ending

Once the session has ended the vehicle will unlock the coupler. A click may be heard at the vehicle/ coupler

Once unlocked, remove it from the vehicle charging inlet

Return the coupler to the dock on the charging station

Emergency Stop

In the event of an emergency the Emergency Stop button may be depressed to instantly stop charging.

To emergency stop follow these steps :







Depress the emergency stop button bellow the charger

The display will show the text "Error occurred: 0x02 Emergency stop was launched. Please unplug your vehicle and check the emergency button is released."

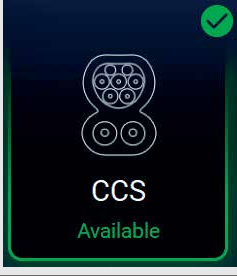
Unplug the coupler from the vehicle

To reset after emergency stop rotate the button clockwise until it pops outward. After a self-test the display will remove the emergency stop message and will be ready for a new session.

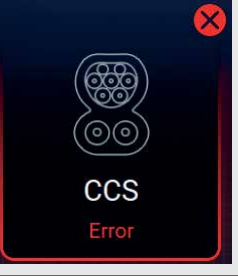
7. Utilization

Available	Preparing/Finishing	Charging	Unavailable	Error
				
				

Note: Applicable in COMBO, CHAdeMO and AC.

Charger states

Available: Connector available

Preparing: Charge preparation

Finishing: Charge ending or ended but connector still connected to the vehicle

Unavailable: Connector unavailable

Error: An error has occurred

User identification

The charging station remains in standby mode while waiting for a new user to be identified. When an user wants to recharge the electrical vehicle, there are 2 ways to identify on the charging station:

- to swipe an activated RFID card once across the card reader,
- to remotely start the charge through an application linked to the supervision tool.

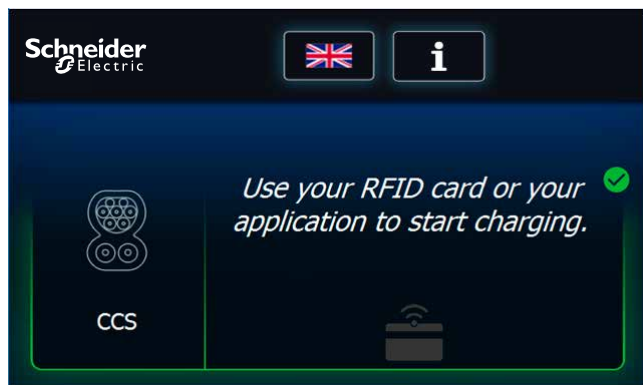

Note: Applicable in COMBO, CHAdeMO

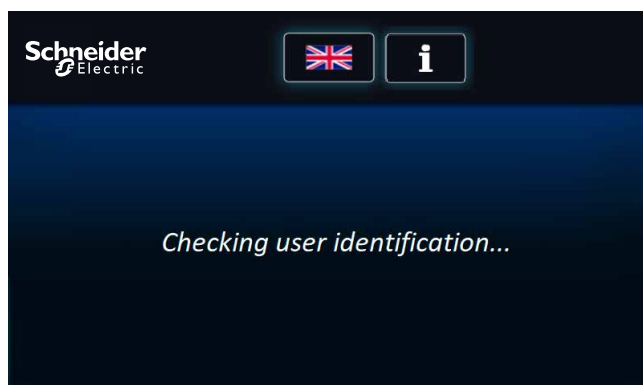

Note: Applicable in COMBO, CHAdeMO

EV connection

The charging station invites the user to connect the EV with the following screen:

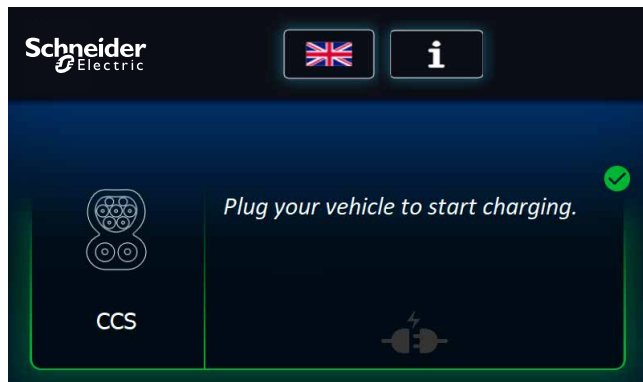

Note: Applicable in COMBO, CHAdeMO

EV connection

Before starting a charge, the charging station communicates with the electrical vehicle to collect information. All these steps are necessary to adapt the charging station parameters to the electrical vehicle.

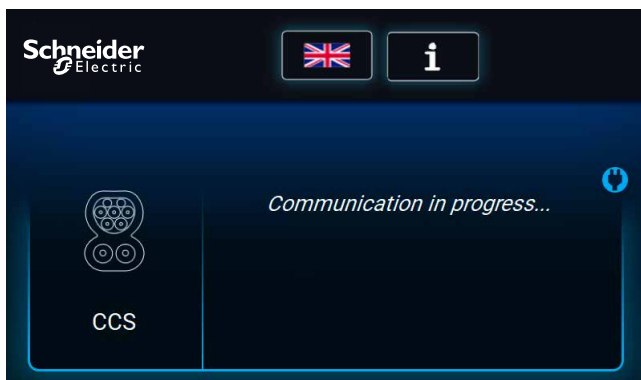

Note: Applicable in COMBO, CHAdeMO and AC

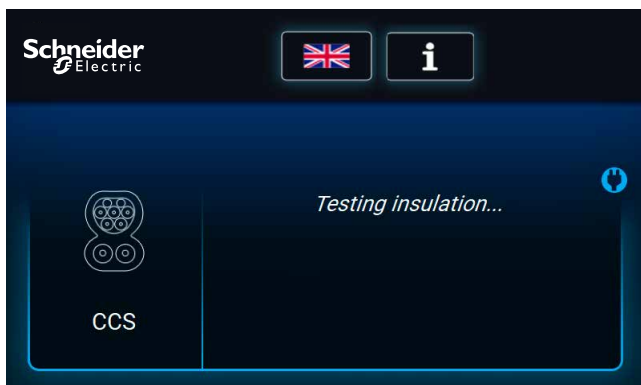

Note: Applicable in COMBO, CHAdeMO

EV charge

Combined Charging System (CCS) et CHAdeMO

During the charge of the electrical vehicle, the charging station shows on first a precharging message, followed by the charge informations (voltage, amperage, power and time remaining)

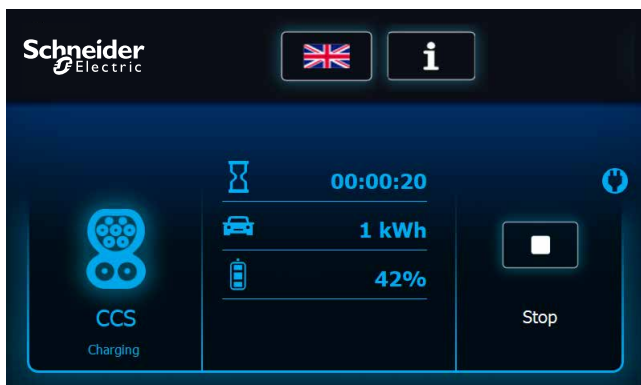

Note: Applicable in COMBO and CHAdeMO

End of charge

After completing the charge of the electric vehicle, the charging station performs multiple control steps before disconnecting the vehicle.

Combined Charging System (CCS)

when the Combo protocol is used, the user can unplug the vehicle.

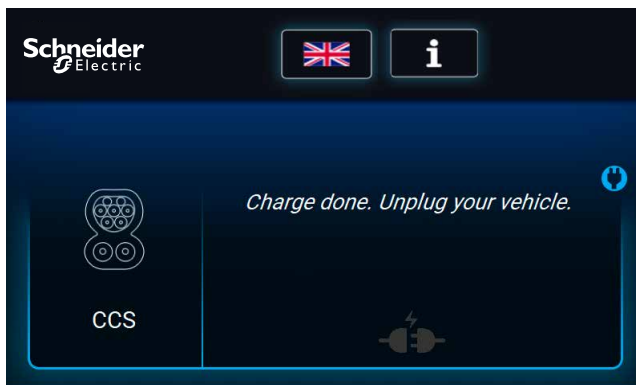
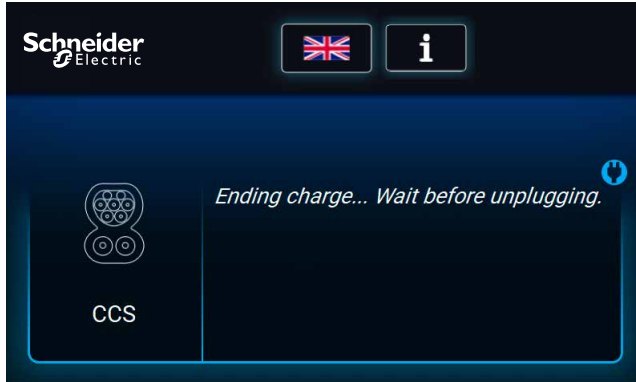

CHAdeMO

When the CHAdeMO protocol is used, the user must identify himself after unplugging his electrical vehicle.

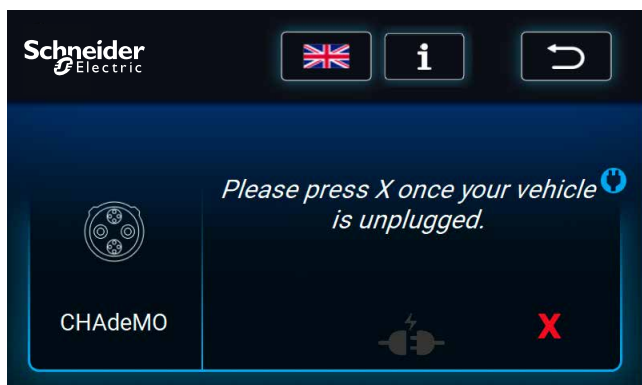
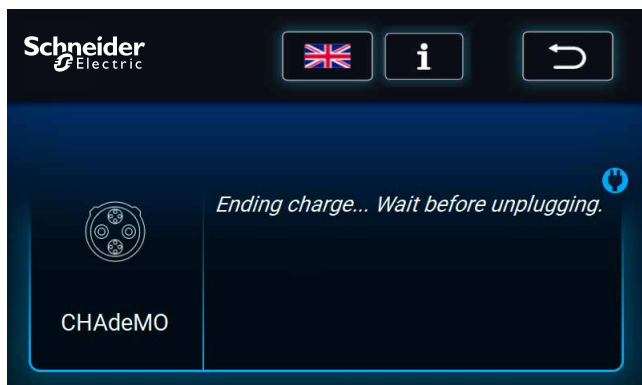

Others messages

Message	Description
Error connecting server. Booting interrupted ! Please call support.	Message displayed during the startup of the charging station if the backend server reject the connection.
Error connecting to RFID reader. Booting interrupted ! Please call support.	Message displayed during the startup of the charging station if the RFID module does not work. Please contact support.
Error connecting to Communication Control Unit. Booting interrupted ! Please call support.	Message displayed during the startup of the charging station if the CCU board does not work. Please contact support.
Error connecting to Power Unit. Booting interrupted ! Please call support.	Message displayed when charging station starts up if there is no internal communication. Please contact technical support.
Charger inoperative. Cannot charge here.	Charger inoperative. Backend server request charger does not accept charge
Charger inoperative. Please unplug your vehicle.	Charger inoperative. Backend server request charger does not accept charge. Unplug the vehicle.
Authorization failed! Please retry identifying.	User rejected by the backend server.
Charger offline. Set up to refuse offline charging.	Charger offline.
Error timeout. Please unplug your vehicle then identify.	Time out, user identified, unplug the vehicle before retrying to identifying.
Plug your vehicle to start charging. Vehicle not detected. Retrying... X	ChaDeMo only : User identified, waiting for electrical vehicle connection.
Error: Authorization failed. You cannot stop the charge session.	The charge cannot be interrupted by this user who is not recognized by the backend server.
To stop charging, use your RFID card or your application.	User wants to stop the charge. He should identify himself to be able to switch off the charge and disconnect his vehicle.
Charge done. Wrong RFID pass. Unplug your vehicle.	User not recognized by the backend server.. Charging terminated. Unplug the vehicle.
Charge done. Wrong RFID pass. Unplug your vehicle then identify to end your session.	ChaDeMo only : User not recognized by the backend server.. Charging terminated. Unplug the vehicle.
Station shut down. Please reboot.	Charging station shut down. Please contact support to restart the charging station.
Updating station... Charging not available.	Charging station is being updated. Please wait.
Error updating. DO NOT CHARGE HERE. Wait for correct update.	Error updating. Please contact support for updating the charging station.
Remote reset started... Station will reboot now.	Station is being rebooted.
Station rebooted. Please unplug your vehicle.	Only CCS : Station rebooted during a charge. Please unplug and retry to launch the charge.
Warning: insulation failure.	Cable insulation failed. Please contact support.

Errors

The error messages are displayed with a characteristic screen. They are thus easily identifiable by the user. A warning pictogram is displayed along with the error message as shown below.



The table below lists error messages that appear on the screen.

Error	Error resolution
Error occurred: 0x02 - 0X03 - 0X81 Emergency stop. Please unplug your vehicle and release the emergency button.	Emergency stop was initiated. Please unplug your vehicle and release the emergency button.
Error occurred: 0x02 - 0X03 - 0X81 Emergency stop. Please unplug your vehicle and release the emergency button.	Emergency stop was initiated. Please unplug your vehicle and release the emergency button.
Error occurred: 0x0A - 0x86 The charging station is overheating. Please unplug your vehicle and check that no air vent is clogged.	The charging station is overheating. Please unplug your vehicle and check that no air vent is clogged.
Error occurred: 0x0A - 0x86 The charging station is overheating. Please unplug your vehicle, identify and check that no air vent is clogged.	ChaDeMo only : The charging station is overheating. Please unplug your vehicle, identify and check that no air vent is clogged.
Error occurred: 0x51 The connection with the vehicle was lost. Please unplug your vehicle.	The connection with the vehicle was lost. Please unplug your vehicle.
Error occurred: 0x07 - 0x29 - 0x51 The connection with the vehicle was lost. Please unplug then identify.	ChaDeMo only : The connection with the vehicle was lost. Please unplug then identify.
Error occurred: 0x22 - 0x33 The connector cannot lock. Please keep the connector closely leant against your vehicle when plugging, until the charge has started. Please unplug your vehicle.	The connector cannot lock. Please keep the connector closely leant against your vehicle when plugging, until the charge has started. Please unplug your vehicle.
Error occurred: 0x22 The connector cannot lock. Please keep the connector closely leant against your vehicle when plugging, until the charge has started. Please unplug your vehicle then identify.	ChaDeMo only : The connector cannot lock. Please keep the connector closely leant against your vehicle when plugging, until the charge has started. Please unplug your vehicle then identify.
Error occurred: 0x3A Your battery model is incompatible with this charger. Please unplug your vehicle.	Your battery model is incompatible with this charger. Please unplug your vehicle.
Error occurred: 0x11 Your battery model is incompatible with this charger. Please unplug then identify.	ChaDeMo only : Your battery model is incompatible with this charger. Please unplug then identify.

Error	Error resolution
Error occurred: 0x32 Your gear is not in parking position. Please unplug your vehicle and engage gear in parking position.	Your gear is not in parking position. Please unplug your vehicle and engage gear in parking position.
Error occurred: 0x14 Your gear is not in parking position. Please unplug your vehicle, identify and engage gear in parking position.	ChaDeMo only : Your gear is not in parking position. Please unplug your vehicle, identify and engage gear in parking position.
Error occurred: 0x15 Your vehicle raised an error. Please check error message in the vehicle, unplug it then identify.	ChaDeMo only : Your vehicle raised an error. Please check error message in the vehicle, unplug it then identify.
Error occurred: 0x31 Your battery's temperature is too high. Please unplug your vehicle.	Your battery's temperature is too high. Please unplug your vehicle.
Error occurred: 0x19 Your battery's temperature is too high. Please unplug your vehicle then identify.	ChaDeMo only : Your battery's temperature is too high. Please unplug your vehicle then identify.
Error occurred: 0x46 Connection between screen and charger has been lost. Please unplug your vehicle.	Connection between HMI screen and charger has been lost. Please unplug your vehicle.
Error occurred: 0x46 Connection between screen and charger has been lost. Please unplug your vehicle then identify.	ChaDeMo only : Connection between HMI screen charger has been lost. Please unplug your vehicle then identify.
Error occurred: 0x-- Please unplug your vehicle.	For all other error codes, please refer to maintenance manual.
Error occurred: 0x-- Please unplug then identify to end your session.	ChaDeMo only : For all other error codes, please refer to maintenance manual.

8. Protecting the environment

Recycling Packaging

The packaging materials from this equipment can be recycled. Please help protect the environment by recycling them in appropriate containers. Thank you for playing your part in protecting the environment.

End-of-Life Recycling

Products in the EVlink DC fast charge range have been optimized to reduce the amount of waste produced at the end of their useful life and for better recovery of component parts and materials when following customary processing procedures. Products have been designed so that their components can be processed by conventional procedures: decontamination where this is recommended, reuse and/or dismantling in order to improve recycling performance, and crushing to separate out the rest of the materials.



MFR77342-EN-00

Schneider Electric Industries SAS

35, rue Joseph Monier
CS 30323
F - 92506 Rueil Malmaison Cedex

www.se.com

Due to possible changes in standards and equipment, the features described in this document in the form of text and images are subject to confirmation by Schneider Electric.

07-2020