

Display timer module

User Guide

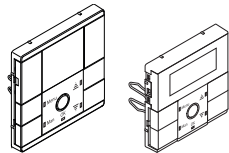

System M

Display timer module

Art. no. MEG5755-03../04..

System Design

Display timer module

Art. no. MEG5755-60..

Necessary accessories

- To be completed with:
- corresponding inserts (see function overview)
- Frame in corresponding design

For your safety

⚠ ⚠ DANGER

HAZARD OF ELECTRIC SHOCK, EXPLOSION, OR ARC FLASH

Safe electrical installation must be carried out only by skilled professionals. Skilled professionals must prove profound knowledge in the following areas:

- Connecting to installation networks
- Connecting several electrical devices
- Laying electric cables
- Safety standards, local wiring rules and regulations

Failure to follow these instructions will result in death or serious injury.

⚠ ⚠ DANGER

HAZARD OF ELECTRIC SHOCK

The PlusLink carries an electrical current and the outputs may carry an electrical current even when the device is switched off.

- Before working on the device or the loads, always disconnect the device from the supply via the upstream miniature circuit breaker.

If one or more PlusLink lines are separately fused in your installation then they are not electrically isolated from one another.

- In this case, you should use the PlusLink Expander.

Failure to follow these instructions will result in death or serious injury.

Notice

HAZARD OF EQUIPMENT DAMAGE

- Connect all connected devices of one or several PlusLink lines to the same phase or use a PlusLink Distributor for cross-phase installation.
- Ensure that the device is disconnected from its circuit during the insulation resistance test.

Failure to follow these instructions can damage the device.

Table of Content

Getting to know the display timer module	1
Connections, displays and operating elements	2
Mounting the module	2
Getting to know the basic functions	2
Getting to know the menu	3
Setting module: Basic menu settings	3
Setting module: Advanced menu	4
Notes on advanced functions	6
Operating the module	7
Blind control	7
Light control	8
Global blind and light scenes	8
Controlling loads from another location via PlusLink	8
What should I do if there is a problem?	8
Technical data	9

Getting to know the display timer module

In combination with different inserts, you can carry out various functions with the display timer module (referred to below as **module**), such as:

- switching, dimming and controlling blinds manually
- time-controlled switching and controlling of blinds

Product features:

- Simple operation using five push-buttons
- Adjustable date and time
- Number of switching cycles (switching on/off, raising/lowering):
 - **Switching, dimming, blind inserts:**
per channel: 2 switching cycles/day
 - **Central unit insert:**
per PL line: 2 switching cycles/day
- Switching times preset at the factory, but can be changed later
- Switching to manual mode possible
- Global control (max. 4 PL lines) and separate line control
- Saving scenes is possible
- Two global scenes can be retrieved via push-buttons
- Astro function (control by astronomical pre-calculation of sunrise and sunset)
- Adaptation of astro function using specific astro time shift
- Random function ranging from 0-30 minutes
- Evaluating DCF timer
- Automatic summer/winter time switchover
- Individually adjustable blind movement time
- Adjustable brightness threshold for sun protection function
- Adjustable response for wind alarm
- Adjustable display brightness
- Automatic deactivation of display lighting can be selected
- Power reserve of at least 6 hours in the event of a power failure
- Reset (restore default settings)

Overview of module functions on receiving inserts

Complete the module with the receiving inserts for switching, dimming or controlling blind/roller shutter in order to carry out **local** light and blind control.

Switching:

<ul style="list-style-type: none"> • Electronic switch insert • Relay switch insert 	<ul style="list-style-type: none"> • switching on/off manually • time-controlled switching on/off • evaluating DCF timer
<ul style="list-style-type: none"> • Electronic switch insert, 2-gang • Relay switch insert, 2-gang 	<ul style="list-style-type: none"> • manually switching on/off both channels together • time-controlled switching on/off of both channels separately or together • evaluating DCF timer

Dimming:

<ul style="list-style-type: none"> • Universal dimmer insert • Control insert 1-10 V • DALI insert 	<ul style="list-style-type: none"> • switching and dimming manually • time-controlled switching • evaluating DCF timer
<ul style="list-style-type: none"> • Universal dimmer insert, 2-gang 	<ul style="list-style-type: none"> • manually switching and dimming both channels at the same time • time-controlled switching of both channels separately or together • evaluating DCF timer

Controlling blinds/roller shutter:

<ul style="list-style-type: none"> • Blind control insert 	<ul style="list-style-type: none"> • raising/lowering manually • time-controlled raising/lowering • Sun protection function • Wind alarm function • disabling blind movement (with magnetic contact) • evaluating DCF timer
--	---

Function overview of the module on sending insert

Complete the module with the sending central unit insert in order to carry out **global** light and blind control via the **PlusLink (PL)**.

Global light and blind control:

<ul style="list-style-type: none"> • Central unit insert 	<ul style="list-style-type: none"> • manual control for all PL lines together: switching, dimming, lowering/raising (push-button function) or retrieving scenes (scene function) • time-controlled for all PL lines together or each PL line separately: switching, raising/lowering • evaluating DCF timer
---	--

Connections, displays and operating elements

Front:

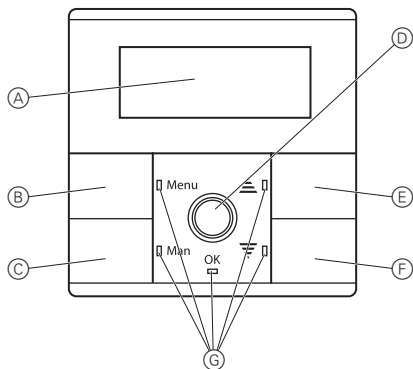

- (A) Display
 - (B) Menu button
 - (C) Manual push-button
 - (D) OK button
 - (E) UP arrow button
 - (F) DOWN arrow button
 - (G) LEDs
- Push-button function (factory setting): Raising/switching on
 - Scene function*: Scene 1
 - Push-button function (factory setting): Lowering/switching off
 - Scene function*: Scene 2

*Can only be selected as alternative in combination with a central unit insert.

Rear:

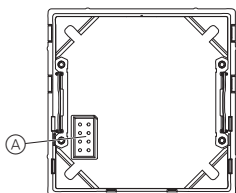

- (A) Module interface

Display elements

i The displayed symbols depend on the inserts used and the sensors connected via PlusLink.



Individual display elements

You will see the following symbols on the display:

	Time, value and information display
1 2 3 4 5 6 7	Display of the weekdays 1 = Monday to 7 = Sunday
AUTO	Automatic mode
AUTO	Astro function
AUTO	Random function
	<ul style="list-style-type: none"> • Status display with switched load: Light on or raising the blind • Switching times for raising/switching on

	<ul style="list-style-type: none"> • Status display with switched load: Lowering the blind • Switching times for lowering/switching off
	Setting the time
	Setting the day, month and year
2nd	Switching time 2
	Sun protection function activated, Setting the brightness threshold
	Wind alarm is executed, Setting the behaviour for wind alarm
	Switching between summer and winter time
	DCF timer is evaluated

Standard display

Example of the standard display during operation:

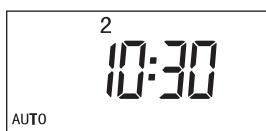

Mounting the module

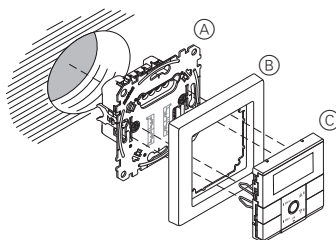

- (A) Insert (see function overview)
- (B) Frame
- (C) Display timer module

Initialising the module

After plugging the module onto the insert for the first time, information on the module type and module version are displayed for one second each. A standard display follows this, either with a flashing clock symbol or a DCF symbol.

Module type display: Display timer module



Standard display with flashing clock symbol

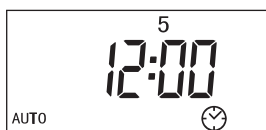

Set time and date (see Section "Setting module: Basic menu settings").

Standard display with DCF symbol

i The DCF timer is detected 5 minutes after connecting to the mains supply.



Time and date were received via a DCF timer.

Error message after changing over the module

If the module is plugged onto an insert that differs in functionality from the previous one, the error message "FAIL" appears and all LEDs flash red.

For initialisation, reset the module to the default settings.

i When you do a reset to the default settings, previously saved settings are lost! The set time and date are not reset.

- 1 Press the push-buttons and simultaneously for 10 seconds.

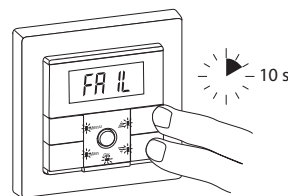

The standard display appears after resetting.

Getting to know the basic functions

i "Blind/roller shutter" will be referred to below as just "blind".

Switching times

The module has a program memory that contains standard switching times that can be changed anytime.

The switching times perform specific actions:

- Switching time : Raise blind, switch on light
- Switching time : Lower blind, switch off light

Both switching times together result in a switching cycle. You can combine weekdays to form a group. In that case the switching times apply to all the days in this group. A weekday group consists of 1-7 days. You can create up to 7 different groups. In the default settings, the working days (Monday - Friday) form a group, and the weekend (Saturday + Sunday) forms a group.

Module in combination with switchable/dimmable inserts

Two switching cycles per day are available for each channel.



Module in combination with a blind control insert

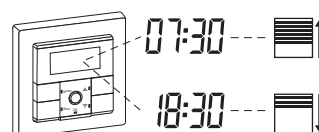

Module in combination with a central unit insert

Two switching cycles per day are available for each PL line.

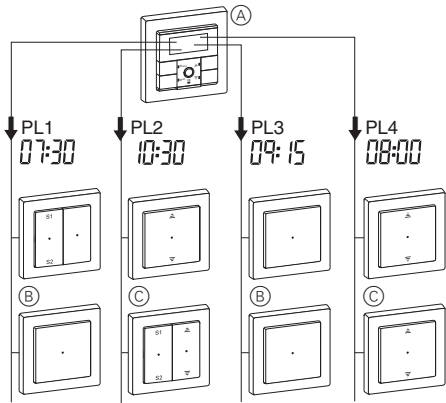

The standard switching times and weekday groups per channel or PL line are:

Weekday groups	Switching cycle	Switching times
Gr. 1 Monday - Friday (1-5)	1	07:30
		18:30
	2	--:--
		--:--
Gr. 2 Saturday - Sunday (6-7)	1	09:30
		22:00
	2	--:--
		--:--

Getting to know the menu

The module has two menu levels:

1. Menu level:

- Set time and date
- Set switching times

2. Menu level: Advanced menu

- Selecting arrow button function
- Save scenes
- Set astro time shift
- Activating/deactivating automatic summer/winter time switchover
- Set individual blind movement time
- Setting brightness threshold for sun protection function
- Setting the blind position for sun protection function
- Set response for wind alarm
- Set display brightness
- Set automatic deactivation of display lighting

The following push-buttons are used to operate the menu:

Push-button	Push button action	Action
Menu	short	• Skip submenu
	long (2 s)	• Open menu • Quit menu
	long (4 s)	• Open advanced menu
▲	short	• Increase values (+1) • Add/keep weekdays • Browse submenu
	press and hold	• Increase values cyclically (fast mode): +5: Astro time shift +10: Brightness threshold +15: Time/date data
▼	short	• Decrease values (-1) • Remove weekdays • Browse submenu
	press and hold	• Decrease values cyclically (fast mode): -5: Astro time shift -10: Brightness threshold -15: Time/date data
OK	short	• Save settings • go to next menu command

i With a long press of [Menu], the menu for setting the time and switching time appears after 2 s.

To open the advanced menu, hold the [Menu] push-button down.

i If you do not press any push-button in the menu for more than 2 minutes, the standard display appears. Changes that are not confirmed with [OK] are not saved.

Setting module: Basic menu settings

Set time and date

i When receiving a DCF time signal via PlusLink, the "Set time and date" menu is no longer displayed. Setting is done automatically (see "Notes on advanced functions" for more information).

Menu structure

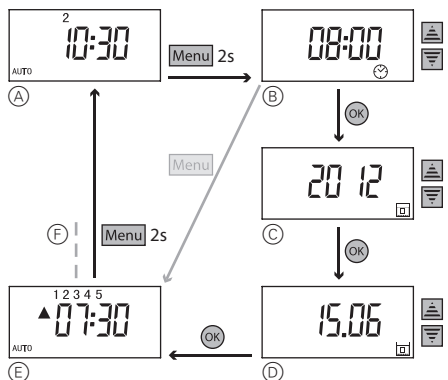

- (A) Standard display
- (B) Set the time
- (C) Set year
- (D) Set day and month
- (E) Set switching times
- (F) see "Set switching times"

Setting

① Open menu: Press [Menu] push-button for 2 s. The time display flashes.



② Set current time using ▲ or ▼ push-button.

③ Confirm setting with [OK].

The year display flashes.



④ Set current year using ▲ or ▼ push-button.

⑤ Confirm setting with [OK].

The day and month display flashes.



⑥ Set current day and month using ▲ or ▼ push-button.

⑦ Confirm setting with [OK].

The "Set switching times" display appears.

To quit the menu: Press [Menu] push-button for 2 s.

Set switching times

Menu structure

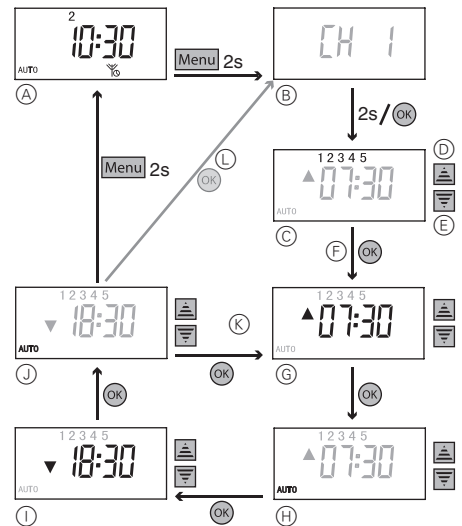

- (A) Standard display with DCF time signal
- (B) Display of the channel / the PL line
- (C) Select weekday (1st group)
- (D) ▲: Add day to group/keep day in group
- (E) ▼: Remove day from group
- (F) Set switching cycle 1
- (G) Set switching time
- (H) Select operating mode
- (I) Set switching time
- (J) Select operating mode
- (K) Set switching cycle 2
- (L) Setting switching times for further weekday groups

i In combination with a 2-gang insert you can set the switching times separately for each channel. The menu briefly displays the corresponding channel (CH 1/ CH 2) when it is started and every time the weekday group is changed.

In combination with a central unit insert you can set the switching times separately for each PL line. The menu briefly displays the corresponding PL line (PL 1-4) when it is started and every time the weekday group is changed.

Setting

① Open menu: Press **[Menu]** push-button for 2 s. If the module does not receive a DCF time signal via PlusLink, "Set time" will appear on the display. To set the switching time, briefly press the **[Menu]** push-button.

The first day of weekday group 1 flashes.

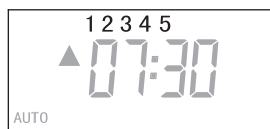

② Use push-button **▲** to add days to group individually/keep days in group or use push-button **▼** to remove from group.

③ Confirm setting with **[OK]**.

i Days removed from an existing group form a new group. You can create up to 7 weekday groups.

The time display flashes.

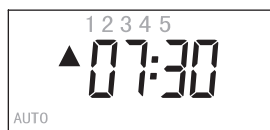

④ Set switching time **▲** with **▲** or **▼** push-button.

⑤ Confirm setting with **[OK]**.

i You can delete the switching time with the **[Man]** push-button. If you press the push-button again, the previously set switching time is displayed.

The operating mode display flashes.

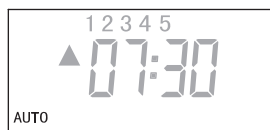

⑥ Select operating mode with push-button **▲** or **▼**.

AUTO	Automatic mode
AUTO ☀	Astro function (see "Notes on advanced functions")
AUTO 📺	Random function (see "Notes on advanced functions")

⑦ Confirm setting with **[OK]**.

The time display flashes.



⑧ Set switching time **▼** with **▲** or **▼** push-button.

⑨ Confirm setting with **[OK]**.

The operating mode display flashes.

⑩ Select operating mode with **▲** or **▼** push-button and confirm with **[OK]**.

The time display flashes.

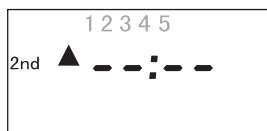

⑪ Set second switching time **▲** with **▲** or **▼** push-button.

⑫ Confirm setting with **[OK]**.

i If you press the **[Man]** push-button a switching time set previously appears.

The operating mode display flashes.

⑬ Select operating mode with **▲** or **▼** push-button and confirm with **[OK]**.

The first day of weekday group 2 flashes.

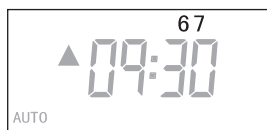

⑭ Press **▲** to add/keep individual days in the group or press **▼** to remove from group.

⑮ Confirm setting with **[OK]**.

The time display flashes.

Repeat the individual steps for setting the switching time (see weekday group 1).

Setting module: Advanced menu

The possible settings in the advanced menu depend on the respective insert (see overview of functions).

Structure of the advanced menu

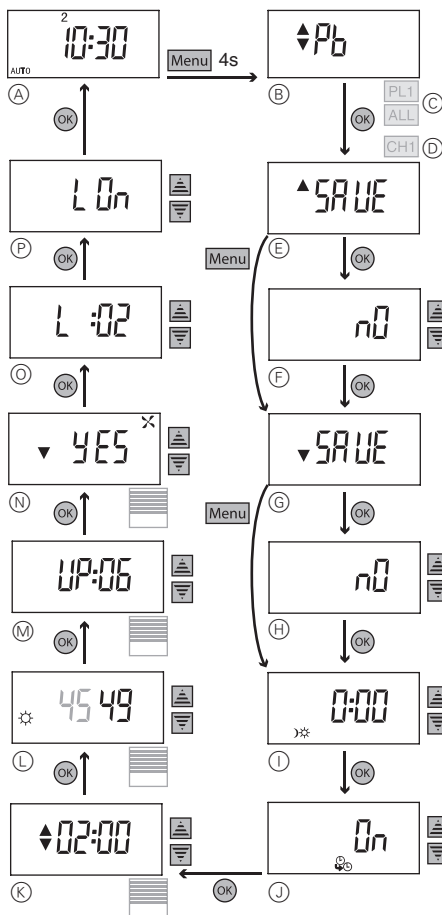

- Ⓐ Standard display **only in combination with a central unit insert**
- Ⓑ Selecting arrow button function
- Ⓒ Display of PL line / ALL (separate scenes for PL lines / then global scenes for all PL lines together can be set)
- only in combination with switchable/dimmable inserts**
- Ⓓ Channel display (scenes can be set separately for two channels)
- Ⓔ Scene 1
- Ⓕ Save scene 1
- Ⓖ Scene 2
- Ⓗ Save scene 2
- Ⓘ Set astro time shift
- Ⓙ Activate/deactivate automatic summer/winter time switchover (not possible when receiving DCF time signal via PL)
- only in combination with a blind control insert**
- Ⓚ Setting individual blind movement time
- Ⓛ Setting brightness threshold for sun protection function
- Ⓜ Setting the blind position for sun protection function
- Ⓝ Set response for wind alarm
- Ⓞ Set display brightness
- Ⓟ Set automatic deactivation of display lighting

Selecting arrow button function

(Only in combination with a central unit insert)

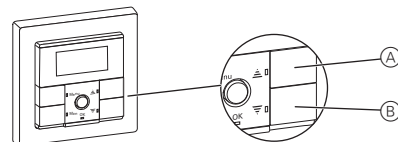

Push-button function / Pb	Scene function / SCn
Ⓐ Raise blind / switch on light	Scene 1
Ⓑ Lower blind / switch off light	Scene 2

If the push-button function has been preset at the factory, you can use the arrow buttons to move the blinds up and down or turn the light on and off. Alternatively, you can use a central unit insert to retrieve scenes via the arrow buttons. You can individually save one scene per arrow button (see "Save scenes"). In order to do this switch the configuration of the arrow buttons from push-button function to the scene function.

① Open advanced menu: Press **[Menu]** push-button for 4 s.

The display for the arrow button function appears.

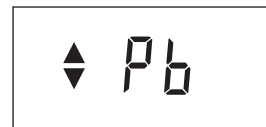

② Select function with push-button **▲** or **▼**.



③ Confirm setting with **[OK]**.

i Configuration of the arrow buttons with scene function applies in automatic mode and in manual mode.

Save scenes

The module allows you to save two scenes that are activated by switching times.

In addition to this, you can save two global scenes (PL 1-4) that can be retrieved with the arrow buttons. These global scenes are only possible in combination with a central unit insert and the respective scene function selected for the arrow buttons. (See "Selecting arrow button function")

i Display of the corresponding channel (CH 1/ CH 2), of the corresponding PL line (PL 1-4) and all PL lines (ALL)

- In combination with a 2-gang insert you can set two scenes separately for each channel. The menu briefly displays the corresponding channel (CH 1/ CH 2) when it is started and every time the weekday group is changed.
- In combination with a central unit insert you can set two scenes separately for each PL line. The menu briefly displays the corresponding PL line (PL 1-4) when it is started and every time the weekday group is changed.
- In combination with a central unit insert and the scene function for the arrow buttons you can set two global scenes for all PL lines. The menu briefly displays "ALL".

- 1 Set brightness of lamps, and desired position of blind (any values possible) with push-button **■** or **▼**.

i **Saving blind scenes:**
Raise blind to the uppermost position and wait for 2 minutes (running time) until the status display **■** disappears from the display. Then set the desired position of the blind.

- 2 Open advanced menu: Press **[Menu]** push-button for 4 s.

Scene 1 display appears.

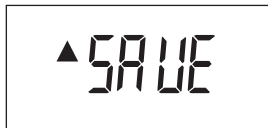

- 3 Confirm setting with **[OK]**.
The "no" display appears.



- 4 Select save option ("yes") with push-button **■** or **▼**.



- 5 Confirm setting with **[OK]**.

- Light scene: All lamps are switched off briefly and then back on again to indicate that the saving procedure has been successful. Then the lamps adopt the saved brightness value.
- Blind scene: The blinds are lowered and raised by one step to indicate that the saving procedure was successful.

Scene 2 display appears.

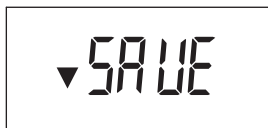

Repeat the individual steps of scene 1.

Setting the astro time shift

(More information in "Notes on advanced functions")

- 1 Open advanced menu: Press **[Menu]** push-button for 4 s.
- 2 Press **[Menu]** push-button repeatedly until the following display appears.

The time display for astro time shift flashes.



- 3 Set astro time shift (max. ± 2 hours) with **■** or **▼** push-button.
- 4 Confirm setting with **[OK]**.

The following table tells you by how many minutes your local time deviates from standard time (Central European Time CET). This deviation represents your astro time shift.

City	Degree of longitude (approx.)	Astro time shift
Warsaw	21° east	+24 Min
Budapest	19° east	+16 Min
Vienna	16° 30' east	+6 Min
Goerlitz	15° east	0 Min
Berlin	13° 30' east	-6 Min
Munich	11° 30' east	-14 Min
Schwerin	11° 30' east	-14 Min
Hamburg	10° east	-20 Min
Frankfurt/Main	8° 45' east	-25 Min
Cologne	6° 57' east	-32 Min
Aachen	6° east	-36 Min
Amsterdam	5° east	-40 Min
Brussels	4° 20' east	-43 Min
Paris	2° 20' east	-50 Min
Madrid	3° 35' west	-74 Min

Activating/deactivating automatic summer/winter time switchover

(Not possible if DCF signal was sent via PL, see "Notes on advanced functions")

- 1 Open advanced menu: Press **[Menu]** push-button for 4 s.
- 2 Press **[Menu]** push-button repeatedly until the following display appears.

"On" flashes.



- 3 Use the **■** or **▼** push-button to select between "On" (switchover activated) and "Off" (switchover deactivated).
- 4 Confirm setting with **[OK]**.

Additional settings for blind control

If the module is combined with a blind control insert, further functions are available (for more information see "Notes on advanced functions")

Setting individual blind movement time

- 1 Open advanced menu: Press **[Menu]** push-button for 4 s.
- 2 Press **[Menu]** push-button repeatedly until the following display appears.

The time display for the individual blind movement time flashes.



- 3 Set the movement time (30 seconds to 3 minutes) with push-button **■** or **▼**.
- 4 Confirm setting with **[OK]**.

Setting brightness threshold for sun protection function

(Only in combination with blind control insert, brightness sensor interface flush-mounted and sun/twilight sensor)

- 1 Open advanced menu: Press **[Menu]** push-button for 4 s.
- 2 Press **[Menu]** push-button repeatedly until the following display appears.

The brightness threshold (right-hand value) flashes. The left-hand value shows the currently measured brightness.



- 3 Set the brightness threshold on a scale from 00 (dark) to 99 (bright) with push-button **■** or **▼**.
- 4 Confirm setting with **[OK]**.

Setting the blind position for sun protection function

- 1 Open advanced menu: Press **[Menu]** push-button for 4 s.
- 2 Press **[Menu]** push-button repeatedly until the following display appears.

The time taken for the blind to move up is displayed in seconds in order to completely release the sensor (here default setting):



- 3 Set the blind position on a scale from 2 (raise fast) to 16 (raise slow) with push-button **■** or **▼**.
- 4 Confirm setting with **[OK]**.

Setting the behaviour for wind alarm

(Only in combination with blind control insert, brightness sensor with wind sensor interface and DCF and wind sensor)

- Open advanced menu: Press **[Menu]** push-button for 4 s.
- Press **[Menu]** push-button repeatedly until the following display appears.

The display "Lower in the event of wind alarm" flashes.

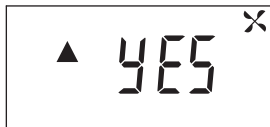

- Set the behaviour of the blind in the event of wind alarm using the **■** push-button or the **▼** push-button.

- YES Blind is raised in the event of wind alarm (standard setting).
- nO Blind does not react to wind alarm.
- ▼** YES Blind is lowered in the event of wind alarm.

- Confirm setting with **[OK]**.

Display settings

Setting display brightness

- Open advanced menu: Press **[Menu]** push-button for 4 s.
- Press **[Menu]** push-button repeatedly until the following display appears.

The display brightness display flashes.

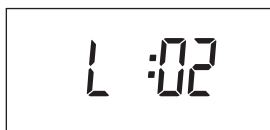

- Set the display brightness on a scale from 00 (off) to 04 (bright) with the **■** or **▼** push-button.
- Confirm setting with **[OK]**.

Set automatic deactivation of display lighting

(The setting option is not shown if the display brightness is set to "0".)

- Open advanced menu: Press **[Menu]** push-button for 4 s.
- Press **[Menu]** push-button repeatedly until the following display appears.

The current setting appears (here default setting: Display lighting is on permanently):



- Change setting with push-button **■** or **▼**.



- LOn: Display lighting is on permanently.
- Lt: Display lighting switches off automatically 10 seconds after the last input.

- Confirm setting with **[OK]**.

Notes on advanced functions

Astro function

In addition to setting switching times, you can adjust the lowering/raising behaviour of your blind and the switching on/off behaviour of your lighting to actual sunrise/sunset using the **Astro function**. For this purpose the module contains an integrated astronomical calendar that calculates the sunrise and sunset for every day of the year.

i The following explanations apply to Central European Time (CET). In the case of Central European Summer Time (CEST) the Astro curves vary by +/- 1h. This is automatically taken into account by the module.

You can activate the astro function separately for each switching time (see "Set switching times").

If the activated astro function has calculated that it will still be dark outside at the set switching time (e.g. "Raise blind at 6:30 a.m."), it will not raise the blind until the sun rises.

Likewise, the blind will be lowered at sunset, if the activated astro function has calculated that it will be dark before the set switching time (e.g. "Lower blind at 7:10 p.m."). The lighting behaviour is identical.

Other switching times set for daylight hours are not affected by the astro function.

Astro function - application examples

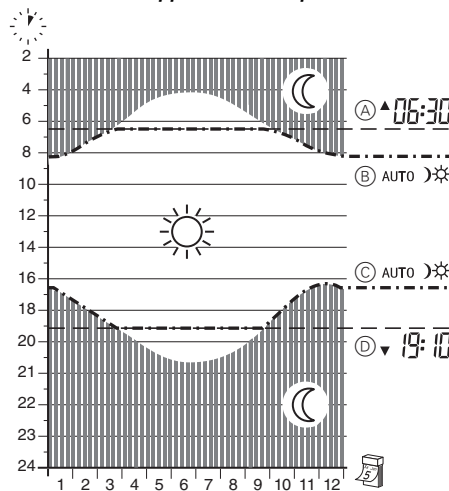

- (A) Set UP time 6:30 a.m.
- (B) Executed UP time
- (C) Executed DOWN time
- (D) Set DOWN time 7:10 p.m.

Example 1:

You want the blind to be raised at sunrise and lowered at sunset each day.

- Switching time **■**: Monday - Sunday 4:00 a.m., astro function activated.
- Switching time **▼**: Monday - Sunday 10:30 p.m., astro function activated.

Example 2:

You want the lighting (e.g. outside lights) to be switched off each day at sunrise and to be switched on each night at sunset.

- Switching time **▼**: Monday - Sunday 4:00 a.m., astro function activated.
- Switching time **■**: Monday - Sunday 10:30 p.m., astro function activated.

i If you want to control the blind and lighting with the astro function only, you must be sure to set the switching times for a time in which it is guaranteed to be dark outside.

Example 3:

You want the blind to be raised each morning at sunrise, yet not before 6:30 a.m. At night you want the blind to be lowered no later than 7:10 p.m. or at sunset, if sunset is before 7:10 p.m.

- Switching time **■**: Monday - Sunday 6:30 a.m., astro function activated.
- Switching time **▼**: Monday - Sunday 7:10 p.m., astro function activated.

When it is still dark outside at 6:30 a.m., the astro function intervenes, and the blind is only raised at the actual time of sunrise. If it is already dark before 7:10 p.m., the astro function causes the blind to be lowered earlier, at the actual time of sunset.

However, when the actual time of sunrise is before 6:30 a.m. the astro function will **not** intervene, and the blind is raised at 6.30 a.m. If it is still light at 7:10 p.m., the astro function will **not** intervene, and the blind is lowered at 7:10 p.m.

Astro time shift

The integrated astronomical calendar is designed for the centre of the Central European Time (CET) zone. The astro time shift takes into account the actual times of sunrise and sunset at different locations. You can adapt the astro function with astro time shift to the specific location and correct the astro times calculated by the module by max. ±2 hours (see "Setting the astro time shift").

Example of blind control:

Set -32 minutes for the location Cologne. This has the consequence that the blinds are lowered in accordance with the later sunset time (32 minutes later than Görlitz).

Random function

This enables you to give any external observer the impression that you are at home. The random function uses an integrated random generator to vary the times you set by between 0 minutes and 30 minutes every day.

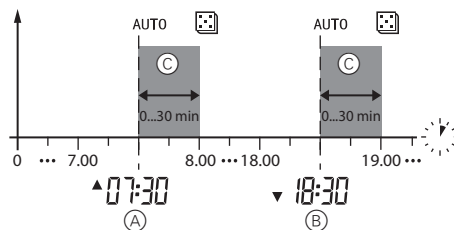

- (A) Set UP time 7:30 a.m.
- (B) Set DOWN time 6:30 p.m.
- (C) Random range 0-30 minutes

You can activate the random function separately for each switching time (see "Set switching times").

Additional functions for blind control

Individual blind movement time

The module is preset at the factory so that the blind takes 2 min. to be lowered (and, where necessary, stops automatically when the lower limit position is reached). You can adjust this time freely between 30 seconds and 3 minutes. This means scenes can be performed faster. (see "Setting individual blind movement time").

Sun protection function

The sun protection function is activated as soon as the brightness at the window measured by the sun/twilight sensor exceeds the set limit value for 2 minutes. The blind is lowered to below the sensor and moves back up again for the movement time set. The time the blind moves back up needs to be set so that the blind stops just above the sensor. If the measured brightness falls below the limit value for 15 minutes, the blind is raised again.

The brightness limit value and the raising time can be set in the advanced menu of the module (see "Setting the brightness threshold for sun protection function" and "Setting the blind position for sun protection function").

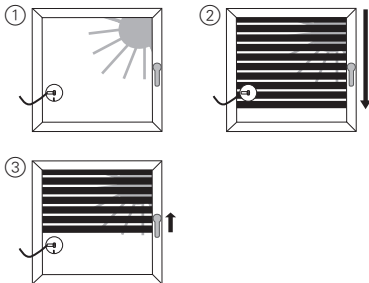

1. The sun/twilight sensor measures the brightness. The limit value is exceeded.
2. The blind is lowered. The sensor is now in the shade, the blind stops below the sensor.
3. Blind is raised for the duration set and stops above the sensor.



Manual operation of the module deactivates the sun protection function. The sun symbol is not visible on the display.

The sun protection function is only active when the blind is completely raised.

Disabling blind movement with magnetic contact

(Only in combination with blind control insert, brightness sensor interface flush-mounted and magnetic contact)

Raising/lowering the blind via PlusLink commands or via switching times of the display timer module is disabled by a magnetic contact when the window or door is open.

Manual operation is still possible with the and push-buttons.

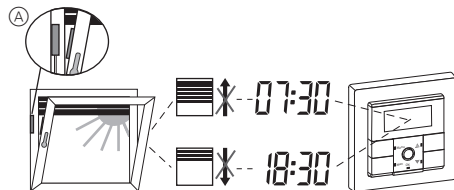

A Magnetic contact



CAUTION Risk of burglary!

Please bear in mind that the blind will not close while the window/door is open when using the magnetic contact.

Wind alarm

In order to protect blinds or awnings from damage caused by strong wind, you can set a blind behaviour for wind alarm.

As soon as the wind speed set on the wind sensor has been steadily exceeded for a period of at least 15 seconds, the blind reacts according to the set behaviour (see "Setting the behaviour for wind alarm"). There are three possible settings:

- Blind is lowered in the event of wind alarm (standard setting).
- Blind is raised in the event of wind alarm.
- Blind does not react to wind alarm.

During this time and until the wind speed drops, lowering and raising the blind via PL or module switching times is disabled. Manual operation is still possible with the and push-buttons. The blind is not automatically lowered or raised after the wind alarm is over.

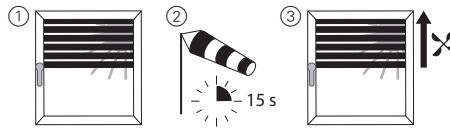

1. Blind is partially lowered.
2. The wind is increasing and exceeds the limit value. After 15 s the sensor interface triggers a wind alarm via the PL.
3. The blind behaves according to its settings.

Evaluating DCF timer

(Only in combination with brightness sensor with wind sensor interface and DCF)

The module can receive a DCF time signal via a sensor interface connected to the PlusLink. The DCF time signal is sent to the module via PL once a day (approx. at 2 o'clock in the morning). The module uses this to automatically set the current date and time.

With the DCF time signal the changeover from summer to winter time occurs automatically.

Response to mains voltage failure and recovery / power reserve

In the event of mains voltage failure the display goes out. The following menu settings are saved permanently:

- Switching times
- Arrow button function
- Scenes
- Blind position for the sun protection function
- Display settings
- Operating mode

The set time and date are saved for at least 6 hours thanks to the power reserve (no batteries required).

After mains voltage recovery the next switching time is carried out. Missed switching times are not carried out.

Operating the module

Deactivate the time and PlusLink control

Press the **[Man]** push-button to switch the module to manual mode and deactivate the control via set switching times and via PlusLink commands. Loads can then only be controlled manually with the and push-buttons.



Exceptions:

- The panic scene is being executed.
- In combination with a blind control insert, the module reacts to sensor values via PlusLink and controls the blind accordingly.

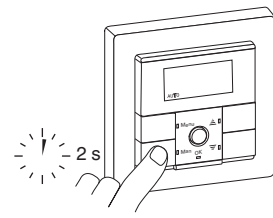

To switch back, press the **[Man]** push-button for 2 s.

After switching to manual mode, "Auto" disappears from the display and the LED next to the **[Man]** push-button lights up red.

Basic functions

Status LEDs for the module

Operation	Status feedback
	<ul style="list-style-type: none"> – green LED briefly lights up upon actuation – Arrow symbol appears when load is activated (light on / blind is raised)
	<ul style="list-style-type: none"> – green LED briefly lights up upon actuation – Arrow symbol appears when load is activated (blind is lowered)

Resetting to default settings

Operation	Status feedback
	all LEDs briefly flash red and all display symbols appear

Blind control

Controlling blinds

- raising/lowering (> 0.5 s)
- up/down in steps (< 0.5 s)

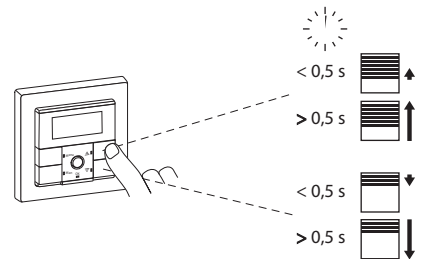

Global blind control

i Global control via PlusLink is possible in combination with the central unit insert and the display timer module.

Example of global raising/lowering and gradual up/down of 1-4 PL lines

Following activation of the push-buttons **■** and **▼** of the module on the central unit insert, all loads in the PL lines are controlled together.

Arrow buttons with push-button function:

- Long push-button action (> 0.5 s): raising/lowering
- Short push-button action (< 0.5 s): up/down gradually

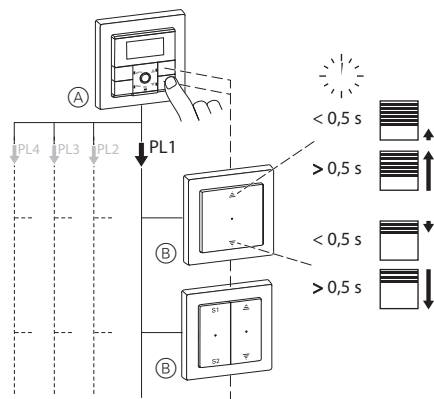

(A) Module on central unit insert

(B) Blind control insert

Light control

Switching load on/off

In combination with 1-gang / 2-gang insert

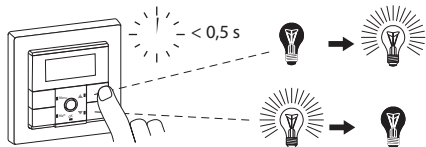

i In combination with a 2-gang insert both channels are switched together.

Display of the status arrow in the display only refers to channel 1.

Dimming load

In combination with 1-gang / 2-gang insert

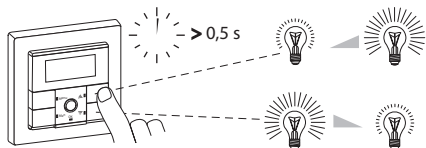

i In combination with a 2-gang insert both channels are dimmed together.

Display of the status arrow only refers to channel 1.

Global light control

i Global control via PlusLink is possible in combination with the central unit insert and the display timer module.

Example of globally switching on/off and dimming the 1-4 PL lines

Following activation of the push-buttons **■** and **▼** of the module on the central unit insert, all loads in the PL lines are controlled together:

Arrow buttons with push-button function

- Short push-button action (< 0.5 s): turn on/off
- Long push-button action (> 0.5 s): dimming

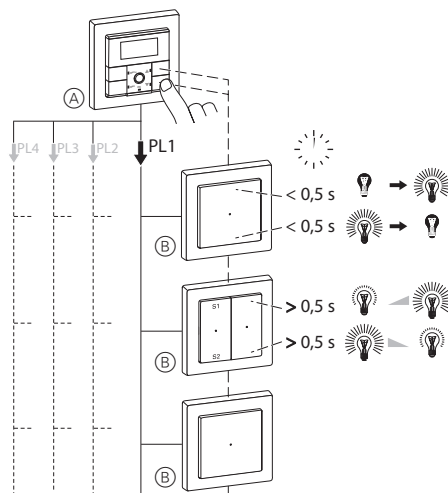

(A) Module on central unit insert

(B) Inserts for switching and dimming (see function overview)

Global blind and light scenes

i Global scenes are possible via the arrow buttons in combination with the central unit insert and the display timer module.

Arrow buttons with scene function:

- Short push-button action (< 0.5 s): Retrieve scene 1/2



▲ Retrieve scene 1

▼ Retrieve scene 2

Controlling loads from another location via PlusLink

- Central unit insert or side controller Plus, 1-gang/2-gang: switching, dimming, controlling blinds and retrieving scenes
- Mechanical push-button/double push-button
- Sensor interface + sensors

What should I do if there is a problem?

"FAIL" flashes on the display, all LEDs flash red.

- Module was plugged onto an insert that differs in functionality from the previous one.
 - Reset module to default settings.

The blind or lighting does not react to a set switching time.

- PlusLink commands deactivate the switching times.
 - The panic scene is being executed.
 - Wind alarm is active.
 - Window / door with magnetic contact is open.
 - Sun/twilight sensor is performing sun protection function.
 - All other PlusLink commands and switching times are performed when levels 1 - 4 are not carried out.
- The module is in manual mode.

While the astro function is activated, the blind and the lighting activities deviate significantly from the actual times of sunrise or sunset.

- Date/time settings and astro time shift are not set correctly.
- Switching between summer/winter time is not activated.

The sun protection function is not performed.

- The brightness threshold is set too high.
 - Reduce brightness threshold in advanced menu.
- Blind is not in the top limit position. Any manual actuation deactivates the sun protection function.
 - Bring blind into top position with a long push of the button and wait for max. 2 min. (running time).
- Wind alarm is active and disables lowering of the blind. The wind symbol is shown on the display.
 - Await wind alarm.
- The sun/twilight sensor is in the shade and cannot detect sunlight.
 - Install sun/twilight sensor on the window in such a way that sunlight is reliably detected.
 - Raise the blind position for the sun protection function in the advanced menu.
- The window / door is open. The magnetic contact disables lowering of the blind.
 - Close window / door.
- The panic scene is being executed.
- The module is in manual mode.

When the window / door with magnetic contact is open, the blind moves up or down.

- Wind alarm is active, causing the blind to be raised to top position.
 - Await wind alarm.
 - Change the blind's behaviour for wind alarm in the menu.

Technical data

Number of switching cycles (switching on/off, raising/lowering):

Switching, dimming, blind inserts:	per channel: 2 switching cycles / day
Central unit insert:	per PL line: 2 switching cycles / day

Functions

Drift:	< 1 s / day
Power reserve:	> 6 hours (no battery required)
Connectable random generator:	0-30 minutes
Astro function	
Astro time shift:	±2 hours
Standard blind movement time:	2 minutes

Display elements:

- 5 LED
- LCD display

Operating elements:

- Menu push-button
- Manual push-button
- OK push-button
- arrow push-button UP ■
- arrow push-button DOWN ▼

Connection: module interface with 8 contact pins



Dispose of the device separately from household waste at an official collection point. Professional recycling protects people and the environment against potential negative effects.

Merten GmbH

Fritz-Kotz-Str. 8
51674 Wiehl - Germany
se.com/contact

Schneider
Electric