



Linergy

Catalog 2024
Distribution and Connection Systems

se.com

Life Is On

Schneider
Electric

General contents

Linery distribution and connection systems

Presentation

Linery Products Presentation
Index of References

A

Linery distribution systems

Distribution blocks

B

Device feeders

C

Power busbars

D

Hot plug busbar system

E

Linery connection systems

Terminal blocks and bars

F

Index of Commercial References With Description

Com. no.	Description	Page
1...		
14811	1P comb busbar 27mm spacing	C-4
14812	2P comb busbar 27mm spacing	C-4
14813	3P comb busbar 27mm spacing	C-4
14814	4P comb busbar 27mm spacing	C-4
14818	End caps and tooth caps	C-4
2...		
21089	Comb busbar 1P and n 48poles	C-7
21093	Comb busbar 3P and n 48poles	C-7
21094	40 End covers/comb busbar 1P and n	C-7
21095	40 End covers/comb busbar 3P and n	C-7
21096	12 Tooth-caps 3Poles	C-7
21098	4 Connectors 25mm ²	C-7
21501	Comb busbar ph and n 12Poles	C-7
21503	Comb busbar ph and n 24Poles	C-7
21505	Comb busbar 3P and n 12Poles	C-7
21507	Comb busbar 3P and n 24Poles	C-7
A...		
A9N21035	Comb busbar 1P-n 63a 56mod.	C-8
A9N21036	Comb busbar 3P-n repart. 63a 56mod.	C-8
A9N21037	Comb busbar 1P-n Vigi 63a 56mod.	C-8
A9N21038	Comb busbar 3P-n Vigi repart. 63a 56mod.	C-8
A9N21039	Set of 20 end caps 1P-n	C-8
A9N21040	Set of 20 end caps 3P-n	C-8
A9N21041	Set of 10 phase connectors	C-8
A9N21042	Set of 10 neutral connectors	C-8
A9N21050	Set of 10 tooth caps	C-8
A9XAH157	Acti 9 comb busbar AUX1P 100A 57 modules	C-5
A9XAH257	Acti 9 comb busbar aux2P 100A 57 modules	C-5
A9XAH357	Acti 9 comb busbar aux3P 100A 57 modules	C-5
A9XAH457	Comb busbar aux4P 100A 57mod.	C-5
A9XAH557	Comb busbar aux5P 100A 57mod.	C-5
A9XAH657	Comb busbar aux3P repart. 100A 57mod.	C-5
A9XPCD04	Acti 9 set of 4 connectors	C-5, C-6
A9XPC812	Clario iC40 FI comb, 3P+N, 12 modules, left power supply	C-7
A9XPC848	Clario iC40 - comb rail FI, 3P+N, 48 modules, left	C-7
A9XPC948	Comb busbar 48 modules C60 clarío right	C-7
A9XPCM04	Acti 9 set of 4 connectors	C-5, C-6
A9XPE110	Acti 9 set of 10 end caps 1P	C-5
A9XPE210	Acti 9 set of 10 end caps 2P	C-5
A9XPE310	Acti 9 set of 10 end caps 3P	C-5
A9XPE410	Acti 9 set of 10 end caps 4P	C-5

Com. no.	Description	Page
A9XPH106	Acti 9 comb busbar 1P 100A 6 modules	C-5
A9XPH112	Acti 9 comb busbar 1P 100A 12 modules	C-5
A9XPH124	Acti 9 comb busbar 1P 100A 24 modules	C-5
A9XPH157	Acti 9 comb busbar 1P 100A 57 modules	C-5
A9XPH212	Acti 9 comb busbar 2P 100A 12 modules	C-5
A9XPH224	Acti 9 comb busbar 2P 100A 24 modules	C-5
A9XPH257	Acti 9 comb busbar 2P 100A 57 modules	C-5
A9XPH312	Acti 9 comb busbar 3P 100A 12 modules	C-5
A9XPH324	Acti 9 comb busbar 3P 100A 24 modules	C-5
A9XPH357	Acti9 - comb busbar - 1L - 18 mm pitch - 12 modules	C-5
A9XPH412	Acti9 comb busbar 4p 100a 12 modules	C-5
A9XPH424	Acti9 comb busbar 4p 100a 24 modules	C-5
A9XPH457	Acti9 comb busbar 4p 100a 57 modules	C-5
A9XPH512	Acti9 comb busbar 4p repart. 100a 12 m	C-5
A9XPH518	Acti9 comb busbar 4p repart. 100a 18 m	C-5
A9XPH524	Acti9 comb busbar 4p repart. 100a 24 m	C-5
A9XPH557	Acti9 comb busbar 4p repart. 100a 57 m	C-5
A9XPM112	Acti9 comb busbar 4p repart. 100a 57 m	C-6
A9XPM312	Comb busbar 2p 100a 12mod.	C-6
A9XPT920	Set of 20 tooth caps	C-5, C-6
AK5PA211N1	Set of 20 tooth caps	E-4
AK5PA211N2	Set of 20 tooth caps	E-4
AK5PA211N3	Set of 20 tooth caps	E-4
AK5PA211PH12	Set of 20 tooth caps	E-4
AK5PA211PH13	Set of 20 tooth caps	E-4
AK5PA211PH23	Set of 20 tooth caps	E-4
AK5PA212N1	Set of 20 tooth caps	E-4
AK5PA212N2	Set of 20 tooth caps	E-4
AK5PA212N3	Set of 20 tooth caps	E-4
AK5PA231	Set of 20 tooth caps	E-4
AK5PA232	Set of 20 tooth caps	E-4
AK5PA232S	Set of 20 tooth caps	E-4
AK5PA241	Set of 20 tooth caps	E-4
AK5PA242	Set of 20 tooth caps	E-4
AK5PA532	Set of 20 tooth caps	E-4
AK5PA542	Set of 20 tooth caps	E-4
AK5PA2311	Set of 20 tooth caps	E-4
AK5PA2312	Set of 20 tooth caps	E-4
AK5PA2312S	Set of 20 tooth caps	E-4

Index of Commercial References With Description

Com. no.	Description	Page
AK5PA5312	Set of 20 tooth caps	E-4
AK5PC12	Set of 20 tooth caps	E-4
AK5PC12PH	Set of 20 tooth caps	E-4
AK5PC13	Set of 20 tooth caps	E-4
AK5PC14	Set of 20 tooth caps	E-4
AK5PC32L	Set of 20 tooth caps	E-4
AK5PC32LPH	Set of 20 tooth caps	E-4
AK5PC33	Set of 20 tooth caps	E-4
AK5PC33L	Set of 20 tooth caps	E-4
AK5PC34	Set of 20 tooth caps	E-4
AK5PC34L	Set of 20 tooth caps	E-4
AK5PC131	Set of 20 tooth caps	E-4
AK5PC331	Set of 20 tooth caps	E-4
AM1DL201	Set of 20 tooth caps	E-4
AZ5CE005	Cable ends, Lineryg TR cable ends	F-64
AZ5CE005D	Cable ends, Lineryg TR cable ends	F-64
AZ5CE007	Pack of cable end 075 mm ²	F-64
AZ5CE007D	Cable ends, Lineryg TR cable ends	F-64
AZ5CE010	Cable ends, Lineryg TR cable ends	F-64
AZ5CE010D	Pack of cable end 1 mm ²	F-64
AZ5CE015	Cable ends, Lineryg TR cable ends	F-64
AZ5CE015D	Cable ends, Lineryg TR cable ends	F-64
AZ5CE025	Cable ends, Lineryg TR cable ends	F-64
AZ5CE025D	Cable ends, Lineryg TR cable ends	F-64
AZ5DE005	Cable end, Lineryg TR cable ends	F-65
AZ5DE007	Cable end, Lineryg TR cable ends	F-65
AZ5DE007D	Cable end, Lineryg TR cable ends	F-65
AZ5DE010	Cable end, Lineryg TR cable ends	F-65
AZ5DE010D	Cable end, Lineryg TR cable ends	F-65
AZ5DE015	Cable end, Lineryg TR cable ends	F-65
AZ5DE015D	Cable end, Lineryg TR cable ends	F-65
AZ5DE025	Cable end, Lineryg TR cable ends	F-65
AZ5DE025D	Cable end, Lineryg TR cable ends	F-65
AZ5DE0071	Cable end, Lineryg TR cable ends	F-65
AZ5DE0101	Cable end, Lineryg TR cable ends	F-65
AZ5DE0151	Cable end, Lineryg TR cable ends	F-65
AZ5DE0255	Cable end, Lineryg TR cable ends	F-65
D...		
DZ5CA002	Cable end, Lineryg TR cable ends	F-65
DZ5CA003	Cable ends	F-65
DZ5CA005	Cable end 0,5	F-65
DZ5CA005D	Cable ends	F-65
DZ5CA007	Cable end insulated markable, 0,75mm ² , m	F-65
DZ5CA007D	Cable end, Lineryg TR cable ends	F-65
DZ5CA010	Cable end insulated markable, 1mm ² , medi	F-65
DZ5CA010D	Insulate cable end 1 mm ² DIN	F-65
DZ5CA015	Cable ends	F-65
DZ5CA015D	Cable end, Lineryg TR cable ends	F-65

Com. no.	Description	Page
DZ5CA025	Cable end insulated markable, 2,5mm ² , me	F-65
DZ5CA025D	Cable end, Lineryg TR cable ends	F-65
DZ5CA042	Cable end insulated for clip-in marker,	F-65
DZ5CA042D	Insulate cable end 4 mm ² DIN	F-65
DZ5CA043	Cable end, Lineryg TR cable ends	F-65
DZ5CA062	Cable end insulated for clip-in marker,	F-65
DZ5CA062D	Cable end, Lineryg TR cable ends	F-65
DZ5CA063	Cable end, Lineryg TR cable ends	F-65
DZ5CA102	Cable end insulated for clip-in marker,	F-65
DZ5CA102D	Cable end, Lineryg TR cable ends	F-65
DZ5CA103	Cable end, Lineryg TR cable ends	F-65
DZ5CA103D	Insulate cable end 10 mm ² DIN	F-65
DZ5CA162	Cable end insulated for clip-in marker,	F-65
DZ5CA162D	Insulate cable end 16 DIN	F-65
DZ5CA163	Cable end, Lineryg TR cable ends	F-65
DZ5CA163D	Cable end, Lineryg TR cable ends	F-65
DZ5CA253	Cable end insulated for clip-in marker,	F-65
DZ5CA253D	Cable end, Lineryg TR cable ends	F-65
DZ5CA352	Cable end 35mm ²	F-65
DZ5CA352D	Wire end sleeve DZ5 according to DIN, 35mm ² /AWG2	F-65
DZ5CA353	Cable end with clipin tag holder long size 35 mm ² red	F-65
DZ5CA353D	Cable end, Lineryg TR cable ends	F-65
DZ5CA502	Cable end 50mm ²	F-65
DZ5CA502D	Cable end, Lineryg TR cable ends	F-65
DZ5CA503	Cable end, Lineryg TR cable ends	F-65
DZ5CA503D	Cable end, Lineryg TR cable ends	F-65
DZ5CE002	Cable end, Lineryg TR cable ends	F-64
DZ5CE002L6	Cable end, Lineryg TR cable ends	F-64
DZ5CE003	Cable end, Lineryg TR cable ends	F-64
DZ5CE003L6	Cable end, Lineryg TR cable ends	F-64
DZ5CE005	Cable end insulated, 0,5mm ² , medium size	F-64
DZ5CE005D	Cable end, Lineryg TR cable ends	F-64
DZ5CE005L6	Cable end, Lineryg TR cable ends	F-64
DZ5CE005L6D	Cable end insulated, 0,5ODI	F-64
DZ5CE005L10D	Cable end, Lineryg TR cable ends	F-64
DZ5CE007	Cable end insulated, 0,75mm ² , medium siz	F-64
DZ5CE007D	Cable end, Lineryg TR cable ends	F-64
DZ5CE007L6	Cable end, Lineryg TR cable ends	F-64
DZ5CE007L6D	Cable end, Lineryg TR cable ends	F-64
DZ5CE007N	Cable end, Lineryg TR cable ends	F-65
DZ5CE010	Cable ends	F-64
DZ5CE010D	Cable end, Lineryg TR cable ends	F-64
DZ5CE010L6	Cable end, Lineryg TR cable ends	F-64
DZ5CE010L6D	Cable end, Lineryg TR cable ends	F-64



Index of Commercial References With Description

Com. no.	Description	Page
DZ5CE010L12	Cable end, Lineryg TR cable ends	F-64
DZ5CE010L12D	Cable end, Lineryg TR cable ends	F-64
DZ5CE010N	Lineryg DZ5 - cable ferrule - medium size - 1mm ² - non-insulated - DIN	F-65
DZ5CE015	Cable ends	F-64
DZ5CE015D	Cable end, Lineryg TR cable ends	F-64
DZ5CE015L6	Cable end, Lineryg TR cable ends	F-64
DZ5CE015L6D	Cable end, Lineryg TR cable ends	F-64
DZ5CE015N	Cable end, Lineryg TR cable ends	F-65
DZ5CE020	Cable end, Lineryg TR cable ends	F-64
DZ5CE025	Cable ends	F-64
DZ5CE025D	Cable end, Lineryg TR cable ends	F-64
DZ5CE025N	Cable end, Lineryg TR cable ends	F-65
DZ5CE040	Cable end, Lineryg TR cable ends	F-65
DZ5CE042	Cable ends	F-64
DZ5CE042D	Cable end, Lineryg TR cable ends	F-64
DZ5CE043	Cable end, Lineryg TR cable ends	F-64
DZ5CE043D	Cable end, Lineryg TR cable ends	F-64
DZ5CE060	Cable ends	F-65
DZ5CE060L	Cable end, Lineryg TR cable ends	F-65
DZ5CE062	Cable ends	F-64
DZ5CE062D	Cable end, Lineryg TR cable ends	F-64
DZ5CE063	Cable end, Lineryg TR cable ends	F-64
DZ5CE063D	Cable end, Lineryg TR cable ends	F-64
DZ5CE100	Cable end, Lineryg TR cable ends	F-65
DZ5CE102	Cable end insulated for clip-in marker, 10mm ²	F-64
DZ5CE102D	Cable end, Lineryg TR cable ends	F-64
DZ5CE103	Cable end, Lineryg TR cable ends	F-64
DZ5CE0153	Cable ends	F-64
DZ5CE0153D	Cable ends	F-64
DZ5CE160	Cable end, Lineryg TR cable ends	F-65
DZ5CE162	Cable end insulated for clip-in marker, 16mm ²	F-64
DZ5CE162D	Cable end, Lineryg TR cable ends	F-64
DZ5CE163	Cable end, Lineryg TR cable ends	F-64
DZ5CE252	Cable end insulated for clip-in marker, 25mm ²	F-64
DZ5CE0253	Cable ends	F-64
DZ5CE0253D	Cable ends	F-64
DZ5CE352	Cable end insulated for clip-in marker, 25mm ²	F-64
DZ5CE352D	Cable end, Lineryg TR cable ends	F-64
DZ5CE353	Cable end, Lineryg TR cable ends	F-64
DZ5CE502	Cable end insulated for clip-in marker, 50mm ²	F-64
DZ5CE502D	Cable end, Lineryg TR cable ends	F-64
DZ5CEB005	Cable end band 0.5mm ²	F-64
DZ5CEB005D	Cable end, Lineryg TR cable ends	F-64
DZ5CEB007	Cable end band 0.7mm ²	F-64
DZ5CEB007D	Cable end, Lineryg TR cable ends	F-64

Com. no.	Description	Page
DZ5CEB010	Cable end band 1mm ²	F-64
DZ5CEB010D	Cable end, Lineryg TR cable ends	F-64
DZ5CEB015	Cable end band 1.5mm ²	F-64
DZ5CEB015D	Cable end, Lineryg TR cable ends	F-64
DZ5CEB025	Cable end, Lineryg TR cable ends	F-64
DZ5CEB025D	Cable end, Lineryg TR cable ends	F-64
E...		
EZ9XPH112	Comb busbar, Easy9 XP, 1P, 63 A, 12 modules	C-9
EZ9XPH157	Comb busbar, Easy9 XP, 1P, 63 A, 57 modules	C-9
EZ9XPH212	Comb busbar, Easy9 XP, 2P, 63 A, 12 modules	C-9
EZ9XPH257	Comb busbar, Easy9 XP, 2P, 63 A, 57 modules	C-9
EZ9XPH312	Comb busbar, Easy9 XP, 3P, 63 A, 12 modules	C-9
EZ9XPH357	Comb busbar, Easy9 XP, 3P, 63 A, 57 modules	C-9
EZ9XPC04	Comb busbar 35 mm ² connector, Easy9, set of 4	C-9
EZ9XPE210	Comb busbar side cover, Easy9, 2P, set of 10	C-9
EZ9XPE310	Comb busbar side cover, Easy9, 3P, set of 10	C-9
G...		
GK2AF01	Motor starter adapter plate, TeSys Deca	C-17
GV1F03	Terminal protection shrouds, TeSys GS, for 4-pole	C-17
GV1G02	Terminal protection shrouds, TeSys GS, for 4-pole	C-17
GV1G09	Terminal protection shrouds, TeSys GS, for 4-pole	C-17
GV1G10	Terminal protection shrouds, TeSys GS, for 4-pole	C-17
GV2AF01	Terminal protection shrouds, TeSys GS, for 4-pole	C-16
GV2AF3	Terminal protection shrouds, TeSys GS, for 4-pole	C-16
GV2AF4	Terminal protection shrouds, TeSys GS, for 4-pole	C-16
GV2G05	Terminal protection shrouds, TeSys GS, for 4-pole	C-17
GV2G245	Terminal protection shrouds, TeSys GS, for 4-pole	C-16
GV2G254	Terminal protection shrouds, TeSys GS, for 4-pole	C-16
GV2G272	Terminal protection shrouds, TeSys GS, for 4-pole	C-16
GV2G345	Terminal protection shrouds, TeSys GS, for 4-pole	C-16
GV2G354	Terminal protection shrouds, TeSys GS, for 4-pole	C-16
GV2G445	Terminal protection shrouds, TeSys GS, for 4-pole	C-16
GV2G454	Terminal protection shrouds, TeSys GS, for 4-pole	C-16

Index of Commercial References With Description

Com. no.	Description	Page
GV2G472	Terminal protection shrouds, TeSys GS, for 4-pole	C-16
GV2G554	Terminal protection shrouds, TeSys GS, for 4-pole	C-16
GV2GA01	Terminal protection shrouds, TeSys GS, for 4-pole	C-17
GV3G264	Terminal protection shrouds, TeSys GS, for 4-pole	C-16
GV3G364	Terminal protection shrouds, TeSys GS, for 4-pole	C-16
GV3S	Terminal protection shrouds, TeSys GS, for 4-pole	C-16
L...		
LA9D65A69	Power connections, parallel and reverser busbars, for 3P	C-19
LA9D65A70	Power connections, parallel busbar, for 4P	C-18
LA9D1261	PARALLEL CONNECTOR OF 2P FOR D09-D38	C-16
LA9D1263	PARALLEL CONNECTOR OF 4P FOR D09-D38	C-16
LA9D2561	Parallel connection of 2 poles, for TeSys Deca contactors	C-16
LA9D3260	Terminal block, TeSys Deca, 3P, screw clamp	C-16
LA9D8017	STAR DELTA KIT FOR LC1D80	C-19
LA9D8069	REVERS KIT FOR D80-95	C-19
LA9D8070	REVERS KIT FOR 4P D80	C-18
LA9D11502	INTERLOCK FOR D115/150, Tesys Deca	C-18
LA9D11569	Power connections, parallel and reverser bars, for 3P	C-19
LA9D11570	Power connections, parallel bars, for 4P	C-18
LA9D11571	Power connections, parallel bars, for 3P	C-18
LA9D80962	CONNECTIONS 3P D80/D95	C-16
LA9D80963	CONNECTIONS 4P D80/D95	C-16
LA9D80973	STAR DELTA MOUNTING PLATE D80	C-19
LA9FG976	TeSys F - set of connections - 3P - reversing	C-20
LA9FH976	TeSys F - set of connections - 3P - reversing	C-20
LA9FJ976	TeSys F - set of connections - 3P - reversing	C-20
LA9FJ982	TeSys F - set of connections - 3P - changeover	C-20
LA9FK976	TeSys F - set of connections - 3P - reversing	C-20
LA9G3101	Cable Memory Extension for 3P G115-225	C-22
LA9G3102	Cable Memory Extension for 3P G265-500	C-22
LA9G3103	Cable Memory Extension for 3P G630-800	C-22
LA9G3111	Flexible extensions 3P G115-225 to MCCB	C-22
LA9G3112	Flexible extensions 3P G265-500 to MCCB	C-22

Com. no.	Description	Page
LA9G3113	Flexible extensions 3P G630-800 to MCCB	C-22
LA9G3601	Straight Terminal Extension 3P G115-225	C-22
LA9G3602	Straight Terminal Extension 3P G265-500	C-22
LA9G3603	Straight Terminal Extension 3P G630-800	C-22
LA9G3611	Spreaders 3P G115-225 35mm-45mm	C-23
LA9G3612	Spreaders 3P G265-500 45mm-70mm	C-23
LA9G3613	Spreaders 3P G400-500 50mm connection	C-23
LA9G3614	Spreaders 3P G630-800 80mm connection	C-23
LA9G3631	Edgwise Terminal Extension 3P G115-225	C-23
LA9G3632	Edgwise Terminal Extension 3P G265-500	C-23
LA9G3633	Edgwise Terminal Extension 3P G630-800	C-23
LA9G3661	Side Terminal Extension 3P G115-225	C-22
LA9G3662	Side Terminal Extension 3P G265-500	C-22
LA9G3663	Side Terminal Extension 3P G630-800	C-22
LA9G3671	LargeTerminal Extension 3P G115-225	C-22
LA9G3672	LargeTerminal Extension 3P G265-500	C-22
LA9G3673	LargeTerminal Extension 3P G630-800	C-22
LA9G3681	Rear Terminal Extension 3P G115-225	C-22
LA9G3682	Rear Terminal Extension 3P G265-500	C-22
LA9G3683	Rear Terminal Extension 3P G630-800	C-22
LA9G3711	Spreader kit for Box conn 3P G115-225	C-23
LA9G3712	Spreader kit for Box conn 3P G265-500	C-23
LA9G3714	Spreader kit for Box conn 3P G630-800	C-23
LA9G3750	ChangeOver Bars 3P Kit G115-225	C-24
LA9G3751	ChangeOver Bars 3P Kit G265-500	C-24
LA9G3752	ChangeOver Bars 3P Kit G630-800	C-24
LA9G3760	Reverser Bars 3P Kit G115-225	C-24
LA9G3761	Reverser Bars 3P Kit G265-500	C-24
LA9G3762	Reverser Bars 3P Kit G630-800	C-24
LA9G4101	Cable Memory Extension for 4P G115-225	C-22
LA9G4102	Cable Memory Extension for 4P G265-500	C-22
LA9G4103	Cable Memory Extension for 4P G630-800	C-22
LA9G4111	Flexible extensions 4P G115-225 to MCCB	C-22



Index of Commercial References With Description

Com. no.	Description	Page
LA9G4112	Flexible extensions 4P G265-500 to MCCB	C-22
LA9G4113	Flexible extensions 4P G630-800 to MCCB	C-22
LA9G4601	Straight Terminal Extension 4P G115-225	C-22
LA9G4602	Straight Terminal Extension 4P G265-500	C-22
LA9G4603	Straight Terminal Extension 4P G630-800	C-22
LA9G4611	Spreaders 4P G115-225 35mm-45mm	C-23
LA9G4612	Spreaders 4P G265-500 45mm-70mm	C-23
LA9G4613	Spreaders 4P G400-500 for 50mm width	C-23
LA9G4614	Spreaders 4P G630-800 for 80mm width	C-23
LA9G4631	Edgwise Terminal Extension 4P G115-225	C-23
LA9G4632	Edgwise Terminal Extension 4P G265-500	C-23
LA9G4633	Edgwise Terminal Extension 4P G630-800	C-23
LA9G4711	Spreader kit for Box conn 4P G115-225	C-23
LA9G4712	Spreader kit for Box conn 4P G265-500	C-23
LA9G4714	Spreader kit for Box conn 4P G630-800	C-23
LA9G4750	ChangeOver Bars 4P Kit G115-225	C-24
LA9G4751	ChangeOver Bars 4P Kit G265-500	C-24
LA9G4752	ChangeOver Bars 4P Kit G630-800	C-24
LA9GQQ330	Star Delta Bars LDY kit for G115-225	C-24
LA9GSQ330	Star Delta Bars LD G265-500/Y G115-225	C-24
LA9GSQ331	CM StarDelta Bars LD G265-500/Y G115-225	C-24
LA9GSS330	Star Delta Bars LDY kit for G265-500	C-24
LA9GTS330	Star Delta Bars LD G630-800/Y G265-500	C-24
LA9GTS331	CM StarDelta Bars LD G630-800/Y G265-500	C-24
LA9GTT330	Star Delta Bars LDY kit for G630-800	C-24
LA9ZA32427	PLATE LUB 32A 45X200 IEC/UL	D-18, D-21
LA9ZA32428	PLATE LUB 32A 45X260 IEC/UL	D-18, D-21
LA9ZA32434	PLATE GV2 32A 45X200 IEC/UL	D-18
LA9ZA32442	PLATE GV2 32A 54X200 IEC/UL	D-18
LA9ZA32443	PLATE GV2 32A 63X200 IEC/UL	D-18
LA9ZA32600	PLATE POWERPACT 60-150A 3P IEC/UL	D-21
LA9ZA32621	PLATE GV2 25A 45X200 IEC/UL	D-18
LA9ZA32622	PLATE GV2 25A 90X200 IEC/UL	D-18
LA9ZA32623	PLATE GV2 32A 90X200 IEC/UL	D-18
LA9ZA32624	PLATE GV3 63A 54X200 IEC/UL	D-20
LA9ZA32625	PLATE GV3 63A 54X260 IEC/UL	D-21

Com. no.	Description	Page
LA9ZA32626	PLATE GV3 63A 117X260 IEC/UL	D-20
LA9ZX01131	BUSBAR SUPPORT 4P END COVERS	D-16
LA9ZX01243	CONNECTORS PLATE 3P 120MM2 IEC/UL	D-22
LA9ZX01244	1M BUSBAR COVER 5MM	D-16, D-17
LA9ZX01245	1M BUSBAR COVER 10MM	D-16, D-17
LA9ZX01285	CONNECTOR 1P 35MM2 FOR 5MM BUSBAR	D-22
LA9ZX01287	CONNECTOR 1P 70MM2 FOR 5MM BUSBAR	D-22
LA9ZX01413	COVER 3P FOR CONNECTORS UP TO 70MM ²	D-22
LA9ZX01485	SUPPORT 4P FOR 60 INTERAXIS BUSBAR IEC	D-16, D-17
LA9ZX01495	SUPPORT 3P FOR 60 INTERAXIS BUSBAR IEC	D-16, D-17
LA9ZX01508	SUPPORT 3P FOR 60 INTERAXIS BUSBAR UL	D-16
LA9ZX01515	BASE PLATE 240X700 UL	D-16
LA9ZX01563	SPRING TERM 3P CONNECT MOD 16MM2 IEC/UL	D-22
LA9ZX01573	BUSBAR SUPPORT 3P END COVERS	D-16
LAD9P3	BAG 10 JUMPERS BAR 3P	C-16
LAD9P32	LC1D40A-D65A 2P PARALLEL BUSBAR	C-16
LAD9P33	LC1D40A-D65A 3P PARALLEL BUSBAR	C-16
LAD9R1	REVERSING SWITCH KIT 3P	C-19
LAD9R1V	REVERSING SWITCH KIT 3P	C-19
LAD9R3	LC1D40A-D65A REVERSOR KIT 3P	C-19
LAD9R3S	LC1D40A-D65A 3P CHANGEOVER KIT 3P	C-18
LAD9SD3	LC1D40A-65A STAR-DELTA KIT	C-19
LAD311	Adapter plates, TeSys Deca Frame 2	C-17
LAD91217	MOUNTING KIT FOR STAR DELTA	C-19
LAD92560	Terminal block, TeSys Deca, 4P, Screw clamp	C-16
LAD93217	MOUNTING KIT FOR STAR DELTA	C-19
LAD96061	Link for parallel connection of 2P	C-16
LADT9R1	REVERSING SWITCH KIT 4P	C-18
LADT9R1V	REVERSING SWITCH KIT 4P	C-18
LGY112510	SCREW DISTRIBUTION BLOCK 1P 125A 10HOLES	B-3
LGY116013	SCREW DISTRIBUTION BLOCK 1P 160A 13HOLES	B-3
LGY125014	SCREW DISTRIBUTION BLOCK 1P 250A 14HOLES	B-3
LGY410028	Screw distribution block 4P 100A 28holes	B-3
LGY412548	Screw distribution block 4P 125a 48holes	B-3
LGY412560	Screw distribution block 4P 125a 60holes	B-3
LGY416048	Screw distribution block 4P 160A 48holes	B-3

Index of Commercial References With Description

Com. no.	Description	Page
LGYN1007	Additional neutral bar for sbl n 100A 7h	B-3
LGYN12512	Additional neutral bar for sbl n 125a 12	B-3
LGYN12515	Additional neutral bar for sbl n 125a 15	B-3
LV429372	Mechanical interlocking for 2 rot handle	D-20, D-21
LV429373	Mechanical interlocking for 2 rot handle	D-20
LV432623	Rotary handle mechanical interlocking n	D-20, D-21
LV432624	Rotary handle mechanical interlocking n	D-20
LVS01109	12 Linergy LGY busbar stops	D-9, D-12
LVS01201	Prisma plus cub.assoc	D-6
LVS01202	4 IPXXB covers Linergy FM 200	C-3
LVS01210	4 IPXXB covers Linergy FM 200	D-6
LVS01211	4 IPXXB covers Linergy FM 200	D-6
LVS03416	Mounting plate for Linergy FC NSXm	C-14
LVS03420	M.PI.4Vigi/NSX/CVS/ 3INS 250 v. Fix. Toggle	C-12
LVS03422	M.Plate 4 Vigi NSX/CVS 250 v. Fixed rot/tel	C-12
LVS03423	M.PI.3-4 V.Withd.NS250 polyp.	C-12
LVS04004	Linergy FM 4P dist. block 80A 24m 44 holes	C-2
LVS04008	Linergy FM 4P dist.block 63A 12m 20 holes	C-2
LVS04012	Linergy FM 2P dis.Block 200A 24m 24holes	C-2
LVS04013	Linergy FM 3P dis.Block 200A 24m 42 holes	C-2
LVS04014	Linergy FM 4P dis.Block 200A 24m 54 holes	C-2
LVS04018	Linergy FM 4P dis.Block 160A 12m 27 holes	C-2
LVS04021	Linergy FM 4P dis.Block 160A 12m 27 holes	C-3, D-6, D-7
LVS04024	4P conn.Lin.Bs stage bb/lin.Fm d. blk200A	C-2, C-3
LVS04026	Linergy FM 4P dis.Block 200A 36m 81 holes	C-2
LVS04029	4 Conn.Lin.Bs rear bb/lin.fm d.blk 200A	C-2, C-3
LVS04030	4 Conn. Ng160/Linergy FM dist.blk 160A	C-3
LVS04031	Linergy DX 1P dist.Block 160A 4m 6 holes	B-4
LVS04033	Linergy DP 3P d.blk/ComPacT 250A 27 holes	B-6
LVS04034	Linergy DP 4P d.blk/ComPacT 250A 36 holes	B-6
LVS04036	Linergy DP 4P d.blk/ComPacT 250A 36 holes	D-12
LVS04037	Linergy DP 4P d.blk/ComPacT 250A 36 holes	B-4
LVS04038	Linergy DP/NSXm 3P 160A 18T	B-7
LVS04039	Linergy DP/NSXm 4P 160A 24T	B-7

Com. no.	Description	Page
LVS04040	Linergy DX 4P 63A top incoming	B-4
LVS04041	Linergy DX 4P 63A bottom incoming	B-4
LVS04045	Linergy DX 4P dist.block 125A 6m 52 holes	B-4
LVS04046	Linergy DX 4P d.blk/ng160 160A 6m 52 hole	B-4
LVS04047	4 Conn.Ng125/Linergy DX dist. Block 125A	B-4
LVS04052	Linergy BS 4P multistage bb 160A 52holes	D-4
LVS04053	Linergy BS 4P multistage bb 250A 52holes	D-4
LVS04054	Linergy BS 4P multistage bb 400A 52holes	D-4
LVS04055	Linergy BS 4P multistage bb 630A 52holes	D-4
LVS04060	Linergy BS 4P multistage bb 630A 52holes	D-7
LVS04061	Linergy BS 4P multistage bb 630A 52holes	D-7
LVS04070	Linergy BS 4P multistage bb 630A 52holes	D-7
LVS04071	Linergy BS 4P multistage bb 630A 52holes	D-7
LVS04074	Linergy BS 4P multistage bb 630A 52holes	D-7
LVS04103	Linergy BS 4P multistage bb 630A 52holes	D-6
LVS04104	Linergy BS 4P multistage bb 630A 52holes	D-6
LVS04107	Linergy BS 4P multistage bb 630A 52holes	D-6
LVS04108	Linergy BS 4P multistage bb 630A 52holes	D-6
LVS04111	Linergy BS 4P multistage bb 630A 52holes	D-6
LVS04112	Linergy BS 4P multistage bb 630A 52holes	D-6
LVS04113	Linergy BS 4P multistage bb 630A 52holes	D-6
LVS04114	Linergy BS 4P multistage bb 630A 52holes	D-6
LVS04116	Linergy BS 4P multistage bb 630A 52holes	D-6
LVS04117	Linergy BS 4P multistage bb 630A 52holes	D-6
LVS04118	Linergy BS 4P multistage bb 630A 52holes	D-6
LVS04119	Linergy BS 4P multistage bb 630A 52holes	D-6
LVS04121	Linergy BS 4P multistage bb 630A 52holes	D-6
LVS04122	Linergy BS 4P multistage bb 630A 52holes	D-6
LVS04123	Linergy BS 4P multistage bb 630A 52holes	D-6
LVS04124	Linergy BS 4P multistage bb 630A 52holes	D-6
LVS04126	Linergy BS 4P multistage bb 630A 52holes	D-6



Index of Commercial References With Description

Com. no.	Description	Page
LVS04127	Lineryg BS 4P multistage bb 630A 52holes	D-6
LVS04128	Lineryg BS 4P multistage bb 630A 52holes	D-6
LVS04129	Lineryg BS 4P multistage bb 630A 52holes	D-6
LVS04145	CU connections 125A 4P W230 with 35° ferrule+45° angle lug	D-7
LVS04146	CU connections 160A 4P W250 with 45° ferrule+45° angle lug	D-7
LVS04147	CU connections 160A 4P W250 with 45° ferrule+45° angle lug	D-7
LVS04148	CU connections 160A 4P W250 with 45° ferrule+45° angle lug	D-7
LVS04150	Connection 160A 4P L380 /Lineryg DX 1P	D-6
LVS04151	Connection 160A 4P L380 /Lineryg DX 1P	D-6
LVS04152	Connection 160A 4P L380 /Lineryg DX 1P	D-6
LVS04155	Additional blk 2x35 ² 3P/ Lineryg DP 250A	
LVS04156	Additional blk 2x35 ² 4P/ Lineryg DP 250A	B-6
LVS04158	Additional blk 2x35 ² 4P/ Lineryg DP 250A	D-6
LVS04161	4 Threaded bars 160A L1000/ Lineryg BS bb	D-2, D-3
LVS04162	4 Threaded bars 250A L1000/ Lineryg BS bb	D-2, D-3
LVS04163	4 Threaded bars 400A L1000/ Lineryg BS bb	D-2, D-3
LVS04171	4 Threaded bars 160A L1400/ Lineryg BS bb	D-2, D-3
LVS04172	4 Threaded bars 250A L1400/ Lineryg BS bb	D-2, D-3
LVS04173	4 Threaded bars 400A L1400/ Lineryg BS bb	D-2, D-3
LVS04174	4 Threaded bars 630A L1400/ Lineryg BS bb	D-3
LVS04191	Lineryg BS rear busbar support 400A	D-2
LVS04192	Lineryg BS multistage b.Bar support 630A	D-3
LVS04194	20 Bolts 8.8 Class m6x20 /5mm copper bar	D-5
LVS04195	40 Screws 8.8 Class m6x16/ threaded bar	D-5
LVS04197	Barrier h1500mm/Lineryg BS multistage bb	D-3
LVS04198	Barrier h100mm /Lineryg BS rear busbar	D-2
LVS04200	Earth bar 35 ² /40 clamps L450 Lineryg TB	F-66
LVS04201	12X3mm dir.Earth bar 35 ² L330 Lineryg TB	F-66
LVS04202	2 Earth bar 35 ² /20 clamp L200 Lineryg TB	F-66
LVS04210	2 Insulat.Spacers/neutral bar Lineryg TB	F-66
LVS04214	4 Earth blk 12x4 ² term.Clamp Lineryg TB	F-66

Com. no.	Description	Page
LVS04215	4 Earth blk 3x16 ² term.Clamp Lineryg TB	F-66
LVS04403	Lineryg FC distribution block for ComPacT NSX250 3P toggle/fixed + connection	C-12
LVS04404	Lineryg FC distribution block for ComPacT NSX250 4P toggle/fixed + connection	C-12
LVS04405	Lineryg FC distribution block for ComPacT NSX250 3P fixed/plug-in + connection	C-12
LVS04406	Lineryg FC distribution block for ComPacT NSX250 4P fixed/plug-in + connection	C-12
LVS04407	Lineryg FC distribution block for ComPacT NSX250 3P fixed W/O connection	C-12
LVS04408	Lineryg FC distribution block for ComPacT NSX250 4P fixed W/O connection	C-12
LVS04410	Lineryg FC distribution block for ComPacT NSXm 160A 3P toggle/ fixed + connection	C-14
LVS04411	Lineryg FC distribution block for ComPacT NSXm 160A 4P toggle/ fixed + connection	C-14
LVS04412	Lineryg FC distribution block for ComPacT NSXm 160A 3P toggle/ fixed	C-14
LVS04413	Lineryg FC distribution block for ComPacT NSXm 160A 4P toggle/ fixed	C-14
LVS04416	Lineryg FC distribution block for ComPacT NSXm 160A 3P toggle/ fixed with VIGI + connection	C-14
LVS04417	Lineryg FC distribution block for ComPacT NSXm 160A 4P toggle/ fixed with VIGI + connection	C-14
LVS04418	Lineryg FC distribution block for ComPacT NSXm 160A 3P toggle/ fixed with VIGI	C-14
LVS04419	Lineryg FC distribution block for ComPacT NSXm 160A 3P toggle/ fixed without connection	C-14
LVS04420	Lineryg FC distribution block for ComPacT NSXm 160A 4P toggle/ fixed without connection	C-14
LVS04502	Lineryg LGY vertical profile 630A L1670	D-9, D-12, F-67
LVS04503	Lineryg LGY vertical profile 800A L1670	D-9, D-12, F-67
LVS04504	Lineryg LGY vertical profile 1000A L1670	D-9, D-12
LVS04505	Lineryg LGY vertical profile 1250A L1670	D-9, D-12
LVS04506	Lineryg LGY vertical profile 1600A L1670	D-9, D-12
LVS04512	Pe v.Bar w.Holes 25x5 L1675 Lineryg TB	F-67
LVS04515	Pe v.Bar w.Holes 50x5 L1675 Lineryg TB	F-67
LVS04516	Drilled flat bar Lineryg BS 60x5 L1675	D-11, D-13
LVS04518	Drilled flat bar Lineryg BS 80x5 L1675	D-11, D-13

Index of Commercial References With Description

Com. no.	Description	Page
LVS04525	Drilled flat bar Linery BS 50x10 L1675	D-11, D-13
LVS04526	Drilled flat bar Linery BS 60x10 L1675	D-11, D-13
LVS04528	Drilled flat bar Linery BS 80x10 L1675	D-11, D-13
LVS04536	Plain hz flat bar Linery BS 60x5 L2000	D-15
LVS04538	Plain hz flat bar Linery BS 80x5 L2000	D-15
LVS04545	Plain hz flat bar Linery BS 50x10 L2000	D-15
LVS04546	Plain hz flat bar Linery BS 60x10 L2000	D-15
LVS04548	Plain hz flat bar Linery BS 80x10 L2000	D-15
LVS04550	Plain hz flat bar Linery BS100x10 L2000	D-15
LVS04552	Plain hz flat bar Linery BS120x10 L2000	D-15
LVS04560	Linery LGYE profile 630A L2000	D-10, D-14
LVS04561	Linery LGYE profile 800A L2000	D-10, D-14
LVS04562	Linery LGYE profile 1000A L2000	D-10, D-14
LVS04563	Linery LGYE profile 1250A L2000	D-10, D-14
LVS04564	Linery LGYE profile 1600A L2000	D-10, D-14
LVS04565	Linery LGYE profile 2000A L2000	D-10, D-14
LVS04566	Linery LGYE profile 2500A L2000	D-10, D-14
LVS04567	Linery LGYE profile 3200A L2000	D-10, D-14
LVS04568	Linery LGYE profile 4000A L2000	D-10, D-14
LVS04604	Linery LGYE vert. Shifted connect.1600A	D-10–D-15
LVS04605	Linery LGYE vert. Long connect. 2500A	D-10–D-15
LVS04607	Linery LGYE vertical connection 4000A	D-10
LVS04620	Linery LGYE horizontal joint 1600A	D-14
LVS04621	Linery LGYE horizontal joint 2500A	D-14
LVS04623	Linery LGYE horizontal joint 4000A	D-14
LVS04624	Linery LGYE horizontal joint 4000A	D-14–D-15
LVS04634	Connection 1000A 5mm hz.Bar/ LGY profile	D-9–D-15
LVS04635	Connection 1600A 5mm hz.Bar/ LGY profile	D-9, D-12, D-13
LVS04636	Connect.1600A 10mm hz bar/ LGY v.Profile	D-9, D-11, D-12, D-13
LVS04637	Connect.Plate 3200A 10mm hz/ v. Flat bar	D-11
LVS04638	Connect.Plate 3200A 10mm hz/ v. Flat bar	D-11
LVS04640	Connect.Plate 3200A 10mm hz/ v. Flat bar	D-15
LVS04641	Connect.Plate 3200A 10mm hz/ v. Flat bar	D-15
LVS04642	Connect.Plate 4000A 10mm hz/ v. Flat bar	D-9, D-11, D-12, D-13

Com. no.	Description	Page
LVS04643	Joint for 120mm bar/Linery BS hz.Busbar	D-15
LVS04651	Mounting hardware Linery LGEu3200A	D-9
LVS04652	Linery LGY rear busbar support	D-12
LVS04653	Linery BS rear vert.Support 5/10mm bar	D-13
LVS04657	Linery TB 3 flat bar supp.For vert. Pe	F-67
LVS04658	12 Stops/1600A bott.Support Linery LGYE	D-10
LVS04659	12 Stops/4000A bott.Support Linery LGYE	D-10
LVS04661	Fixed support vert. Bb Linery LGYE/BS	D-10, D-11
LVS04662	Free busbar support Linery LGYE/BS	D-10, D-11, D-13, D-14, D-15
LVS04663	Bottom lat.V.5/10 Bb support lin. LGYE/BS	D-10, D-11
LVS04664	Fixed support hz. Bb Linery LGYE/BS	D-14, D-15
LVS04666	Bot.Lat.5/10 Bb support W300 lin. LGYE/BS	D-10, D-11
LVS04667	2 Horizontal pe supports Linery TB	F-67
LVS04669	Wedge, Linery BS, for busbar support	D-13
LVS04671	Mount. Hardware bb>80mm Linery LGYE/BS	D-11, D-14, D-15
LVS04672	2 Connect.Plate hz/v.Pe bar Linery TB	F-67
LVS04678	2 Connect.Plate hz/v.Pe bar Linery TB	D-11, D-14, D-15
LVS04752	Insulated flex.bar 32x8 L1800	C-14
LVS04753	20 M8 torque nuts	C-12
LVS04766	20 M8 LGY bolts for copper bar L39	D-9, D-12, F-67
LVS04767	Set of 12 screwplates for Linery evolution 2500A	D-9, D-12
LVS04772	20 M8/diam.24 Flat washers flex. Bar/LGY	D-9, D-12
LVS04773	20 M8/diam.28 Flat washers flex. Bar/LGY	D-9, D-12
LVS04774	20 M8/diam.20 Flat washers lugs<25 ² /LGY	D-9, D-12
LVS04775	20 Bolts 8.8 Class M8x20 /Linery BS	D-9, D-12
LVS04794	12 Phase Marker/Linery Lgy/Lgye Profile	D-9, D-12
LVS04809	Linery Fc Tooth Caps, 4p, For Nsx100-250 Linery Fc Device Feeders	C-13
LVS04810	Tooth-cap 1P Linery FC D.BLK NSXm 160A	C-15
LVS04922	Form 2 side barrier for lat.Vert.bb.	C-12, C-14
LVS04924	Form 2 side barrier restoration kit	C-12, C-14
LVS07051	4 Cable Conn.1P 160A 70mm ² Linery BS	D-5
LVS07052	4 Cable conn.1P 250A 185mm ² Linery BS	D-5
LVS07053	4 Cable connect1P 400A 300mm ² Linery BS	D-5



Index of Commercial References With Description

Com. no.	Description	Page
LVS09516	Switchboard portable lamp	C-7
N...		
NSYAS500	Lower anchoring supp vertical busbar 500	D-11
NSYAS600	Lower anchoring supp vertical busbar 600	D-11
NSYAS800	Lower anchoring supp vertical busbar 800	D-11
NSYAS800L	Low support vertical busbar L800. 115mm	D-11
NSYBHS500	Horizontal busbar supp 3200A 500	D-15
NSYBHS600	Horizontal busbar supp 3200A 600	D-15
NSYBHS800	Horizontal busbar supp 3200A 800	D-15
NSYBHS800L	2 horizontal busbar supp 3200A L800. 115	D-15
NSYSDR200BD	ClimaSys forced vent. IP54, 850m3/h, 230V	F-6, F-7, F-8, F-9, F-10, F-11, F-12, F-13, F-14, F-16, F-17, F-18, F-19, F-20, F-22, F-23, F-24, F-32, F-33, F-34, F-35, F-36, F-37, F-38, F-40, F-41, F-42, F-44, F-45, F-48, F-49, F-50, F-52, F-53, F-54, F-55, F-56, F-57
NSYSFPA	ClimaSys forced vent. IP54, 850m3/h, 230V	D-9
NSYTRAAB15	ClimaSys forced vent. IP54, 850m3/h, 230V	F-27, F-58
NSYTRAAB35	ClimaSys forced vent. IP54, 850m3/h, 230V	F-6, F-7, F-8, F-9, F-10, F-11, F-12, F-13, F-14, F-16, F-17, F-18, F-19, F-20, F-22, F-23, F-24, F-32, F-33, F-34, F-35, F-36, F-37, F-38, F-40, F-41, F-42, F-44, F-45, F-48, F-49, F-50, F-52, F-53, F-54, F-55, F-56, F-57, F-58, F-59
NSYTRAABV35	ClimaSys forced vent. IP54, 850m3/h, 230V	F-6, F-7, F-8, F-9, F-10, F-11, F-12, F-13, F-14, F-16, F-17, F-18, F-19, F-20, F-22, F-23, F-24, F-32, F-33, F-34, F-35, F-36, F-37, F-38, F-40, F-41, F-42, F-44, F-45, F-48, F-49, F-50, F-52, F-53, F-54, F-55, F-56, F-57, F-58, F-59
NSYTRAATM1	ClimaSys forced vent. IP54, 850m3/h, 230V	F-6, F-7, F-8, F-9, F-10, F-11, F-12, F-13, F-14, F-16, F-17, F-18, F-19, F-20, F-22, F-23, F-24, F-32, F-33, F-34, F-35, F-36, F-37, F-38, F-40, F-41, F-42, F-44, F-45, F-48, F-49, F-50, F-52, F-53, F-54, F-55, F-56, F-57, F-58

Com. no.	Description	Page
NSYTRAATP1	ClimaSys forced vent. IP54, 850m3/h, 230V	F-6, F-7, F-8, F-9, F-10, F-11, F-12, F-13, F-14, F-16, F-17, F-18, F-19, F-20, F-22, F-23, F-24, F-32, F-33, F-34, F-35, F-36, F-37, F-38, F-40, F-41, F-42, F-44, F-45, F-48, F-49, F-50, F-52, F-53, F-54, F-55, F-56, F-57, F-58
NSYTRAB5	ClimaSys forced vent. IP54, 850m3/h, 230V	F-60
NSYTRAB5L1N	ClimaSys forced vent. IP54, 850m3/h, 230V	F-60
NSYTRAB6	ClimaSys forced vent. IP54, 850m3/h, 230V	F-60
NSYTRAB6L1N	Marking strip, Lineryg TR, clip in type, 6mm	F-60
NSYTRAB8	Marking strip, Lineryg TR, clip in type, 6mm	F-60
NSYTRAB10	ClimaSys forced vent. IP54, 850m3/h, 230V	F-60
NSYTRAB510	ClimaSys forced vent. IP54, 850m3/h, 230V	F-60
NSYTRAB520	ClimaSys forced vent. IP54, 850m3/h, 230V	F-60
NSYTRAB530	ClimaSys forced vent. IP54, 850m3/h, 230V	F-60
NSYTRAB540	ClimaSys forced vent. IP54, 850m3/h, 230V	F-60
NSYTRAB550	ClimaSys forced vent. IP54, 850m3/h, 230V	F-60
NSYTRAB560	ClimaSys forced vent. IP54, 850m3/h, 230V	F-60
NSYTRAB570	ClimaSys forced vent. IP54, 850m3/h, 230V	F-60
NSYTRAB580	ClimaSys forced vent. IP54, 850m3/h, 230V	F-60
NSYTRAB590	ClimaSys forced vent. IP54, 850m3/h, 230V	F-60
NSYTRAB610	Marking strip, Lineryg TR, clip in type, 6mm	F-60
NSYTRAB620	Marking strip, Lineryg TR, clip in type, 6mm	F-60
NSYTRAB630	Marking strip, Lineryg TR, clip in type, 6mm	F-60
NSYTRAB640	Marking strip, Lineryg TR, clip in type, 6mm	F-60
NSYTRAB650	Marking strip, Lineryg TR, clip in type, 6mm	F-60
NSYTRAB660	Marking strip, Lineryg TR, clip in type, 6mm	F-60
NSYTRAB670	Marking strip, Lineryg TR, clip in type, 6mm	F-60
NSYTRAB680	Marking strip, Lineryg TR, clip in type, 6mm	F-60
NSYTRAB690	Marking strip, Lineryg TR, clip in type, 6mm	F-60
NSYTRAB5100	ClimaSys forced vent. IP54, 850m3/h, 230V	F-60
NSYTRAB6100	Marking strip, Lineryg TR, clip in type, 6mm	F-60

Index of Commercial References With Description

Com. no.	Description	Page
NSYTRAB51100	ClimaSys forced vent. IP54, 850m3/h, 230V	F-60
NSYTRAB61100	Marking strip, Lineryg TR, clip in type, 6mm	F-60
NSYTRABC	Marking strip, Lineryg TR, clip in type, 6mm	F-63
NSYTRABCP1	Marking strip, Lineryg TR, clip in type, 6mm	F-63
NSYTRABCP5	Marking strip, Lineryg TR, clip in type, 6mm	F-63
NSYTRABCV	Marking strip, Lineryg TR, clip in type, 6mm	F-63
NSYTRABCV23	Marking strip, Lineryg TR, clip in type, 6mm	F-63
NSYTRABCV35	Marking strip, Lineryg TR, clip in type, 6mm	F-63
NSYTRABCV58	Marking strip, Lineryg TR, clip in type, 6mm	F-63
NSYTRABF5	Marking strip, Lineryg TR, clip in type, 6mm	F-60
NSYTRABF6	Marking strip, Lineryg TR, clip in type, flat, 5mm	F-60
NSYTRABF510	Marking strip, Lineryg TR, clip in type, 5mm	F-60
NSYTRABF520	Marking strip, Lineryg TR, clip in type, flat, 5mm	F-60
NSYTRABF530	Marking strip, Lineryg TR, clip in type, flat, 5mm	F-60
NSYTRABF540	Marking strip, Lineryg TR, clip in type, flat, 5mm	F-60
NSYTRABF550	Marking strip, Lineryg TR, clip in type, flat, 5mm	F-60
NSYTRABF610	Marking strip, Lineryg TR, clip in type, flat, 5mm	F-60
NSYTRABF620	Marking strip, Lineryg TR, clip in type, flat, 5mm	F-60
NSYTRABF630	Marking strip, Lineryg TR, clip in type, flat, 5mm	F-60
NSYTRABF640	Marking strip, Lineryg TR, clip in type, flat, 5mm	F-60
NSYTRABF650	Marking strip, Lineryg TR, clip in type, flat, 5mm	F-60
NSYTRABFPV5	Marking strip, Lineryg TR, clip in type, flat, 5mm	F-60
NSYTRABFPV6	Marking strip, Lineryg TR, clip in type, flat, 5mm	F-60
NSYTRABMP1	Marking strip, Lineryg TR, clip in type, flat, 5mm	F-60, F-62
NSYTRABPV5	Marking strip, Lineryg TR, clip in type, flat, 5mm	F-60
NSYTRABPV6	Marking strip, Lineryg TR, clip in type, flat, 5mm	F-60
NSYTRABPV8	Marking strip, Lineryg TR, clip in type, flat, 5mm	F-60
NSYTRAC22	Cover plate, Lineryg TR, 2 points, 2.2mm	F-11, F-24
NSYTRAC22BL	Cover plate, Lineryg TR, 2 points, 2.2mm	F-11, F-24
NSYTRAC23	Cover plate, Lineryg TR, 3 points, 2.2mm	F-12, F-16, F-18, F-19
NSYTRAC24	Cover plate, Lineryg TR, 2 points, 2.2mm width	F-13, F-16

Com. no.	Description	Page
NSYTRAC162	Marking strip, Lineryg TR, clip in type, flat, 5mm	F-11
NSYTRAC952	Cover plate, Lineryg TR, 2 points, 2.2mm width	F-9
NSYTRACE24	Cover plate, Lineryg TR, 2 level, 2.2mm	F-13, F-14, F-17, F-19
NSYTRACE26	Cover plate, Lineryg TR, 3 level, 2.2mm	F-14
NSYTRACEP24	Cover plate, Lineryg TR, 3 level, 2.2mm	F-13, F-14, F-17, F-19
NSYTRACM22	Cover plate, Lineryg TR, 3 level, 2.2mm	F-27
NSYTRACP43	Cover plate, Lineryg TR, 2.2mm	F-50, F-52
NSYTRACP44	Cover plate, Lineryg TR, 2.2mm width	F-50, F-52
NSYTRACPE26	Cover plate, Lineryg TR, 2.2mm width	F-54
NSYTRACPK22	Cover plate, Lineryg TR, 2.2mm width	F-57
NSYTRACPK23	Cover plate, Lineryg TR, 2.2mm width	F-57
NSYTRACR22	Cover plate, Lineryg TR, 2.2mm	F-33, F-36, F-49, F-52
NSYTRACR23	Cover plate, Lineryg TR, 2.2mm	F-33, F-36, F-45, F-49, F-52
NSYTRACR24	Cover plate, Lineryg TR, 2.2mm	F-33, F-36, F-45, F-49, F-52
NSYTRACR42	Cover plate, Lineryg TR, 2 points, 2.2mm	F-36, F-49, F-52, F-57
NSYTRACR44	Cover plate, Lineryg TR, 4 points	F-34, F-36
NSYTRACR62	Cover plate, Lineryg TR, 2 points	F-34, F-36
NSYTRACR63	Cover plate, Lineryg TR, 2.2mm width	F-35
NSYTRACR102	Cover plate, Lineryg TR, 2.2mm width	F-35, F-38
NSYTRACR162	Cover plate, Lineryg TR, 2.2mm width	F-35, F-38
NSYTRACRE24	Cover plate, Lineryg TR, 2 level, 2.2mm	F-41, F-42, F-54
NSYTRACRE26	Cover plate, Lineryg TR, 2 level, 2.2mm	F-41
NSYTRACRE44	Cover plate, Lineryg TR, 2 level, 2.2mm width	F-41, F-42
NSYTRACS	Cover plate, Lineryg TR, 2 level, 2.2mm width	F-58
NSYTRACS2	Cover plate, Lineryg TR, 2 level, 2.2mm width	F-6, F-10, F-13, F-14, F-17, F-59
NSYTRACS4	Cover plate, Lineryg TR, 2 level, 2.2mm width	F-12, F-13, F-14, F-16, F-17, F-18, F-19, F-59
NSYTRACS6	Cover plate, Lineryg TR, 2 level, 2.2mm width	F-7, F-10, F-59
NSYTRACS10	Cover plate, Lineryg TR, 2 level, 2.2mm width	F-7, F-11, F-59
NSYTRACS16	Cover plate, Lineryg TR, 2 level, 2.2mm width	F-7, F-11, F-59
NSYTRACS35	Cover plate, Lineryg TR, 2 level, 2.2mm width	F-8, F-11, F-59
NSYTRACSR	Cover plate, Lineryg TR, 2 level, 2.2mm width	F-58



Index of Commercial References With Description

Com. no.	Description	Page
NSYTRACSR2	Cover plate, Linery TR, 2 level, 2.2mm width	F-32, F-33, F-36, F-40, F-41, F-42, F-44, F-45, F-59
NSYTRACSR6	Cover plate, Linery TR, 2 level, 2.2mm width	F-59
NSYTRACT22	Cover plate, Linery TR, 2 points, 2.2mm thickness	F-23
NSYTRAFT	Cover plate, Linery TR, 2 points, 2.2mm thickness	F-6, F-7, F-10, F-12, F-13, F-14, F-16, F-17, F-18, F-19, F-22, F-23, F-24, F-32, F-33, F-34, F-35, F-36, F-37, F-38, F-40, F-41, F-42, F-44, F-45, F-48, F-49, F-50, F-52, F-53, F-54, F-56, F-57, F-58
NSYTRAFTGN	Cover plate, Linery TR, 2 points, 2.2mm thickness	F-23, F-58
NSYTRAFTYE	Cover plate, Linery TR, 2 points, 2.2mm thickness	F-23, F-58
NSYTRAL22	Plug-in bridge, Linery TR, 10 points	F-6, F-10, F-13, F-14, F-17, F-18, F-19, F-26, F-32, F-33, F-40, F-41, F-42, F-44, F-45, F-48, F-49, F-52, F-54, F-55, F-56, F-57
NSYTRAL23	Plug-in bridge, Linery TR, 2 points	F-6, F-10, F-13, F-14, F-17, F-18, F-19, F-26, F-32, F-33, F-40, F-41, F-42, F-44, F-45, F-48, F-49, F-52, F-54, F-55, F-56, F-57
NSYTRAL24	Plug-in bridge, Linery TR, 2 points	F-6, F-10, F-13, F-14, F-17, F-18, F-19, F-26, F-32, F-33, F-40, F-41, F-42, F-44, F-45, F-48, F-49, F-52, F-54, F-55, F-56, F-57
NSYTRAL25	Plug-in bridge, Linery TR, 2 points	F-6, F-10, F-13, F-14, F-17, F-18, F-19, F-26, F-32, F-33, F-40, F-41, F-42, F-44, F-45, F-48, F-49, F-52, F-54, F-55, F-56, F-57
NSYTRAL42	Plug-in bridge, Linery TR, 10 points	F-7, F-10, F-12, F-13, F-14, F-16, F-17, F-19, F-27, F-33, F-34, F-41, F-42, F-49, F-50, F-53, F-57
NSYTRAL43	Plug-in bridge, Linery TR, 2 points	F-7, F-10, F-12, F-13, F-14, F-16, F-17, F-19, F-27, F-33, F-34, F-41, F-42, F-49, F-50, F-53, F-57

Com. no.	Description	Page
NSYTRAL44	Plug-in bridge, Linery TR, 2 points	F-6, F-10, F-13, F-14, F-17, F-18, F-19, F-26, F-32, F-33, F-40, F-41, F-42, F-44, F-45, F-48, F-49, F-52, F-54, F-55, F-56, F-57
NSYTRAL45	Plug-in bridge, Linery TR, 2 points	F-6, F-10, F-13, F-14, F-17, F-18, F-19, F-26, F-32, F-33, F-40, F-41, F-42, F-44, F-45, F-48, F-49, F-52, F-54, F-55, F-56, F-57
NSYTRAL62	Plug-in bridge, Linery TR, 2 points	F-7, F-10, F-22, F-23, F-24, F-34, F-35, F-37
NSYTRAL63	Plug-in bridge, Linery TR, 2 points	F-7, F-10, F-22, F-23, F-24, F-34, F-35
NSYTRAL65	Plug-in bridge, Linery TR, 2 points	F-11
NSYTRAL102	Cover plate, Linery TR, 2 points, 2.2mm thickness	F-7, F-10, F-11, F-34, F-35, F-38
NSYTRAL162	Plug-in bridge, Linery TR, 2 points, for 16mm ² terminal blocks	F-7, F-11, F-35, F-38
NSYTRAL210	Plug-in bridge, Linery TR, 10 points	F-6, F-10, F-13, F-14, F-17, F-18, F-19, F-26, F-32, F-33, F-40, F-41, F-42, F-44, F-45, F-48, F-49, F-52, F-54, F-55, F-56, F-57
NSYTRAL210BL	Plug-in bridge, Linery TR, 10 points	F-6, F-26, F-32, F-33, F-48, F-49
NSYTRAL210GR	Plug-in bridge, Linery TR, 10 points	F-6, F-26, F-32, F-33, F-48, F-49
NSYTRAL220	Plug-in bridge, Linery TR, 2 points	F-6, F-10, F-13, F-14, F-17, F-18, F-19, F-26, F-32, F-33, F-40, F-41, F-42, F-44, F-45, F-48, F-49, F-52, F-54, F-55, F-56, F-57
NSYTRAL352	Plug-in bridge, Linery TR, 2 points	F-8, F-11
NSYTRAL410	Plug-in bridge, Linery TR, 10 points	F-7, F-10, F-12, F-13, F-14, F-16, F-17, F-19, F-27, F-33, F-34, F-41, F-42, F-49, F-50, F-53, F-57
NSYTRAL410BL	Plug-in bridge, Linery TR, 10 points	F-7, F-27, F-33, F-34, F-35, F-49, F-50
NSYTRAL410GR	Plug-in bridge, Linery TR, 10 points	F-7, F-27, F-33, F-34, F-49, F-50
NSYTRAL420	Plug-in bridge, Linery TR, 2 points	F-7, F-10, F-12, F-13, F-14, F-16, F-17, F-18, F-19, F-27, F-33, F-34, F-41, F-42, F-49, F-50, F-53, F-57
NSYTRAL610	Plug-in bridge, Linery TR, 2 points	F-7, F-10, F-11, F-22, F-23, F-24, F-34, F-35, F-37
NSYTRAL702	Plug-in bridge, Linery TR, 2 points	F-8
NSYTRALF1610	Plug-in bridge, Linery TR, 2 points	F-20

Index of Commercial References With Description

Com. no.	Description	Page
NSYTRALR62	Plug-in bridge, Linergy TR, 2 points	F-34, F-35
NSYTRALR102	Plug-in bridge, Linergy TR, 2 points	F-35
NSYTRALV24	Plug-in bridge, Linergy TR, 2 points	F-13, F-14
NSYTRALV24R	Plug-in bridge, Linergy TR, 2 points	F-28, F-40, F-41, F-46, F-54
NSYTRALV352	Plug-in bridge, Linergy TR, 2 points	F-8
NSYTRAP22	Plug-in bridge, Linergy TR, 2 points	F-6, F-7, F-10, F-11, F-24
NSYTRAPE24	Plug-in bridge, Linergy TR, 2 points	F-13, F-14, F-17, F-19
NSYTRAPEN2	Plug-in bridge, Linergy TR, 2 points	F-62
NSYTRAPEN3	Plug-in bridge, Linergy TR, 2 points	F-62
NSYTRAPLOT	Plug-in bridge, Linergy TR, 2 points	F-62
NSYTRAPR23	Plug-in bridge, Linergy TR, 2 points	F-45, F-52
NSYTRAPR24	Plug-in bridge, Linergy TR, 2 points	F-33, F-36, F-45, F-49, F-52, F-57
NSYTRAPR42	Plug-in bridge, Linergy TR, 2 points	F-32, F-33, F-36, F-37, F-48, F-49, F-52
NSYTRASB4	Plug-in bridge, Linergy TR, 2 points	F-6, F-7, F-8, F-9, F-10, F-11, F-12, F-13, F-14, F-16, F-17, F-18, F-19, F-20, F-22, F-23, F-24, F-26, F-27, F-32, F-33, F-34, F-35, F-36, F-37, F-38, F-40, F-41, F-42, F-44, F-45, F-48, F-49, F-50, F-52, F-53, F-54, F-55, F-56, F-57, F-59
NSYTRASF520	Plug-in bridge, Linergy TR, 2 points	F-19, F-45, F-57, F-58
NSYTRASF520B	Plug-in bridge, Linergy TR, 2 points	F-19, F-45, F-57, F-58
NSYTRASF520M	Plug-in bridge, Linergy TR, 2 points	F-19, F-45, F-57, F-58
NSYTRASJ2	Plug-in bridge, Linergy TR, 2 points	F-23
NSYTRASJ4	Plug-in bridge, Linergy TR, 2 points	F-23
NSYTRASJ6	Plug-in bridge, Linergy TR, 2 points	F-23
NSYTRASV	Plug-in bridge, Linergy TR, 2 points	F-58
NSYTRASV1	Plug-in bridge, Linergy TR, 2 points	F-19, F-45, F-57, F-58
NSYTRASV2	Plug-in bridge, Linergy TR, 2 points	F-19, F-45, F-57
NSYTRASV2	Plug-in bridge, Linergy TR, 2 points	F-58
NSYTRAXPV6	Plug-in bridge, Linergy TR, 2 points	F-60
NSYTRP22	Terminal block, Linergy TR	F-46, F-49
NSYTRP22AR	Terminal block, Linergy TR, push-in type	F-46, F-49
NSYTRP22BL	Terminal block, Linergy TR, push-in type	F-46, F-49
NSYTRP22PE	Terminal block, Linergy TR, push-in type, 2 points, 2.5mm ²	F-46, F-52
NSYTRP22SC	Terminal block, Linergy TR, grey, 2.5mm ²	F-46, F-57
NSYTRP22TB	Terminal block, Linergy TR, grey, 2.5mm ²	F-57
NSYTRP22TB	Terminal block, Linergy TR, grey, 2.5mm ²	F-46

Com. no.	Description	Page
NSYTRP23	Terminal block, Linergy TR	F-46, F-49
NSYTRP23AR	Terminal block, Linergy TR	F-46, F-49
NSYTRP23BL	Terminal block, Linergy TR, 2.5mm ²	F-46, F-49
NSYTRP23PE	Terminal block, Linergy TR, push-in type, 3 points, 2.5mm ²	F-46, F-52
NSYTRP23SC	Terminal block, Linergy TR, grey, 2.5mm ² , push-in type	F-46, F-57
NSYTRP24	Terminal block, Linergy TR, 2.5mm ²	F-46, F-49
NSYTRP24BL	Terminal block, Linergy TR, 2.5mm ²	F-46, F-49
NSYTRP24D	Terminal block, Linergy TR, 2.5mm ²	F-46, F-54
NSYTRP24DBL	Terminal block, Linergy TR, 2.5mm ²	F-46, F-54
NSYTRP24DPE	Terminal block, Linergy TR, 2.5mm ²	F-46, F-54
NSYTRP24PE	Terminal block, Linergy TR, push-in type, 4 points, 2.5mm ²	F-46, F-52
NSYTRP24SC	Terminal block, Linergy TR, push-in type, 4 points, 2.5mm ²	F-46
NSYTRP26T	Terminal block, Linergy TR, 2.5mm ²	F-54
NSYTRP42	Terminal block, Linergy TR, 4mm ²	F-46, F-49
NSYTRP42BL	Terminal block, Linergy TR, 4mm ²	F-46, F-49
NSYTRP42PE	Terminal block, Linergy TR, 4mm ²	F-46, F-52
NSYTRP42TB	Terminal block, Linergy TR, 4mm ²	F-46, F-57
NSYTRP43	Terminal block, Linergy TR, 4mm ²	F-46, F-50
NSYTRP43BL	Terminal block, Linergy TR, 4mm ²	F-46, F-50
NSYTRP43PE	Terminal block, Linergy TR, 4mm ²	F-46, F-52
NSYTRP44	Terminal block, Linergy TR, 4mm ²	F-46, F-50
NSYTRP44BL	Terminal block, Linergy TR, push-in type, feed through, 4 points, 4mm ²	F-46, F-50
NSYTRP44PE	Terminal block, Linergy TR, push-in type, 4 points, 4mm ²	F-46, F-52
NSYTRR22	Terminal block, Linergy TR, 16mm ²	F-28, F-33
NSYTRR22BL	Terminal block, Linergy TR, 16mm ²	F-28, F-33
NSYTRR22MP	Terminal block, Linergy TR, 16mm ²	F-30
NSYTRR22PE	Terminal block, Linergy TR, 16mm ²	F-28, F-36
NSYTRR22SC	Terminal block, Linergy TR, 16mm ²	F-30, F-45
NSYTRR22TB	Terminal block, Linergy TR, 16mm ²	F-30, F-45
NSYTRR23	Terminal block, Linergy TR, 16mm ²	F-28, F-33
NSYTRR23BL	Terminal block, Linergy TR, 16mm ²	F-28, F-33
NSYTRR23PE	Terminal block, Linergy TR, 16mm ²	F-28, F-36
NSYTRR23SC	Terminal block, Linergy TR, 16mm ²	F-30, F-45
NSYTRR23TB	Terminal block, Linergy TR, 16mm ²	F-30, F-45
NSYTRR24	Terminal block, Linergy TR, 16mm ²	F-28, F-33
NSYTRR24BL	Terminal block, Linergy TR, 16mm ²	F-28, F-33
NSYTRR24D	Terminal block, Linergy TR, 16mm ²	F-30, F-41
NSYTRR24DBL	Terminal block, Linergy TR, 16mm ²	F-30, F-41
NSYTRR24DPE	Terminal block, Linergy TR, 16mm ²	F-30, F-42
NSYTRR24MFBL	Terminal block, Linergy TR, 16mm ²	F-30
NSYTRR24PE	Terminal block, Linergy TR, 16mm ²	F-28, F-36
NSYTRR24SCD	Terminal block, Linergy TR, 16mm ²	F-30
NSYTRR26T	Terminal block, Linergy TR, 16mm ²	F-30, F-41
NSYTRR26TBL	Terminal block, Linergy TR, 16mm ²	F-30, F-41
NSYTRR26TPE	Terminal block, Linergy TR, 16mm ²	F-30



Index of Commercial References With Description

Com. no.	Description	Page
NSYTRR42	Terminal block, Lineryg TR, 16mm ²	F-28, F-33
NSYTRR42BL	Terminal block, Lineryg TR, 16mm ²	F-28, F-33
NSYTRR42PE	Terminal block, Lineryg TR, 16mm ²	F-28, F-36
NSYTRR42TB	Terminal block, Lineryg TR, 16mm ²	F-30
NSYTRR43	Terminal block, Lineryg TR, 16mm ²	F-28, F-33
NSYTRR43BL	Terminal block, Lineryg TR, 16mm ²	F-28
NSYTRR43PE	Terminal block, Lineryg TR, 16mm ²	F-28
NSYTRR44	Terminal block, Lineryg TR, 16mm ²	F-28, F-34
NSYTRR44BL	Terminal block, Lineryg TR, 16mm ²	F-28
NSYTRR44D	Terminal block, Lineryg TR, 16mm ²	F-30, F-41
NSYTRR44DBL	Terminal block, Lineryg TR, 16mm ²	F-30, F-41
NSYTRR44DPE	Terminal block, Lineryg TR, 16mm ²	F-30, F-42
NSYTRR44PE	Terminal block, Lineryg TR, 16mm ²	F-28, F-36
NSYTRR62	Terminal block, Lineryg TR, 16mm ²	F-28, F-34
NSYTRR62BL	Terminal block, Lineryg TR, 16mm ²	F-28, F-34
NSYTRR62PE	Terminal block, Lineryg TR, 16mm ²	F-28, F-36
NSYTRR63	Terminal block, Lineryg TR, 16mm ²	F-28, F-34
NSYTRR102	Terminal block, Lineryg TR, push-in type, 4 points, 4mm ²	F-28, F-34
NSYTRR102BL	Terminal block, Lineryg TR, push-in type, 4 points, 4mm ²	F-28, F-34
NSYTRR102PE	Terminal block, Lineryg TR, push-in type, 4 points, 4mm ²	F-28, F-38
NSYTRR162	Terminal block, Lineryg TR, push-in type, 4 points, 4mm ²	F-28, F-34
NSYTRR162BL	Terminal block, Lineryg TR, push-in type, 4 points, 4mm ²	F-28, F-34
NSYTRR162PE	Terminal block, Lineryg TR, 16mm ²	F-28, F-38
NSYTRR352	Terminal block, Lineryg TR, 16mm ²	F-28
NSYTRR352BL	Terminal block, Lineryg TR, 16mm ²	F-28
NSYTRR352PE	Terminal block, Lineryg TR, 16mm ²	F-28
NSYTRV22	Screw terminal, feed through	F-2, F-7
NSYTRV22AR	Screw terminal, feed through	F-2, F-7
NSYTRV22BL	Screw terminal, feed through	F-2, F-7
NSYTRV22M	Screw terminal, feed through	F-4, F-27
NSYTRV22MBL	Screw terminal, feed through	F-4, F-27
NSYTRV22MPE	Mini terminal block, Lineryg TR, green-yellow, 2.5 mm ²	F-4, F-27
NSYTRV22PE	Terminal block, Lineryg TR, 2.5mm ²	F-2, F-11
NSYTRV22RD	Terminal block, Lineryg TR, 2.5mm ²	F-2, F-7
NSYTRV22SC	Terminal block, Lineryg TR, 2.5mm ²	F-4, F-19
NSYTRV22ST	Terminal block, Lineryg TR, 2.5mm ²	F-4, F-19
NSYTRV22TB	Terminal block, Lineryg TR, 2.5mm ²	F-4, F-19
NSYTRV22WH	Terminal block, Lineryg TR, 2.5mm ²	F-2, F-7
NSYTRV23PE	Terminal block, Lineryg TR, 2.5mm ²	F-4
NSYTRV24D	Screw terminal, feed through	F-4, F-13
NSYTRV24DBL	Screw terminal, feed through	F-4, F-13
NSYTRV24DPE	Screw terminal, feed through	F-4, F-17
NSYTRV24PE	Screw terminal, feed through	F-4
NSYTRV26T	Screw terminal, 3 levels	F-4, F-14
NSYTRV26TBL	Screw terminal, 3 levels	F-4, F-14
NSYTRV26TC	Screw terminal, 3 levels	F-4

Com. no.	Description	Page
NSYTRV42	Screw terminal, feed through	F-2, F-7
NSYTRV42AR	Screw terminal, feed through	F-2, F-7
NSYTRV42BK	Screw terminal, feed through	F-2
NSYTRV42BL	Screw terminal, feed through	F-2, F-7
NSYTRV42GN	Screw terminal, feed through	F-2, F-7
NSYTRV42M	Screw terminal, feed through	F-4, F-27
NSYTRV42MBL	Screw terminal, feed through	F-4, F-27
NSYTRV42MPE	Screw terminal, mini, for 15mm din rail, protective earth, 2PTS, 4mm ²	F-4, F-27
NSYTRV42PE	Terminal block, Lineryg TR, 4mm ²	F-2, F-11
NSYTRV42RD	Terminal block, Lineryg TR, 4mm ²	F-2, F-7
NSYTRV42SC	Terminal block, Lineryg TR, 4mm ²	F-4, F-19
NSYTRV42SCD	Terminal block, Lineryg TR, 4mm ²	F-4, F-19
NSYTRV42SF5	Terminal block, Lineryg TR, 4mm ²	F-4, F-20
NSYTRV42SF5LA	Terminal block, Lineryg TR, with 110 to 250V led	F-20
NSYTRV42SF5LD	Terminal block, Lineryg TR, with 12 to 30V led	F-4, F-20
NSYTRV42SF6	Terminal block, Lineryg TR, with 12 to 30V led	F-4, F-20
NSYTRV42SF6LA	Terminal block, Lineryg TR, with 12 to 30V led	F-20
NSYTRV42SF6LD	Terminal block, Lineryg TR, with 12 to 30V led	F-4, F-20
NSYTRV42ST	Terminal block, Lineryg TR, with 12 to 30V led	F-19
NSYTRV42STAR	Terminal block, Lineryg TR, with 12 to 30V led	F-4, F-19
NSYTRV42TB	Terminal block, Lineryg TR, 4mm ²	F-4, F-19
NSYTRV42WH	Terminal block, Lineryg TR, 4mm ²	F-2, F-7
NSYTRV43	Screw terminal, feed through	F-4, F-13
NSYTRV43BL	Screw terminal, feed through	F-4, F-13
NSYTRV43PE	Screw terminal, protective earth, 3 points, 4mm ²	F-2, F-4, F-17
NSYTRV44	Screw terminal, feed through	F-4, F-13
NSYTRV44BL	Screw terminal, protective earth, 3 points, 4mm ²	F-4, F-13
NSYTRV44D	Terminal block, Lineryg TR, 4mm ²	F-4, F-14
NSYTRV44DBL	Terminal block, Lineryg TR, 4mm ²	F-4, F-14
NSYTRV44DPE	Terminal block, Lineryg TR, 4mm ²	F-4, F-17
NSYTRV44PE	Terminal block, Lineryg TR, 4mm ²	F-2, F-4, F-17
NSYTRV62	Terminal block, Lineryg TR, 16mm ²	F-2, F-7
NSYTRV62BL	Terminal block, Lineryg TR, 16mm ²	F-2, F-7
NSYTRV62NE	Terminal block, Lineryg TR, 16mm ²	F-4, F-24
NSYTRV62PE	Terminal block, Lineryg TR, 16mm ²	F-2, F-11, F-36
NSYTRV62TT	Terminal block, Lineryg TR, 16mm ²	F-23
NSYTRV62TTD	Terminal block, Lineryg TR, 16mm ²	F-4, F-23
NSYTRV62TTPE	Terminal block, Lineryg TR, 16mm ²	F-4, F-23
NSYTRV102	Terminal block, Lineryg TR, 16mm ²	F-2, F-7
NSYTRV102BL	Terminal block, Lineryg TR, 16mm ²	F-2, F-7
NSYTRV102PE	Terminal block, Lineryg TR, 16mm ²	F-2, F-11
NSYTRV162	Terminal block, Lineryg TR, 16mm ²	F-2, F-7
NSYTRV162BL	Terminal block, Lineryg TR, 16mm ²	F-2, F-7
NSYTRV162PE	Terminal block, Lineryg TR, 16mm ²	F-2, F-11

Index of Commercial References With Description

Com. no.	Description	Page
NSYTRV162SF	Terminal block, Linergy TR, 16mm ²	F-4, F-20
NSYTRV352	Screw terminal, 3 levels	F-2, F-8
NSYTRV352BL	Screw terminal, 3 levels	F-2, F-8
NSYTRV352PE	Screw terminal, 3 levels	F-2, F-11
NSYTRV502	Terminal block, Linergy TR, 16mm ²	F-2, F-8
NSYTRV502BL	Terminal block, Linergy TR, 16mm ²	F-2, F-8
NSYTRV502PE	Terminal block, Linergy TR, 16mm ²	F-2, F-11
NSYTRV702	Terminal block, Linergy TR, 16mm ²	F-2, F-8
NSYTRV702BL	Terminal block, Linergy TR, 16mm ²	F-2, F-8
NSYTRV1502B	Terminal block, Linergy TR, 16mm ²	F-2, F-9

R...

R9XE110	Caps	C-10
R9XE210	Caps	C-10
R9XE310	Caps	C-10
R9XE410	Caps	C-10
R9XFC04	Connector	C-10
R9XFH112	Resi9 - comb busbar - 1L - 18 mm	C-10
R9XFH118	Resi9 - comb busbar - 1L - 18 mm	C-10
R9XFH157	Resi9 - comb busbar - 1L - 18 mm	C-10
R9XFH212	Resi9 - comb busbar - 1L+N - 18 mm	C-10
R9XFH218	Resi9 - comb busbar - 1L+N - 18 mm	C-10
R9XFH257	Resi9 - comb busbar - 1L+N - 18 mm	C-10
R9XFH312	Resi9 - comb busbar - 3L - 18 mm	C-10
R9XFH318	Resi9 - comb busbar - 3L - 18 mm	C-10
R9XFH357	Resi9 - comb busbar - 3L - 18 mm	C-10
R9XFH412	Resi9 - comb busbar - 3L+N - 18 mm	C-10
R9XFH418	Resi9 - comb busbar - 3L+N - 18 mm	C-10
R9XFH457	Resi9 - comb busbar - 3L+N - 18 mm	C-10
R9XFH518	Resi9 - comb busbar - 3L+N balanced - 18 mm	C-10
R9XFH518G	Resi9 - comb busbar - 3L+N balanced - 18 mm	C-10
R9XFH557	Resi9 - comb busbar - 3L+N balanced - 18 mm	C-10
R9XT20	Caps	C-10



All Schneider Electric
distribution and connection
systems have been brought
together into a single brand
name:

Linergy

Think Lineryg!

A



Because Lineryg is...



Flexible

- > **Lineryg** is a complete range of more than 900 references, suitable for all type of applications (electrical distribution, process and control, datacenters, etc.).
- > **Lineryg** can be easily adapted to technical demand, customer habits and preferences.
- > Thanks to their ComPacTness, **Lineryg** products can be easily installed into a minimum of space.
- > **Lineryg** is easy to implement in the shortest possible time.
- > With **Lineryg** you can make changes to your panel on the installation site, right up to the last minute.



Safer

- > **Lineryg** IPxxB everywhere.
- > **Lineryg** "Hot plug" solution, enabling connections without turning off the switchboard (energised connection).
- > **Lineryg** simplifies wiring, thus directly contributing to enhancing panel reliability.



Reliable

- > **Lineryg** is fully compliant with IEC standards, and some systems are also multi-standard.
- > All **Lineryg** distribution and connection systems have been designed and tested to work together (synergies with Schneider Electric devices).
- > **Lineryg**, brings you the benefit of an energy-efficient switchboard.

And much more...



Linery

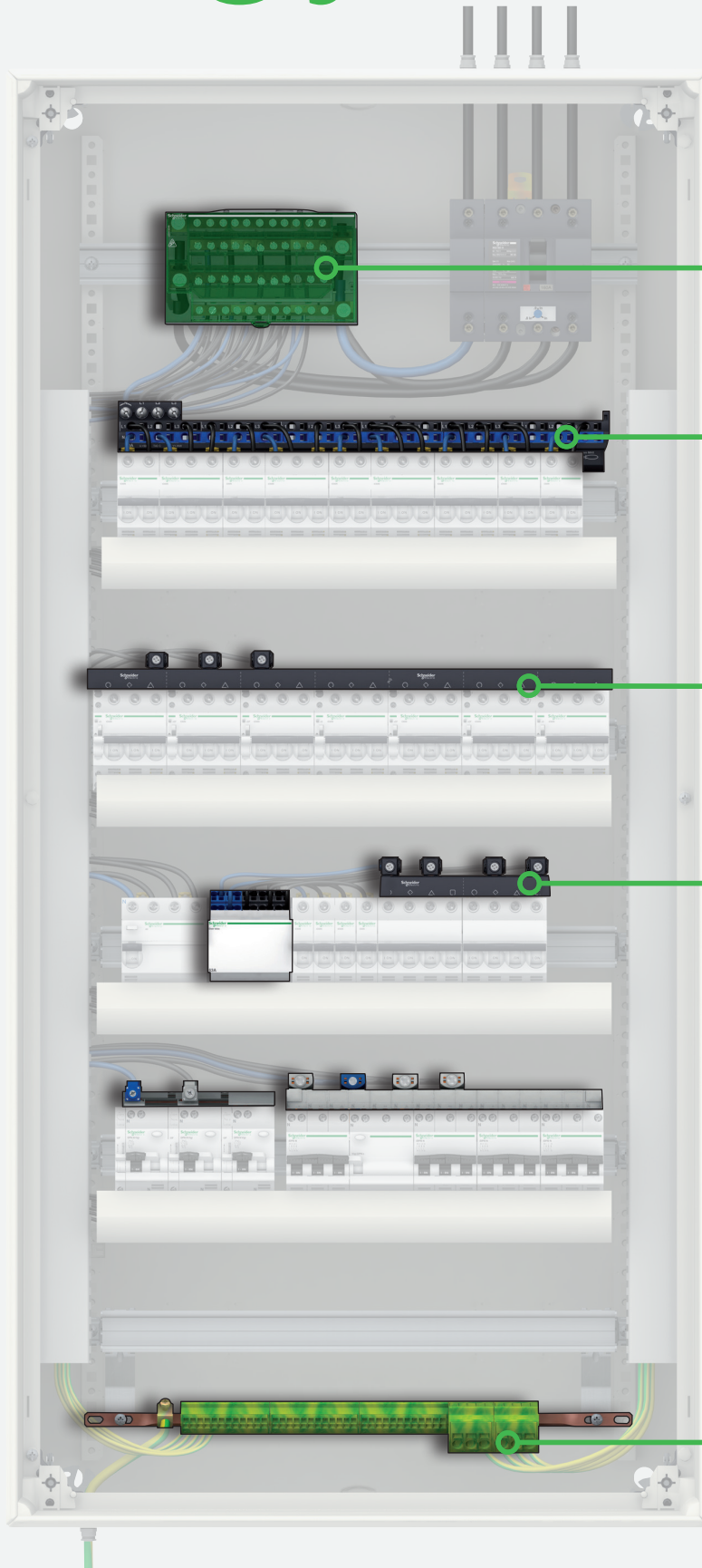
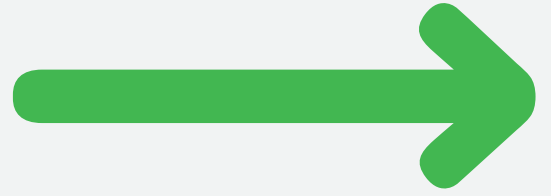

Inside PrismaSeT Enclosures and Switchboards, you benefit from IEC 61439 tested solutions.

With Linergy, you will be able to connect your rows regardless of the enclosure you have chosen.

Linergy DS

Distribution Blocks



- > ComPacT solution
- > Cabling capacity of up to 60 connection points
- > Screw connection models

Linergy FM

Device Feeders



- > Quick distribution of up to 54 outgoers
- > Maximum flexibility to balance your phases
- > No creepage campaign thanks to clamp technology

Linergy FH

Device Feeders

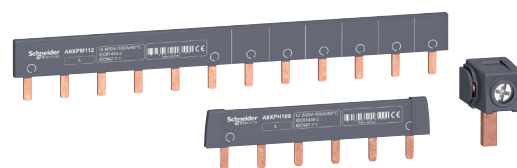

- > Complete family of products to cover all needs
- > Easy to install
- > ComPacTness up to 100 A

Linergy TB

Earth Bars and PE Connectors



- > Minimum space required
- > Quick connection models

A

Lineryg offers you smart power network solutions for your switchboard.

Lineryg BW

Power Busbars



- > Solutions available up to 630 A
- > Solutions can be adapted to all switchboard architectures

Lineryg FM

Device Feeders



- > Maximum flexibility to balance your phases

Lineryg DX

Distribution Blocks



- > Quick connection models
- > Easy to wire
- > ComPacT solution
- > Cabling capacity of up to 52 connection points

Lineryg FH

Device Feeders

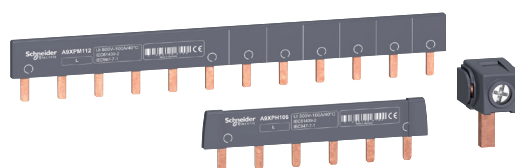

- > All lengths available (up to 1 m)
- > Comb busbars compatible with auxiliaries

Lineryy

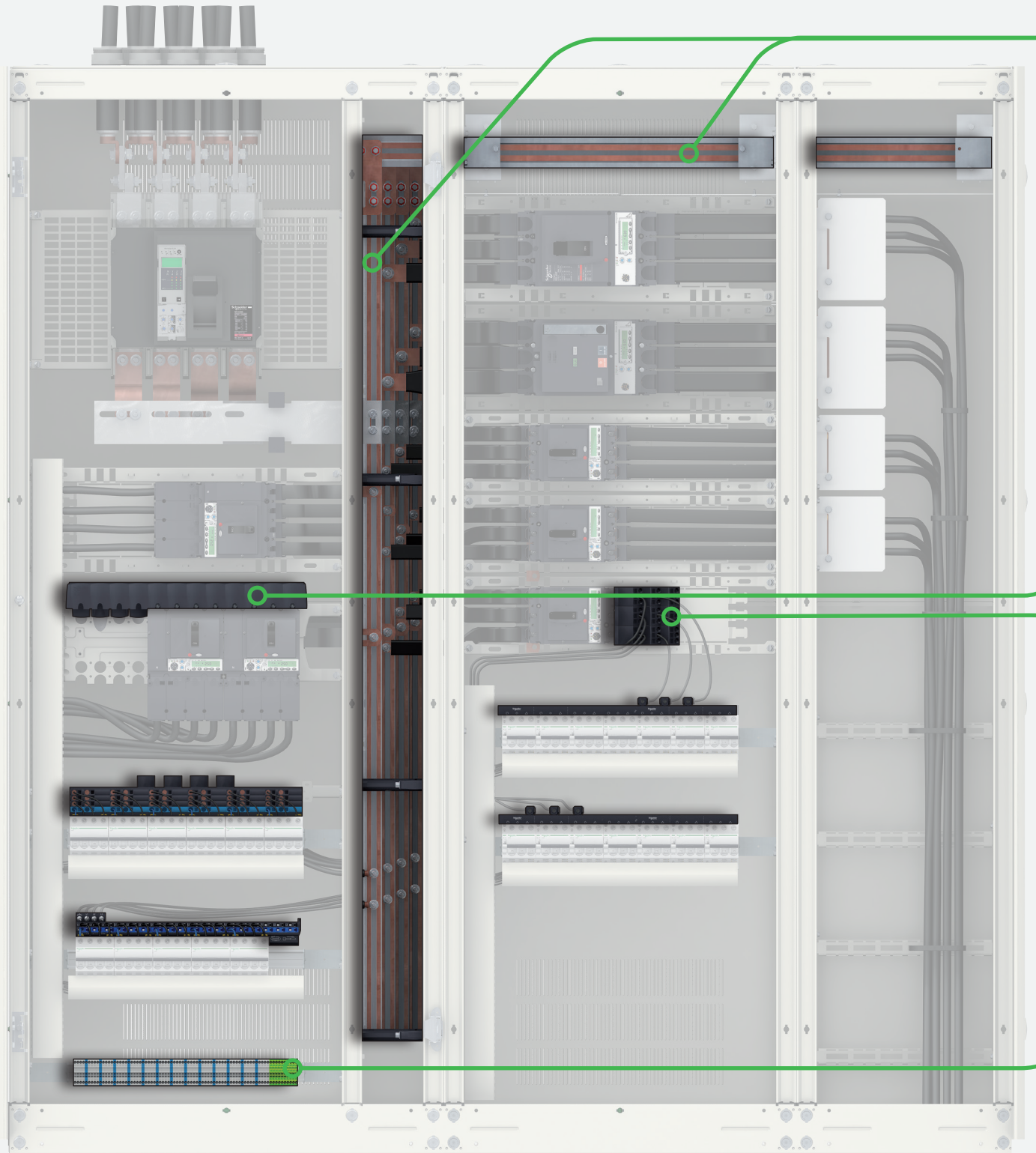
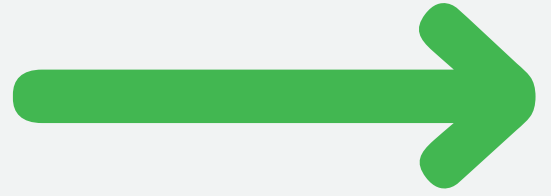

Inside PrismaSeT Enclosures and Switchboards, you benefit from IEC 61439 tested solutions.

Lineryg also offers the most advanced busbar solutions while remaining simple.

A

Lineryg LGY/ LGYE

Power Busbars

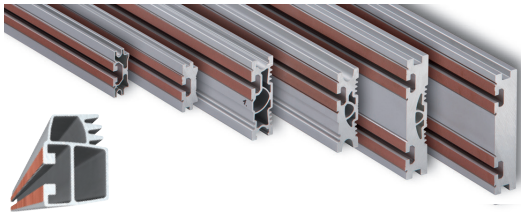

- > Solutions available up to 4000 A
- > Connection everywhere without drilling (with LGY and LGYE profile)

Lineryg FC

Device Feeders

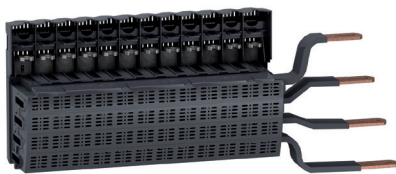

- > ComPacT NSXm (4 x 4P / 5 x 3P) solution
- > ComPacT NSX (3 x 4P / 4 x 3P) solution
- > Reliable connection
- > Quick connection system dedicated to ComPacT NSXm up to 160 A/ ComPacT NSX up to 250 A

Lineryg DP

Distribution Blocks

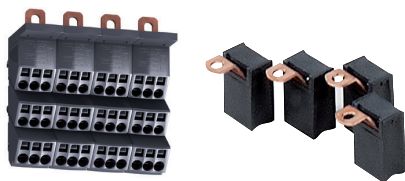

- > Simplicity of use
- > Quick connection system dedicated to ComPacT NSXm up to 160 A/ ComPacT NSX up to 250 A

Lineryg TR

Terminal Blocks

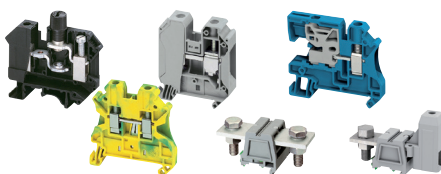

- > Simplicity of use
- > Consistency and cross-functionality guaranteed
- > Few references for a maximum of applications

Lineryg

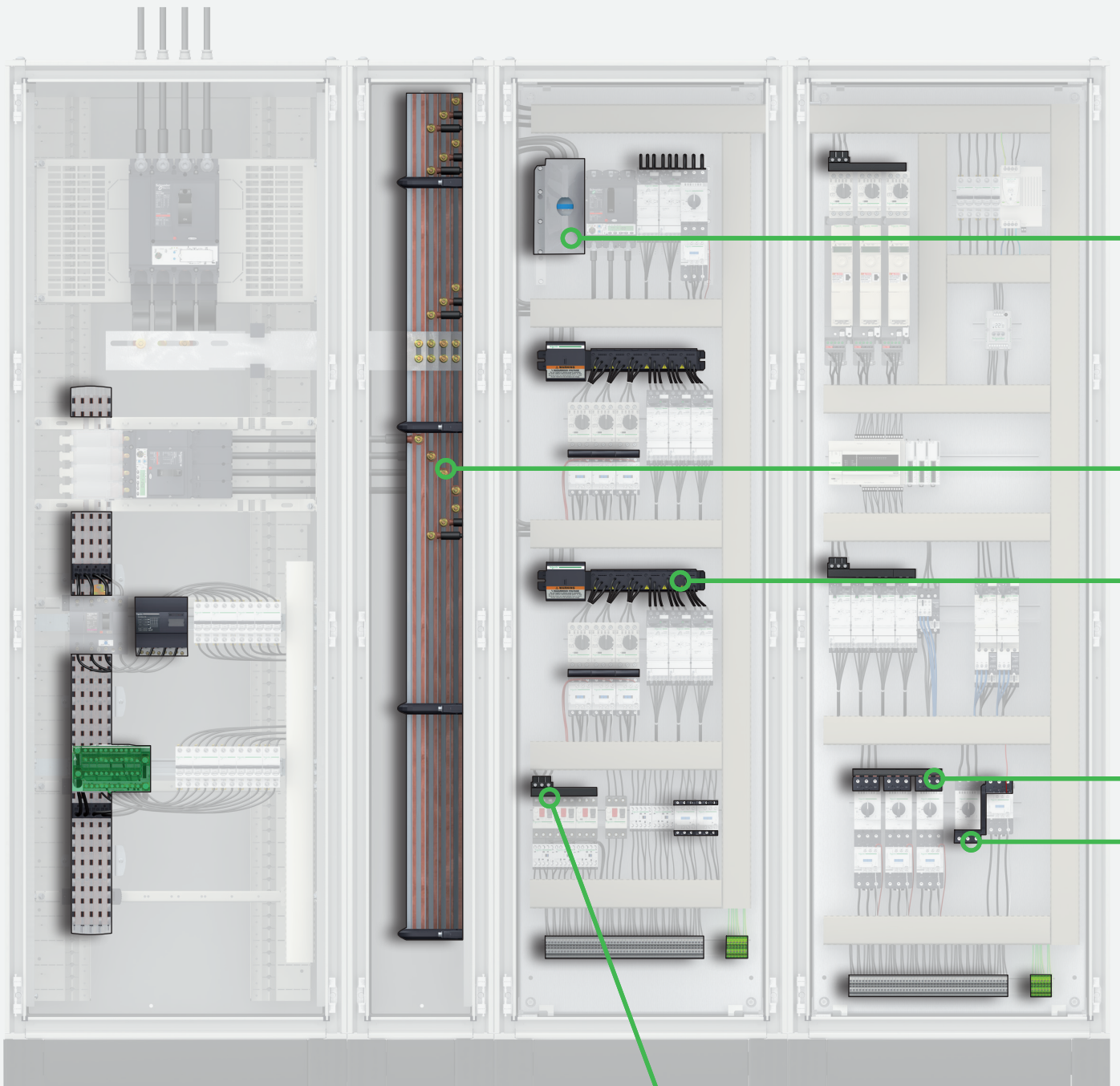
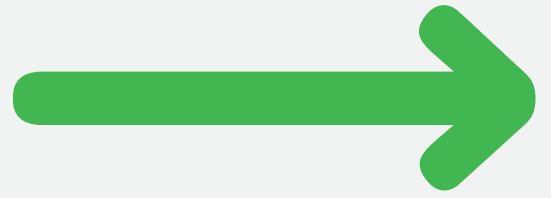

Thanks to Linergy, you can have the scalable and flexible panel that you deserve.

Linergy BZ

Power Busbars

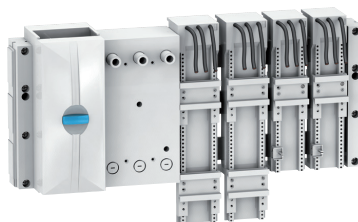

- > Quick connection plates for ComPacT and TeSys offers
- > Multi-standard offering up to 630 A

Linergy LGY / LGYE

Power Busbars

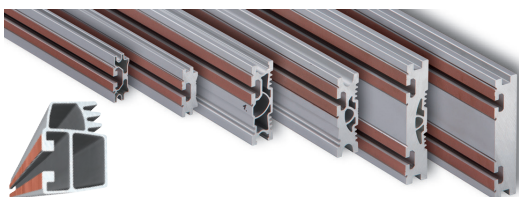

- > Solutions available up to 4000 A
- > Panel devices powered everywhere inside the panel

Linergy HK

"Hot Plug" Distribution



- > Panel easily upgradeable
- > Reliable "hot plug" modification or upgrade
- > Multi-standard system of up to 160 A

Linergy FT

Device Feeders

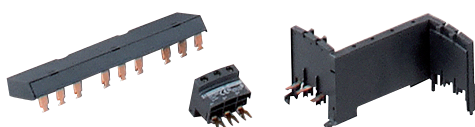

- > Optimised productivity and efficiency of your control panel
- > Easy to install
- > High reliability

A



GreenPremium™

Endorsing eco-friendly products in the industry



Green Premium is the only label that allows you to effectively develop and promote an environmental policy whilst preserving your business efficiency. This eco label guarantees compliance with up-to-date environmental regulations, but it does more than this.

Over 75% of Schneider Electric manufactured products have been awarded the Green Premium eco label



Discover what we mean by green...

Check your products!

Schneider Electric's Green Premium eco label is committed to offering transparency, by disclosing extensive and reliable information related to the environmental impact of its products:

RoHS

Schneider Electric products are subject to RoHS requirements at a world wide level, even for the many products that are not required to comply with the terms of the regulation. Compliance certificates are available for products that fulfil the criteria of this European initiative, which aims to eliminate hazardous substances.

REACH

Schneider Electric applies the strict REACH regulation on its products at a worldwide level, and discloses extensive information concerning the presence of SVHC (Substances of Very High Concern) in all of its products.

PEP: Product Environmental Profile

Schneider Electric publishes complete set of environmental data, including carbon footprint and energy consumption data for each of the life cycle phases on all of its products, in compliance with the ISO 14025 PEP e-passport program. PEP is especially useful for monitoring, controlling, saving energy, and/or reducing carbon emissions.

EoLI: End of Life Instructions

Available at the click of a button, these instructions provide:

- Recyclability rates for Schneider Electric products
- Guidance to mitigate personnel hazards during the dismantling of products and before recycling operations
- Parts identification for recycling or for selective treatment, to mitigate environmental hazards/incompatibility with standard recycling processes

Distribution blocks

Contents

Lineryg DS	B - 2
Screw distribution blocks	B - 2
Lineryg DX	B - 4
Quick distribution blocks	B - 4
Lineryg DP	B - 6
Quick distribution blocks - ComPacT NSX and INS-INV up to 250 A	B - 6
Quick distribution blocks - ComPacT NSXm up to 160 A	B - 7

Linergy DS

Screw distribution blocks



IEC/EN 60947-7-1, IEC/EN 61439-1 & 2





Description

- Single-pole or four-pole distribution block that can be installed on a standard DIN rail or on a mounting plate.
- Compatible with PrismaSeT G and PrismaSeT P, Pragma, Mini Pragma and Resbo series switchboards.
- Incomers and feeders are connected to screw terminals that accept rigid or flexible cables with ferrule.
- Optional: additional neutral terminal strip for four-pole distribution block.

Advantages

- Simplified power supply for main incomers.
- Easy phase balancing.
- Easy, effortless cabling due to excellent accessibility.
- Visible cabling.
- Insulation between phases.
- The single-pole distribution blocks are adjacent and bridgeable via the second incoming hole for parallel connection.

Screw distribution blocks

Number of poles	1P			4P
				
Rated operational current	125 A	160 A	250 A	100 A
Total connections capacity	10	13	14	4 x 7
Terminal capacity				
Diameter	2 x Ø 9.5 mm	2 x Ø 12 mm	1 x Ø 15.3 mm	2 x Ø 7.5 mm
	2 x Ø 7.5 mm	3 x Ø 7.5 mm	1 x Ø 10 mm	5 x Ø 5.5 mm
	6 x Ø 5.8 mm	8 x Ø 5.8 mm	4 x Ø 6 mm	-
	-	-	8 x Ø 7.5 mm	-
Rated peak withstand current (Ipk)	25 kA	36 kA	60 kA	24 kA
Rated short-time withstand current (Icw) (IEC/EN 60947-7-1)	4.2 kArms/1 s	8.4 kArms/1 s	14.4 kArms/1 s	3 kArms/1 s
Width (number of 9 mm pitches)	3	4	5	8
Dimension (H x W x D)	85 x 27 x 50.5	85 x 36 x 50.5	85 x 45 x 50.5	100 x 71 x 50.5
Weight (g)	125	163	239	210
Neutral terminal strip (optional)	-	-	-	LGYN1007
Reference	LGY112510	LGY116013	LGY125014	LGY410028

Linery DS

Screw distribution blocks



On LGY412560 and LGY416048 references
Input cabling facilitated by side terminals

Technical data

Common characteristics

Rated insulation voltage (Ui)	500 V AC
Rated operational voltage (Ue)	230 V AC (Ph/N) 440 V AC (Ph/Ph)
Rated impulse withstand voltage (Uimp)	8 kV
Rated conditional short-circuit current of an assembly	Up to the breaking capacity of Schneider Electric feeder circuit breakers, even in cascading configuration
Network frequency	50/60 Hz
Pollution degree	3
Overvoltage category	III

Additional technical characteristics

Reference temperature	40°C
Operating temperature	-25°C to 55°C
Dielectric withstand (IEC/EN 60947-1)	2500 V AC

B

			Neutral terminal strip		
125 A	160 A	160 A	100 A	125 A	150 A
4 x 12	4 x 15	4 x 12	7	12	15
1 x Ø 9 mm	1 x Ø 9.5 mm	1 x Ø 12 mm	2 x Ø 7.5 mm	1 x Ø 9 mm	1 x Ø 9.5 mm
7 x Ø 7.5 mm	3 x Ø 8.5 mm	3 x Ø 9 mm	5 x Ø 5.5 mm	7 x Ø 7.5 mm	3 x Ø 8.5 mm
4 x Ø 6.5 mm	11 x Ø 6.5 mm	8 x Ø 7.5 mm	-	4 x Ø 6.5 mm	11 x Ø 6.5 mm
-	-	-	-	-	-
26 kA	28 kA	36 kA	-	-	-
4.2 kArms/1 s	4.2 kArms/1 s	8.4 kArms/1 s	-	-	-
14	20	18	7	14	17
100 x 126 x 50.5	100 x 162 x 50.5	100 x 174 x 50.5	20 x 70 x 35	20 x 125 x 35	20 x 155 x 35
390	559	567	63	111	149
LGYN12512	LGYN12515	LGYN12512	-	-	-
LGY412548	LGY412560	LGY416048	LGYN1007	LGYN12512	LGYN12515

Terminal technical data

Type		P22 screw							
Diameter		Ø 5.5 mm	Ø 5.8 mm	Ø 6 mm	Ø 6.5 mm	Ø 7.5 mm	Ø 8.5 mm	Ø 9 mm	Ø 9.5 mm
Section	Rigid cable	1.5 to 16 mm ²	1.5 to 16 mm ²	1.5 to 16 mm ²	1.5 to 16 mm ²	2.5 to 25 mm ²	6 to 35 mm ²	10 to 35 mm ²	10 to 35 mm ²
	Flexible cable or with ferrule	1.5 to 10 mm ²	1.5 to 10 mm ²	1.5 to 10 mm ²	1.5 to 10 mm ²	1.5 to 16 mm ²	4 to 25 mm ²	4 to 25 mm ²	6 to 35 mm ²
Tightening torque		2 N.m	2 N.m	2 N.m	2 N.m	2 N.m	2 N.m	2.5 N.m	2.5 N.m
Type		Hc screw							
Diameter		Ø 9.5 mm	Ø 10 mm	Ø 12 mm	Ø 15.3 mm	-			
Section	Rigid cable	10 to 35 mm ²	1.5 to 50 mm ²	25 to 70 mm ²	35 to 120 mm ²	-			
	Flexible cable or with ferrule	6 to 35 mm ²	1.5 to 35 mm ²	16 to 50 mm ²	25 to 95 mm ²	-			
Tightening torque		8 N.m	4 N.m	1 P: 9 N.m	4P: 5 N.m	14 N.m			

Linergy DX

Quick distribution blocks

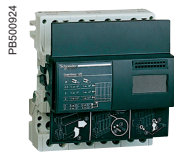

IEC 60947-7-1, IEC 61439-2



Description

- Downstream circuits are connected from the front, to spring terminals.
- Contact pressure automatically adapts to the size of the conductor.
- Contacts are insensitive to vibrations and thermal variations.
- Only one cable (flexible or rigid) can be inserted per terminal.

Quick distribution blocks

Number of poles		4P, incomers from top	4P, incomers from bottom
			
Rated operational current at 40°	(Ie)	63 A	63 A
Rated conditional short-circuit current of an assembly	(Isc)	The reinforced breaking capacity due to cascading in circuit breaker combinations is maintained. The worst-case situations have been tested.	The reinforced breaking capacity due to cascading in circuit breaker combinations is maintained. The worst-case situations have been tested.
Rated insulation voltage	(Ui)	500 V AC	500 V AC
Rated operational voltage	(Ue)	440 V AC	440 V AC
Rated impulse withstand voltage	(Uimp)	6 kV	6 kV
Rated short-time current Icw	(Icw)		
Rated operational frequency		50/60 Hz	50/60 Hz
Degree of protection		IPxxB	IPxxB
Incoming terminals		1 tunnel terminal 25 ² /ph	1 tunnel terminal 25 ² /ph
Total connection capacity, outgoing terminals		24 connections: 4 x 6 ² /phase 12 x 6 ² /neutral	24 connections: 4 x 6 ² /phase 12 x 6 ² /neutral
Dimensions (H x W x D)		96.5 x 72 x 62 8 x 9 mm pitch	96.5 x 72 x 62 8 x 9 mm pitch
Installation		Clipped onto a DIN rail	Clipped onto a DIN rail
Other			
Standard for installation inside PrismaSeT		IEC 61439-2	IEC 61439-2
Glow-wire 60695-2-11		960°C	960°C
Degree of pollution		3	3
References		LVS04040	LVS04041

Accessories

References	-	-
------------	---	---



Linergy DX

Quick distribution blocks

Advantages

- A reliable electrical connection, no maintenance required (tightness guaranteed over time).
- Quick connection.
- Easy phase balancing.
- Ease of rewiring if the switchboard is expanded or modified.

B

4P		1P	
			
125 A	160 A	160 A	
20 kA/60 ms max according to IEC 61439-1	20 kA/60 ms max according to IEC 61439-1	32 kA	
750 V	750 V	750 V	
690 VAC	690 VAC	690 VAC	
8 kV	8 kV	8 kV	
4.5 kA rms/1s	4.5 kA rms/1s		
50/60 Hz	50/60 Hz	50/60 Hz	
IPxxB	IPxxB	IPxxB	
1 tunnel terminal 35 ² /ph	1 tunnel terminal 35 ² /ph	1 tunnel terminal 70/ph	
52 connections: 7 x 4 ² /phase 3 x 6 ² /phase 2 x 10 ² /phase 1 x 16 ² /phase (screw terminal)	52 connections: 7 x 4 ² /phase 3 x 6 ² /phase 2 x 10 ² /phase 1 x 16 ² /phase (screw terminal)	6 connections: 6 x 16 ² /phase	
127 x 108 x 48 8 x 9 mm pitch	127 x 108 x 48 8 x 9 mm pitch	95 x 36 x 70 4 x 9 mm pitch	
Screwed to plain or slotted backplate or onto DIN rail	Screwed to plain or slotted backplate or onto DIN rail	Onto DIN rail	
Possible to combine 2 terminal blocks (2nd terminal block supplied from enclosed terminals in the 1st, I _{max} of 2nd terminal block: 80 A)	Possible to combine 2 terminal blocks (2nd terminal block supplied from enclosed terminals in the 1st, I _{max} of 2nd terminal block: 80 A)		
IEC 61439-2	IEC 61439-2	IEC 61439-2	
960°C	960°C	960°C	
3	3	3	
LVS04045	LVS04046	LVS04031	
(4 x 125 A flexible connectors)		Copper spacer (batch of 4)	
LVS04047		LVS04037	

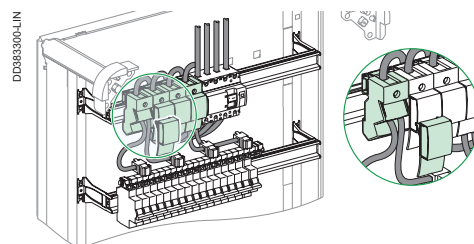
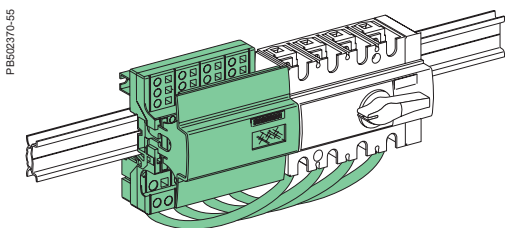

Linery DP

Quick distribution blocks for ComPacT NSX and INS-INV up to 250 A

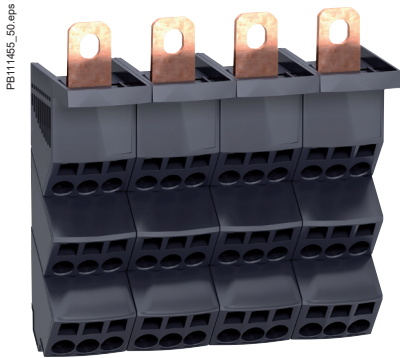



IEC 60947-7-1, IEC 61439-1 and 2

Description

- The Linery DP Quick distribution block is designed for installation directly downstream of ComPacT NSX and INS-INV up to 250 A. It can also be clipped onto a modular rail.

Advantages

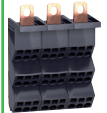
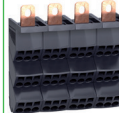
- It is quick to mount in the horizontal position. Electrical connections are made directly to the device terminals.
- It is the same width as the devices and does not take up any additional space in the switchboard.
- The connection terminals are slanted to facilitate cable entry and avoid exceeding the bending radius of the flexible and rigid cables.

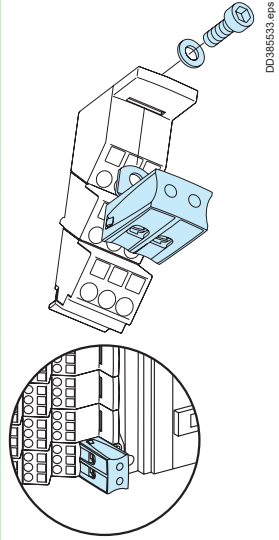
Quick distribution blocks for ComPacT devices			Additional block	
Number of poles	3P	4P	3P/4P	
				
Rated operational current (Ie)	250 A	250 A	250 A	
Rated peak withstand current (Ipk)	32 kA	32 kA		
Rated short-time current with upstream protection of 150 kA Icc (Icc)	150 kA	150 kA		
Thermal stress (I ² .t)	7.225 x 10 ⁷	7.225 x 10 ⁷		
Total connection capacity, outgoing terminals	27 connections: 6 x 10 ² /phase 3 x 16 ² /phase	36 connections: 6 x 10 ² /phase 3 x 16 ² /phase	2 connections: 2 x 35 ² per pole	
Incomer terminals	1 cable lug 120 mm ² per pole			
Dimensions (H x W x D)	105 x 138 x 63	140 x 138 x 64		
Installation	On mounting plate or DIN rail		On mounting plate	
Product certifications	ASEFA			
Standard for installation inside PrismaSeT	IEC 61439-1-2			
Glow-wire 60695-2-11	960°C			
References	LVS04033	LVS04034	LVS04155 (3P) LVS04156 (4P)	

Technical Data	
Common characteristics	
Rated conditional short-circuit current of an assembly (Isc)	The reinforced breaking capacity due to cascading in circuit-breaker combinations is maintained. The worst-case situations have been tested.
Rated insulation voltage (Ui)	750 V AC
Rated operational voltage (Ue)	690 V AC
Rated impulse withstand voltage (Uimp)	8 kV
Network frequency	50/60 Hz
Degree of protection	IPxxB
Degree of pollution	3
Overvoltage category	III
Additional technical characteristics	
Reference temperature	40 °C
Operating temperature	-25 °C to 55 °C

Installation

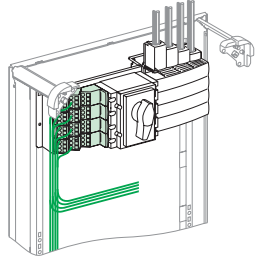

DD381346-70-LGI.eps

Directly on the mounting plates of horizontally mounted **ComPacT NSX100/250** and **ComPacT INS-INV250** devices in the enclosures.

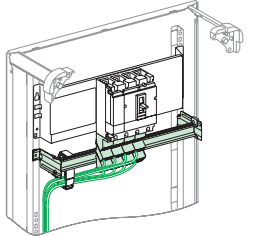

DD380760-70-LGI.eps

It can also be mounted downstream of vertically mounted **ComPacT NSX100/250** and **ComPacT INS-INV250** devices in the enclosures. In this case, the Linery DP is mounted on a depth-adjustable modular rail.

Lineryg DP

Quick distribution blocks for ComPacT NSXm up to 160 A

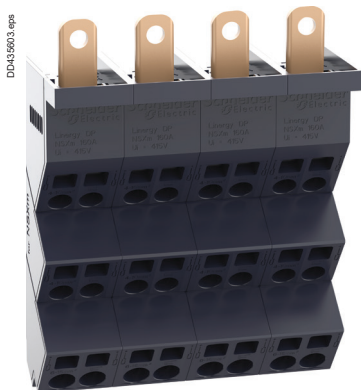

IEC 60947-7-1, IEC 61439-1 and 2



Description

- The Lineryg DP quick distribution block is designed for installation directly downstream of ComPacT NSXm up to 160 A. It can also be clipped onto a modular rail.

Avantages

- It is quick to mount in the horizontal position. Electrical connections are made directly to the device terminals.
- It is the same width as the devices and does not take up any additional space in the switchboard.
- The connection terminals are slanted to facilitate cable entry and avoid exceeding the bending radius of the flexible and rigid cables.

Quick distribution blocks for ComPacT devices

Number of poles	3P	4P
		
Rated operational current (Ie)	160 A	160 A
Rated peak withstand current (Ipk)	20 kA	20 kA
Rated short-time current (Icc)	70 kA	70 kA
Thermal stress (I ² .t)	4.7 x 10 ⁶ A ² S	4.7 x 10 ⁶ A ² S
Total connection capacity, outgoing terminals	18 connections: 4 x 10 ² /phase 2 x 16 ² /phase	24 connections: 4 x 10 ² /phase 2 x 16 ² /phase
Incomer terminals	1 cable lug 70 mm ² per pole	
Dimensions (H x W x D)	140 X 81 X 58 mm	140 X 108 X 58 mm
Installation	On mounting plate or DIN rail	
Product certifications	ASEFA	
Standard for installation inside PrismaSeT	IEC 61439-1-2	
Glow-wire 60695-2-11	960 °C	
Catalogue numbers	LVS04038	LVS04039

Technical Data

Common characteristics

Rated conditional short-circuit current of an assembly (Isc)	The reinforced breaking capacity due to cascading in circuit-breaker combinations is maintained. The worst-case situations have been tested.
Rated insulation voltage (Ui)	800 V AC
Rated operational voltage (Ue)	690 V AC
Rated impulse withstand voltage (Uimp)	8 kV
Network frequency	50/60 Hz
Degree of protection	IPxxB
Degree of pollution	3
Overvoltage category	III

Additional technical characteristics

Reference temperature	40 °C
Operating temperature	-25 °C to 55 °C

Installation

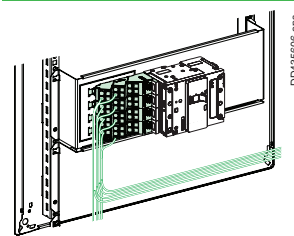

Directly on the mounting plates of horizontally mounted **ComPacT NSXm** devices in the enclosures.

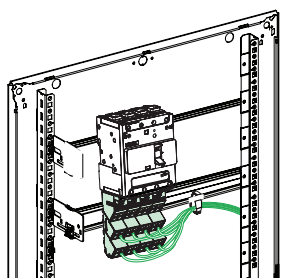

It can also be mounted downstream of vertically mounted **ComPacT NSXm** devices in the enclosures. In this case, the Lineryg DP is mounted on a depth-adjustable modular rail.

Device Feeders

Contents

Linergy FM	C - 2
Quick device feeders	C - 2
Linergy FH	C - 4
Horizontal comb busbar for 27mm pitch for C120, NG125	C - 4
Horizontal comb busbar for 18 mm pitch for Acti 9 / Multi 9	C - 5
Horizontal comb busbar for 9 mm pitch for Acti 9	C - 7
Horizontal comb busbar for 18 mm pitch for Domae	C - 9
Horizontal biconnect comb busbar for 18 mm pitch	C - 10
Linergy FC	C - 12
Feeders for ComPacT NSX and INS-INV up to 250 A	C - 12
Feeders for ComPacT NSXm up to 160 A	C - 14
Linergy FT	C - 16
TesyS comb busbar	C - 16
Giga High Power contactors - Power wiring accessories	C - 22
Product References	C - 22



Linergy FM

Quick device feeders

IEC 60947-7-1, IEC 61439-2



Description

- Distribution over full rows of modular devices.
- The distribution block is generally supplied by busbars in enclosures and cubicles.
- Easy phase balancing.
- Mix of devices and functions in the same row.
- Installation ≥ 160 A: clipped onto the back of a modular rail or screwed onto a solid or pre-slotted plate.

Distribution blocks

Number of poles	4P	4P
Rated peak withstand current (Ipk)	63 A	80 A
Rated conditional short-circuit current of an assembly (Isc)	15 kA	13 kA
Insulation voltage (Ui)	500 V AC	500 V AC
Rated voltage (Ue)	440 V AC	440 V AC
Rated impulse withstand voltage (Uimp)	6 kV	8 kV
Maximum current (Imax)	-	-
Rated operational frequency	50/60 Hz	50/60 Hz
Degree of protection	IPxxB	IPxxB
Supply at incoming terminals	Enclosed terminals for cables up to 25 mm ²	Enclosed terminals for cables up to 25 mm ²
Total connection capacity at outgoing terminals	Spring terminals: 4 for each phase (2 x 1 to 4 mm ² + 2 x 1 to 6 mm ²) 8 for the neutral (4 x 1 to 4 mm ² + 4 x 1 to 6 mm ²)	Spring terminals for rigid or flexible cables without ferrule: 9 for each phase (2 x 6 mm ² + 7 x 4 mm ²) 17 for the neutral (4 x 6 mm ² + 13 x 4 mm ²)
Width	24 9-mm pitches 12 18-mm modules	48 9-mm pitches 24 18-mm modules
Composition	Stripped copper connections (L=100 mm) 10 x 4 mm ² + 6 x 6 mm ²	Stripped copper connections (L=105 mm) 6 mm ² (6 black) 4 mm ² (20 black)
References	LVS04008	LVS04004

Installation

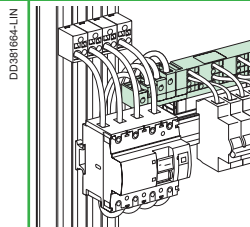

Clipped onto the back of a modular rail, or screw fixing.

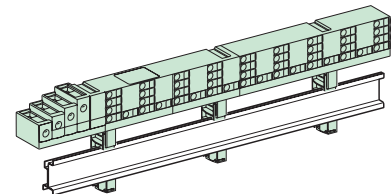

Clipped onto the back of a modular rail, or screw fixing.

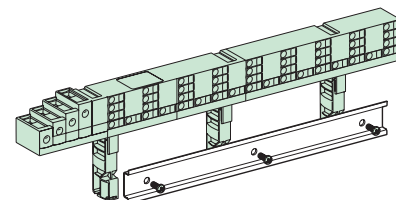

Can be mounted in Pragma Evolution enclosures and in PrismaSeT Pack 160

Linergy FM

Quick device feeders

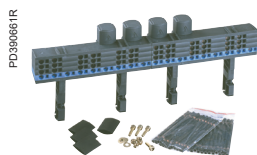

	4P	2P	3P	4P	4P
	160 A 27 kA	200 A 25 kA	200 A 25 kA	200 A 30 kA	200 A 27 kA
The cascading reinforced breaking capacity when combining circuit breakers is maintained. The worst-case scenarios have been tested.					
	750 V AC	750 V AC	750 V AC	750 V AC	750 V AC
	690 V AC	690 V AC	690 V AC	690 V AC	690 V AC
	8 kV	8 kV	8 kV	8 kV	8 kV
	50 A for feeder for 10 mm ² cable/63 A for feeder for 2 10 mm ² cables				
	50/60 Hz				
	IPxxB				
	Direct onto the row by cable 50 mm ² with crimped lug, or flexible bar 20 x 3 From Linergy BW insulated busbar in enclosure or cubicle with connection ref. LVS04021 From Linergy BS sheathed busbar with connection ref. LVS04024 From Linergy BS rear busbar with connection ref. LVS04029				
	6 connection points for each phase 9 connection points for the neutral	12 connection points for the phase and the neutral	12 connection points for each phase 18 connection points for the neutral		
	24 9-mm pitches 12 18-mm modules	48 9-mm pitches 24 18-mm modules			72 9-mm pitches 36 18-mm modules
	2 sachets with 12 stripped copper connections 10 mm ² (L=100 mm) Protective covers for power supply rows (IPxxB) Fixing accessories for power supply rows				
	LVS04018	LVS04012	LVS04013	LVS04014	LVS04026

Connections to the distribution block

	4P 200 A connection (supplied with fixing accessories)	4P 200 A connection (supplied with fixing accessories)	4P 200 A connection (supplied with fixing accessories)	4P 160 A connection for Linergy FM 1/2 row
Allows power supply from	Linergy BW busbar	Linergy BS sheathed busbar	Linergy BS rear busbar	Switchgear
References	LVS04021	LVS04024	LVS04029	LVS04030

Spare parts



Reference	4 covers for 160/200 A Linergy FM rows LVS01202
-----------	---

Linergy FH

Horizontal comb busbar for 27 mm pitch for C120, NG125

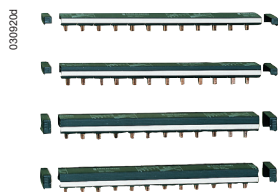

IEC 60664-1

Description

Comb busbars make it easier to install Schneider Electric products.

- Supplied with 2 side plates, IP2
- Outgoing feeders can be marked
- Cutting markings on the copper bars and the insulating material

C120, NG125		27 mm poles, cuttable			
Number of poles		1P	2P	3P	4P
	030820d				
		Supplied with 2 side plates, IP2 and 4 tooth cover end-pieces Outgoing feeders can be marked Cutting markings on the copper bars and the insulating material Unused teeth can be insulated with tooth covers			
Rated operational current at 40°C	(Ie)	125 A			
Rated conditional short-circuit current of an assembly	(Isc)	Compatible with the breaking capacity of Schneider Electric circuit breakers			
Insulation voltage	(Ui)	620 V			
Rated voltage	(Ue)	500 V			
Fire resistance to IEC 695-2-1		Self-extinguishing 960°C 30 s			
Colour		RAL 7016 (anthracite grey)			
Use					
		Power supply by connector recommended			
Number of 27 mm modules		16	16	15	16
Set of		1			
References		14811	14812	14813	14814

Installation

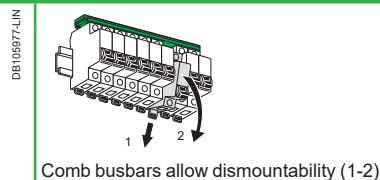

Accessories

Number of poles	1P, 2P, 3P, 4P		
	PG184071	030821d	
	Tooth covers		Insulated connector
			Compatible with all Schneider Electric comb busbars Clip onto the comb busbar's insulating material, which gives them very great stability Receive clip-on markers allowing circuit identification
Use			
Set of	20		For 25 mm ² semi-rigid cable
References	14818		-
Installation			

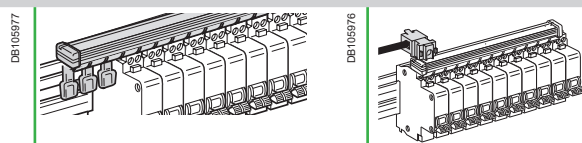

Linery FH

Horizontal comb busbar for 18 mm pitch for Acti 9 / Multi 9

IEC 60947-7-1, IEC 61439-2

Description

Comb busbars make it easier to install Schneider Electric products.

- Can be sawn and cut in a single pass
- Supplied with two IP20 lateral end-pieces except for 57 module references
- The end-pieces are compulsory after cutting
- The phases are identified by symbols on each side of the comb busbar for installation in all positions
- Cutting marks on the insulating material
- The special comb busbars for circuit breakers with 9 mm auxiliaries have a 9 mm gap for inserting iOF and iSD

PB502379

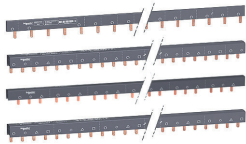

Acti 9 / Multi 9		18 mm poles, cuttable										
Number of poles		1P	2P	3P	4P	3 (N+P)	Aux+1P	Aux+2P	Aux+3P	Aux+4P	3 (Aux+1P)	3 (Aux+N+1P)
	PB110259-24											
Rated operational current at 40°C (Ie)		100 A										
Rated conditional short-circuit current of an assembly (Isc)		Compatible with the breaking capacity of Schneider Electric circuit breakers										
Insulation voltage (Ui)		500 V										
Rated voltage (Ue)		415 V										
Fire resistance to IEC 695-2-1		Self-extinguishing 960°C 30 s										
Colour		RAL 7016 (anthracite grey)										
Use												
Power supply by connector recommended												
Type		L1...	L1L2...	L1L2L3...	NL1L2L3...	NL1NL2... ...NL3	AuxL1...	AuxL1L2...	AuxL1L2L3	AuxNL1... ...L2L3	AuxL1... ...AuxL2... ...AuxL3	AuxL1... ...AuxL2... ...AuxL3
Set of		1	1	1	1	1	1	1	1	1	1	1
References												
6 modules of 18 mm		A9XPH106	-	-	-	-	-	-	-	-	-	-
12 modules of 18 mm		A9XPH112	A9XPH212	A9XPH312	A9XPH412	A9XPH512*	-	-	-	-	-	-
18 modules of 18 mm		-	-	-	-	A9XPH518*	-	-	-	-	-	-
24 modules of 18 mm		A9XPH124	A9XPH224	A9XPH324	A9XPH424	A9XPH524*	-	-	-	-	-	-
57 modules of 18 mm		A9XPH157	A9XPH257	A9XPH357	A9XPH457	A9XPH557*	A9XAH157	A9XAH257	A9XAH357	A9XAH457	A9XAH657	A9XAH557*

* This comb busbar is only compatible in top feeding for simple lug devices and bottom feeding on double lug devices.

Installation

PB110290-40



PB110793-40



Accessories

Number of poles	1P	2P	3P	4P	-	-	-	
	DB404806			DB404806		PB110256-15	PB110259-22	
	End-pieces				Tooth covers		Connectors	
	Lateral end-pieces providing IP20 protection				Insulate teeth that have been left free		Monoconnect Double terminals	
							Comb busbar power supply. Horizontal in comer on each side. For 35 mm ² cable. Tightening torque 4 N.m	
Set of	10	10	10	10	20	4	4	
References	A9XPE110	A9XPE210	A9XPE310	A9XPE410	A9XPT920	A9XPCM04	A9XPCD04	

Linergy FH

Horizontal comb busbar for 18 mm pitch for Acti 9 / Multi 9

IEC 60947-7-1, IEC 61439-2

Description

Comb busbars make it easier to install Schneider Electric products. The phases are identified by symbols on each side of the comb busbar. Dismountability of devices with Acti 9.

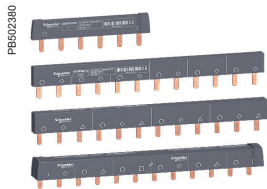

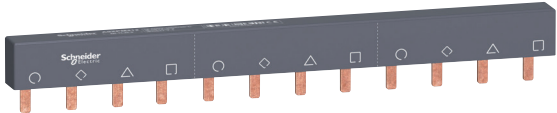

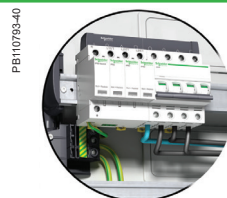
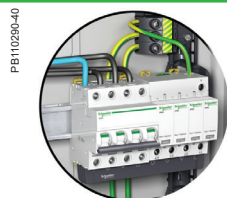

Acti 9 / Multi 9		18 mm poles, not cuttable	
Number of poles	1P	3P	
	PB110231-15		
Rated operational current at 40°C (Ie)	100 A		
Rated conditional short-circuit current of an assembly (Isc)	Compatible with the breaking capacity of Schneider Electric circuit breakers		
Insulation voltage (Ui)	500 V		
Rated voltage (Ue)	415 V		
Fire resistance to IEC 695-2-1	Self-extinguishing 960°C 30 s		
Colour	RAL 7016 (anthracite grey)		
Use			
Type	Power supply by connector recommended		
Set of	L1	L1L2L3	
	1	1	
References			
12 modules of 18 mm	A9XPM112	A9XPM312	

Installation

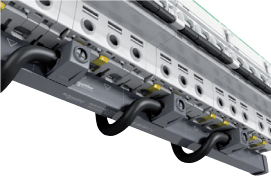

Accessoires

			
	Cache-dents	Connecteurs	
	Isoloz les dents libres	Bornes doubles	Monoconnexion
Utilisation	Arrivée horizontale de chaque côté Pour câble de 35 mm ² Couple de serrage 4 N.m.		
Ensemble de	20	4	4
Références	A9XPT920	A9XPCD04	A9XPCM04
Installation			

Linery FH

Horizontal comb busbar for 9 mm pitch for Acti 9, C60

IEC 61439-1



Description

Comb busbars ensure:

- Easy, reliable mounting of 1P+N and 3P+N, TL, CT, ID, V, BP and Cm switchgear: tooth positioning opposite the device terminals is ensured by indexing of copper parts
- C60/ID Group Feeder comb busbars contain two different parts:
 - Connection of Group Feeder switchgear: C60 (3P+N) or ID (3P+N) circuit breaker in 18 mm modules, powered by cables, through the bottom, directly by the terminals
 - Connection of Clario, Prodis and Libro switchgear in 9 mm modules

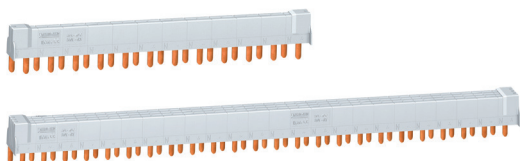
PB602382





Acti 9 Ph+N		9 mm poles, cuttable				
Number of poles		1P+N		3P+N		
						
		21501		21505		
		Complete comb busbars (supplied with 4 side plates and 1 tooth cover)				
Rated operational current at 40°C	(Ie)	80 A				
Rated conditional short-circuit current of an assembly	(Isc)	Compatible with the breaking capacity of Schneider Electric circuit breakers				
Insulation voltage	(Ui)	440 V				
Rated voltage	(Ue)	230 V (P4 + N) - 400 V (3Ph + N)				
Rated impulse withstand voltage	(Uimp)	6 kV				
Degree of protection		IP20				
Fire resistance to IEC 695-2-1		Self-extinguishing 960°C 30 s				
Colour		RAL 7035				
Number of 18 mm modules	Comb busbar	12	24	12	18	24
	Tooth cover	3	6	3	3	6
References		21501	21503	21505	LVS09516	21507
Comb busbars alone						
Number of 18 mm modules	Comb busbar	48			48	
References		21089			21093	

C60/ID Group Feeder comb busbars alone

Number of poles		3P+N		
				
Rated operational current at 40°C	(Ie)	80 A		
Rated conditional short-circuit current of an assembly	(Isc)	Compatible with the breaking capacity of Schneider Electric circuit breakers		
Insulation voltage	(Ui)	440 V		
Rated voltage	(Ue)	230 V (P4 + N) - 400 V (3Ph + N)		
Rated impulse withstand voltage	(Uimp)	6 kV		
Degree of protection		IP20		
Fire resistance to IEC 695-2-1		Self-extinguishing 960°C 30 s		
Colour		RAL 7035		
Number of 18-mm modules		12	48	48
Power supply		Through left-hand	Through left-hand	Through right-hand
References		A9XPC812	A9XPC848	A9XPC948

Accessories

Number of poles		1P+N	3P+N		
					
		End-pieces	Tooth covers (3 x 18-mm modules)	Tooth covers (1 x 18-mm module)	Connectors (grey)
Set of		40	12	10	4
References		21094	21095	21096	21098

Linergy FH

Horizontal comb busbar for 9 mm pitch for Acti 9

IEC 61439-1

Description

PB1080283

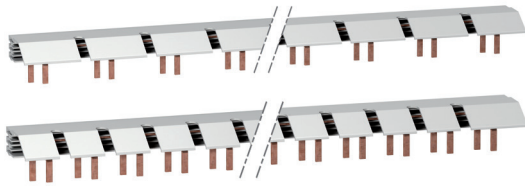

- Connection of Clario, Prodis and Libro switchgear in 9 mm modules
- The special comb busbars for circuit breaker have a gap of 9 mm for inserting OF, SD, OF-SD/OF auxiliaries
- The comb busbars for 3P+N circuit breakers and auxiliaries are compatible with PrismaSeT switchboard
- 1P+N comb busbars with PrismaSeT and Pragma 24

Acti 9		9 mm poles, cuttable			
Number of poles		1P+N	3P+N	1P+N	3P+N
		A9N21036		A9N21037	
		Comb busbars		Comb busbars DPN Vigi	
Rated operational current at 40°C (Ie)		63 A			
Rated conditional short-circuit current of an assembly (Isc)		Compatible with the breaking capacity of Schneider Electric circuit breakers			
Insulation voltage (Ui)		500 V			
Rated voltage (Ue)		230 V (P4 + N) - 400 V (3Ph + N)			
Degree of protection		IP20			
Fire resistance to IEC 695-2-1		Self-extinguishing 960°C 30 s			
Colour		RAL 7035			
Number of 18-mm modules		56	56	56	56
References		A9N21035	A9N21036	A9N21037	A9N21038

Accessories					
Number of poles	1P+N	3P+N			
	End-pieces	Connectors (grey)	Neutral connectors (blue)	Tooth cover (1 x 18 mm module)	
Set of	20	10	10	10	
References	A9N21039	A9N21040	A9N21041	A9N21042	A9N21050

Linergy FH

Horizontal comb busbar for 18 mm pitch for Domae

IEC 61439-1, IEC60664

Description

Comb busbars:

- Ensure easy reliable mounting of switchgear: tooth positioning opposite the device terminals is ensured by indexing of copper parts.
- Can be sawn and cut.
- Are supplied with two IP20 lateral end-pieces (the end-pieces are compulsory).
- Unused teeth can be insulated with tooth covers.

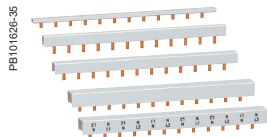

Domae		18 mm poles, cuttable							
Number of poles		1P	2P	3P	4P	L1N/L2N/L3N			
Rated operational current at 40°C (Ie)		63 A							
Rated conditional short-circuit current of an assembly (Isc)		Compatible with the breaking capacity of Schneider Electric circuit breakers							
Insulation voltage (Ui)		500 V							
Rated voltage (Ue)		Ph/N 230 V AC							
		Ph/Ph 400 V AC							
Fire resistance to IEC 695-2-1		Self-extinguishing 850°C 30 s							
Colour		RAL 7035							
Power supply		By 16 mm ² semi-rigid or 10 mm ² flexible cable With connector							
Number of 18 mm modules		12	57	12	57	12	57	57	57
References		EZ9XPH112	EZ9XPH157	EZ9XPH212	EZ9XPH257	EZ9XPH312	EZ9XPH357	-	-

PB502372



Installation

PB101630_SE-40

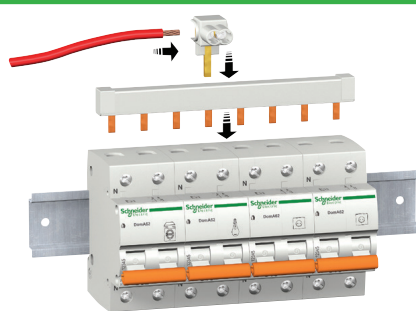

Accessories

Type	Connectors (4, 35 mm ²)	End-pieces (2 phases)	End-pieces (3 phases)	End-pieces (4 phases)	Tooth covers
Set of	1	10	10	10	10
References	EZ9XPC04	EZ9XPE210	EZ9XPE310	-	-

PB502373



PB101632-10



PB502376



PB100898



Linergy FH

Horizontal biconnect comb busbar for 18 mm pitch

PB602361

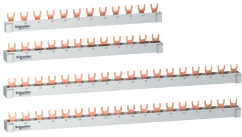

IEC60664-1

Description

Distribution and sub-distribution of the electric power supply
Fast assembly and disassembly of connected devices

Horizontal biconnect comb busbar		18 mm poles, cuttable											
Number of poles		1P			2P			3P			4P		
Rated operational current at 40°C (Ie)		63 A											
Rated conditional short-circuit current of an assembly (Isc)		Compatible with the breaking capacity of Schneider Electric circuit breakers											
Insulation voltage (Ui)		500 V											
Rated voltage (Ue)		Ph/N			Ph/N			Ph/N			Ph/N		
		Ph/Ph			Ph/Ph			Ph/Ph			Ph/Ph		
Fire resistance to IEC 695-2-1		Self-extinguishing 960°C 30 s											
Colour		RAL 7035 (grey)											
Use		Power supply: into box lug (25 mm ² rigid or 16 mm ² flexible) or by connector (35 mm ² rigid or 25 mm ² flexible with ferrule)											
Type		L1			L1L2			L1L2L3			L1L2L3L4		
Number 18 mm, modules		12	18	57	12	18	57	12	18	57	12	18	57
Set of		1	1	1	1	1	1	1	1	1	1	1	1
References		R9XFH112	R9XFH118	R9XFH157	R9XFH212	R9XFH218	R9XFH257	R9XFH312	R9XFH318	R9XFH357	R9XFH412	R9XFH418	R9XFH457

Installation

DB4-05995





Horizontal biconnect comb busbar		18 mm poles, cuttable												
Number of poles		4P												
Rated operational current at 40°C (Ie)		63 A												
Rated conditional short-circuit current of an assembly (Isc)		Compatible with the breaking capacity of Schneider Electric circuit breakers												
Insulation voltage (Ui)		500 V												
Rated voltage (Ue)		Ph/N			Ph/N			Ph/N			Ph/N			
		Ph/Ph			Ph/Ph			Ph/Ph			Ph/Ph			
Fire resistance to IEC 695-2-1		Self-extinguishing 960°C 30 s												
Colour		RAL 7035 (grey)												
Use		Power supply: into box lug (25 mm ² rigid or 16 mm ² flexible) or by connector (35 mm ² rigid or 25 mm ² flexible with ferrule)												
Type		NL1L2L3L4 - NL1NL2NL3						NL1NL2NL3						
Number 18 mm, modules		18						18						57
Set of		1						1						1
References		R9XFH518G						R9XFH518						R9XFH557

Installation

DB-405995



Accessories		18 mm poles, cuttable											
Number of poles		1P			2P			3P			4P		
End-pieces													
Tooth covers													
Connectors													
Set of		10			20			20			4		
References		R9XE110	R9XE210	R9XE310	R9XE410	R9XT20	R9XT20	R9XT20	R9XT20	R9XT20	R9XT20	R9XT20	R9XT20



Linergy FC

Feeders for ComPacT NSX and INS-INV up to 250 A

IEC 61439-1 and 2

Description

Linergy FC is an insulated horizontal distribution block. It connects directly to the mounting plate and can supply:



- Three 4P and four 3P ComPacT NSX circuit breakers, whatever the ratings (100, 160 or 250 A), the operating systems (toggle, rotary handle, motor mechanism), whether fixed or plug-in, front or rear connection (the circuit breakers must be equipped with long terminal shields downstream)
- Three 4P or four 3P ComPacT INS-INV switch-disconnectors, whatever the ratings (100, 160 or 250 A), whether front or rear connection.
- The design and small size blend perfectly with the devices.
- It can be supplied by Linergy BS or Linergy LGY busbars positioned to the left or right.
- Fully insulated, Linergy FC contributes to the safety of life and property. Numerous and well distributed vents ensure natural convection and optimum cooling of the conductors.
- The circuit breakers can be easily connected from the front. It is simple to interchange a device or to add a device in a reserve slot.
- There are markings (N, L1, L2, L3) on the front and the sides for the phases.
- The running of auxiliary cables between the devices and the corresponding terminal blocks is also taken into account. Spacious trunking is built into the blocks for the auxiliary wiring.

PB502507-48_reps

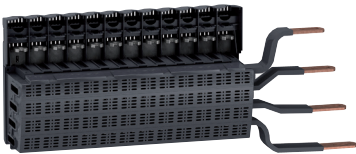

PB502503-48_reps



	Distribution block for ComPacT NSX 100/250 Toggle/Fixed+Connection		Distribution block for ComPacT NSX 100/250 Toggle/Fixed+Connection		Distribution block for ComPacT NSX 100/250 Fixed W/O Connection	
						
	Linergy FC with prefabricated connections by insulated flexible bars (1)		Linergy FC with prefabricated connections (1)		Linergy FC without prefabricated connections (1)	
Number of poles	3P	4P	3P	4P	3P	4P
Connection to	Linergy LGY busbars		Linergy BS, Linergy LGY or Linergy LGYE Aluminum profile busbars		Linergy BS, Linergy LGY or Linergy LGYE Aluminum profile busbars	
Number of devices	4	3	4	3	4	3
Composition	Self-adhesive labels to mark the phases for connections to the busbars.					
PrismaSeT P Mounting plates						
Toggle, Fixed, NSX100/250	LVS03420	LVS03420	-	-	LVS03420	LVS03420
Toggle, Plug-in, NSX100/250	-	-	LVS03423	LVS03423	LVS03423	LVS03423
Rotary handle, motor mechanism, Fixed, NSX100/250	-	-	LVS03422	LVS03422	LVS03422	LVS03422
Cat. no.	LVS04403	LVS04404	LVS04405	LVS04406	LVS04407 (2)	LVS04408 (2)

Implementation

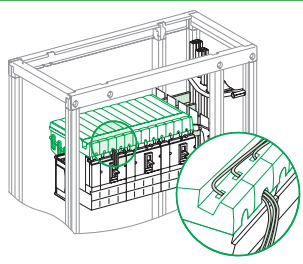

Auxiliary wires running in the built-in trunking.

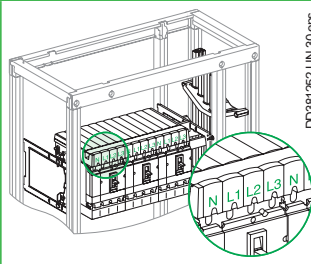

Phase marking on the front of the distribution block.

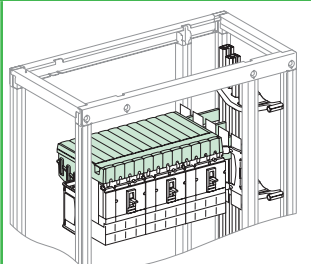

(1) The connection of a Linergy FC distribution block using pre-wired connectors or insulated flexible bars is not compatible with Form 2 partitioning (LVS04922). In this case, use the form 2 restoration kit (LVS04924).
 (2) For the connection, use insulated flexible bars, 32 x 8 mm cat. no. LVS04753; Each connection must not be longer than 500 mm. This size is validated with Schneider Electric insulated flexible bars.

Lineryg FC

Feeders for ComPacT NSX and INS-INV up to 250 A

Accessories

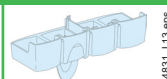
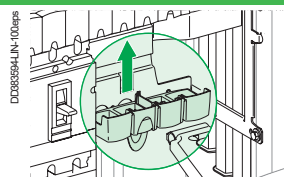

Tooth caps

The caps block off the reserve terminals on a Lineryg FC distribution block. Made of an insulating material, they simply clip on from the front.

Catalogue numbers

LVS04809

Characteristics

Common characteristics

Rated operational current at 40°	(In)	Distribution-block derating follows the normal derating curves of ComPacT NSX and INS-INV
Rated conditional short-circuit current of an assembly	(Isc)	The reinforced breaking capacity due to cascading in circuit breaker combinations is maintained. The worst-case situations have been tested. The electrical characteristics are perfectly compatible with the connected devices. Neither the temperature derating curves nor the performance levels of the circuit breakers and switch-disconnectors are altered.
Rated insulation voltage	(Ui)	750 V AC
Rated operational voltage	(Ue)	690 V AC
Rated impulse withstand voltage	(Uimp)	8 kV
Rated peak withstand current	(Ipk)	50 kA rms
Rated short-time current with upstream protection of 85 kA Icc	(Icc)	85 kA
Thermal stress	(I².t)	2.500 x 10 ⁷
Rated conditional short-circuit current of an assembly		Short-circuit withstand current compatible with the breaking capacity of the ComPacT NSX circuit breakers connected to the distribution block.

Lineryg FC selection table for special cases

For most installations, the temperature around the switchboard is 40 °C, corresponding to an average temperature of 60 °C inside the switchboard.

Under certain conditions, the temperature inside the switchboard may be different.

(A) Rated operational current as a function of the temperature inside the switchboard

Temperature (°C)		40	45	50	55	60	65	70
I _{nc} (A)	3P	800	800	775	750	725	700	675
	4P	675	675	655	635	615	595	570

To obtain the maximum permissible current for the lineryg FC, apply the diversity factor K:

- Lineryg FC 3P: K = 0.8
- Lineryg FC 4P: RDF = 0.9.

Lineryg FC

Feeders for ComPacT NSXm up to 160 A

IEC 61439-1 and 2

Description

Lineryg FC is an insulated horizontal distribution block. It connects directly to the mounting plate and can supply:

- Four 4P and five 3P ComPacT NSXm circuit breakers (four 3P and 4P for ComPacT NSXm Vigi), whatever the ratings (63, 100 or 160 A) with toggle and direct rotary handle operating mechanism.
- The design and small size blend thoroughly with the devices.
- It can be supplied by Lineryg BS, Lineryg LGYE Aluminum profile and Lineryg LGY busbars positioned to the left or right.
- Fully insulated, Lineryg FC helps to protect life and property. Numerous and well distributed vents ensure natural convection and optimum cooling of the conductors.
- The circuit breakers can be easily connected from the front. It is simple to interchange a device or to add a device in a reserve slot.
- There are markings (N, L1, L2, L3) on the front and the sides for the phases.
- The running of auxiliary cables between the devices and the corresponding terminal blocks is also considered. Spacious trunking is built into the blocks for the auxiliary wiring.

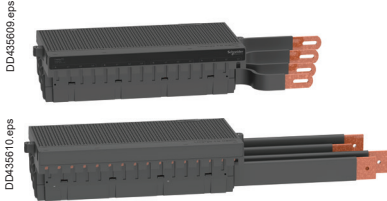

	ComPacT NSXm - Toggle (with Everlink terminal)		ComPacT NSXm - Toggle/ DRH (with Everlink terminal)			
	Lineryg FC with prefabricated connections by insulated flexible bars (1)		Lineryg FC with prefabricated connections (1)		Lineryg FC without prefabricated connections (1)	
Number of poles	3P	4P	3P	4P	3P	4P
Connection to	Lineryg LGY busbars		Lineryg BS and Lineryg LGYE Aluminum profile busbars			
Number of devices	5 (2)	4	5 (2)	4	5 (2)	4
PrismaSeT P Mounting plates	LVS03416	LVS03416	LVS03416	LVS03416	LVS03416	LVS03416
Cat. no.	LVS04410 LVS04416 (3)	LVS04411	LVS04412 LVS04417 (3)	LVS04413	LVS04419 (3) LVS04418 (3) (4)	LVS04420 (3)

Implementation

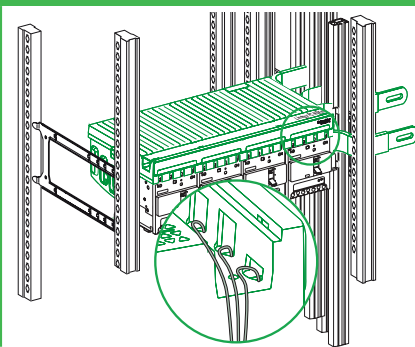

Auxiliary wires running in the built-in trunking.

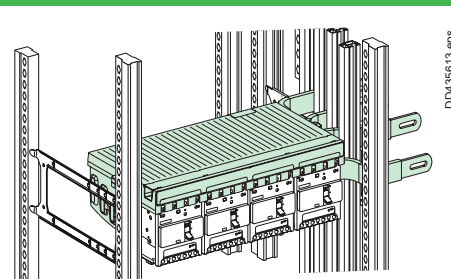

- (1) The connection of a Lineryg FC distribution block using pre-wired connectors or insulated flexible bars is not compatible with Form 2 partitioning (LVS04922). In this case, use the form 2 restoration kit (LVS04924).
- (2) Lineryg FC configuration having NSXm with Vigi can mount four devices in a row for both 3P and 4P.
- (3) For the connection, use insulated flexible bars, 32 x 6 mm cat. no. LVS04752; Each connection must not be longer than 500 mm. This size is validated with Schneider Electric insulated flexible bars.
- (4) The catalogue reference number is used only with NSXm Vigi.

Linergy FC

Feeders for ComPacT NSXm up to 160 A

Accessories

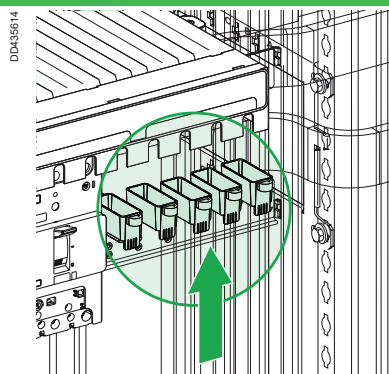

Tooth caps

The caps block off the reserve terminals on a Linergy FC distribution block. Made of an insulating material, they simply clip on and install the screw from the front.

Catalogue numbers

LVS04810

Characteristics

Common characteristics

Rated operational current at 40°	(In)	Distribution-block derating follows the normal derating curves of ComPacT NSXm
Rated conditional short-circuit current of an assembly	(Isc)	The reinforced breaking capacity due to cascading in circuit breaker combinations is maintained. The worst-case situations have been tested. The electrical characteristics are perfectly compatible with the connected devices. Neither the temperature derating curves nor the performance levels of the circuit breakers and switch-disconnectors are altered.
Rated insulation voltage	(Ui)	800 V AC
Rated operational voltage	(Ue)	690 V AC
Rated impulse withstand voltage	(Uimp)	8 kV
Rated peak withstand current	(Ipk)	18 kA
Rated short-time current with upstream protection of 85 kA Icc	(Icc)	50 kA
Thermal stress	(I².t)	4.5 x 10⁶ A²S
Rated conditional short-circuit current of an assembly		Short-circuit withstand current compatible with the breaking capacity of the ComPacT NSXm circuit breakers connected to the distribution block.

Linergy FC selection table for special cases

For most installations, the temperature around the switchboard is 40 °C, corresponding to an average temperature of 60 °C inside the switchboard.

Under certain conditions, the temperature inside the switchboard may be different.

(A) Rated operational current as a function of the temperature inside the switchboard

Ambient Air Temperature outside panel (°C)		35	40	45	50
IP31(A)	3P	600	575	550	525
	4P	500	480	460	440
IP55 (A)	3P	515	500	475	450
	4P	460	440	420	400

Linergy FT

Tesys comb busbar

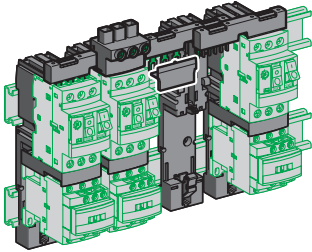

PB502399







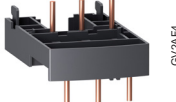

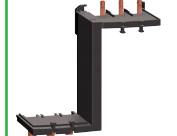
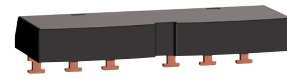
Description

It is much easier to create protection and control blocks, thanks to a range of accessories. These can be used to:

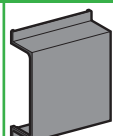
- Supply power to a group of blocks (combs and connection blocks GV2 G ●)
- Fix a fuse-carrier and a contactor on top of one another (mounting plate LAD 311)
- Interconnect a fuse-carrier and its contactor (rigid wiring modules GV2 AF ●, LAD 3 ●)
- Using them creates considerably more space in the switchboard and reduces the wiring time

	Combination blocks			S-shape busbars	115 A busbars for connecting contactors in parallel	
						
	Between GV2 and contactor LC1 K or LP1 K	Between GV2 and contactor LC1 D09... D38	Between GV2 mounted on LAD 311 and contactor LC1 D09... D38	For circuit-breakers GV3 P ●● and GV3 L ●● and contactors LC1 D40A...D65A	Contactors LC1 D40A...D65A	
Set of	10	10	10		2	3
References	GV2AF01	GV2AF3	GV2AF4	GV3S	GV3G264	GV3G364

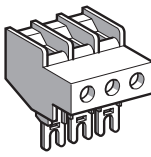
Accessories						
						
	Protective end cover	Terminal block for supply to one or more GV2 G busbar sets		Cover for terminal block	Flexible 3-pole connecting a GV2 to a contactor LC1-D09... D25	
	For unused busbar outlets	Connection from the top	Can be fitted with current limiter GV1 L3 (GV2 ME and GV2 P)	For mounting in modular panels	Centre distance between mounting rails: 100... 120 mm	
Set of	5	1	1	10	10	
References	GV1G10	GV1G09	GV2G05	-	GV1G02	

Accessories for main pole and control connections								
Number of poles	4-pole 10 mm ²	3-pole 25 mm ²	2-pole					
								
	Connectors for cable, size (1 connector)		Links for parallel connection of					
For use with contactors LC1	(~) (=)	DT20, DT25	D09...D38	D09...D38	DT20, DT25 (4P)	DT32, DT40 (4P)	D40A...D65A	D80, D95
		DT20, DT25	D09...D38	D09...D38	DT20, DT25 (4P)	DT32, DT40 (4P)	D40A...D65A	D80
Set of		1	1	10	10	10	1	2
References		LAD92560	LA9D3260	LA9D2561	LA9D1261	LAD96061	LAD9P32	-

Linergy FT

Tesys comb busbar

Sets of 3-pole 63 A busbars											
PB602384				PB602386			ODAGV2G445			ODAGV2G554	
	2 tap-offs			3 tap-offs		4 tap-offs		5 tap-offs			
	Pitch mm										
	45	54	72	45	54	45	54	72	54		
	GV2G245	GV2G254	GV2G272	GV2G345	GV2G354	GV2G445	GV2G454	GV2G472	GV2G554		



LAD311		PB111888		GK2AF01		GV2GA01	
	Adapter plates	Height compensation plate		Motor starter adapter plate		Connections upstream/downstream	
	For mounting a GV2 ME or GV2 P and contactor LC1 D09... D38 with front faces aligned	7.5 mm		With 3-pole connection for mounting a GV2 and a contactor LC1 D09... D25		For connecting GV2 ME to a printed circuit board	
	1	10		1		10	
	LAD311	GV1F03		GK2AF01		GV2GA01	

3-pole			4-pole		
ODALABD0962			ODALABD0963		
	D09...D38	D40A...D65A	D80, D95	DT20, DT25	D80, D95
	D09...D38	D40A...D65A	D80, D95	DT20, DT25	D80
	10	1	1	2	2
	LAD9P3	LAD9P33	LA9D80962	LA9D1263	LA9D80963



Linery FT

Tesys comb busbar

For 3-pole reversing contactors

									
	LAD9R1		LAD9R3	LA9D8069					
	Kits for assembly of reversing contactors								
Composition	<ul style="list-style-type: none"> ■ A mechanical interlock LAD 9V2 with electrical interlock LAD 9V1 ■ A set of power connections LAD 9V5 (parallel) and LAD 9V6 (reversing) 		<ul style="list-style-type: none"> ■ A mechanical interlock LAD 9V2 without electrical interlock ■ A set of power connections LAD 9V5 (parallel) and LAD 9V6 (reversing) 		<ul style="list-style-type: none"> ■ A mechanical interlock LAD 4CM ■ A set of power connections LA9 D65A69 		<ul style="list-style-type: none"> ■ A set of parallel bars ■ A set of reverser bars 		
For contactors	LC1 D09 to D38		LC1 D40A to D65A	LC1 D09 to D38 with screw terminals or connectors	LC1 D09...D32 with spring terminal connections	LC1 D40A to D65A	LC1 D80 and D95 (~)	LC1 D80 and D95 (—)	LC1 D115 and D150
References	LAD9R1V	LAD9R1	LAD9R3	LAD9V5 + LAD9V6	LAD9V12 + LAD9V13	LA9D65A69	LA9D8069	LA9D8069	LA9D11569

For 4-pole changeover contactor

									
		LA9D6570	LA9D8070						
	Kits for assembly of changeover contactor pairs		Sets of power connections						
Composition	<ul style="list-style-type: none"> ■ A mechanical interlock LAD 9V2 with electrical interlock LAD 9V1 ■ A set of power connections (changeover) LAD 9V7 		<ul style="list-style-type: none"> ■ A mechanical interlock LAD 9V2 without electrical interlock ■ A set of power connections (changeover) LAD 9V7 		Comprising a set of parallel bars				
For contactors	LC1 DT20 to DT40 with screw terminals or connectors		LC1 DT60A and DT80A	LC1 D80004	LP1 D80004	LC1 D115004	LC1 DT203 to DT403 with spring terminals	LC1 D80004	LP1 D80004
References	LADT9R1V	LADT9R1	LA9D65A70	LA9D8070	LA9D8070	LA9D11570	-	LA9D8070	LA9D8070

Linergy FT

Tesys comb busbar

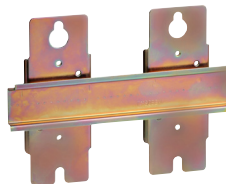
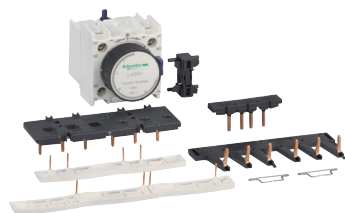

For star-delta starter

- 1 time delay contact block LAD S2 (LC1 D09...D80)
- Power circuit connections (LC1 D09...D80)
- Hardware required for fixing the contactors onto the mounting plate (LC1 D80)

Equipment mounting plates

LC1 D09 and D12	LC1 D18 to D32	LC1 D40A and D50A	LC1 D80	LC1 D09, D12 and D18	LC1 D32	LC1 D40A and D50A	LC1 D80
LAD91217	LAD93217	LAD9SD3	LA9D8017	-	-	-	LA9D80973

For 3-pole changeover contactor pairs

LAD90570



Mechanical interlocks

Sets of power connections

Without integral electrical interlock

With integral electrical interlock

Comprising a set of parallel bars

LC1 D40A...D65A	LC1 D115 and D150	LC1 D115 and D150
LAD9R3S	LA9D11502	LA9D11571

Linergy FT

Tesys comb busbar

Components for assembling 3-pole reversing contactors and changeover contactor pairs

LA9FF982



3-pole reversing contactors for motor control

813154-LIN

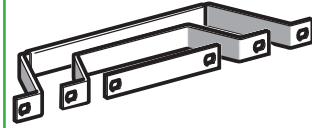

3-pole changeover contactor pairs

Horizontal mounting	LC1 F115 (1)	LC1 F150 (1)	LC1 F185 (1)	LC1 F225 (1)	LC1 F265 (1)	LC1 F330 (1)	LC1 F400 (1)	LC1 F500 (1)	LC1 F630 (1) or F800
For assembly of 3-pole reversing contactors for motor control References	-	-	LA9FG976	-	LA9FH976	LA9FJ976	LA9FJ976	LA9FK976	-
For assembly of 3-pole changeover contactor pairs References	-	-	-	-	-	LA9FJ982	LA9FJ982	-	-

Components for assembling 3 and 4-pole changeover contactor pairs

813186-LIN

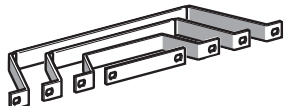

4-pole changeover contactor pairs

Horizontal mounting	LC1F1154 (1)	LC1F1504 (1)	LC1F1854 (1)	LC1F2254 (1)	LC1F2654 (1)	LC1F3304 ⁽¹⁾	LC1F4004 (1)	LC1F5004 (1)	LC1F6304 (1)
Set of power connections References	-	-	-	-	-	LA9FJ977	LA9FJ977	-	-

Accessories

LA9FF602

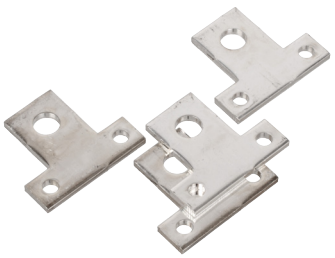

LA9 ● 602

Links for parallel connection of poles (in pairs)

LA9FF601



LA9 F ● 601

Links for "star" connection of 3 poles



LC1 F1154 (1)	LC1 F1504 (1), F1854	LC1 F2254 (1), F2654, F3304, F4004	LC1 F5004 (1)	LC1 F6304 (1)	LC1 F115 (1)	LC1 F150 (1), F185	LC1 F225 (1), F265, F330, F400	LC1 F500 (1)	LC1 F630 (1), F800
References	-	-	LA9FK602	-	-	-	-	LA9FK601	-

(1) Tesys F substitution is on going by TeSys Giga. See dedicated pages to get information about Power Wiring accessories.

Linergy FT

Tesys comb busbar

Right-angled connectors

									
	LA9 F ● 981			LA9 F ● 979					
Contactors	LC1 F115 (1)			LC1 F150 (1), F185			LC1 F225 (1), F265, F330, F400		
Thermal overload relays	LR9 F5 ● 67, LR9 F67			LR9 F5 ● 69, F5 ● 71, LR9 F69, F71			LR9 F7 ● 75, LR9 F75		
Width (mm)	15			20			25		
Type	Rear	Side	Large surface area	Rear	Side	Large surface area	Rear	Side	Large surface area
References	-	-	-	-	-	-	LA9FJ981	LA9FJ979	LA9FJ980

Right-angled connectors

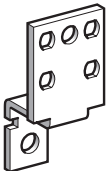
						
	LA9 FL980					
Contactors	LC1 F500 (1)			LC1 F630 (1), F800		
Thermal overload relays	LR9 F7 ● 79, F7 ● 81, LR9 F79, F81			LR9 F7 ● 81, LR9 F81		
Width (mm)	30			40		
Type	Rear	Side	Large surface area	Rear	Side	Large surface area
References	-	-	-	-	-	-

Accessories

Contactors	LC1 F115 (1)	LC1 F150 (1) and F 185	LC1 F185 (1)	LC1 F225 (1) and F265	LC1 F330 (1) and F400	LC1 F400 (1)	LC1 F500 (1)	LC1 F630 (1), F800	
Thermal overload relays	LR9 F5 ● 57, F5 ● 63, LR9 F5 ● 67, F5 ● 69, LR9 F69, F71	LR9 F5 ● 57, F5 ● 63	LR9 F5 ● 71, LR9 F71	LR9 F5 ● 71, LR9 F71	LR9 F7 ● 75, F ● 79, LR9 F75, F79	LR9 F7 ● 75, F7 ● 79, LR9 F75, F79	LR9 F7 ● 81, LR9 F81	LR9 F7 ● 75, F7 ● 79, LR9 F7 ● 81, LR9 F75, F79, F81	LR9 F7 ● 81, LR9 F81
Width (mm)	15	20	25	25	25	25	25	30	40
References	-	-	-	-	-	-	-	-	-

(1) Tesys F substitution is on going by TeSys Giga. See dedicated pages to get information about Power Wiring accessories.

Power terminals

'Cable Memory' connection blocks

Cables or busbars can be connected to the contactor by means of the optional memory connection blocks. When the contactor is removed for maintenance, the cables or busbars remain connected to these connection blocks, making reinstallation faster and easier.



LA9G3101

Cable memory ⁽¹⁾

Description	Compatibility with contactors	Quantity Set of	Reference
'Cable memory' for 3-pole contactors - for holding cables in place	LC1G115...LC1G225	2	LA9G3101
	LC1G265...LC1G500	2	LA9G3102
	LC1G630...LC1G800	2	LA9G3103
'Cable memory' for 4-pole contactors - for holding cables in place	LC1G115...LC1G225	2	LA9G4101
	LC1G265...LC1G500	2	LA9G4102
	LC1G630...LC1G800	2	LA9G4103

(1) 'Cable memory' connection blocks are always supplied with Advanced contactor version

Fixed terminals extension

Flexible connecting bars to connect TeSys Giga High power contactors with MCCBs mounted in the same plane and orientation. These bars can be used along with Advanced or Standard version contactors. They help to get a quick and easy connection between contactor and MCCV with saving in installation time.

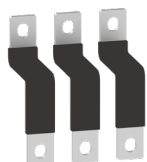

LA9G3111

'Flexible terminal extension' for MCCBs

Description	Compatibility with contactors	To connect with NSX/NS MCCBs	Quantity Set of	Reference
Flexible terminal extension 3-pole	LC1G115...LC1G225	NSX100...NSX250	3	LA9G3111
	LC1G265...LC1G500	NSX400...NSX630	3	LA9G3112
	LC1G630...LC1G800	NSX800...NS1250	3	LA9G3113
Flexible terminal extension 4-pole	LC1G115...LC1G225	NSX100...NSX250	4	LA9G4111
	LC1G265...LC1G500	NSX400...NSX630	4	LA9G4112
	LC1G630...LC1G800	NSX800...NS1250	4	LA9G4113

Straight terminal extensions



LA9G3601

Description	Suitable for	Compatibility with contactors	Quantity Set of	Reference
Straight terminal extension	3P	LC1G115...LC1G225	3	LA9G3601
		LC1G265...LC1G500	3	LA9G3602
		LC1G630...LC1G800	3	LA9G3603
	4P	LC1G115...LC1G225	4	LA9G4601
		LC1G265...LC1G500	4	LA9G4602
		LC1G630...LC1G800	4	LA9G4603

Right angled terminal extension



LA9G3682

Description	Suitable for	Compatibility with contactors	Quantity Set of	Reference
Right angled side terminal extension	3P	LC1G115...LC1G225	3	LA9G3661
		LC1G265...LC1G500	3	LA9G3662
		LC1G630...LC1G800	3	LA9G3663
Right angled large terminal extension	3P	LC1G115...LC1G225	3	LA9G3671
		LC1G265...LC1G500	3	LA9G3672
		LC1G630...LC1G800	3	LA9G3673
Right angled rear terminal extension	3P	LC1G115...LC1G225	3	LA9G3681
		LC1G265...LC1G500	3	LA9G3682
		LC1G630...LC1G800	3	LA9G3683



LA9G3631

Edgewise terminal extensions				
Description	Suitable for	Compatibility with contactors	Quantity Set of	Reference
Edgewise terminal extension	3P	LC1G115...LC1G225	3	LA9G3632
		LC1G265...LC1G500	3	LA9G3632
		LC1G630...LC1G800	3	LA9G3633
	4P	LC1G115...LC1G225	4	LA9G4631
		LC1G265...LC1G500	4	LA9G4632
		LC1G630...LC1G800	4	LA9G4633

Power terminals

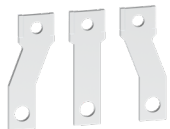

LA9G3611

Spreader kits					
Description	Suitable for	Compatibility with contactors	Increase of pole pitch	Quantity Set of	Reference
Spreader kits	3P	LC1G115...LC1G225	35 to 45 mm	3	LA9G3611
		LC1G265...LC1G500	45 to 70 mm	3	LA9G3612
	4P	LC1G115...LC1G225	35 to 45 mm	4	LA9G4611
		LC1G265...LC1G500	45 to 70 mm	4	LA9G4612

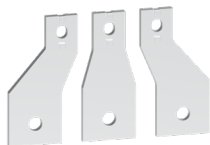

LA9G3613

Terminal extension for larger power connections					
Description	Suitable for	Compatibility with contactors	Power connection size	Quantity Set of	Reference
Terminal connections	3P	LC1G115...LC1G225	50 mm width	3	LA9G3613
		LC1G265...LC1G500	80 mm width	3	LA9G3614
	4P	LC1G115...LC1G225	50 mm width	4	LA9G4613
		LC1G265...LC1G500	80 mm width	4	LA9G4614



LA9G4711

Edgewise terminal extensions						
Description	Suitable for	Compatibility with contactors	Increase of pole pitch	Suitable for box connectors	Quantity Set of	Reference
Edgewise terminal extension	3P	LC1G115...LC1G225	35 to 45 mm	DZ2 FJ1/FH1 & AL400	3	LA9G3711
		LC1G265...LC1G500	45 to 70 mm	DZ2 FJ1/FK1 & AL400/AL600	3	LA9G3712
		LC1G630...LC1G800	70 to 80 mm	DZ2 FL1/FK1 & Type S/AL600	3	LA9G3714
	4P	LC1G115...LC1G225	35 to 45 mm	DZ2 FJ1/FH1 & AL400	4	LA9G4711
		LC1G265...LC1G500	45 to 70 mm	DZ2 FJ1/FK1 & AL400/AL600	4	LA9G4712
		LC1G630...LC1G800	70 to 80 mm	DZ2 FL1/FK1 & Type S/AL600	4	LA9G4714

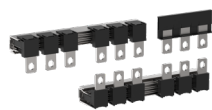

LA9GQQ330

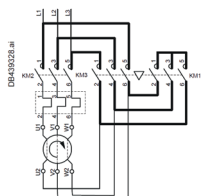

Star-Delta (Wye-Delta) connection kits (1)

Description	Suitable for	for Line (KM2) and Delta (KM3) contactor	+ Star contactor (KM1)	Reference
Connection kit bars for Line-Delta Star contactor assembly	3P	LC1G115...LC1G225	LC1G115...LC1G225	LA9GQQ330
		LC1G265...LC1G500	LC1G115...LC1G225	LA9GSQ330
		LC1G265...LC1G500	LC1G265...LC1G500	LA9GSS330
	3P	LC1G630...LC1G800	LC1G265...LC1G500	LA9GTS330
		LC1G630...LC1G800	LC1G630...LC1G800	LA9GTT330
		LC1G265...LC1G500	LC1G115...LC1G225	LA9GSQ331
		LC1G630...LC1G800	LC1G265...LC1G500	LA9GTS331

(1) UL listed.



LA9G3760

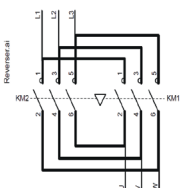

Reverser connection kits

Description	Suitable for	Compatibility with contactors	Reference
Connection kit: bars for reverser contactor assembly	3P	LC1G115...LC1G225	LA9G3760
		LC1G265...LC1G500	LA9G3761
		LC1G630...LC1G800	LA9G3762



LA9G3750

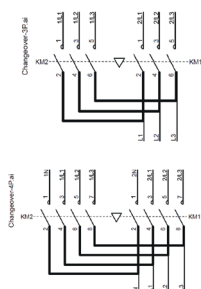

Changeover connection kits

Description	Suitable for	Compatibility with contactors	Reference
Connection kit: bars for changeover contactor assembly	3P	LC1G115...LC1G225	LA9G3750
		LC1G265...LC1G500	LA9G3751
		LC1G630...LC1G800	LA9G3752
	4P	LC1G115...LC1G225	LA9G4750
		LC1G265...LC1G500	LA9G4751
		LC1G630...LC1G800	LA9G4752

Power busbars

Contents

Linergy BS	D - 2
Rear flat busbars upto 400 A	D - 2
Multi-stage busbars upto 630 A	D - 3
Multi-stage distribution block upto 630 A	D - 4
Common accessories upto 630 A	D - 5
Linergy BW	D - 6
Insulated busbars upto 630 A	D - 6
Linergy LGY, LGYE Aluminum profiles, BS	D - 8
Selection guide upto 4000 A	D - 8
Linergy LGY, LGYE, BS	D - 9
Lateral profiles upto 3200 A	D - 9
LGYE Lateral profiles upto 4000 A	D - 10
BS Lateral Flat Copper Busbars upto 3200 A	D - 11
Linergy LGY, BS	D - 12
Lateral profiles upto 1600 A	D - 12
Linergy LGY, BS	D - 14
Horizontal profiles upto 4000 A	D - 14
Linergy BZ	D - 16
Quick busbar systems	D - 16

Linergy BS

Rear flat busbars up to 400 A

PD38652-SE

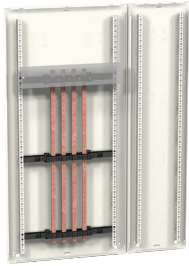

IEC 61439-1 & 2

Description

The busbar can be 3-pole or 4-pole with ratings between 160 A and 400 A. 2 lengths are available: 1000 and 1400 mm, which can be cut as required. The number of supports depends on the installation maximum rated current.

160 to 400 A copper busbars

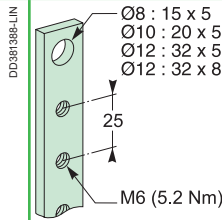

		160 A	250 A	400 A	
Rated peak withstand current	(Ipk)	30 kÅ	40 kÅ	55 kÅ	
Rated insulation voltage	(Ui)	1000 V	1000 V	1000 V	
Rated short-time current	(Icw)	10 kA rms/1s	13 kA rms/1s	25 kA rms/1s	
Conductor cross-section		15 x 5 mm	20 x 5 mm	32 x 5 mm	
Installation		Threaded M6 holes every 25 mm all the way up Connection by: 16 to 50 mm ² flexible cables with crimped lugs			
Set of		4			
Length (mm)		1000	1400	1000	1400
References		LVS04161	LVS04171	LVS04162	LVS04172
				LVS04163	LVS04173

Insulating busbar support (1)

Distance between supports depending on Icw/Ipk (2)	≤ 10 kA rms/1 s/30 kÅ	≤ 13 kA rms/1 s/40 kÅ	≤ 15 kA rms/1 s/40 kÅ	≤ 20 kA rms/1 s/45 kÅ	≤ 25 kA rms/1 s/55 kÅ
	450 mm	-	450 mm	450 mm	300 mm
					225 mm
Installation	On the rear uprights Screwed onto a solid or pre-slotted plate (fixing centres 450 x 200 mm)				
References	LVS04191	LVS04191	LVS04191	LVS04191	LVS04191

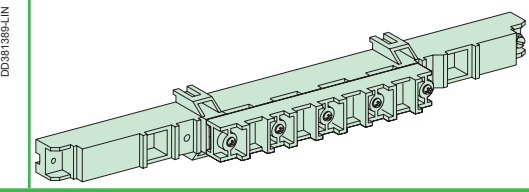

IPxxB insulating protective shield

Length	470 mm	470 mm	470 mm
Height	100 mm	100 mm	100 mm
Composition	Supplied with fixings		
References	LVS04198	LVS04198	LVS04198

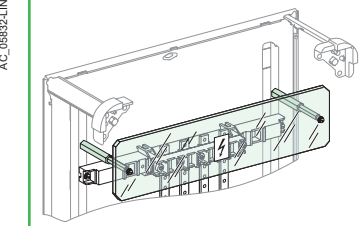

(1) The supports allow installation of a 5th busbar with 15 or 20 x 5 mm cross-section to create the earth collector.
 (2) Linergy FM 200 A distribution blocks with connections ref. LVS04029 can act as intermediate supports (max. distance apart 200 mm) in addition to the support ref. LVS04191 at the top and bottom.

Linery BS

Multi-stage busbars up to 630 A

PD306533_SE

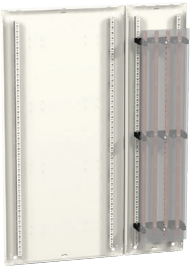

IEC 61439-1 & 2

Description

Multi-stage busbars are installed in a sheath L = 300 mm. We strongly recommend dividing the current between 2 cubicles or enclosures joined on either side. All the connection points are easily accessible from the front. The busbar orientation makes them easier to tighten and facilitates running the cables between them. The current can be 3-pole or 4-pole with ratings between 160 A and 630 A. 2 lengths are available: 1000 and 1400 mm, which can be cut as required. The number of supports depends on the installation maximum rated current.

160 to 630 A copper busbars

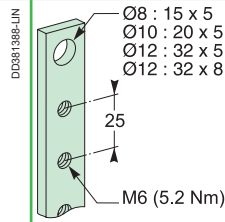

	160 A	250 A	400 A	630 A				
Rated peak withstand current (I _{pk})	30 kÅ	40 kÅ	55 kÅ	55 kÅ				
Rated insulation voltage (U _i)	750 V	750 V	750 V	750 V				
Rated short-time current (I _{cw})	10 kA rms/1s	13 kA rms/1s	15, 20 kA rms/1s	25 kA rms/1s				
Supply at incoming terminals	Connection by: 16 to 50 mm ² flexible cables with crimped lugs							
Conductor cross-section	15 x 5 mm	20 x 5 mm	32 x 5 mm	32 x 8 mm				
Installation	Flat copper busbar with threaded M6 holes every 25 mm all the way up							
Set of	4							
Length (mm)	1000	1400	1000	1400	1000	1400	1000	1400
References	LVS04161	LVS04171	LVS04162	LVS04172	LVS04163	LVS04173	Pending	LVS04174

Insulating busbar support ⁽¹⁾

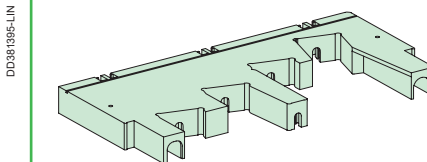

Support fixing centres in accordance with I _{cw} /I _{pk} ⁽²⁾	≤ 10 kA rms/1 s/30 kÅ	≤ 13 kA rms/1 s/40 kÅ	≤ 15 kA rms/1 s/40 kÅ	≤ 20 kA rms/1 s/45 kÅ	≤ 25 kA rms/0.6 s/55 kÅ	≤ 25 kA rms/1 s/55 kÅ
	450 mm	450 mm	450 mm	450 mm	450 mm	450 mm
	-	450 mm	450 mm	450 mm	450 mm	450 mm
	-	-	450 mm	450 mm	450 mm	450 mm
	-	-	300 mm	300 mm	300 mm	300 mm
	-	-	300 mm	300 mm	300 mm	300 mm
	-	-	-	-	-	300 mm
Installation	Installation on functional uprights in PrismaSeT. Screwed onto a solid or pre-slotted plate (450 x 200 mm fixing centres)					
References	LVS04192	LVS04192	LVS04192	LVS04192	LVS04192	LVS04192

IPxxB insulating protective shield

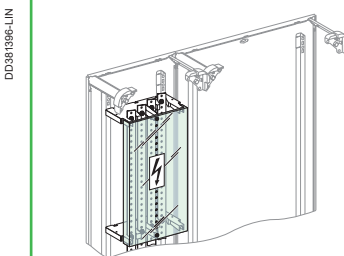

Length	250 mm	250 mm	250 mm	250 mm
Height	1500 mm	1500 mm	1500 mm	1500 mm
Composition	Fixing accessories supplied with support ref. LVS04192			
References	LVS04197	LVS04197	LVS04197	LVS04197

Linergy BS

Multi-stage distribution block up to 630 A

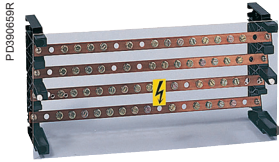

IEC 61439-1 & 2

Description

The distribution block can be installed horizontally in the device zone or vertically in the 300 mm wide duct of enclosures and cubicles.

The distribution block is made up of:

- two staggered supports made of an insulating material
- four slanted copper bars with holes every 25 mm

Multi-stage distribution blocks

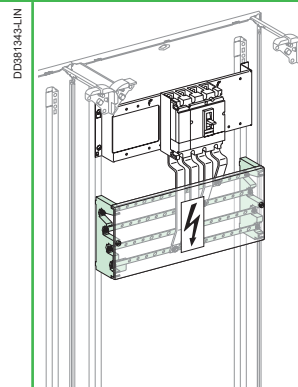
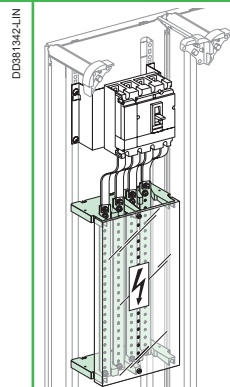

	160 A	250 A	400 A	630 A
Rated peak withstand current (I _{pk})	30 kA	30 kA	40 kA	40 kA
Rated insulation voltage (U _i)	750 V AC			
Rated operational voltage (U _e)	440 V			
Rated impulse withstand voltage (U _{imp})	8 kV			
Rated short-time current (I _{cw})	10 kA rms/1 s	13 kA rms/1 s	20 kA rms/1 s	25 kA rms/1 s
Total connection capacity	4 incomers per phase: ø 12.2 mm clearance holes 13 outgoing per phase 16 to 50 mm ² : M6 tapped holes			
Busbar cross-section	15 x 5 mm	20 x 5 mm	32 x 5 mm	32 x 8 mm
Dimensions (mm)				
Installation	Screwed in horizontal position on functional uprights in enclosures and cubicles (PrismaSeT G) Screwed in vertical position on sheathed uprights (PrismaSeT G) Screwed onto a solid or pre-slotted plate (fixing centres 450 x 200 mm) Screwed onto adapter ref. LVS03595 (PrismaSeT P)			
Composition	2 multi-stage supports made of an insulating material 4 slanted copper busbars, with holes every 25 mm 1 pack of 36 M6 x 16 screws + contact washers 1 IPxxB front insulating shield			
References	LVS04052	LVS04053	LVS04054	LVS04055

Linergy BS

Common accessories up to 630 A

Incomer accessories

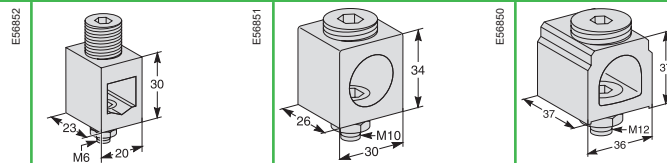

Connectors for copper or aluminium cables			
Rated operational current at 40°C (I _e)	160 A	250 A	400 A
Supply at incoming terminals	70 mm ² cables	16 to 185 mm ² cables	70 to 300 mm ² cables
Composition	Supplied with fixings at busbar end		
Set of	4		
References	LVS07051	LVS07052	LVS07053

Outgoer accessories

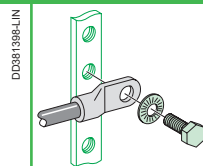

Class 8.8 fixings		
Composition	20 M6 x 20 screws + 20 nuts + 40 contact washers	40 M6 x 16 screws + 40 contact washers
References	LVS04194	LVS04195



Linery BW

Insulated busbars up to 630 A

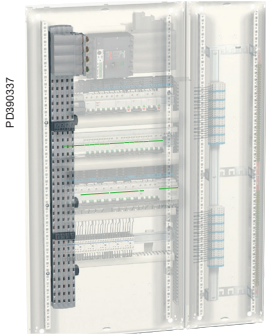

Description

- ComPacT busbar, **IPxxB**, ready for installation (supplied complete with supports and end caps)
- Shaped busbar, threaded M6 with 25-mm pitch, can be cut with 200-mm pitch (150 mm for the 125 A)
- Busbar installed on insulating supports, screwed onto the rear uprights
- Wide selection of tested pre-wired connectors
- Clip-on covers to protect against direct contact (IPxxB). Can easily be cut to allow connections to pass through to the switchgear
- Ends protected by end caps

Linery BW busbar											
	125 A		160 A		250 A		400 A		630 A		
Rated peak withstand current (I _{pk})	20 kA		30 kA		30 kA		52.5 kA		52.5 kA		
Rated insulation voltage (U _i)	500 V		750 V		750 V		750 V		1000 V		
Rated impulse withstand voltage (U _{imp})	8 kV		8 kV		8 kV		8 kV		8 kV		
Rated short-time current (I _{cw})	8.5 kA rms/1 s		10 kA rms/1 s		13 kA rms/1 s		20 kA rms/1 s		25 kA rms/1 s		
Length (mm)	450	750	1000	1400	1000	1400	1000	1400	1000	1400	
References	3P	LVS04103	LVS04107	LVS04111	LVS04116	LVS04112	LVS04117	LVS04113	LVS04118	LVS04114	LVS04119
	4P	LVS04104	LVS04108	LVS04121	LVS04126	LVS04122	LVS04127	LVS04123	LVS04128	LVS04124	LVS04129

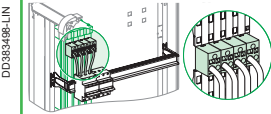
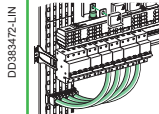
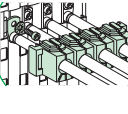
Accessories				
	IPxxB tap-off terminals			
	For one 6 mm ² cable and one 10 mm ² cable (U _i): 750 V	For one 1 to 16 mm ² cable (U _i): 750 V	200 A connections	IPxxB insulating covers
				Class 8.8 fixing accessories
Used for connecting	<ul style="list-style-type: none"> ■ All switchgear equipped with enclosed terminals ■ Linery FM 160/200 A 	<ul style="list-style-type: none"> ■ All switchgear equipped with enclosed terminals ■ Linery FM 63/80/160/200 A 	<ul style="list-style-type: none"> ■ Linery FM 200 A 	Covers which can be clipped on and cut to size are used to isolate the connectors of a connection with cables of cross-section 10 to 25 mm ²
Set of	12	12	4	20
References	LVS04151	LVS04152	LVS04021	LVS04150
				LVS04158

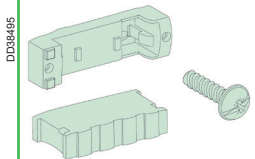
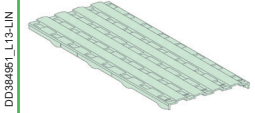
Spare parts					
	Linery BW busbar supports				
Rated operational current at 40° (I _e)	125 A	160 A	250 A	400 A	630 A
Composition	2 busbar supports + 2 end caps + packet of fixing accessories				
References	-	LVS01210	LVS01210	LVS01210	LVS01211
	IPxxB clip-on covers				
Length (mm)	200				
Set of	2				
References	-	LVS01201	LVS01201	LVS01201	LVS01201

Linergy BW

Insulated busbars up to 630 A

Linergy BW busbar connections with power supply unit

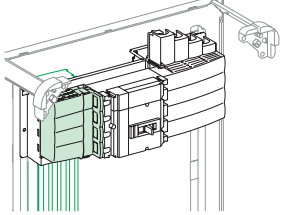
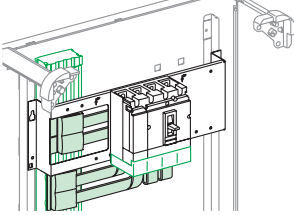
								
	Power supply units with connections			Universal power supply units + pre-wired connectors			Universal power supply units + connections to be made (flexible insulated busbars can be used)	
Used for connecting ComPacT	<ul style="list-style-type: none"> Horizontal NSX100/250 with or without Vigi Horizontal INS-INV250 	<ul style="list-style-type: none"> Horizontal NSX400 Horizontal INS-INV320/400 	<ul style="list-style-type: none"> Horizontal NSX630 Horizontal INS-INV500/630 	<ul style="list-style-type: none"> Enclosed NSX100/250 with toggle switch Enclosed vertical INS-INV250 	<ul style="list-style-type: none"> Sheathed NSX100/250 with or without Vigi Sheathed vertical INS-INV250 	<ul style="list-style-type: none"> Sheathed NSX400/630 with or without Vigi Sheathed INS-INV320/630 	<ul style="list-style-type: none"> Enclosed horizontal NSX100/250 with rotary handle or remote control Vertical Fupact INF100/160, Fupact ISFT100/250 	<ul style="list-style-type: none"> Enclosed NSX400/630 with or without Vigi Enclosed INS-INV320/630
References	LVS04060	LVS04070	LVS04071	LVS04061 + LVS04062	LVS04061 + LVS04064	LVS04074 + LVS04073	LVS04061	LVS04074

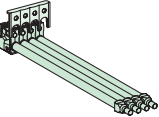
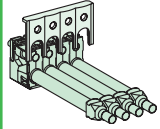
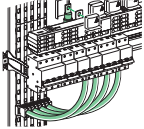

Pre-wired connectors

					
	Connections		IPxxB 3/4P monobloc connection	IPxxB 3/4P monobloc connection	Connections
	35 mm ² ferrule + 45° angled connector	45 mm ² ferrule + 45° angled connector	Quick connection on the busbar equipped with a male ferrule for enclosed terminals. Neutral identified by the colour blue.		-
Rated operational (Ie) current at 40°	125 A	160 A	160 A	160 A	200 A
Length	230 mm	250 mm	440 mm	150 mm	-
Used for connecting	<ul style="list-style-type: none"> NG125, INS-INV with enclosed terminals ref. 28947 or 28948 	<ul style="list-style-type: none"> INS-INV160, NG125, NG160 	<ul style="list-style-type: none"> NG160 (left-hand position), Vigi NG160 (middle position) NG125, INS-INV160, C120, iC120 	<ul style="list-style-type: none"> NG160 (left-hand position), NG125, INS-INV160, C120, iC120 	<ul style="list-style-type: none"> Linergy FM 200 A
Set of	4	4	1	1	4
References	LVS04145	LVS04146	LVS04148	LVS04147	LVS04021

Linergy LGY, LGYE, BS Selection guide up to 4000 A

IEC 61439-1 & 2

Description

PrismaSeT P and PrismaSeT HD switchboards have a complete, coherent system for routing the electrical current:

- optimised busbars
- pre-wired connectors
- customised distribution blocks

Vertical busbar

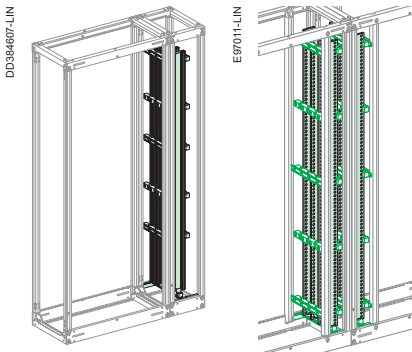

Lateral in sheath

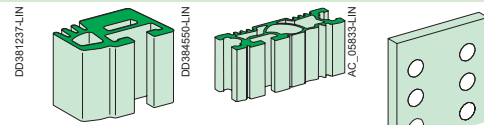

	LGY profile	LGYE profile	Linergy BS flat busbars
Permissible current	Up to 3200 A	Up to 4000 A	Up to 3200 A
Material	Linergy Aluminum profile	Linergy Aluminum profile	Pre-slotted copper
Busbar	8 profile types depending on the current	9 profile types depending on the current	Th. 5 mm up to 1600 A Th. 10 mm up to 3760 A
Busbar length	1670 mm	2000 mm	1675 mm
Installation in PrismaSeT P sheath	150 mm wide 2 x 150 mm wide 300 mm wide	Up to 1600 A Up to 3200 A	Up to 2500 A Up to 3200 A
Installation in PrismaSeT HD sheath	300 mm wide	500 mm deep For 3200-4000 A	Up to 4000 A 500, 600 or 800 mm deep



At the back of a cubicle

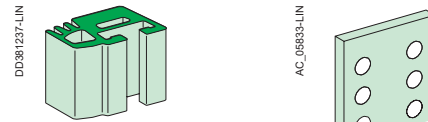

	LGY profile	Linergy BS flat busbars
Permissible current	Up to 1600 A	Up to 1600 A
Material	Linergy Aluminum profile	Pre-slotted copper
Busbar type	5 profile types depending on the current	10 mm thick up to 1600 A
Busbar length	1670 mm	1675 mm
Installation	In 650 mm wide PrismaSeT cubicle or 700 mm wide PrismaSeT HD cubicle regardless of depth	

Horizontal busbar

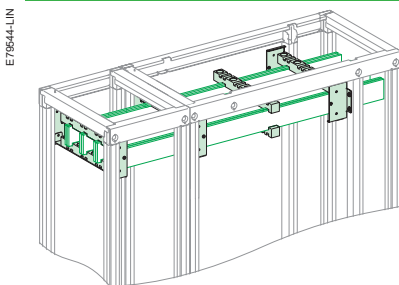

	LGYE profiles	Linergy BS flat busbars
Permissible current	Up to 4000 A	Up to 4000 A
Material	Linergy Aluminum profile	Copper solid busbars
Busbar type	9 profile types depending on the current	5 mm up to 1600 A 10 mm up to 4000 A
Busbar length	2000 mm	2000 mm
Installation	At the top or bottom of the cubicle, horizontally 400 or 600 mm deep for PrismaSeT P 500, 600 or 800 mm deep for PrismaSeT HD	

Linery LGY

Lateral profiles up to 3200 A

Linery LGY profiles			Up to 1600 A (single busbar)					Up to 3200 A (double busbar)		
In PrismaSeT P sheath	L150					2 x L150				
In PrismaSeT HD sheath	L300					-				
Linery profile, 1670 mm long										
Permissible current for an ambient temp. of 35°C around the switchboard	630 A	800 A	1000 A	1250 A	1600 A	2 x 1000 A	2 x 1250 A	2 x 1600 A		
IP ≤ 31	680 A	840 A	1040 A	1290 A	1650 A	200 A	2500 A	3200 A		
IP > 31	590 A	760 A	950 A	1170 A	1480 A	1820 A	2260 A	2920 A		
Number of profiles per phase	1					2				
References	LVS04502	LVS04503	LVS04504	LVS04505	LVS04506	LVS04504	LVS04505	LVS04506		

Busbar supports

	Characteristics: An end stop must be fitted on the bottom support: LVS01109 (sold in lots of 12)						
Number depending on l _{cw} (kA rms/1 s)	≤ 25	3					2 x 3
	≤ 30		3				2 x 3
	≤ 40			3			2 x 3
	≤ 50				4		2 x 3
	≤ 60					5	2 x 4
	≤ 65						2 x 4
	≤ 75						2 x 5
	≤ 85						2 x 5
References	LVS04651 (+ set of 2 upright adapters NSYSFPA for installation in PrismaSeT HD cubicle)						

Equipotential bonding

	3 equipotential bonding items must be installed between the busbars						Connection made with a flat 80 x 10 mm busbar between 2 L150 sheaths
References							

Connections to the Linery BS horizontal busbar

	Characteristics: Fixings supplied. Order 1 connection per phase			
References according to horizontal busbar size	5 mm thick	LVS04634 (1000 A)	LVS04635 (1600 A)	-
	10 mm thick	LVS04636		2 x LVS04636
	Width ≤ 80 mm			
	Width > 80 mm	LVS04636 + LVS04642		2 x LVS04636 + 2 x LVS04642

Accessories

Linery screw	Characteristics	Sold in lots of 20: 20 screws + 20 nuts + 20 contact washers, class 8.8. The screws slide into the profile and are then locked in the desired position.
	References	25 mm long LVS04766 (for lug and flexible busbar connection) 39 mm long LVS04767 (for copper busbar connection)
Steel plain washers	Characteristics	M8 sold in lots of 20
	References	ext. ø 20 mm LVS04772 ext. ø 24 mm LVS04773 ext. ø 28 mm LVS04774
	Characteristics	M8 sold in lots of 20 for connection of ≤ 25 mm ² lugs to Linery
Brass plain washers	References	ext. ø 20 mm LVS04775
	Characteristics	12 clip-on supports + N, L1, L2, L3, PE, PEN labels
Identification	References	LVS04794

Linergy distribution systems - Power busbars

Linergy LGYE Aluminum profiles

Lateral profiles up to 4000 A

Linergy LGYE Aluminum Profiles									
	Up to 4000 A								
In PrismaSeT P sheath	L150					L300			
In PrismaSeT HD sheath	L300								
Linergy profile, 2000 mm long									
	630 A	800 A	1000 A	1250 A	1600 A	2000 A	2500 A	3200 A	4000 A
Permissible current for an ambient temperature of 35°C around the switchboard	530 A	680 A	850 A	1050 A	1480 A	1650 A	2100 A	2800 A	3620 A
Length to cut for side mounting	1675 mm							1625 mm	
Number of profiles per phase	1								
References	LVS04560	LVS04561	LVS04562	LVS04563	LVS04564	LVS04565	LVS04566	LVS04567	LVS04568

Busbar supports

	Fixed support LVS04661	Support arm LVS04662	LVS04666
Characteristics	3 fixed supports are compulsory to hold the busbar in position. If more than 3 supports are needed, use support arms (in addition).		
Number depending on Icw (kA rms/1 s)	≤ 30	3	
	≤ 40	5	3
	≤ 50	5	3
	≤ 60	5	3
	≤ 65	5	3
	≤ 75	7	5
	≤ 85	7	5
	≤ 100		9
References	LVS04661 (fixed support) + LVS04662 (support arm if necessary)	LVS04661 (fixed support) + LVS04671 (fixings) + LVS04662 (support arm if necessary)	LVS04661 (fixed support) + LVS04646 (sold in lots of 12 spacers) + LVS04662 (support arm if necessary)

Wedging busbars in position

	Wedge fitted on bottom support	Wedge fitted on bottom support
Characteristics	The bottom support is used to place profiles and ensure they are in the correct position. It is not considered to be a busbar support.	
References	LVS04663 (bottom support)	LVS04666 (bottom support) + LVS04661 (fixed support)
	LVS04658 (pack of 12 replacement shims)	LVS04659 (pack of 12 replacement shims)

Connections to the Linergy Evolution LGYE horizontal busbar

	≤ 1600 A	2000/2500 A	3200/4000 A
Characteristics	Supplied with fixings. References are supplied individually: 1 connection per phase.		
References according to horizontal busbar size	LVS04604 (short connection)	LVS04605 (long connection)	LVS04607

Linery BS

Lateral flat copper busbars up to 3200 A

Flat copper busbars															
	Up to 1600 A					Up to 3200 A									
In PrismaSeT P sheath	L150					L150			L300		2 x L150				
In PrismaSeT HD sheath	L300 D500/600/800					L300 D500/600/800									
Pre-slotted copper, 1675 mm long															
Permissible current for an ambient temp. of 35°C around the switchboard	P ≤ 31		800 A		1000 A	1400 A	1800 A	1200 A	1400 A	1800 A	2050 A	2300 A	2820 A	3200 A	3200 A
	P > 31		750 A		900 A	1250 A	1600 A	1080 A	1250 A	1600 A	1850 A	2000 A	2500 A	2820 A	2820 A
Busbar cross-section (mm)	60 x 5		80 x 5		60 x 5	80 x 5	50 x 10	60 x 10	80 x 10	50 x 10	60 x 10	80 x 10	100x10	80 x 10	
Number of busbars per phase	1		2		1		2		1		2		-		
References	LVS04516		LVS04518		LVS04516	LVS04518	LVS04525	LVS04526	LVS04528	LVS04525	LVS04526	LVS04528	pending	LVS04528	

Busbar supports

Description		Attach directly to the sheath frame. 3 fixed supports are compulsory to hold the busbar in position. If more than 3 supports are needed, use support arms (in addition). The bottom wedge support is used to place the busbar and ensure it is in the correct position. It does not count as a busbar support.											
	Number of supports	≤ 15	3			3			3			2 x 3	
	depending on I _{cw} (kA _{rms} /1 s)	≤ 25	5			3			3			2 x 3	
		≤ 30	5			5			3			2 x 3	
		≤ 40	7			5			5			2 x 3	
		≤ 50	7			5			5			2 x 3	
		≤ 60	7			7			5			2 x 5	
		≤ 65	7			7			5			2 x 5	
		≤ 75	7			9			7			2 x 5	
		≤ 85	7			7			7			2 x 5	
	References of supports depending on distance between bars and sheath depth	PrismaSeT P sheath L150 mm	LVS04661 (fixed) + LVS04662 (arm) + LVS04663 (shim)										
	75 mm distance between bars	L300 mm	LVS04661 (fixed) + LVS04662 (arm) + LVS04666 + LVS04661 (shim) ⁽¹⁾										
	PrismaSeT HD sheath D500 mm	LVS04662 (arm) + NSYAS500 (shim) (1)											
	L300 75 mm distance between bars	D600 mm	LVS04662 (arm) + NSYAS600 (shim) (1)										
		D800 mm	LVS04662 (arm) + NSYAS800 (shim) (1)										
	PrismaSeT HD sheath D800 mm	LVS04678 (arm) + NSYAS800L (shim) (1)											

(1) If using a 100 x 10 bars, add a pack of screws ref. LVS04671 for each fixed support LVS04661 and arm support LVS04662.

Connections to the Linery BS horizontal busbar

Characteristics												
Reference of the connection piece depending on horizontal busbar size	≤ 80 mm	Pending										
	> 80 mm	Pending										
		1 bar per phase			2 bars per phase			double busbar				
		50 x 10	60 x 10	80 x 10	50 x 10	60 x 10	80 x 10	100 x 10	80 x 10			
		LVS04636	LVS04637	LVS04637	LVS04637	LVS04637	LVS04637	LVS04638	LVS04636 x 2			
		LVS04636 + LVS04642	LVS04637	LVS04637 + LVS04642	LVS04637 + LVS04642	LVS04637 + LVS04642	LVS04638	LVS04636 + LVS04642 x 2				



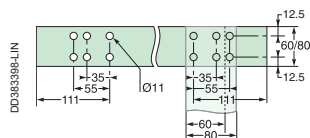

(2) Drill hole dimensions for 5 mm thick horizontal busbars



Linergy distribution systems - Power busbars



Linergy LGY

Rear profiles up to 1600 A

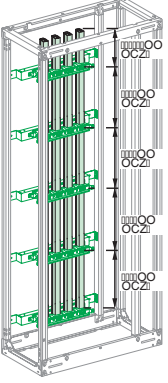
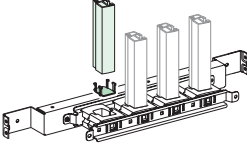
Linergy LGY profiles		Up to 1600 A				
At the back of a PrismaSeT P cubicle		L650				
At the back of a PrismaSeT HD cubicle		L700				
Linergy profile, 1670 mm long						
		630 A	800 A	1000 A	1250 A	1600 A
Permissible current for an ambient temp. of 35°C around the switchboard	IP ≤ 31	680 A	840 A	1040 A	1290 A	1650 A
	IP > 31	590 A	760 A	950 A	1170 A	1480 A
Number of profiles per phase		1				
References		LVS04502	LVS04503	LVS04504	LVS04505	LVS04506

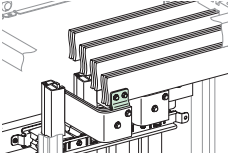
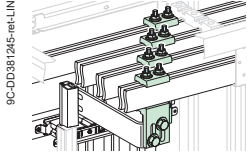
Busbar supports										
	Number depending on Icw (kA rms/1 s)	<table border="1"> <tr><td>≤ 25</td><td>3</td></tr> <tr><td>≤ 30</td><td>4</td></tr> <tr><td>≤ 40</td><td>5</td></tr> <tr><td>≤ 50</td><td>7</td></tr> </table>	≤ 25	3	≤ 30	4	≤ 40	5	≤ 50	7
	≤ 25	3								
	≤ 30	4								
	≤ 40	5								
	≤ 50	7								
Characteristics	 <p>An end stop must be fitted on the bottom support LVS01109 (sold in lots of 12)</p>									
References	LVS04652									

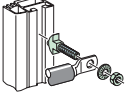
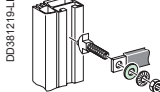
Connections to the Linergy BS horizontal flat busbar							
Characteristics	 <p>LVS04635 connection to 5 mm thick horizontal busbar</p>	 <p>LVS04036 connection to 10 mm thick horizontal busbar</p>					
	References according to horizontal busbar size	<table border="1"> <tr><td>5 mm thick</td><td>LVS04635</td></tr> <tr><td>10 mm thick</td><td>LVS04636</td></tr> <tr><td>Width > 80 mm</td><td>LVS04636 + LVS04642</td></tr> </table>	5 mm thick	LVS04635	10 mm thick	LVS04636	Width > 80 mm
5 mm thick	LVS04635						
10 mm thick	LVS04636						
Width > 80 mm	LVS04636 + LVS04642						

Accessories								
Linergy screw	Characteristics	   <p>Sold in lots of 20: 20 screws + 20 nuts + 20 contact washers, class 8.8 The screws slide into the profile and are then locked in the desired position</p>						
	Reference	<table border="1"> <tr><td>25 mm wide</td><td>LVS04766 (for lug and flexible busbar connection)</td></tr> <tr><td>39 mm wide</td><td>LVS04767 (for copper busbar connection)</td></tr> </table>	25 mm wide	LVS04766 (for lug and flexible busbar connection)	39 mm wide	LVS04767 (for copper busbar connection)		
25 mm wide	LVS04766 (for lug and flexible busbar connection)							
39 mm wide	LVS04767 (for copper busbar connection)							
Steel plain washers	Characteristics	M8 sold in lots of 20						
	Reference	<table border="1"> <tr><td>ext. ø 20 mm</td><td>LVS04772</td></tr> <tr><td>ext. ø 24 mm</td><td>LVS04773</td></tr> <tr><td>ext. ø 28 mm</td><td>LVS04774</td></tr> </table>	ext. ø 20 mm	LVS04772	ext. ø 24 mm	LVS04773	ext. ø 28 mm	LVS04774
	ext. ø 20 mm	LVS04772						
ext. ø 24 mm	LVS04773							
ext. ø 28 mm	LVS04774							
Brass plain washers	Characteristics	M8 sold in lots of 20 for connection of ≤ 25 mm ² lugs to Linergy						
Identification	Characteristics	12 clip-on supports + N, L1, L2, L3, PE, PEN labels						
	Reference	LVS04794						

Linergy BS

Rear flat busbars up to 1600 A

Flat busbars							
	Up to 1600 A						
At the back of a PrismaSeT P cubicle	L650						
At the back of a PrismaSeT HD cubicle	L700			-	L700		
Pre-slotted copper, 1670 mm long							
Permissible current for an ambient temperature of 35°C around the switchboard	800 A	1000 A	1400 A	1800 A	1000 A	1200 A	1600 A
IP ≤ 31	800 A	1000 A	1400 A	1800 A	-	-	-
IP > 31	750 A	900 A	1250 A	1600 A	1080 A	1250 A	1600 A
Busbar cross-section (mm)	60 x 5						
Number of busbars per phase	1		2		1		
References	LVS04516	LVS04518	LVS04516	LVS04518	LVS04525	LVS04526	LVS04528

Busbar supports

CHILDERIC_GM2

PB603009

Fixed busbar support LVS04653

Busbar support arm LVS04662

Characteristics

3 fixed supports ref. LVS04653 are compulsory to keep the busbar vertical. If more than 3 supports are needed, use support arms ref. LVS04662 (in addition). Metal shim ref. LVS04669 (sold in lots of 100), 5 mm thick, is screwed onto the busbar. It rests on a fixed support and is used to wedge the busbar in position.

DD3380815-LIN

DD3380815-LIN

Wedging: 1 busbar/phase

Wedging: 2 busbars/phase

Number depending on I _{av} (kArms/1 s)	≤ 15	≤ 25	≤ 30	≤ 40	≤ 50	≤ 60	≤ 65	≤ 75	≤ 85
3	3	3	3	3	3	3	3	3	3
5	5	5	5	5	5	5	5	5	5
7	7	7	7	7	7	7	7	7	7
9									9

References

LVS04653 (fixed) + LVS04662 (arm) + LVS04669 (shim)

Connections to the Linergy BS horizontal flat busbar

DD381244-LIN

DD381244-LIN

LVS04635 connection to horizontal busbar 5 mm thick

LVS04636 connection to horizontal busbar 10 mm thick

Characteristics

For part of the connection, flexible insulated busbars are needed. References LVS04635, LVS04636 are supplied individually = 1 connection per phase. Reference LVS04642 consists of 2 M8 x 140 screws which can replace the original M8 x 120 screws.

References according to horizontal busbar size	5 mm thick	10 mm thick	Width ≤ 80 mm	Width > 80 mm
	LVS04635	LVS04636	LVS04636	LVS04636 + LVS04642











Linergy LGYE Aluminum profiles

Horizontal profiles up to 4000 A

Linergy LGYE Aluminum Profiles											
Installation in PrismaSeT P and PrismaSeT HD		Up to 1600 A					Up to 4000 A				
Linergy profile, 2000 mm long, supplied with an end stop to wedge the profile in place		DD384538-LIN	DD381226-LIN	DD384538-LIN	DD384539-LIN	DD384540-LIN	DD384541-LIN	DD384542-LIN	DD384543-LIN	DD384544-LIN	
		630 A	800 A	1000 A	1250 A	1600 A	2000 A	2500 A	3200 A	4000 A	
Permissible current for an ambient temperature of 35°C		630 A	800 A	1000 A	1250 A	1650 A	2000 A	2440 A	3200 A	3620	
around the switchboard		530 A	680 A	850 A	1050 A	1480 A	1650 A	2100 A	2800 A	3350	
Number of profiles per phase		1									
Total number of vertical modules (50 mm)		3					3			4	
References		LVS04560	LVS04561	LVS04562	LVS04563	LVS04564	LVS04565	LVS04566	LVS04567	LVS04568	
Busbar supports											
		Fixed support LVS04664				Free Support LVS04662					
Characteristics		2 fixed supports for 650 to 800 wide frame and 1 fixed support for 300 or 400 wide frame (2 when the busbar is at the bottom) are compulsory. If more supports are needed, add support arms if necessary.									
Busbar supports 75 mm distance between	Number of supports	≤ 15	2		2						
	≤ 25	2		2							
	depending on I _{cw} (kA rms/1 s)	≤ 30	2		2						
	≤ 40	-	2		2						
	≤ 50	-	2		2						
	≤ 60	-	3		2						
	≤ 65	-	3		3						
	≤ 75	-	3		3						
	≤ 85	-	3		3						
	≤ 100	-	-		4						
References	Fixed support	LVS04664				LVS04664 + LVS04678 (fixings)		LVS04664 + LVS04646 (sold in lots of 12 spacers)			
References	Support arm	LVS04662				LVS04662 + LVS04671 (fixings)		LVS04662 + LVS04646 (sold in lots of 12 spacers)			
Joining											
		LVS04620		LVS04623		LVS04624					
References		3x LVS04620 (3P) 4x LVS04620 + LVS04624 (4P)				3x LVS04621 (3P) 4x LVS04621 + LVS04624 (4P)		3x LVS04623 (3P) 4x LVS04623 + LVS04624 (4P)			
Note	Reference LVS04624 is compulsory when installing jointed Linergy LGYE Aluminum profile 4P busbars and must be fitted where the frames meet. When installed at the bottom of a cubicle, the busbar must be partitioned.										

Linergy BS

Horizontal flat busbars up to 4000 A

Flat busbars											
Installation in PrismaSeT P and PrismaSeT HD		Up to 1600 A				Up to 4000 A					
Solid copper busbar, 2000 mm long											
Permissible current for an ambient temp. of 35°C around the switchboard	IP ≤ 31	800 A	1000 A	1400 A	1800 A	1800 A	2050 A	2300 A	2820 A	3300 A	3760 A
	IP > 31	750 A	900 A	1250 A	1600 A	1600 A	1850 A	2000 A	2500 A	2900 A	3340 A
Busbar cross-section (mm)		60 x 5	80 x 5	60 x 5	80 x 5	80 x 10	50 x 10	60 x 10	80 x 10	100 x 10	120 x 10
Number of busbars per phase		1	1	2	2	1	2	2	2	2	2
Total number of vertical modules (50 mm)		3									
References		LVS04536	LVS04538	LVS04536	LVS04538	LVS04548	LVS04545	LVS04546	LVS04548	LVS04550	LVS04552

Busbar supports



In cubicle: PrismaSeT P L650 or L650+150 or PrismaSeT HD L700/PH D500/600/800 with 75 mm distance between bars	Number of supports	≤ 15	2	2	2	2	2	2	2	2	2	
	depending on l _{cw}	≤ 25	3	2	3	3	3	3	3	3	3	
	(kA rms/1 s)	≤ 30	3	2	3	3	3	3	3	3	3	
	≤ 40	3	2	3	3	3	3	3	3	3	3	
	≤ 50	-	3	3	3	3	3	3	3	3	3	
	≤ 60	-	-	3	3	3	3	3	3	3	3	
	≤ 65	-	-	3	3	3	3	3	3	3	3	
	≤ 75	-	-	4	3	4	3	4	3	4	3	
	≤ 85	-	-	-	-	3	-	3	-	3	-	
	References	Fixed support	LVS04664	LVS04664	LVS04664	LVS04664	LVS04664	LVS04664	LVS04664	LVS04664	LVS04664 + LVS04671 (fixings)	LVS04664 + LVS04671 (fixings)
Free Support	LVS04662	LVS04662	LVS04662	LVS04662	LVS04662	LVS04662	LVS04662	LVS04662	LVS04662	LVS04662 + LVS04671 (fixings)	LVS04662 + LVS04671 (fixings)	
In sheath: PrismaSeT P L400 with 75 mm distance between bars	Number of supports	≤ 25	1	1	1	1	1	1	1	1	1	
	depending on l _{cw}	≤ 40	2	2	2	2	2	2	2	2	2	
	(kA rms/1 s)	≤ 50	2	2	2	2	2	2	2	2	2	
	≤ 85	-	-	2	-	2	-	2	-	2	-	
	References	Fixed support	LVS04664	LVS04664	LVS04664	LVS04664	LVS04664	LVS04664	LVS04664	LVS04664	LVS04664 + LVS04671 (fixings)	LVS04664 + LVS04671 (fixings)
Free Support	LVS04662	LVS04662	LVS04662	LVS04662	LVS04662	LVS04662	LVS04662	LVS04662	LVS04662	LVS04662 + LVS04671 (fixings)	LVS04662 + LVS04671 (fixings)	
In sheath: PrismaSeT P L300 or PrismaSeT HD L300/PH with 75 mm distance between bars	Number depending on l _{cw}	≤ 30	1	1	1	1	1	1	1	1	1	
	(kA rms/1 s)	≤ 50	2	2	2	2	2	2	2	2	2	
	≤ 85	-	-	2	-	2	-	2	-	2	-	
	References	Fixed support	LVS04664 (PrismaSeT P) or NSYBHS500 (PrismaSeT HD D500) or NSYBHS600 (PrismaSeT HD D600) or NSYBHS800 (PrismaSeT HD D800)	LVS04664 (PrismaSeT P) or NSYBHS500 (PrismaSeT HD D500) or NSYBHS600 (PrismaSeT HD D600) or NSYBHS800 (PrismaSeT HD D800)	LVS04664 (PrismaSeT P) or NSYBHS500 (PrismaSeT HD D500) or NSYBHS600 (PrismaSeT HD D600) or NSYBHS800 (PrismaSeT HD D800)	LVS04664 (PrismaSeT P) or NSYBHS500 (PrismaSeT HD D500) or NSYBHS600 (PrismaSeT HD D600) or NSYBHS800 (PrismaSeT HD D800)	LVS04664 (PrismaSeT P) or NSYBHS500 (PrismaSeT HD D500) or NSYBHS600 (PrismaSeT HD D600) or NSYBHS800 (PrismaSeT HD D800)	LVS04664 (PrismaSeT P) or NSYBHS500 (PrismaSeT HD D500) or NSYBHS600 (PrismaSeT HD D600) or NSYBHS800 (PrismaSeT HD D800)	LVS04664 (PrismaSeT P) or NSYBHS500 (PrismaSeT HD D500) or NSYBHS600 (PrismaSeT HD D600) or NSYBHS800 (PrismaSeT HD D800)	LVS04664 (PrismaSeT P) or NSYBHS500 (PrismaSeT HD D500) or NSYBHS600 (PrismaSeT HD D600) or NSYBHS800 (PrismaSeT HD D800)	LVS04664 (PrismaSeT P) or NSYBHS500 (PrismaSeT HD D500) or NSYBHS600 (PrismaSeT HD D600) or NSYBHS800 (PrismaSeT HD D800) + LVS04671 (fixings)	LVS04664 (PrismaSeT P) or NSYBHS500 (PrismaSeT HD D500) or NSYBHS600 (PrismaSeT HD D600) or NSYBHS800 (PrismaSeT HD D800) + LVS04671 (fixings)
	Free Support	LVS04662	LVS04662	LVS04662	LVS04662	LVS04662	LVS04662	LVS04662	LVS04662	LVS04662	LVS04662 + LVS04671 (fixings)	LVS04662 + LVS04671 (fixings)
In PrismaSeT HD cubicle L700 with 115 mm distance between bars	Number depending on l _{cw}	≤ 30	-	2	2	2	2	2	2	2	2	
	(kA rms/1 s)	≤ 40	-	3	3	3	3	3	3	3	3	
	≤ 60	-	-	3	3	3	3	3	3	3	3	
	≤ 75	-	-	4	4	4	4	4	4	4	4	
	≤ 85	-	-	-	-	4	3	4	3	4	3	
	References	Fixed support	LVS04664	LVS04664	LVS04664	LVS04664	LVS04664	LVS04664	LVS04664	LVS04664	LVS04664	LVS04664 + LVS04671 (fixings)
Free Support	LVS04678	LVS04678	LVS04678	LVS04678	LVS04678	LVS04678	LVS04678	LVS04678	LVS04678	LVS04678	LVS04678 + LVS04671 (fixings)	
In PrismaSeT HD L300 sheath with 115 mm distance between bars	Characteristics	2 fixed supports for 700 wide frame and 1 fixed support for 300/400 wide frame are compulsory. If more supports are needed, add support arms.										
	Number depending on l _{cw}	≤ 50	-	1	1	1	1	1	1	1	1	
	≤ 85	-	-	2	-	2	-	2	-	2	-	
	References	Fixed support	LVS04664	LVS04664	LVS04664	LVS04664	LVS04664	LVS04664	LVS04664	LVS04664	LVS04664	LVS04664 + LVS04671 (fixings)
Free Support	LVS04678	LVS04678	LVS04678	LVS04678	LVS04678	LVS04678	LVS04678	LVS04678	LVS04678	LVS04678	LVS04678 + LVS04671 (fixings)	

Joining

Sliding joints with self-breaking lock nut

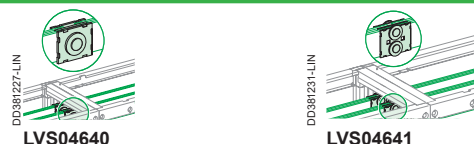

References (1 joint per phase)	LVS04640	LVS04641	LVS04640	LVS04641	LVS04641	LVS04640	LVS04641	LVS04643
---------------------------------------	----------	----------	----------	----------	----------	----------	----------	----------

Note: When installed at the bottom of a cubicle, the busbar must be partitioned. For more information on Partitioning, please refer PrismaSeT P Catalog, Section - H.



Linergy BZ

Quick busbar systems

IEC 61439-1 & UL845

DB40324-LIN

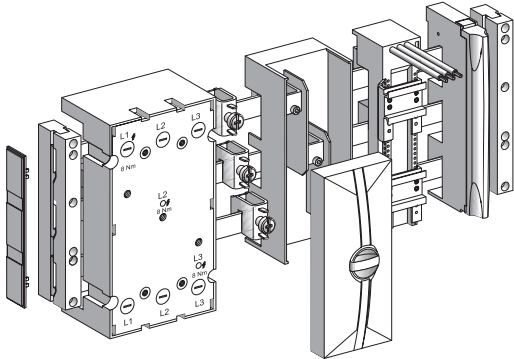

Description

This mounting plate system for busbars simplifies the installation of motor feeder components used in your electrical installations. Power distribution is performed by a busbar. The mounting plates are fitted directly on this busbar, by snap-on mounting, thus implementing electrical distribution.

IEC busbar supports				IEC accessories		
Number of poles	3		4		-	
	LA9ZX01495	LA9ZX01573	LA9ZX01485	LA9ZX01131	LA9ZX01244	LA9ZX01245
	For 12, 15, 20, 25, 30 x 5/10 mm ² busbars	End covers for 3-pole busbar support	For 12, 15, 20, 25, 30 x 5/10 mm ² busbars	End covers for 4-pole busbar support (5 left, 5 right)	1m busbar cover 5mm	1m busbar cover 10mm
Set of	10	10	10	10	10	10
References	LA9ZX01495	LA9ZX01573	LA9ZX01485	LA9ZX01131	LA9ZX01244	LA9ZX01245

UL busbar supports			UL accessories			
Number of poles	3		3		-	
	LA9ZX01508	LA9ZX01573	LA9ZX01515		LA9ZX01244	LA9ZX01245
	For 12, 20, 30 x 5/10 mm busbars	End covers for busbar support	Base plate 240 x 700		1m busbar cover 5mm	1m busbar cover 10mm
Set of	10	10	2		10	10
References	LA9ZX01508	LA9ZX01573	LA9ZX01515		LA9ZX01244	LA9ZX01245

Linergy BZ

Quick busbar systems

Technical data

General characteristics								
LA9ZX01495 and LA9ZX01485 (IEC)								
Compatibility of bar dimensions	12 x 5 mm	15 x 5 mm	20 x 5 mm	25 x 5 mm	30 x 5 mm	12 x 10 mm	20 x 10 mm	30 x 10 mm
Rated operational current at 40° (Ie)	200 A	250	320	400	450	360	520	630
Rated peak withstand current (Ipk)	30 kA	30 kA	30 kA	30 kA	45 kA	35 kA	35 kA	53 kA
Distance max. between 2 busbars supports	570 mm	570 mm	570 mm	570 mm	570 mm	570 mm	570 mm	570 mm
Degree of protection	IP20 with cover LA9ZX01244 or LA9ZX01245							
Thermal resistance	125°C							
Rated current frequency	50/60 Hz							
Rated insulation voltage	690 V							
Rated operating voltage	690 V							



LA9ZX01508 (UL)								
Compatibility of bar dimensions	12 x 5 mm	20 x 5 mm	30 x 5 mm	12 x 10 mm	20 x 10 mm	30 x 10 mm		
Rated operational current at 40° (Ie)	150 A	362 A	500 A	300 A	564 A	630 A		
Irms surge current	18 kA	18 kA	22 - 25 kA	18 kA	18 kA	22 - 25 kA		
SCCR (protected by ComPacT NSX circuit breaker)	250 A 480 V AC	65 kA	-	-	65 kA	-	-	
	250 A 600 V AC	25 kA	-	-	25 kA	-	-	
	400 A 480 V AC	-	65 kA	65 kA	-	65 kA	65 kA	
	400 A 600 V AC	-	35 kA	35 kA	-	35 kA	35 kA	
	500 A 480 V AC	-	-	65 kA	-	-	65 kA	
	600 A 600 V AC	-	-	35 kA	-	-	-	
	600 A 480 V AC	-	-	50 kA	-	-	50 kA	
SCCR (protected by fuses Class J or T, etc.)	400 A 480 V AC	100 kA	100 kA	100 kA	100 kA	100 kA	100 kA	
	500 A 480 V AC	-	-	100 kA	-	-	100 kA	
	500 A 600 V AC	-	-	100 kA	-	-	100 kA	
Max. distance between 2 busbar supports (busbar protected)	400 mm	800 mm	800 mm	400 mm	800 mm	800 mm		
Degree of protection	IP20 with cover LA9ZX01244 or LA9ZX01245							
Thermal resistance	125 °C							
Rated current frequency	50/60 Hz							
Rated operating voltage	600 V							





Linergy BZ

Quick busbar systems

For TeSyS Power - Motor Circuit Breaker & TeSyS Control Contactors

				
	PB112418	PB112417	PB112420	
	LA9ZA32443, LA9ZA32621	LA9ZA32434, LA9ZA32442	LA9ZA32622, LA9ZA32623	
	Mounting plate, 1-way		Mounting plate, 2-way	
Operating current AC-3 440 V	25 A	32 A	25 A	32 A
For TeSyS Power – Deca Motor Circuit Breakers	GV2 ME GV2 P GV2 LE	GV2 ME GV2 P GV2 LE	GV2 ME GV2 P GV2 LE	GV2 ME GV2 P GV2 LE
For TeSyS Control – Micro Contactors For TeSyS Control – Deca Contactors	LC1 D LC1 K LP4 K06-K12	LC1 D	LC1 D LC1 K LP4 K06-K12	LC1 D
Dimensions (L x H x W) (mm)	45 x 200 x 63	45 x 200 x 63 54 x 200 x 63 63 x 200 x 63	90 x 200 x 63	90 x 200 x 63
Set of	4	4 4 4	2	2
References	LA9ZA32621	LA9ZA32434 LA9ZA32442 LA9ZA32443	LA9ZA32622	LA9ZA32623

For TeSyS Control - Ultra Motor Starter

		
	PB112416	PB112419
	LA9ZA32427	LA9ZA32428
	Mounting plate, 1-way	
Operating current AC-3 440 V	32 A	
For TeSyS Control - Ultra Motor Starter	LUB12, LUB32	
Dimensions (L x H x W) (mm)	45 x 200 x 63	45 x 260 x 63
Set of	4	
References	LA9ZA32427	LA9ZA32428

Linergy BZ

Quick busbar systems

Determining the spacing between busbar supports (LA9ZX01495 and LA9ZX01485), according to IEC 61439-1⁽¹⁾

Short-circuit withstand diagram according to UL845 (LA9ZX01508)

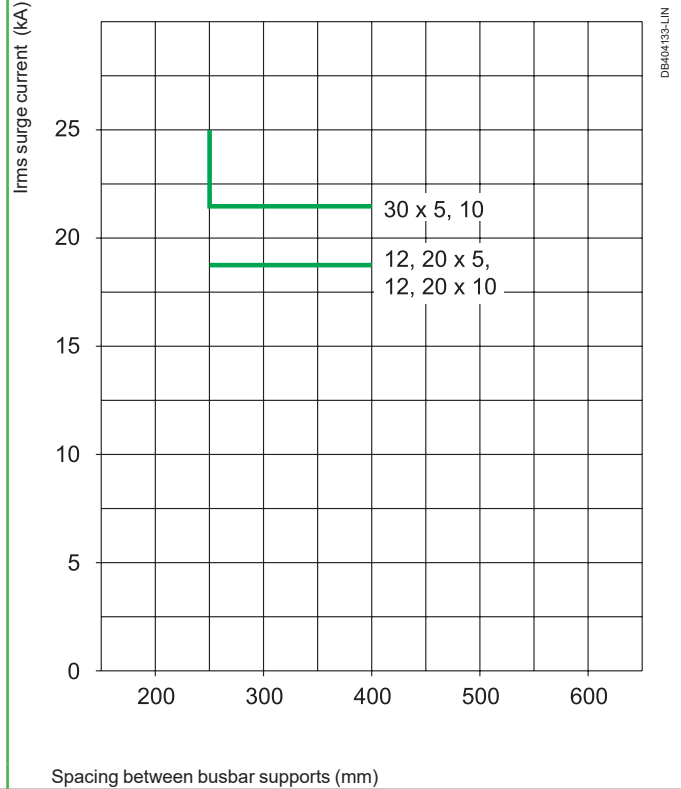
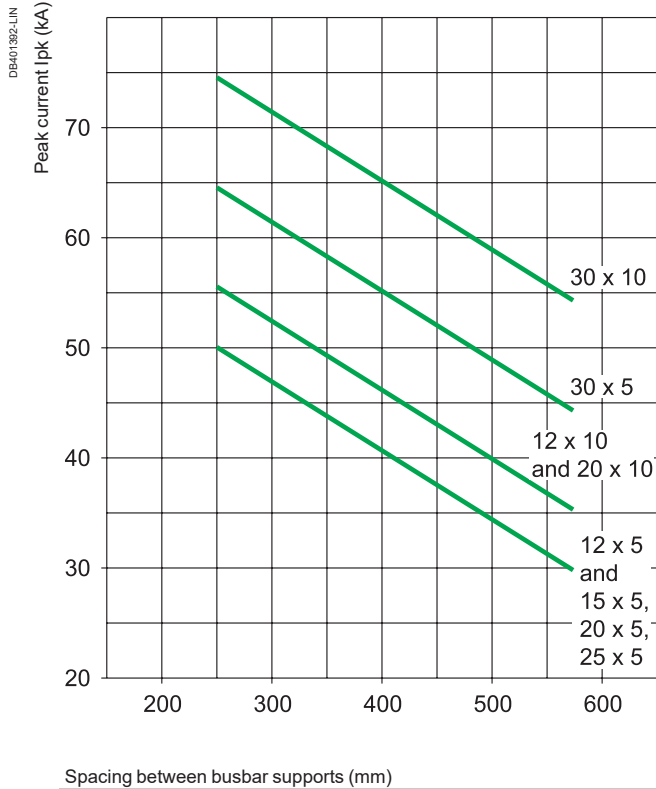



(1) Depending on the short-circuit current.



Linergy BZ

Quick busbar systems

For TeSys Power - Deca Motor Circuit Breaker Frame 3

			
	PB112422	PB112423	PB112426
	LA9ZA32624	LA9ZA32625	LA9ZA32626
	Mounting plate, 1-way		Mounting plate, 2-way
Operating current AC-3 440 V	63 A		25 A
For TeSys Power - Deca Circuit Breaker Frame 3	GV3 P	GV3 P	GV3 P
For TeSys Control - Deca contactors	-	LC1 D40A...65 A	LC1 D40A...65 A
Dimensions (L x H x W) (mm)	54 x 200 x 63	54 x 260 x 63	117 x 260 x 63
Set of	4	4	2
References	LA9ZA32624	LA9ZA32625	LA9ZA32626

For ComPacT NSX Circuit Breakers

				
	PB112431	PB112430	PB112429	PB112432
	Mounting plate for 3P ComPacT NSX circuit breakers	Mounting plate for 4P ComPacT NSX circuit breakers	Mounting plate for 3P ComPacT NSX circuit breakers	Mounting plate for 4P ComPacT NSX circuit breakers
Rated operational current at 40° (Ie)	100-250 A		400-630 A	
Dimensions (L x H x W) (mm)	104 x 190 x 63	139 x 251 x 63	139 x 270 x 63	139 x 270 x 63
Set of	1	1	1	1
References	LV429372	LV429373	LV432623	LV432624

Linergy BZ

Quick busbar systems

Technical data

Characteristics of busbar mounting plates					
Type of mounting plate	LA9ZA32621 LA9ZA32622	LA9ZA32427 LA9ZA32428 LA9ZA32434 LA9ZA32623 LA9ZA32442 LA9ZA32443	LA9ZA32624 LA9ZA32625 LA9ZA32626	LV429372 LV429373	LV432623 LV432624
Degree of protection as per IEC 60529 (IP)	20				
Rated insulation voltage	690 V				
Permissible current	25 A	32 A	63 A	80 A - 100 A - 250 A	400 A-630 A
Peak rated current	50 kA	50 kA ⁽¹⁾	50 kA	50 kA	50 kA
SCCR (UL) with ComPacT NSX circuit breaker protection (mm ²)	The cascading reinforced breaking capacity when combining circuit breakers is maintained				
Conductor cross section (colour: black)	4 mm ² 12 AWG	6 mm ² 10 AWG	10 mm ² 8 AWG	-	-
Type of conductor insulating material (PVC)	105°				

(1) 35 kA with TeSys LUB12 for LA9ZA32427 and LA9ZA32428.



For 3P PowerPact circuit breakers

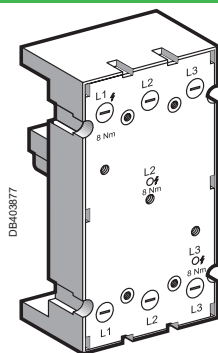





LA9ZA32600

	Mounting plate for H frame circuit breakers	Mounting plate for J frame circuit breakers	Mounting plate for L frame circuit breakers
Rated operational current at 40° (Ie)	60-100-150 A	100-250 A	250-400-600 A
Dimensions (L x H x W) (mm)	104 x 190 x 63	104 x 190 x 63	139 x 270 x 63
Set of	1	1	1
References	LA9ZA32600	LV429372	LV432623

Linergy BZ

Quick busbar systems

Terminals			
Number of poles	1P		
	PB112437 	PB112438 	PB112439 
	LA9ZX01285	LA9ZX01287	LA9ZX01413
	For flat bars, 5 mm		3P cover, width 84 mm
Rated operational current at 40° (Ie)	270 A	400 A	
Supply at incoming terminals	4 - 35 mm ²	16 - 70 mm ²	
Set of	50	25	10
References	LA9ZX01285	LA9ZX01287	LA9ZX01413

Terminals on mounting plate	
Number of poles	3P
	PB112434 
	LA9ZX01243
	On mounting plate + cover, for 12 x 5 to 30 x 10 busbars
Rated operational current at 40° (Ie)	440 A
Supply at incoming terminals	35 - 120 mm ²
Set of	1
References	LA9ZX01243

Connection module	
Number of poles	3P
	PB112444 
	LA9ZX01563
	Spring terminal connection + cover, for busbars of 12 x 5 to 30 x 10
Rated operational current at 40° (Ie)	63 A
Supply at incoming terminals	1.5 - 16 mm ²
Set of	8
References	LA9ZX01563

Linergy BZ

Quick busbar systems

Technical data

Connection by connectors								
	LA9ZX01285		LA9ZX01287		LA9ZX01243		LA9ZX01563	
	Min.	Max.	Min.	Max.	Min.	Max.	Min.	Max.
Flexible wire	4 mm ²	35 mm ²	16 mm ²	70 mm ²	35 mm ²	120 mm ²	1.5 mm ²	16 mm ²
Multi-core wire	4 mm ²	35 mm ²	16 mm ²	70 mm ²	35 mm ²	120 mm ²	1.5 mm ²	16 mm ²
Rigid wire	4 mm ²	35 mm ²	-	-	-	-	1.5 mm ²	16 mm ²
Tightening torque	... x 5 N.m Supplied without cover		... x 5 N.m Supplied without cover		... x 5-10 N.m		... x 5-10 N.m	



Hot plug busbar system

Contents

Linergy HK	E - 2
Hot plug pre-assembled busbar systems	E - 2

Linergy HK

Hot plug pre-assembled busbar systems

IEC 61439

Description

The assembly of automated control and distribution panels requires the use of products that are not only safe, but also simple and quick to mount and wire up. These pre-assembled busbar systems meet all these criteria.

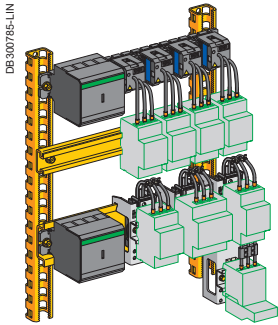

Busbar systems

PB112408

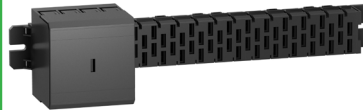

Number of conductors	4					
Number of tap-offs at 18 mm intervals	12	18	24	30	48	54
Length (mm)	344	452	560	668	992	1100
Suitable for mounting in enclosure width (mm)	600	800	800	800	1200	1200
References	AK5JB143	AK5JB144	AK5JB145	AK5JB146	AK5 JB149	AK5JB1410

Lineryg HK

Hot plug pre-assembled busbar systems

Technical data

Busbar system characteristics							
Product certifications		UL, CSA, DNV, LROS					
Degree of protection	Against access to live parts	IPxxB conforming to IEC 60529					
Flame resistance	Conforming to IEC 60695	850°C (incandescent wire)					
	Conforming to standard UL 94	V0					
Number of conductors	AK5 JB14p	4					
Supply current		AC					
Rated operational current (Ie)	Ambient temperature 35°C	160 A					
	K coefficient to be applied according to the ambient temperature	35°C	40°C	45°C	50°C	55°C	60°C
Rated insulation voltage (Ui)	Conforming to IEC 61439-1	1 K	0.96 K	0.92 K	0.88 K	0.83 K	0.78 K
	Conforming to UL and CSA	690 V					
Operational voltage (Ue)	Conforming to UL and CSA	600 V					
		Off-load plugging-in and unplugging, with power on					
	Conforming to IEC 61439-1	400 V					
	Conforming to UL, CSA	480 V					
		Plugging-in and unplugging, with power off					
	Conforming to IEC 61439-1	690 V					
	Conforming to UL, CSA	600 V					
Maximum permissible peak current		25 kA					
Maximum let-through energy (I ² t)		1 x 10 ⁷ A ² s					
Rated operational frequency		50 Hz or 60 Hz					
Upstream short-circuit (1) and overload protection	Type of protection	Schneider Electric circuit-breaker		Fuses			
		NSX 160 N	NSX 160 H	aM	gF		
	Rating	160 A	160 A	160 A	160 A		
	Prospective short-circuit current	36 kA	70 kA	100 kA	100 kA		
	Operational current	160	160	160	160		
Supply incoming terminals		Maximum c.s.a.		Minimum c.s.a.			
	Flexible cable with cable end	70 mm ²		2.5			
	Solid cable	70 mm ²		2.5			
	Tightening torque	10 Nm					
Installation	Horizontal or vertical (2)	Fixing with screws provided					



(1) For conditions where conditional short-circuit current exceeds 25 kA.



(2) Using side stop **AK5 BT01** on mounting plates **AK5 PA**.



Linergy HK

Hot plug pre-assembled busbar systems

	Omega rail, width 75 mm	Removable power sockets				
						
	AM1DL201	AK5PC12				AK5PC12PH
Number of poles		Single-phase + Neutral			2-phase	
Material and surface treatment	2 mm sheet steel					
Number of points used on the busbar system	1					
Rated operational current at 40° (Ie)	16 A		32 A	32 A	16 A	32 A
Length (mm)	2000 (1)	200	1000	2000	200	1000
Depth (mm)	15					
Set of	6					
References	AM1DL201	AK5PC12	AK5PC32L	AK5PC32L2	AK5PC12PH	AK5PC32LPH

	Component mounting plates incorporating tap-off				
	Single plate (height 105 mm)				
					
	AK5PA211N1				AK5PA211PH12
Number of poles	Single-phase + Neutral				2-phase
No. of 18 mm points used on the busbar system	3				
Rated operational current at 40° (Ie)	25 A	25 A	25 A	25 A	
Phase	Ph1+N	Ph2+N	Ph3+N	Ph1+Ph2	
Number of 6 rails for component support	1	1	1	1	
References	AK5PA211N1	AK5PA211N2	AK5PA211N3	AK5PA211PH12	

	Component mounting plates incorporating tap-off				
	Double plate (height 190 mm)				
					
	AK5PA232				
Number of poles	Single-phase + Neutral			2-phase	
No. of 18 mm points used on the busbar system	3				
Rated operational current at 40° (Ie)	25 A	25 A	25 A	25 A	25 A
Phase	Ph1+N	Ph2+N	Ph3+N	Ph1+Ph2	Ph1+Ph3
Number of 6 rails for component support	2	2	2	2	2
References	AK5PA212N1	AK5PA212N2	AK5PA212N3	-	-

(1) Cut and drill to suit use. (2) Total of 6 sockets supplied: 2 sockets (N + L1), 2 sockets (N + L2), 2 sockets (N + L3).

(3) Total of 6 sockets supplied: 2 sockets (L1 + L2), 2 sockets (L1 + L3), 2 sockets (L2 + L3).

Linergy distribution systems - Hot plug busbar system

Linergy HK

Hot plug pre-assembled busbar systems

			 <small>PB112412</small>						
AK5PC13 3-phase			AK5PC14 3-phase + Neutral				AK5PC14 3-phase + Common		
2			2				2		
16 A	32 A		16 A	32 A	32 A	16 A (10 Common)	32 A (10 Common)		
200	250	1000	200	250	1000	2000	200	250	
6	6	6	6	6	6	6	6	6	
AK5PC13	AK5PC33	AK5PC33L	AK5PC14	AK5PC34	AK5PC34L	AK5PC34L2	AK5PC131	AK5PC331	

		 <small>LAGNEAU_GM1_EN40_12_04_5009</small>		
		AK5PA231		
		3-phase	3-phase + Common	3-phase + Neutral
		3	3	3
25 A	25 A	25 A	25 A	25 A
Ph1+Ph3	Ph2+Ph3	-	-	-
1	1	1	1	1
AK5PA211PH13	AK5PA211PH23	AK5PA231	AK5PA2311	AK5PA241

			 <small>PB112409</small>				
			AK5PA242				
3-phase			3-phase + Neutral	3-phase + Common		3-phase + Neutral	
3			3	3		6	
25 A	25 A	50 A	25 A	25 A (10 Common)	25 A (10 Common)	50 A (10 Common)	50 A
-	-	-	-	-	-	-	-
2	2	1	2	2	2	1	1
AK5PA232	AK5PA232S	AK5PA532	AK5PA242	AK5PA2312	AK5PA2312S	AK5PA5312	AK5PA542









Terminal blocks and bars

Contents

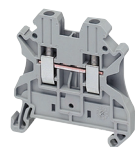
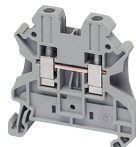
Linergy TR	F - 2
Selection guide - Screw terminal blocks	F - 2
Selection guide - Spring terminal blocks	F - 28
Selection guide - Push in terminal blocks	F - 52
Accessories	F - 58
Marking accessories	F - 60
Linergy TB	F - 64
Earth bars	F - 64
PE Conductors	F - 65
Linergy TA	F - 64
Auxiliary connections	F - 68

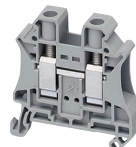
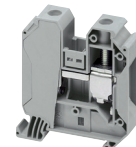
Lineryy TR

Selection guide: screw terminal blocks

		Passthrough				
						
Nominal c.s.a (mm ²)		2.5	4	6	10 & 16	35 to 70
Number of poles	1 - 1 x 1	NSYTRV22	NSYTRV42	NSYTRV62	NSYTRV102 NSYTRV162	NSYTRV352 NSYTRV502 NSYTRV702
	1 - 1 x 2	-	-	-	-	-
	1 - 2 x 2	-	-	-	-	-
Colours	Grey	■	■	■	■	■
	Blue	NSYTRV22BL	NSYTRV42BL	NSYTRV62BL	NSYTRV102BL NSYTRV162BL	NSYTRV352BL NSYTRV502BL NSYTRV702BL
	Green/yellow (PE)	-	-	-	-	-
	Orange	NSYTRV22AR	NSYTRV42AR	-	-	-
	Red	NSYTRV22RD	NSYTRV42RD	-	-	-
	Green	-	NSYTRV42GN	-	-	-
	White	NSYTRV22WH	NSYTRV42WH	-	-	-
	Black	-	NSYTRV42BK	-	-	-
Mounting on	35 mm 	■	■	■	■	■
	35 mm 	■	■	■	■	■
	Telequick	-	-	-	-	-
	15 mm 	-	-	-	-	-
See pages		80	81	81	81	82

PE502410-70



Snap-on PE foot

Earth terminal blocks are simply snapped onto the DIN rail to make contact. This mechanically and electrically efficient connection meets all the requirements of standard IEC 60947-7-2.



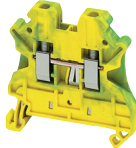
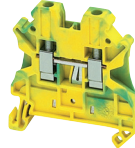
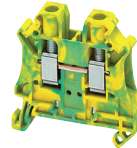
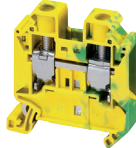

Linery TR

Selection guide: screw terminal blocks

	Lug to Lug	Protective earth						
PE60220-30		PE602174		PE602176		PE602175		
	95 & 150	2.5	4	6 & 10	16 to 50			
	NSYTRV1502B	NSYTRV22PE	NSYTRV42PE	NSYTRV62PE NSYTRV102PE	NSYTRV162PE NSYTRV352PE NSYTRV502PE			
	-	-	NSYTRV43PE	-	-			
	-	-	NSYTRV44PE	-	-			
	■	-	-	-	-			
	-	-	-	-	-			
	-	■	■	■	■	■		■
	-	-	-	-	-			-
	-	-	-	-	-			-
	-	-	-	-	-			-
	■	■	■	■	■	■		■
	■	■	■	■	■	■		■
	-	-	-	-	-			-
	-	-	-	-	-			-
	83	84	84	84/85	85			

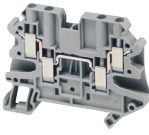
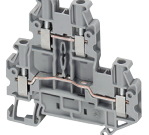
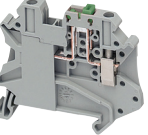
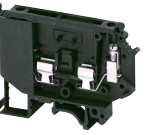
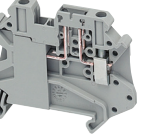
Lineryy TR

Selection guide: screw terminal blocks

		Double deck		Disconnect		
		Multi-pole	Double deck	Blade	Fused	Removable carrier
						
Nominal c.s.a (mm ²)		2.5 & 4	2.5 & 4	2.5 & 4	4 & 16	2.5 & 4
Number of poles	1 - 1 x 1	-	-	NSYTRV22SC NSYTRV22ST NSYTRV42SC	NSYTRV42SF5 NSYTRV42SF6 NSYTRV162SF	NSYTRV22TB NSYTRV42TB
	2 - 1 x 1	-	NSYTRV24D NSYTRV44D	NSYTRV42SCD	-	-
	3 - 1 x 1	-	NSYTRV26T	-	-	-
	5 - 1 x 1	-	-	-	-	-
	10 - 1 x 1	-	-	-	-	-
	1 - 1 x 2	NSYTRV43	-	-	-	-
	1 - 2 x 2	NSYTRV44	-	-	-	-
	With LED	-	-	-	NSYTRV42SF5LD NSYTRV42SF6LD	-
Colours	Grey	■	■	■	-	■
	Blue	-	NSYTRV24DBL NSYTRV44DBL	■	-	-
	Green/yellow (PE)	-	NSYTRV24DPE NSYTRV44DPE	-	-	-
	Orange	-	-	NSYTRV42STAR	-	-
	Mounting on	35 mm 	■	■	■	■
	35 mm 	■	■	■	■	■
	Telequick	-	-	-	-	-
	15 mm 	-	-	-	-	-
See pages		86/87/90/91	87/88	92/93	94	93

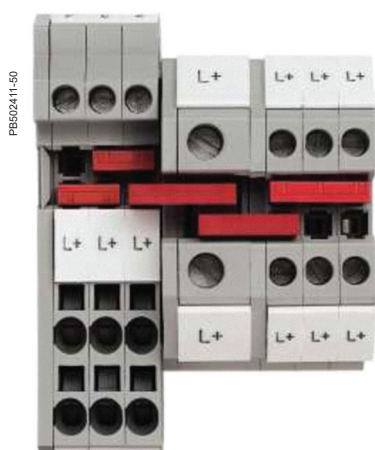



Flexible plug-in bridge system

The **NSYTRAL*** plug-in bridges allow potential distribution to be implemented quickly. All terminals have two bridge shafts to make flexible chain bridging, step bridging or bridging between nonadjacent terminal blocks possible. The reducing bridge permits simple connection of terminal blocks with different nominal cross-sections, (e.g. an **NSYTRV102** terminal connected to an **NSYTRV22** terminal. This way the power distribution terminal blocks can be quickly setup.

Linery TR

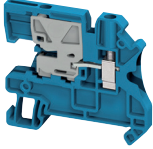
Selection guide: screw terminal blocks

	Measuring	For neutral conductors	Miniature	DB6		
			Passthrough	With Telequick universal foot		
PE602206		PE602221 	PE602751-20 	PE601877-4-18 		
	6	4 to 10	2.5 & 4	4	6	35
	NSYTRV62TTD	- NSYTRV62NE	NSYTRV22M NSYTRV42M	-	-	-
	-	-	-	-	-	-
	-	-	-	-	-	-
	-	-	-	-	-	-
	-	-	-	-	-	-
	-	-	-	-	-	-
	■	-	■	■	■	■
	-	■	NSYTRV22MBL NSYTRV42MBL	-	-	-
	NSYTRV62TTPE	-	NSYTRV22MPE NSYTRV42MPE	-	-	-
	-	-	-	-	-	-
	■	■	-	■	■	■
	■	■	-	■	■	■
	-	-	-	■	■	■
	-	-	■	-	-	-
	96/97	98	100/101	-	-	-



Lineryy TR

Screw terminal blocks

Screw terminal blocks - Passthrough

PBS02081-20

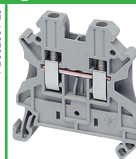

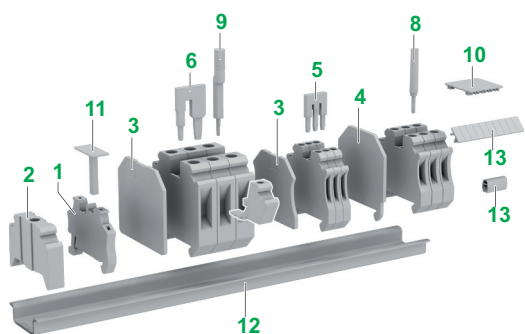

		NSYTRV22		
Nominal c.s.a.		2.5 mm ²		
	Type of block	Passthrough		
	Type of connection	1 pole - 1 x 1		
	Colour	Grey		
Max. electric values (U _{max} , I _{max})		1000 V, 32 A		
Dimensions (mm)				
	Length	47.7		
	Height	47.5		
	Width	5.2		
Cabling c.s.a. (mm ²)		2.5		
	Flexible cable	0.14 - 4		
	Solid cable	0.14 - 4		
Nominal electric values				
	IEC/EN 60947-7-1	1000 V, 24 A		
	UL	600 V, 20 A, 26 - 12 AWG		
	CSA	600 V, 20 A, 26 - 12 AWG		
Certifications		UL, CSA, VDE, GL, LR, DNV		
Terminal blocks				
	Grey	Sold in lots of 50	Unit reference NSYTRV22	
	Blue	50	NSYTRV22BL	
	Orange	50	NSYTRV22AR	
	Red	50	NSYTRV22RD	
	Green	-	-	
	White	50	NSYTRV22WH	
	Black	-	-	
Accessories				
1	End stop	Clip-on, 5.2 mm	50	NSYTRAAB35
2	for 35 mm DIN rail	With screw, 9.5 mm	50	NSYTRAABV35
3	End plate	Grey	50	NSYTRAC22
		width 2.2 mm	50	NSYTRAC22BL
4	Partition plate, width 2 mm	Grey	50	NSYTRAP22
5	Plug-in bridge	2-pole	50	NSYTRAL22
		3-pole	50	NSYTRAL23
		4-pole	50	NSYTRAL24
		5-pole	50	NSYTRAL25
		10-pole	10	NSYTRAL210
		20-pole	10	NSYTRAL220
	Blue	10-pole	10	NSYTRAL210BL
	Grey	10-pole	10	NSYTRAL210GR
6	Step-down bridge, down to 2.5/4 mm ²	Screw to screw terminal	-	-
		Screw to spring terminal	-	-
8	Test plug	Metallic part, Ø 2.3 mm	10	NSYTRAATM1
		Insulating sleeve, red	10	NSYTRAATP1
9	Test adaptor	For plug-in bridge shaft	10	NSYTRAFT
10	Warning label	Yellow	10	NSYTRACS2
11	Marker tag holder	For ●AB35 end stop	100	NSYTRASB4
12	DIN rail 35 x 7.2 mm	Perforated, 2 m long	20	NSYSDR200BD
13	Marking accessories			See page 142
General data				
	Strip length (mm)		9	
	Screw thread		M3	
	Torque (Nm)		0.5 - 0.6	

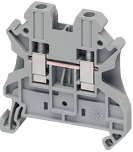

Linery TR

Screw terminal blocks

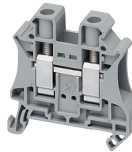
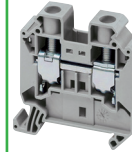
 <small>PB6216E-20</small>		 <small>PB62167-20</small>		 <small>PB62173-20</small>		 <small>PB6218E-20</small>	
NSYTRV42	4 mm ²	NSYTRV62	6 mm ²	NSYTRV102	10 mm ²	NSYTRV162	16 mm ²
Passthrough		Passthrough		Passthrough		Passthrough	
1 pole - 1 x 1		1 pole - 1 x 1		1 pole - 1 x 1		1 pole - 1 x 1	
Grey		Grey		Grey		Grey	
1000 V, 41 A		1000 V, 57 A		1000 V, 76 A		1000 V, 101 A	
47.7		47.7		47.7		55.5	
47.5		47.5		47.5		55	
6.2		8.2		10.2		12.2	
4		6		10		16	
0.14 - 6		0.2 - 10		0.5 - 16		1.5 - 25	
0.14 - 6		0.2 - 10		0.5 - 16		1.5 - 25	
1000 V, 32 A		1000 V, 41 A		1000 V, 57 A		1000 V, 76 A	
600 V, 30 A, 26 - 10 AWG		600 V, 50 A, 24 - 8 AWG		600 V, 65 A, 20 - 6 AWG		600 V, 85 A, 16 - 4 AWG	
600 V, 30 A, 26 - 10 AWG		600 V, 50 A, 24 - 8 AWG		600 V, 65 A, 20 - 6 AWG		600 V, 85 A, 16 - 4 AWG	
UL, CSA, VDE, GL, LR, DNV		UL, CSA, VDE, GL, LR, DNV		UL, CSA, VDE, GL, LR, DNV		UL, CSA, VDE, GL, LR, DNV	
Sold in lots of	Unit reference	Sold in lots of	Unit reference	Sold in lots of	Unit reference	Sold in lots of	Unit reference
50	NSYTRV42	50	NSYTRV62	50	NSYTRV102	50	NSYTRV162
50	NSYTRV42BL	50	NSYTRV62BL	50	NSYTRV102BL	50	NSYTRV162BL
50	NSYTRV42AR	-	-	-	-	-	-
50	NSYTRV42RD	-	-	-	-	-	-
-	NSYTRV42GN	-	-	-	-	-	-
50	NSYTRV42WH	-	-	-	-	-	-
-	NSYTRV42BK	-	-	-	-	-	-
50	NSYTRAAB35	50	NSYTRAAB35	50	NSYTRAAB35	50	NSYTRAAB35
50	NSYTRAABV35	50	NSYTRAABV35	50	NSYTRAABV35	50	NSYTRAABV35
50	NSYTRAC22	50	NSYTRAC22	50	NSYTRAC22	50	NSYTRAC162
50	NSYTRAC22BL	50	NSYTRAC22BL	50	NSYTRAC22BL	-	-
50	NSYTRAP22	50	NSYTRAP22	50	NSYTRAP22	-	-
50	NSYTRAL42	10	NSYTRAL62	10	NSYTRAL102	10	NSYTRAL162
50	NSYTRAL43	10	NSYTRAL63	-	-	-	-
50	NSYTRAL44	-	-	-	-	-	-
50	NSYTRAL45	10	-	-	-	-	-
10	NSYTRAL410	10	NSYTRAL610	-	-	-	-
10	NSYTRAL420	-	-	-	-	-	-
10	NSYTRAL410BL	-	-	-	-	-	-
10	NSYTRAL410GR	-	-	-	-	-	-
-	-	10	NSYTRALV62	10	NSYTRALV102	10	NSYTRALV162
-	-	10	-	10	-	10	NSYTRALVR162
10	NSYTRAATM1	10	NSYTRAATM1	10	NSYTRAATM1	10	NSYTRAATM1
10	NSYTRAATP1	10	NSYTRAATP1	10	NSYTRAATP1	10	NSYTRAATP1
10	NSYTRAFT	10	NSYTRAFT	-	-	-	-
10	NSYTRACS4	10	NSYTRACS6	10	NSYTRACS10	10	NSYTRACS16
100	NSYTRASB4	100	NSYTRASB4	100	NSYTRASB4	100	NSYTRASB4
20	NSYS DR200BD	20	NSYS DR200BD	20	NSYS DR200BD	20	NSYS DR200BD
9		10		10		14	
M3		M4		M4		M5	
0.6 - 0.8		1.5 - 1.8		1.5 - 1.8		2.5 - 3	





*Screw bridge

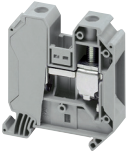

Lineryy TR

Screw terminal blocks

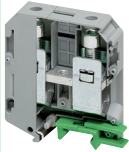
Screw terminal blocks - Passthrough

							
Nominal c.s.a.		NSYTRV352 35 mm ²	NSYTRV502 50 mm ²	NSYTRV702 70 mm ²			
	Type of block	Passthrough	Passthrough	Passthrough			
	Type of connection	1 pole - 1 x 1	1 pole - 1 x 1	1 pole - 1 x 1			
	Colour	Grey	Grey	Grey			
Max. electric values (U _{max} , I _{max})		1000 V, 125 A	1000 V, 150 A	1000 V, 192 A			
Dimensions (mm)							
	Length	60.2	70.5	70.5			
	Height	65.7	83.5	87.5			
	Width	16	20	20.3			
Cabling c.s.a. (mm ²)		35	50	70			
	Flexible cable	1.5 - 50	25 - 70	25 - 70			
	Solid cable	1.5 - 50	16 - 70	16 - 95			
Nominal electric values							
	IEC/EN 60947-7-1	1000 V, 125 A	1000 V, 150 A	1000 V, 192 A			
	UL	600 V, 150 A, 14 - 1/0 AWG	600 V, 150 A, 6 - 1/0 AWG	600 V, 192 A, 4 - 3/0 AWG			
	CSA	600 V, 150 A, 14 - 1/0 AWG	600 V, 150 A, 6 - 1/0 AWG	600 V, 192 A, 4 - 3/0 AWG			
Certifications		UL, CSA, VDE, GL	UL, CSA, VDE, GL, LR, DNV	UL, CSA, VDE, GL, LR, DNV			
Terminal blocks							
	Grey	Sold in lots of 50	Unit reference NSYTRV352	Sold in lots of 10	Unit reference NSYTRV502	Sold in lots of 10	Unit reference NSYTRV702
	Blue	50	NSYTRV352BL	10	NSYTRV502BL	10	NSYTRV702BL
Accessories							
End stop	Clip-on, 5.2 mm	50	NSYTRAAB35	50	NSYTRAAB35	50	NSYTRAAB35
for 35 mm DIN rail	With screw, 9.5 mm	50	NSYTRAABV35	50	NSYTRAABV35	50	NSYTRAABV35
End plate, width 2.2 mm	Grey	-	Included	-	Included	-	Included
Plug-in bridge	2-pole	10	NSYTRAL352	10	NSYTRAL502 *	-	-
Red							
Screw bridge	2-pole	-	-	-	-	10	NSYTRAL702
Step-down bridge, down to 2.5/4 mm ²	Screw to screw terminal	10	NSYTRALV352	-	-	-	-
Test plug	Metallic part, Ø 2.3 mm	10	NSYTRAATM1	10	NSYTRAATM1	10	NSYTRAATM1
	Insulating sleeve, red	10	NSYTRAATP1	10	NSYTRAATP1	10	NSYTRAATP1
Warning label	Yellow	10	NSYTRACS35	-	-	-	-
Marker tag holder	For ●AB35 end stop	100	NSYTRASB4	100	NSYTRASB4	100	NSYTRASB4
DIN rail 35 x 7.2 mm	Perforated, 2 m long	20	NSYS DR200BD	20	NSYS DR200BD	20	NSYS DR200BD
Marking accessories		See page 142					
General data							
	Strip length (mm)	18	24	24			
	Screw thread	M6	M6	M8			
	Torque (Nm)	3.2 - 3.7	6 - 8	08 - 10			

*Screw bridge

Lineryy TR

Screw terminal blocks

Screw terminal blocks - High current

PB602200-30





		NSYTRV1502B	
Nominal c.s.a.		150 mm ²	
	Type of block	Passthrough - lug to lug	
	Type of connection	1 pole - 1 x 1	
	Color	Grey	
Max. electric values		1500 V, 309 A	
Dimensions (mm)			
	Length	235	
	Height	84	
	Width	41	
Cabling c.s.a. (mm ²)		6 mm ² to 150 mm ²	
	Flexible cable	6 mm ² to 150 mm ²	
	Solid cable	6 mm ² to 150 mm ²	
Nominal electric values			
	IEC/EN 60947-7-1	1500 V, 309 A	
	UL	600 V, 310 A, 10 - 350 AWG/kcmil	
	CSA	600 V, 310 A, 10 - 350 AWG/kcmil	
Certifications		UL, CSA	
Terminal blocks			
		Sold in lots of	Unit reference
		5	NSYTRV1502B
Accessories			
End stop	Clip-on, 5.2 mm	50	NSYTRAAB35
for 35 mm DIN rail	With screw, 9.5 mm	50	NSYTRAABV35
Partition plate	Grey	10	NSYTRAC952
Test plug	Metalic part, Ø 2.3 mm	10	NSYTRAATM1
	Insulating sleeve, red	10	NSYTRAATP1
Marker tag holder	For ●AB35 end stop	100	NSYTRASB4
DIN rail 35 x 7.2 mm	Perforated, 2 m long	20	NSYSR200BD
Marking accessories		See page 154	
General data			
	Strip length (mm)	The stripping length depends on the specification provided by the cable lug manufacturer.	
	Screw thread	M10	
	Torque (Nm)	10-20	



Lineryy TR

Screw terminal blocks

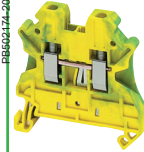
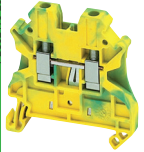
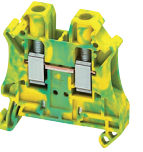
Screw terminal blocks - Protective earth

							
		NSYTRV22PE	NSYTRV42PE	NSYTRV62PE			
Nominal c.s.a.		2.5 mm ²	4 mm ²	6 mm ²			
	Type of block	Protective earth	Protective earth	Protective earth			
	Type of connection	1 pole - 1 x 1	1 pole - 1 x 1	1 pole - 1 x 1			
	Colour	Green/Yellow	Green/Yellow	Green/Yellow			
Max. electric values		-	-	-			
Dimensions (mm)							
	Length	47.7	47.7	47.7			
	Height	47.5	47.5	47.5			
	Width	5.2	6.2	8.2			
Cabling c.s.a. (mm ²)		2.5	4	6			
	Flexible cable	0.14 - 4	0.14 - 6	0.2 - 10			
	Solid cable	0.14 - 4	0.14 - 6	0.2 - 10			
Nominal electric values							
	IEC/EN 60947-7-1	-	-	-			
	UL	26 - 12 AWG	26 - 10 AWG	24 - 8 AWG			
	CSA	26 - 12 AWG	26 - 10 AWG	24 - 8 AWG			
Certifications		UL, CSA, VDE, GL, LR; DNV	UL, CSA, VDE, GL, LR, DNV	UL, CSA, VDE, GL, LR, DNV			
Terminal blocks							
	Green/Yellow	Sold in lots of 50	Unit reference NSYTRV22PE	Sold in lots of 50	Unit reference NSYTRV42PE	Sold in lots of 50	Unit reference NSYTRV62PE
Accessories							
End stop for 35 mm DIN rail	Clip-on, 5.2 mm	50	NSYTRAAB35	50	NSYTRAAB35	50	NSYTRAAB35
	With screw, 9.5 mm	50	NSYTRAABV35	50	NSYTRAABV35	50	NSYTRAABV35
End plate, width 2.2 mm	Grey	50	NSYTRAC22	50	NSYTRAC22	50	NSYTRAC22
	Blue	50	NSYTRAC22BL	50	NSYTRAC22BL	50	NSYTRAC22BL
Partition plate, width 2 mm	Grey	50	NSYTRAP22	50	NSYTRAP22	50	NSYTRAP22
Plug-in bridge Red	2-pole	50	NSYTRAL22	50	NSYTRAL42	10	NSYTRAL62
	3-pole	50	NSYTRAL23	50	NSYTRAL43	10	NSYTRAL63
	4-pole	50	NSYTRAL24	50	NSYTRAL44	-	-
	5-pole	50	NSYTRAL25	50	NSYTRAL45	-	-
	10-pole	10	NSYTRAL210	10	NSYTRAL410	10	NSYTRAL610
Test plug	20-pole	10	NSYTRAL220	10	NSYTRAL420	-	-
Metallic part, Ø 2.3 mm		10	NSYTRAATM1	10	NSYTRAATM1	10	NSYTRAATM1
	Insulating sleeve, red	10	NSYTRAATP1	10	NSYTRAATP1	10	NSYTRAATP1
Test adaptor	For plug-in bridge shaft	10	NSYTRAFT	10	NSYTRAFT	10	NSYTRAFT
Warning label	Yellow	10	NSYTRACS2	10	NSYTRACS4	10	NSYTRACS6
Marker tag holder	For ●AB35 end stop	100	NSYTRASB4	100	NSYTRASB4	100	NSYTRASB4
DIN rail 35 x 7.2 mm	Perforated, 2 m long	20	NSYSDR200BD	20	NSYSDR200BD	20	NSYSDR200BD
Marking accessories		See page 142					
General data							
	Strip length (mm)	9		9		10	
	Screw thread	M3		M3		M4	
	Torque (Nm)	0.5 - 0.6		0.6 - 0.8		1.5 - 1.8	

Linergy TR

Screw terminal blocks

PB602106-20		PB602106-20		PB602177-20		PB602106-20	
							
NSYTRV102PE		NSYTRV162PE		NSYTRV352PE		NSYTRV502PE	
10 mm ²		16 mm ²		35 mm ²		50 mm ²	
Protective earth		Protective earth		Protective earth		Protective earth	
1 pole - 1 x 1		1 pole - 1 x 1		1 pole - 1 x 1		1 pole - 1 x 1	
Green/Yellow		Green/Yellow		Green/Yellow		Green/Yellow	
-		-		-		-	
47.7		55		65.7		70.5	
47.5		55.5		60.2		83.5	
10.2		12.2		16		20	
10		16		35		50	
0.5 - 16		1.5 - 25		1.5 - 35		25 - 70	
0.5 - 16		1.5 - 25		1.5 - 35		16 - 70	
76 A		101 A		125 A		150 A	
20 - 6 AWG		16 - 4 AWG		14 - 1/0 AWG		6 - 1/0 AWG	
20 - 6 AWG		16 - 4 AWG		14 - 1/0 AWG		6 - 1/0 AWG	
UL, CSA, VDE, GL, LR; DNV		UL, CSA, VDE, GL, LR, DNV		UL, CSA, VDE, GL		UL, CSA, GL, LR, DNV	
Sold in lots of	Unit reference	Sold in lots of	Unit reference	Sold in lots of	Unit reference	Sold in lots of	Unit reference
50	NSYTRV102PE	50	NSYTRV162PE	50	NSYTRV352PE	50	NSYTRV502PE
50	NSYTRAAB35	50	NSYTRAAB35	50	NSYTRAAB35	50	NSYTRAAB35
50	NSYTRAABV35	50	NSYTRAABV35	50	NSYTRAABV35	50	NSYTRAABV35
50	NSYTRAC22	50	NSYTRAC162	-	Included	-	Included
50	NSYTRAC22BL	-	-	-	-	-	-
50	NSYTRAP22	-	-	-	-	-	-
10	NSYTRAL102	10	NSYTRAL162	10	NSYTRAL352	-	-
-	-	-	-	-	-	-	-
-	-	-	-	-	-	-	-
-	-	-	-	-	-	-	-
-	-	-	-	-	-	-	-
10	NSYTRAATM1	10	NSYTRAATM1	10	NSYTRAATM1	10	NSYTRAATM1
10	NSYTRAATP1	10	NSYTRAATP1	10	NSYTRAATP1	10	NSYTRAATP1
-	-	-	-	-	-	-	-
10	NSYTRACS10	10	NSYTRACS16	10	NSYTRACS35	-	-
100	NSYTRASB4	100	NSYTRASB4	100	NSYTRASB4	100	NSYTRASB4
20	NSYSR200BD	20	NSYSR200BD	20	NSYSR200BD	20	NSYSR200BD
10		14		18		24	
M4		M5		M6		M6	
1.5 - 1.8		2.5 - 3		3.2 - 3.7		6 - 8	



Lineryy TR

Screw terminal blocks

Screw terminal blocks - Double deck passthrough

PB502181-20

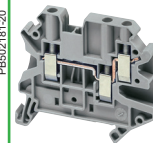

		NSYTRV43	
Nominal c.s.a.		4 mm ²	
	Type of block	Passthrough - Multi-pole	
	Type of connection	1 pole - 1 x 2	
	Colour	Grey	
Max. electric values (U _{max} , I _{max})		500 V, 41 A	
Dimensions (mm)			
	Length	57.8	
	Height	47.5	
	Width	6.2	
Cabling c.s.a. (mm ²)		4	
	Flexible cable	0.14 - 6	
	Solid cable	0.14 - 6	
Nominal electric values			
	IEC/EN 60947-7-1	500 V, 32 A	
	UL	150 V, 30 A, 26 - 10 AWG	
	CSA	150 V, 30 A, 26 - 10 AWG	
Certifications		UL, CSA, GL, LR, DNV	
Terminal blocks			
		Sold in lots of	Unit reference
	Grey	50	NSYTRV43
	Blue	50	NSYTRV43BL
Accessories			
1	End stop	Clip-on, 5.2 mm	50 NSYTRAAB35
2	for 35 mm DIN rail	With screw, 9.5 mm	50 NSYTRAABV35
3	End plate,	Grey	50 NSYTRAC23
3	width 2.2 mm	Grey, partial plate	- -
4	Partition plate,	Grey	- -
4	width 2 mm		
5	Plug-in bridge	2-pole	50 NSYTRAL42
		Red	
		3-pole	50 NSYTRAL43
		4-pole	50 NSYTRAL44
		5-pole	50 NSYTRAL45
		10-pole	10 NSYTRAL410
	20-pole	10 NSYTRAL420	
6	Vertical bridge	1-pole	- -
8	Test plug	Metallic part, Ø 2.3 mm	10 NSYTRAATM1
		Insulating sleeve, red	10 NSYTRAATP1
9	Test adaptor	For plug-in bridge shaft	10 NSYTRAFT
10	Warning label	Yellow	10 NSYTRACS4
11	Marker tag holder	For ●AB35 end stop	100 NSYTRASB4
12	DIN rail 35 x 7.2 mm	Perforated, 2 m long	20 NSYSDR200BD
13	Marking accessories		
General data			
	Strip length (mm)	9	
	Screw thread	M3	
	Torque (Nm)	0.6 - 0.8	

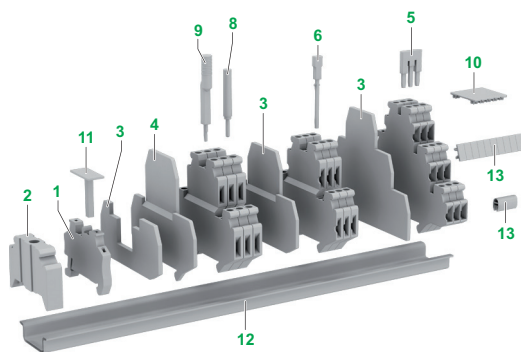

Linery TR

Screw terminal blocks

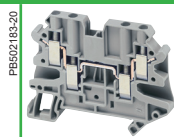

P6602183-20

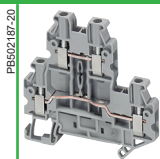

P6602187-20

NSYTRV44		NSYTRV24D	
4 mm ²		2.5 mm ²	
Passthrough - Multi-pole		Passthrough - Double deck	
1 pole - 2 x 2		2 pole - 1 x 1	
Grey		Grey	
500 V, 39 A		500 V, 28 A	
65.4		69.9	
47.5		65	
6.2		5.2	
4		2.5	
0.14 - 6		0.14 - 4	
0.14 - 6		0.14 - 4	
500 V, 32 A		500 V, 24 A	
150 V, 30 A, 26 - 10 AWG		600 V, 20 A, 26 - 12 AWG	
150 V, 30 A, 26 - 10 AWG		600 V, 20 A, 26 - 12 AWG	
UL, CSA, GL, LR, DNV		UL, CSA, GL, LR, DNV	
Sold in lots of	Unit reference	Sold in lots of	Unit reference
50	NSYTRV44	50	NSYTRV24D
50	NSYTRV44BL	50	NSYTRV24DBL
50	NSYTRAAB35	50	NSYTRAAB35
50	NSYTRAABV35	50	NSYTRAABV35
50	NSYTRAC24	50	NSYTRACE24
-	-	50	NSYTRACEP24
-	-	50	NSYTRAPE24
50	NSYTRAL42	50	NSYTRAL22
50	NSYTRAL43	50	NSYTRAL23
50	NSYTRAL44	50	NSYTRAL24
50	NSYTRAL45	50	NSYTRAL25
10	NSYTRAL410	10	NSYTRAL210
10	NSYTRAL420	10	NSYTRAL220
-	-	50	NSYTRALV24
10	NSYTRAATM1	10	NSYTRAATM1
10	NSYTRAATP1	10	NSYTRAATP1
10	NSYTRAFT	10	NSYTRAFT
10	NSYTRACS4	10	NSYTRACS2
100	NSYTRASB4	100	NSYTRASB4
20	NSYSDR200BD	20	NSYSDR200BD
9		9	
M3		M3	
0.6 - 0.8		0.5 - 0.6	



Linery TR

Screw terminal blocks

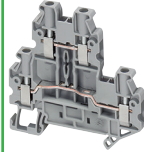
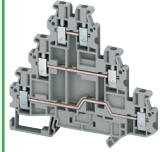
Screw terminal blocks - Double deck passthrough					
					
		NSYTRV44D		NSYTRV26T	
Nominal c.s.a.		4 mm ²		2.5 mm ²	
	Type of block	Passthrough - Double deck		Passthrough - Triple deck	
	Type of connection	2 pole - 1 x 1		3 pole - 1 x 1	
	Colour	Grey		Grey	
Max. electric values (U _{max} , I _{max})		800 V, 36 A		500 V, 24 A	
Dimensions (mm)					
	Length	69.9		90	
	Height	65		77.5	
	Width	6.2		5.2	
Cabling c.s.a. (mm ²)		4		2.5	
	Flexible cable	0.14 - 6		0.14 - 4	
	Solid cable	0.14 - 6		0.14 - 4	
Nominal electric values					
	IEC/EN 60947-7-1	800 V, 30 A		500 V, 20 A	
	UL	600 V, 30 A, 26 - 10 AWG		600 V, 20 A, 26 - 12 AWG	
	CSA	600 V, 30 A, 26 - 10 AWG		600 V, 20 A, 26 - 12 AWG	
Certifications		UL, CSA, GL, LR, DNV		UL, CSA	
Terminal blocks					
		Sold in lots of	Unit reference	Sold in lots of	Unit reference
	Grey	50	NSYTRV44D	50	NSYTRV26T
	Blue	50	NSYTRV44DBL	-	-
Accessories					
End stop for 35 mm DIN rail	Clip-on, 5.2 mm	50	NSYTRAAB35	50	NSYTRAAB35
	With screw, 9.5 mm	50	NSYTRAABV35	50	NSYTRAABV35
End plate, width 2.2 mm	Grey	50	NSYTRACE24	50	NSYTRACE26
	Grey, partial plate	50	NSYTRACEP24	-	-
Partition plate, width 2 mm	Grey	50	NSYTRAPE24	-	-
Plug-in bridge Red	2-pole	50	NSYTRAL42	50	NSYTRAL22
	3-pole	50	NSYTRAL43	50	NSYTRAL23
	4-pole	50	NSYTRAL44	50	NSYTRAL24
	5-pole	50	NSYTRAL45	50	NSYTRAL25
	10-pole	10	NSYTRAL410	10	NSYTRAL210
	20-pole	10	NSYTRAL420	10	NSYTRAL220
Vertical bridge	1-pole	50	NSYTRALV24	-	-
Test plug	Metallic part, Ø 2.3 mm	10	NSYTRAATM1	10	NSYTRAATM1
	Insulating sleeve, red	10	NSYTRAATP1	10	NSYTRAATP1
Test adaptor	For plug-in bridge shaft	10	NSYTRAFT	10	NSYTRAFT
Warning label	Yellow	10	NSYTRACS4	10	NSYTRACS2
Marker tag holder	For ●AB35 end stop	100	NSYTRASB4	100	NSYTRASB4
DIN rail 35 x 7.2 mm	Perforated, 2 m long	20	NSYSR200BD	20	NSYSR200BD
Marking accessories		See page 142			
General data					
	Strip length (mm)	9		9	
	Screw thread	M3		M3	
	Torque (Nm)	0.6 - 0.8		0.5 - 0.6	

* The 3 levels are connected.



Linery TR

Screw terminal blocks

Screw terminal blocks - Double deck protective earth

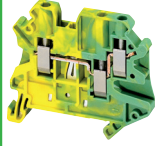
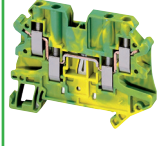
			
		NSYTRV43PE	NSYTRV44PE
Nominal c.s.a.		4 mm ²	4 mm ²
	Type of block	Protective earth - Multi-pole	Protective earth - Multi-pole
	Type of connection	1 pole - 1 x 2	1 pole - 2 x 2
	Colour	Green/Yellow	Green/Yellow
Max. electric values		-	-
Dimensions (mm)			
	Length	57.8	65.4
	Height	47.5	47.5
	Width	6.2	6.2
Cabling c.s.a. (mm ²)		4	4
	Flexible cable	0.14 - 6	0.14 - 6
	Solid cable	0.14 - 6	0.14 - 6
Nominal electric values			
	IEC/EN 60947-7-1	-	-
	UL	26 - 10 AWG	26 - 10 AWG
	CSA	26 - 10 AWG	26 - 10 AWG
Certifications		UL, CSA, GL, LR, DNV	UL, CSA, GL, LR, DNV
Terminal blocks			
	Green/Yellow	Sold in lots of 50	Unit reference NSYTRV43PE
			Sold in lots of 50
			Unit reference NSYTRV44PE
Accessories			
End stop for 35 mm DIN rail	Clip-on, 5.2 mm	50	NSYTRAAB35
	With screw, 9.5 mm	50	NSYTRAABV35
End plate, width 2.2 mm	Grey	50	NSYTRAC23
	Grey, partial plate	-	-
Partition plate, width 2 mm	Grey	-	-
Plug-in bridge Red	2-pole	50	NSYTRAL42
	3-pole	50	NSYTRAL43
	4-pole	50	NSYTRAL44
	5-pole	50	NSYTRAL45
	10-pole	10	NSYTRAL410
	20-pole	10	NSYTRAL420
Test plug	Metalic part, Ø 2.3 mm	10	NSYTRAATM1
	Insulating sleeve, red	10	NSYTRAATP1
Test adaptor	For plug-in bridge shaft	10	NSYTRAF1
Warning label	Yellow	100	NSYTRACS4
Marker tag holder	For ●AB35 end stop	20	NSYTRASB4
DIN rail 35 x 7.2 mm	Perforated, 2 m long	20	NSYSDR200BD
Marking accessories			
General data			
	Strip length (mm)	9	9
	Screw thread	M3	M3
	Torque (Nm)	0.6 - 0.8	0.6 - 0.8

Linery TR

Screw terminal blocks

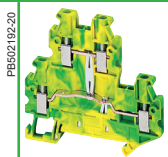

PB602102-20

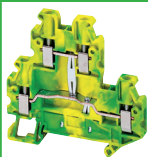

PB602101-20

NSYTRV24DPE	NSYTRV44DPE
2.5 mm²	4 mm²
Protective earth - Double deck	Protective earth - Double deck
1 pole - 2 x 2	1 pole - 2 x 2
Green/Yellow	Green/Yellow
-	-
69.9	69.9
65	65
5.2	6.2
2.5	4
0.14 - 4	0.14 - 6
0.14 - 4	0.14 - 6
-	-
26 - 12 AWG	26 - 10 AWG
26 - 12 AWG	26 - 10 AWG
UL, CSA, GL, LR, DNV	UL, CSA, GL, LR, DNV

Sold in lots of	Unit reference	Sold in lots of	Unit reference
50	NSYTRV24DPE	50	NSYTRV44DPE
50	NSYTRAAB35	50	NSYTRAAB35
50	NSYTRAABV35	50	NSYTRAABV35
50	NSYTRACE24	50	NSYTRACE24
50	NSYTRACEP24	50	NSYTRACEP24
50	NSYTRAPE24	50	NSYTRAPE24
50	NSYTRAL22	50	NSYTRAL42
50	NSYTRAL23	50	NSYTRAL43
50	NSYTRAL24	50	NSYTRAL44
50	NSYTRAL25	50	NSYTRAL45
10	NSYTRAL210	10	NSYTRAL410
10	NSYTRAL220	10	NSYTRAL420
10	NSYTRAATM1	10	NSYTRAATM1
10	NSYTRAATP1	10	NSYTRAATP1
10	NSYTRAFT	10	NSYTRAFT
100	NSYTRACS2	100	NSYTRACS4
20	NSYTRASB4	20	NSYTRASB4
20	NSYS DR200BD	20	NSYS DR200BD

9	9
M3	M3
0.5 - 0.6	0.6 - 0.8



Lineryg TR

Screw terminal blocks

Screw terminal blocks - Disconnect

P860296020

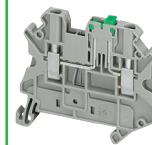

		NSYTRV22SC		
Nominal c.s.a.		2.5 mm ²		
	Type of block	Disconnect (blade)		
	Type of connection	1 pole - 1 x 1		
	Color	Grey		
Max. electric values (U _{max} , I _{max})		400 V, 20 A		
Dimensions (mm)				
	Length	57.8		
	Height	49.1		
	Width	5.2		
Cabling c.s.a. (mm ²)		2.5		
	Flexible cable	0.14 - 4		
	Solid cable	0.14 - 4		
Nominal electric values				
	IEC/EN 60947-7-1	400 V, 20 A		
	UL	300 V, 16 A, 26 - 12 AWG		
	CSA	300 V, 16 A, 26 - 12 AWG		
Certifications		UL, CSA		
Terminal blocks				
		Sold in lots of	Unit reference	
	Grey	50	NSYTRV22SC	
	Grey, with test points	50	NSYTRV22ST	
	Orange, with test points	-	-	
Accessories				
1	End stop	Clip-on, 5.2 mm	50	NSYTRAAB35
2	for 35 mm DIN rail	With screw, 9.5 mm	50	NSYTRAABV35
3	End plate, width 2.2 mm	Grey	50	NSYTRAC23
		Grey, partial plate	-	-
4	Partition plate, width 2 mm	Grey	-	-
5	Plug-in bridge	2-pole	50	NSYTRAL22
		3-pole	50	NSYTRAL23
		4-pole	50	NSYTRAL24
		5-pole	50	NSYTRAL25
		10-pole	10	NSYTRAL210
		20-pole	10	NSYTRAL220
14	Removable carrier width 6.1 mm 6 A max	For fuse 5 x 20 mm	-	-
		For fuse 5 x 20 mm 110 - 250 V LED	-	-
		For fuse 5 x 20 mm 12 - 30 V LED	-	-
15	Removable carrier width 5.1 mm 6 A max	For component	-	-
		With 1N4007 diode	-	-
8	Test plug	Metallic part, Ø 2.3 mm	10	NSYTRAATM1
		Insulating sleeve, red	10	NSYTRAATP1
9	Test adaptor	For plug-in bridge shaft	10	NSYTRAFT
10	Warning label	Yellow	10	NSYTRACS4
11	Marker tag holder	For ●AB35 end stop	100	NSYTRASB4
12	DIN rail 35 x 7.2 mm	Perforated, 2 m long	20	NSYSDR200BD
13	Marking accessories		See page 142	
General data				
	Strip length (mm)	9		
	Screw thread	M3		
	Torque (Nm)	0.5 - 0.6		

* Disconnect knife on each level.

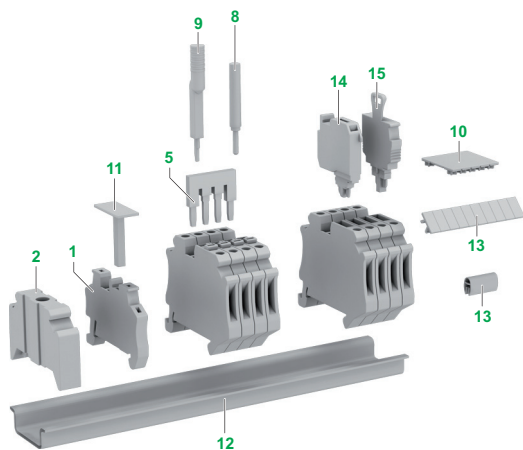

Linery TR

Screw terminal blocks

PB502181-20		PB502179-20		PB502178-20		PB502193-20	
NSYTRV22TB		NSYTRV42SC		NSYTRV42TB		NSYTRV42SCD	
2.5 mm ²		4 mm ²		4 mm ²		4 mm ²	
Disconnect (for carrier)		Disconnect (blade)		Disconnect (for carrier)		Disconnect - Double deck	
1 pole - 1 x 1		1 pole - 1 x 1		1 pole - 1 x 1		2 pole - 1 x 1	
Grey		Grey		Grey		Grey	
400 V, 20 A		500 V, 20 A		400 V, 20 A		500 V, 38 A	
57.8		57.8		57.8		69.9	
47.5		49.1		47.5		65	
5.2		6.2		6.2		6.2	
2.5		4		4		4	
0.14 - 4		0.14 - 6		0.14 - 6		0.14 - 6	
0.14 - 4		0.14 - 6		0.14 - 6		0.14 - 6	
400 V, 20 A		500 V, 20 A		500 V, 20 A		500 V, 30 A	
600 V, 16 A, 26 - 12 AWG		600 V, 16 A, 26 - 10 AWG		600 V, 16 A, 26 - 10 AWG		300 V, 30 A, 26 - 10 AWG	
600 V, 16 A, 26 - 12 AWG		600 V, 16 A, 26 - 10 AWG		600 V, 16 A, 26 - 10 AWG		300 V, 30 A, 26 - 10 AWG	
UL, CSA		UL, CSA		UL, CSA		UL, CSA	
Sold in lots of	Unit reference	Sold in lots of	Unit reference	Sold in lots of	Unit reference	Sold in lots of	Unit reference
50	NSYTRV22TB	50	NSYTRV42SC	50	NSYTRV42TB	50	NSYTRV42SCD
-	-	-	-	-	-	-	-
-	-	50	NSYTRV42STAR	-	-	-	-
50	NSYTRAAB35	50	NSYTRAAB35	50	NSYTRAAB35	50	NSYTRAAB35
50	NSYTRAABV35	50	NSYTRAABV35	50	NSYTRAABV35	50	NSYTRAABV35
50	NSYTRAC23	-	Included	-	Included	50	NSYTRACE24
-	-	-	-	-	-	50	NSYTRACEP24
-	-	-	-	-	-	50	NSYTRAPE24
50	NSYTRAL22	50	NSYTRAL42	50	NSYTRAL42	50	NSYTRAL42
50	NSYTRAL23	50	NSYTRAL43	50	NSYTRAL43	50	NSYTRAL43
50	NSYTRAL24	50	NSYTRAL44	50	NSYTRAL44	50	NSYTRAL44
50	NSYTRAL25	50	NSYTRAL45	50	NSYTRAL45	50	NSYTRAL45
10	NSYTRAL210	10	NSYTRAL410	10	NSYTRAL410	10	NSYTRAL410
10	NSYTRAL220	10	NSYTRAL420	10	NSYTRAL420	10	NSYTRAL420
10	NSYTRASF520	-	-	10	NSYTRASF520	-	-
10	NSYTRASF520M	-	-	10	NSYTRASF520M	-	-
10	NSYTRASF520B	-	-	10	NSYTRASF520B	-	-
10	NSYTRASV1	-	-	10	NSYTRASV1	-	-
10	NSYTRASV2	-	-	10	NSYTRASV2	-	-
10	NSYTRAATM1	10	NSYTRAATM1	10	NSYTRAATM1	10	NSYTRAATM1
10	NSYTRAATP1	10	NSYTRAATP1	10	NSYTRAATP1	10	NSYTRAATP1
10	NSYTRAFT	10	NSYTRAFT	10	NSYTRAFT	10	NSYTRAFT
10	NSYTRACS4	10	NSYTRACS4	10	NSYTRACS4	10	NSYTRACS4
100	NSYTRASB4	100	NSYTRASB4	100	NSYTRASB4	100	NSYTRASB4
20	NSYSDR200BD	20	NSYSDR200BD	20	NSYSDR200BD	20	NSYSDR200BD
9		9		9		9	
M3		M3		M3		M3	
0.5 - 0.6		0.6 - 0.8		0.6 - 0.8		0.6 - 0.8	





Linergy TR Screw terminal blocks

Screw terminal blocks - Measuring terminals

PB50208SE-35

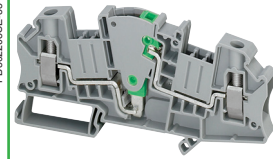

		NSYTRV62TTD
Nominal c.s.a.	Type of block	Knife disconnect
	Type of connection	1 pole - 1 x 1
	Colour	Grey
	Max. electric values (U _{max} , I _{max})	500 V, 30 A
Dimensions (mm)		
	Length	100.8
	Height	49.6
	Width	8.2
Cabling c.s.a. (mm ²)		6
	Flexible cable	0.2 - 10
	Solid cable	0.2 - 10
Nominal electric values		
	IEC/EN 60947-7-1	500 V, 30 A
	UL	600 V, 30 A. 24 - 8 AWG
	CSA	600 V, 30 A. 24 - 8 AWG
Certifications		UL, CSA

Terminal blocks

		Sold in lots of	Unit reference
	Grey	50	NSYTRV62TTD
	Green/Yellow	-	-

Accessories

1 End stop	Clip-on, 5.2 mm	50	NSYTRAAB35
2 for 35 mm DIN rail	With screw, 9.5 mm	50	NSYTRAABV35
3 End plate, width 2.2 mm	Grey	50	NSYTRACT22
14 Switching jumper, pluggable	2 points	10	NSYTRASJ2
	4 points	10	NSYTRASJ4
	Plug-in bridge		
5 Plug-in bridge	Red		
	2-pole	10	NSYTRAL62
	3-pole	10	NSYTRAL63
15 Switching lock	10-pole	10	NSYTRAL610
	Pluggable	10	NSYTRASJ6
	8 Test plug	Metallic part, Ø 2.3 mm	10
Insulating sleeve, red		10	NSYTRAATP1
9 Test plug adaptor	Grey	10	NSYTRAFT
	For plug-in bridge shaft		
	Yellow	10	NSYTRAFTYE
11 Marker tag holder	Green	10	NSYTRAFTGN
	For ●AB35 end stop	100	NSYTRASB4
	12 DIN rail 35 x 7.2 mm	Perforated, 2 m long	20
13 Marking accessories		See page 142	

General data

Strip length (mm)	10
Screw thread	M4
Torque (Nm)	1.5 - 1.8

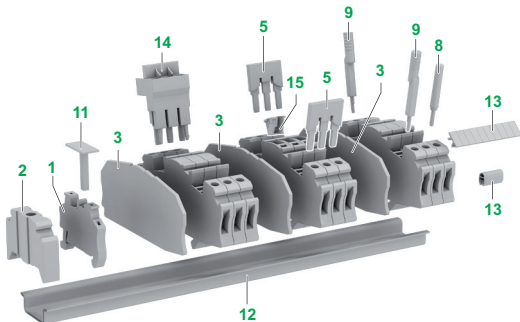

PB50208SE-35

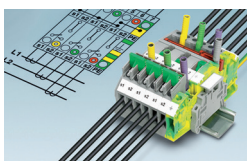

Only two **NSYTRV62TTD** measuring transducer disconnect terminal blocks are required for a current transformer measuring circuit. This means that less space is required compared to a circuit design using slide-type terminal blocks.

PB50208SE-32

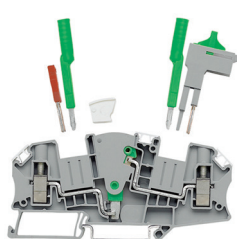

The new **NSYTRV62TT** measuring transducer disconnect terminal blocks with screw connection technology are characterised by easy operation and clarity. All switching statuses are instantly clearly visible. Due to the extensive range of flexible accessories, costs and time are saved when executing all transducer test circuit tasks.

Linery TR

Screw terminal blocks

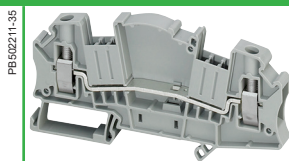

NSYTRV62TT

6 mm²
Passthrough
1 pole - 1 x 1
Grey
500 V, 30 A

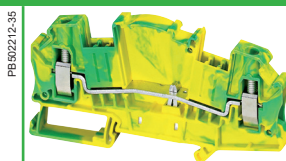

NSYTRV62TTPE

6 mm²
Protective earth
1 pole - 1 x 1
Green/Yellow
-

100.8
49.6
8.2
6
0.2 - 10
0.2 - 10

100.8
49.6
8.2
6
0.2 - 10
0.2 - 10

500 V, 30 A
600 V, 30 A, 24 - 8 AWG
600 V, 30 A, 24 - 8 AWG
UL, CSA

-
24 - 8 AWG
24 - 8 AWG
UL, CSA

Sold in lots of

50
-

Unit reference

NSYTRV62TT

-

Sold in lots of

-
50

Unit reference

-
NSYTRV62TTPE

50
50
50
10
10
10
10
10
10
10
10
10
10
10
10
100
20
NSYTRAAB35
NSYTRAABV35
NSYTRACT22
NSYTRASJ2
NSYTRASJ4
NSYTRAL62
NSYTRAL63
NSYTRAL610
NSYTRASJ6
NSYTRAATM1
NSYTRAATP1
NSYTRAFT
NSYTRAFTYE
NSYTRAFTGN
NSYTRASB4
NSYSDR200BD

50
50
50
-
-
10
10
10
10
-
10
10
10
10
10
10
10
10
20
NSYTRAAB35
NSYTRAABV35
NSYTRACT22
-
-
NSYTRAL62
NSYTRAL63
NSYTRAL610
-
NSYTRAATM1
NSYTRAATP1
NSYTRAFT
NSYTRAFTYE
NSYTRAFTGN
NSYTRASB4
NSYSDR200BD

10
M4
1.5 - 1.8

10
M4
1.5 - 1.8

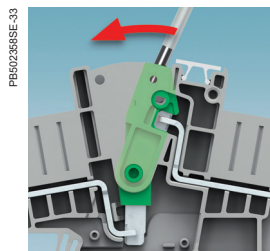

The longitudinal isolating switch contacts snap safely into their respective switching state. Imprinted switching symbols ensure clarity. The optional switching lock snaps in and effectively prevents accidental switching. For simultaneous actuation, two switches can be connected to each other using a connection bridge.

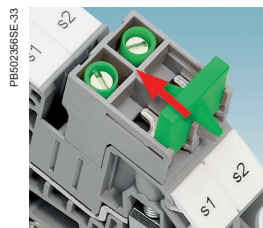

The NSYTRASJ switch jumpers can be placed on both sides of the disconnect point in the bridge shaft and can be securely snapped in irrespective of the terminal strip configuration. The bridge for the transformer short-circuit can be securely engaged in the end positions and screw terminal points are used to make contact.

Lineryg TR

Screw terminal blocks

Screw terminal blocks - Neutral disconnect

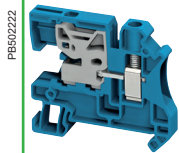

		NSYTRV62NE	
Nominal c.s.a.		6 (10) mm ²	
	Type of block	Neutral disconnect	
	Type of connection	1 pole - 1 x 1	
	Colour	Blue	
Max. electric values (U _{max} , I _{max})		400 V, 41 A	
Dimensions (mm)			
	Length	55	
	Height	47,5	
	Width	8.2	
Cabling c.s.a. (mm ²)		6	
	Flexible cable	0.2 - 10	
	Solid cable	0.2 - 10	
Nominal electric values			
	IEC/EN 60947-7-1	400 V, 41 A	
	UL	-	
	CSA	-	
Certifications		-	
Terminal blocks			
	Blue	Sold in lots of	Unit reference
		50	NSYTRV62NE
Accessories			
End stop for 35 mm DIN rail	Clip-on, 5.2 mm	50	NSYTRAAB35
	With screw, 9.5 mm	50	NSYTRAABV35
End plate, width 2.2 mm	Grey	50	NSYTRAC22
	Blue	50	NSYTRAC22BL
Partition plate, width 2 mm	Grey	50	NSYTRAP22
Plug-in bridge Red	2-pole	10	NSYTRAL62
	3-pole	10	NSYTRAL63
	10-pole	10	NSYTRAL610
Terminal clamp for neutral bar		25	
Test plug	Metallic part, Ø 2.3 mm	10	NSYTRAATM1
	Insulating sleeve, red	10	NSYTRAATP1
Test adaptor	For plug-in bridge shaft	10	NSYTRAFT
Marker tag holder	For ●AB35 end stop	100	NSYTRASB4
DIN rail 35 x 7.2 mm	Perforated, 2 m long	20	NSYSDR200BD
Marking accessories			
General data			
	Strip length (mm)	10	
	Screw thread	M4	
	Torque (Nm)	1.5 - 1.8	

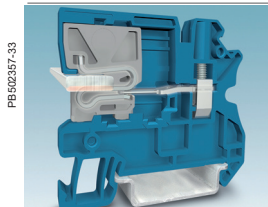

All **NSYTRV●●NE** disconnect terminal blocks have a screwless disconnect slide. When this is levered over with a standard screwdriver, the contact fork slides onto the busbar. The slide engages in the end positions to provide additional protection against accidental actuation. The shape of the **NSYTRV●●NE** disconnect terminal blocks is the same as for the screw terminal blocks **NSYTRV**.

Lineryy TR

Screw terminal blocks

Screw terminal blocks - Miniature passthrough

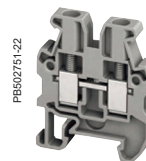

		NSYTRV22M			
Nominal c.s.a.		2.5 mm ²			
	Type of block	Passthrough			
	Type of connection	1 pole - 1 x 1			
	Colour	Grey			
Max. electric values (U _{max} , I _{max})		500 V, 24 A			
Dimensions (mm)					
	Length	30			
	Height	34			
	Width	5.2			
Mounting on		NS15 DIN rail			
Cabling c.s.a. (mm ²)		2.5			
	Flexible cable	0.2 - 2.5			
	Solid cable	0.2 - 4			
Nominal electric values					
	IEC/EN 60947-7-1	500 V, 24 A			
	UL	600 V, 20 A, 24 - 12 AWG			
	CSA	600 V, 20 A, 24 - 12 AWG			
Certifications		UL, CSA, VDE			
Terminal blocks					
	Grey	Sold in lots of 50	Unit reference NSYTRV22M		
	Blue	50	NSYTRV22MBL		
Accessories					
1	End stop for 15 mm DIN rail	Clip-on, 5.2 mm	50	NSYTRAAB15	
3	End plate	Grey	50	NSYTRACM22	
5	Plug-in bridge	Red	2-pole	50	NSYTRAL22
		3-pole	50	NSYTRAL23	
		4-pole	50	NSYTRAL24	
		5-pole	50	NSYTRAL25	
		10-pole	10	NSYTRAL210	
		20-pole	10	NSYTRAL220	
	Blue	10-pole	10	NSYTRAL210BL	
	Grey	10-pole	10	NSYTRAL210GR	
11	Marker tag holder	For ●AB15 end stop	100	NSYTRASB4	
13	Marking accessories		See page 142		
General data					
	Strip length (mm)		9		
	Screw thread		M3		
	Torque (Nm)		0.5 - 0.6		

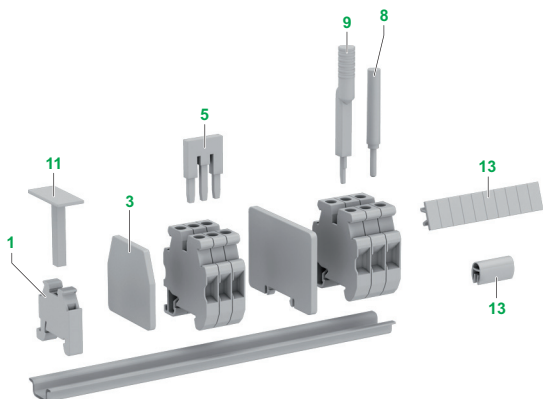

Linery TR

Screw terminal blocks

Screw terminal blocks - Miniature protective earth

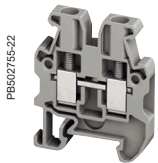

NSYTRV42M
4 mm²
Passthrough
1 pole - 1 x 1
Grey
500 V, 32 A

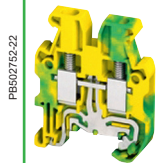

NSYTRV22MPE
2.5 mm²
Protective earth
1 pole - 1 x 1
Green/Yellow
-

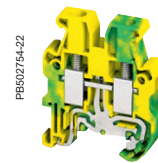

NSYTRV42MPE
4 mm²
Protective earth
1 pole - 1 x 1
Green/Yellow
-

30	30	30
34	34	34
6.2	5.2	6.2
NS15 DIN rail	NS15 DIN rail	NS15 DIN rail
4	2.5	4
0.2 - 4	0.2 - 2.5	0.2 - 4
0.2 - 6	0.2 - 4	0.2 - 6
500 V, 32 A	-	-
600 V, 30 A, 24 - 10 AWG	24 - 12 AWG	24 - 10 AWG
600 V, 30 A, 24 - 10 AWG	24 - 12 AWG	24 - 10 AWG
UL, CSA, VDE	UL, CSA, VDE	UL, CSA, VDE

Sold in lots of	Unit reference	Sold in lots of	Unit reference	Sold in lots of	Unit reference
50	NSYTRV42M	50	NSYTRV22MPE	50	NSYTRV42MPE
50	NSYTRV42MBL	-	-	-	-





50	NSYTRAAB15	50	NSYTRAAB15	50	NSYTRAAB15
50	NSYTRACM22	50	NSYTRACM22	50	NSYTRACM22
50	NSYTRAL42	-	-	-	-
50	NSYTRAL43	-	-	-	-
50	NSYTRAL44	-	-	-	-
50	NSYTRAL45	-	-	-	-
10	NSYTRAL410	-	-	-	-
10	NSYTRAL420	-	-	-	-
10	NSYTRAL410BL	-	-	-	-
10	NSYTRAL410GR	-	-	-	-
100	NSYTRASB4	100	NSYTRASB4	100	NSYTRASB4

8	9	8
M3	M3	M3
0.6 - 0.8	0.5 - 0.6	0.6 - 0.8

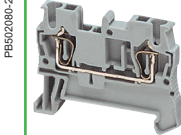
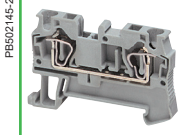
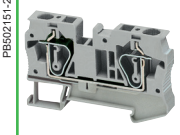
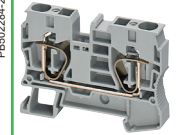

Linergy TR

Selection guide: spring terminal blocks

		Passthrough			
		Passthrough			
					
Nominal c.s.a (mm ²)		2.5	4	6	10, 16 & 35
Number of poles	1 - 1 x 1	NSYTRR22	NSYTRR42	NSYTRR62	NSYTRR102 NSYTRR162
	1 - 1 x 2	NSYTRR23	NSYTRR43	NSYTRR63	-
	1 - 2 x 2	NSYTRR24	NSYTRR44	-	-
Colours	Grey	■	■	■	■
	Blue	NSYTRR22BL NSYTRR23BL NSYTRR24BL	NSYTRR42BL - -	NSYTRR62BL	NSYTRR102BL NSYTRR162BL -
	Green/yellow (PE)	-	-	-	-
	Mounting on				
Mounting on	35 mm 	■	■	■	■
	35 mm 	■	■	■	■
	Telequick	-	-	-	-
	15 mm 	-	-	-	-
See pages		106/107	107/108	108/109	109

PBE02284-70

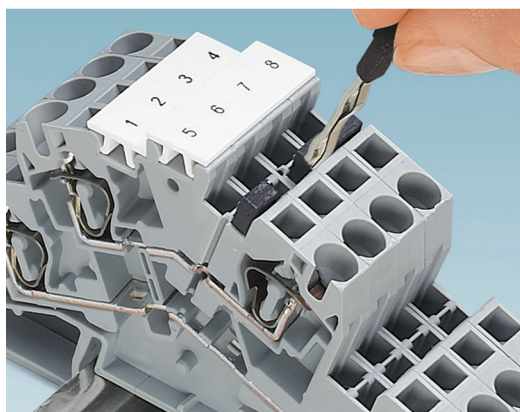





Vertical bridge

The **NSYTRALV24R** vertical bridge offers the option of connecting both levels of the standard double-level **NSYTRR24D** and **NSYTRR44D** terminal blocks.

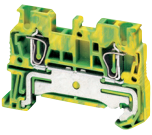

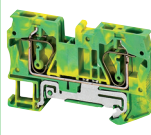

Linery TR

Selection guide: spring terminal blocks

Protective earth				
PB602138-20 	PB602146-20 	PB602152-20 	PB602285-20 	
2.5	4	6	10, 16 & 35	
NSYTRR22PE	NSYTRR42PE	NSYTRR62PE	NSYTRR102PE NSYTRR162PE	
NSYTRR23PE	-	-	-	
NSYTRR24PE	NSYTRR44PE	-	-	
-	-	-	-	
-	-	-	-	
■	■	■	■	
■	■	■	■	
■	■	■	■	
-	-	-	-	
-	-	-	-	
110	111	111	112	

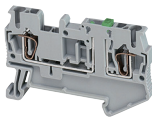
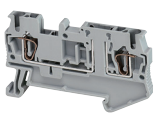
Linergy TR

Selection guide: spring terminal blocks

		Double deck		Disconnect	
		Passthrough		Blade	
		Removable carrier			
					
Nominal c.s.a (mm ²)		2.5 & 4		2.5 & 4	
Number of poles	1 - 1 x 1	-		NSYTRR22SC	
	1 - 1 x 2	-		NSYTRR23SC	
	2 - 1 x 1	NSYTRR24D NSYTRR44D		-	
	3 - 1 x 1	NSYTRR26T		-	
Colours	Grey	■		■	
	Blue	-		-	
	Green/yellow (PE)	NSYTRR44DBL -		-	
		NSYTRR24DPE NSYTRR44DPE -		-	
Mounting on	35 mm 	■		■	
	35 mm 	■		■	
	Telequick	-		-	
	15 mm 	-		-	
See pages	114/115/116		118/119/120		119/120

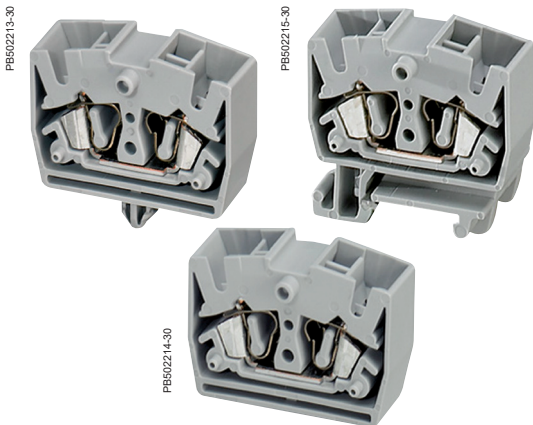



Miniature terminal blocks with maximum usage

Due to its space saving design, mini spring-cage terminal blocks are ideal for wiring in extremely restricted spaces. The generous connection space enables fast wiring of both stranded and solid conductors. They can be mounted on NS 15 DIN rail or directly mounted using screw flange or engagement pins.

Linery TR

Selection guide: spring terminal blocks

Miniature	
Direct mounting	Pin mounting
 <small>PB60216-20</small>	 <small>PB60217-20</small>
2.5	2.5
-	-
-	-
-	-
-	-
■	■
-	-
NSYTRR24MFBL	-
-	-
-	-
-	-
-	-
-	-
124/125	125

Linergy TR

Spring terminal blocks

Spring terminal blocks - Passthrough

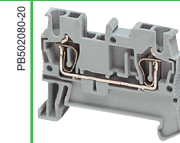

		NSYTRR22	
Nominal c.s.a.		2.5 mm ²	
	Type of block	Passthrough	
	Type of connection	1 pole - 1 x 1	
	Colour	Grey	
Max. electric values (U _{max} , I _{max})		800 V, 31 A	
Dimensions (mm)			
	Length	48.5	
	Height	36.5	
	Width	5.2	
Cabling c.s.a. (mm ²)		2.5	
	Flexible cable	0.08 - 2.5	
	Solid cable	0.08 - 4	
Nominal electric values			
	IEC/EN 60947-7-1	800 V, 24 A	
	UL	600 V, 20 A, 28 - 12 AWG	
	CSA	600 V, 20 A, 28 - 12 AWG	
Certifications		UL, CSA, VDE, GL, LR, DNV	
Terminal blocks			
		Sold in lots of	Unit reference
	Grey	50	NSYTRR22
	Blue	50	NSYTRR22BL
Accessories			
1	End stop	Clip-on, 5.2 mm	50 NSYTRAAB35
2	for 35 mm DIN rail	With screw, 9.5 mm	50 NSYTRAABV35
3	End plate, width 2.2 mm	Grey	50 NSYTRACR22
4	Partition plate, width 2 mm	Grey	50 NSYTRAPR42
5	Plug-in bridge	2-pole	50 NSYTRAL22
		3-pole	50 NSYTRAL23
		4-pole	50 NSYTRAL24
		5-pole	50 NSYTRAL25
		10-pole	10 NSYTRAL210
		20-pole	10 NSYTRAL220
	Blue	10-pole	10 NSYTRAL210BL
		Grey	10 NSYTRAL210GR
8	Test plug	Metallic part, Ø 2.3 mm	10 NSYTRAATM1
		Insulating sleeve, red	10 NSYTRAATP1
9	Test adaptor	For plug-in bridge shaft	10 NSYTRAFT
10	Warning label	Yellow	10 NSYTRACSR2
11	Marker tag holder	For ●AB35 end stop	100 NSYTRASB4
12	DIN rail 35 x 7.2 mm	Perforated, 2 m long	20 NSYSDR200BD
13	Marking accessories		See page 142
General data			
	Strip length (mm)	10	

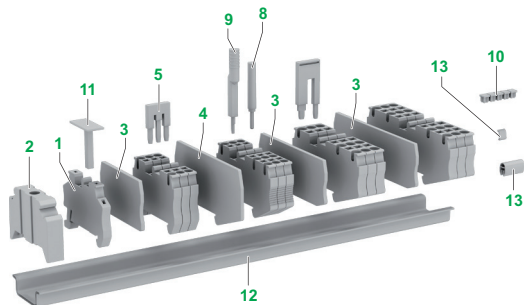

Linery TR

Spring terminal blocks

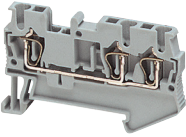
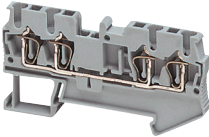
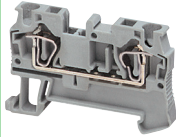
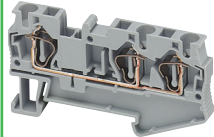
 <small>PB602141-25</small>		 <small>PB602143-28</small>		 <small>PB602145-23</small>		 <small>PB602147-28</small>	
NSYTRR23		NSYTRR24		NSYTRR42		NSYTRR43	
2.5 mm ²		2.5 mm ²		4 mm ²		4 mm ²	
Passthrough		Passthrough		Passthrough		Passthrough	
1 pole - 1 x 2		1 pole - 2 x 2		1 pole - 1 x 1		1 pole - 1 x 2	
Grey		Grey		Grey		Grey	
800 V, 28 A		800 V, 28 A		800 V, 40 A		800 V, 40 A	
60.5		72		56		71.5	
36.5		36.5		36.5		36.5	
5.2		5.2		6.2		6.2	
2.5		2.5		4		4	
0.08 - 2.5		0.08 - 2.5		0.08 - 4		0.08 - 4	
0.08 - 4		0.08 - 4		0.08 - 6		0.08 - 6	
800 V, 24 A		800 V, 24 A		800 V, 32 A		800 V, 32 A	
600 V, 20 A, 28 - 12 AWG		600 V, 20 A, 28 - 12 AWG		600 V, 30 A, 28 - 10 AWG		600 V, 30 A, 28 - 10 AWG	
600 V, 20 A, 28 - 12 AWG		600 V, 20 A, 28 - 12 AWG		600 V, 30 A, 28 - 10 AWG		600 V, 30 A, 28 - 10 AWG	
UL, CSA, VDE, GL, LR, DNV		UL, CSA, VDE, GL, LR, DNV		UL, CSA, VDE, GL, LR; DNV		UL, CSA, VDE, GL, LR, DNV	
Sold in lots of	Unit reference	Sold in lots of	Unit reference	Sold in lots of	Unit reference	Sold in lots of	Unit reference
50	NSYTRR23	50	NSYTRR24	50	NSYTRR42	50	NSYTRR43
50	NSYTRR23BL	50	NSYTRR24BL	50	NSYTRR42BL	50	-
50	NSYTRAAB35	50	NSYTRAAB35	50	NSYTRAAB35	50	NSYTRAAB35
50	NSYTRAABV35	50	NSYTRAABV35	50	NSYTRAABV35	50	NSYTRAABV35
50	NSYTRACR23	50	NSYTRACR24	50	NSYTRACR42	50	NSYTRACR43
-	-	50	NSYTRAPR24	50	NSYTRAPR42	-	-
50	NSYTRAL22	50	NSYTRAL22	50	NSYTRAL42	50	NSYTRAL42
50	NSYTRAL23	50	NSYTRAL23	50	NSYTRAL43	50	NSYTRAL43
50	NSYTRAL24	50	NSYTRAL24	50	NSYTRAL44	50	NSYTRAL44
50	NSYTRAL25	50	NSYTRAL25	50	NSYTRAL45	50	NSYTRAL45
10	NSYTRAL210	10	NSYTRAL210	10	NSYTRAL410	10	NSYTRAL410
10	NSYTRAL220	10	NSYTRAL220	10	NSYTRAL420	10	NSYTRAL420
10	NSYTRAL210BL	10	NSYTRAL210BL	10	NSYTRAL410BL	10	NSYTRAL410BL
10	NSYTRAL210GR	10	NSYTRAL210GR	10	NSYTRAL410GR	10	NSYTRAL410GR
10	NSYTRAATM1	10	NSYTRAATM1	10	NSYTRAATM1	10	NSYTRAATM1
10	NSYTRAATP1	10	NSYTRAATP1	10	NSYTRAATP1	10	NSYTRAATP1
10	NSYTRAFT	10	NSYTRAFT	10	NSYTRAFT	10	NSYTRAFT
10	NSYTRACSR2	10	NSYTRACSR2	10	-	10	-
100	NSYTRASB4	100	NSYTRASB4	100	NSYTRASB4	100	NSYTRASB4
20	NSYSR200BD	20	NSYSR200BD	20	NSYSR200BD	20	NSYSR200BD
10		10		10		10	



Linery TR

Spring terminal blocks

Spring terminal blocks - Passthrough

PB602146-33

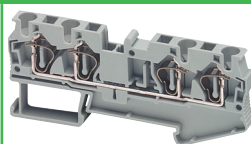

PB602151-28

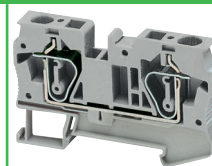

		NSYTRR44		NSYTRR62
Nominal c.s.a.		4 mm ²		6 mm ²
	Type of block	Passthrough		Passthrough
	Type of connection	1 pole - 2 x 2		1 pole - 1 x 1
	Colour	Grey		Grey
Max. electric values (U _{max} , I _{max})		800 V, 40 A		1000 V, 52 A
Dimensions (mm)				
	Length	87		69.5
	Height	36.5		43.5
	Width	6.2		8.2
Cabling c.s.a. (mm ²)		4		6
	Flexible cable	0.08 - 4		0.5 - 6
	Solid cable	0.08 - 6		0.2 - 10
Nominal electric values				
	IEC/EN 60947-7-1	800 V, 32 A		800 V, 41 A
	UL	600 V, 30 A, 28 -10 AWG		600 V, 50 A, 24 - 8 AWG
	CSA	600 V, 30 A, 28 -10 AWG		600 V, 50 A, 24 - 8 AWG
Certifications		UL, CSA, VDE, GL, LR, DNV		UL, CSA, VDE, GL, LR, DNV
Terminal blocks				
		Sold in lots of	Unit reference	Sold in lots of
				Unit reference
	Grey	50	NSYTRR44	50
	Blue			50
				NSYTRR62BL
Accessories				
End stop	Clip-on, 5.2 mm	50	NSYTRAAB35	50
for 35 mm DIN rail	With screw, 9.5 mm	50	NSYTRAABV35	50
End plate, width 2.2 mm	Grey	50	NSYTRACR44	50
Plug-in bridge	2-pole	50	NSYTRAL42	10
Red	3-pole	50	NSYTRAL43	10
	4-pole	50	NSYTRAL44	-
	5-pole	50	NSYTRAL45	-
	10-pole	10	NSYTRAL410	10
	20-pole	10	NSYTRAL420	-
Blue	10-pole	10	NSYTRAL410BL	-
Grey	10-pole	10	NSYTRAL410GR	-
Step-down bridge, down to 2.5/4 mm ²	Spring to spring terminal	-	-	10
				NSYTRALR62
Test plug	Metallic part, Ø 2.3 mm	10	NSYTRAATM1	10
	Insulating sleeve, red	10	NSYTRAATP1	10
Test adaptor	For plug-in bridge shaft	10	NSYTRAFT	10
Marker tag holder	For ●AB35 end stop	100	NSYTRASB4	100
DIN rail 35 x 7.2 mm	Perforated, 2 m long	20	NSYSDR200BD	20
Marking accessories		See page 142		
General data				
	Strip length (mm)	10		12

Linery TR

Spring terminal blocks

PB502161-34

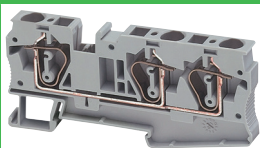

PB502284-28

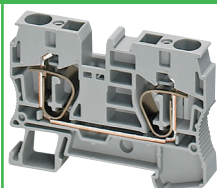

PB502157-30

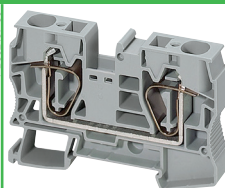

NSYTRR63	NSYTRR102	NSYTRR162
6 mm ²	10 mm ²	16 mm ²
Passthrough	Passthrough	Passthrough
1 pole - 1 x 2	1 pole - 1 x 1	1 pole - 1 x 1
Grey	Grey	Grey
1000 V, 52 A	1000 V, 65 A	1000 V, 90 A
90.5	71.5	80
43.5	50.5	51
8.2	10.2	12.2
6	10	16
0.5 - 6	0.2 - 10	0.2 - 16
0.2 - 10	0.2 - 16	0.2 - 25
800 V, 41 A	800 V, 57 A	800 V, 76 A
600 V, 50 A, 24 - 8 AWG	600 V, 65 A, 16 - 6 AWG	600 V, 85 A, 16 - 4 AWG
600 V, 50 A, 24 - 8 AWG	600 V, 65 A, 16 - 6 AWG	600 V, 85 A, 16 - 4 AWG
UL, CSA, VDE, GL, LR, DNV	UL, CSA, VDE, GL, LR, DNV	UL, CSA, VDE, GL, LR, DNV

Sold in lots of	Unit reference	Sold in lots of	Unit reference	Sold in lots of	Unit reference
50	NSYTRR63	50	NSYTRR102	50	NSYTRR162
-	-	50	NSYTRR102BL	50	NSYTRR162BL
50	NSYTRAAB35	50	NSYTRAAB35	50	NSYTRAAB35
50	NSYTRAABV35	50	NSYTRAABV35	50	NSYTRAABV35
50	NSYTRACR63	50	NSYTRACR102	50	NSYTRACR162
10	NSYTRAL62	10	NSYTRAL102	10	NSYTRAL162
10	NSYTRAL63	-	-	-	-
-	-	-	-	-	-
-	-	-	-	-	-
10	NSYTRAL610	-	-	-	-
-	-	-	-	-	-
-	-	-	-	-	-
-	-	-	-	-	-
10	NSYTRALR62	10	NSYTRALR102	10	-
10	NSYTRAATM1	10	NSYTRAATM1	-	-
10	NSYTRAATP1	10	NSYTRAATP1	-	-
10	NSYTRAFT	10	NSYTRAFT	-	-
100	NSYTRASB4	100	NSYTRASB4	100	NSYTRASB4
20	NSYSDR200BD	20	NSYSDR200BD	20	NSYSDR200BD

12	18	18
----	----	----



Linery TR

Spring terminal blocks

Spring terminal blocks - Protective earth

		 PB602139-20	 PB602142-25	 PB602144-28			
Nominal c.s.a.		NSYTRR22PE	NSYTRR23PE	NSYTRR24PE			
		2.5 mm ²	2.5 mm ²	2.5 mm ²			
	Type of block	Protective earth	Protective earth	Protective earth			
	Type of connection	1 pole - 1 x 1	1 pole - 1 x 2	1 pole - 2 x 2			
Max. electric values	Colour	Green/Yellow	Green/Yellow	Green/Yellow			
		-	-	-			
Dimensions (mm)							
	Length	48.5	60.5	72			
	Height	36.5	36.5	36.5			
	Width	5.2	5.2	5.2			
Cabling c.s.a. (mm ²)		2.5	2.5	2.5			
	Flexible cable	0.08 - 2.5	0.08 - 2.5	0.08 - 2.5			
	Solid cable	0.08 - 4	0.08 - 4	0.08 - 4			
Nominal electric values							
	IEC/EN 60947-7-1	-	-	-			
	UL	28 - 12 AWG	28 - 12 AWG	28 - 12 AWG			
	CSA	28 - 12 AWG	28 - 12 AWG	28 - 12 AWG			
Certifications		UL, CSA, VDE, GL, LR, DNV	UL, CSA, VDE, GL, LR, DNV	UL, CSA, VDE, GL, LR, DNV			
Terminal blocks							
	Green/Yellow	Sold in lots of 50	Unit reference NSYTRR22PE	Sold in lots of 50	Unit reference NSYTRR23PE	Sold in lots of 50	Unit reference NSYTRR24PE
Accessories							
End stop for 35mm DIN rail	Clip-on, 5.2 mm	50	NSYTRAAB35	50	NSYTRAAB35	50	NSYTRAAB35
	With screw, 9.5 mm	50	NSYTRAABV35	50	NSYTRAABV35	50	NSYTRAABV35
End plate, width 2.2 mm	Grey	50	NSYTRACR22	50	NSYTRACR23	50	NSYTRACR24
Partition plate, width 2 mm	Grey	50	NSYTRAPR42			50	NSYTRAPR24
Plug-in bridge Red	2-pole	-	-	-	-	-	-
	3-pole	-	-	-	-	-	-
	10-pole	-	-	-	-	-	-
Test plug	Metallic part, Ø 2.3 mm	10	NSYTRAATM1	10	NSYTRAATM1	10	NSYTRAATM1
	Insulating sleeve, red	10	NSYTRAATP1	10	NSYTRAATP1	10	NSYTRAATP1
Test adaptor	For plug-in bridge shaft	10	NSYTRAFT	10	NSYTRAFT	10	NSYTRAFT
Warning label	Yellow	10	NSYTRACSR2	10	NSYTRACSR2	10	NSYTRACSR2
Marker tag holder	For ●AB35 end stop	100	NSYTRASB4	100	NSYTRASB4	100	NSYTRASB4
DIN rail 35 x 7.2 mm	Perforated, 2 m long	20	NSYSDR200BD	20	NSYSDR200BD	20	NSYSDR200BD
Marking accessories		See page 142					
General data							
	Strip length (mm)	10		10		10	

Linergy TR

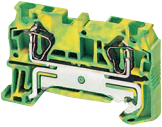
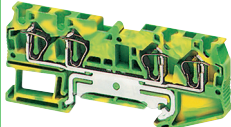
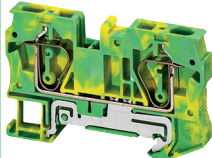

Spring terminal blocks

PB502146-23		PB502150-33		PB502152-34	
					
NSYTTR42PE		NSYTTR44PE		NSYTTR62PE	
4 mm ²		4 mm ²		6 mm ²	
Protective earth		Protective earth		Protective earth	
1 pole - 1 x 1		1 pole - 2 x 2		1 pole - 1 x 1	
Green/Yellow		Green/Yellow		Green/Yellow	
-		-		-	
56		87		69.5	
36.5		36.5		43.5	
6.2		6.2		8.2	
4		4		6	
0.08 - 4		0.08 - 4		0.2 - 6	
0.08 - 6		0.08 - 6		0.08 - 4	
-		-		-	
28 - 10 AWG		28 - 10 AWG		24 - 8 AWG	
28 - 10 AWG		28 - 10 AWG		24 - 8 AWG	
UL, CSA, VDE, GL, LR, DNV		UL, CSA, VDE, GL, LR, DNV		UL, CSA, VDE, GL, LR, DNV	
Sold in lots of	Unit reference	Sold in lots of	Unit reference	Sold in lots of	Unit reference
50	NSYTTR42PE	50	NSYTTR44PE	50	NSYTRV62PE
50	NSYTRAAB35	50	NSYTRAAB35	50	NSYTRAAB35
50	NSYTRAABV35	50	NSYTRAABV35	50	NSYTRAABV35
50	NSYTRACR42	50	NSYTRACR44	50	NSYTRACR62
50	NSYTRAPR42	-	-	-	-
-	-	-	-	10	NSYTRAL62
-	-	-	-	10	NSYTRAL63
-	-	-	-	10	NSYTRAL610
10	NSYTRAATM1	10	NSYTRAATM1	10	NSYTRAATM1
10	NSYTRAATP1	10	NSYTRAATP1	10	NSYTRAATP1
10	NSYTRAFT	10	NSYTRAFT	10	NSYTRAFT
10	-	10	-	10	-
100	NSYTRASB4	100	NSYTRASB4	100	NSYTRASB4
20	NSYSDR200BD	20	NSYSDR200BD	20	NSYSDR200BD
10		10		12	

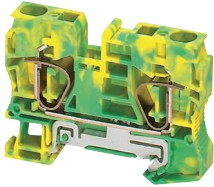
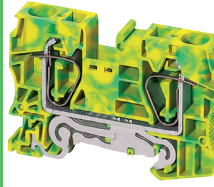

Lineryy TR

Spring terminal blocks

Spring terminal blocks - Protective earth					
					
		NSYTTR102PE		NSYTTR162PE	
Nominal c.s.a.		10 mm ²		16 mm ²	
	Type of block	Protective earth		Protective earth	
	Type of connection	1 pole - 1 x 1		1 pole - 1 x 1	
	Colour	Green/Yellow		Green/Yellow	
Max. electric values		-		-	
Dimensions (mm)					
	Length	71.5		80	
	Height	50.5		51	
	Width	10.2		12.2	
Cabling c.s.a. (mm ²)		10		16	
	Flexible cable	0.2 - 10		0.2 - 16	
	Solid cable	0.2 - 16		0.2 - 25	
Nominal electric values					
	IEC/EN 60947-7-1	-		-	
	UL	16 - 6 AWG		16 - 4 AWG	
	CSA	16 - 6 AWG		16 - 4 AWG	
Certifications		UL, CSA, VDE, GL, LR, DNV		UL, CSA, VDE, GL, LR, DNV	
Terminal blocks					
		Sold in lots of	Unit reference	Sold in lots of	Unit reference
	Green/Yellow	50	NSYTTR102PE	25	NSYTTR162PE
Accessories					
End stop for 35mm DIN rail	Clip-on, 5.2 mm	50	NSYTRAAB35	50	NSYTRAAB35
	With screw, 9.5 mm	50	NSYTRAABV35	50	NSYTRAABV35
End plate, width 2.2 mm	Grey	50	NSYTRACR102	50	NSYTRACR162
Plug-in bridge Red	2-pole	10	NSYTRAL102	10	NSYTRAL162
Test plug	Metallic part, Ø 2.3 mm	10	NSYTRAATM1	-	-
	Insulating sleeve, red	10	NSYTRAATP1	-	-
Test adaptor	For plug-in bridge shaft	10	NSYTRAFT	-	-
Marker tag holder	For ●AB35 end stop	100	NSYTRASB4	100	NSYTRASB4
DIN rail 35 x 7.2 mm	Perforated, 2 m long	20	NSYSDR200BD	20	NSYSDR200BD
Marking accessories		See page 142			
General data					
	Strip length (mm)	18		18	



Linergy TR

Spring terminal blocks

Spring terminal blocks - Double deck passthrough

PB502164-25

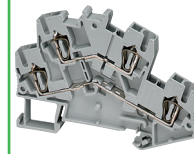

		NSYTRR24D	
Nominal c.s.a.	Type of block	Passthrough - Double deck	
	Type of connection	2 pole - 1 x 1	
	Colour	Grey	
	Max. electric values (Umax, Imax)	500 V, 26 A	
Dimensions (mm)			
	Length	78	
	Height	55	
	Width	5.2	
Cabling c.s.a. (mm ²)		2.5	
	Flexible cable	0.08 - 2.5	
	Solid cable	0.08 - 4	
Nominal electric values			
	IEC/EN 60947-7-1	500 V, 22 A	
	UL	600 V, 20 A, 28 - 12 AWG	
	CSA	600 V, 20 A, 28 - 12 AWG	
Certifications (1)		UL, CSA, VDE, GL, LR, DNV	
Terminal blocks			
		Sold in lots of	Unit reference
	Grey	50	NSYTRR24D
	Blue	-	-
Accessories			
1	End stop	Clip-on, 5.2 mm	50 NSYTRAAB35
2	for 35 mm DIN rail	With screw, 9.5 mm	50 NSYTRAABV35
3	End plate, width 2.2 mm	Grey	50 NSYTRACRE24
5	Plug-in bridge Red	2-pole	50 NSYTRAL22
		3-pole	50 NSYTRAL23
		4-pole	50 NSYTRAL24
		5-pole	50 NSYTRAL25
		10-pole	10 NSYTRAL210
		20-pole	10 NSYTRAL220
6	Vertical bridge	1-pole	50 NSYTRALV24R
8	Test plug	Metallic part, Ø 2.3 mm	10 NSYTRAATM1
		Insulating sleeve, red	10 NSYTRAATP1
9	Test adaptor	For plug-in bridge shaft	10 NSYTRAFT
10	Warning label	Yellow	10 NSYTRACSR2
11	Marker tag holder	For ●AB35 end stop	100 NSYTRASB4
12	DIN rail 35x7.2mm	Perforated, 2m long	20 NSYSDR200BD
13	Marking accessories		See page 142
General data			
	Strip length (mm)	10	

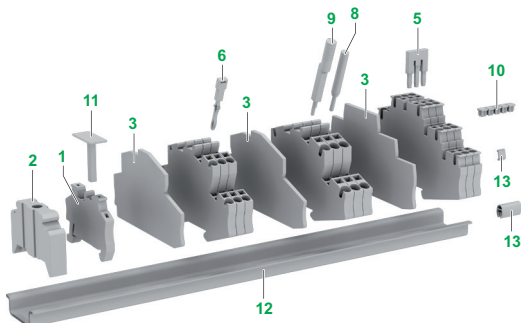

PB502354-33

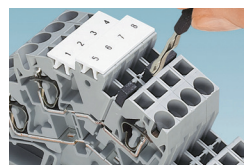

The **NSYTRALV24R** vertical bridge offers the option of connecting both levels of the standard double-level **NSYTRR24D** or **NSYTRR44D** terminal blocks.

Linergy TR

Spring terminal blocks

PB602153-30



PB602155-33

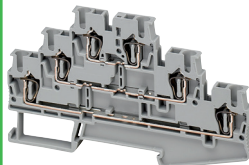

NSYTRR44D

4 mm²
Passthrough - Double deck
2 pole - 1 x 1
Grey
500 V, 34 A

NSYTRR26T

2.5 mm²
Passthrough - 3 Levels
3 pole - 1 x 1
Grey
500 V, 28 A

92.4
55
6.2
4
0.08 - 4
0.08 - 6

99.5
58
5.2
2.5
0.08 - 2.5
0.08 - 4

500 V, 28 A
600 V, 30 A, 28 - 10 AWG
600 V, 30 A, 28 - 10 AWG
UL, CSA, VDE, GL, LR, DNV

500 V, 20 A
600 V, 20 A, 28 - 12 AWG
600 V, 20 A, 28 - 12 AWG
UL, CSA, VDE, GL, LR

Sold in lots of

Unit reference

50 NSYTRR44D
50 NSYTRR44DBL

Sold in lots of

Unit reference

50 NSYTRR26T
-

50 NSYTRAAB35
50 NSYTRAABV35
50 NSYTRACRE44

50 NSYTRAAB35
50 NSYTRAABV35
-

50 NSYTRAL42
50 NSYTRAL43
50 NSYTRAL44
50 NSYTRAL45
10 NSYTRAL410
10 NSYTRAL420
50 NSYTRALV24R
10 NSYTRAATM1
10 NSYTRAATP1
10 NSYTRAFT
10 -
100 NSYTRASB4
20 NSYSDR200BD

50 NSYTRAL22
50 NSYTRAL23
50 NSYTRAL24
50 NSYTRAL25
10 NSYTRAL210
10 NSYTRAL220
-
10 NSYTRAATM1
10 NSYTRAATP1
10 NSYTRAFT
10 NSYTRACSR2
100 NSYTRASB4
20 NSYSDR200BD

10

10

Linery TR

Spring terminal blocks

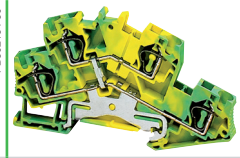
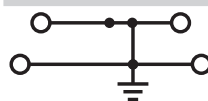
Spring terminal blocks - Double deck protective earth					
					
		NSYTRR24DPE		NSYTRR44DPE	
Nominal c.s.a.		2.5 mm ²		4 mm ²	
	Type of block	Protective earth - Double deck		Protective earth - Double deck	
	Type of connection	1 pole - 2 x 2		1 pole - 2 x 2	
	Colour	Green/Yellow		Green/Yellow	
Max. electric values		-		-	
Dimensions (mm)					
	Length	78		92.4	
	Height	55		55	
	Width	5.2		6.2	
Cabling c.s.a. (mm ²)		2.5		4	
	Flexible cable	0.08 - 2.5		0.08 - 4	
	Solid cable	0.08 - 4		0.08 - 6	
Nominal electric values					
	IEC/EN 60947-7-1	-		-	
	UL	28 - 12 AWG		28 - 10 AWG	
	CSA	28 - 12 AWG		28 - 10 AWG	
Certifications (1)		UL, CSA, VDE, GL, LR, DNV		UL, CSA, VDE, GL, LR, DNV	
Terminal blocks					
		Sold in lots of	Unit reference	Sold in lots of	Unit reference
Green/Yellow		50	NSYTRR24DPE	50	NSYTRR44DPE
Accessories					
End stop for 35 mm DIN rail	Clip-on, 5.2 mm	50	NSYTRAAB35	50	NSYTRAAB35
	With screw, 9.5 mm	50	NSYTRAABV35	50	NSYTRAABV35
End plate, width 2.2 mm	Grey	50	NSYTRACRE24	50	NSYTRACRE44
Plug-in bridge Red	2-pole	50	NSYTRAL22	50	NSYTRAL42
	3-pole	50	NSYTRAL23	50	NSYTRAL43
	4-pole	50	NSYTRAL24	50	NSYTRAL44
	5-pole	50	NSYTRAL25	50	NSYTRAL45
	10-pole	10	NSYTRAL210	10	NSYTRAL410
	20-pole	10	NSYTRAL220	10	NSYTRAL420
Test plug	Metallic part, Ø 2.3 mm	10	NSYTRAATM1	10	NSYTRAATM1
	Insulating sleeve, red	10	NSYTRAATP1	10	NSYTRAATP1
Test adaptor	For plug-in bridge shaft	10	NSYTRAFT	10	NSYTRAFT
Warning label	Yellow	10	NSYTRACSR2	10	-
Marker tag holder	For ●AB35 end stop	100	NSYTRASB4	100	NSYTRASB4
DIN rail 35 x 7.2 mm	Perforated, 2 m long	20	NSYSDR200BD	20	NSYSDR200BD
Marking accessories		See page 142			
General data					
	Strip length (mm)	10		10	



Lineryy TR

Spring terminal blocks

Spring terminal blocks - Disconnect

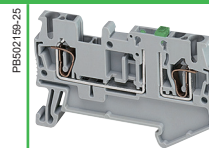

		NSYTRR22SC	
Nominal c.s.a.		2.5 mm ²	
Type of block		Disconnect (blade)	
Type of connection		1 pole - 1 x 1	
Colour		Grey	
Max. electric values (U _{max} , I _{max})		400 V, 20 A	
Dimensions (mm)			
Length		60.5	
Height		36.5	
Width		5.2	
Cabling c.s.a. (mm ²)		2.5	
Flexible cable		0.08 - 2.5	
Solid cable		0.08 - 4	
Nominal electric values			
IEC/EN 60947-7-1		400 V, 20 A	
UL		600 V, 16 A, 28 - 12 AWG	
CSA		300 V, 16 A, 28 - 12 AWG	
Certifications		UL, CSA	
Terminal blocks			
		Sold in lots of	Unit reference
Grey		50	NSYTRR22SC
Accessories			
1	End stop	Clip-on, 5.2 mm	50 NSYTRAAB35
2	for 35 mm DIN rail	With screw, 9.5 mm	50 NSYTRAABV35
3	End plate, width 2.2 mm	Grey	50 NSYTRACR23
4	Partition plate, width 2 mm	Grey	- -
5	Plug-in bridge Red	2-pole	50 NSYTRAL22
		3-pole	50 NSYTRAL23
		4-pole	50 NSYTRAL24
		5-pole	50 NSYTRAL25
		10-pole	10 NSYTRAL210
		20-pole	10 NSYTRAL220
14	Removable carrier width 6.1 mm 6 A max	For fuse 5 x 20 mm	- -
		For fuse 5 x 20 mm 110 - 250 V LED	- -
		For fuse 5 x 20 mm 12 - 30 V LED	- -
15	Removable carrier width 5.1 mm 6 A max	For component	- -
		With 1N4007 diode	- -
8	Test plug	Metallic part, Ø 2.3 mm	10 NSYTRAATM1
		Insulating sleeve, red	10 NSYTRAATP1
9	Test adaptor	For plug-in bridge shaft	10 NSYTRAFT
10	Warning label	Yellow	50 NSYTRACSR2
11	Marker tag holder	For ●AB35 end stop	100 NSYTRASB4
12	DIN rail 35 x 7.2 mm	Perforated, 2 m long	20 NSYSDR200BD
13	Marking accessories	See page 142	
General data			
Strip length (mm)		10	

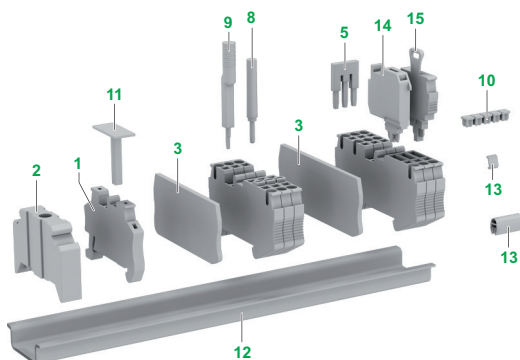

Linery TR

Spring terminal blocks

PB62/162-28

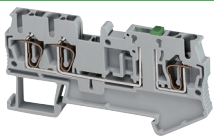

PB62/162-25

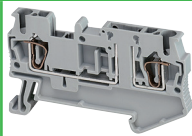

PB62/163-28

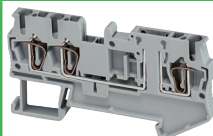





NSYTRR23SC		NSYTRR22TB		NSYTRR23TB	
2.5 mm ²		2.5 mm ²		2.5 mm ²	
Disconnect (blade)		Disconnect (for carrier)		Disconnect (for carrier)	
1 pole - 1 x 2		1 pole - 1 x 1		1 pole - 1 x 2	
Grey		Grey		Grey	
400 V, 20 A		400 V, 20 A		400 V, 20 A	
72		60.5		72	
36.5		36.5		36.5	
5.2		5.2		5.2	
2.5		2.5		2.5	
0.08 - 2.5		0.08 - 2.5		0.08 - 2.5	
0.08 - 4		0.08 - 4		0.08 - 4	
400 V, 20 A		400 V, 20 A		400 V, 20 A	
600 V, 16 A, 28 - 12 AWG		300 V, 16 A, 28 - 12 AWG		300 V, 16 A, 28 - 12 AWG	
300 V, 16 A, 28 - 12 AWG		300 V, 16 A, 28 - 12 AWG		300 V, 16 A, 28 - 12 AWG	
UL, CSA		UL, CSA		UL, CSA	
Sold in lots of	Unit reference	Sold in lots of	Unit reference	Sold in lots of	Unit reference
50	NSYTRR23SC	50	NSYTRR22TB	50	NSYTRR23TB
50	NSYTRAAB35	50	NSYTRAAB35	50	NSYTRAAB35
50	NSYTRAABV35	50	NSYTRAABV35	50	NSYTRAABV35
50	NSYTRACR24	50	NSYTRACR23	50	NSYTRACR24
50	NSYTRAPR24	-	-	50	NSYTRAPR24
50	NSYTRAL22	50	NSYTRAL22	50	NSYTRAL22
50	NSYTRAL23	50	NSYTRAL23	50	NSYTRAL23
50	NSYTRAL24	50	NSYTRAL24	50	NSYTRAL24
50	NSYTRAL25	50	NSYTRAL25	50	NSYTRAL25
10	NSYTRAL210	10	NSYTRAL210	10	NSYTRAL210
10	NSYTRAL220	10	NSYTRAL220	10	NSYTRAL220
-	-	10	NSYTRASF520	10	NSYTRASF520
-	-	10	NSYTRASF520M	10	NSYTRASF520M
-	-	10	NSYTRASF520B	10	NSYTRASF520B
-	-	10	NSYTRASV1	10	NSYTRASV1
-	-	10	NSYTRASV2	10	NSYTRASV2
10	NSYTRAATM1	10	NSYTRAATM1	10	NSYTRAATM1
10	NSYTRAATP1	10	NSYTRAATP1	10	NSYTRAATP1
10	NSYTRAFT	10	NSYTRAFT	10	NSYTRAFT
50	NSYTRACSR2	50	NSYTRACSR2	50	NSYTRACSR2
100	NSYTRASB4	100	NSYTRASB4	100	NSYTRASB4
20	NSYSDR200BD	20	NSYSDR200BD	20	NSYSDR200BD
10		10		10	

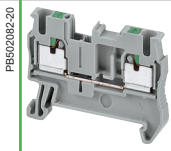
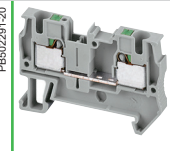
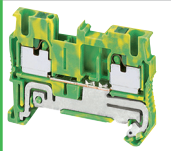
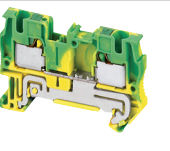

Linergy TR

Selection guide: push-in terminal blocks

Push-in		Passthrough		Protective earth	
		Passthrough			
					
Nominal c.s.a (mm ²)		2.5	4	2.5	4
Number of poles	1 - 1 x 1	NSYTRP22	NSYTRP42	NSYTRP22PE	NSYTRP42PE
	1 - 1 x 2	NSYTRP23	NSYTRP43	NSYTRP23PE	NSYTRP43PE
	1 - 2 x 2	NSYTRP24	NSYTRP44	NSYTRP24PE	NSYTRP44PE
	2 - 1 x 1	-	-	-	-
Colours	Grey	■	■	-	-
	Blue	NSYTRP22BL NSYTRP23BL NSYTRP24BL	NSYTRP42BL NSYTRP43BL NSYTRP44BL	-	-
	Green/yellow (PE)	-	-	■	■
	Orange	NSYTRP22AR NSYTRP23AR	-	-	-
Mounting on	35 mm 	■	■	■	■
	35 mm 	■	■	■	■
	Telequick	-	-	-	-
	15 mm 	-	-	-	-
See pages		128/129	129/130	132	133

PB502360-70

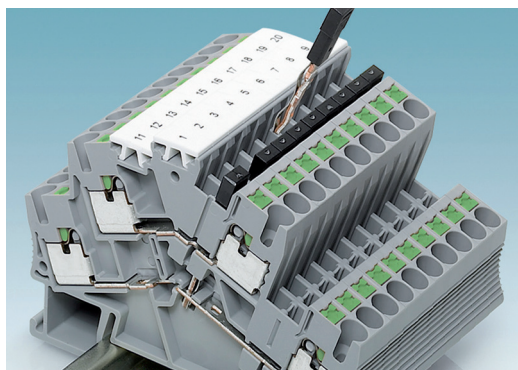

Vertical bridge

The **NSYTRALV24R** vertical bridge offers the option of connecting both levels of the standard double-level **NSYTRP24D** terminal block.

Linery TR

Selection guide: push-in terminal blocks

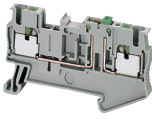
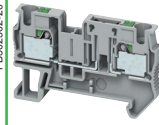
	Double deck	Disconnect	
		Blade	Removable carrier
			
	2.5	2.5	2.5 & 4
	-	NSYTRP22SC	NSYTRP22TB NSYTRP42TB
	-	NSYTRP23SC	-
	-	-	-
	NSYTRP24D	-	-
	■	■	■
	NSYTRP24DBL	-	-
	NSYTRP24DPE	-	-
	-	-	-
	■	■	■
	■	■	■
	-	-	-
	-	-	-
	134	136/137	137

Linergy TR

Push-in terminal blocks

Push-in terminal - Passthrough

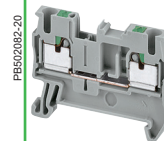

PE602002-20

		NSYTRP22			
Nominal c.s.a.	Nominal c.s.a.	2.5 mm ²			
	Type of block	Passthrough			
	Type of connection	1 pole - 1 x 1			
	Colour	Grey			
Max. electric values (U _{max} , I _{max})	800 V, 30 A				
Dimensions (mm)					
	Length	48.5			
	Height	36.5			
	Width	5.2			
Cabling c.s.a. (mm ²)	Cabling c.s.a. (mm ²)	2.5			
	Flexible cable	0.14 - 2.5			
	Solid cable	0.14 - 4			
Nominal electric values					
	IEC/EN 60947-7-1	800 V, 24 A			
	UL	600 V, 20 A, 24 -12 AWG			
	CSA	600 V, 20 A, 24 -12 AWG			
Certifications	UL, CSA, VDE, GL, LR				
Terminal blocks					
		Sold in lots of			
	Grey	50			
	Blue	50			
	Orange	50			
		Unit reference			
		NSYTRP22			
		NSYTRP22BL			
		NSYTRP22AR			
Accessories					
1	End stop	Clip-on, 5.2 mm	50	NSYTRAAB35	
2	for 35 mm DIN rail	With screw, 9.5 mm	50	NSYTRAABV35	
3	End plate width 2.2 mm	Grey	50	NSYTRACR22	
4	Partition plate width 2 mm	Grey	50	NSYTRAPR42	
5	Plug-in bridge	Red	2-pole	50	NSYTRAL22
		3-pole	50	NSYTRAL23	
		4-pole	50	NSYTRAL24	
		5-pole	50	NSYTRAL25	
		10-pole	10	NSYTRAL210	
		20-pole	10	NSYTRAL220	
Blue	10-pole	10	NSYTRAL210BL		
Grey	10-pole	10	NSYTRAL210GR		
8	Test plug	Metallic part, Ø 2.3 mm	10	NSYTRAATM1	
		Insulating sleeve, red	10	NSYTRAATP1	
9	Test adaptor	For plug-in bridge shaft	10	NSYTRAFT	
11	Marker tag holder	For ●AB35 end stop	100	NSYTRASB4	
12	DIN rail 35 x 7.2 mm	Perforated, 2 m long	20	NSYSR200BD	
13	Marking accessories		See page 142		
General data					
	Strip length (mm)		10		

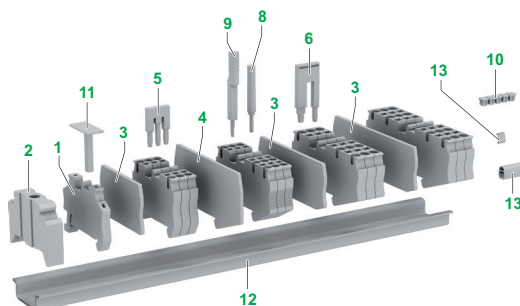

Linergy TR

Push-in terminal blocks

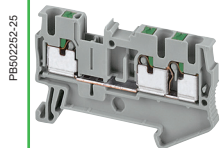

PE602291-25

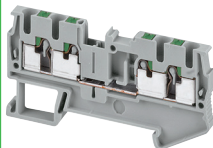

PE602291-28

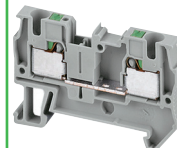

PE602291-23



NSYTRP23		NSYTRP24		NSYTRP42	
2.5 mm ²		2.5 mm ²		4 mm ²	
Passthrough		Passthrough		Passthrough	
1 pole - 1 x 2		1 pole - 2 x 2		1 pole - 1 x 1	
Grey		Grey		Grey	
800 V, 30 A		800 V, 30 A		800 V, 38 A	
60.5		72		56	
36.5		36.5		36.5	
5.2		5.2		6.2	
2.5		2.5		4	
0.14 - 2.5		0.14 - 2.5		0.2 - 4	
0.14 - 4		0.14 - 4		0.2 - 6	
800 V, 24 A		800 V, 24 A		800 V, 32 A	
600 V, 20 A, 24 - 12 AWG		600 V, 20 A, 24 - 12 AWG		600 V, 30 A, 24 - 10 AWG	
600 V, 20 A, 24 - 12 AWG		600 V, 20 A, 24 - 12 AWG		600 V, 30 A, 24 - 10 AWG	
UL, CSA, VDE, GL, LR		UL, CSA, VDE, GL, LR		UL, CSA, GL, LR	
Sold in lots of	Unit reference	Sold in lots of	Unit reference	Sold in lots of	Unit reference
50	NSYTRP23	50	NSYTRP24	50	NSYTRP42
50	NSYTRP23BL	50	NSYTRP24BL	50	NSYTRP42BL
50	NSYTRP23AR	-	-	-	-
50	NSYTRAAB35	50	NSYTRAAB35	50	NSYTRAAB35
50	NSYTRAABV35	50	NSYTRAABV35	50	NSYTRAABV35
50	NSYTRACR23	50	NSYTRACR24	50	NSYTRACR42
-	-	50	NSYTRAPR24	50	NSYTRAPR42
50	NSYTRAL22	50	NSYTRAL22	50	NSYTRAL42
50	NSYTRAL23	50	NSYTRAL23	50	NSYTRAL43
50	NSYTRAL24	50	NSYTRAL24	50	NSYTRAL44
50	NSYTRAL25	50	NSYTRAL25	50	NSYTRAL45
10	NSYTRAL210	10	NSYTRAL210	10	NSYTRAL410
10	NSYTRAL220	10	NSYTRAL220	10	NSYTRAL420
10	NSYTRAL210BL	10	NSYTRAL210BL	10	NSYTRAL410BL
10	NSYTRAL210GR	10	NSYTRAL210GR	10	NSYTRAL410GR
10	NSYTRAATM1	10	NSYTRAATM1	10	NSYTRAATM1
10	NSYTRAATP1	10	NSYTRAATP1	10	NSYTRAATP1
10	NSYTRAFT	10	NSYTRAFT	10	NSYTRAFT
100	NSYTRASB4	100	NSYTRASB4	100	NSYTRASB4
20	NSYSDR200BD	20	NSYSDR200BD	20	NSYSDR200BD
10		10		12	



Linery TR

Push-in terminal blocks

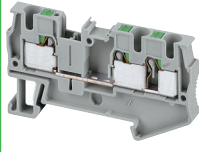
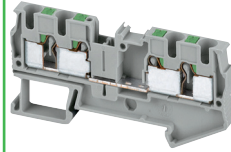
Push-in terminal - Passthrough



		PE502294-26 	PE502297-30 		
		NSYTRP43	NSYTRP44		
Nominal c.s.a.		4 mm ²	4 mm ²		
	Type of block	Passthrough	Passthrough		
	Type of connection	1 pole - 1 x 2	1 pole - 2 x 2		
	Colour	Grey	Grey		
Max. electric values (Umax , Imax)		800 V, 38 A	800 V, 38 A		
Dimensions (mm)					
	Length	66.5	77		
	Height	36.5	36.5		
	Width	6.2	6.2		
Cabling c.s.a. (mm ²)		4	4		
	Flexible cable	0.2 - 4	0.2 - 4		
	Solid cable	0.2 - 6	0.2 - 6		
Nominal electric values					
	IEC/EN 60947-7-1	800 V, 32 A	800 V, 32 A		
	UL	600 V, 30 A, 24 - 10 AWG	600 V, 30 A, 24 - 10 AWG		
	CSA	600 V, 30 A, 24 - 10 AWG	600 V, 30 A, 24 - 10 AWG		
Certifications		UL, CSA, GL, LR	UL, CSA, GL, LR		
Terminal blocks					
		Sold in lots of	Unit reference	Sold in lots of	Unit reference
	Grey	50	NSYTRP43	50	NSYTRP44
	Blue	50	NSYTRP43BL	50	NSYTRP44BL
	Orange	-	-	-	-
Accessories					
End stop	Clip-on, 5.2 mm	50	NSYTRAAB35	50	NSYTRAAB35
for 35 mm DIN rail	With screw, 9.5 mm	50	NSYTRAABV35	50	NSYTRAABV35
End plate	Grey	50	NSYTRACP43	50	NSYTRACP44
width 2.2 mm					
Plug-in bridge	2-pole	50	NSYTRAL42	50	NSYTRAL42
Red	3-pole	50	NSYTRAL43	50	NSYTRAL43
	4-pole	50	NSYTRAL44	50	NSYTRAL44
	5-pole	50	NSYTRAL45	50	NSYTRAL45
	10-pole	10	NSYTRAL410	10	NSYTRAL410
	20-pole	10	NSYTRAL420	10	NSYTRAL420
Blue	10-pole	10	NSYTRAL410BL	10	NSYTRAL410BL
Grey	10-pole	10	NSYTRAL410GR	10	NSYTRAL410BL
Test plug	Metallic part, Ø 2.3 mm	10	NSYTRAATM1	10	NSYTRAATM1
	Insulating sleeve, red	10	NSYTRAATP1	10	NSYTRAATP1
Test adaptor	For plug-in bridge shaft	10	NSYTRAFT	10	NSYTRAFT
Marker tag holder	For ●AB35 end stop	100	NSYTRASB4	100	NSYTRASB4
DIN rail 35 x 7.2 mm	Perforated, 2 m long	20	NSYSDR200BD	20	NSYSDR200BD
Marking accessories		See page 142			
General data					
	Strip length (mm)	12		12	



Linery TR

Push-in terminal blocks

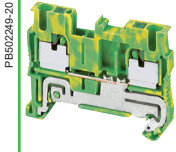
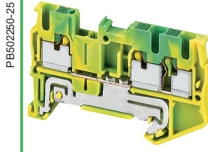
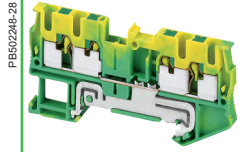
Push-in terminal blocks - Protective earth

							
		NSYTRP22PE	NSYTRP23PE	NSYTRP24PE			
Nominal c.s.a.	Nominal c.s.a.	2.5 mm ²	2.5 mm ²	2.5 mm ²			
	Type of block	Protective earth	Protective earth	Protective earth			
	Type of connection	1 pole - 1 x 1	1 pole - 1 x 2	1 pole - 2 x 2			
	Colour	Green/Yellow	Green/Yellow	Green/Yellow			
Max. electric values		-	-	-			
Dimensions (mm)							
	Length	48.5	60.5	72			
	Height	36.5	36.5	36.5			
	Width	5.2	5.2	5.2			
Cabling c.s.a. (mm ²)	Cabling c.s.a. (mm ²)	2.5	2.5	2.5			
	Flexible cable	0.08 - 2.5	0.08 - 2.5	0.08 - 2.5			
	Solid cable	0.08 - 4	0.08 - 4	0.08 - 4			
Nominal electric values							
	IEC/EN 60947-7-1	-	-	-			
	UL	24 - 12 AWG	24 - 12 AWG	24 - 12 AWG			
	CSA	24 - 12 AWG	24 - 12 AWG	24 - 12 AWG			
Certifications		UL, CSA, VDE, GL, LR	UL, CSA, VDE, GL, LR	UL, CSA, VDE, GL, LR			
Terminal blocks							
		Sold in lots of	Unit reference	Sold in lots of	Unit reference	Sold in lots of	Unit reference
	Green/Yellow	50	NSYTRP22PE	50	NSYTRP23PE	50	NSYTRP24PE
Accessories							
End stop for 35 mm DIN rail	Clip-on, 5.2 mm	50	NSYTRAAB35	50	NSYTRAAB35	50	NSYTRAAB35
	With screw, 9.5 mm	50	NSYTRAABV35	50	NSYTRAABV35	50	NSYTRAABV35
End plate, width 2.2 mm	Grey	50	NSYTRACR22	50	NSYTRACR23	50	NSYTRACR24
	Grey	50	NSYTRAPR42	-	-	50	NSYTRAPR24
Plug-in bridge Red	2-pole	50	NSYTRAL22	50	NSYTRAL22	50	NSYTRAL22
	3-pole	50	NSYTRAL23	50	NSYTRAL23	50	NSYTRAL23
	4-pole	50	NSYTRAL24	50	NSYTRAL24	50	NSYTRAL24
	5-pole	50	NSYTRAL25	50	NSYTRAL25	50	NSYTRAL25
	10-pole	10	NSYTRAL210	10	NSYTRAL210	10	NSYTRAL210
	20-pole	10	NSYTRAL220	10	NSYTRAL220	10	NSYTRAL220
Test plug	Metallic part, Ø 2.3 mm	10	NSYTRAATM1	10	NSYTRAATM1	10	NSYTRAATM1
	Insulating sleeve, red	10	NSYTRAATP1	10	NSYTRAATP1	10	NSYTRAATP1
Test adaptor	For plug-in bridge shaft	10	NSYTRAFB	10	NSYTRAFB	10	NSYTRAFB
Marker tag holder	For ●AB35 end stop	100	NSYTRASB4	100	NSYTRASB4	100	NSYTRASB4
DIN rail 35 x 7.2 mm	Perforated, 2 m long	20	NSYSDR200BD	20	NSYSDR200BD	20	NSYSDR200BD
Marking accessories		See page 142					
General data							
	Strip length (mm)	10		10		10	

Linery TR

Push-in terminal blocks

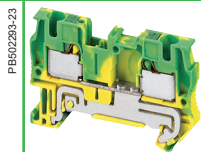

NSYTRP42PE

4 mm²
Protective earth
1 pole - 1 x 1
Green/Yellow
-

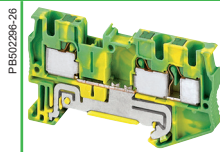

NSYTRP43PE

4 mm²
Protective earth
1 pole - 1 x 2
Green/Yellow
-

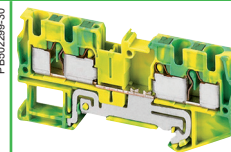

NSYTRP44PE

4 mm²
Protective earth
1 pole - 2 x 2
Green/Yellow
-

56
36.5
6.2
4
0.08 - 4
0.08 - 6

66.5
36.5
6.2
4
0.08 - 4
0.08 - 6

77
36.5
6.2
4
0.08 - 4
0.08 - 6

-
24 - 10 AWG
24 - 10 AWG
UL, CSA, GL, LR

-
24 - 10 AWG
24 - 10 AWG
UL, CSA, GL, LR

-
24 - 10 AWG
24 - 10 AWG
UL, CSA, GL, LR

Sold in lots of Unit reference

50 NSYTRP42PE

Sold in lots of Unit reference

50 NSYTRP43PE

Sold in lots of Unit reference

50 NSYTRP44PE

50 NSYTRAAB35
50 NSYTRAABV35

50 NSYTRAAB35
50 NSYTRAABV35

50 NSYTRAAB35
50 NSYTRAABV35

50 NSYTRACR42

50 NSYTRACP43

50 NSYTRACP44

50 NSYTRAPR42

- -

- -

50 NSYTRAL42

50 NSYTRAL42

50 NSYTRAL42

50 NSYTRAL43

50 NSYTRAL43

50 NSYTRAL43

50 NSYTRAL44

50 NSYTRAL44

50 NSYTRAL44

50 NSYTRAL45

50 NSYTRAL45

50 NSYTRAL45

10 NSYTRAL410

10 NSYTRAL410

10 NSYTRAL410

10 NSYTRAL420

10 NSYTRAL420

10 NSYTRAL420

10 NSYTRAATM1

10 NSYTRAATM1

10 NSYTRAATM1

10 NSYTRAATP1

10 NSYTRAATP1

10 NSYTRAATP1

10 NSYTRAFT

10 NSYTRAFT

10 NSYTRAFT

100 NSYTRASB4

100 NSYTRASB4

100 NSYTRASB4

20 NSYSDR200BD

20 NSYSDR200BD

20 NSYSDR200BD

12

12

12



Linergy TR

Push-in terminal blocks

Push-in terminal blocks - Double deck passthrough

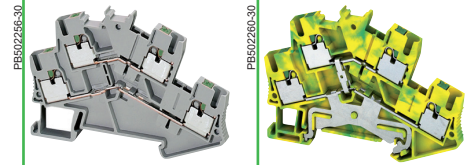

	NSYTRP24D	NSYTRP24DPE
Nominal c.s.a.	2.5 mm ²	2.5 mm ²
Type of block	Passthrough - Double deck	Protective earth - Double deck
Type of connection	2 pole - 1 x 1	1 pole - 2 x 2
Colour	Grey	Green/Yellow
Max. electric values (U _{max} , I _{max})	500 V, 24 A	-

Dimensions (mm)

Length	78	78
Height	55	55
Width	5.2	5.2
Cabling c.s.a. (mm ²)	2.5	2.5
Flexible cable	0.14 - 2.5	0.14 - 2.5
Solid cable	0.14 - 4	0.14 - 4

Nominal electric values

IEC/EN 60947-7-1	500 V, 22 A	-
UL	600 V, 20 A, 26 - 12 AWG	26 - 12 AWG
CSA	600 V, 20 A, 26 - 12 AWG	26 - 12 AWG
Certifications (1)	UL, CSA, VDE, GL, LR, DNV	UL, CSA, VDE, GL, LR, DNV

Terminal blocks

	Sold in lots of	Unit reference	Sold in lots of	Unit reference
Grey	50	NSYTRP24D	50	NSYTRP24DPE
Blue	50	NSYTRP24DBL	-	-

Accessories

1 End stop	Clip-on, 5.2 mm	50	NSYTRAAB35	50	NSYTRAAB35
2 for 35 mm DIN rail	With screw, 9.5 mm	50	NSYTRAABV35	50	NSYTRAABV35
3 End plate, width 2.2 mm	Grey	50	NSYTRACRE24	50	NSYTRACRE24
5 Plug-in bridge	2-pole	50	NSYTRAL22	50	NSYTRAL22
	3-pole	50	NSYTRAL23	50	NSYTRAL23
	4-pole	50	NSYTRAL24	50	NSYTRAL24
	5-pole	50	NSYTRAL25	50	NSYTRAL25
	10-pole	10	NSYTRAL210	10	NSYTRAL210
	20-pole	10	NSYTRAL220	10	NSYTRAL220
6 Vertical bridge	1-pole	50	NSYTRALV24R	-	-
8 Test plug	Metallic part, Ø 2.3 mm	10	NSYTRAATM1	10	NSYTRAATM1
	Insulating sleeve, red	10	NSYTRAATP1	10	NSYTRAATP1
9 Test adaptor	For plug-in bridge shaft	10	NSYTRAPT	10	NSYTRAPT
11 Marker tag holder	For ●AB35 end stop	100	NSYTRASB4	100	NSYTRASB4
12 DIN rail	Perforated, 2 m long 35 x 7.2 mm	20	NSYSDR200BD	20	NSYSDR200BD
13 Marking accessories		See page 142			

General data

Strip length (mm)	10	10
-------------------	----	----

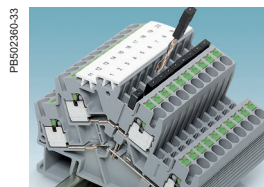
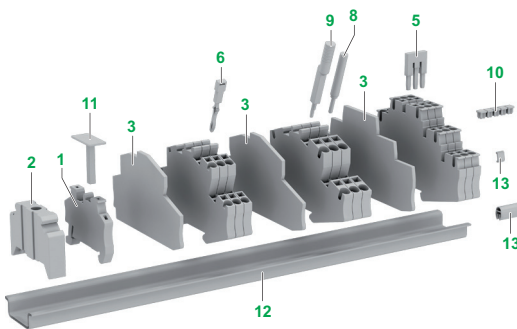

The NSYTRALV24R vertical bridge offers the option of connecting both levels of the standard double deck NSYTRP24D terminal block.

Linery TR

Push-in terminal blocks

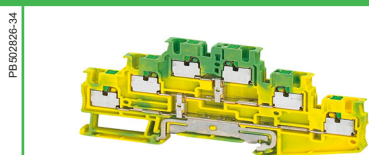
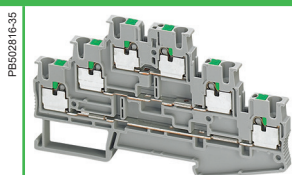

NSYTRP26T		NSYTRP26TPE	
2.5 mm ²		2.5 mm ²	
Passthrough - 3 Levels		Passthrough - 3 Levels	
3 pole - 1 x 1		3 pole - 1 x 1	
Grey		Green/Yellow	
500 V, 24 A		-	
102		102	
58		58	
5.2		5.2	
2.5		2.5	
0.14 - 2.5		0.14 - 2.5	
0.14 - 4		0.14 - 4	
500 V, 20 A		-	
300 V, 20 A, 26 - 12 AWG		26 - 12 AWG	
300 V, 20 A, 26 - 12 AWG		-	
UL, CSA		UL	
Sold in lots of	Unit reference	Sold in lots of	Unit reference
50	NSYTRP26T	50	NSYTRP26TPE
50	-	-	-
50	NSYTRAAB35	50	NSYTRAAB35
50	NSYTRAABV35	50	NSYTRAABV35
50	NSYTRACPE26	50	NSYTRACPE26
50	NSYTRAL22	50	NSYTRAL22
50	NSYTRAL23	50	NSYTRAL23
50	NSYTRAL24	50	NSYTRAL24
50	NSYTRAL25	50	NSYTRAL25
10	NSYTRAL210	10	NSYTRAL210
10	NSYTRAL220	10	NSYTRAL220
-	-	-	-
10	NSYTRAATM1	10	NSYTRAATM1
10	NSYTRAATP1	10	NSYTRAATP1
10	NSYTRAFT	10	NSYTRAFT
100	NSYTRASB4	100	NSYTRASB4
20	NSYSDR200BD	20	NSYSDR200BD
10		10	



Linergy TR

Push-in terminal blocks

Push-in terminal blocks - Disconnect

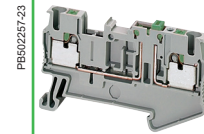

		NSYTRP22SC
Nominal c.s.a.		2.5 mm ²
	Type of block	Disconnect (blade)
	Type of connection	1 pole - 1 x 1
	Colour	Grey
Max. electric values (U _{max} , I _{max})	400 V, 20 A	

Dimensions (mm)		
	Length	62
	Height	36.5
	Width	5.2
Cabling c.s.a. (mm ²)		2.5
	Flexible cable	0.14 - 2.5
	Solid cable	0.14 - 4

Nominal electric values		
	IEC/EN 60947-7-1	400 V, 20 A
	UL	300 V, 20 A, 26 -12 AWG
	CSA	300 V, 20 A, 26 -12 AWG
Certifications	UL, CSA, VDE, GL, LR	

Terminal blocks			
	Grey	Sold in lots of	Unit reference
		50	NSYTRP22SC

Accessories				
1	End stop	Clip-on, 5.2 mm	50	NSYTRAAB35
2	for 35 mm DIN rail	With screw, 9.5 mm	50	NSYTRAABV35
3	End plate, width 2.2 mm	Grey	50	NSYTRACPK22
4	Partition plate, width 2 mm	Grey	-	-
5	Plug-in bridge Red	2-pole	50	NSYTRAL22
		3-pole	50	NSYTRAL23
		4-pole	50	NSYTRAL24
		5-pole	50	NSYTRAL25
		10-pole	10	NSYTRAL210
14	Removable carrier width 6.1 mm	For fuse 5 x 20 mm	-	
		For fuse 5 x 20 mm 110 V	-	
		For fuse 5 x 20 mm 12 V	-	
15	Removable carrier width 5.1 mm	For component	-	
		With 1N4007 diode	-	
8	Test plug	Metallic part, Ø 2.3 mm	10	NSYTRAATM1
		Insulating sleeve, red	10	NSYTRAATP1
9	Test adaptor	For plug-in bridge shaft	10	NSYTRAFT
11	Marker tag holder	For ●AB35 end stop	100	NSYTRASB4
12	DIN rail 35 x 7.2 mm	Perforated, 2 m long	20	NSYSDR200BD
13	Marking accessories	See page 142		

General data		
	Strip length (mm)	10

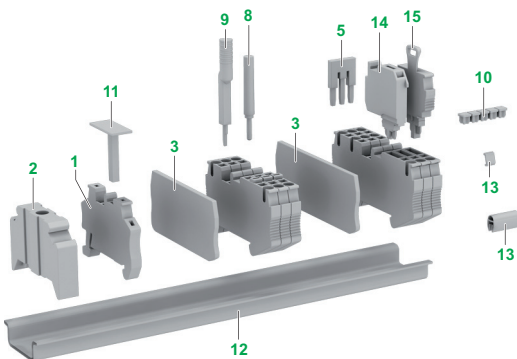

Linery TR

Push-in terminal blocks

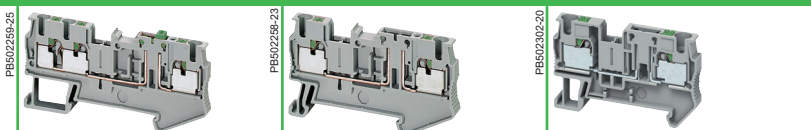



NSYTRP23SC	NSYTRP22TB	NSYTRP42TB
2.5 mm ²	2.5 mm ²	4 mm ²
Disconnect (blade)	Disconnect (for carrier)	Disconnect (for carrier)
1 pole - 1 x 2	1 pole - 1 x 1	1 pole - 1 x 1
Grey	Grey	Grey
400 V, 20 A	400 V, 20 A	400 V, 20 A
72	62	56
36.5	36.5	36.5
5.2	5.2	6.2
2.5	2.5	4
0.14 - 2.5	0.14 - 2.5	0.2 - 4
0.14 - 4	0.14 - 4	0.2 - 6
400 V, 20 A	400 V, 20 A	400 V, 20 A
300 V, 20 A, 26 -12 AWG	300 V, 20 A, 26 -12 AWG	300 V, 20 A, 24 -12 AWG
300 V, 20 A, 26 -12 AWG	300 V, 20 A, 26 -12 AWG	300 V, 20 A, 24 -12 AWG
UL, CSA, VDE, GL, LR	UL, CSA, VDE, GL, LR	UL, CSA, VDE, GL

Sold in lots of	Unit reference	Sold in lots of	Unit reference	Sold in lots of	Unit reference
50	NSYTRP23SC	50	NSYTRP22TB	50	NSYTRP42TB
50	NSYTRAAB35	50	NSYTRAAB35	50	NSYTRAAB35
50	NSYTRAABV35	50	NSYTRAABV35	50	NSYTRAABV35
50	NSYTRACPK23	50	NSYTRACPK22	50	NSYTRACR42
50	NSYTRAPR24	-	-	50	NSYTRAPR24
50	NSYTRAL22	50	NSYTRAL22	50	NSYTRAL42
50	NSYTRAL23	50	NSYTRAL23	50	NSYTRAL43
50	NSYTRAL24	50	NSYTRAL24	50	NSYTRAL44
50	NSYTRAL25	50	NSYTRAL25	50	NSYTRAL45
10	NSYTRAL210	10	NSYTRAL210	10	NSYTRAL410
10	NSYTRAL220	10	NSYTRAL220	10	NSYTRAL420
-		10	NSYTRASF520	10	NSYTRASF520
-		10	NSYTRASF520M	10	NSYTRASF520M
-		10	NSYTRASF520B	10	NSYTRASF520B
-		10	NSYTRASV1	10	NSYTRASV1
-		10	NSYTRASV2	10	NSYTRASV2
10	NSYTRAATM1	10	NSYTRAATM1	10	NSYTRAATM1
10	NSYTRAATP1	10	NSYTRAATP1	10	NSYTRAATP1
10	NSYTRAFT	10	NSYTRAFT	10	NSYTRAFT
100	NSYTRASB4	100	NSYTRASB4	100	NSYTRASB4
20	NSYSDR200BD	20	NSYSDR200BD	20	NSYSDR200BD
10		10		10	



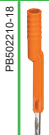

Lineryy TR Accessories

Accessories

				
Test accessories	NSYTRAFT	NSYTRAFT●●	NSYTRAATM1	NSYTRAATP1
Description	Test adapter for Ø 4 mm test plugs	Snap-on test adapter for Ø 4 mm test plugs	Test adapter - metallic part Ø 2.3 mm	Test adapter - plastic part
Dimensions W / D / H (mm)	6 / 6.5 / 51 mm	6 / 6.5 / 51 mm	5 / 5 / 10.8 mm	5 / 5 / 20 mm
Material	Polyamide (PA 6.6)	Polyamide (PA 6.6)	Silver-plated brass	Polyamide (PA 6.6)
Colour	Grey	Orange / Yellow / Green	Silver	Red
Inflammability class acc. to UL 94	V0	V0	-	V0
Temperature range (°C)	-40 ... +125	-40 ... +125	-40 ... +125	-40 ... +125
Compatibility	For 2.5 mm ² , 4 mm ² & 6 mm ² terminals	For 6 mm ² terminals	For 2.5 mm ² , 4 mm ² & 6 mm ² terminals	-
For terminal block width	5.2 mm; 6.2 mm & 8.2 mm	8.2 mm	5.2 mm; 6.2 mm & 8.2 mm	-
Mounting position	Plugs in bridge shafts	Plugs in bridge shafts Cannot be removed	Plugs in bridge shafts For 2.3 mm Ø socket hole	For NSYTRAATM1 metal part



Marking strips		Sold in lots of	Unit Reference	Sold in lots of	Unit Reference	Sold in lots of	Unit Reference	Sold in lots of	Unit Reference
Color	Grey	10	NSYTRAFT	-	-	10	NSYTRAATM1	-	-
	Yellow	-	-	10	NSYTRAFTYE	-	-	-	-
	Green	-	-	10	NSYTRAFTGN	-	-	-	-
	Red	-	-	-	-	-	-	10	NSYTRAATP1



Accessories

			
Insulation accessories	NSYTRAAB35	NSYTRAABV35	NSYTRAAB15
Description	End stop, clip-on	End stop, with screw	End stop, clip-on
Dimensions W / D / H (mm)	5.2 / 48.5 / 35	9.5 / 48.6 / 32.8	5.2 / 22 / 22.6 mm
Material	Polyamide (PA)	Polyamide (PA)	Polyamide (PA)
Colour	Grey	Grey	Grey
Inflammability class acc. to UL 94	V2	V2	V2
Temperature range (°C)	-40 ... +100	-40 ... +100	-40 ... +100
Compatibility	For NS 35/7.5 or NS 35/15 DIN rail	For NS 35/7.5 or NS 35/15 DIN rail	For NS 15 DIN rail
For terminal block width	-	-	-
Mounting position	Markable with NSYTRABF5● strips	Markable with NSYTRAB8● strips	Markable with NSYTRABF5● strips

Marking strips		Sold in lots of	Unit Reference	Sold in lots of	Unit Reference	Sold in lots of	Unit Reference
Color	Grey	50	NSYTRAAB35	50	NSYTRAABV35	50	NSYTRAAB15
	Yellow	-	-	-	-	-	-

Linery TR Accessories

			
<small>PB502170-18</small>	<small>PB502171-18</small>		
NSYTRASV●	NSYTRASF520●		
Removable component carrier - with spring cage contact - 6 A max	Removable fuse carrier For fuse 5 x 20 mm - 6 A max		
5.1 / 24 / 22 mm	6.1 / 28 / 25 mm		
Polyamide (PA 6.6)	Polyamide (PA 6.6)		
Grey	Black		
V0	V0		
-40 ... +125	-40 ... +125		
For all disconnect terminals	For 4 mm ² disconnect terminals Only for individual 2.5 mm ² disconnect terminals		
5.2 mm & 6.2 mm	6.2 mm (& 5.2 mm)		
Plugs in the disconnect area Markable with NSYTRABF5● strips	Plugs in the disconnect area Markable with NSYTRAB6● strips Only for single 5.2 mm terminal blocks		
Sold in lots of	Unit Reference	Sold in lots of	Unit Reference
10	NSYTRASV1 for component	10	NSYTRASF520
10	NSYTRASV2 with 1N4007 diode	10	NSYTRASF520M with LED 110-250V
-	-	10	NSYTRASF520B with LED 11-30 V
-	-	-	-
-	-	-	-
-	-	-	-



			
<small>PB502172-18</small>	<small>PB502282-18</small>	<small>PB502121-18</small>	
NSYTRACS●	NSYTRACSR●	NSYTRASB4	
Warning label for screw terminals	Warning cover for spring and push-in terminals	Terminal strip marker carrier, height-adjustable	
-	-	10 / 22 / 27	
Polyamide	Polyamide	Polyamide	
Yellow	Yellow	Grey	
V0	V2	V2	
-40 ... +125	-40 ... +100	-40 ... +100	
Only for screw terminal from 2.5 mm ² up to 35 mm ²	Only for spring or push-in terminal from 2.5 mm ² up to 35 mm ²	For NSYTRAAB35 , NSYTRAABV35 & NSYTRAAB15 end stop	
5.2 / 6.2 / 8.2 / 10.2 / 12 / 16 mm	5.2 / 6.2 / 8.2 / 10.2 / 12 / 16 mm	-	
The warning label snap into the screw shafts of the relevant terminal	The warning cover snap into the actuation shafts of the relevant terminal	Snap into the shaft of the end stop Markable with LA9D91 or LA9D93 labels	
Sold in lots of	Unit Reference	Sold in lots of	Unit Reference
-	-	100	NSYTRASB4
10	NSYTRACS2	-	-
10	NSYTRACS4	-	-
10	NSYTRACS6	-	-
10	NSYTRACS10	-	-
10	NSYTRACS16	-	-
10	NSYTRACS35	-	-



Linery TR

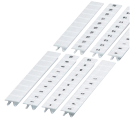

Marking accessories

Marking accessories

	 PB502338-18	 PB502338-17	 PB502338-17
Clip-in marker strips	NSYTRAB5●	NSYTRAB6●	NSYTRAB8●
Description	10 consecutive figures or numbers, printed horizontally	10 consecutive figures or numbers, printed horizontally	10 consecutive figures or numbers, printed horizontally
Material	Polyamide (PA 6.6, silicone and halogen free)	Polyamide (PA 6.6, silicone and halogen free)	Polyamide (PA 6.6, silicone and halogen free)
Colour	Black markings on white background	Black markings on white background	Black markings on white background
Inflammability class acc. to UL 94	V2	V2	V2
Temperature range (°C)	-40 ... +100	-40 ... +100	-40 ... +100
Compatibility	For all 2,5 mm ² terminal blocks For 10 mm ² TBs: 2 marking elements for 1 terminal	For all 4 mm ² terminal blocks For 16 mm ² TBs: 2 marking elements for 1 terminal	For 6 mm ² TBs: NSY TRV / TRR For 35 mm ² TBs: 2 marking elements for 1 terminal
For terminal block width	5.2 mm	6.2 mm	8.2 mm
Mounting position	Lateral sides for NSYTRV terminal blocks Central shaft for NSYTRR / NSYTRP / NSYTRH terminal blocks	Lateral sides for NSYTRV terminal blocks Central shaft for NSYTRR / NSYTRP / NSYTRH terminal blocks	Lateral sides for NSYTRV terminal blocks Central shaft for NSYTRR / NSYTRP terminal blocks

Marking strips						
Printed characters	Sold in lots of	Unit reference	Sold in lots of	Unit reference	Sold in lots of	Unit reference
1 10	10	NSYTRAB510	10	NSYTRAB610		
11 20	10	NSYTRAB520	10	NSYTRAB620		
21 30	10	NSYTRAB530	10	NSYTRAB630		
31 40	10	NSYTRAB540	10	NSYTRAB640		
41 50	10	NSYTRAB550	10	NSYTRAB650		
51 60	10	NSYTRAB560	10	NSYTRAB660		
61 70	10	NSYTRAB570	10	NSYTRAB670		
71 80	10	NSYTRAB580	10	NSYTRAB680		
81 90	10	NSYTRAB590	10	NSYTRAB690		
91 100	10	NSYTRAB5100	10	NSYTRAB6100		
1 100 (1 - 10; 11 -20; ... 91 - 100)	100	NSYTRAB51100	100	NSYTRAB61100	-	-
L1, L2, L3, N, PE, L1, L2, L3, N, PE	10	NSYTRAB5L1N	10	NSYTRAB6L1N	-	-

Marking cards

	 PB502343-26	 PB502344-26	 PB502345-26			
Blank marking cards	Sold in lots of	Unit reference	Sold in lots of	Unit reference	Sold in lots of	Unit reference
72 characters (6 strips)	10	NSYTRABPV5	-	-	-	-
60 characters (6 strips)	-	-	10	NSYTRABPV6	-	-
42 characters (6 strips)	-	-	-	-	10	NSYTRABPV8

Marking cards for AB1/DB6 terminals and Multi9 Acti9 range (2)

Blank (60 characters max.)	-	-	10	NSYTRAXPV6	-	-
----------------------------	---	---	----	------------	---	---

Accessories						
Plotter adapter for marking cards	1	NSYTRABMP1	1	NSYTRABMP1	1	NSYTRABMP1

(1) For 16mm² terminal blocks or bigger, the strip must be broken and use the individual marking characters.

(2) Only for AB1 terminal blocks 4mm²; and for Multi9 Acti9 range. Can't be used in NSYTR terminals.

Linery TR

Marking accessories

Marking accessories

PB50201-20



		NSYTRABCV●	
		Marking collars for cables	
Description		Open marker carrier, 15 mm wide, for clipping into wire	
	Material	PVC (Siliconefree)	
	Colour	White marker with transparent sleeve	
	Inflammability class according to UL 94	V0	
Compatibility	Temperature range [°C]	-50 ... +80	
	Mounting position	For conductor diameter 2 mm up to 8 mm	
	Marking elements	Clip-on to the cable	
		With any of the NSYTRABCP● marking elements	
Marking collars and inserts			
Marking collars		Sold in lots of	Unit reference
for conductor diameter	2 to 3.5 mm	500	NSYTRABCV23
	3 to 5 mm	500	NSYTRABCV35
	5 to 8 mm	500	NSYTRABCV58
Marking inserts, A4 format, perforated			
Colour	White	-	-
Marking card with 50 inserts			
Colour	White	-	-

Marking accessories

PB502051-30

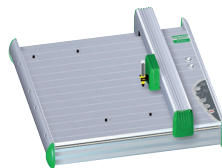

		NSYTRAPLOT	
		Plotter	
		<ul style="list-style-type: none"> ■ A flexible plotter that helps you label marking elements quickly and easily. ■ Rugged construction in stylish aluminium ■ Easy to change fixtures to suit a variety of marking elements ■ Auto calibration no adjustment necessary ■ Including NSYTRA BMP1 / BMP2 adaptor plates, 0.25 & 0.35 mm black pens, Spacial.print software, power supply, connecting cables, user manual 	
Printing area		A4	
Input voltage/ frequency		100 - 240 V AC, 50/60 Hz	
Interface		USB 2.0	
Operating system		MS Windows XP/Vista/7	
Compatibility		For all NSYTR blank marking cards	
Marking collars and inserts			
Marking plotter		Sold in lots of	Unit reference
Colour	Grey	1	NSYTRAPLOT
Accessories			
		Sold in lots of	Unit reference
Adaptor plates	For NSYTRABPV● , NSYTRAXPV* and NSYTRABCP5 marking cards	1	NSYTRABMP1
Pen, disposable	0.25 mm line, black	1	NSYTRAPEN2
	0.35 mm line, black	1	NSYTRAPEN3

(1) Can print ZBY0102; ZBY0501 and ZBY0502 marking elements and all marking sheets: NSYTRABCV●; ZBY4100; ZBY001; ZBY5100 and ZBY1101.

Linery TR

Marking accessories

PB602352-28



NSYTRABC●

Marking inserts for collars

360 inserts for marking collars, A4 format, perforated 15 x 4 mm inserts

Polyester (Silicone and halogen free)

White, yellow, red or blue

V0

40 ... +100

For all **NSYTRABCV●** marking collars

Slides inside the collar sleeve

Can be printed with any office printer, plotter or pen

PB602201-32



NSYTRABCP5

Marking card for collars

Marking card with 50 inserts for marking collars 15 x 4 mm inserts

Polycarbonate

White

V0

-40 ... +120

For all **NSYTRABCV●** marking collars

Slides inside the collar sleeve

Can be printed with plotter or pen

Sold in lots of

Unit reference

-

-

-

-

-

-

10

NSYTRABCP1

Sold in lots of

Unit reference

-

-

-

-

-

-

10

NSYTRABCP5

Marking components (1) (2)

816258

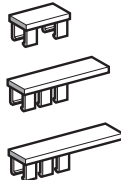

AB1SA●

Blank clip-on marker

Sold in lots of

500

Size mm

Unit reference

4.5 x 8.3

AB1SA1

(1) Can NOT be mounted directly on NSYTR* terminal blocks, need to use the NSYTRABB* adapters!

(2) For Schneider Electric products such as thermal-magnetic circuit-breakers, modular contactors, model D and model E contactors, interfaces. Can also be used with terminal blocks type NSYTR* in association with NSYTRABB* adapters.



Lineryg TR

Mounting and cabling accessories Conforming to standard NF C 63-023 or DIN 46228-4

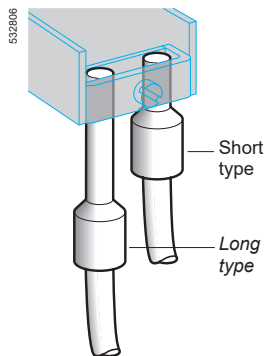

DZ5CE

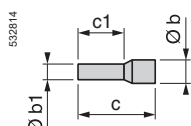

DZ5CE/AZ5CE



AZ5CE●●●

Single conductor cable ends (Packed in individual bags or "strings" of bags)											
Conductor c.s.a.		Type	Dimensions				Sold in lots of	Unit reference NF C 63-023		Unit reference DIN 46228-4	
mm ²	AWG		Ø b	Ø b1	c	c1		Reference	color	Reference	color
0.25	26	Short	2.3	1.1	10	6	10 x 100	DZ5CE002L6	Yellow		
		Medium	2.3	1.1	12	8	10 x 100	DZ5CE002			
0.34	24	Short	2.5	1.1	10	6	10 x 100	DZ5CE003L6	Green		
		Medium	2.5	1.1	12	8	10 x 100	DZ5CE003			
0.5	22	Short	3.1	1.3	12	6	10 x 100	DZ5CE005L6 (1)	White		White
		Medium	3.1	1.3	14	8	10 x 100	DZ5CE005 (1)			
		-	-	-	-	-	-	-			
0.75	20	Short	3.3	1.5	12	6	10 x 100	DZ5CE007L6 (1)	Blue		Grey
		Medium	3.3	1.5	14	8	10 x 100	DZ5CE007 (1)			
1	18	Short	3.5	1.7	12	6	10 x 100	DZ5CE010L6 (1)	Red		Red
		Medium	3.5	1.7	14	8	10 x 100	DZ5CE010 (1)			
		Long	3.5	1.7	18	12	10 x 100	DZ5CE010L12 (1)			
1.5	16	Short	4	2	12	6	10 x 100	DZ5CE015L6 (1)	Black		Black
		Medium	4	2	14	8	10 x 100	DZ5CE015 (1)			
		Long	4	2	24	18	10 x 100	DZ5CE0153 (1)			
2	14	Medium	4.2	2.2	14	8	10 x 100	DZ5CE020	Yellow		
2.5	14	Medium	4.7	2.5	14	8	10 x 100	DZ5CE025 (1)	Grey		Blue
		Long	4.7	2.5	24	18	10 x 100	DZ5CE0253 (1)			
4	12	Medium	5.4	3.2	17	10	10 x 100	DZ5CE042 (1)	Orange		Grey
		Long	5.4	3.2	26	18	10 x 100	DZ5CE043 (1)			
6	10	Medium	6.9	3.9	20	12	1 x 100	DZ5CE062 (1)	Green		Yellow
		Long	6.9	3.9	26	18	1 x 100	DZ5CE063 (1)			
		Medium	8.4	4.9	22	12	1 x 100	DZ5CE102 (1)			
10	8	Long	8.4	4.9	28	18	1 x 100	DZ5CE103 (1)	Brown		Red
		Medium	9.6	6.2	24	12	1 x 100	DZ5CE162 (1)			
16	6	Long	9.6	6.2	28	18	1 x 100	DZ5CE163 (1)	White		Blue
		Medium	12	7.7	30	18	1 x 50	DZ5CE252 (1)			
25	4	Long	12	7.7	36	22	1 x 50	DZ5CE253 (1)	Black		
		Medium	13.5	8.7	30	16	1 x 50	DZ5CE352 (1)			
35	2	Long	13.5	8.7	39	25	1 x 50	DZ5CE353 (1)	Red		Red
		Medium	16	11	36	20	1 x 50	DZ5CE502 (1)			
50	0	Medium	16	11	36	20	1 x 50	DZ5CE502 (1)	Blue		Blue

Single conductor cable ends (Packed in dispenser pack)											
0.5	22	Medium	3.1	1.3	14	8	5 x 200	AZ5CE005 (1)	White	AZ5CE005D (1)	White
0.75	20	Medium	3.3	1.5	14	8	5 x 200	AZ5CE007 (1)	Blue	AZ5CE007D (1)	Grey
1	18	Medium	3.5	1.7	14	8	5 x 200	AZ5CE010 (1)	Red	AZ5CE010D (1)	Red
1.5	16	Medium	4	2	14	8	5 x 200	AZ5CE015 (1)	Black	AZ5CE015D (1)	Black
2.5	14	Medium	4.7	2.5	14	8	5 x 200	AZ5CE025 (1)	Grey	AZ5CE025D (1)	Blue

Single conductor cable ends (Strips of 50 packed in bag)											
0.5	22	Medium	3.1	1.3	14	8	10 x 50	DZ5CEB005 (1)	White	DZ5CEB005D (1)	White
0.75	20	Medium	3.3	1.5	14	8	10 x 50	DZ5CEB007 (1)	Blue	DZ5CEB007D (1)	Grey
1	18	Medium	3.5	1.7	14	8	10 x 50	DZ5CEB010 (1)	Red	DZ5CEB010D (1)	Red
1.5	16	Medium	4	2	14	8	10 x 50	DZ5CEB015 (1)	Black	DZ5CEB015D (1)	Black
2.5	14	Medium	4.7	2.5	14	8	10 x 50	DZ5CEB025 (1)	Grey	DZ5CEB025D (1)	Blue

(1) UL certified products.

Lineryy TR

Mounting and cabling accessories Conforming to standard NF C 63-023 or DIN 46228-4

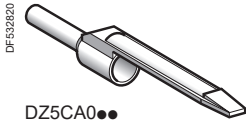

DZ5CA0●●

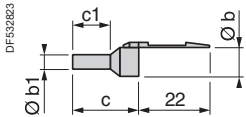

DZ5CA●●●●
(with clip-in marker tag holder)

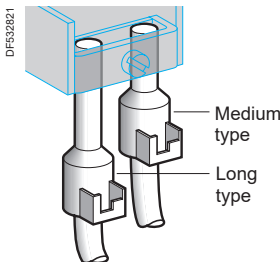

DZ5CA●●●●

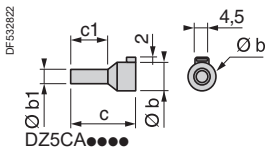

DZ5CA●●●●

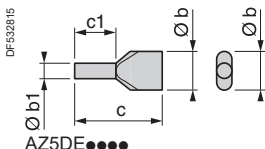

AZ5DE●●●●



DZ5CE●●●●

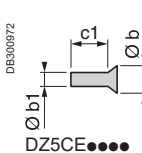

DZ5CE●●●●

Single conductor markable cable ends (Packed in "strings" of bags)

Conductor c.s.a.		Type	Dimensions				Sold in lots of	Unit reference NF C 63-023		Unit reference DIN 46228-4	
mm ²	AWG		Ø b	Ø b1	c	c1		Reference	color	Reference	color
0.25	26	Medium	2.3	1.1	12	8	10 x 100	DZ5CA002	Yellow		
0.34	24	Medium	2.5	1.1	12	8	10 x 100	DZ5CA003	Green		
0.5	22	Medium	3.1	1.3	14	8	10 x 100	DZ5CA005 (1)	White	DZ5CA005D (1)	White
0.75	20	Medium	3.3	1.5	14	8	10 x 100	DZ5CA007 (1)	Blue	DZ5CA007D (1)	Grey
1	18	Medium	3.5	1.7	14	8	10 x 100	DZ5CA010 (1)	Red	DZ5CA010D (1)	Red
1.5	16	Medium	4	2	14	8	10 x 100	DZ5CA015 (1)	Black	DZ5CA015D (1)	Black
2.5	14	Medium	4.7	2.5	14	8	10 x 100	DZ5CA025 (1)	Grey	DZ5CA025D (1)	Blue

Single conductor cable ends with facility for clip-in marker tag holder

4	12	Medium	5.4	3.2	20	12	10 x 100	DZ5CA042 (1)	Orange	DZ5CA042D (1)	Grey
		Long	5.4	3.2	26	18	10 x 100	DZ5CA043 (1)			
6	10	Medium	6.9	3.9	20	12	1 x 100	DZ5CA062	Green	DZ5CA062D	Yellow
		Long	6.9	3.9	26	18	1 x 100	DZ5CA063			
10	8	Medium	8.4	4.9	22	12	1 x 100	DZ5CA102	Brown	DZ5CA102D	Red
		Long	8.4	4.9	28	18	1 x 100	DZ5CA103			
16	6	Medium	9.6	6.2	24	12	1 x 100	DZ5CA162	White	DZ5CA162D	Blue
		Long	9.6	6.2	28	18	1 x 100	DZ5CA163			
25	4	Medium	12	7.7	30	18	1 x 100	DZ5CA253	Black	DZ5CA253D	Yellow
35	2	Medium	13.5	8.7	30	16	1 x 20	DZ5CA352	Red	DZ5CA352D	Red
		Long	13.5	8.7	39	25	1 x 20	DZ5CA353			
50	0	Medium	16	11	36	20	1 x 20	DZ5CA502	Blue	DZ5CA502D	Blue
		Long	16	11	40	25	1 x 20	DZ5CA503			

Twin conductor cable ends (in dispenser pack)

2 x 0.75	20	Medium	2.8x5	2	15	8	5 x 100	AZ5DE007 (2)	Blue	AZ5DE007D (1)	Grey
2 x 1	18	Medium	3.4x5.4	2.25	15	8	5 x 100	AZ5DE010 (2)	Red	AZ5DE010D (1)	Red
2 x 1.5	16	Medium	3.6x6.6	2.5	15	8	5 x 100	AZ5DE015 (2)	Black	AZ5DE015D (1)	Black
2 x 2.5	14	Medium	4.2x7.8	3.2	18.5	10	5 x 50	AZ5DE025 (2)	Grey	AZ5DE025D (1)	Blue

Twin conductor cable ends (packed in 1 plastic bag)

2 x 0.5	22	Medium	2.5x4.7	1.7	15	8	1 x 1000	AZ5DE005 (2)	White		
2 x 0.75	20	Medium	2.8x5	2	15	8	1 x 1000	AZ5DE0071 (2)	Blue		
2 x 1	18	Medium	3.4x5.4	2.25	15	8	1 x 1000	AZ5DE0101 (2)	Red		
2 x 1.5	16	Medium	3.6x6.6	2.5	15	8	1 x 1000	AZ5DE0151 (2)	Black		
2 x 2.5	14	Medium	4.2x7.8	3.2	18.5	10	1 x 500	AZ5DE0255 (2)	Grey		

Single conductor uninsulated cable ends

Conductor c.s.a.		Type	Dimensions				Sold in lots of	Unit reference DIN 46228-1	
mm ²	AWG		Ø b	Ø b1	c	c1		Reference	
0.75	20	Medium	2.3	1.2	--	8	10 x 100	DZ5CE007N	
1	18	Medium	2.5	1.4	--	8	10 x 100	DZ5CE010N	
1.5	16	Medium	2.8	1.7	--	8	10 x 100	DZ5CE015N	
2.5	14	Medium	3.4	2.2	--	10	10 x 100	DZ5CE025N	
4	12	Medium	4	2.8	--	12	1 x 100	DZ5CE040	
		Long	4.7	3.5	--	12	1 x 100	DZ5CE060	
6	10	Medium	4.7	3.5	--	18	1 x 100	DZ5CE060L	
		Long	4.7	3.5	--	18	1 x 100	DZ5CE100	
10	8	Medium	5.8	4.5	--	18	1 x 100	DZ5CE100	
16	6	Medium	7.5	5.8	--	18	1 x 100	DZ5CE160	

(1) UL certified products.
(2) cCSAus certified products.



Linery TB

Earth bars

DD381516-LIN

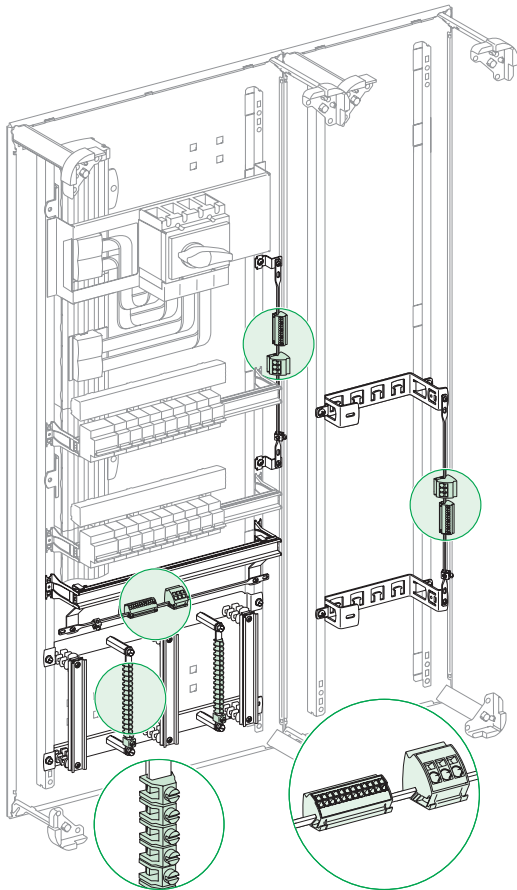

Description

This range of earth bars is installed:

- in the duct which can constitute a dedicated area, completely separate from the equipment
- or in the switchgear compartment, at the top or the bottom

Fast-connecting earth bar

DD381516-LIN

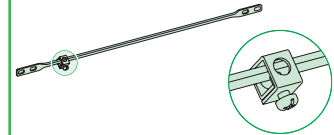

Copper earth bar

Cross-section (mm)	12 x 3
Effective length (mm)	330
Total length (mm)	450
Composition	Copper bar with 1 terminal 16 to 35 mm ²
References	LVS04201

Accessories

DD381516-LIN

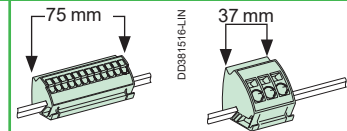

Earth blocks with terminals

Spring-fixing (clip onto the earth bar)

Total connection capacity	12 x 4 mm ²	3 x 16 mm ²
Composition	4 earth blocks	4 earth blocks
References	LVS04214	LVS04215

Accessories

DD381516-LIN

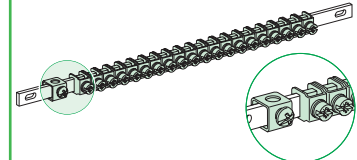

Earth bar with jumper

Total connection capacity	40 x 2.5 to 16 mm ²	20 x 2.5 to 16 mm ²
Cross-section (mm)	12 x 13	12 x 13
Length (mm)	450	200
Composition	40 jumpers and a terminal (16 to 35 mm ²)	20 jumpers and a terminal (16 to 35 mm ²)
References	LVS04200	LVS04202

Accessories

DD381519-LIN

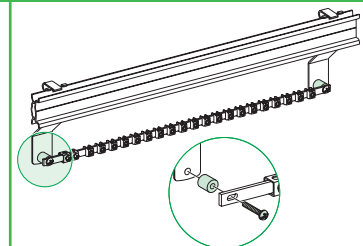

Neutral bar

Converts an earth bar to a neutral bar

Composition	2 insulating spacers
References	LVS04210

Linergy TB PF conductors

PE conductors

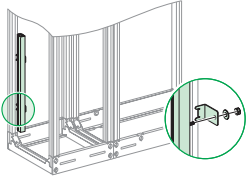
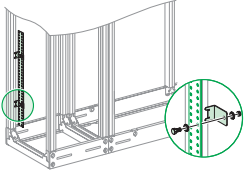
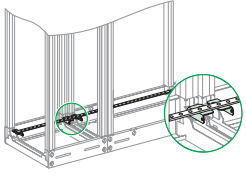
						
	DD381163-LIN		DD381162-LIN		DD381164-LIN	
	Vertical PE conductor with Linergy LGY profile (W = 1670 mm)		Vertical PE conductor with Linergy BS busbar (W = 1675 mm)		Horizontal PE conductor with Linergy BS busbar	
Rated short-time current (I _{cw})	≤ 40	> 40	≤ 40	> 40	≤ 40	> 40
Permissible current (A)	630	800				
Cross-section (mm)			25 x 5	50 x 5	25 x 5	50 x 5
References	LVS04502	LVS04503	LVS04512	LVS04515	LVS04512	LVS04515

Support selection

Composition	Three supports for a vertical PE (supplied with PE marking), to be screwed onto the framework	Three supports for a vertical PE (supplied with PE marking), to be screwed onto the framework	Two supports for a horizontal PE
References	LVS04657	LVS04657	LVS04667

Connection between PE conductors

		
	DD381165-LIN	
	Connection plates for horizontal/vertical PE bars	Linergy connection hardware
Composition	2	20 M8 screws (W = 25 mm) + 20 nuts + 20 contact washers for connection to cable lugs or flexible bars
References	LVS04672	LVS04766



Linergy TA

Auxiliary connections

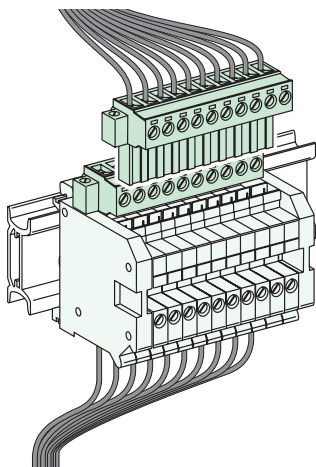

Description

For distributing auxiliary voltages in power and regulation equipment.

Terminal block for auxiliary wiring

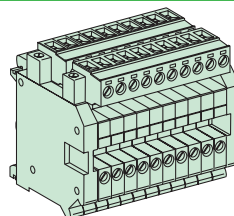

Standards		IEC	UL
Rated operational current at 40°	(Ie)	12 A	20 A
Rated operational voltage	(Ue)	250 V	300 V
Rated impulse withstand voltage	(Uimp)	4 kV	
Connection capacity	Input	10 (grey)	
	Output	2 x 10 (grey)	
Dimensions (HxWxD)	(mm)	61 x 48 x 45	
Cross-section		0.2 to 4 mm	
Tightening torque		0.5 to 0.6 Nm	
Composition		3.5 18-mm modules	
References		LVS04228	

Four-pole auxiliary bus duct

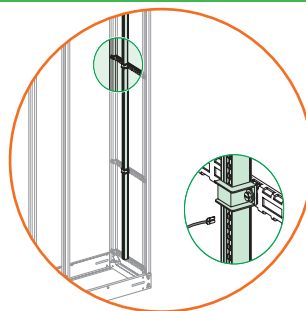

		Duct for 4 conductors
		166 tap-off points with Faston connectors, per linear meter
Rated operational current at 40°	(Ie)	32 A
Rated insulation voltage	(Ui)	660 V
Length (mm)		1755
Composition		Supplied with 2 end clamps and 1 lateral clamp for mounting on cable-tie supports
References		LVS04203



How to find more technical information?



All technical information about products listed in this guide are now available on: www.se.com

Browse the "product datasheet" to check out:

- > Characteristics
- > Dimensions
- > And also links to user guides, curves, CAD files...

From the home page, type the product reference into the "Search" box.



Example

Then, clic on the green reference

The product datasheet appears with the technical data and product characteristics at the bottom of the page.



Access to related downloads



You can get this information in one pdf file.



Life Is On

Schneider
Electric

Schneider Electric Industries SAS

35, rue Joseph Monier
CS 30323
92506 Rueil Malmaison Cedex
France

RCS Nanterre 954 503 439
Capital social 896 313 776 €
www.se.com

05-2024
LVYED213001EN

© 2024 - Schneider Electric. All Rights Reserved.
All trademarks are owned by Schneider Electric Industries SAS or its affiliated companies.
Document reference: SP0368101-00

This document has been
printed on recycled paper

