

PacT Series
TransferPacT

Catalog 2024
Transfer Switching Equipment
Source-Changeover Systems

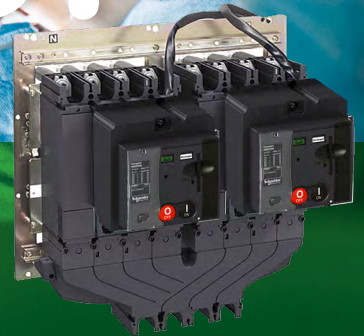



Green Premium™

An industry leading portfolio of offers delivering sustainable value



More than 75% of our product sales offer superior transparency on the material content, regulatory information and environmental impact of our products:

- RoHS compliance
- REACH substance information
- Industry leading # of PEP's*
- Circularity instructions

The Green Premium program stands for our commitment to deliver customer valued sustainable performance. It has been upgraded with recognized environmental claims and extended to cover all offers including Products, Services and Solutions.

CO₂ and P&L impact through... Resource Performance

Green Premium brings improved resource efficiency throughout an asset's lifecycle. This includes efficient use of energy and natural resources, along with the minimization of CO₂ emissions.

Cost of ownership optimization through... Circular Performance

We're helping our customers optimize the total cost of ownership of their assets. To do this, we provide IoT-enabled solutions, as well as upgrade, repair, retrofit, and remanufacture services.

Peace of mind through... Well-being Performance

Green Premium products are RoHS and REACH compliant. We're going beyond regulatory compliance with step-by-step substitution of certain materials and substances from our products.

Improved sales through... Differentiation

Green Premium delivers strong value propositions through third-party labels and services. By collaborating with third-party organizations we can support our customers in meeting their sustainability goals such as green building certifications.



Discover what we mean by green
Check your products!

*PEP: Product Environmental Profile (i.e. Environmental Product Declaration)

Legal Information

The information provided in this catalog contains description of Schneider Electric products, solutions and services (offer) with technical specifications and technical characteristics of the performance of the corresponding offer.

The content of this document is subject to revision at any time without notice due to continued progress in methodology, design, and manufacturing.

To the extent permitted by applicable law, no responsibility or liability is assumed by Schneider Electric and its subsidiaries for any type of damages arising out of or in connection with

(i) informational content of this catalog not conforming with or exceeding the technical specifications

(ii) any error contained in this catalog

(iii) any use, decision, act or omission made or taken on basis of or in reliance on any information contained or referred to in this catalog.

SCHNEIDER ELECTRIC MAKES NO WARRANTY OR REPRESENTATION OF ANY KIND, WHETHER EXPRESS OR IMPLIED, AS TO WHETHER THIS CATALOG OR ANY INFORMATION CONTAINED THEREIN SUCH AS PRODUCTS AND SERVICES WILL MEET REQUIREMENTS, EXPECTATIONS OR PURPOSE OF ANY PERSON MAKING USE THEREOF.

Schneider Electric brand and any trademarks of Schneider Electric and its subsidiaries referred to in this catalog are property of Schneider Electric or its subsidiaries. All other brands are trademarks of their respective owners.

This catalog and its content are protected under applicable copyright laws and provided for informative use only. No part of this catalog may be reproduced or transmitted in any form or by any means (electronic, mechanical, photocopying, recording, or otherwise), for any purpose, without the prior written permission of Schneider Electric.

Copyright, intellectual, and all other proprietary rights in the content of this catalog (including but not limited to software, audio, video, text, and photographs) rests with Schneider Electric or its licensors. All rights in such content not expressly granted herein are reserved. No rights of any kind are licensed or assigned or shall otherwise pass to person accessing this information.

Trademarks

QR Code is a registered trademark of DENSO WAVE INCORPORATED in Japan and other countries.



A transfer switching equipment is indispensable:

For critical applications in particular
For all others in general



A transfer switching equipment is indispensable for applications that need a continuous supply of electric power (hospitals, airports, banks, government facilities, etc.).

However transfer switching equipment is also suitable for all LV electrical installations exposed to:

- > **Nominal voltage loss or dip (when there is high demand for electric power)**
- > **Unpredictable power quality**



> **Frequent power cuts**

These factors, and many others, can damage the continuity of service of your electrical installation.

For infrastructure managers, a source-changeover system gives direct economic benefits. It is possible to select your source based on power cost.

In this case, the replacement source is used as an alternative, more economical source.

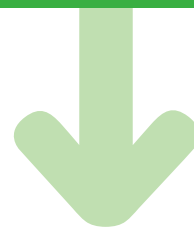

- > **Managing energy efficiently**
- > **Power Cost**
- > **Safety**

Where backup supply must be reliable: now that is everywhere

Electricity is the fuel that feeds economic activity. Very few operations can withstand the financial impact of an electrical stoppage.

For occupant comfort, business continuity, and worker/visitor safety, dependability levels that used to apply to hospitals or airports are now becoming required in shopping malls and offices.

Additionally, utility companies make their contracts more sophisticated to deal with energy concerns. For example, including time restrictions to total accessible power.

For these reasons, backup power sources expand across all types of buildings, and require high performance connection and management.

Enabling you to meet these challenges, TransferPacT comes as the natural continuation of the world leading low voltage distribution system developed by Schneider Electric.





\$740 000

average cost per event of
unplanned downtime in a
data center

Source

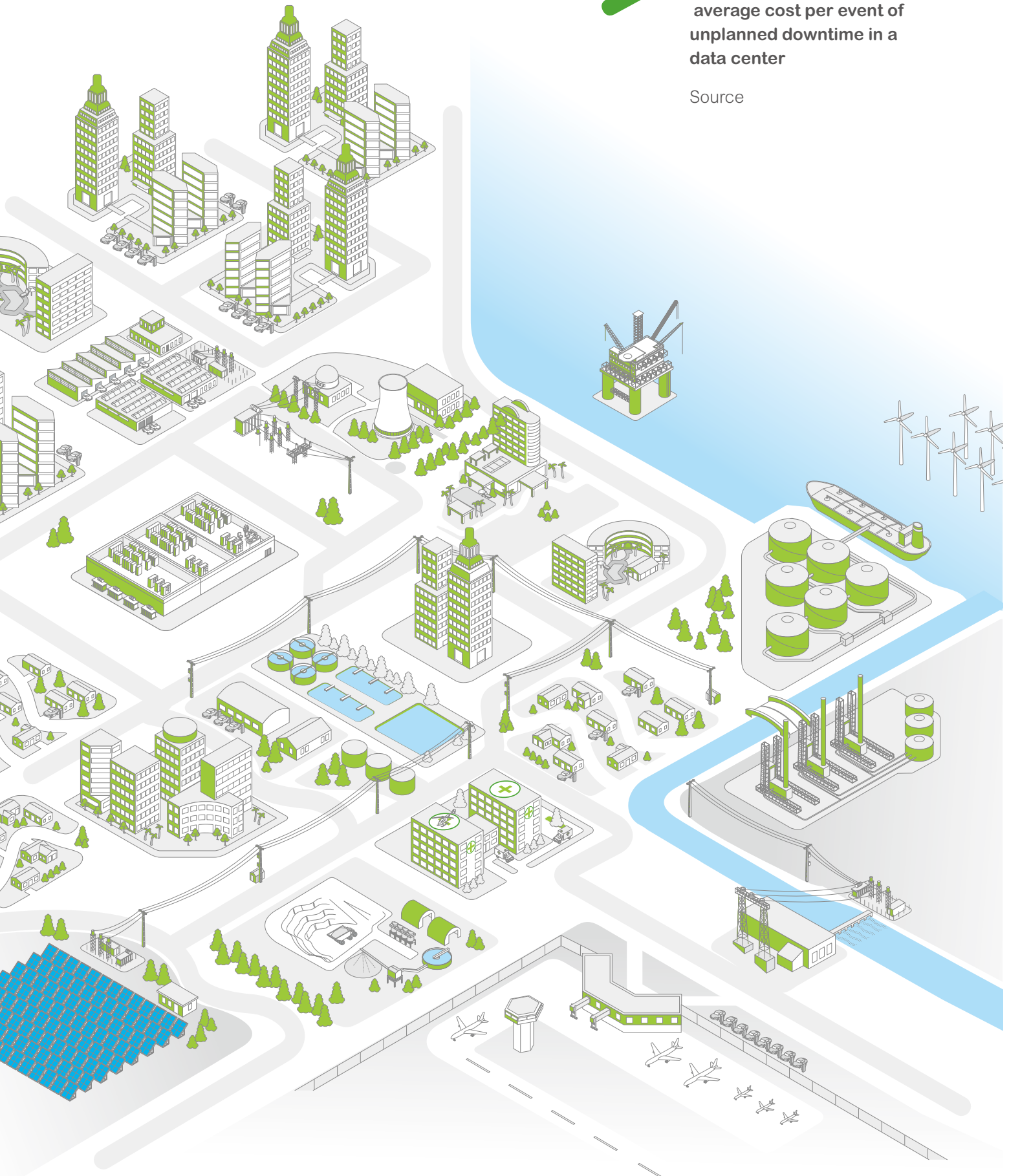

3 ways to switch the load to meet your needs

①

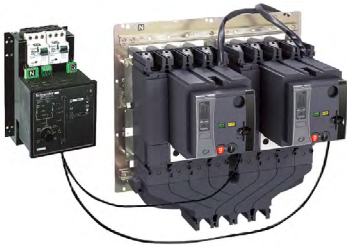

Automatic Source-Changeover System (or ATSE: Automatic Transfer Switching Equipment)

An automatic controller may be added to a remote-operated source-changeover system. It is possible to automatically control source transfer according to programmed (dedicated controllers) or programmable (PLC) operating modes. These solutions ensure optimum energy management.

System

Derived ATSE: Two or three circuit breakers that may have different configurations, linked by an electrical interlocking system. A mechanical interlocking system protects against electrical malfunctions or incorrect manual operations, with an automatic control system (dedicated controllers or PLC).

Non-derived ATSE: Specifically designed ATSE with a specific controller for the system. A mechanical interlocking system is standard for product which protects against electrical malfunctions or incorrect manual operations.

②



Manual Source-Changeover System (or MTSE: Manual Transfer Switching Equipment)

A very simple way to switch the load. It is controlled manually by an operator. The time required to switch from the 'N' source to 'R' source can vary.

System

Two or three mechanically interlocked manually-operated circuit breakers or two switch-disconnectors.

③



Remote-Operated Source-Changeover System (or RTSE: Remote Transfer Switching Equipment)

The most commonly used system for devices with high ratings. No direct human intervention is required. Source-changeover is controlled electrically.

System

Derived RTSE: Two or three circuit breakers that may have different configurations, linked by an electrical interlocking system. In addition, a mechanical interlocking system protects against electrical malfunctions or incorrect manual operations.

Non-Derived RTSE:

Specifically TSE that is electrically operated and not self-acting. A mechanical interlocking system is standard for product which protects against electrical malfunctions or incorrect manual operations.



Applications

Commercial and service sector industry and infrastructure (operating rooms in hospitals, safety systems for buildings, computer rooms for banks and insurance companies, lighting and emergency lighting systems in malls, etc.)



Buildings and infrastructure where the need for continuity of service is significant but not a priority: offices, small and medium-sized businesses.

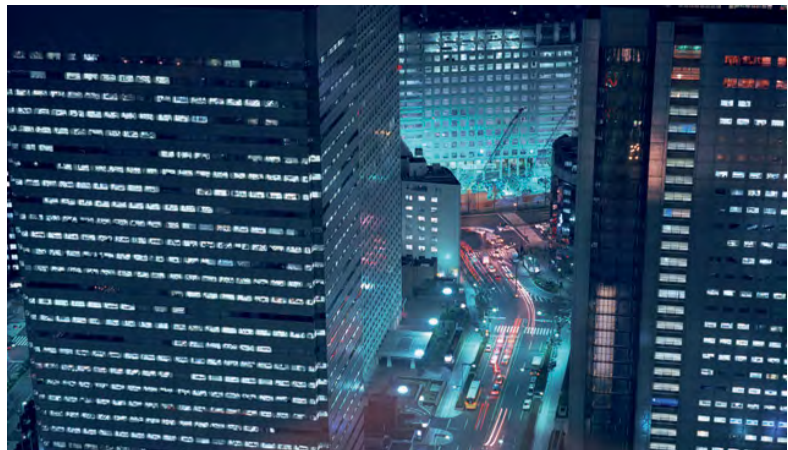

Industry like assembly lines, engine rooms on ships, critical auxiliaries in thermal powerstations, etc.

Infrastructure like port and railway installations, runway lighting systems, control systems on military sites, etc.

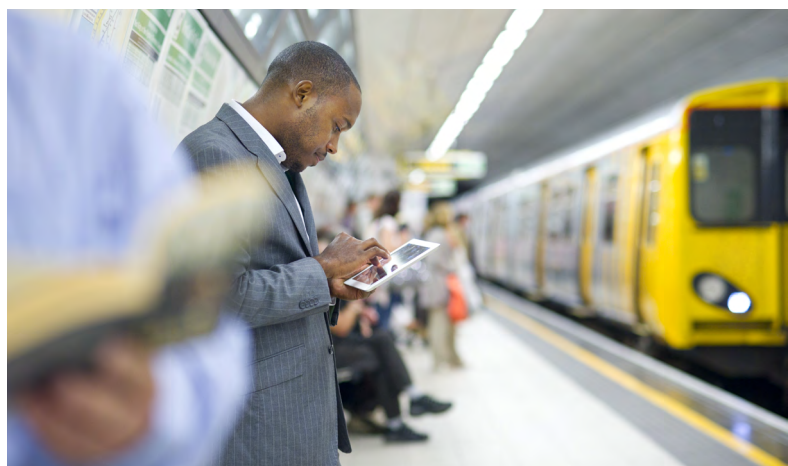

Whatever the system, you benefit from our expertise!



For many years Schneider Electric's source changeover system have proved their reliability everywhere around the world, in most power dependable buildings. Switching is performed by ComPacT or MasterPacT circuit breakers, the ultimate references in industrial switchgear.

Maximized Continuity of Service

- > Energy availability is ensured whatever is the external requirements (e.g. high power demand).
- > Maintenance and replacement of the sources (N or R) can be done with no interruption of service.

You can maintain a continuous level of service and customer satisfaction.

Maximized Safety

For LV electrical installations where safety and continuity of service are critical for people and/or equipment such as hospitals, airports, banks, malls, etc.

Optimized Energy Management

- > Transfer the load to a replacement source according to external requirements.
- > Manage power sources according to power quality and power costs.
- > Perform system regulation.
- > Switch to an emergency replacement source.

You are no longer dependent on your power supply (and supplier)

Simplicity and Reliability

- > Simple installation on LV switchboard.
- > Optimized size of the switchboard.
- > System based on pre-tested components.
- > Compliance with IEC 60947-6-1.

Other Information

TransferPacT Automatic



> LVPED216028EN

ComPacT NSXm - NSX



> LVPED217032EN

ComPacT INS/INV



> LVPED213024EN

ComPacT NS



> LVPED211021EN

MasterPacT MTZ



> LVPED216026EN

For maximized continuity of service...

Incoming Feeders and Main LV Switchboards

PB115735.eps



Currents
From 630 to 6300 A

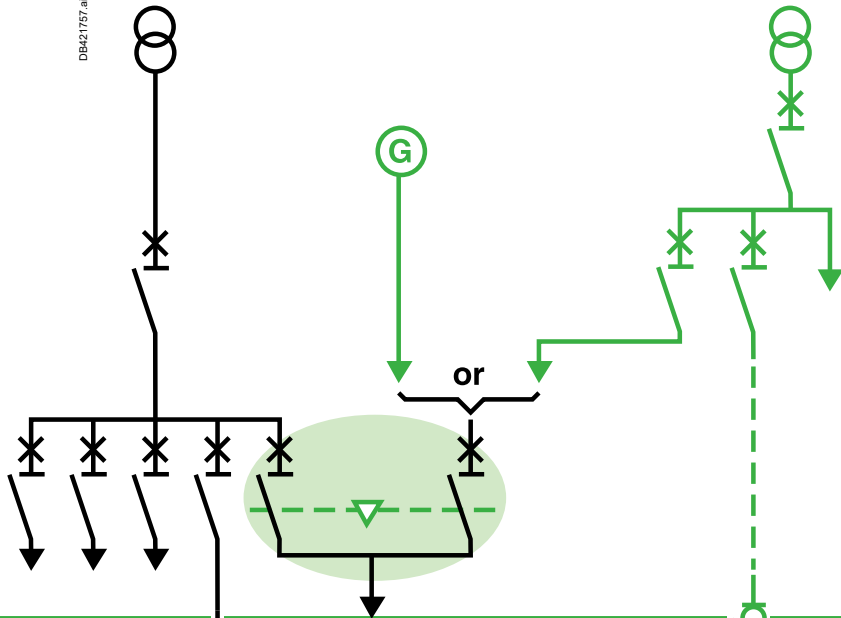

Power Distribution

PrismaSerG.png



Currents
From 250 to 3200 A

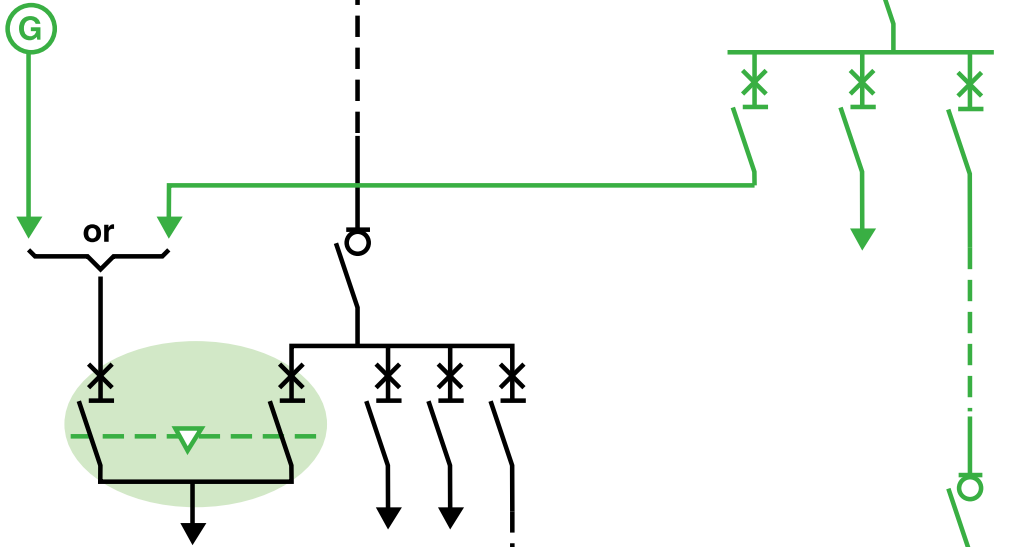

Loads

PB93346.eps



Currents
From 40 to 400 A

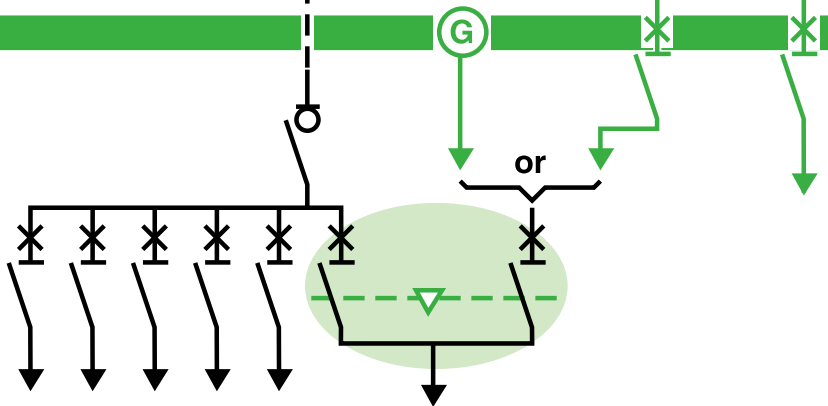

... in a wide range of applications

1 normal source
1 replacement source

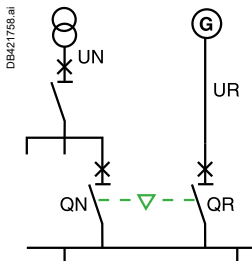

QN	QR
0	0
1	0
0	1

2 sources with coupler on busbars

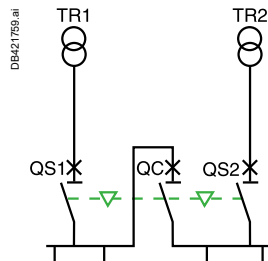

QS1	QC	QS2
0	0	0
1	0	1
1	1	0
0	1	1
1	0	0 ⁽¹⁾
0	0	1 ⁽¹⁾

(1) possible by forcing operation

2 normal sources
1 replacement source

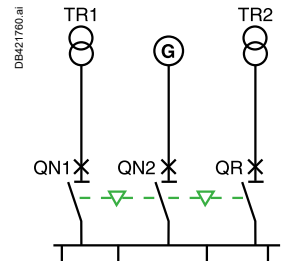

QN1	QN2	QR
0	0	0
1	1	0
0	0	1
1	0	0
0	1	0

Generator or permanent source

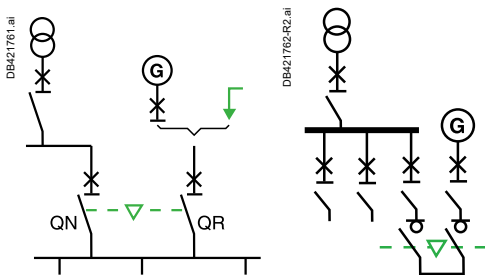

QN	QR
0	0
1	0
0	1

Typical applications:

- Continuous production processes
- Most distribution panels in hospitals, including operating rooms
- Computer rooms

Generator or permanent source

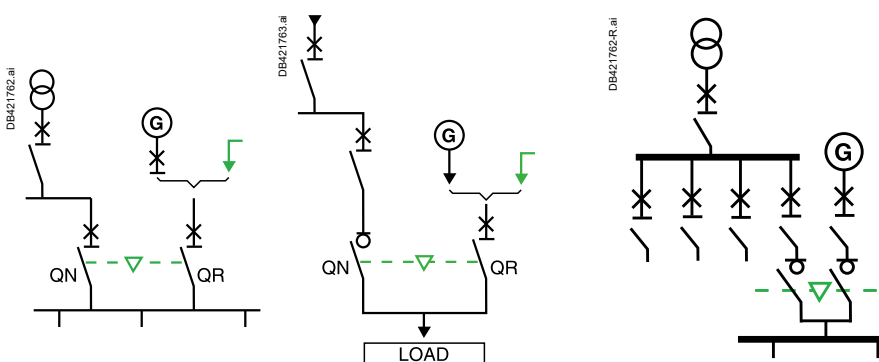

QN	QR
0	0
1	0
0	1

Typical applications:

- Large electrical installations (e.g. airports)
- Refrigeration units
- Special electricity tariffs
- Safety system such as fire alarm, fire pump, safety lifting stations

General Contents

General Contents

TransferPacT

TransferPacT Automatic and Active Automatic

(Automatic Transfer Switching Equipment)

A

TransferPacT Remote

(Remote Transfer Switching Equipment)

B

TransferPacT FXM

(MTSE/Complete Source Changeover Assembly)

C

TransferPacT: ComPacT and MasterPacT based

(Manual, Remote and Automatic TSE/Source Changeover Systems)

D

TransferPacT Automatic and Active Automatic

A

TransferPacT Class PC	A-2
General Features	A-4
Controller General Features.....	A-14
Control Mode and Transfer Logic.....	A-17
Controller Accessories.....	A-48
Electrical and Mechanical Accessories - Frame 100.....	A-51
Electrical and Mechanical Accessories- Frame 160	A-53
Electrical and Mechanical Accessories - Frame 250.....	A-55
Electrical and Mechanical Accessories- Frame 630	A-62
Electrical and Mechanical Accessories- Frame 800	A-67
Electrical and Mechanical Accessories- Frame 1600.....	A-72
Automatic Transfer Switching Equipment.....	A-75
Coding Principle	A-109
References of TransferPacT Active Automatic and Automatic 32-1600 A.....	A-110
Circuit Breaker/Transfer Switching Equipment Coordination	A-115
Fuses/Transfer Switching Equipment Coordination	A-121

TransferPacT Class PC

A

ATSE: Automatic Transfer Switching Equipment
(Non-derived ATSE, PC Type)

ATSE

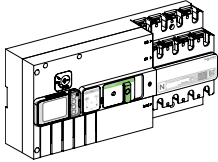

Function Modules

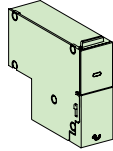

Indication Auxiliaries

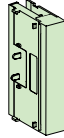

External HMI

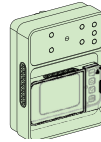

Cable



Definition of Class PC

Transfer switch equipment based on mechanical switching devices, that do not need electrical power to hold the main contacts open or closed. They are capable of making, carrying, and breaking currents under normal circuit conditions including operating overload conditions, and making and withstanding short-circuit currents.

Definition of ATSE (Automatic Transfer Switching Equipment)

Self-acting transfer switching equipment, including all necessary sensing inputs, monitoring, and control logic for transferring operations.

TransferPacT automatic transfer switching equipment is a Class PC ATSE specially designed in accordance with IEC 60947-6-1 requirements for power transfer. It has great withstand capabilities to short circuits and reliable making, carrying and breaking capabilities. Thus keeping reliable connectivity of circuits.

It is an all in one, Non-derived ATSE.

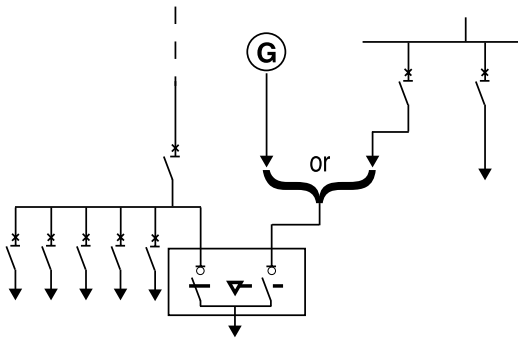

TransferPacT Class PC

TransferPacT is a high speed, comPacT, modular design intelligent automatic transfer switch that provides maximum scalability and robust performance. It is a Class PC ATSE designed according to IEC 60947-6-1, available through 32 A to 1600 A, 2,3,4 pole with rated operating voltage through 208 V to 440 V*.

*Note: Voltage varies depending on different frame. For more information, see general feature section.

A



Power availability

Maximized uptime:

Innovative technology ensuring transfer in less than 500 ms.

Vast application:

Utilization category AC-33B without derating, fits the most complicated load types.

Reliable under extreme condition:

Short circuit capabilities including short time withstand current for your power continuity.

Robust design – Extreme Environment Proof:

- Best-in-class electromagnetic protection, exceeding industry standards on class B.
- Designed to perform in harsh environments with operating temperature -25...70 °C
- Successfully passed testing in compliance with IEC 60068-2-6 and IEC 60068-2-27.



Efficiency

Easy installation:

- Built-in DPS and sensing wire, 30% of commissioning time saving.
- Multiple installation adapted. E.g. DIN rail for 32 A ~160 A (TA10, TA16).

Enhanced scalability:

- 10 function modules plug and play, non-disruption upgrading.



Connectivity

Natively connected – Integrated in EcoStruxure™ Power

- 24/7 precise power monitoring on voltage, frequency, voltage unbalance, phase rotation.



Cyber security

Designed according to cyber security standard IEC 62443 at the level of SL1.



Sustainability

Green premium ecolabel.

- Green Package for full product range.
- Saving trees - Scan QR code for full version for technical documents.

General Features

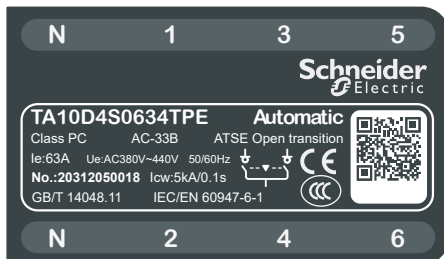
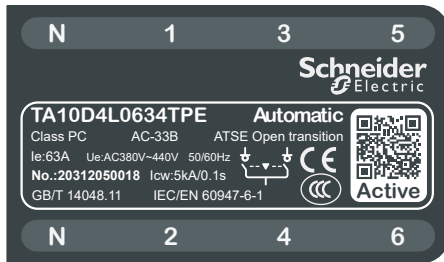

Codes and Standard

- IEC 60947-1 General rules
- IEC 60947-6-1 Transfer switching equipment
- GB 14048.1 General rules
- GB/T 14048.11 Transfer switching equipment

Certifications and Declarations

- CB certification
- CE certification
- CCC certification
- UKCA declaration

Environmental Conditions

- TransferPacT ATSE can operate in an ambient temperature of $-25\text{ }^{\circ}\text{C} \sim +70\text{ }^{\circ}\text{C}$
- The altitude of the installation site shall not exceed 2000 m
- When the highest temperature is $+55\text{ }^{\circ}\text{C}$, the relative humidity in air shall not exceed 95%
- Storage temperature: $-40\text{ }^{\circ}\text{C} \sim +85\text{ }^{\circ}\text{C}$

Vibration and Shock

- Tests are carried out in compliance with IEC 60068-2-6 and IEC 60068-2-27

Electromagnetic Compatibility (EMC)

- EMC Class A
- EMI Class B
- Electrostatic discharge Level 4
- Radio-frequency electromagnetic field Level 3
- Fast transient bursts Level 4
- Surges Level 4
- Harmonic wave Level 3
- Voltage dips and short-time interruptions Level 3

Degree of Pollution

- Pollution degree 3 as defined by IEC standard 60947

General Features

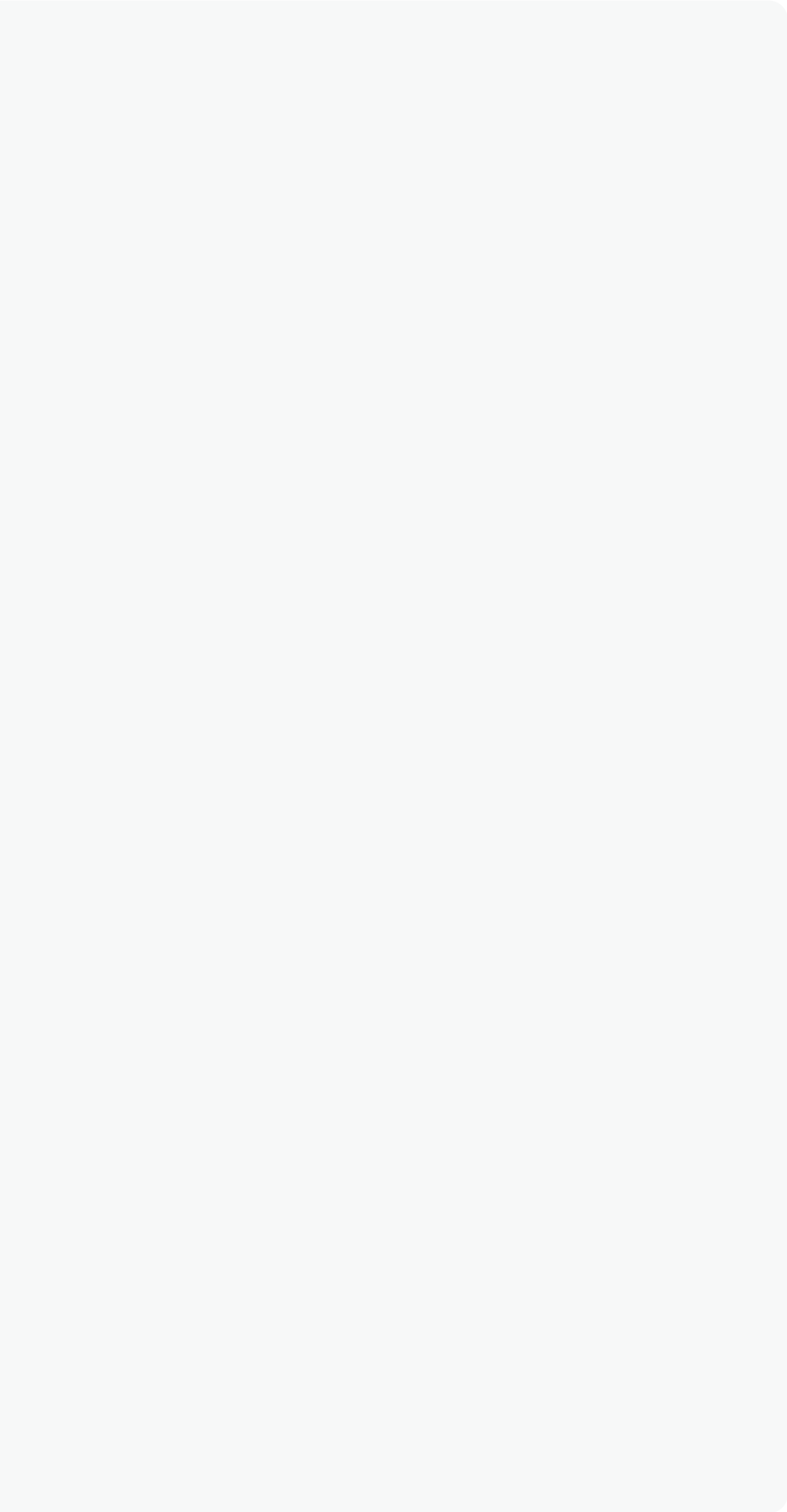

General Features



TransferPacT Active Automatic



TransferPacT Automatic

TransferPacT Automatic /TransferPacT Active Automatic

Frame		
Conventional Thermal Current	I _{th}	at 60 °C
Rated operating current (A)	I _e	AC-33B
		AC-32B
Number of poles		
Operating positions		
Control types		

Electrical Characteristics as Defined by IEC 60947-1 / 60947-6-1 and EN 60947-1 / 60947-6-1

Rated insulation voltage (V)	U _i	
Rated impulse withstand voltage (kV)	U _{imp}	
Rated operating voltage (V)	U _e	AC50/60 Hz
Rated operating frequency (Hz)	F	
Rated short-time withstand current (kA)	I _{cw}	
Rated short-circuit making capacity (400 V, 50 Hz)	I _{cm}	switch alone
		with upstream circuit breaker
Rated duties		Uninterrupted duty
Contact Transfer Time* (I -> II or II -> I)		
I -> II or II -> I transfer time*, after power loss		
Mechanical durability		
Controller life expectancy (years)		
Suitability for Isolation		

Installation and Connection- Fixed, Front Connection

Installation
Wiring

Switch Accessories

Position feedback(Auxiliary contact)	
Terminal cover	
Rail buckle	
Terminal Shield	
Load extension bars	
Interphase barrier	
Degree of pollution	
Upstream protection	Refer to Complementary technical information
Dimensions and weights	
	2pole
Overall dimensions W x H x D (mm)	3pole
	4pole
	2pole
Approximate weight (kg)	3pole
	4pole
	2pole

Note:
 Standard Optional
 (1) default 230 V/400 V
 * : Transfer times are at rated voltage, excluding time delays when applicable
 **: suitable for normal and upside down installation
 For the upstream protection coordination with transfer switching equipment, refer to coordination tables in page A55-A59 or complementary technical guid.

General Features



	TA10	TA16
	100	160
	100	160
	32,40,50,63	80,100,125,160
	80,100	
	2/3/4	3/4
	3	3
	Active Automatic HMI/ Automatic HMI	Active Automatic HMI/ Automatic HMI

	TA10	TA16
	800	800
	6	8
	2P:220/230/240/250 V(1) 3P,4P:380/400/415/440 V(1)	3P,4P:380/400/415/440 V(1)
	50/60 Hz	50/60 Hz
	5kA/0.1 s	10kA/0.1 s
	15 kA	20 kA
	75 kA	154 kA
	■	■
	≤ 200 ms	≤ 200 ms
	≤ 500 ms	≤ 500 ms
	8,000	10,000
	10	10
	■	■

	TA10	TA16
	Rail/base plate**	Rail/base plate**
	busbar /Cable	Busbar/crimp lug

	TA10	TA16
	□	□
	■	■
	■	■
	□	□
	□	□
	-	□
	3	3

	310 x 155 x 94	
	310 x 155 x 94	351 x 164 x 95
	310 x 155 x 94	351 x 164 x 95
	3.4	-
	3.4	5.6
	3.4	5.6

General Features



TransferPacT Active Automatic



TransferPacT Automatic

TransferPacT Automatic /TransferPacT Active Automatic

Frame		
Conventional Thermal Current	I _{th}	at 60°C
Rated operating current (A)	I _e	AC-33B
Number of poles		
Operating positions		
Control types		

Electrical Characteristics as Defined by IEC 60947-1 / 60947-6-1 and EN 60947-1 / 60947-6-1

Rated insulation voltage (V)	U _i	
Rated impulse withstand voltage (kV)	U _{imp}	
Rated operating voltage (V)	U _e	AC50/60 Hz
Rated operating frequency (Hz)		
Rated short-time withstand current (kA)		
Rated short-circuit making capacity (400 V, 50 Hz)	I _{cm}	switch alone with upstream circuit breaker
Rated duties		
Uninterrupted duty		
Contact Transfer Time* (I -> II or II -> I)		
I -> II or II -> I transfer time*, after power loss		
Mechanical durability		
Controller life expectancy (years)		
Suitability for Isolation		

Installation and Connection- Fixed, Front Connection

Installation		
Wiring		

Switch Accessories

Position feedback(Auxiliary contact)		
Terminal cover		
Rail buckle		
Terminal Shield		
Connection accessories	Crimp lug	
	Connector	
	Terminal Extension	
Interphase barrier		
Tightening torque for electrical connections (Nm)		
Degree of pollution		
Upstream protection	Refer to Complementary technical information	
Dimensions and weights		
Overall dimensions	3pole	
W x H x D (mm)	4pole	
Approximate weight (kg)	3pole	
Note:	4pole	

■ Standard □ Optional

(1). at 50°C

General Features



	TA25	TA63	TA80
	250	630	800
	250	630	800 ⁽¹⁾
	100,200,250	320,400,500,630	800
	3/4	3/4	3/4
	3	3	3
	Active Automatic HMI/ Automatic HMI	Active Automatic HMI/ Automatic HMI	Active Automatic HMI/ Automatic HMI

	TA25	TA63	TA80
	800	800	1000
	8	12	12
	208/220/230/240 V 380/400/415/440 V	208/220/230/240 V 380/400/415/440 V	208/220/230/240 V 380/400/415/440 V
	50/60 Hz	50/60 Hz	50/60 Hz
	15kA/0.1 s 10kA/0.5 s	25kA/0.1 s 20kA/0.5 s	25kA/0.1 s 20kA/0.5 s
	30 kA	40 kA	40 kA
	330 kA	330 kA	330 kA
	■	■	■
	≤ 200 ms	≤ 200 ms	≤ 200 ms
	≤ 500 ms	≤ 500 ms	≤ 500 ms
	10,000	10,000	10,000
	10	10	10

	TA25	TA63	TA80
	Base Plate	Base Plate	Base Plate
	Busbar/Crimp lug/Cable	Busbar/Crimp Lug/Cable	Busbar/Crimp Lug/Cable

	TA25	TA63	TA80
	□	□	□
	Maximum 3 sets	Maximum 3 sets	Maximum 3 sets
	-	-	-
	-	-	-
	□	□	□
	□	□	□
	□	-	□
	□	□	□
	□	□	□
	15±1.5	50±5	50±5
	3	3	3

	370 x 341 x 186	467 x 341 x 186	467 x 341 x 186
	370 x 341 x 186	467 x 341 x 186	467 x 341 x 186
	13.1	20.8	21.4
	13.3	22.1	22.4

General Features



TransferPacT Active Automatic

TransferPacT Automatic /TransferPacT Active Automatic

Frame		
Conventional Thermal Current	I _{th}	at 60°C
Rated operating current (A)	I _e	AC-33B
Number of poles		
Operating positions		
Control types		

Electrical Characteristics as Defined by IEC 60947-1 / 60947-6-1 and EN 60947-1 / 60947-6-1

Rated insulation voltage (V)	U _i	
Rated impulse withstand voltage (kV)	U _{imp}	
Rated operating voltage (V)	U _e	AC50/60 Hz
Rated operating frequency (Hz)	F	
Rated short-time withstand current (kA)	I _{cw}	
Rated short-circuit making capacity (400 V, 50 Hz)	I _{cm}	switch alone with upstream circuit breaker
Rated duties		Uninterrupted duty
Contact Transfer Time* (I -> II or II -> I)		
I -> II or II -> I transfer time*, after power loss		
Mechanical durability (2)		
Controller life expectancy (years)		
Suitability for Isolation		

Installation and Connection- Fixed, Front Connection

Installation		
Wiring		

Switch Accessories

Position feedback(Auxiliary contact)		
Terminal cover		
Rail buckle		
Connection accessories	Crimp lug	
	Connector	
	Terminal Extension	
Interphase barrier		
Tightening torque for electrical connections (Nm)		
Degree of pollution		
Upstream protection	Refer to Complementary technical information	
Dimensions and weights		
Overall dimensions	3pole	
W x H x D (mm)	4pole	
Approximate weight (kg)	3pole	
	4pole	

Note:
 ■ Standard □ Optional
 (1). at 50°C
 (2). durability with maintenance

General Features



TA1A
1600
1600
800,1000,1250,1600
3/4
3
Active Automatic HMI

TA1A
1000
12
380/400/415/440 V
50/60 Hz
70kA/0.1 s 50kA/0.5 s
105 kA
154 kA
■
≤ 200 ms
≤ 500 ms
10,000
10
■

TA1A
Base
Busbar/Crimp lug/Cable

TA1A
□
Maximum 4 sets
-
-
□
□
□
□
50±4
3

540 x 391 x 383.5
540 x 391 x 383.5
800-1250 A: 63.2 ; 1600 A: 65
800-1250 A: 69.5 ; 1600 A: 72

Controller General Features

TransferPacT provides advanced microprocessor controller with two options:

- Active automatic HMI (LCD display and keypad)
- Automatic HMI (Rotary and DIP switch).

It is a robust and reliable controller which offers voltage, frequency, control, timing and diagnostic functions required for wide range of power application.

Automatic HMI is easy to install and use, while active automatic HMI contains every function needed with eight control modes.

There are two key breakthroughs for TransferPacT controller:

- Active automatic HMI and automatic HMI can be swapped, that means an easy way to upgrade your controller, or replace it for maintenance or renewal.
- 10 types of function modules can be installed on TransferPacT controller, at any time, which provides maximum scalability and a reduced total cost of ownership, since you can add a function as demand grows.

Controller Type	Active Automatic With LCD Display	Automatic With Setting By Rotary Switch
Installation	Embedded controller	Embedded controller
Controller Functional Characteristics		
2P (Phase-Neutral)	230 V: can be set at 220 V/240 V/250 V	230 V: can be set at 220 V/240 V/250 V
3P/4P (Phase -Phase)*	230V: Can be set at 208 V/220 V/240 V	-
3P/4P (Phase-Neutral)	400 V: Can be set at 380 V/415 V/440 V	400 V: Can be set at 380 V/415 V/440 V
Rated operating frequency (Hz)	50/60	50/60
Rated insulation voltage (V)		
3P/4P (Phase -Phase)*	300V	-
2P/3P/4P (Phase-Neutral)	500V	500V
Impulse withstand voltage (KV)		
3P/4P (Phase -Phase)*	4 kV	-
2P/3P/4P (Phase-Neutral)	6 kV	6 kV
Operating temperature	-25 °C to +70 °C	-25 °C to +70 °C
Operating altitude	≤2000 m	≤2000 m
Protection degree	IP20/IP40*	IP20
Pollution degree	3	3
Accuracy	Voltage	1%
(for power deviation)	Frequency	0.1%
Electrostatic discharge	Level 4	Level 4**
Radio-frequency electromagnetic field	Level 3	Level 3
Fast transient bursts	Level 4	Level 4
Surges	Level 4	Level 4
Harmonic wave	Class 3	Class 3
Voltage dips and short-time interruptions	Level 3	Level 3
Vibration	IEC 60068-2-6	IEC 60068-2-6
Shock	IEC 60068-2-27	IEC 60068-2-27
Display of Controller		
Display mode	LCD + LED + Indicator	Rotary switch + DIP switch + LED + Indicator
Single line diagram	■	■
Language	English/Chinese/French/Russian/Spanish/ Italian/German/Portuguese	Not Applicable
Power status	■	■
Position for contact (electrical indication)	■	■
Set value	Button	Rotary switch + DIP switch

Note: ■ Standard □ Optional

* IP40 for external HMI

** plastic cover need to close

Controller General Features

Controller Type		Active Automatic With LCD Display	Automatic With Setting By Rotary Switch
Control Mode			
Auto	Auto return	■	■
	Non return	■	■
	Handle	■	■
	Force	□	□
Non-Auto	Fire	□	□
	Inhibit	□	□
	Local	■	-
	Voluntary	□	□
	communication**	■	-
	Test	■	□
Auto Control			
Sampling		Three Phase for both Normal and Alternate	Three Phase for both Normal and Alternate
Voltage loss		< 36 V	< 36 V
Under voltage	Set value	70% to 95%	4%, 6%, 8%, 10%, 12%, 14%, 16%, 18%, 20%
Over voltage	Set value	105% to 135%	4%, 6%, 8%, 10%, 12%, 14%, 16%, 18%, 20%
Under frequency	Set value	80% to 98%	2%, 3%, 4%, 5%, 6%, 7%, 8%, 9%, 10%
Over frequency	Set value	101% to 120%	2%, 3%, 4%, 5%, 6%, 7%, 8%, 9%, 10%
Unbalance of three phase voltage		2% to 30%	-
Phase rotation		Yes	-
Time Delay			
Transfer delay		0-30 minutes	U-U:0, 1, 2, 3, 5, 10, 20, 30, 60 s. U-G:5 s
Retransfer delay		0-60 minutes	0, 1, 2, 3, 5, 10, 20, 30, 60 min
Center off delay		0-30 s	0 or 5 s
Genset start delay		0-120 s	0, 1, 2, 3, 5, 10, 20, 30, 60 s
Genset cooldown delay		0-60 minutes	60 s
Loadshedding delay		0-15 s	-
Genset ready alarm delay		15-300 s	300 s
Test delay:on load		1-1800 s	
Test delay:off load		1-1800 s	
Other Functions			
Calendar time		■	-
Position feedback (mechanical)		□	□
Event log		■	-
Source priority		■	■
Communication		Modbus RTU	-
Transfer Inhibit		□	□
Password protection		■	-
Gen start-stop		□	□
Test		■	□
Load shedding		□	□
Fire protection		□	□
Failure lock		■	■
Alarm Indication		■	■
External power supply port (auxiliary supply)		■	-
Wrong connection of neutral alarm		■	-

Note: ■ Standard □ Optional

** communication transfer only applicable to Frame 250&630&800&1600

A

Controller General Features

Active Automatic HMI (With LCD Display) Description

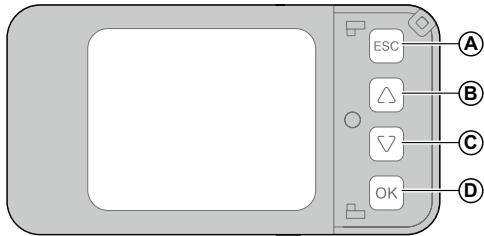

Label	Description
A	Navigation button to return to previous page
B	Navigation button for rolling up
C	Navigation button for rolling down
D	OK button to confirm any status

Automatic HMI (With Rotary Switch) Description

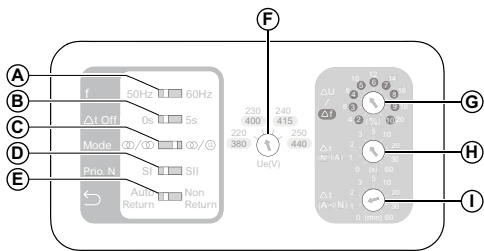

Label	Description
A	Rated frequency
B	Time delay for off position
C	Type of source = Utility/Utility = Utility/Genset
D	Source priority
E	Transition mode for return to normal position
F	Nominal voltage
G	Voltage and frequency thresholds setting
H	Transfer time delay in seconds from normal source to alternate source
I	Transfer time delay in minutes from alternate source to normal source

Controller General Features

Single Line Diagram Description

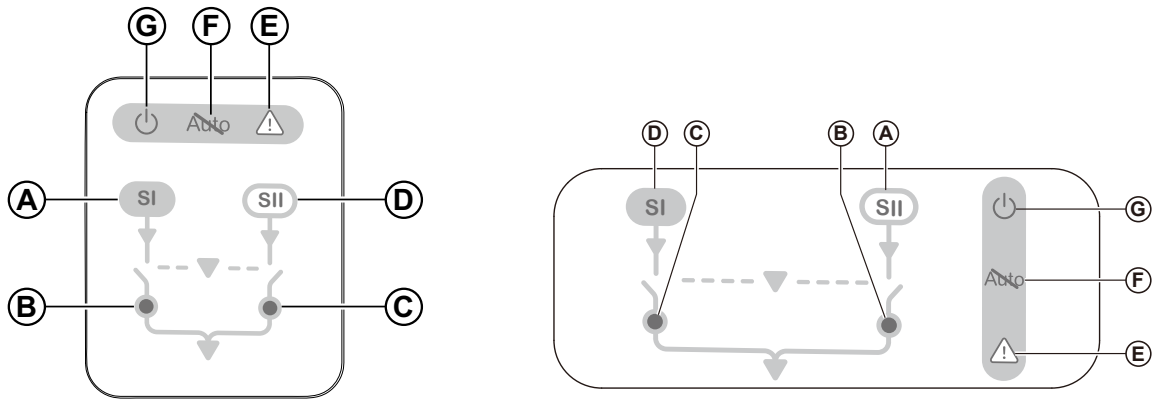

A

Label	Description
A	Source I power status indicator
B	Contact position of source I
C	Contact position of source II
D	Source II power status indicator
E	Alarm indicator
F	"Not in Auto" status indicator
G	Power ON indicator

Controller General Features

Single Line Diagram LEDs

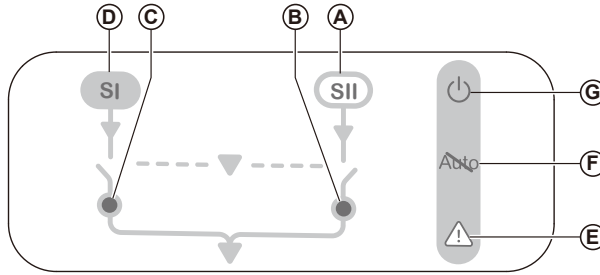
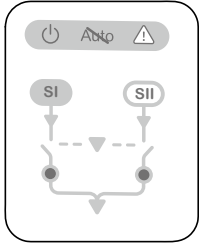

LED Indication	Status	Description
	-----	No energy, ATSE power off
		ATSE updating in process or Test mode in progress
		ATSE is running in normal operation, ready to transfer
	-----	The ATSE is running in Auto mode
		ATSE is "Not in Automatic" mode, and will not automatically transfer in case of source failure.
	-----	No alarm
		Alarm is active
SI	-----	No Source I
		Source I out of range
		Source I present and in the range
SII	-----	No Source II
		Source II out of range
		Source II present and in the range
	-----	Source I is opened (Not connected)
		Time delay is running for transferring
	-----	Source II is opened (Not connected)
	-----	Source II is opened (Not connected)
		Time delay is running for transferring
	-----	Source II is closed (Connected)

NOTE: The LED indicator on the equipment and the external HMI is for reference. In the event of a contradiction between the LED and the mechanical indication, the latter prevails

Control Mode and Transfer Logic Transfer Switching Equipment 32–1600 A

Overview

The control mode is used to operate TSE in different applications. The TransferPacT Active automatic contains every function needed with nine control modes:

- Auto mode
- Test mode
- Communication transfer mode*
- Voluntary transfer mode
- Local control mode
- Transfer inhibit mode
- Fire protection mode
- Force to off mode
- Handle transfer mode

The TransferPacT Automatic contains below control modes:

- Auto mode
- Test mode
- Voluntary transfer mode
- Transfer inhibit mode
- Fire protection mode
- Force to off mode
- Handle transfer mode

* communication transfer for Frame 250 ,Frame 630, Frame 800 and Frame 1600 only.

Priority of Control Mode

Type of mode	Handle	Force	Fire	Inhibit	Local	Voluntary	Comm	Test	Auto
Handle transfer mode	-								
Force to off mode	x	-							
Fire protection mode	x	x	-						
Transfer inhibit mode	x	x	x	-					
Local control mode	x	x	x	x	-				
Voluntary transfer mode	x	x	x	x	x	-			
Comm transfer mode	x	x	x	x	x	x	-		
Test mode	x	x	x	x	x	x	x	-	
Auto mode	x	x	x	x	x	x	x	x	-

“-” = No caution
 “|” = Interrupt
 “X” = Ignore



Control Mode and Transfer Logic

Transfer Switching Equipment 32–1600 A

Auto Control Mode

ATSE works on auto control mode normally. The controller monitors the real time values of both the sources. When there is source contingency, the transfer action will be energized to keep the power continuity for critical source.

Auto mode supports U-G or U-U applications.

NOTE: Auto transfer will not be active, if transfer action damages driving system (for example, both are out of range, TSE refuses to transfer).

There are two types of auto control mode:

- Auto-return
- Non-return

Naming	Condition for Stay on A Situation Return	
power source definition	N available	N available
	A available	A unavailable
Auto-return	Switch to N	Switch to N
Non-return	Stay at A	Switch to N

Auto return

The Auto return has two modes:

- When the voltage on the N source exceeds the threshold (over voltage, under voltage, over frequency, under frequency) or does not exist, the ATSE will be transferred to the A source.
- When the voltage on the N source is within the threshold range, the ATSE will be transferred to N source.

The process of transfer can be controlled by time delay.

Transfer Process for Auto return U-U Application

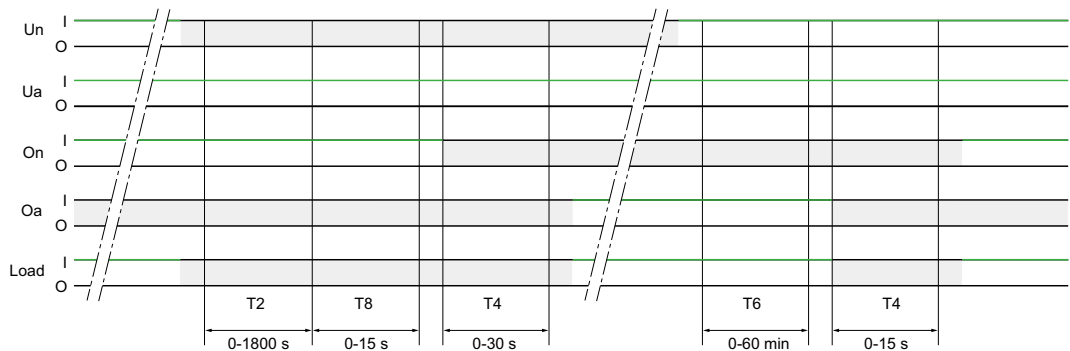

Symbols	Description
Un	Source I
Ua	Source II
On	Contact close at N source
Oa	Contact close at A source
Load	Status
T2	Transfer delay
T8	Loadshed Delay
T4	Center-off Delay

Control Mode and Transfer Logic

Transfer Switching Equipment 32–1600 A

Symbols	Description
T6	Re-Transfer Delay

Key

O: OFF (circuit open)
 I: ON (circuit closed)
 [Grey Box] : no Power



Transfer Logic for Auto-Return U-U Application

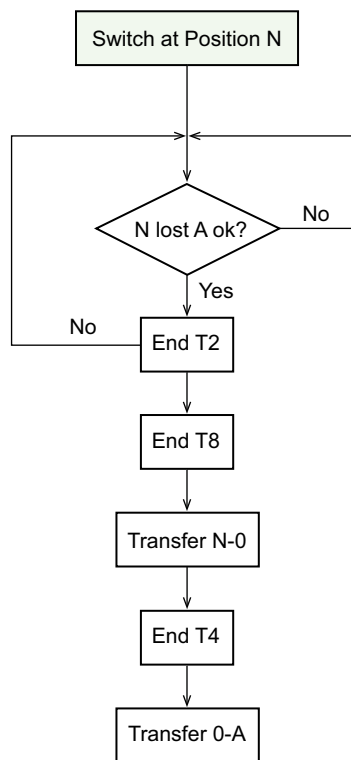

Transfer Logic

* T2 will reset if N becomes unavailable or A becomes unavailable

Control Mode and Transfer Logic

Transfer Switching Equipment 32–1600 A

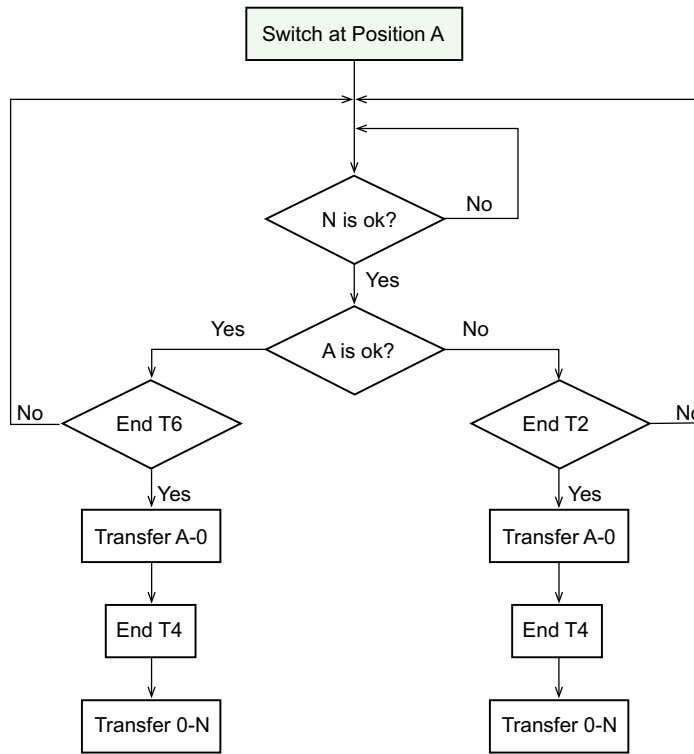

Retransfer Logic

- T2 will reset if N becomes unavailable
- T6 will reset if N becomes unavailable
- During T6, if A is not available it will keep to count T6 if the rest time of T6 is shorter than T2. Other wise it goes to T2

Retransfer principles when source A is ok, retransfer goes to T6, when source A is not ok and source A is utility, retransfer goes to T2. If source A is Genset and is not ok, retransfer delay is 0.

Transfer Process for U-G Application

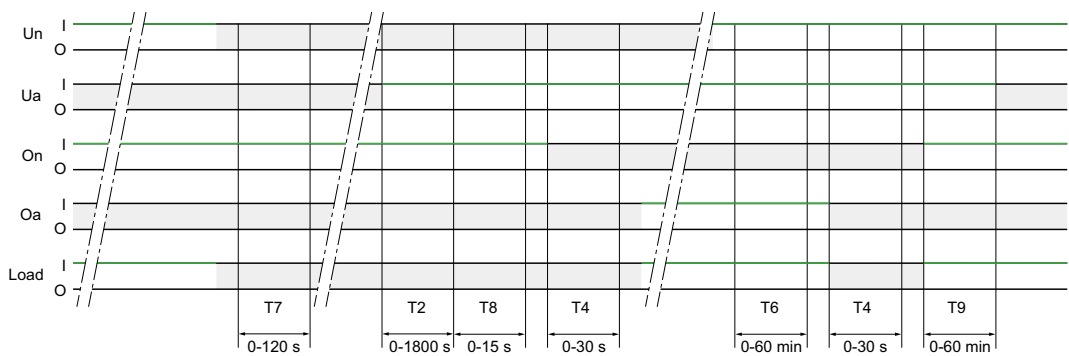

Symbols	Description
Un	Source I
Ua	Source II
On	Contact close at N source
Oa	Contact close at A source
Load	status
T7	Genset Start Delay
T2	Transfer delay
T8	Loadshed Delay

Control Mode and Transfer Logic

Transfer Switching Equipment 32–1600 A

Symbols	Description
T4	Center-off Delay
T6	Re-Transfer Delay
T9	Genset Cool Delay
Key	
O: OFF (circuit open)	
I: ON (circuit closed)	
 : No Power	

A

Control Mode and Transfer Logic Transfer Switching Equipment 32–1600 A

Transfer Logic for U-G Application

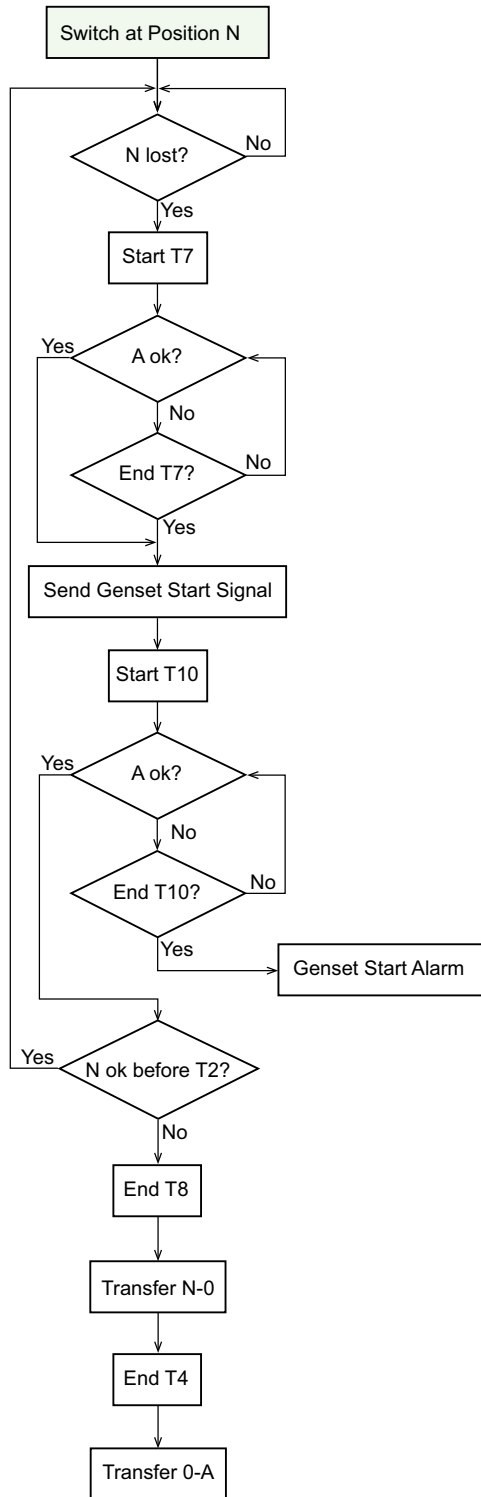

Transfer Logic

- T2 will reset if N becomes unavailable
- If disable Genset Start Fail Warning, T10 will not be counted
- The whole transfer will be canceled if N becomes available during T7

Control Mode and Transfer Logic Transfer Switching Equipment 32–1600 A

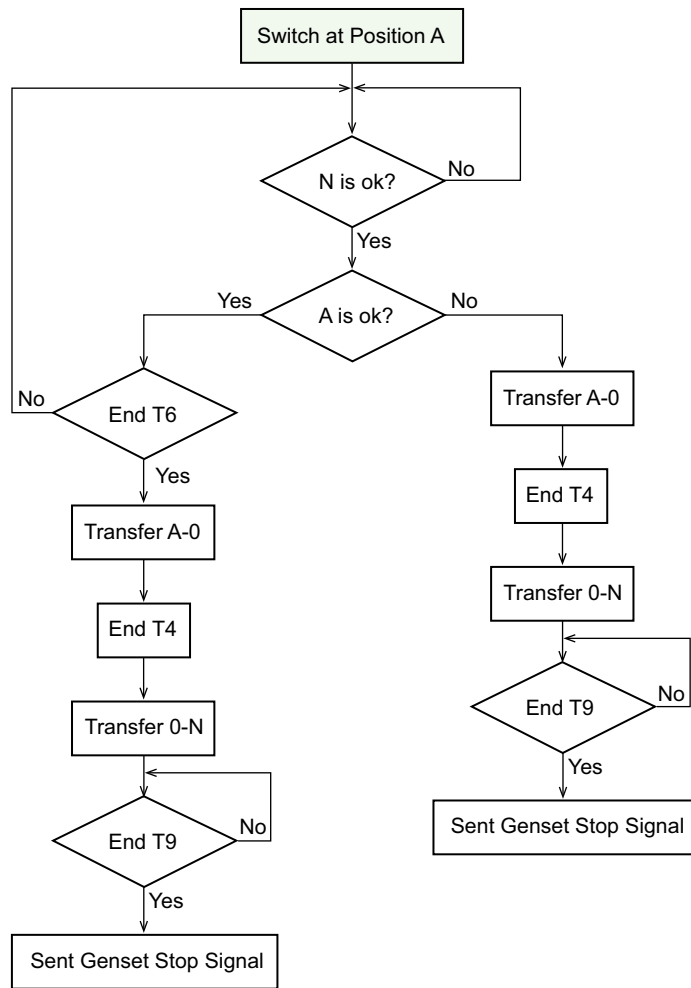

Retransfer Logic

- T2 will reset if N becomes unavailable
- T6 will reset if N becomes unavailable
- During T6, if A is not available it will keep to count T6 if the rest time of T6 is shorter than T2. Other wise it goes to T2

Control Mode and Transfer Logic Transfer Switching Equipment 32–1600 A

Non-Return

In the non-return mode, after auto transfer to replacement, the ATSE will be connected to the alternate source until:

- An external order is given to transfer back to N source.
- The alternate source is out of range. In such case, the ATSE controller will transfer back to the N source to maintain power availability.

There will be only one time power off, when there is normal power outage.

Transfer Process for Non-Return U-U Application

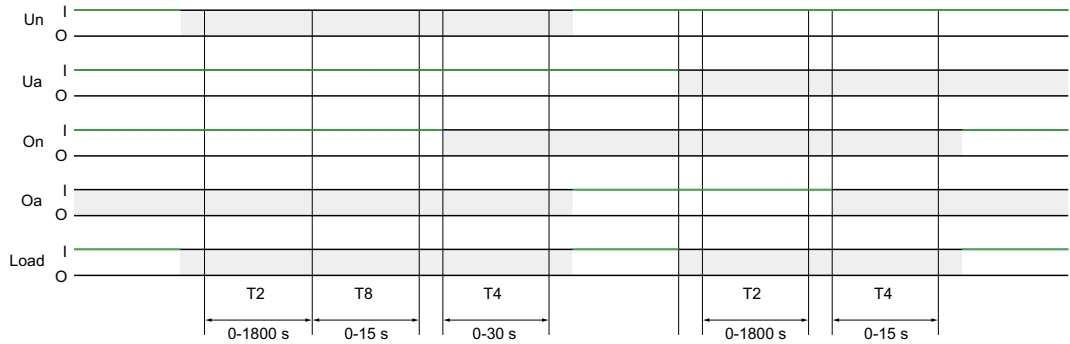

Symbols	Description
Un	Source I
Ua	Source II
On	Contact close at N source
Oa	Contact close at A source
Load	Status
T2	Transfer delay
T8	Loadshed Delay
T4	Center-off Delay

Key
 O: OFF (circuit open)
 I: ON (circuit closed)
 [Grey Box] : No Power

Control Mode and Transfer Logic

Transfer Switching Equipment 32–1600 A

Logic for Non-Return U-U Application

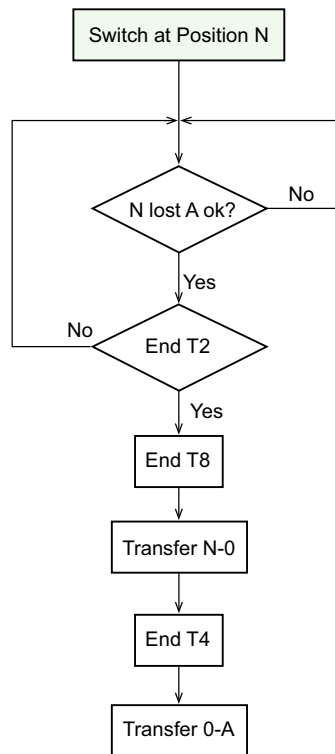

Transfer Logic

* T2 will reset if N becomes unavailable or A becomes unavailable

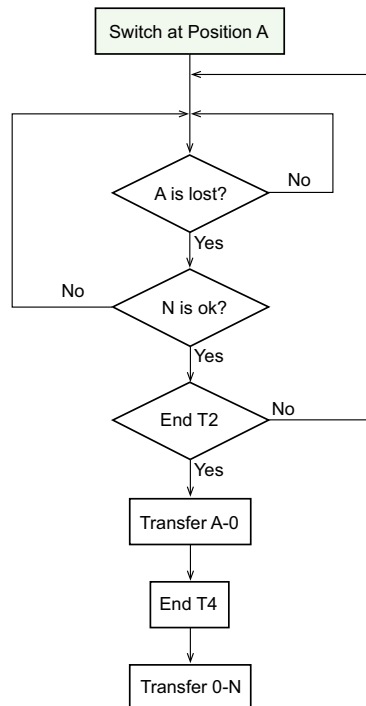

Retransfer Logic

* T2 will reset if N becomes unavailable

Control Mode and Transfer Logic

Transfer Switching Equipment 32–1600 A

Transfer Process for Non-Return U-G Application

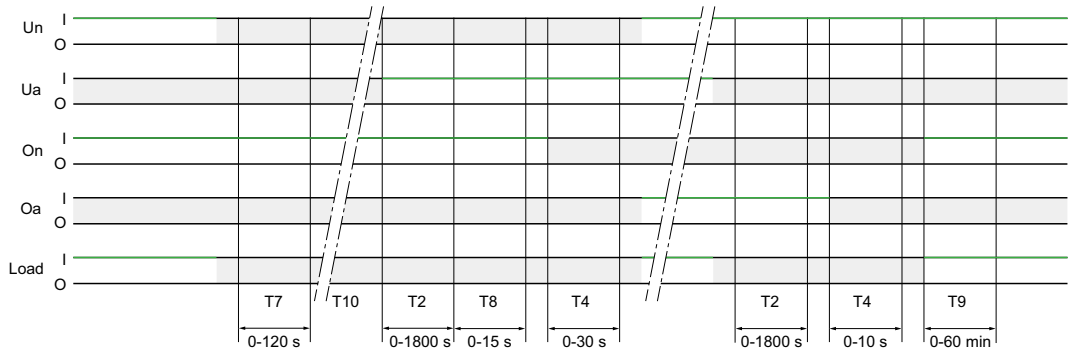

Symbols	Description
Un	Source I
Ua	Source II
On	Contact close at N source
Oa	Contact close at A source
Load	status
T7	Genset Start Delay
T2	Transfer delay
T8	Loadshed Delay
T4	Center-off Delay
T9	Genset Cool Delay
Key	
O	: OFF (circuit open)
I	: ON (circuit closed)
■	: No Power

Control Mode and Transfer Logic

Transfer Switching Equipment 32–1600 A

Logic of Non-Return for U-G Application

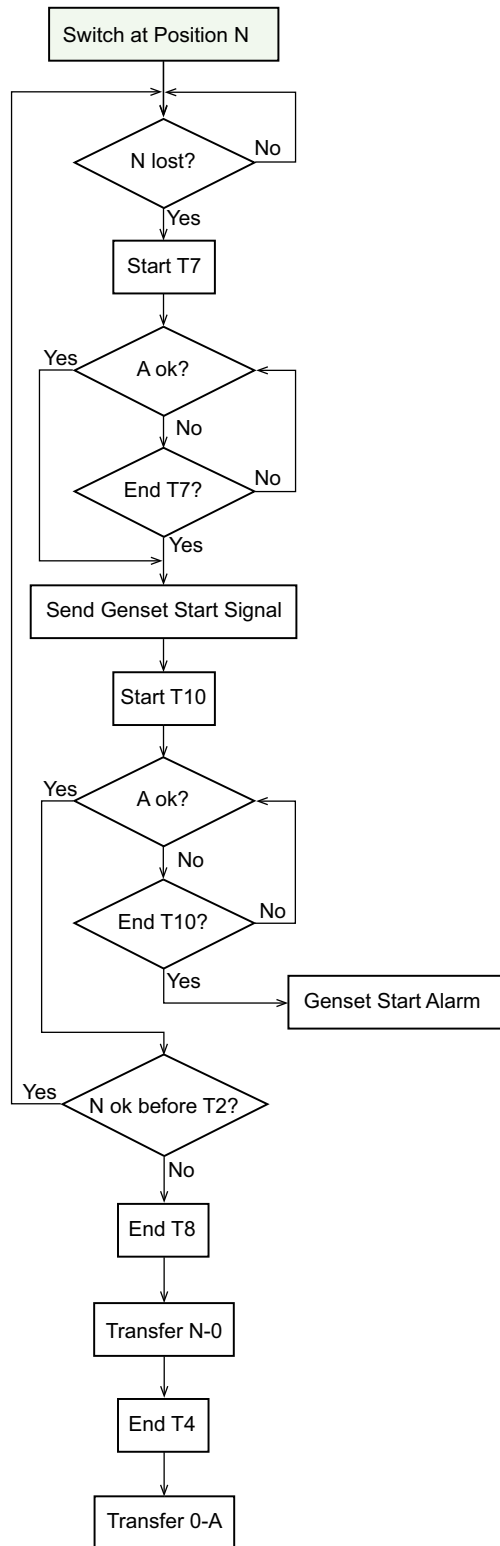

Transfer Logic

- T2 will reset if N becomes unavailable or A becomes unavailable
- If disable Genset Start Fail Warning, T10 will not be counted

Control Mode and Transfer Logic

Transfer Switching Equipment 32–1600 A

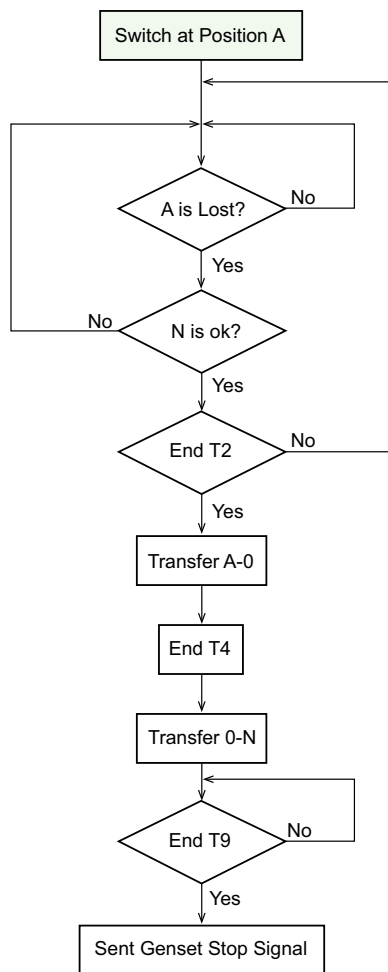

Retransfer Logic

* T2 will reset if N becomes unavailable

Control Mode and Transfer Logic

Transfer Switching Equipment 32–1600 A

Communication Control Mode

The communication control function allows TSE to transfer or test through communication. The switch can refuse to respond if the action will damage the driving system. It cannot transfer to unavailable source either.

The communication control function can be enabled/disabled through Active Automatic HMI (only available for TransferPacT Active Automatic transfer switch equipment).

To use the communication control successfully, at least one Modbus module should be installed and activated.

NOTE: Communication control is OFF by default. Follow the instructions below to enable communication control.

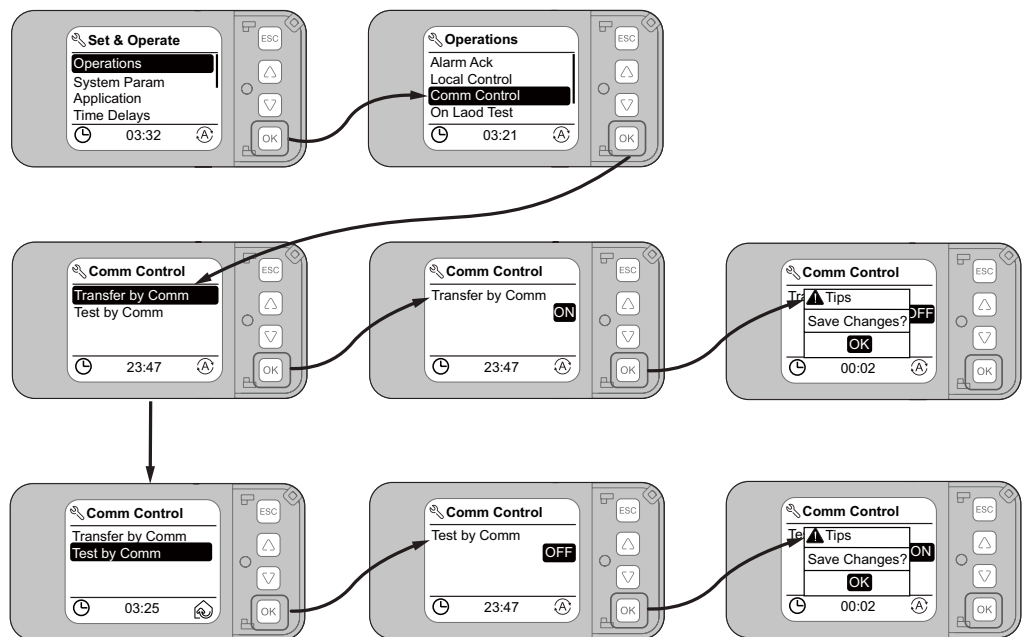

Transfer by Communication

Transfer Logic Overview

Transfer by communication support the following four commands:

- Comm to Normal Source
- Comm to Alternate Source
- Comm to OFF
- Comm to Exit

The command is sent through PC - Modbus. Comm to N/A is equivalent to the voluntary transfer mode on the transfer result. Comm to OFF is equivalent to local control to Off, but not equivalent to force to Off. The ATSE will transfer to OFF after receiving the command without any time delay.

When more than one Modbus modules are installed, the ATSE will only respond to the module which will send the command first. It will not response to any command from other modules until the first module sends the Exit command.

Control Mode and Transfer Logic

Transfer Switching Equipment 32–1600 A

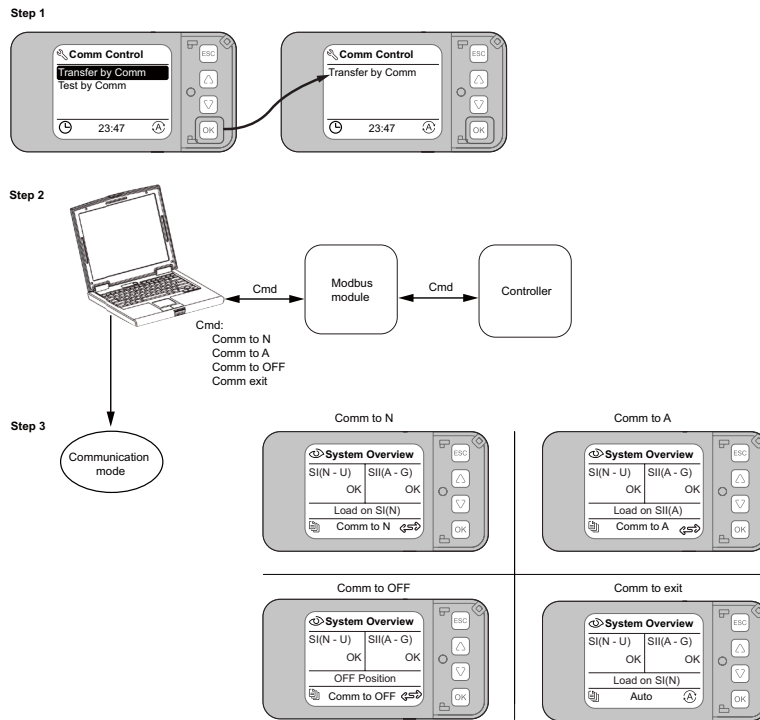

Exit Communication Control Mode

There are three ways to exit communication control mode:

- The Modbus master device sends the Exit command to the active Modbus module installed on ATSE.
- Turn off Transfer by Comm from active automatic HMI.
- The active Modbus module is offline.

Control Mode and Transfer Logic Transfer Switching Equipment 32–1600 A

Transfer Logic of Communication to A (U-U Application)

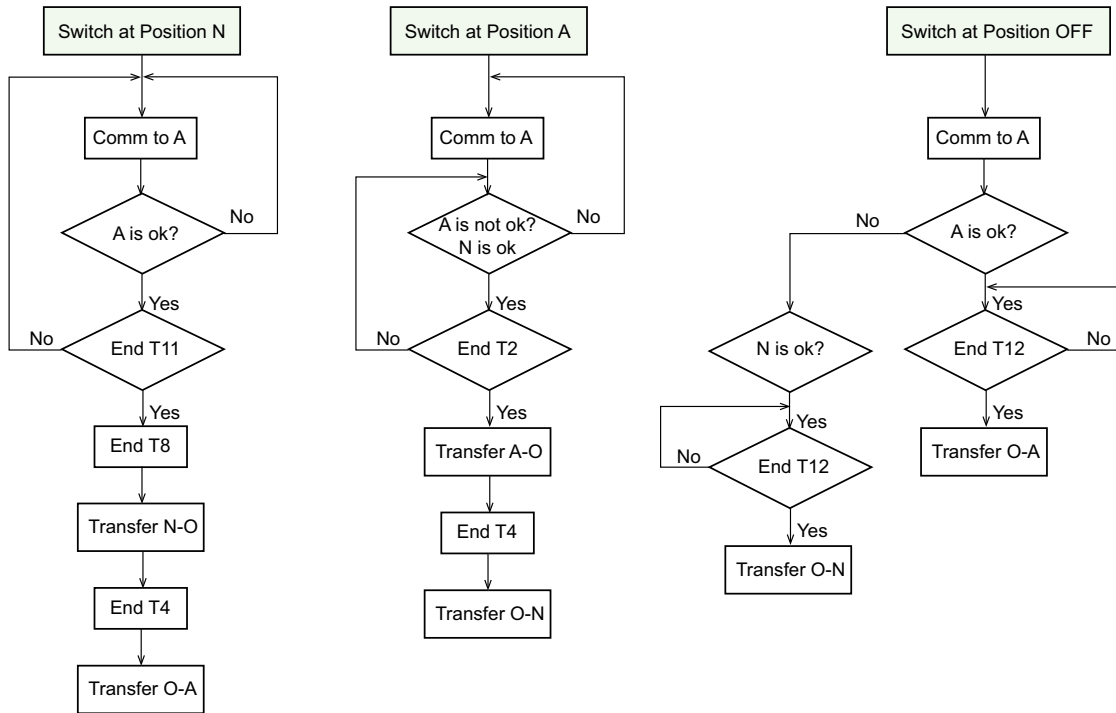

* T11 is internal fixed time delay

Transfer Logic of Communication to N (U-U Application)

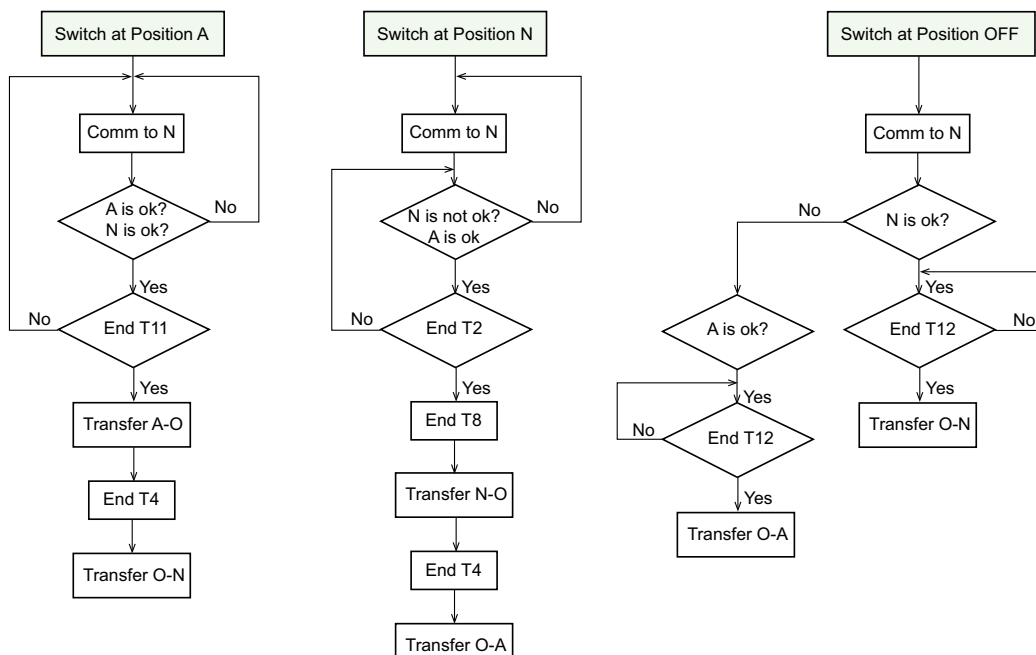

* T11 is internal fixed time delay



Control Mode and Transfer Logic

Transfer Switching Equipment 32–1600 A

Transfer Logic of Communication to A (U-G Application)

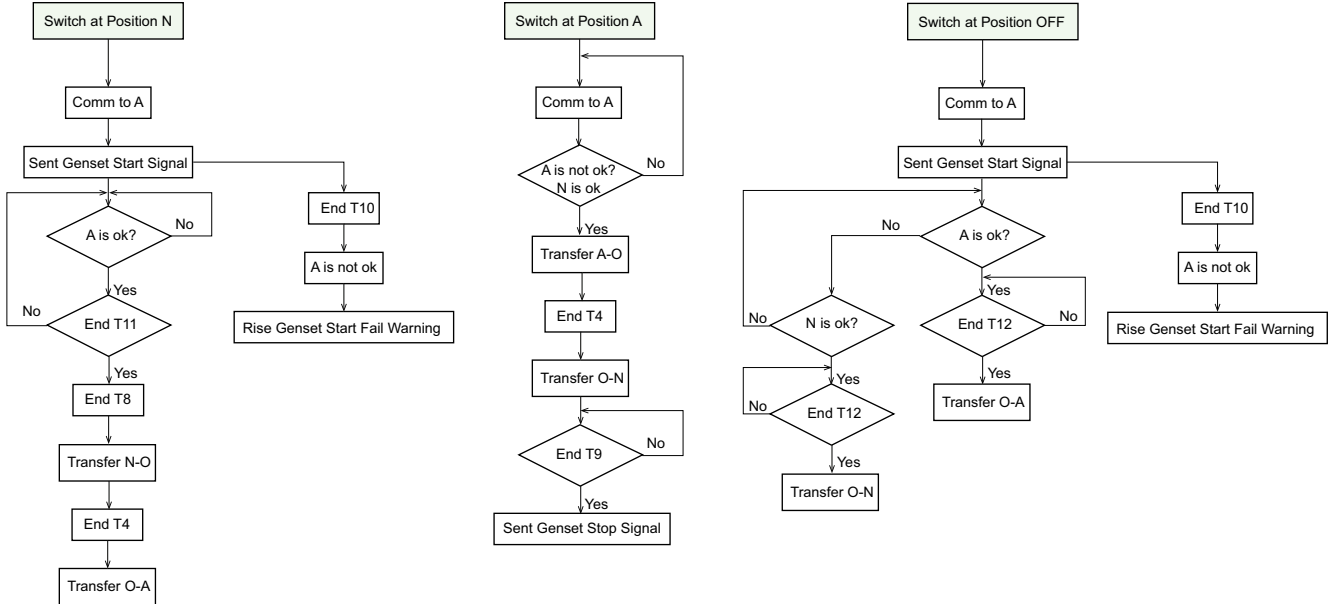

* T11 is internal fixed time delay

Control Mode and Transfer Logic

Transfer Switching Equipment 32–1600 A

Transfer Logic of Communication to N (U-G Application)

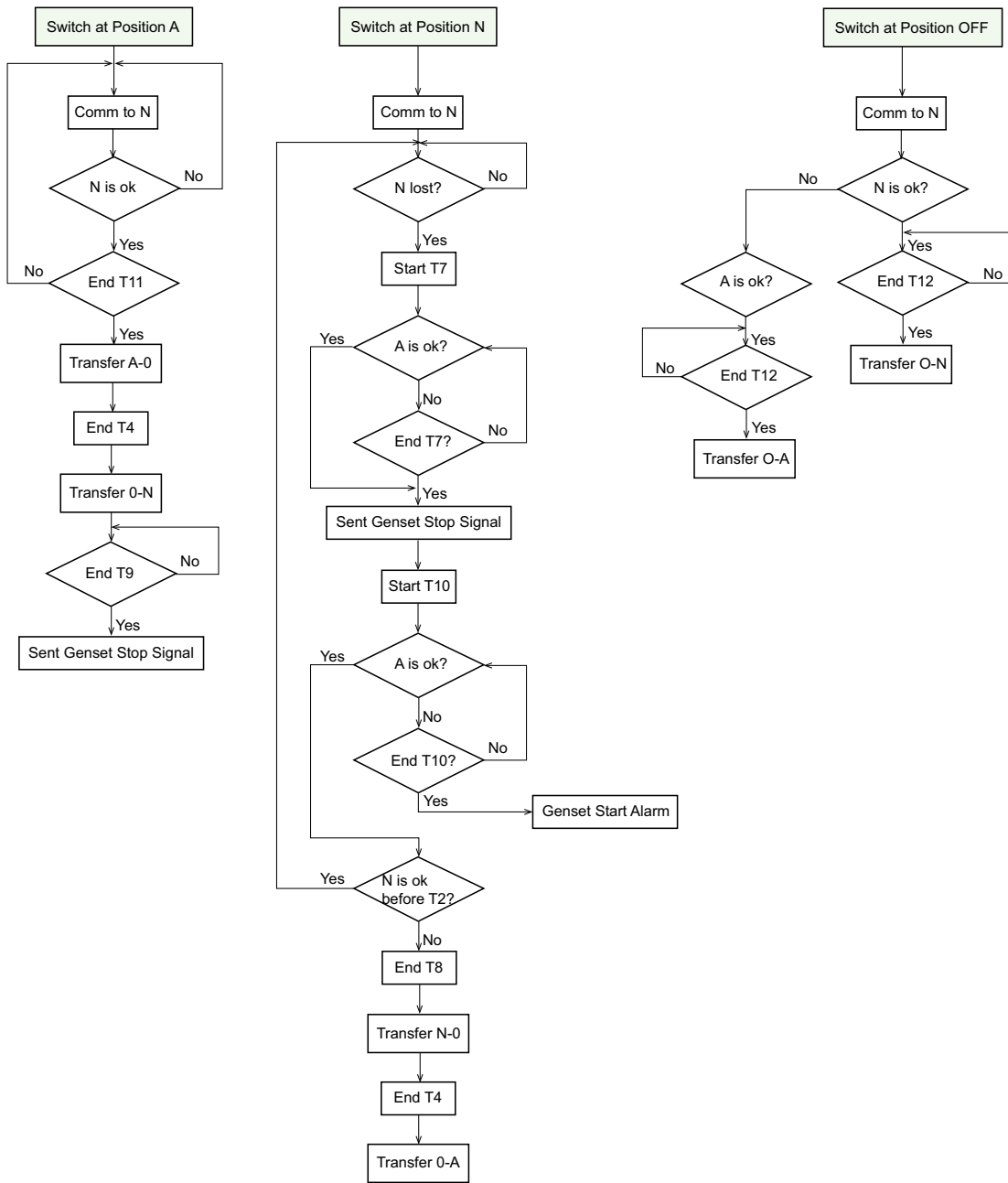

* T11 is internal fixed time delay

Transfer Logic of Communication to Off

Comm to OFF is equivalent to local control to off in Local Control Mode, but different to Force to Off Mode. The ATSE will transfer to off after receiving the command without any time delay. For more information, see Local Control Mode, page A-44.

Control Mode and Transfer Logic Transfer Switching Equipment 32–1600 A Test by Communication

Transfer by communication that supports the following three commands:

- On Load Test
- Off Load test
- Test Exit

When more than one Modbus modules are installed, the ATSE will only respond to the module which send the command first. It will not respond to any command from other modules until the first module sends the Exit command.

When the test is ongoing, ATSE ignores any other interface signal from active automatic HMI or DI module (TPCDIO07).

The operation of Test by communication is equivalent to Test mode. For more information, see Test Mode, page A-37.

Step 1

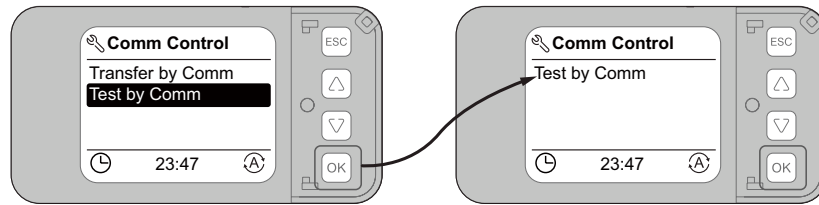

Step 2

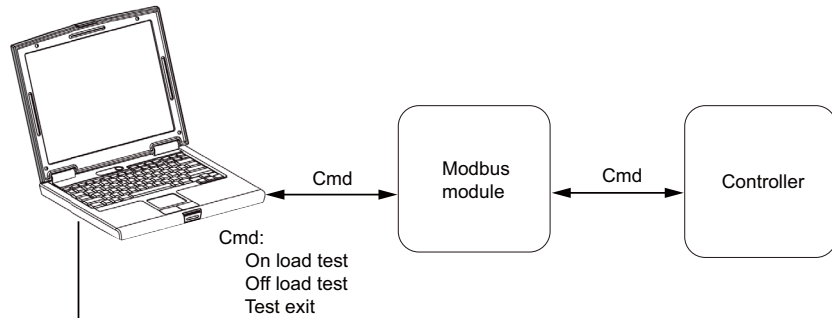

Step 3



Stop Test by Communication

There are three ways to exit communication control mode:

- The Modbus master device send Test Exit command to the active Modbus module installed on ATSE.
- Turn off Test by Comm from active automatic HMI.
- The active Modbus module is offline.

Control Mode and Transfer Logic

Transfer Switching Equipment 32–1600 A

Voluntary Transfer Mode

The voluntary transfer mode is equivalent to auto-priority mode on one source, with forced priority to the SI or SII source. It is activated when associated input is closed (the commercial reference number for the voluntary control module is TPCDIO08). It takes over 200 ms to activate the voluntary mode. The signal for voluntary transfer should be constant.

Voluntary transfer is normally used for special tariffs. Once the mode is set from voluntary to N or A, ATSE still remains in auto mode. When there is power contingency on target source, transfer switch can re-transfer to available source automatically.

NOTE: Auto transfer will not be active, if transfer action damages driving system (for example, both source are out of range, TSE refuses to transfer).

The following are the voluntary transfer mode use cases:

Use Case 1: Typhoon Mode

During typhoon or earthquake, the Genset will be more stable than utility. The user for this case has installed a typhoon mode switch on his control panel. The user will activate the typhoon mode switch. It is connected to the input voluntary transfer mode which will transfer to alternate source (need accessory to have function of voluntary transfer using TPCDIO08 accessories). The ATSE will now activate the Genset output and will transfer to Genset once ready.

Now during the typhoon, the Genset is flooded. The ATSE will still be in auto mode. It detects alternate source failure. If the normal source is fine, it will try to transfer to normal source (voluntary is still an auto mode, and we have auto-return). If the normal source is not available then ATSE will not do any transfer. Still during typhoon, the Genset can restart (it was a fuel level problem). As the typhoon mode switch is still enabled, the ATSE will transfer back to the Genset. The Genset output keeps activated.

So, whatever the source is connected, the typhoon is gone. The utility is back to normal. The user will deactivate the typhoon mode switch. The ATSE will transfer back to normal source at auto mode with auto-return, U-G.

The configuration needed is a ATSE along with voluntary transfer module. With this configuration, the user don't need to play with any ATSE settings (return mode, priority source, what is the normal source).

Use Case 2: Peak Tariff (Align with Controller UA/BA)

Initially this feature was created in UA BA in France for Special Tariff Fare (STF) capability. Special Tariff Fare (STF) in France is a special electricity pricing that allows to have discount price on low consumption hours, with the drawback of having a very expensive kWh price on peak hours. With this option, EDF (French utility) provides an output on the energy meter to warn the end user about the price increase. This output is wired on the voluntary transfer input of the controller, which automatically transfers the load to a cheaper alternate source. This allows to help shedding the peaks on the network.

Control Mode and Transfer Logic

Transfer Switching Equipment 32–1600 A

Transfer Logic of Voluntary to A (U-U Application)

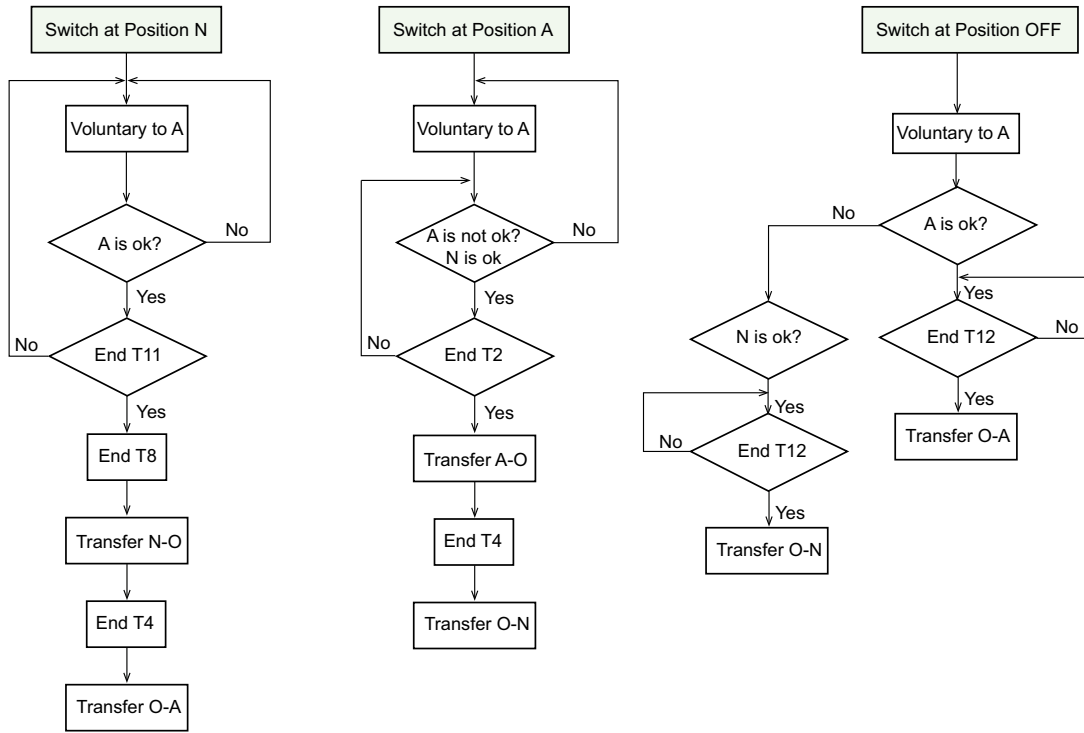

* T11 is internal fixed time delay

Transfer Logic of Voluntary to N (U-U Application)

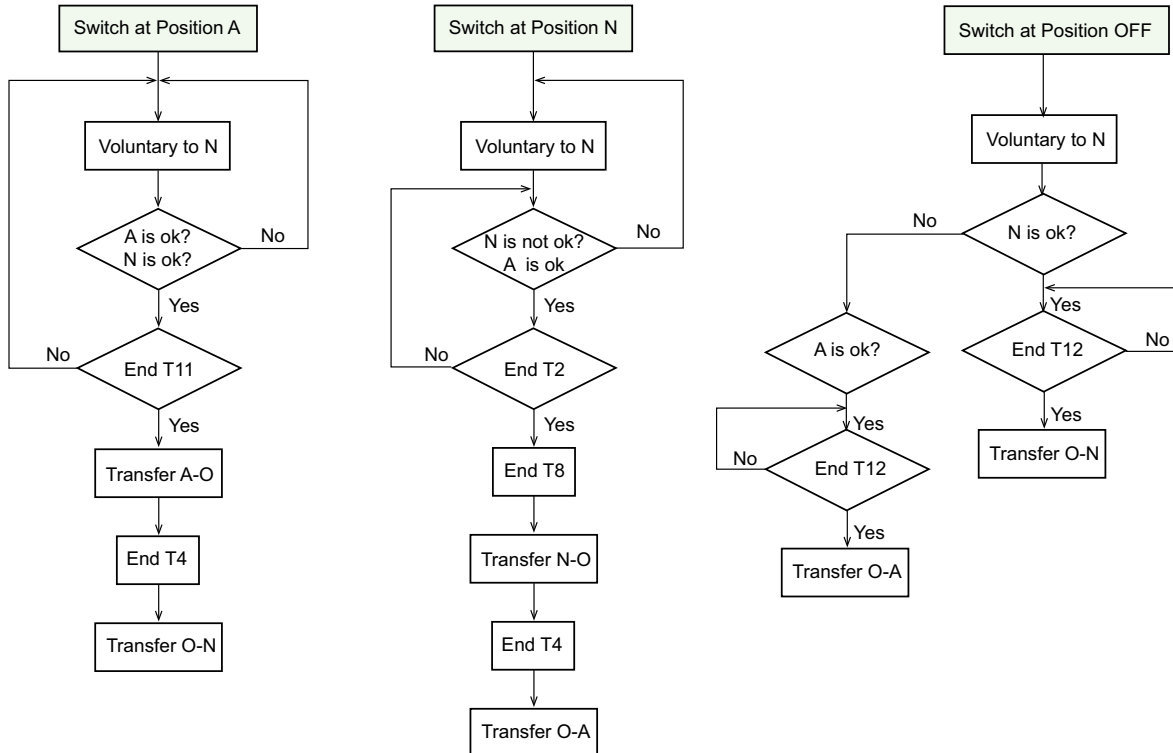

* T11 is internal fixed time delay

Control Mode and Transfer Logic

Transfer Switching Equipment 32–1600 A

Transfer Logic of Voluntary to A (U-G Application)

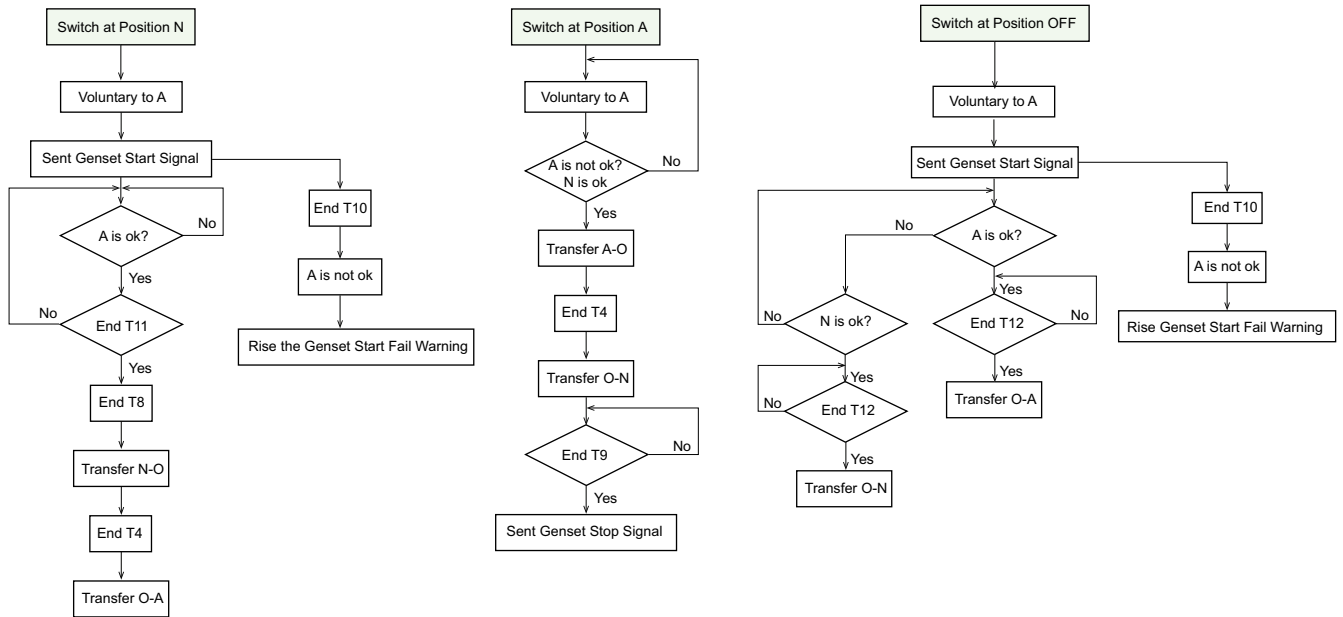

* T11 is internal fixed time delay

Control Mode and Transfer Logic

Transfer Switching Equipment 32–1600 A

Transfer Logic of Voluntary to N (U-G Application)

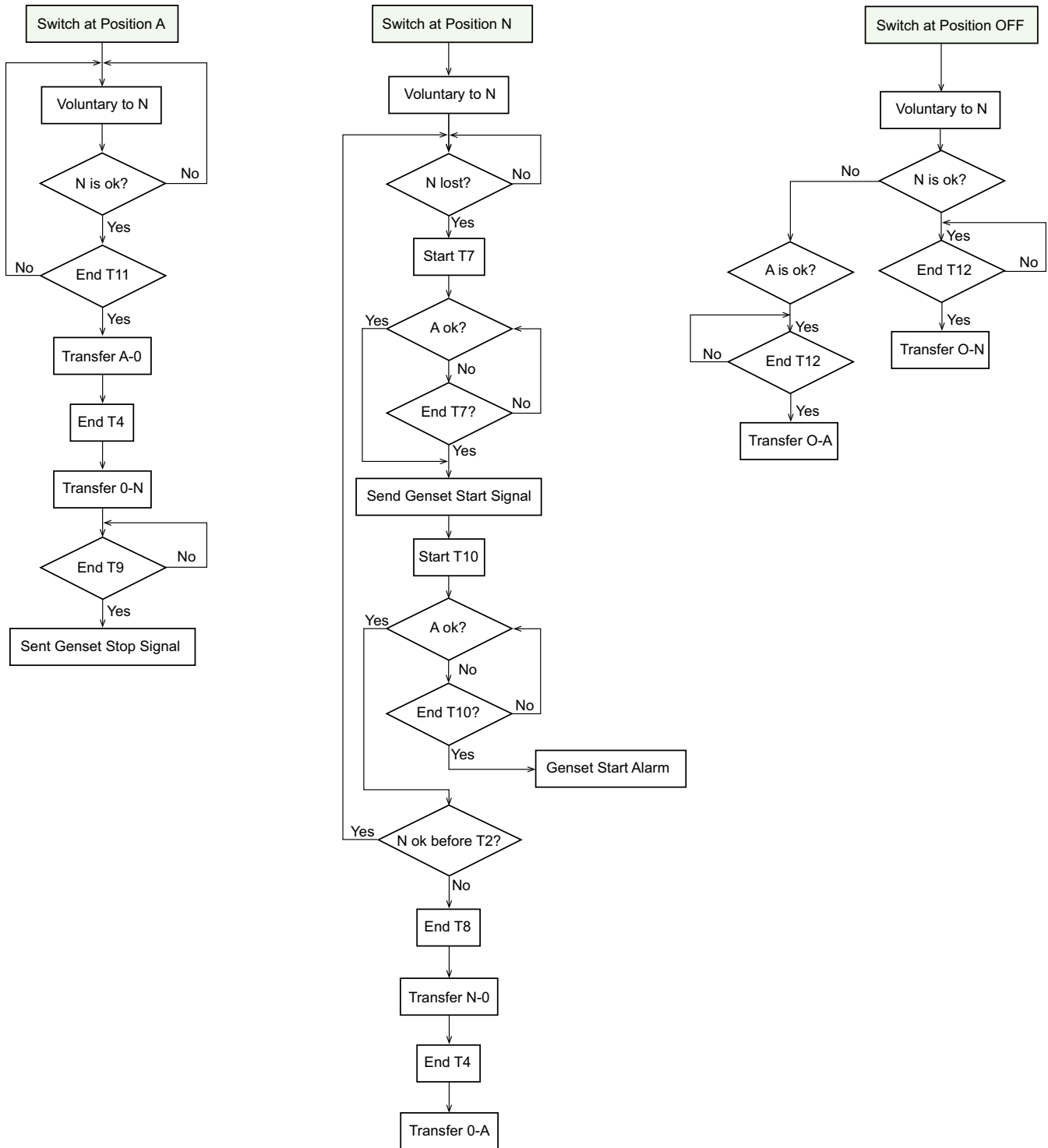

* T11 is internal fixed time delay

Control Mode and Transfer Logic

Transfer Switching Equipment 32–1600 A

Test Mode

The test mode is a procedure to simulate the transfer process with following purpose:

- Test normal transfer actions for ATSE-On load test
- Test Genset-Off load test
- Test Genset-Transfer functions-On load test

Ways to Start Test

There are three ways to conduct the test:

- Through Active Automatic HMI.
- Through DI using TPCDIO07 accessories.
- Through Modbus communication using TPCCOM16 module.

There is no priority among the test command from HMI, DI and Modbus. ATSE will act upon receiving the command from any way.

When the test is ongoing, ATSE ignores any other command until receiving the command to exit test.

Command to exit test should be sent through the same way used to start the test. Otherwise ATSE will not respond. For example, if you start the test through DI module, you have to stop the test through DI module as well.

Default Time for Test

- Default as unlimited test (no time duration, has to stop the test manually).
- If you select limited test, the default time duration is 30 s.

Time Range for Test

- 10 s–1800 s with steps of 1 s.
- Time delay can be bypassed by pressing ESC key in Active Automatic HMI.

Pre-Condition to Start Test Mode

The following conditions are mandatory for the test:

- ATSE is in auto mode.
- ATSE is in normal position while in U to U Application.
- ATSE is in alternate position while in U to U Application.
- ATSE is in normal position while in U to G Application.
- For U-U application, R source shall be available before test. Otherwise, there will be an alarm.
NOTE: On load test will not be active, if transfer action damages driving system (for example, both source are out of range, TSE refuses to transfer).

1. Source N is abnormal during the T7, T10, T2, T13, and T14 delay.
2. Interrupted by higher priority signals.
3. When not in the T8 and T4 phases, the controller terminates the current test after receiving the stop request.
4. The Onload test fails.

Off Load Test

- The purpose of this function is to check the Genset can start, without power interruption.

NOTE:

- This test does not check if the switch is able to make the transfer.
- The test is only available with U-G configuration.
- The off load test should not be proposed, when the ATSE doesn't have Genset output feature.
- This function will only be accessible for product with HMI, as the Test mode default value is On load.
- The orders from higher priority will interrupt the test procedure.

Control Mode and Transfer Logic Transfer Switching Equipment 32–1600 A

Off Load Test

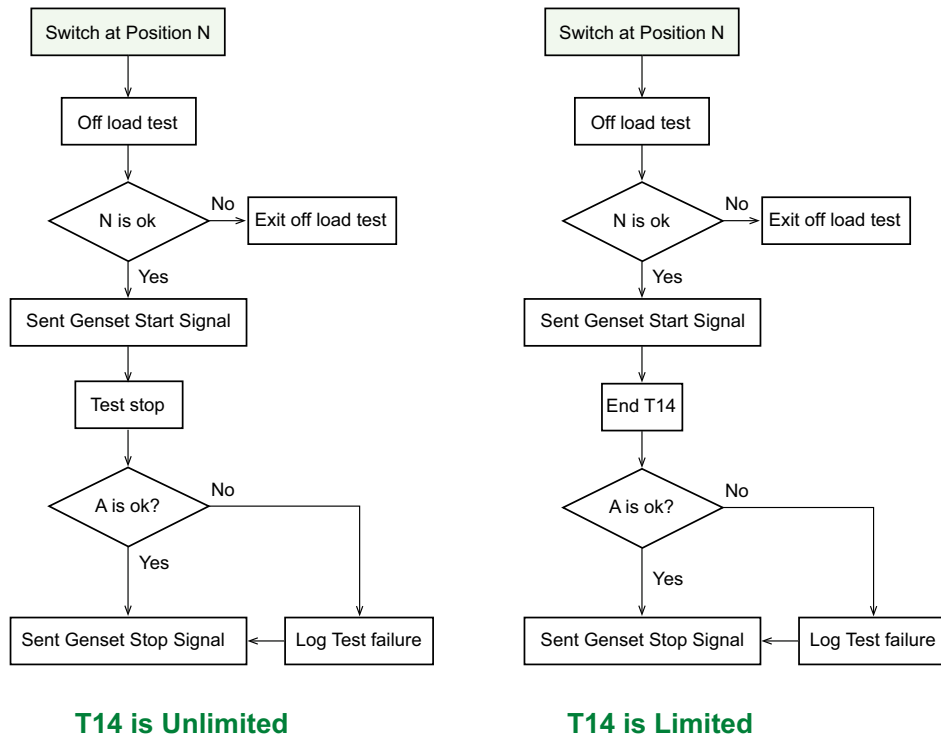

On Load Test

- The purpose of this function is to execute ATSE transfer (when the source is still valid) to make sure the system is still able to execute the transfer. The UU and U-G configuration are both available.
- When the ATSE receive the testing start request:
 - The ATSE shall initiate the transfer to the Alternate source if the Alternate source is in range, and according to the transfer delays (T7, T2...).
 - The ATSE shall log a test start event.
- Two conditions to return to N source:
 - When the ATSE receive the stop request from user.
 - When the Test timer is activated, and the test timer is completed.

Control Mode and Transfer Logic

Transfer Switching Equipment 32–1600 A

Logic of on Load Test U-U

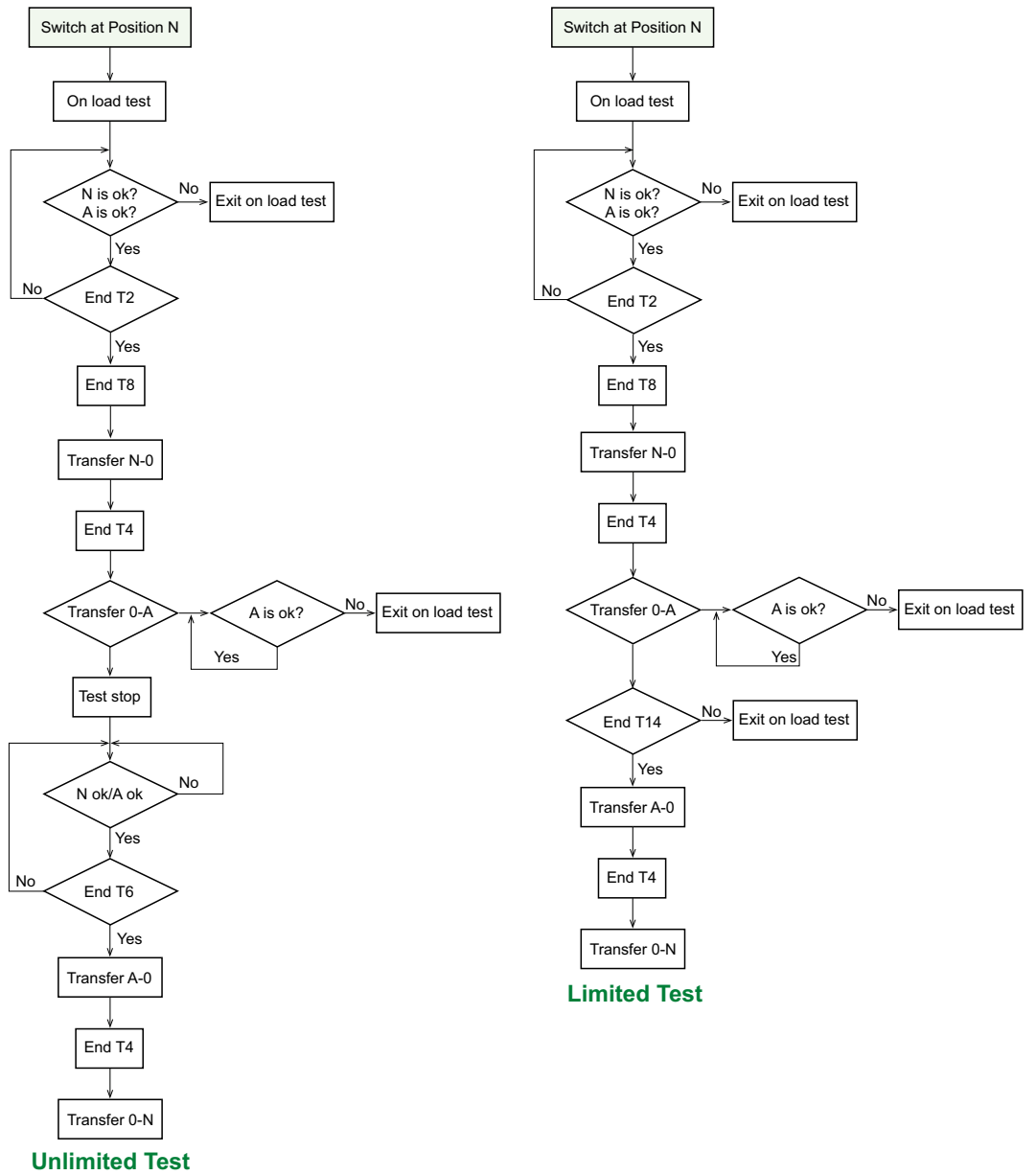

Control Mode and Transfer Logic

Transfer Switching Equipment 32–1600 A

Logic of on Load Test U-G

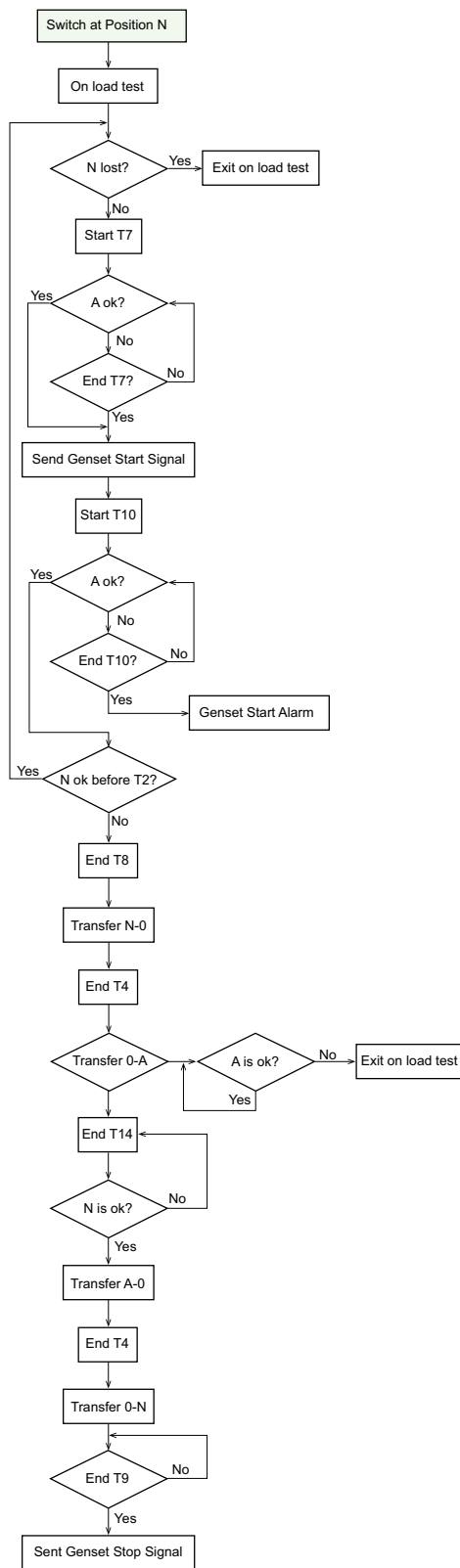

Limited Test

Control Mode and Transfer Logic Transfer Switching Equipment 32–1600 A

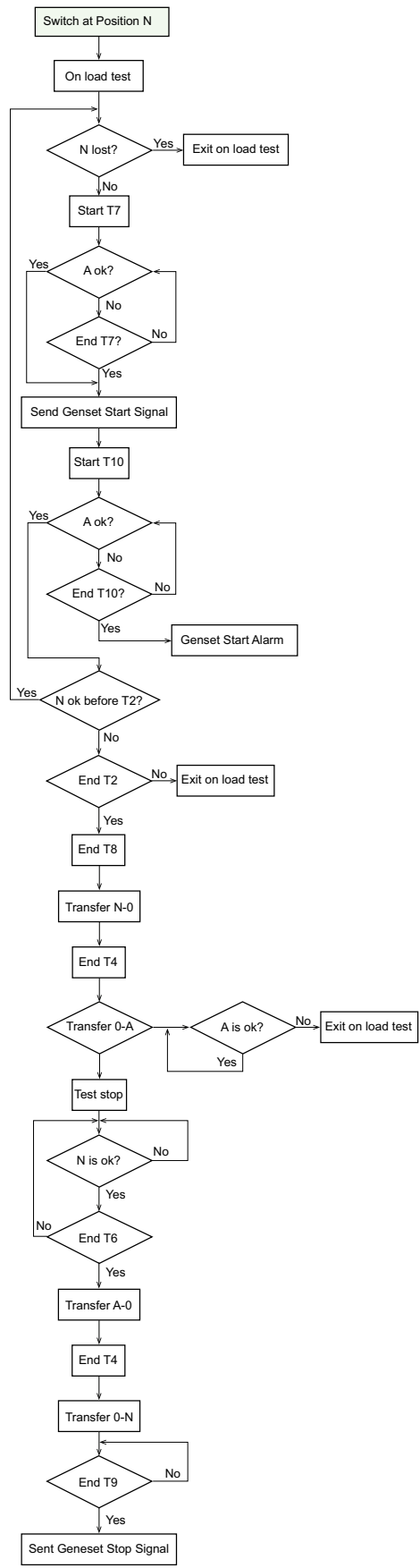

Unlimited Test

Control Mode and Transfer Logic

Transfer Switching Equipment 32–1600 A

Local Control Mode

⚠ CAUTION

HAZARD OF EQUIPMENT DAMAGE

Enable the local control through Active Automatic HMI to exit the auto mode.

Failure to follow these instructions can result in injury or equipment damage.

NOTICE

POTENTIAL POWER OUTAGE OF EQUIPMENT

To re-enter Auto mode, disable local control through Active Automatic HMI or External HMI.

Failure to follow these instructions can result in equipment damage.

The local mode is activated through the HMI (only available for Active Automatic, RS version change to Automatic). It allows locally to change the logical position of the TSE. The switch will refuse to active if the action will damage the driving system. It cannot transfer to unavailable source.

NOTE: Local transfer will not be active, if transfer action damage driving system (for example, both overvoltage are out of range, TSE refuses to transfer) or both sources are out of operating voltage of solenoid.

Auto Genset start signal and load shedding signal is not available for this mode. In this case, the target source conformity is verified before transfer and time delays are not considered.

A

Control Mode and Transfer Logic Transfer Switching Equipment 32–1600 A

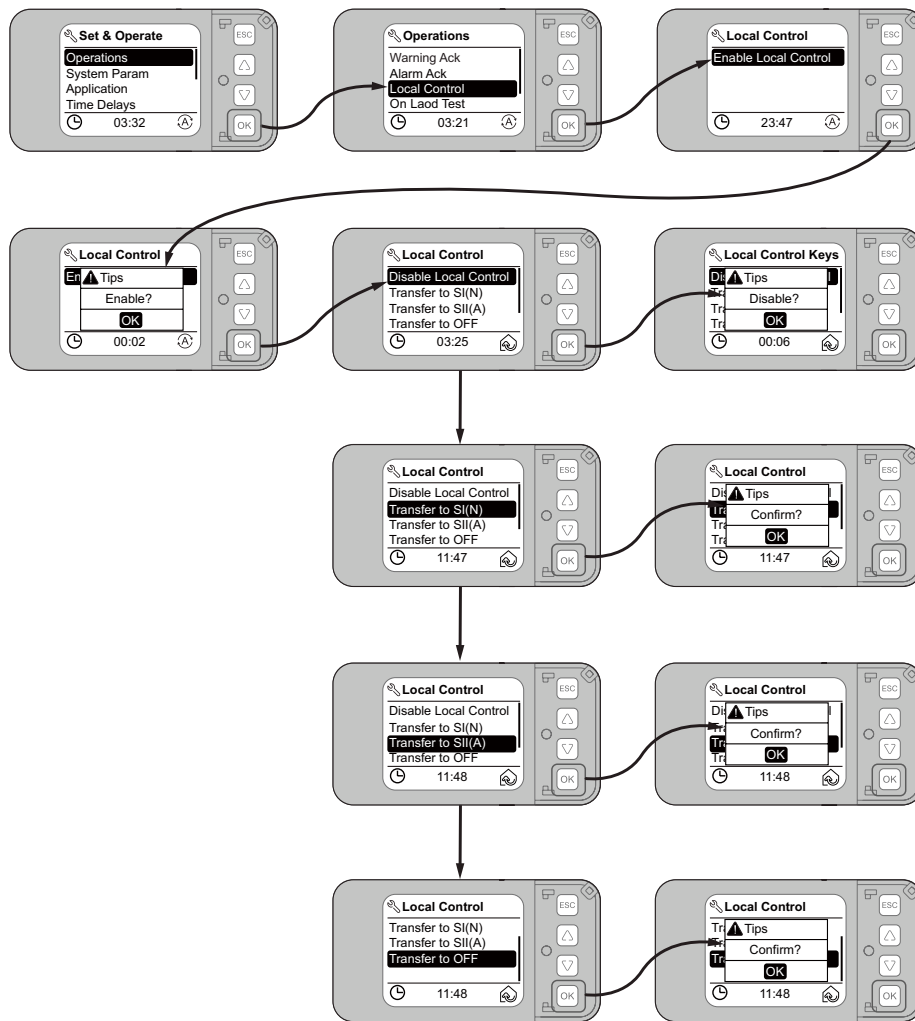

Local Control to N

The command is sent through HMI. There is no time delay except OFF delay. The switch will transfer to normal after receiving the order to it when normal power is in tolerance.

Local Control to A

The command is sent through HMI. There is no time delay except OFF delay. The switch will transfer to alternate after receiving the order to it when alternate power is in tolerance.

Local Control to O

The command is sent through HMI. There shall be no time delay. The switch will transfer to OFF after receiving the order to it.

Control Mode and Transfer Logic

Transfer Switching Equipment 32–1600 A

Transfer Inhibit Mode

When the transfer inhibition input is active, the controller can not send any order to TSE. Front face selection buttons are locked and the HMI only displays transfer inhibit.

Fire, Force to OFF and Handle mode still works as before. When exit Fire, Force to OFF and Handle mode, transferring blocked by transfer inhibit.

Use this mode only when inhibit signal (from DI) is active and no higher operation mode is running. When ATS transfer is ongoing, wait until transfer completed.

Exit this mode after inhibit signal is inactive.

Accessories are required using TPCDIO07 to extend this function of the TSE.

Application

- Transfer inhibit occurs when there is power interruption because of short circuit.
- This function can be used to lock the controller by customized signals.
- This function can be used for cooperation with different ATSE.

Fire Protection Mode

- An emergency stop order to transfer ATSE to off position. All the other transfer mode will be canceled except force to OFF and handle control. There shall be no time delay.
- Exit fire protection after signal disappeared.
- Require accessories TPCDIO10 or TPCDIO11 or TPCDIO13 or TPCDIO14 to extend this function.

Application

- The fire protection signal can transfer ATSE to off position when there is fire emergency.

Force to OFF Mode

- Transfer ATSE to OFF position with an emergency stop order. All the other transfer mode will be canceled except handle control. There should be no time delay.
- Exit Force after signal disappeared.
- Accessories are required using TPCDIO07 to extend this function of TSE.

Handle Transfer Mode

- The handle or manual transfer mode is activated from the TSE directly. It deactivates the controller control function except position status (outputs and LEDs), source status LEDs and alarm LED.
- No operation for load shedding and generator, keep the status as before.
- No alarm relay output.

Controller Accessories



Load Shedding and Availability Warning

Function:

Load shedding

- The emergency power (Genset) sometimes may not afford all loads. A signal from controller will shed some non-critical loads
- Load shedding will send the signal after enabling this function

Availability warning output

- When transfer switch is not in auto or power lost on two sources, a dry contact will output the signal
- After back to Auto status or power recovery, the signal will be stopped

Compatibility: Active Automatic and Automatic

Rating: 250 VAC, 5 A or 30 VDC, 5 A

Digital output



Transfer Inhibit and Remote Testing

Function:

Transfer inhibit

- Transfer Inhibit when there is power interruption because of short circuit
- This function can be used to lock the controller by customized signals
- This function can be used for cooperation with different ATSE
- Remove transfer inhibit signal to Exit this mode

Remote testing

- Remote testing is an input signal to start test procedure.
- The remote test can only be started at Auto mode
- For Active Automatic HMI, on load, off load test and time duration can be selected.
- For Automatic HMI, on load test is unlimited.

Compatibility: Active Automatic and Automatic

Dry Contact

Digital input



Voluntary Remote Control

Function:

Voluntary transfer to N or A

- Voluntary transfer is an active input. It can transfer the ATSE to Normal or Alternate source according to requirements (such as energy saving)
- Voluntary transfer will still keep the power continuity as much as possible. The function will be bypassed if target source loses the power. For example, after voluntary to A while A source failed, ATSE will transfer back to N if N is available
- Exit voluntary mode after signal disappeared

Force to Off

- An emergency stop order to transfer ATSE to off position. All the other transfer mode will be canceled except handle control
- Exit Force after signal disappeared

Compatibility: Active Automatic and Automatic

Dry Contact

Digital input

Controller Accessories

Fire Protection

Function:

The fire protection signal can transfer ATSE to off position when there is fire emergency.

- Fire protection with input of DC24 V pulse signal. Input Voltage: 24 VDC (-20% ~ +20%), Maximum Input Current: 10 mA
- Fire protection with input of DC24 V Constant signal. Input Voltage: 24 VDC (-20% ~ +20%), Maximum Input Current: 10mA
- Fire protection with input of AC230 V Constant. Input Voltage: 230 VAC (-20% ~ +20%), 50 Hz/60 Hz Maximum Input Current: 10 mA
- Fire protection with 1 input, dry contact

Compatibility: Active Automatic and Automatic
Digital input



A

BUS Extension and 24 VDC Auxiliary Supply

Function:

BUS extension

- Can be used to connect external HMI

DC 24V Auxiliary Supply

- External power for controller when both source failure
- External power to keep power for Modbus communication when both source failure

Compatibility: Active Automatic

Rating: Input Voltage: 24 VDC (-20% ~ +20%), Maximum Input Current: 1 A



Modbus RTU (Serial Port)

Function:

Modbus

- Can be used to connect with other system
- Require External 24 V or at least one main source to keep communication
- With Protocol Modbus RTU communication

Compatibility: Active Automatic



Genset Start and Alarm

Function:

Genset start output

- When utility source is lost, a dry contact will start Genset. No matter with or without external 24 V, a time delay (T7) before genset start can be set
- When Utility source has recovered, and ATSE has transferred back to Utility, Genset signal will remain until end of Genset cooldown timer

Alarm

- When there is critical alarm, a dry contact will output the signal
- Restart controller (open and close dielectric door) to shut down the Alarm

Compatibility: Active Automatic and Automatic

Rating: 250 VAC, 5 A or 30 VDC, 5 A

Digital output

Note: The alarm signal is irrelevant to generator start or stop. It is relevant to transfer errors and phase rotations (for Active automatic version only) errors, for more detail, refer to DOCA0214EN-00



Controller Accessories



External HMI

- Door mounted HMI provide exact same function as TransferPacT active automatic HMI Including status display, settings, event log, control transfer switch.It consists of an install base and LCD display, IP40. TPCCIF04

IP54 Cover

- Optional accessory, Protective cover for external HMI for outdoor installations. TPCOTH37 or TPCOTH38(economic solution).

HMI Cable

Used to connect the TSE and external HMI. 2*RJ45 port.

- TRV00810: cable length is 1 m
- TRV00820: cable length is 2 m
- TRV00830: cable length is 3 m

Energy Sensor

- Function: provides accurate real-time measurements and energy values.
- Application: for Frame 250 4P,downstream(load side) only. neutral be on left. LV434021

Electrical and Mechanical Accessories - Frame 100

A

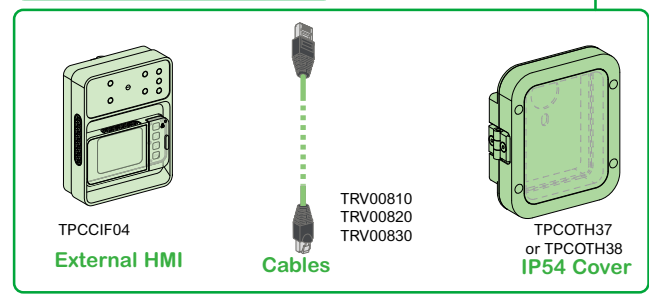
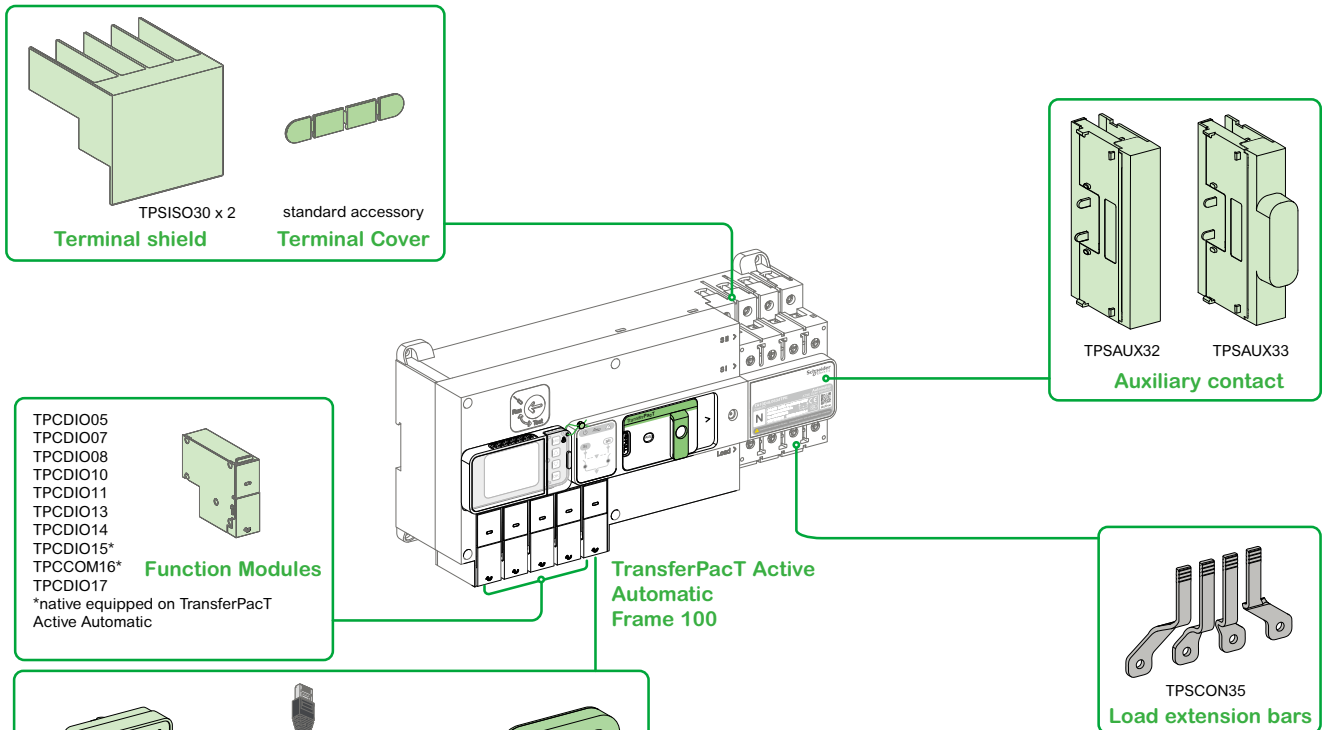
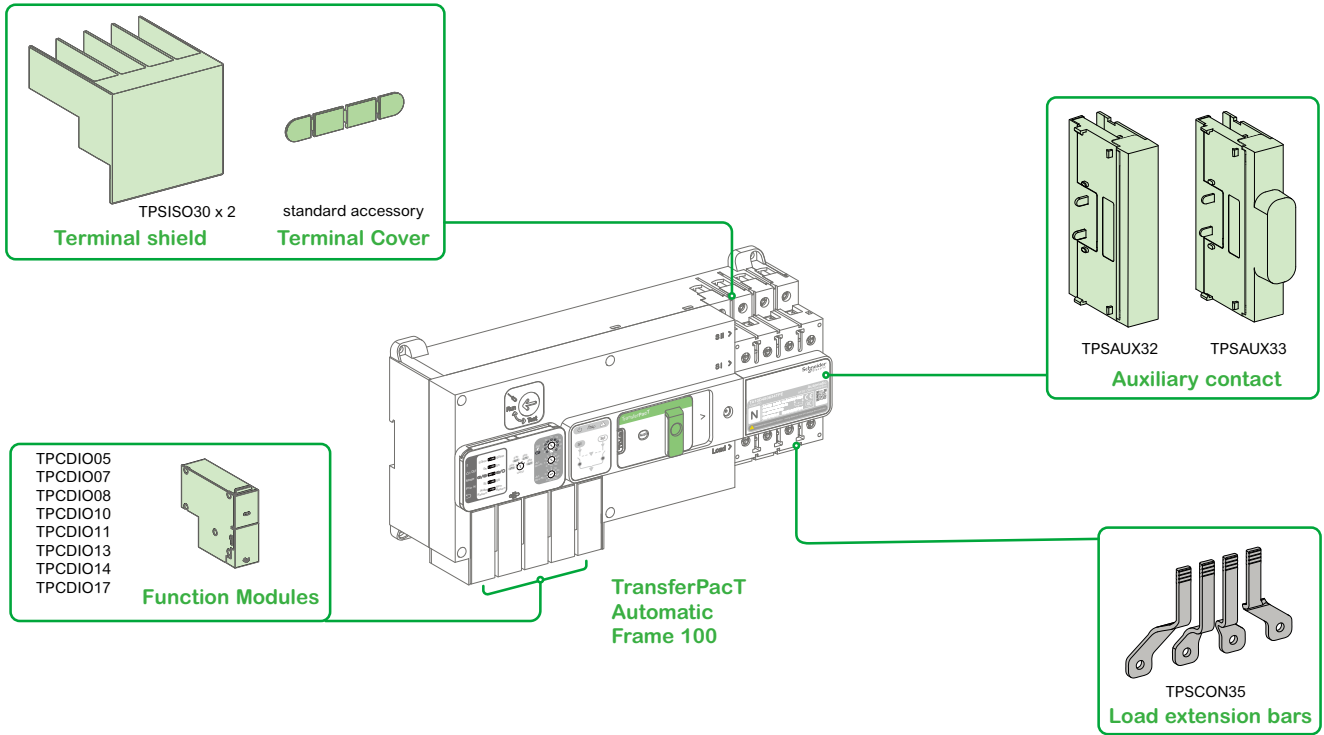

Electrical and Mechanical Accessories - Frame 100



Auxiliary Contact Module

- TPSAUX32: Provide the open and closed status indication for both source I and source II.
- TPSAUX33: Provide the open and closed status indication for OFF position.

Insulating Accessories

Terminal Shield

- Optional accessory, Provide terminal protection on the cable incoming and output.
- TPSISO30: Terminal Shield (set of 2)



Terminal Extension

- Natively supplied with interphase barriers.



Type	Pole	Commercial Reference	Quantity
Spreaders			
18-28 mm	3P	TPSCON35	4
	4P	TPSCON35	4

Electrical and Mechanical Accessories- Frame 160

A

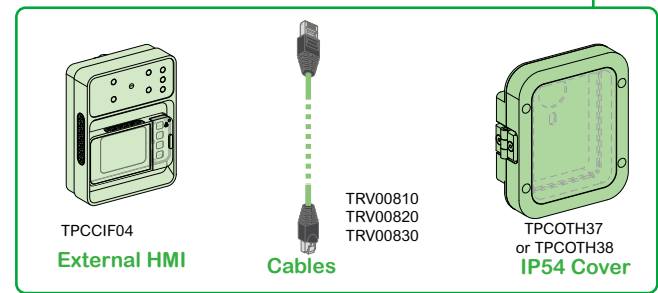
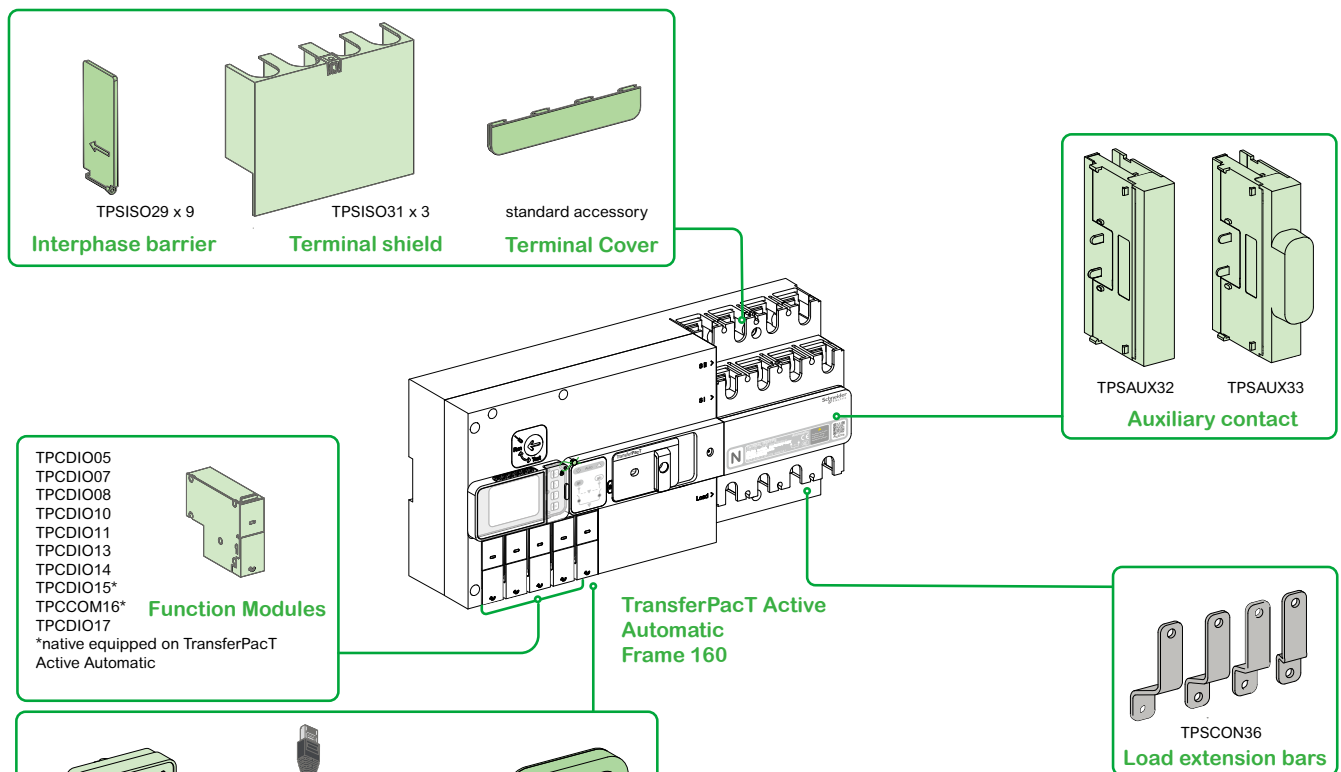
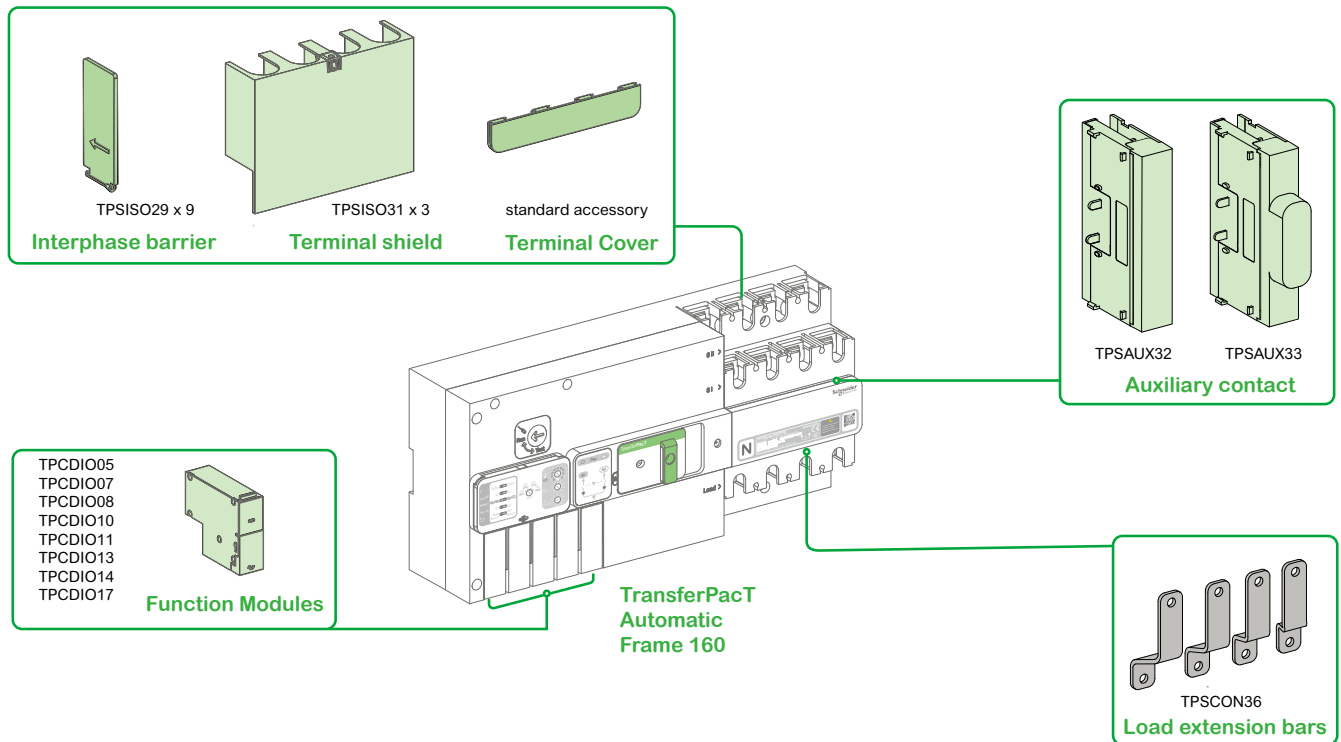

Electrical and Mechanical Accessories - Frame 160

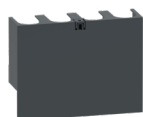

Auxiliary Contact Module

- TPSAUX32: Provide the open and closed status indication for both source I and source II.
- TPSAUX33: Provide the open and closed status indication for OFF position.

Insulating Accessories

Terminal Shield

Optional accessory, Provide terminal protection on the cable incoming and output.

- TPSISO31: Terminal Shield(set of 3)

Interphase Barrier

Optional accessory, Provide protection for the cable incoming and output, effectively avoiding short circuits between phases.

- TPSISO29: Interphase barrier(set of 9)

Terminal Extension

- Natively supplied with interphase barriers.



Type	Pole	Commercial Reference	Quantity
Spreaders			
30-40 mm	3P	TPSCON36	4
	4P	TPSCON36	4

Electrical and Mechanical Accessories - Frame 250

A

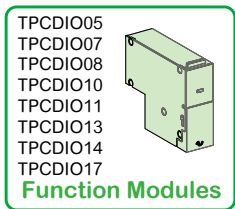
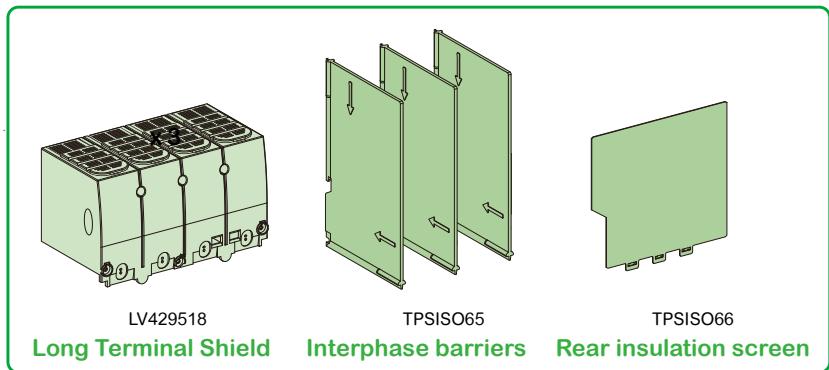

**TransferPacT
Automatic
Frame 250**

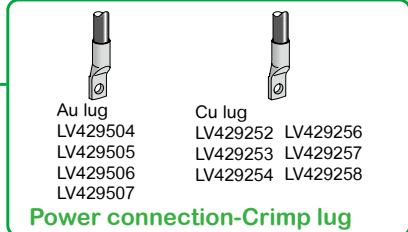
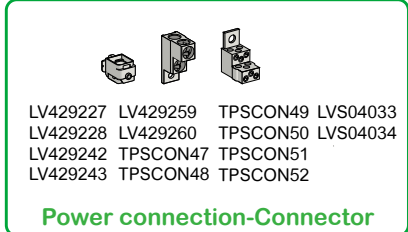
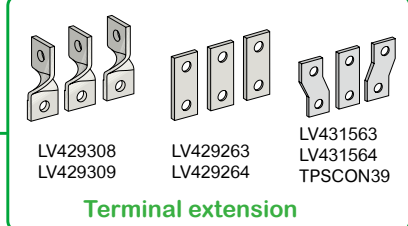
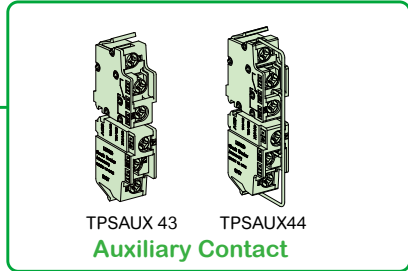
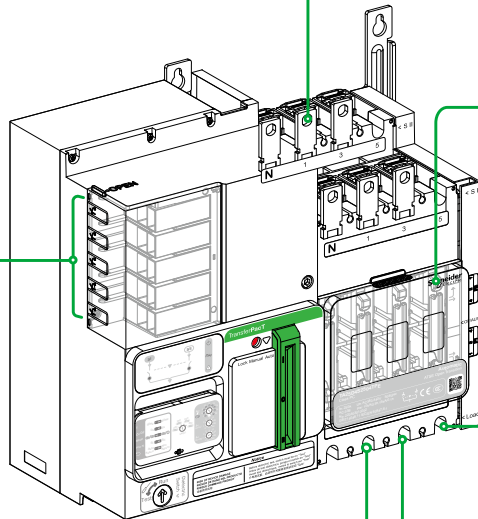

Electrical and Mechanical Accessories- Frame 250

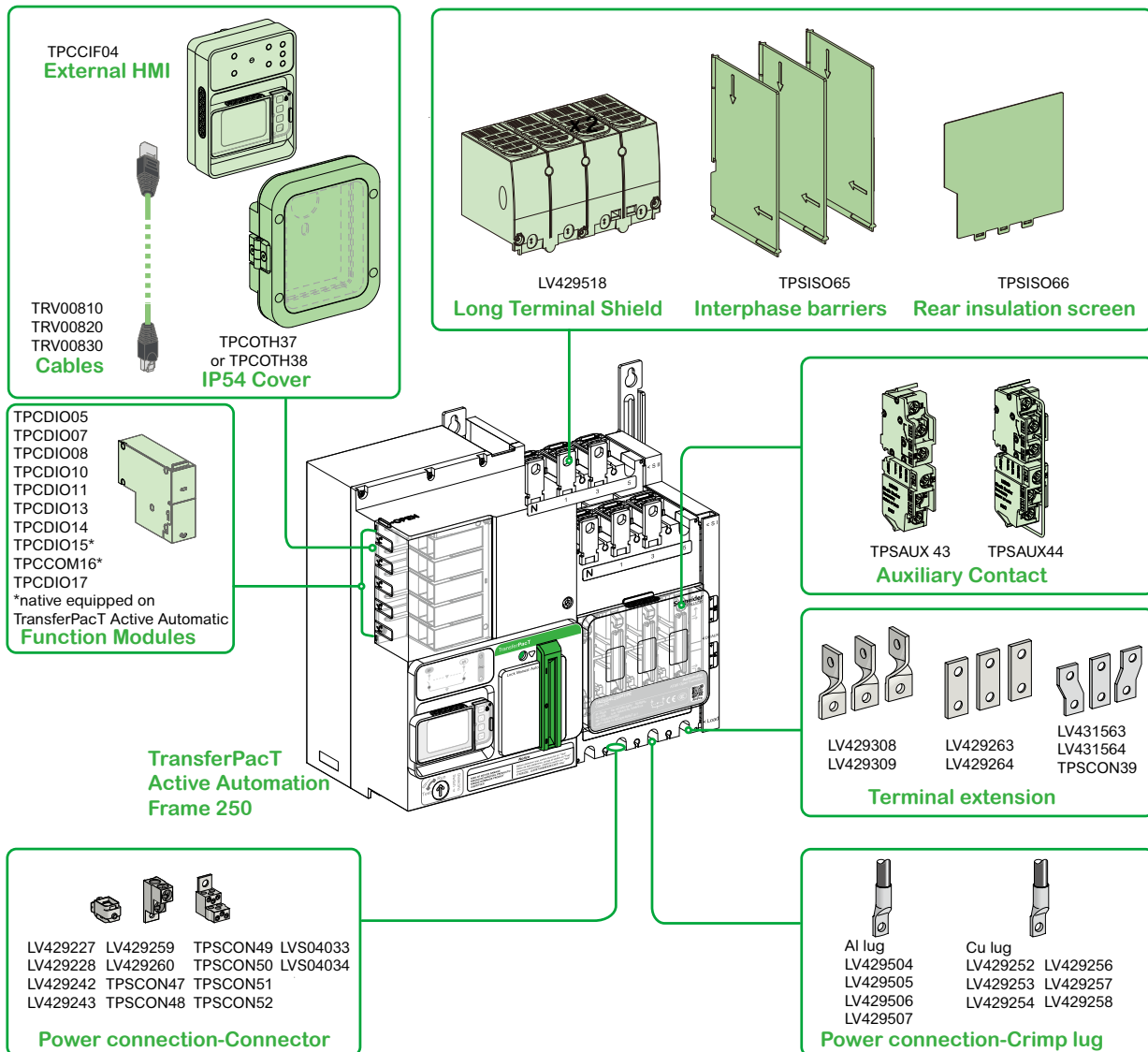

Electrical and Mechanical Accessories- Frame 250

Auxiliary Contact Module

- TPSAUX43: Provide the open and closed status indication for both source I and source II .
- TPSAUX44: Provide the open and closed status indication for OFF position.

Insulating Accessories

Terminal Shield

Optional accessory, Provide terminal protection on the cable incoming and output.

- LV429518: Terminal Shield (set of 1)

Interphase Barrier

Optional accessory, Provide protection for the cable incoming and output, effectively avoiding short circuits between phases.

- TPSISO65: Interphase barriers (set of 3)

Insulation Screen

Optional accessory, Provide protection for the cable incoming and output.

- TPSISO66: Insulating screen. Applicable for source II only, maximum 1 set.

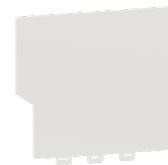

A

Electrical and Mechanical Accessories- Frame 250

Connection Accessories

Bare Cable Connector

Cable material	number	Cross section	Pole	Commercial reference	Quantity
Aluminum/Copper	1 cable	25 to 95 mm ²	3P	LV429227	3
			4P	LV429228	4
		120 to 185 mm ²	3P	LV429259	3
			4P	LV429260	4
		120 to 240 mm ²	3P	TPSCON49 ^b	3
			4P	TPSCON50 ^b	4
	2 cables	50 to 120 mm ²	3P	TPSCON51 ^{a,b}	3
			4P	TPSCON52 ^{a,b}	4
	6 cables	1.5 to 35 mm ²	3P	TPSCON47 ^b	3
			4P	TPSCON48 ^b	4
9 cables		3P	LVS04033 ^a	3	
		4P	LVS04034 ^a	4	
steel	1 cable	1.5 to 95 mm ²	3P	LV429242	3
			4P	LV429243	4

a: Applicable for load side only

b: Must select terminal shield to ensure incoming and output terminal protection.

Electrical and Mechanical Accessories- Frame 250

Crimp Lug for Cables

- Natively supplied with interphase barriers.

Cable material	Cross section	Pole	Commercial reference	Quantity
Aluminum	150 mm ²	3P	LV429504	3
		4P	LV429505	4
	185 mm ²	3P	LV429506	3
		4P	LV429507	4
Copper	120 mm ²	3P	LV429252	3
		4P	LV429256	4
	150 mm ²	3P	LV429253	3
		4P	LV429257	4
	185 mm ²	3P	LV429254	3
		4P	LV429258	4



Terminal Extension

- Natively supplied with interphase barriers.

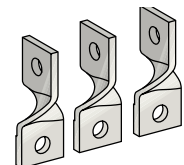
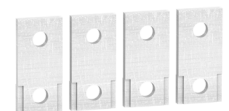

Type	Pole	Commercial reference	Quantity
Spreaders			
35-45 mm	3P	LV431563	3
	4P	LV431564 ^b	4
	4P	TPSCON39 ^a	4
Straight			
	3P	LV429263	3
	4P	LV429264	4
Edge wise			
	3P	LV429308	3
	4P	LV429309	4



a: For incomings only
b: For load only.

Electrical and Mechanical Accessories- Frame 250

Compatibility Matrix

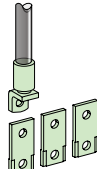
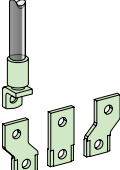
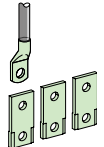
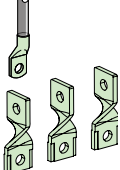
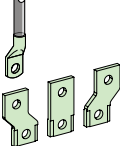
Type of conductor	No insulation	Interphase barrier	Long terminal shield	Insulating screen for 1 lug per terminal	Insulating screen for 2 lugs per terminal
 <p>Cables(Al) +crimp lugs</p>	-	Mandatory (Supplied)	Possible	-	-
 <p>Cables(Cu) +crimp lugs</p>	-	Mandatory (Supplied)	Possible	Possible	Possible
 <p>Cables (Al) + crimp lugs + straight terminal extensions</p>	-	Mandatory (Supplied)	-	Mandatory	-
 <p>Cables (Al) + crimp lugs + Spreaders terminal extensions</p>	-	Mandatory (Supplied)	-	Mandatory	-
 <p>Cables (Cu) + crimp lugs + straight terminal extensions</p>	-	Mandatory (Supplied)	-	Mandatory	NA/Mandatory (120 mm 2 only)
 <p>Cables (Cu) + crimp lugs + edgewise terminal extensions</p>	-	Mandatory (Supplied)	-	Possible	-
 <p>Cables (Cu) +crimp lugs +Spreader terminal extensions</p>	-	Mandatory (Supplied)	-	Mandatory	NA/Mandatory (120 mm 2 only)

Electrical and Mechanical Accessories- Frame 250

Compatibility Matrix

Type of conductor	No insulation	Interphase barrier	Long terminal shield	Insulating screen
Cables +Steel connectors LV429242 LV429243	Possible	Possible	Possible	-
Cables +Alluminum connectors TPSCON47 TPSCON48 TPSCON49 TPSCON50 TPSCON51 TPSCON52	-	-	Mandatory	-
Cables +connectors +Alluminum connectors LV429227 LV429259 LV429228 LV429260	Possible	Possible	Possible	-
Insulated bars	Possible	Possible	Possible	Possible
Insulated bars +straight terminal extension	Mandatory (supplied)	-	-	Mandatory
Insulated bars +edgewise terminal extension	Mandatory (supplied)	-	-	Possible
Insulated bars +spreader terminal extension	Mandatory (supplied)	-	-	Mandatory

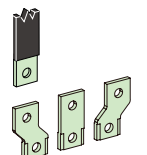
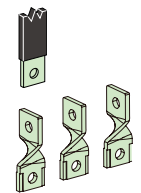
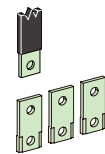
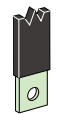
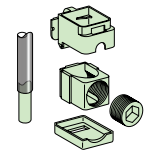
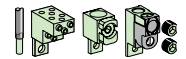
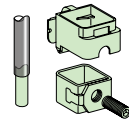

A

Electrical and Mechanical Accessories- Frame 630

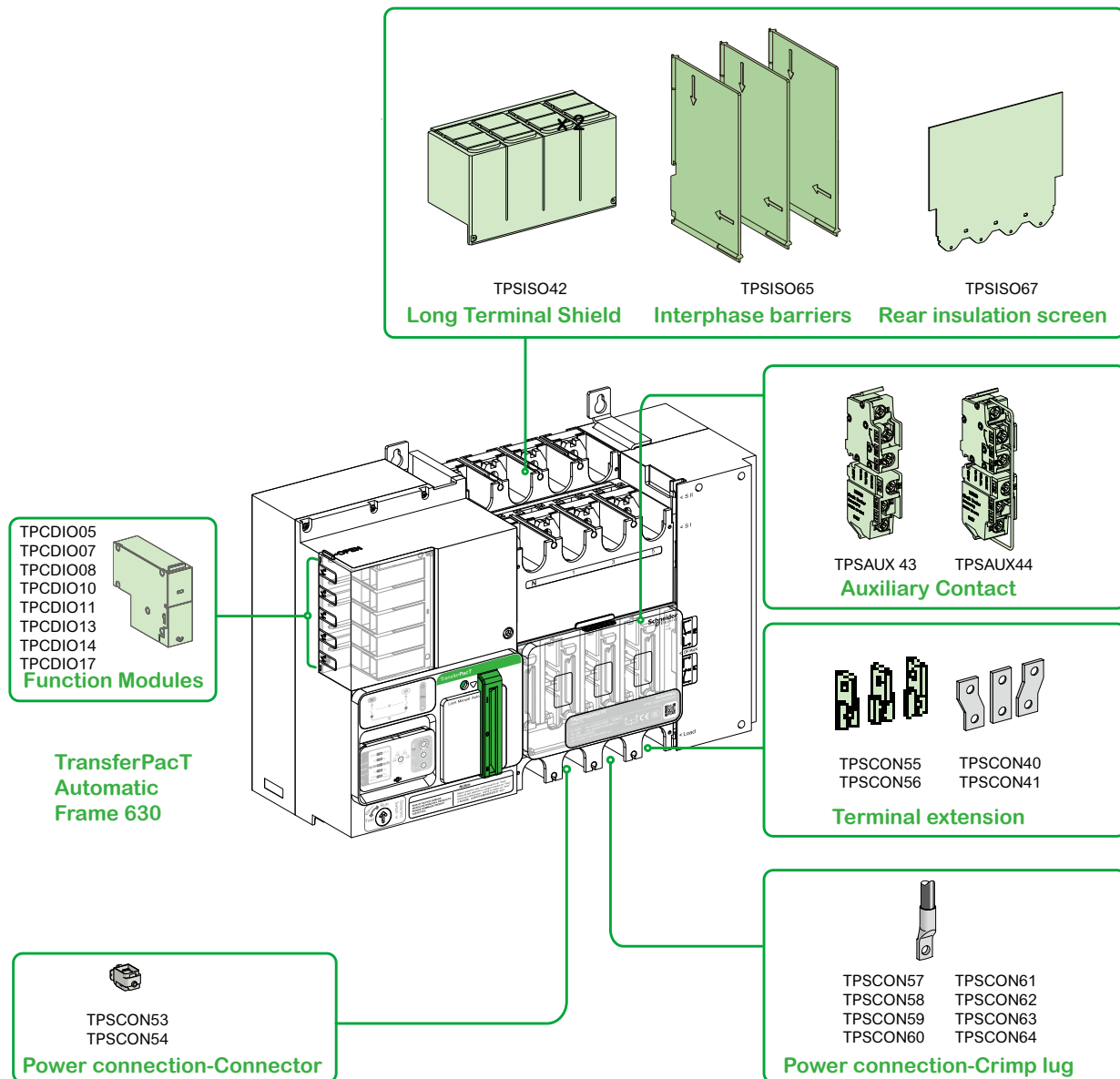

Electrical and Mechanical Accessories- Frame 630

A

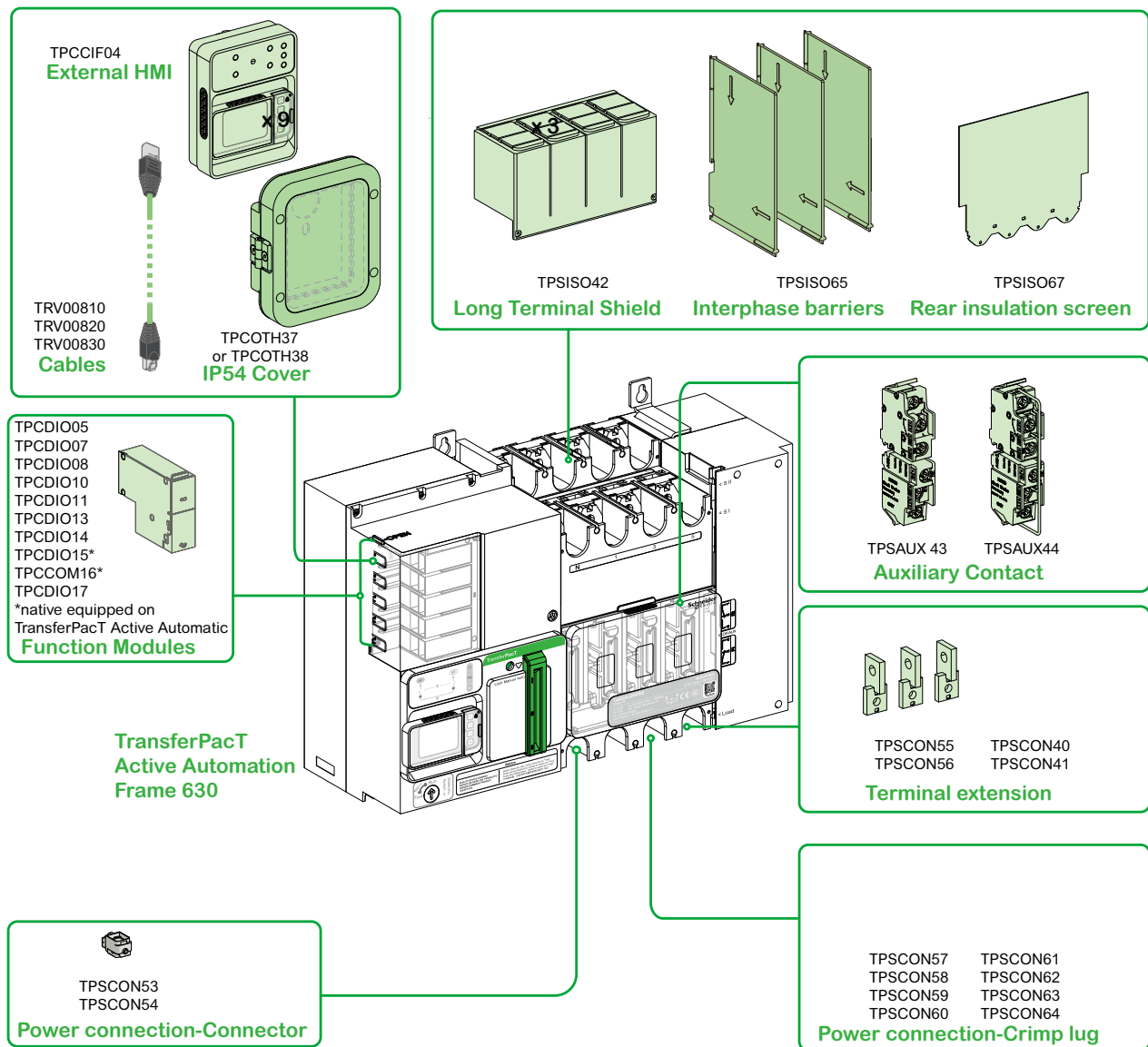

Electrical and Mechanical Accessories- Frame 630

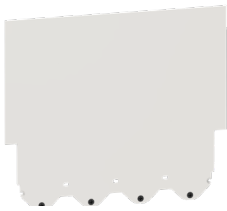

Auxiliary Contact Module

- TPSAUX43: Provide the open and closed status indication for both source I and source II .
- TPSAUX44: Provide the open and closed status indication for OFF position .

Insulating Accessories

Terminal Shield

Optional accessory, Provide terminal protection on the cable incoming and output.

- TPSISO42: Terminal Shield (set of 1)

Interphase Barrier

Optional accessory, Provide protection for the cable incoming and output, effectively avoiding short circuits between phases.

- TPSISO65: Interphase barriers (set of 3)

Insulation Screen

Optional accessory, Provide protection for the cable incoming and output.

- TPSISO67: Insulating screen (set of 1). Applicable for source and load, maximum 3 set.

Electrical and Mechanical Accessories- Frame 630

Connection Accessories

Bare Cable Connector

Cable Material	Number	Cross Section	Pole	Commercial Reference	Quantity
Aluminum/Copper	1 cable	35 to 300 mm ²	3P	TPSCON53 ^b	3
			4P	TPSCON54 ^b	4



b: Must select terminal shield to ensure incoming and output terminal protection.

Crimp Lug for Cables

- Natively supplied with interphase barriers.

Cable Material	Cross Section	Pole	Commercial Reference	Quantity
Aluminum	240 mm ²	3P	TPSCON61	3
		4P	TPSCON62	4
	300 mm ²	3P	TPSCON63	3
		4P	TPSCON64	4
Copper	240 mm ²	3P	TPSCON57	3
		4P	TPSCON58	4
	300 mm ²	3P	TPSCON59	3
		4P	TPSCON60	4



Terminal Extension

- Natively supplied with interphase barriers.

Type	Pole	Commercial Reference	Quantity
Spreaders 45-55 mm	3P	TPSCON40	3
	4P	TPSCON41 ^a	4
	4P	TPSCON68 ^b	4
Edge wise	3P	TPSCON55	3
	4P	TPSCON56	4



a: For incomings only
b: For load only.

Electrical and Mechanical Accessories- Frame 630

Compatibility Matrix

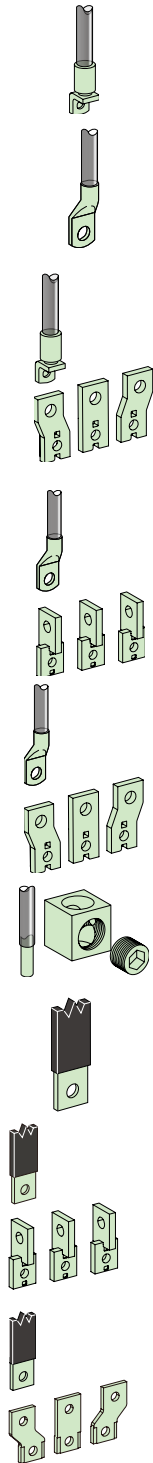

Type of Conductor	No Insulation	Interphase Barrier	Long Terminal Shield	Insulating Screen for 1 Lug per Terminal	Insulating Screen for 2 Lugs per Terminal
Cables (Al) +crimp lugs	-	Mandatory (Supplied)	Possible (instead of phase barriers)	SI: front screen mandatory Load: front screen mandatory	-
Cables (Cu) +crimp lugs	-	Mandatory (Supplied)	Possible (instead of phase barriers)	SII: rear screen possible	SII: rear screen mandatory
Cables (Alu) +crimp lugs +Spreaders terminal extensions	-	Mandatory (Supplied)		SI: front screen mandatory SII: rear screen mandatory Load: front screen mandatory	-
Cables (Cu) +crimp lugs + edgewise terminal extensions	-	Mandatory (Supplied)	-	Possible	-
Cables (Alu) +crimp lugs +Spreaders terminal extensions	-	Mandatory (Supplied)	-	SI: front screen mandatory SII: rear screen mandatory Load: front screen mandatory	SI: front screen mandatory SII: rear screen mandatory Load: front screen mandatory
cables+ aluminum connectors	-	-	Mandatory	-	-
Insulated bars	Possible	Possible	Possible	Possible	-
Insulated bars +edgewise terminal extension	-	Mandatory (supplied)	-	Possible	-
Insulated bars +spreader terminal extension	-	Mandatory (supplied)	-	Mandatory	-

Electrical and Mechanical Accessories- Frame 800

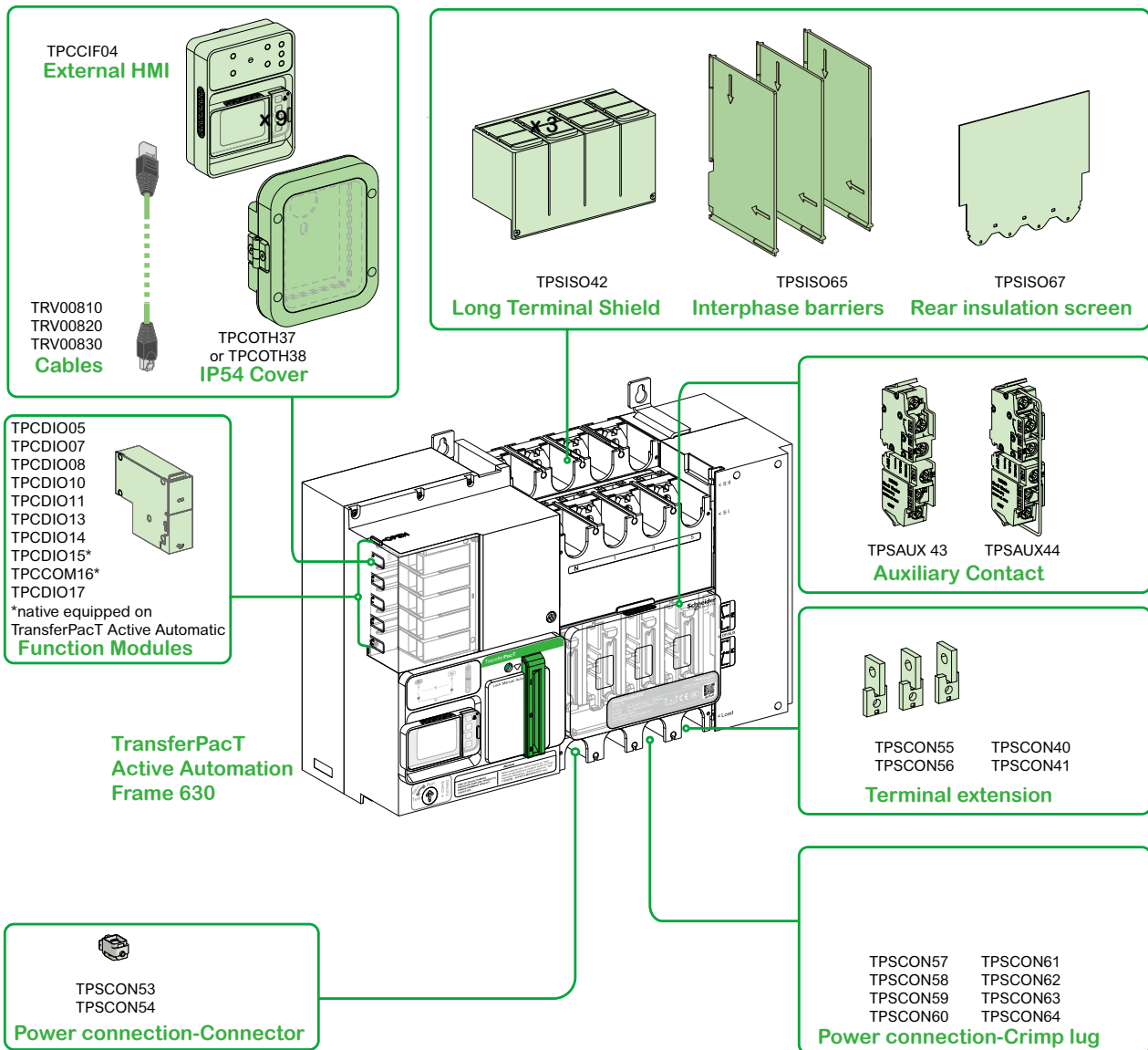

Electrical and Mechanical Accessories- Frame 800

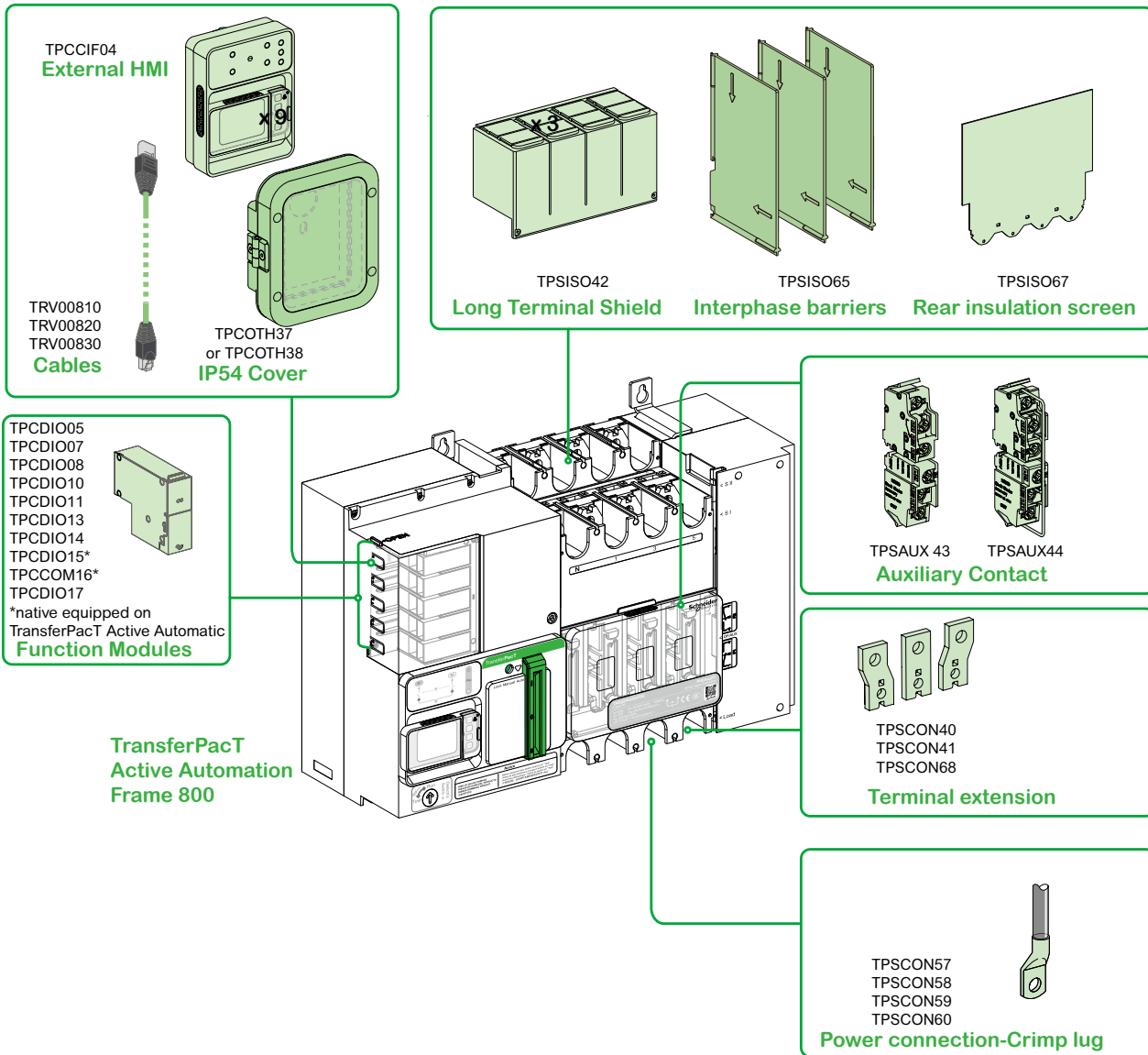

Electrical and Mechanical Accessories- Frame 800



Auxiliary Contact Module

- TPSAUX43: Provide the open and closed status indication for both source I and source II .
- TPSAUX44: Provide the open and closed status indication for OFF position .

Insulating Accessories

Terminal Shield

Optional accessory: Provide terminal protection on the bar incoming and output.

- TPSISO42: Terminal Shield (set of 1)

Interphase Barrier

Optional accessory: Provide protection for the cable incoming and output, effectively avoiding short circuits between phases.

- TPSISO65: Interphase barriers (set of 3)

Insulation Screen

Optional accessory: Provide protection for the cable incoming and output.

- TPSISO67: Insulating screen (set of 1). Applicable for source and load, maximum 3 set.

A

Electrical and Mechanical Accessories- Frame 800

Crimp Lug for Cables

- Natively supplied with interphase barriers.

Cable Material	Cross Section	Pole	Commercial Reference	Quantity
Copper	240 mm ²	3P	TPSCON57	3
		4P	TPSCON58	4
	300 mm ²	3P	TPSCON59	3
		4P	TPSCON60	4



Terminal Extension

- Natively supplied with interphase barriers.

Type	Pole	Commercial Reference	Quantity
Spreaders			
45-55 mm	3P	TPSCON40	3
	4P	TPSCON41 ^a	4
	4P	TPSCON68 ^b	4



- a:** For incomings only
b: For load only.

Electrical and Mechanical Accessories- Frame 800

Compatibility Matrix

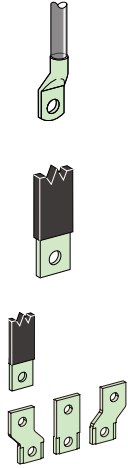

Type of Conductor	No Insulation	Interphase Barrier	Long Terminal Shield	Insulating Screen for 1 Lug per Terminal	Insulating Screen for 2 Lugs per Terminal
Cables (Cu) +crimp lugs	-	Mandatory (Supplied)	-	SII: rear screen possible	SII: rear screen mandatory
Insulated bars	Possible	Possible	Possible	Possible	-
Insulated bars +spreader terminal extension	-	Mandatory (supplied)	-	Mandatory	-



Electrical and Mechanical Accessories- Frame 1600

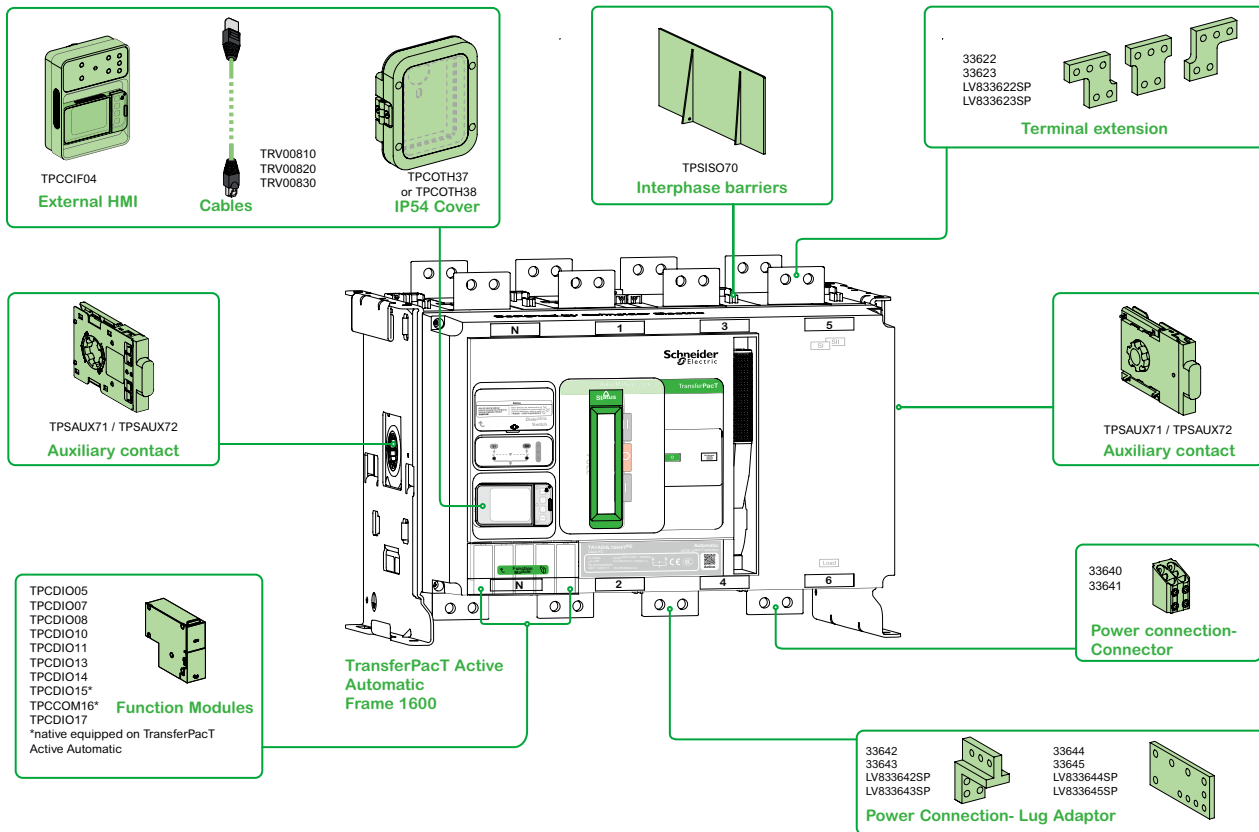

Electrical and Mechanical Accessories- Frame 1600



Auxiliary Contact Module

- TPSAUX71: Provide the open and closed status indication for both source I and source II .
- TPSAUX72: Provide the open and closed status indication for OFF position .

Insulating Accessories

Interphase Barrier

Optional accessory: Provide protection for the cable incoming and output, effectively avoiding short circuits between phases. 3 pieces for Source I & Source II, 3 pieces for load.

- TPSISO70: Interphase barriers (set of 3)

Installation Kit

Optional accessory: Provide upside down installation product.

- TPSOTH73: upside down installation kit (set of 2)

Electrical and Mechanical Accessories- Frame 1600

Crimp Lug for Cables

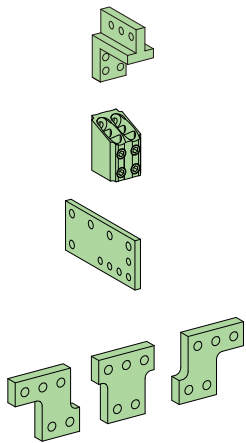

Type	Pole	Commercial Reference	Quantity
Vertical Connection adaptors	3P	33642	3
	4P	33643	4
	3P	LV833642SP	3
	4P	LV833643SP	4
Connectors 240 mm ²	3P	33640	3
	4P	33641	4
Cable lug adaptors	3P	33644	3
	4P	33645	4
	3P	LV833644SP	3
	4P	LV833645SP	4
spreaders 70 mm to 95 mm	3P	33622	3
	4P	33623	4
	3P	LV833622SP	3
	4P	LV833623SP	4

Automatic Transfer Switching Equipment

Class PC

TransferPacT Active Automatic and Automatic Frame 100/2P, 3P, 4P



Minimum Electrical Clearance

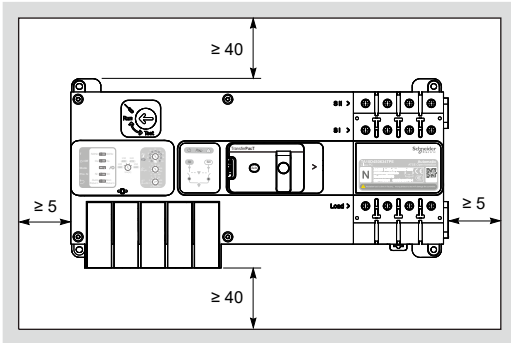

Bare Product

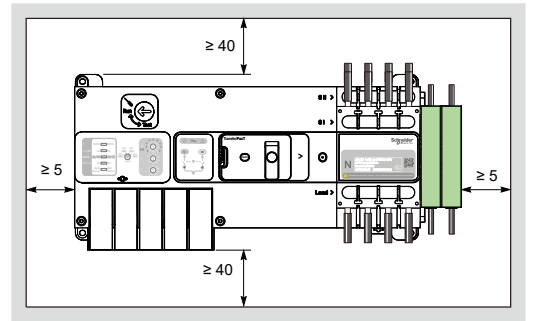

With Auxiliary Contact

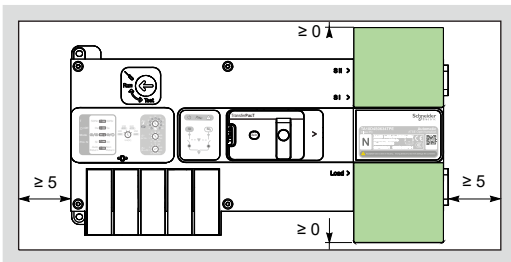

With Terminal Shield

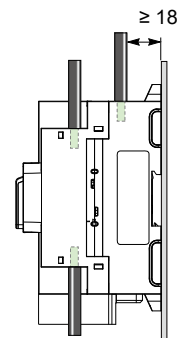
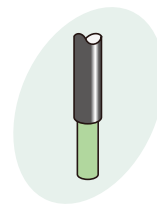

Cable to Base Plate

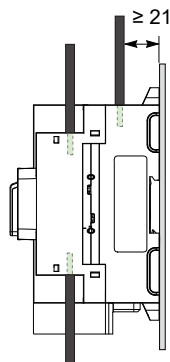
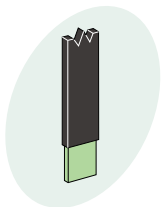

Busbar to Base Plate

Automatic Transfer Switching Equipment

Class PC

TransferPacT Active Automatic and Automatic Frame 160/3P, 4P

Minimum Electrical Clearance

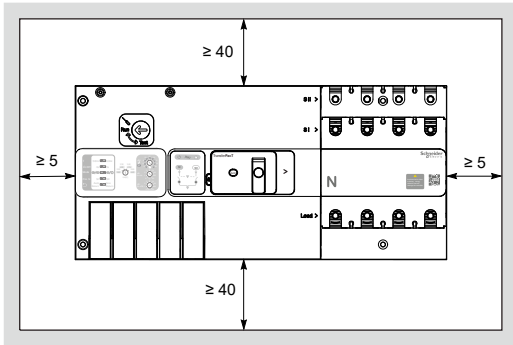

Bare Product

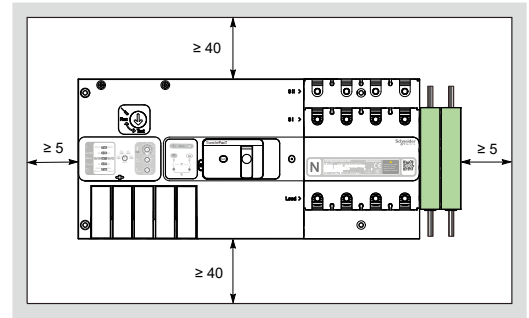

With Auxiliary Contact

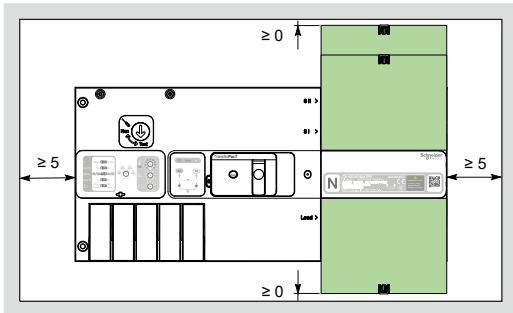

With Terminal Shield

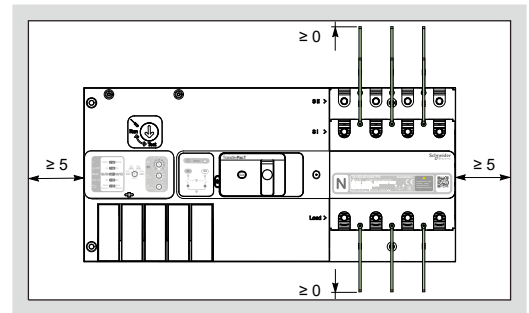

With Interphase Barriers

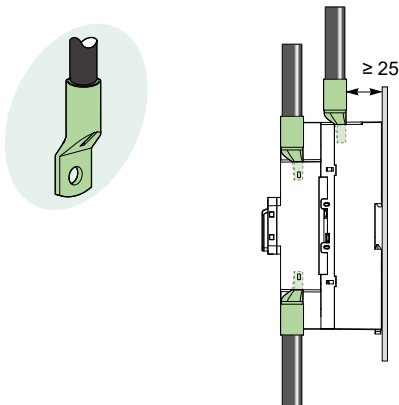

Crimp Lug to Base Plate

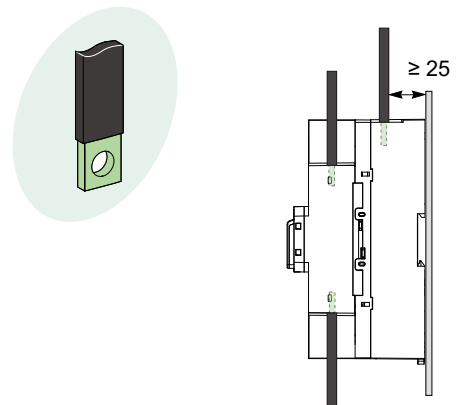

Busbar to Base Plate

Automatic Transfer Switching Equipment

Class PC

TransferPacT Active Automatic and Automatic Frame 250/3P, 4P

A

Minimum Electrical Clearance

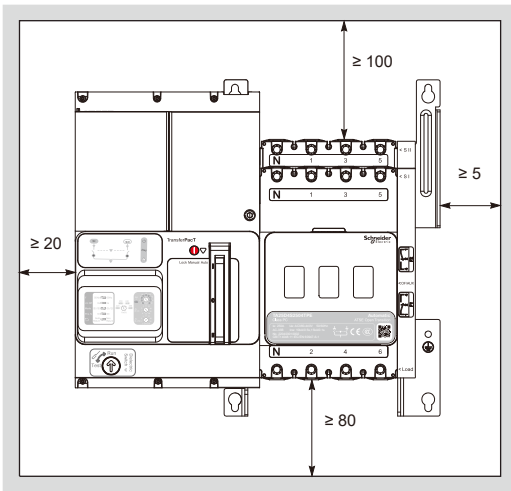

Bare Product

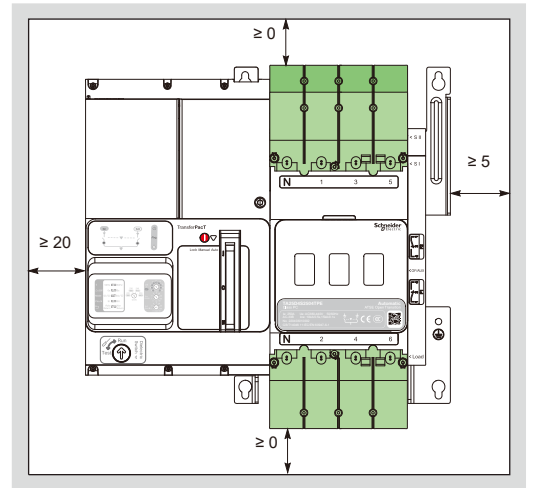

With Terminal Shield

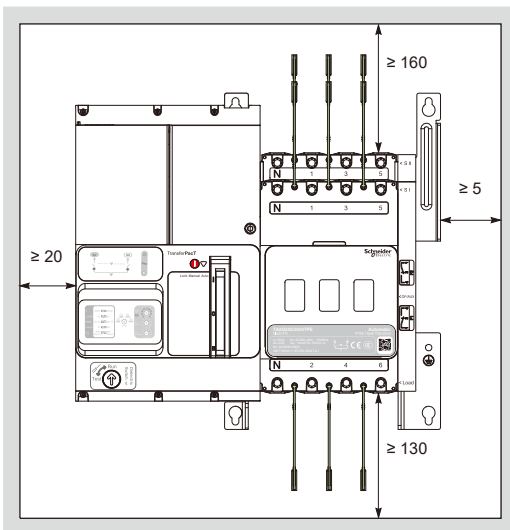

With Interphase Barriers

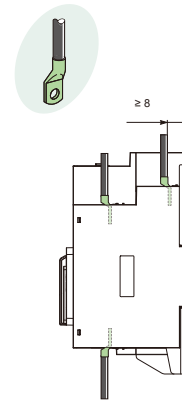

Crimp Lug to Base Plate

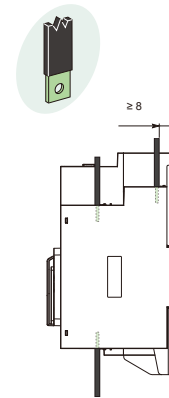

Busbar to Base Plate

Automatic Transfer Switching Equipment

Class PC

TransferPacT Active Automatic and Automatic Frame 630/3P, 4P

Minimum Electrical Clearance

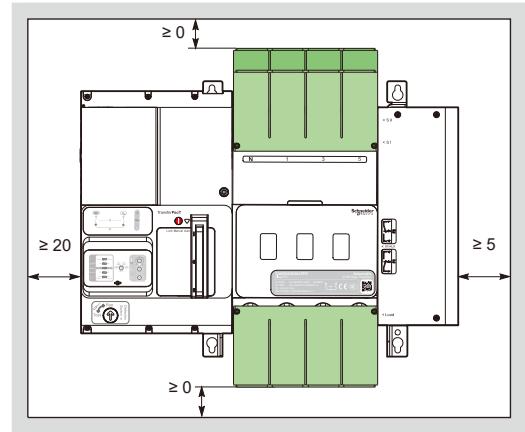
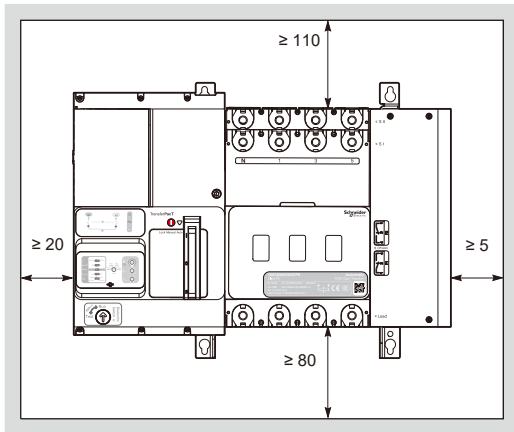

Bare Product

With Terminal Shield

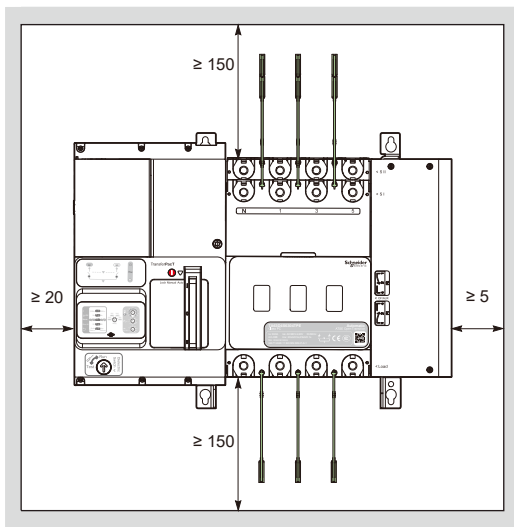

With Interphase Barriers

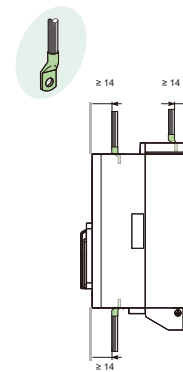

Crimp Lug to Base Plate

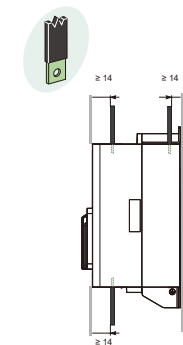

Busbar to Base Plate

Automatic Transfer Switching Equipment

Class PC

TransferPacT Active Automatic and Automatic Frame 800/3P, 4P

A

Minimum Electrical Clearance

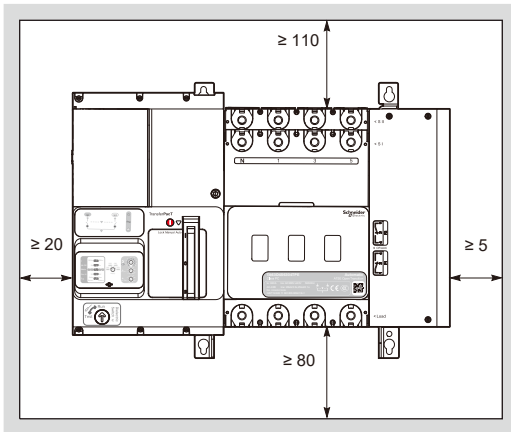

Bare Product

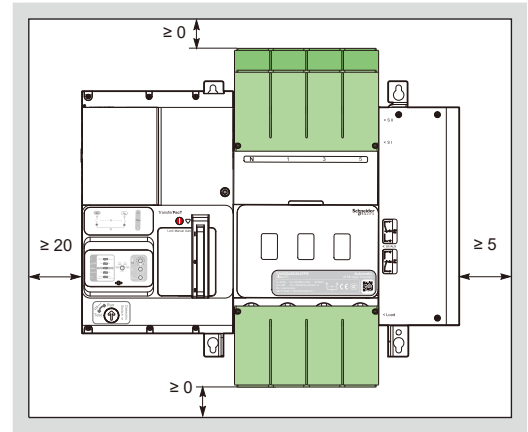

With Terminal Shield

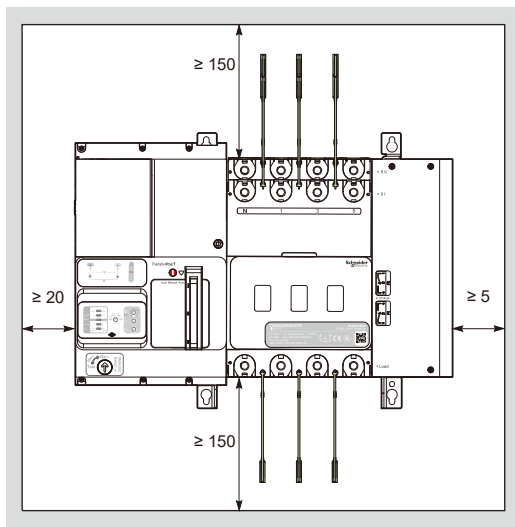

With Interphase Barriers

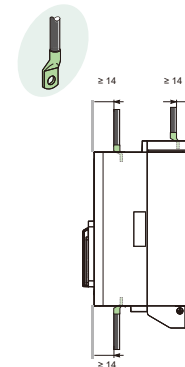

Crimp Lug to Base Plate



Busbar to Base Plate

Automatic Transfer Switching Equipment

Class PC

TransferPacT Active Automatic and Automatic Frame 1600/3P, 4P

Minimum Electrical Clearance

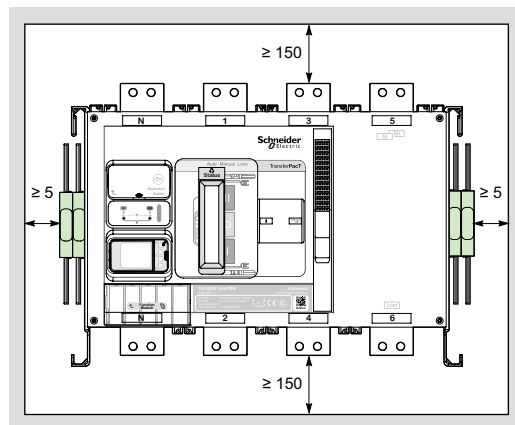
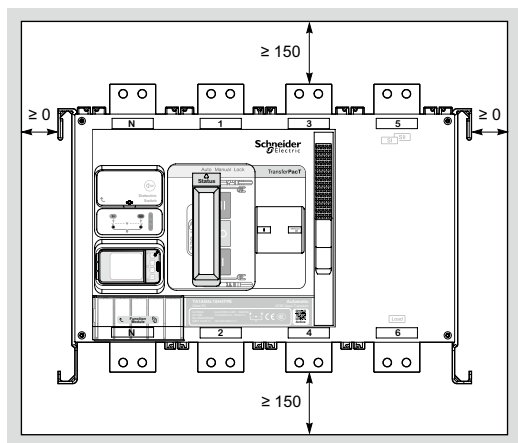

Bare Product

With Auxiliary Contacts

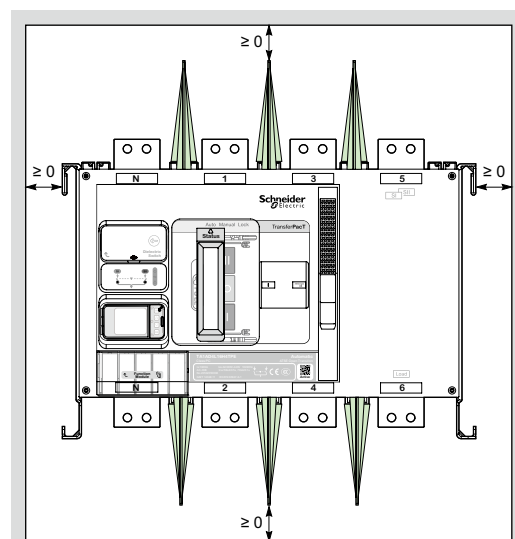
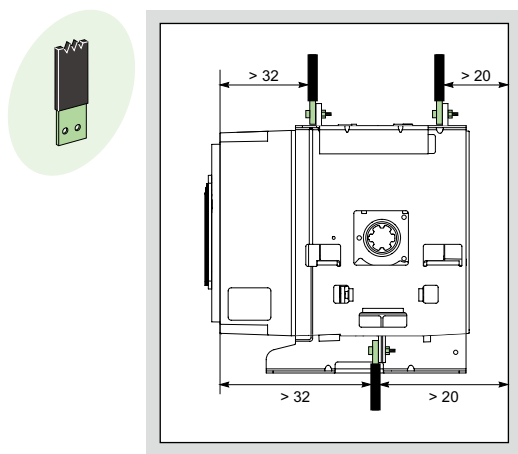

Busbar to panel

With Interphase Barriers

Automatic Transfer Switching Equipment

Class PC

TransferPacT Active Automatic and Automatic Frame 100/2P, 3P, 4P



Dimensions

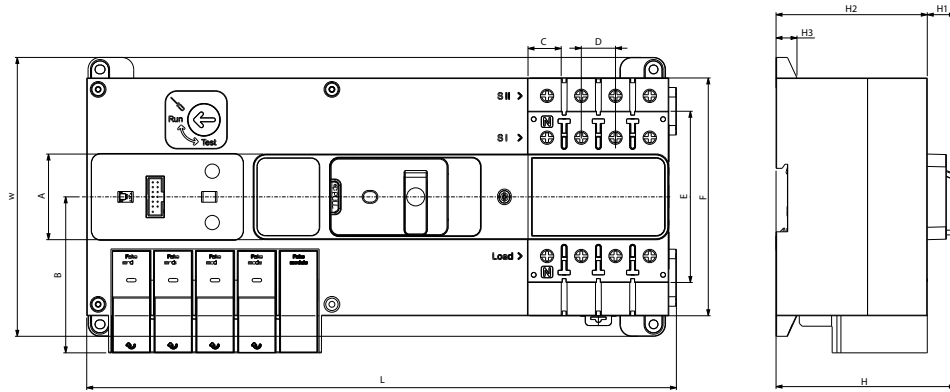

Panel and Front Panel Cut

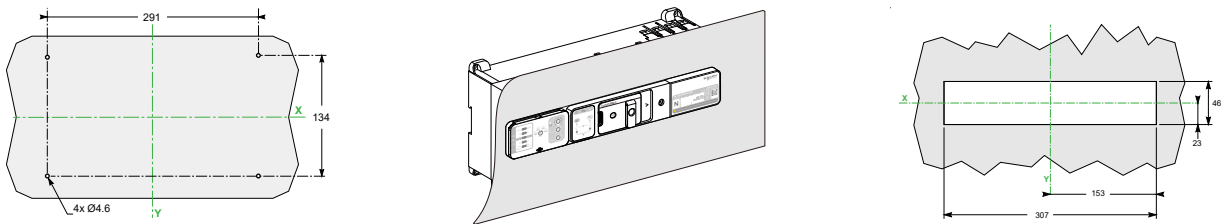

Frame	L	W	H	A	B	C	D	E	F	H1	H2	H3
100	310	147	94	45	82	17.5	18	90	125	15	79.5	11

Automatic Transfer Switching Equipment

Class PC

TransferPacT Active Automatic & Automatic Frame 160 / 3P, 4P

Dimensions

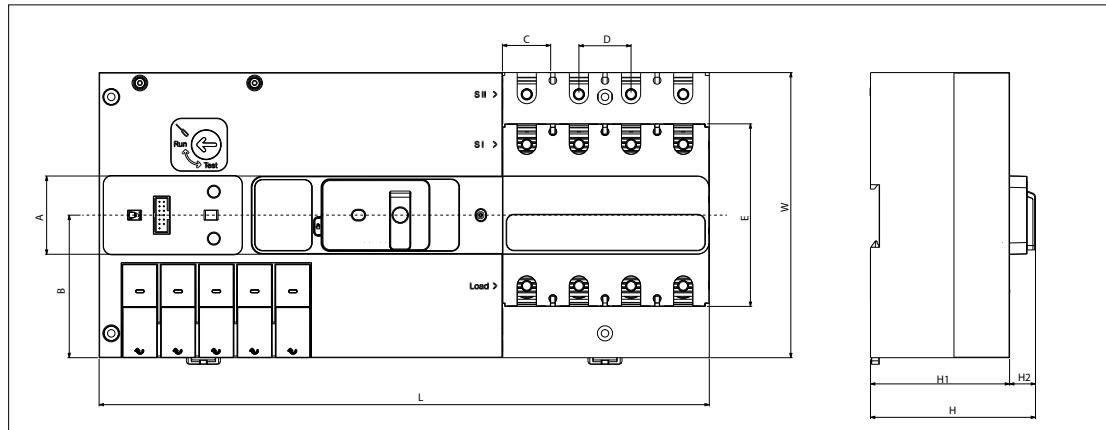

Panel and Front Panel Cut

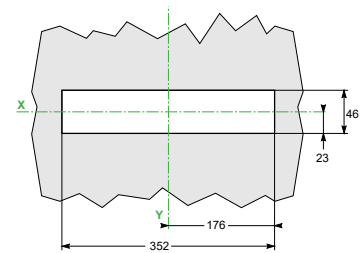
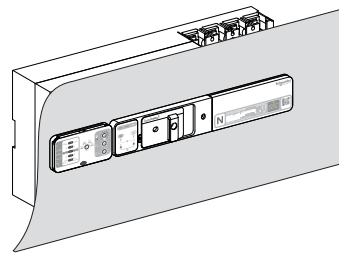
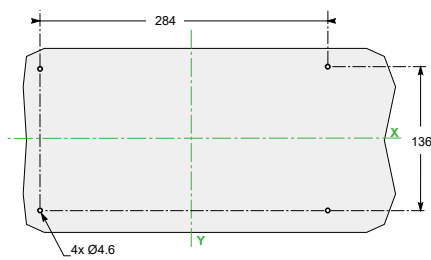

Frame	L	W	H	A	B	C	D	E	F	H1	H2	H3
160	351	164	95	45	82	28	30	105		80	15	

Automatic Transfer Switching Equipment

Class PC

TransferPacT Active Automatic & Automatic Frame 250 / 3P, 4P

Dimensions

A

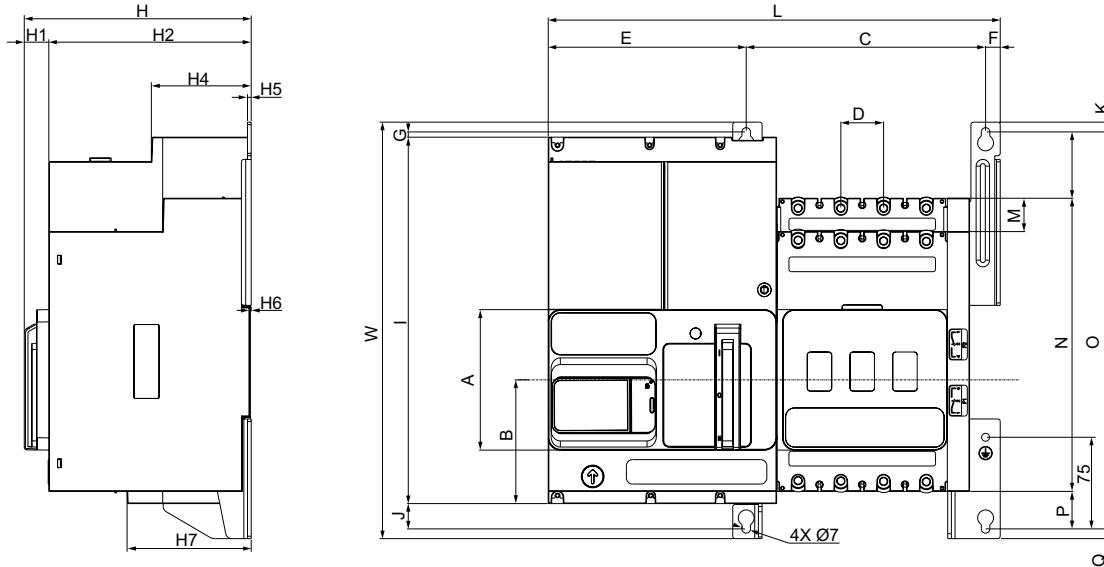

Panel and Front Panel Cut

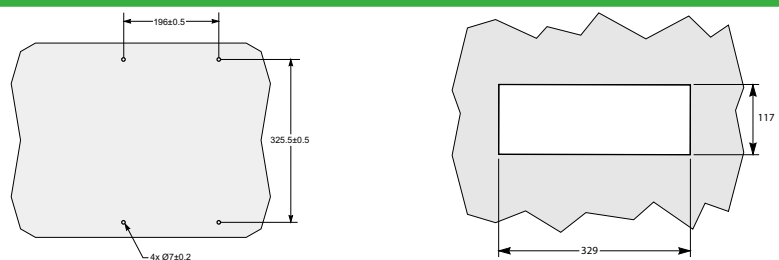

Frame	L	W	H	A	B	C	D	E	F	H1	H2
250	370	341	185.8	115	101.3	196	35	162	12	20.1	165.7

Frame	H4	H5	H6	H7	I	J	K	M	N	O	P	Q
250	81.75	3	0.7	101.6	300	20.7	8	27.3	240	325	30.7	8

Automatic Transfer Switching Equipment

Class PC

TransferPacT Active Automatic&Automatic Frame 630 / 3P, 4P

Dimensions

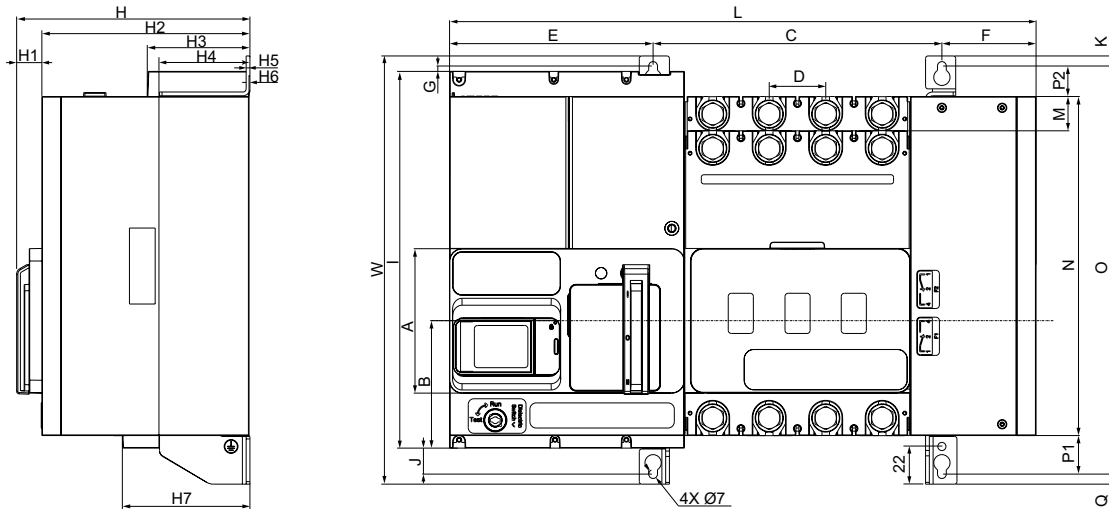

Panel and Front Panel Cut

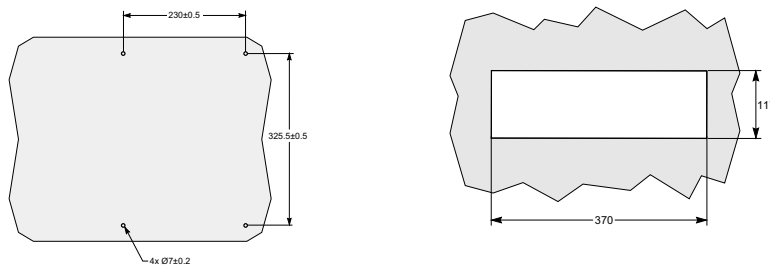

Frame	L	W	H	A	B	C	D	E	F	G	H1	H2	H3
630	467	341	185.8	115	101.5	230	45	162	75	4.3	20.1	165.7	81.7
Frame	H4	H5	H6	H7	I	J	K	M	N	O	P1	P2	Q
630	72.45	3	0.7	101.6	300	20.7	8	27.3	270	325	30.7	24.3	8

Automatic Transfer Switching Equipment

Class PC

TransferPacT Active Automatic&Automatic Frame 800 / 3P, 4P

A

Dimensions

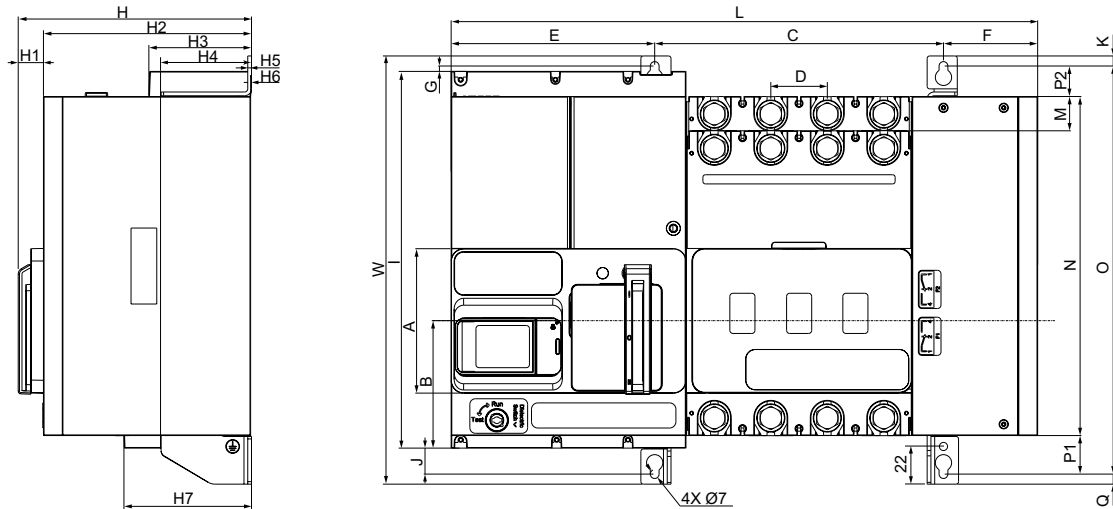

Panel and Front Panel Cut

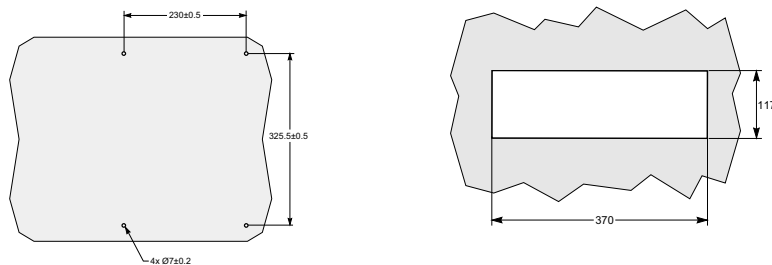

Frame	L	W	H	A	B	C	D	E	F	G	H1	H2	H3
800	467	341	185.8	115	101.5	230	45	162	75	4.3	20.1	165.7	81.7
Frame	H4	H5	H6	H7	I	J	K	M	N	O	P1	P2	Q
800	72.45	3	0.7	101.6	300	20.7	8	27.3	270	325	30.7	24.3	8

Automatic Transfer Switching Equipment

Class PC

TransferPacT Active Automatic&Automatic Frame 1600 / 3P, 4P

Dimensions (mm)

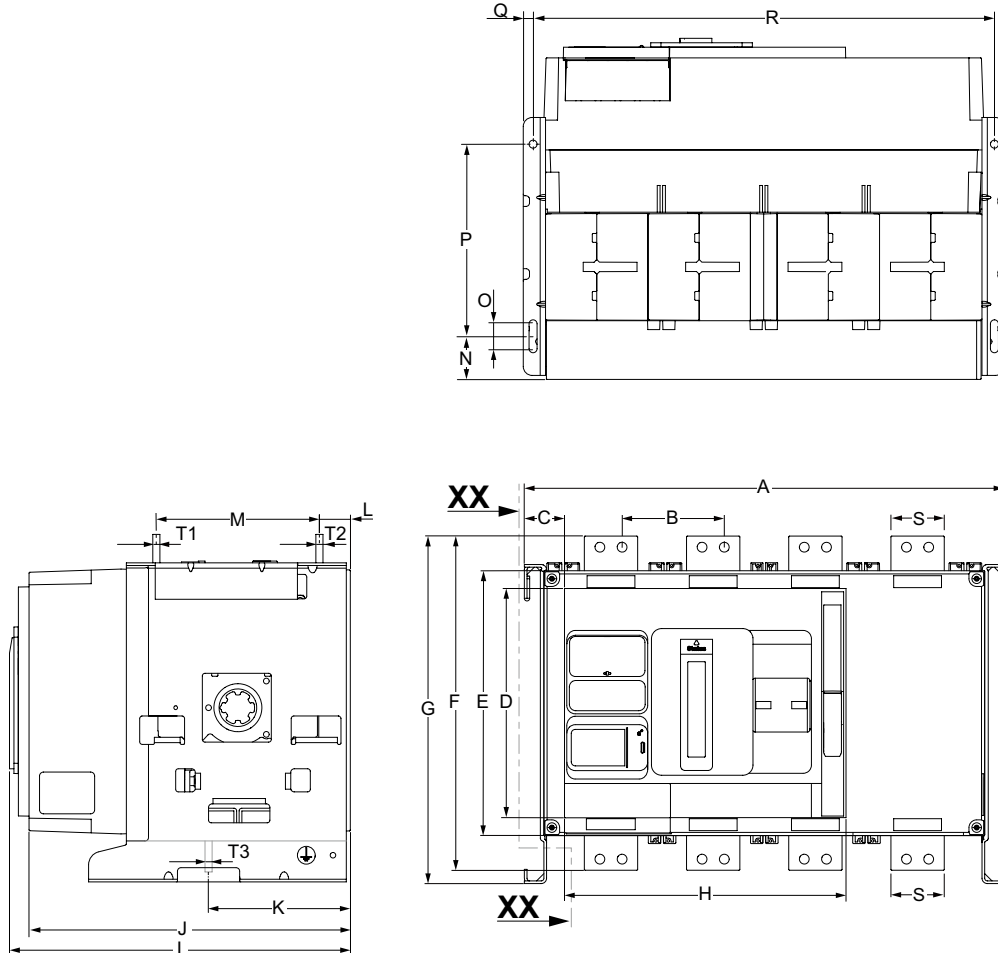

Door Cutout (mm)

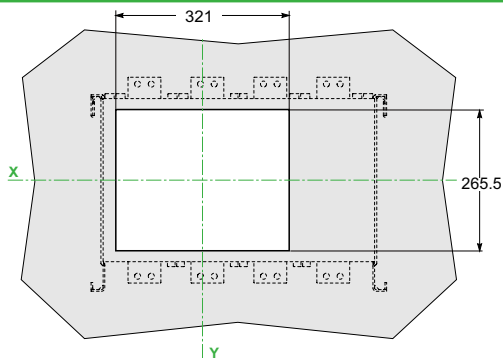

Frame	A	B	C	D	E	F	G	H	I	J	K	L
800-1600 A	540	115	45	258	298	376	391	317	383.5	361.5	126.5	34.75

Frame	M	N	O	P	Q	R	S	T1	T2	T3
800-1250 A	183.5	48.5	28	216	11	518	60	6	6	6
1600 A								8	8	10

Automatic Transfer Switching Equipment

Class PC

TransferPacT Frame 1600 Wring Capacity

Dimensions with Vertical connection Adaptors (mm)

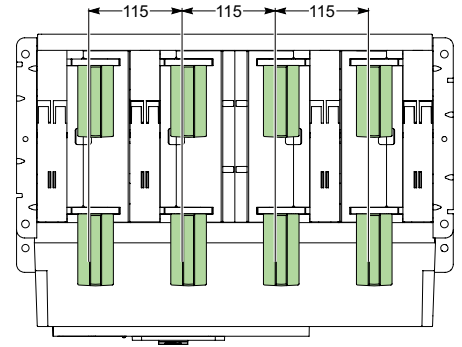
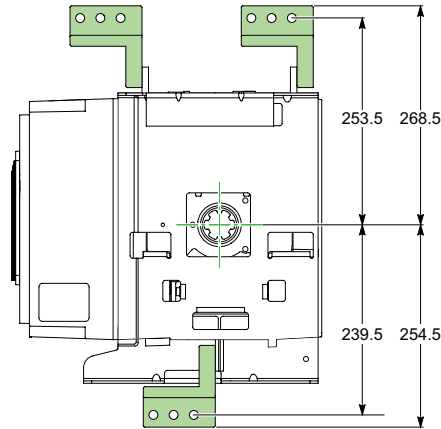
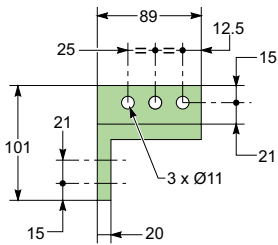

A

Dimension with Cable lug Adaptors (mm)

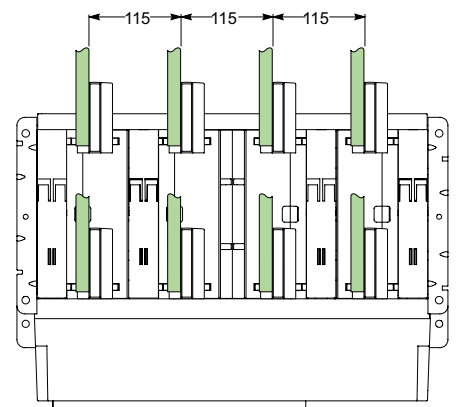
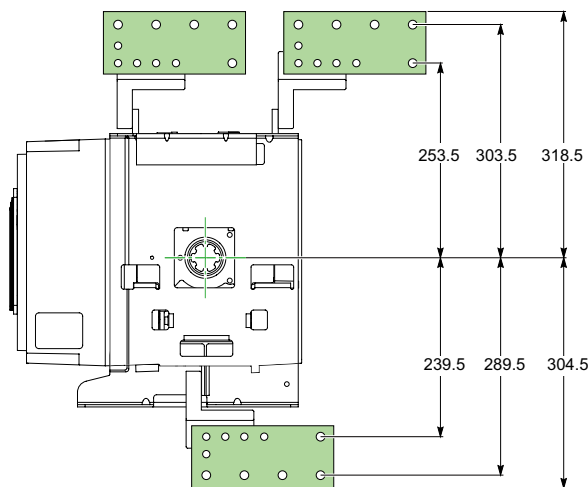
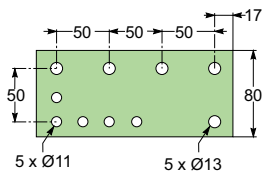

Automatic Transfer Switching Equipment

Class PC

TransferPacT Frame 1600 Wring Capacity

Dimensions with Bare Cable Connector (mm)

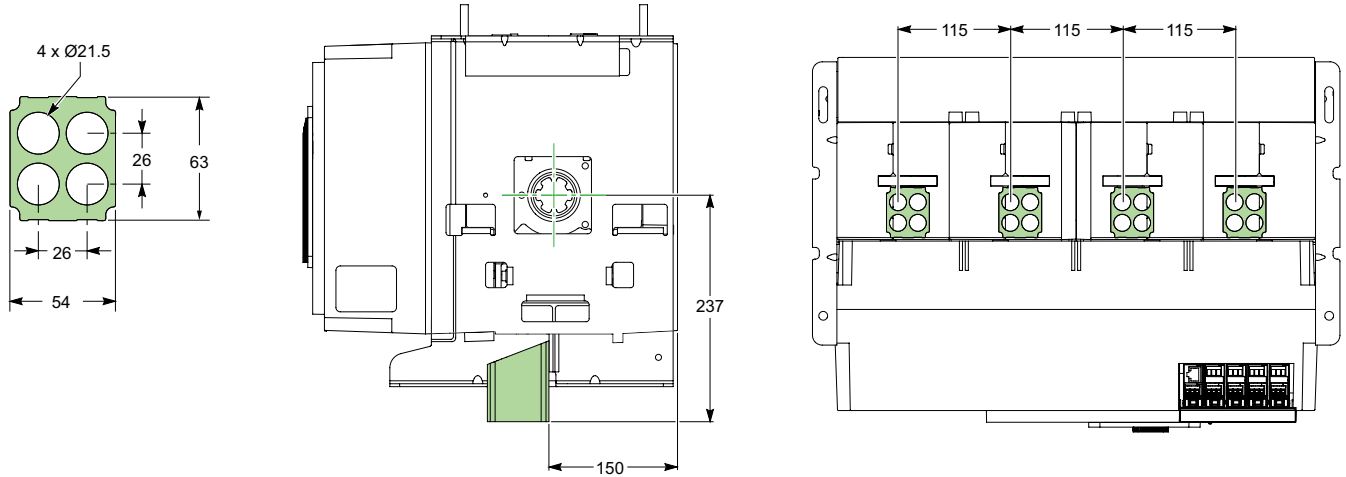

Dimension with Spreaders (mm)

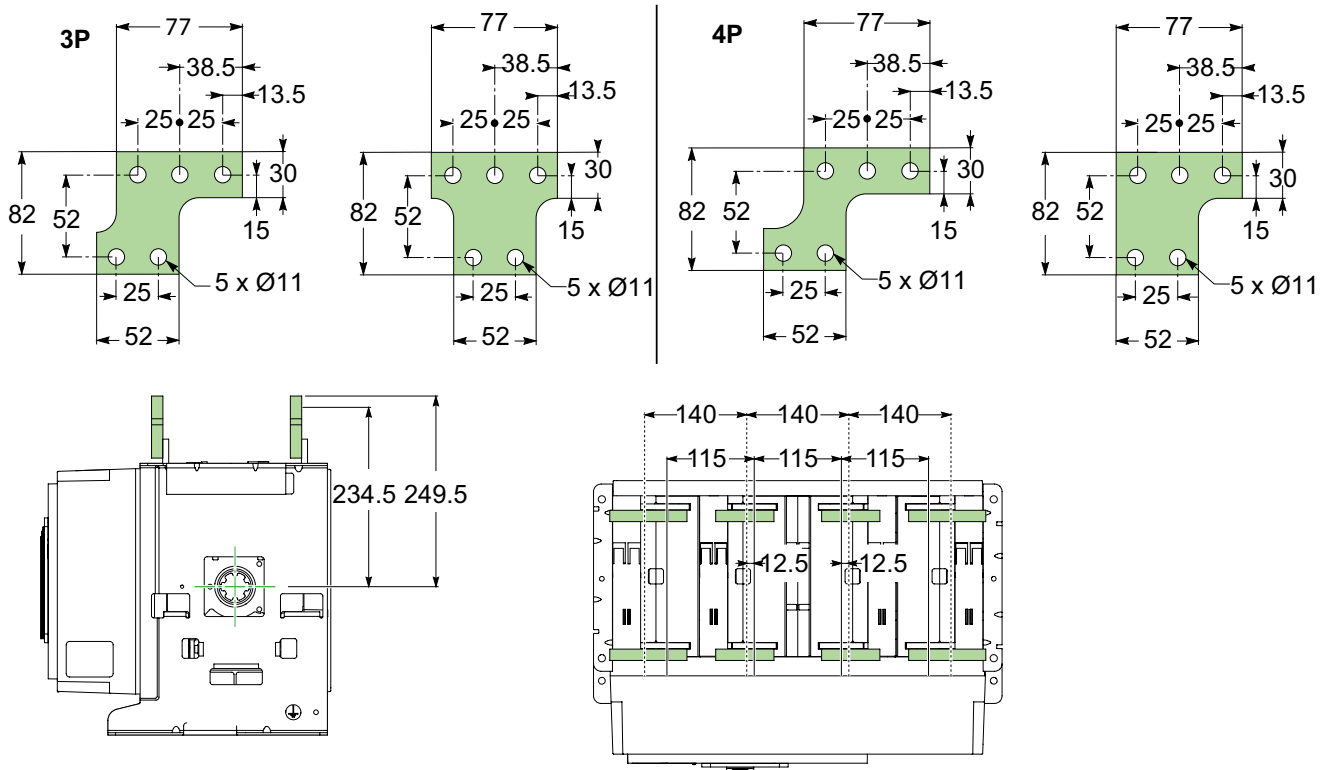

Automatic Transfer Switching Equipment

TransfePacT Active Automatic

Class PC

External HMI

Overview

The external HMI is used to display the HMI on the panel. The HMI consists of external HMI base and a LCD screen.

The external HMI must be connected with the function module with commercial reference as TPCDIO15. The connection of the external HMI is done using a cable and an external HMI base and LCD display.

Position of External HMI and Switch

Perform the following procedure to connect the external HMI on the panel door.

1. Rotate the external HMI to the back side.
2. Remove the nut of external HMI.
3. Insert the external HMI on the front door.

NOTE: Please make the cutout on the front door as per the dimension given.

4. Insert the nut.
5. Lock the nut.
6. Insert the cable into the external HMI.
7. Insert the other end of the cable into the function module (TPCDIO15).

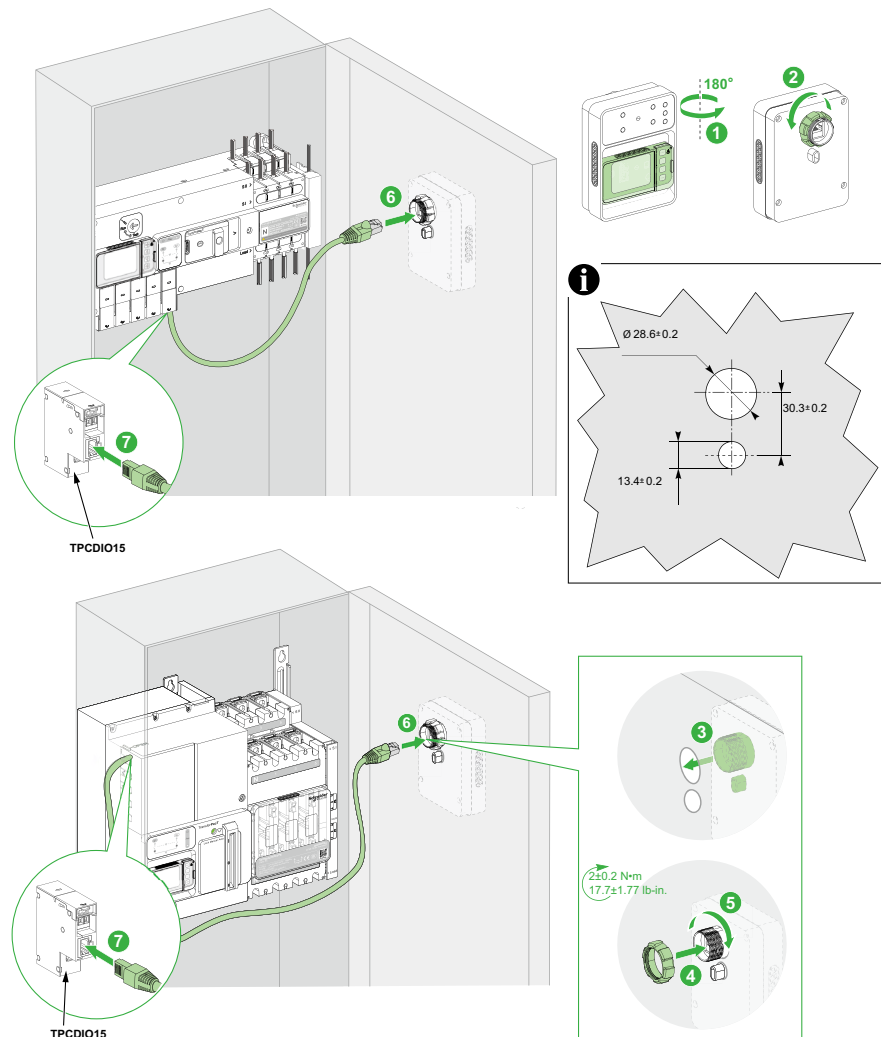

Automatic Transfer Switching Equipment

TransferPacT Active Automatic and Automatic Auxiliary Contact for Frame 100 & Frame 160

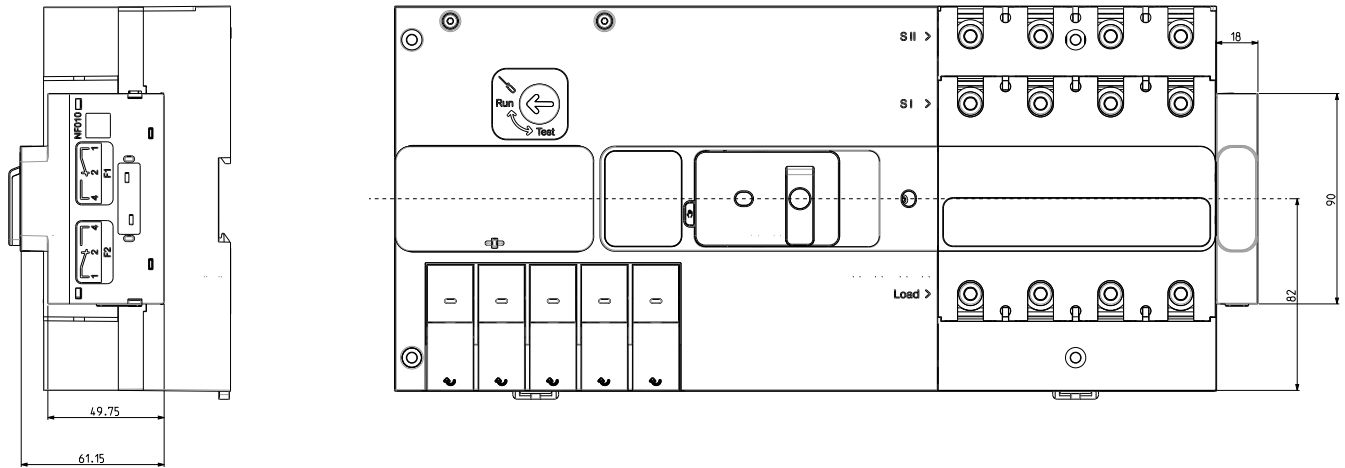

Auxiliary Contact for Frame 250 & Frame 630 & Frame 800

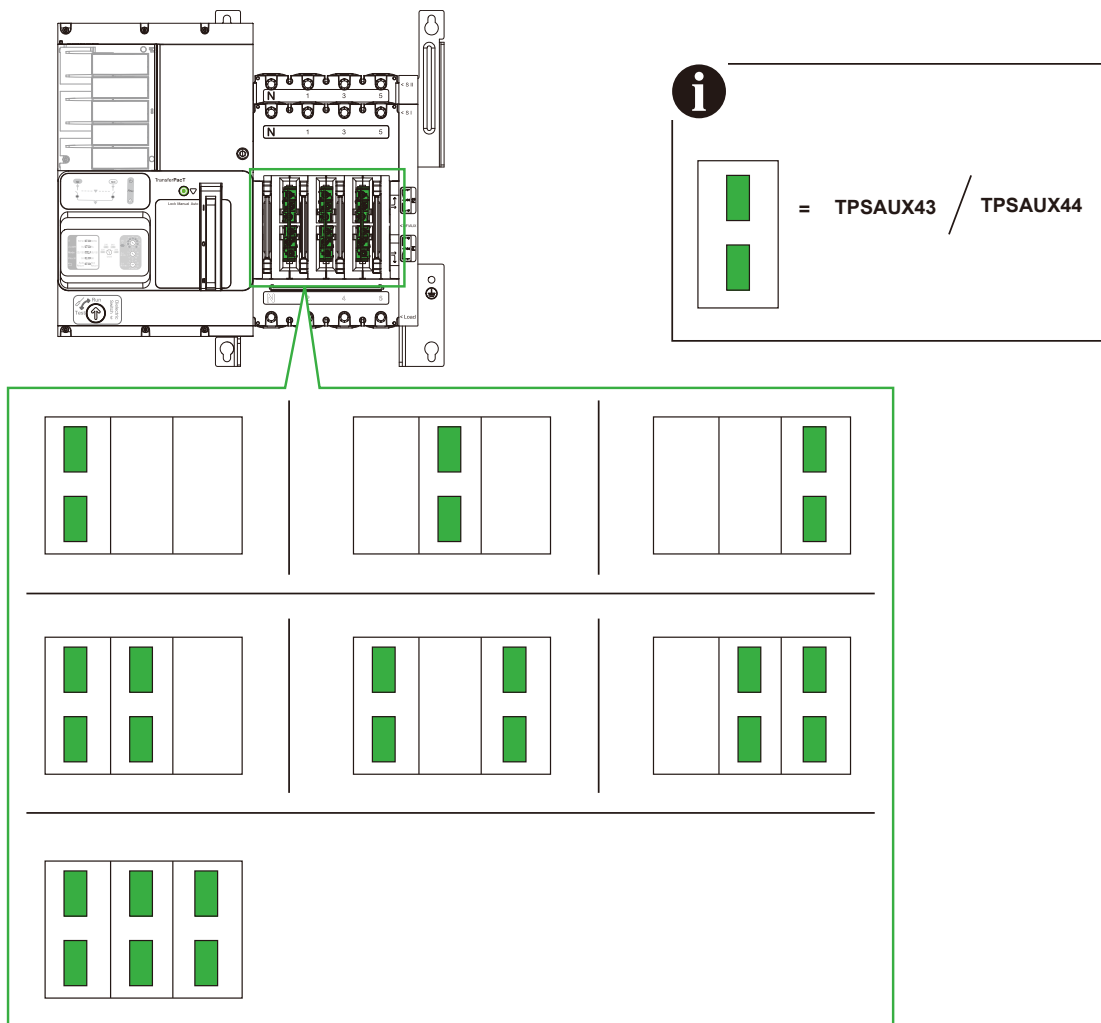

Automatic Transfer Switching Equipment

TransferPacT Active Automatic and Automatic

Auxiliary Contact for Frame 1600

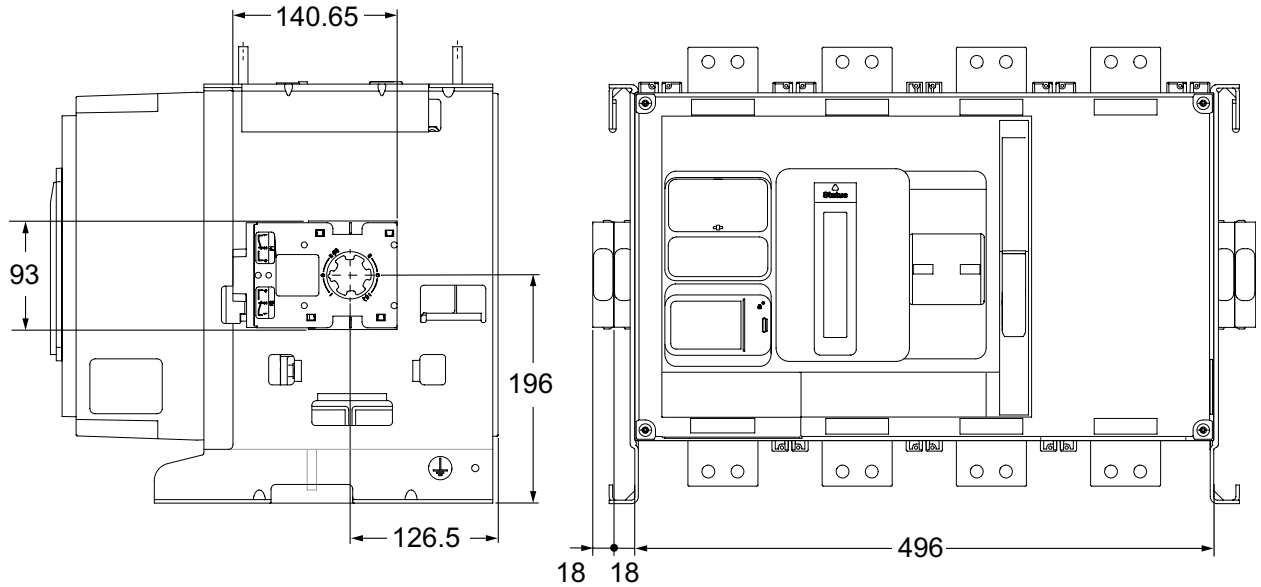

Auxiliary Contact for Frame 1600

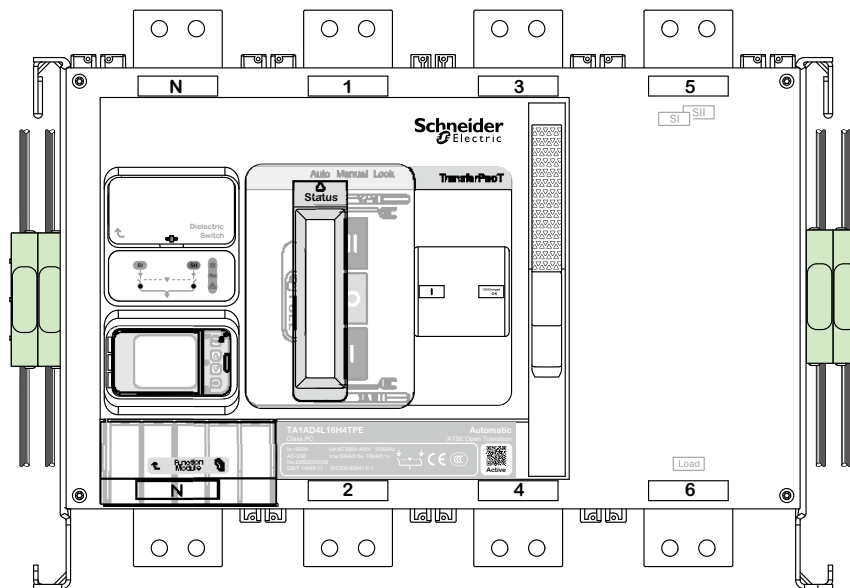

Note: Maximum 4 add on auxiliary contacts (2 on each side) can be installed.

Automatic Transfer Switching Equipment

Class PC

TransferPacT , Frame 100 & Frame 160, Wiring Capacity

Dimensions for Frame 100

Pole partition	(mm)	18
Cable-Rigid Cu/Al	L (mm)	≤ 13
	S (mm ²)	≤ 1.5-35
Cable-Flexible Cu/Al	L (mm)	≤ 13
	S (mm ²)	≤ 1.5-35
Bar	W (mm)	≤ 10
	D (mm)	≤ 5
Torque	(Nm)	3.5±0.3

Dimensions for Frame 160

Pole partition	(mm)	30
Bars	A (mm)	≤ 20
	B (mm)	≤ 6
	C (mm)	≤ 6
	D (mm)	12 ≤ D ≤ 14
	∅ (mm)	≥ 6.4
Cable with Crimp Lug	A (mm)	≤ 20
	B (mm)	≤ 6
	C (mm)	≤ 6
	∅ (mm)	≥ 6.4
Torque	(Nm)	8±0.8

Automatic Transfer Switching Equipment

Class PC

TransferPacT, Frame 250, Wiring Capacity



Dimensions for Frame 250

	Pole partition	(mm)	35
	Bars	A (mm)	≤ 25
		B (mm)	≤ 10
		C (mm)	≤ 6
		D (mm)	10 ≤ D ≤ 15
		Ø (mm)	≥ 8
		Cable with Crimp Lug	
			Ø (mm) ≥ 8
Torque			(Nm) 15±1.5

Connection of Bare Cables to Frame 250

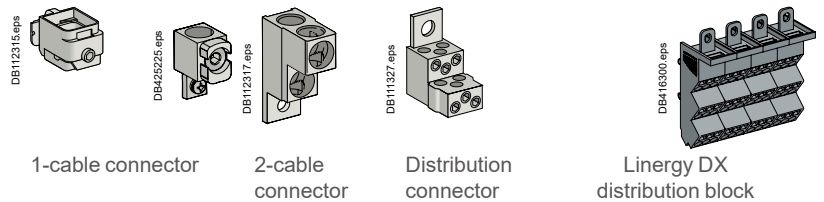

1-cable connector 2-cable connector Distribution connector Linergy DX distribution block

	1-cable connector	Steel ≤ 160 A	Aluminium ≤ 250 A		
	L (mm)	25	25		
	S (mm ²) Cu/Al	1.5 to 95 ^[1]	25 to 50	70 to 95 120 to 240 150 max. flex.	
	Torque (Nm)	12	20	26	31
	2-cable connector				
	L (mm)	25 or 50			
	S (mm ²) Cu/Al	2 x 50 to 2 x 120			
	Torque (Nm)	22			
6-cable distribution connector (aluminium)					
	L (mm)	15 or 30			
	S (mm ²) Cu/Al	1.5 to 6 ^[1]	8 to 35		
	Torque (Nm)	4	6		
Linergy DP distribution block (9 cables)					
	L (mm)	12	16		
	S (mm ²) Cu/Al	6 x 4 to 10	3 x 6 to 16		

[1] For flexible cables from 1.5 to 4 mm², connection with crimped or self-crimping ferrules.

Automatic Transfer Switching Equipment

Class PC

TransferPacT, Frame 630, Wiring Capacity

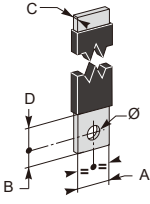
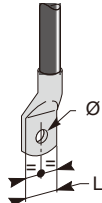
Dimensions for Frame 630			
	Pole partition	(mm)	45
	Bars	A (mm)	≤ 32
		B (mm)	≤ 15
		C (mm)	3 ≤ D ≤ 10
		D (mm)	13 ≤ D ≤ 15
		Ø (mm)	≥ 10
	Cable with Crimp Lug	L (mm)	≤ 25
		Ø (mm)	≥ 10
Torque		(Nm)	50±5

Connection of Bare Cabels to Frame 630

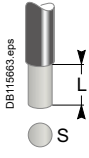

1-cable connector

		1-cable connector	
	L (mm)	30	
	S (mm ²) Cu/Al	35 to 300 rigid 240 max. flex.	
	Torque (Nm)	31	

Automatic Transfer Switching Equipment

Class PC

TransferPacT, Frame 800, Wiring Capacity



Dimensions for Frame 800

	Pole partition	(mm)	45
	Bars	A (mm)	≤ 32
		B (mm)	≤ 15
		C (mm)	8 ≤ D ≤ 17
		D (mm)	13 ≤ D ≤ 15
		Ø (mm)	≥ 10
	Cable with Crimp Lug	L (mm)	≤ 25
		Ø (mm)	≥ 10
	Torque	(Nm)	50±5

Automatic Transfer Switching Equipment

Class PC

TransferPacT, Frame 1600, Wiring Capacity (mm)

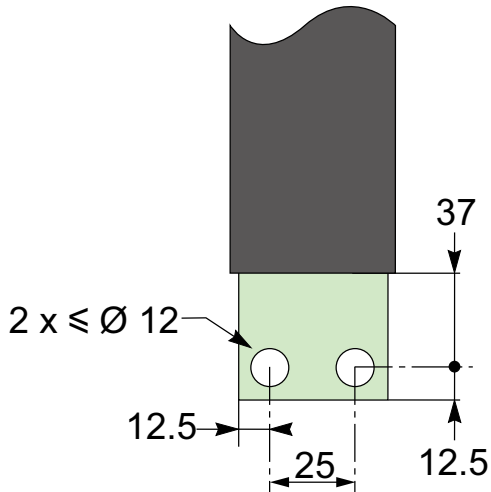

Busbar Connection recommendation

Connection	Service current	Ti : 40 °C		Ti : 50 °C		Ti : 60 °C		Ti : 70 °C	
		No. of 5 mm thick bars	No. of 10 mm thick bars	No. of 5 mm thick bars	No. of 10 mm thick bars	No. of 5 mm thick bars	No. of 10 mm thick bars	No. of 5 mm thick bars	No. of 10 mm thick bars
Horizontal Connection	800	2b.50 x 5	1b.50 x 10	2b.50 x 5	1b.50 x 10	2b.60 x 5	1b.60 x 10	3b.50 x 5	2b.40 x 10
	1000	2b.60 x 5	1b.60 x 10	2b.60 x 5	1b.60 x 10	2b.80 x 5	2b.40 x 10	3b.60 x 5	2b.50 x 10
	1250	3b.50 x 5	2b.40 x 10	3b.50 x 5	2b.40 x 10	3b.60 x 5	2b.50 x 10	3b.80 x 5	2b.60 x 10
	1250	2b.80x5		2b.80x5					
Vertical Connection	1600	3b.80 x 5	2b.60 x 10	3b.80 x 5	2b.60 x 10	3b.100 x 5	3b.50 x 10	3b.100 x 5	2b.80 x 10
	800	2b.40 x 5	1b.40 x 10	2b.40 x 5	1b.40 x 10	2b.50 x 5	1b.50 x 10	2b.50 x 5	1b.50 x 10
	1000	2b.50 x 5	1b.50 x 10	2b.50 x 5	1b.50 x 10	2b.60 x 5	1b.60 x 10	2b.60 x 5	1b.60 x 10
	1250	2b.60 x 5	1b.60 x 10	2b.60 x 5	1b.60 x 10	3b.50 x 5	2b.40 x 10	2b.80 x 5	2b.50 x 10
	1600	3b.60 x 5	2b.50 x 10	3b.60 x 5	2b.50 x 10	2b.100 x 5	2b.60 x 10	3b.80 x 5	2b.60 x 10

Installation Recommendation

Use at High Temperatures

Frame 100 & Frame 160

Power Dissipated and Resistance per Pole

TransferPacT	Frame 100				Frame 160		
	40	63	80	100	100	125	160
Rating (A)	40	63	80	100	100	125	160
Resistance per pole (mΩ)	0.3	0.3	0.3	0.3	0.2	0.2	0.2
Power dissipated per pole (W)	0.5	1.2	1.9	2	2	3.1	5.1

Temperature Derating

TransferPacT	Frame 100				Frame 160		
	40	63	80	100	100	125	160

Front connection with bare-cable connectors or lugs

Thermal current I _{th} at	60 °C	40	63	80	100	100	125	160
	65 °C	40	63	80	100	100	125	160
	70 °C	40	63	80	100	100	125	150

TransferPacT	100	160					
---------------------	------------	------------	--	--	--	--	--

Front connection

Thermal current I _{th} at	60 °C	100				160		
	65 °C	100				160		
	70 °C	100				160		

Front connection with right-angle terminal extension + bare-cable connectors

Thermal current I _{th} at	55 °C	100				160		
	60 °C	100				160		
	65 °C	100				160		
	70 °C	100				160		

Frame 250 & Frame 630

Power Dissipated and Resistance per Pole

TransferPacT	250				630			
	Rating (A)	100	160	200	250	320	400	500
Resistance per pole (mΩ)	0.15	0.15	0.15	0.15	0.09	0.09	0.09	0.09
Power dissipated per pole (W)	1.5	3.8	6	9.4	9.2	14.4	22.5	35.7

Temperature derating

TransferPacT	100	160	200	250	320	400	500	630
--------------	-----	-----	-----	-----	-----	-----	-----	-----

Connection by bars

Thermal current I _{th} at	60 °C	100	160	200	250	320	400	500	630
	65 °C	100	160	200	250	320	400	500	590
	70 °C	100	160	200	250	320	400	500	550

Connection by cables with crimp lugs

Thermal current I _{th} at	60 °C	100	160	200	250	320	400	500	630
	65 °C	100	160	200	250	320	400	500	590
	70 °C	100	160	200	250	320	400	500	550

Connection by cables with connector and terminal shield

Thermal current I _{th} at	40 °C	100	160	200	250	320	400	500	592
	45 °C	100	160	200	250	320	400	500	571
	50 °C	100	160	200	250	320	400	500	548
	55 °C	100	160	200	250	320	400	500	525
	60 °C	100	160	200	250	320	400	500	501
	65 °C	100	160	200	250	320	400	475	475
	70 °C	100	160	200	250	320	400	448	448

Connection of terminal extensions

Thermal current I _{th} at	60 °C	100	160	200	250	320	400	500	630
	65 °C	100	160	200	250	320	400	500	590
	70 °C	100	160	200	250	320	400	500	550

Installation Recommendation

Use at High Temperatures

Frame 800

Power Dissipated and Resistance per Pole

TransferPacT	800
Rating (A)	800
Resistance per pole (mΩ)	0.07
Power dissipated per pole (W)	44.8

Temperature derating

TransferPacT	800
--------------	-----

Connection by bars

Thermal current I _{th} at	50 °C	800
	55 °C	780
	60 °C	757
	65 °C	733
	70 °C	708

Connection by cables with crimp lugs

Thermal current I _{th} at	50 °C	800
	55 °C	780
	60 °C	757
	65 °C	733
	70 °C	708

Connection of terminal extensions

Thermal current I _{th} at	50 °C	800
	55 °C	780
	60 °C	757
	65 °C	733
	70 °C	708

Frame 1600

Power Dissipated and Resistance per Pole

TransferPacT	800	1000	1250	1600
Rating (A)	800	1000	1250	1600
Resistance per pole (mΩ)	0.035	0.035	0.035	0.028
Power dissipated per pole (W)	22.4	35	54.7	71.7

Temperature derating

TransferPacT	800	1000	1250	1600
--------------	-----	------	------	------

Connection by bars

Thermal current I _{th} at	40 °C	800	1000	1250	1600
	45 °C	800	1000	1250	1600
	50 °C	800	1000	1250	1600
	55 °C	800	1000	1250	1560
	60 °C	800	1000	1250	1520
	65 °C	800	1000	1250	1480
	70 °C	800	1000	1250	1440

Installation Recommendation

Use at High Altitude

Frame 100 & Frame 160

Altitude Derating

Altitude (m)		2000	3000	4000	5000
Impulse withstand voltage (kV) U _{imp}	Frame 100	6	5.3	4.7	4.1
	Frame 160	8	7	6.3	5.4
	Controller	6	6	6	5.9
Rated insulation voltage (V) U _i	Switch	800	700	620	540
	Controller	500	500	500	500
Rated current (A) at 40°C I _{n x}		1	0.96	0.93	0.9

A

Frame 250 & Frame 630

Altitude Derating

Altitude (m)		2000	3000	4000	5000
Impulse withstand voltage (kV) U _{imp}	Frame 250	8	7.1	6.4	5.6
	Frame 630	12	11	10	8
	Controller	6	6	6	5.9
Rated insulation voltage (V) U _i	Switch	800	710	640	560
	Controller	500	500	500	500
Rated current (A) at 40°C I _{n x}		1	0.98	0.97	0.95

Frame 800

Altitude Derating

Altitude (m)		2000	3000	4000	5000
Impulse withstand voltage (kV) U _{imp}	Frame 800	12	11	10	8
	Controller	6	6	6	5.9
Rated insulation voltage (V) U _i	Switch	1000	900	780	700
	Controller	500	500	500	500
Rated current (A) at 40°C I _{n x}		1	0.98	0.97	0.95

Frame 1600

Altitude Derating

Altitude (m)		2000	3000	4000	5000
Impulse withstand voltage (kV) U _{imp}	Frame 1600	12	11	10	8
	Controller	6	6	6	5.9
Rated insulation voltage (V) U _i	Frame 1600	1000	900	780	700
	Controller	500	500	500	500
Rated current (A) at 40°C I _{n x}		1	0.99	0.96	0.94

Automatic Transfer Switching Equipment

TransferPacT Active Automatic and Automatic

Wiring Diagrams for Frame 100: 32-100 A

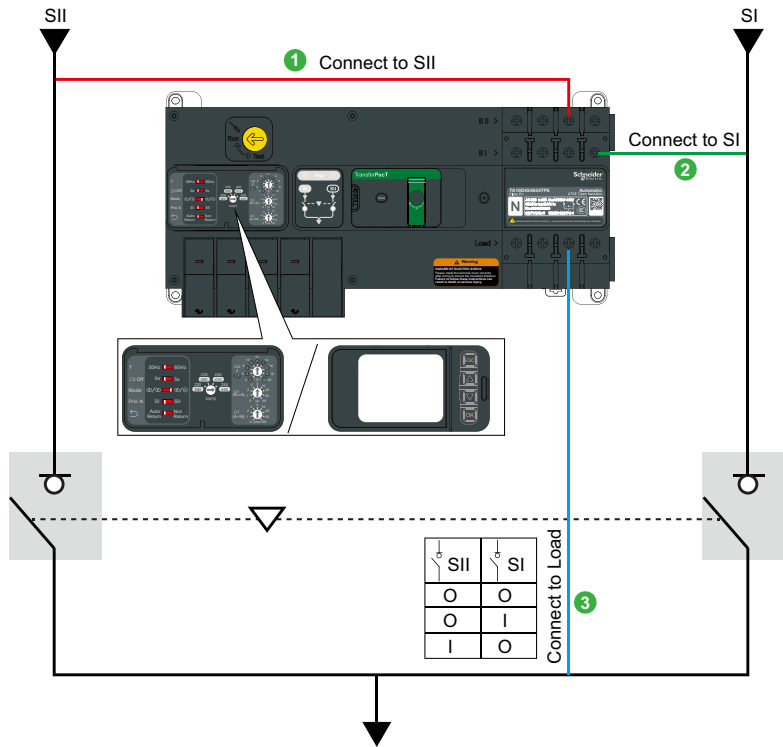

3P/4P

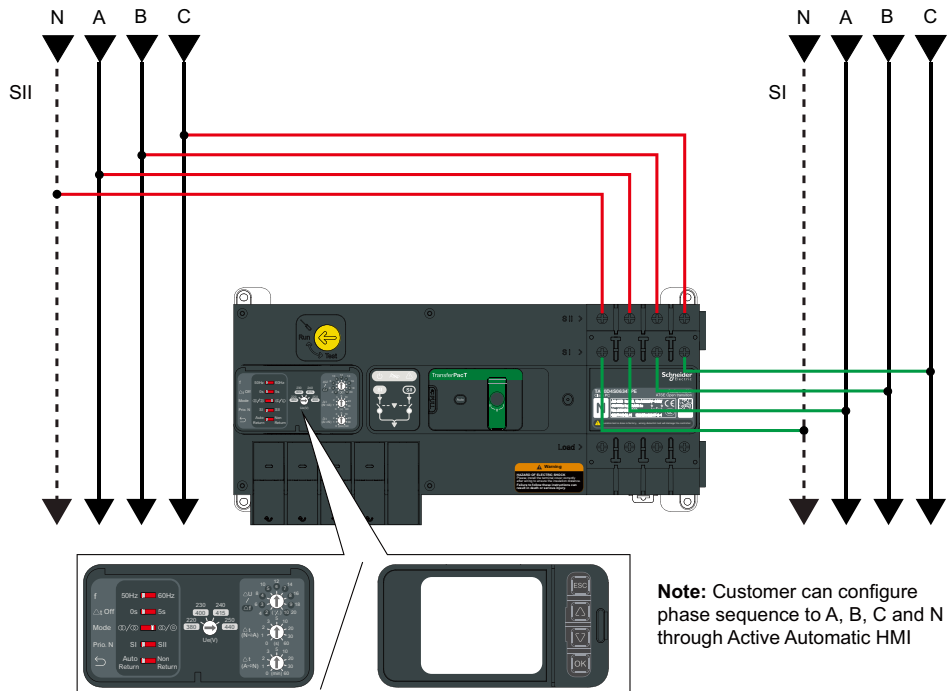

Automatic Transfer Switching Equipment

TransferPacT Active Automatic and Automatic

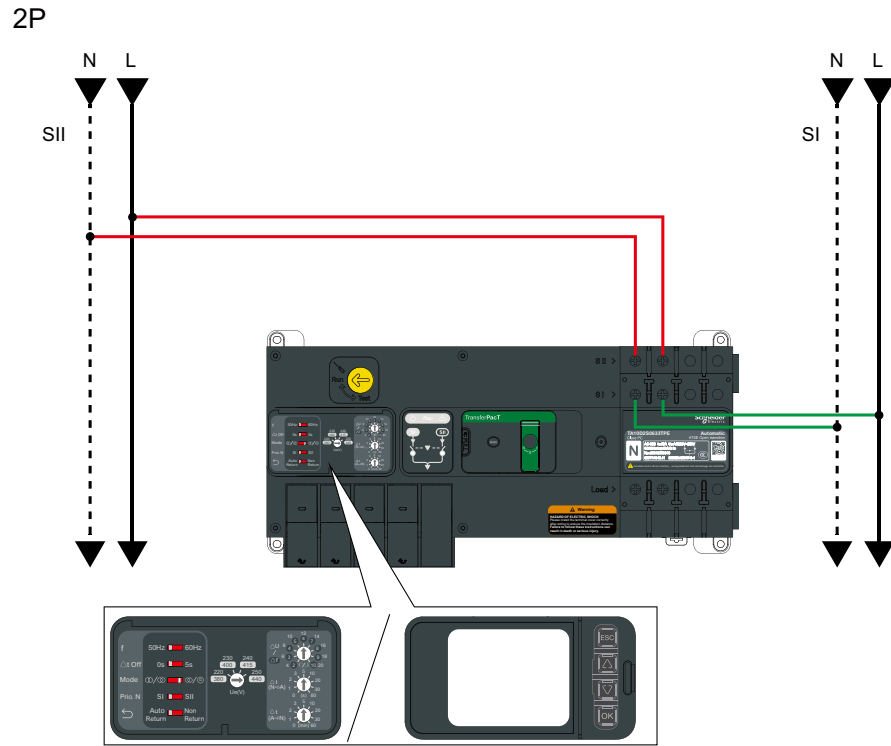

Automatic Transfer Switching Equipment

TransferPacT Active Automatic and Automatic

Wiring Diagrams for Frame 160: 80-160 A

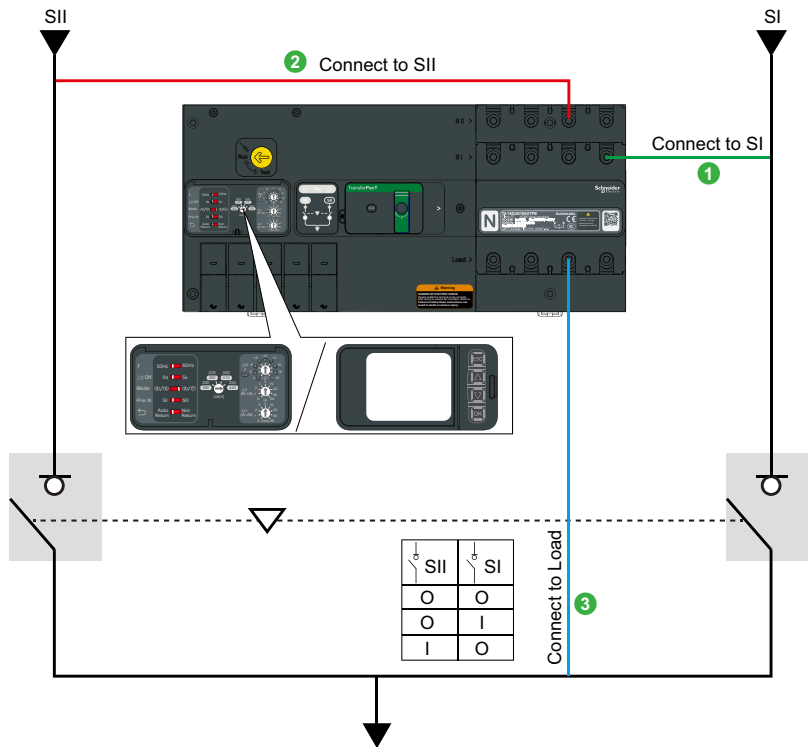

3P/4P

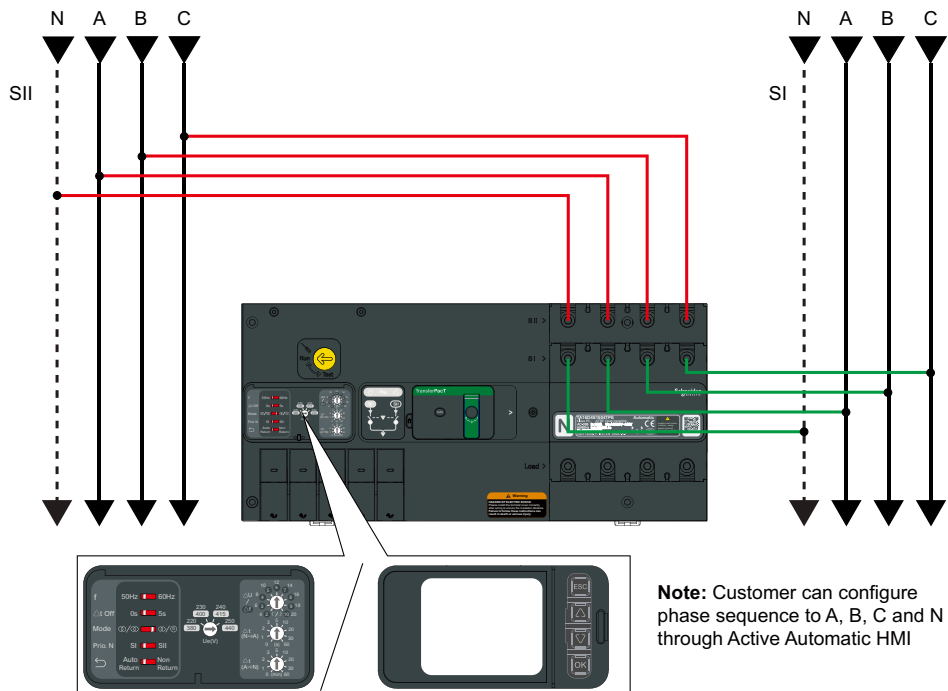

Automatic Transfer Switching Equipment

TransferPacT Active Automatic and Automatic

Wiring Diagrams for Frame 250: 100-250 A

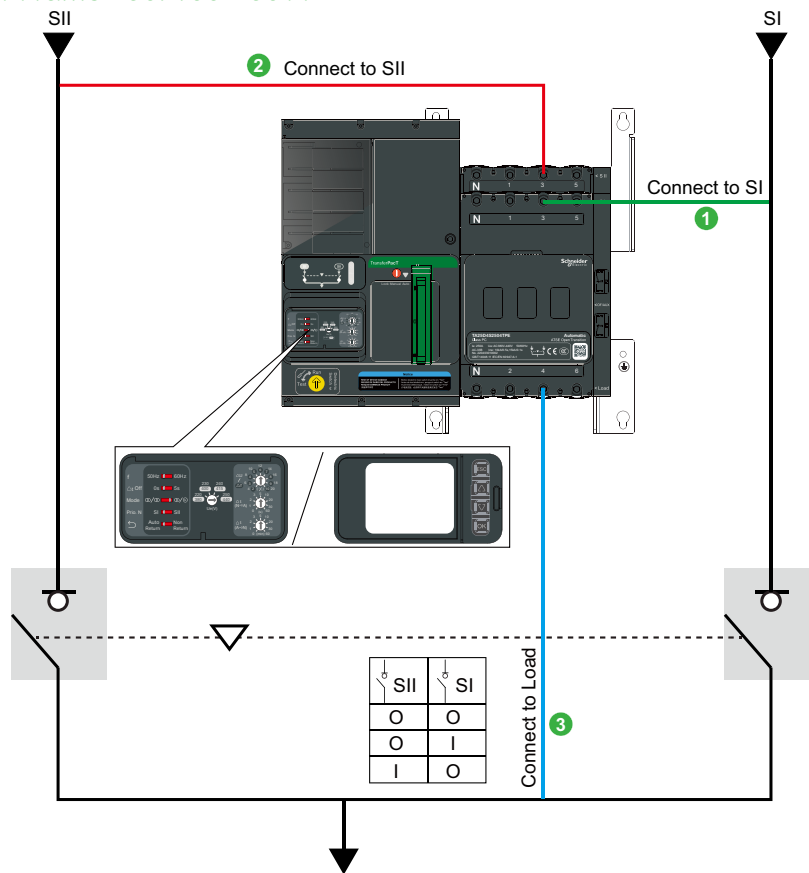

3P/4P

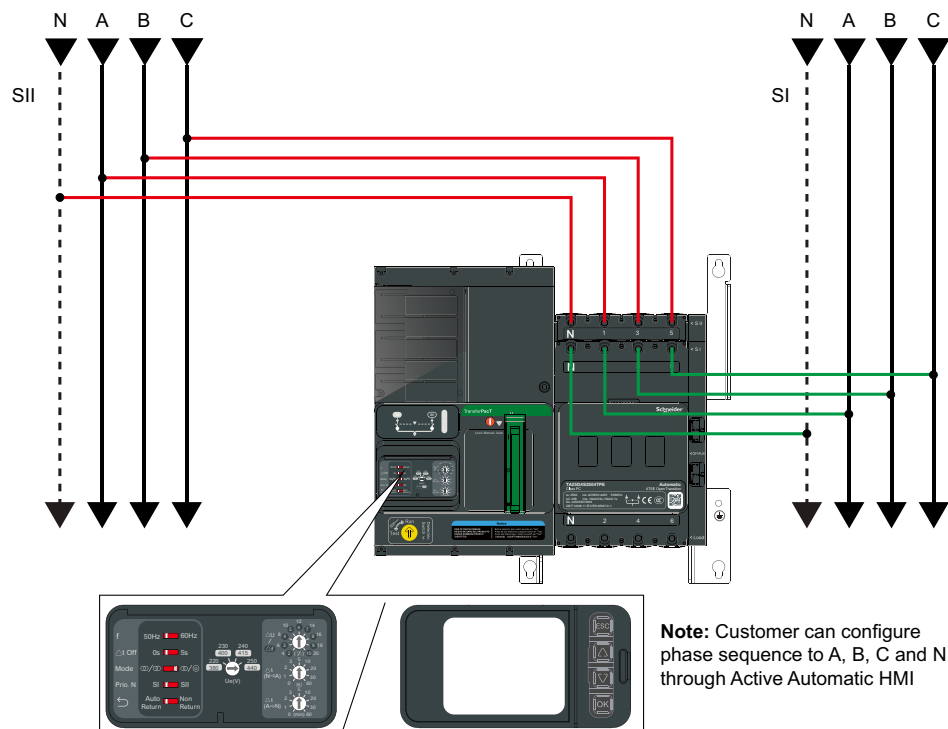

Automatic Transfer Switching Equipment

TransferPacT Active Automatic and Automatic

Wiring Diagrams for Frame 630: 320-630 A and Frame 800: 800A

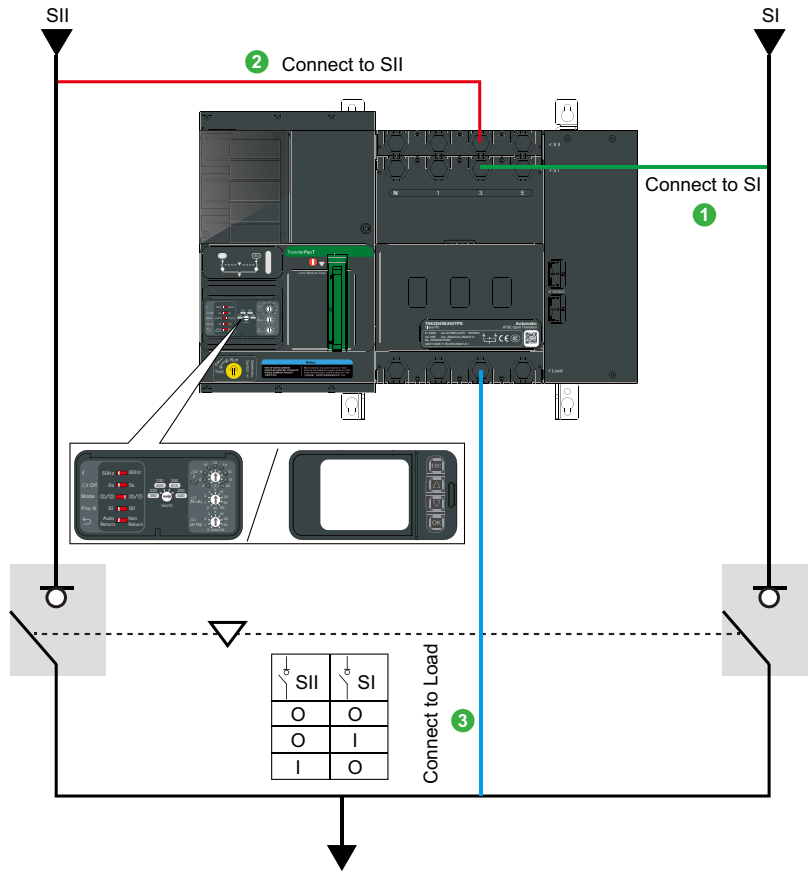

3P/4P

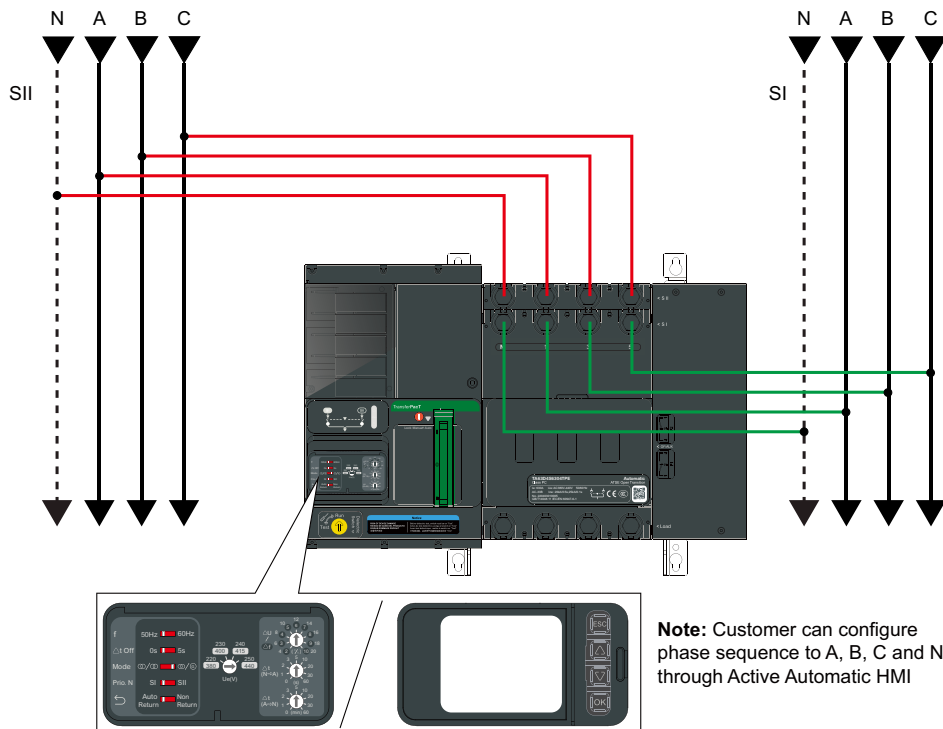

Automatic Transfer Switching Equipment

TransferPacT Active Automatic and Automatic

Wiring Diagrams for Frame 1600: 800-1600A

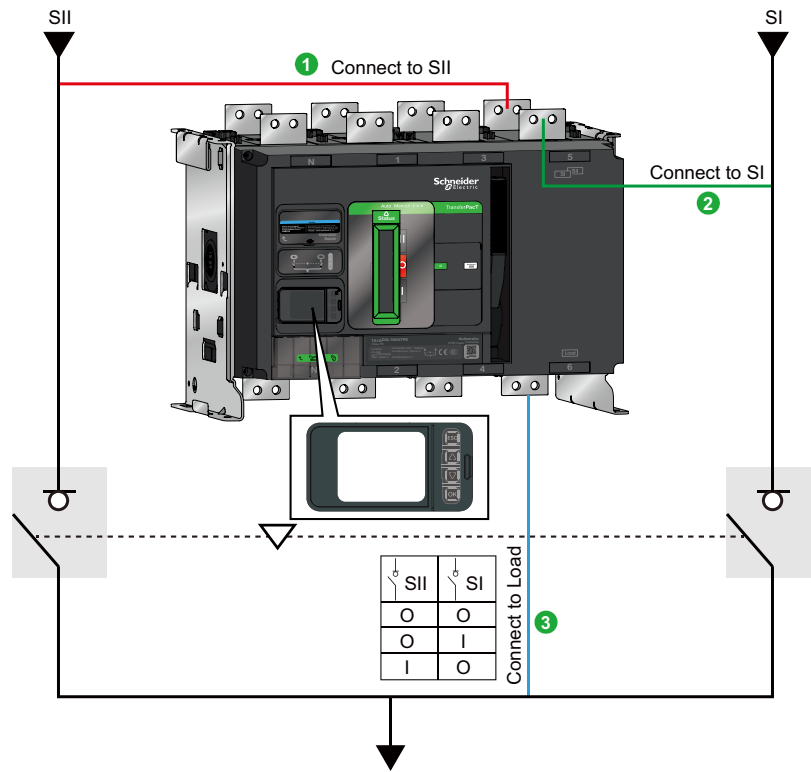

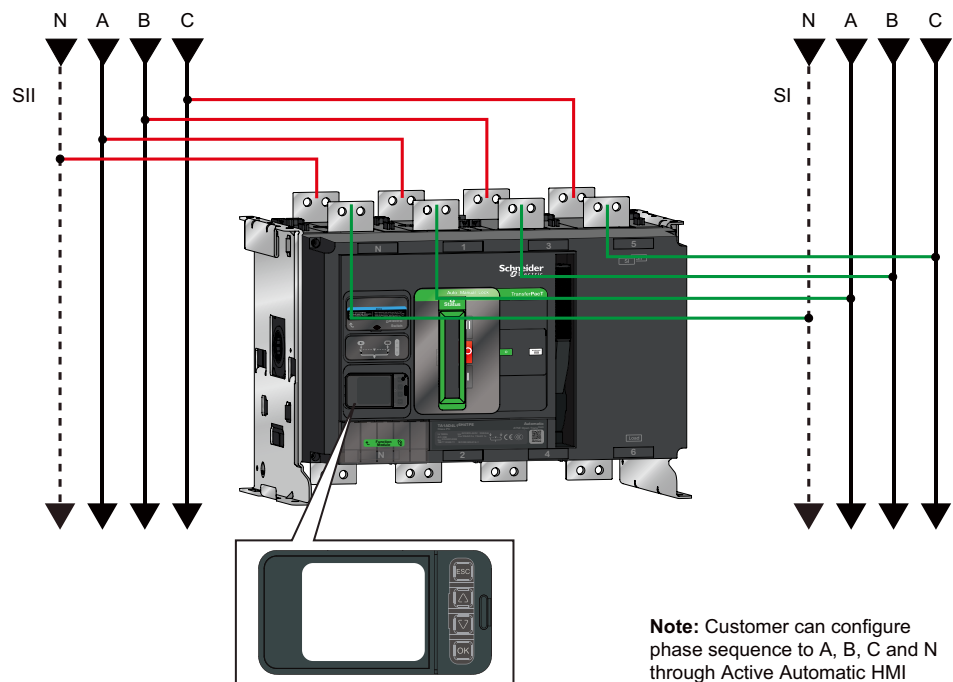

3P/4P

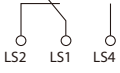
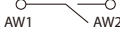
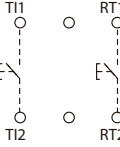
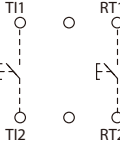
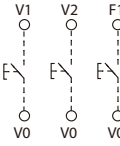
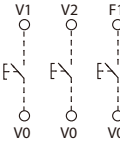
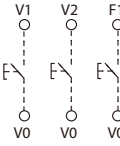
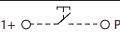
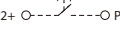

Note: Customer can configure phase sequence to A, B, C and N through Active Automatic HMI

Automatic Transfer Switching Equipment Function Module

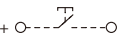
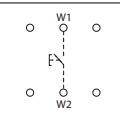
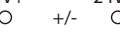
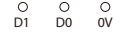
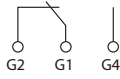
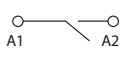
	Maximum Qty per Product	Terminal Code	Terminal Definition
	1	LS1,LS2,LS4	loadshedding signal output
		AW1,AW2	Availability warning output
TPCDIO05			
	1	TI1,TI2	Transfer Inhibit signal input, short to work
		RT1,RT2	Remote testing input,short to work
TPCDIO07			
	1	V0,V1	short to Transfer to Normal
		V0,V2	short to Transfer to Alternate
		V0,F1	short to Transfer to OFF
TPCDIO08			
	1	P1+,P1-	DC24 V pluse signal,enable fire protetion
		P2+,P2-	DC24 V pluse signal,diable fire protection
TPCDIO10			
	1	C1+,C1-	DC24 V constant signal,enable fire protetion
TPCDIO11			
	1	C1+,C1-	AC230 V constant signal,enable fire protetion
TPCDIO13			
	1	W1,W2	Passive Signal, Short to enable fire protetion
TPCDIO14			
	1	24V+,24V-	DC 24 V external power port (auxiliary supply)
TPCDIO15			
	2	D1,D0,0V	modbus communication port
TPCCOM16			
	1	G1,G2,G4	Genset start signal output
		A1,A2	Alarming output
TPCDIO17			

NOTE: for detailed function module terminal definition and default settings, refer to user guide DOCA0214EN-00

Automatic Transfer Switching Equipment Auxiliary Contact



TPSAUX32



TPSAUX43



TPSAUX71

When installed on left side



- Ⓐ SI open
- Ⓑ SI closed
- Ⓒ SII open
- Ⓓ SII closed

Transfer switching equipment is closed at SI:

- F11-F14 is closed
- F11-F12 is opened

Transfer switching equipment is closed at SII:

- F21-F24 is closed
- F21-F22 is opened

Transfer switching equipment is at OFF position:

- F11-F12 and F21-F22 are closed
- F11-F14 and F21-F24 are opened

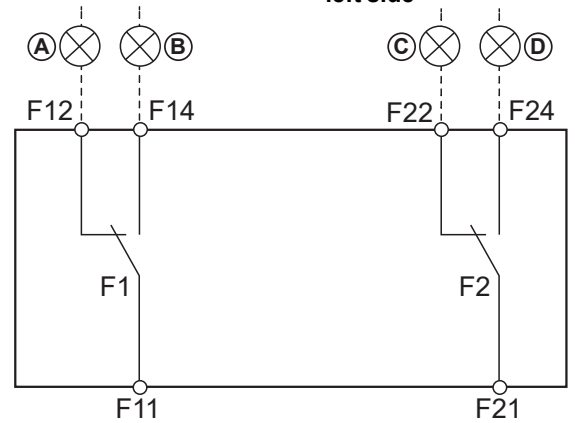

TPSAUX33



TPSAUX44



TPSAUX72

Transfer switching equipment is at OFF position:
F12-F22 is closed

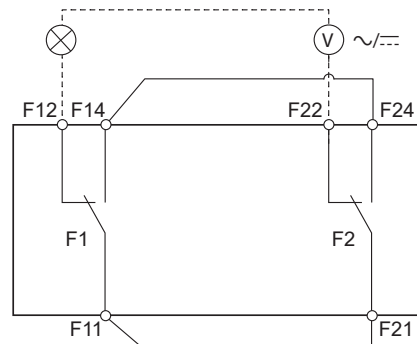

Transfer switching equipment is not at OFF position:
F11-F14 and F21-F24 are closed

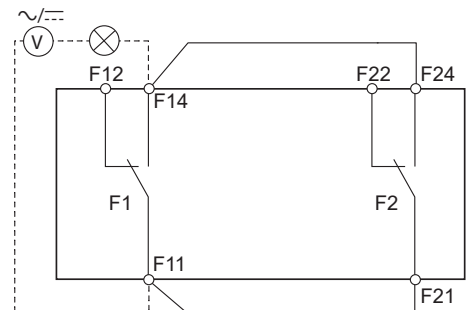

NOTE: terminal capacity for auxiliary contact is AC250 V 2 A.

Automatic Transfer Switching Equipment Auxiliary Contact



TPSAUX71

TPSAUX71 When installed on right side

- (A) SII open
- (B) SII closed
- (C) SI open
- (D) SI closed

Transfer switching equipment is closed at SI:

- F21-F24 is closed
- F21-F22 is opened

Transfer switching equipment is closed at SII:

- F11-F14 is closed
- F11-F12 is opened

Transfer switching equipment is at OFF position:

- F21-F22 and F11-F12 are closed
- F21-F24 and F11-F14 are opened

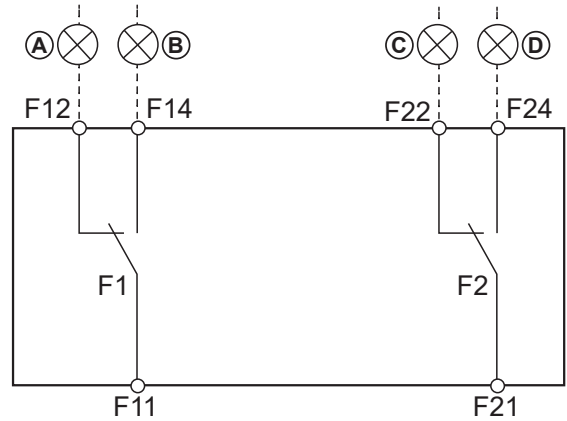

Note: Only TPSAUX71 has different definition when installed on different sides.

Electrical Characteristic of OF Auxiliary Contact

U	AC								DC				
	24	40	130	240	440	480	600	690	24	48	125	130	250
12	10	10	10	10	10	10		6*	10	2.5		0.8	0.3*
13	6	6	5	4	3	2		1	2.5	1.2		0.35	0.05*
14									1	0.2		0.05	0.03*
15	6	6	5	4	2*	1.5*		0.1					
UL489						6	3				0.8		0.3

Coding Principle



TA16DL1604TPE-ISO.png

The commercial reference of TransferPacT Automatic Transfer Switching Equipment is coded with significant features to explain the type of frame rating, transition, controller type, rated voltage, rated current and number of poles

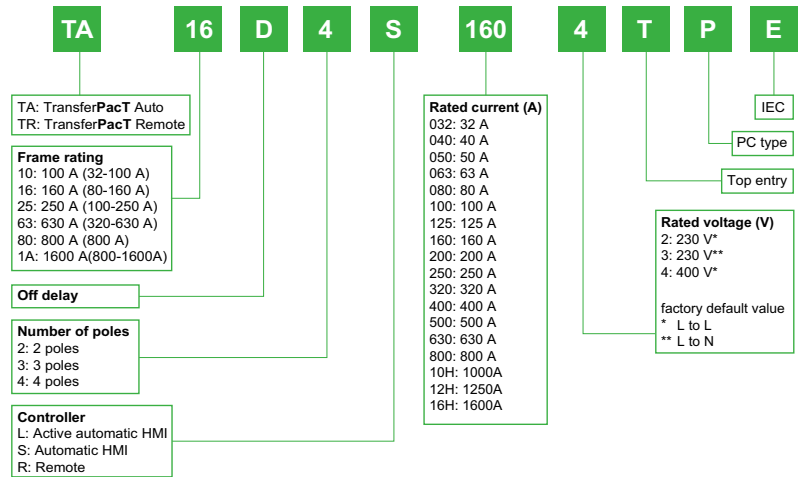

References of TransferPacT Active Automatic and Automatic 32-1600 A

TransferPacT Active Automatic



	2P	3P	4P
32A	TA10D2L0323TPE	TA10D3L0324TPE	TA10D4L0324TPE
40A	TA10D2L0403TPE	TA10D3L0404TPE	TA10D4L0404TPE
50A	TA10D2L0503TPE	TA10D3L0504TPE	TA10D4L0504TPE
63A	TA10D2L0633TPE	TA10D3L0634TPE	TA10D4L0634TPE
80A	TA10D2L0803TPE	TA10D3L0804TPE	TA10D4L0804TPE
100A	TA10D2L1003TPE	TA10D3L1004TPE	TA10D4L1004TPE
80A		TA16D3L0804TPE	TA16D4L0804TPE
100A		TA16D3L1004TPE	TA16D4L1004TPE
125A		TA16D3L1254TPE	TA16D4L1254TPE
160A		TA16D3L1604TPE	TA16D4L1604TPE
100A ¹		TA25D3L1002TPE	TA25D4L1002TPE
250A ¹		TA25D3L2502TPE	TA25D4L2502TPE
200A		TA25D3L2004TPE	TA25D4L2004TPE
250A		TA25D3L2504TPE	TA25D4L2504TPE
630A ¹		TA63D3L6302TPE	TA63D4L6302TPE
800A ¹		TA80D3L8002TPE	TA80D4L8002TPE
320A		TA63D3L3204TPE	TA63D4L3204TPE
400A		TA63D3L4004TPE	TA63D4L4004TPE
500A		TA63D3L5004TPE	TA63D4L5004TPE
630A		TA63D3L6304TPE	TA63D4L6304TPE
800A		TA80D3L8004TPE	TA80D4L8004TPE
800 A		TA1AD3L8004TPE	TA1AD4L8004TPE
1000 A		TA1AD3L10H4TPE	TA1AD4L10H4TPE
1250 A		TA1AD3L12H4TPE	TA1AD4L12H4TPE
1600 A		TA1AD3L16H4TPE	TA1AD4L16H4TPE

1. For phase to phase 208 V/220 V/230 V/240 V application.

References of TransferPacT Active Automatic and Automatic 32-1600 A

TransferPacT Automatic

	2P	3P	4P
 TA10D3S0324TPE-C.jpg	32A	TA10D2S0323TPE	TA10D3S0324TPE
	40A	TA10D2S0403TPE	TA10D3S0404TPE
	50A	TA10D2S0503TPE	TA10D3S0504TPE
 TA10D4S0634TPE-C.jpg	63A	TA10D2S0633TPE	TA10D3S0634TPE
	80A	TA10D2S0803TPE	TA10D3S0804TPE
	100A	TA10D2S1003TPE	TA10D3S1004TPE
	80A		TA16D3S0804TPE
 TA16D4S1004TPE.jpg	100A		TA16D4S1004TPE
	125A		TA16D3S1254TPE
	160A		TA16D3S1604TPE
	200A		TA25D3S2004TPE
 TA25D4S2504TPE.jpg	250A		TA25D4S2504TPE
	320A		TA63D3S3204TPE
	400A		TA63D3S4004TPE
	500A		TA63D3S5004TPE
 TA63D4S6304TPE.jpg	630A		TA63D4S6304TPE
	800A		TA80D3S8004TPE
			TA80D4S8004TPE

TransferPacT Automatic Function Modules

For Active Automatic and Automatic HMI			
 TPCDIO6_ISO.jpg	Load shedding and Availability warning	TPCDIO05	
	Transfer inhibit and Remote testing	TPCDIO07	
	Voluntary Remote control	TPCDIO08	
	Fire Protection 24 Vdc pulse	TPCDIO10	
	Fire Protection 24 Vdc constant	TPCDIO11	
	Fire Protection 230 Vac constant	TPCDIO13	
	Fire Protection Dry contact	TPCDIO14	
	Genset start and Alarm	TPCDIO17	
	For Active Automatic HMI only (* Native equipped for TransferPacT active automatic. no need to order except for renewal or replace)		
	BUS Extension and 24 VDC auxiliary supply	TPCDIO15	
Modbus RTU (Serial Port)	TPCCOM16		

TransferPacT Automatic spare part

 TPCCIF01_ISO.jpg	Active Automatic HMI	TPCCIF01
	Automatic HMI	TPCCIF02



References of TransferPacT Active Automatic and Automatic 32-1600 A

TransferPacT Active Automatic External HMI

TPCCIF04_ISO.png



1x

External HMI

TPCCIF04

TPCOTH18_ISO.eps



1x

HMI Cable 1 m

TRV00810

HMI Cable 2 m

TRV00820

HMI Cable 3 m

TRV00830

TPCOTH37_ISO.png



1x

IP54 cover (for outdoor installation)

**TPCOTH37
TPCOTH38***

*TPCOTH38 is the same material, economic replacement for TPCOTH37

Auxiliary Contacts

TPSAUX32_ISO.png



OF for Source position for frame 100 and frame 160

TPSAUX32

OF for Off position for frame 100 and frame 160

TPSAUX33

OF for Source position for frame 250 and frame 630

TPSAUX43

OF for Off position for frame 250 and frame 630

TPSAUX44

OF for Source position for frame 1600

TPSAUX71

OF for Off position for frame 1600

TPSAUX72

Insulation Accessory



Terminal shield for frame 100 (set of 2)

TPSISO30

Terminal shield for frame 160 (set of 3)

TPSISO31

Terminal Shield for frame 250 (100-250 A) (set of 1)

LV429518

Terminal Shield for frame 630 (320-630 A) (set of 1)

TPSISO42

Interphase barrier frame 160 (set of 9)

TPSISO29

Interphase barriers for frame 250 (100-250 A) and frame 630 (320-630A) (set of 3)

TPSISO65

Interphase barriers, TransferPacT, Accessories for Frame 1600A, set of 3

TPSISO70

Insulating screen for frame 250 (100-250 A) (set of 1).

TPSISO66

Insulating screen for frame 630 (320-630 A) (set of 1).

TPSISO67

Installation Kit



mounting kit for upside down installation, Frame 1600A

TPSOTH73

References of TransferPacT Active Automatic and Automatic 32-1600 A



A

Connection accessory-bare cable connector

Aluminum		
 <p>TPSCON5_image.png</p>	1 cable 25 mm ² to 95 mm ² , frame 250 (set of 3).	LV429227
	1 cable 25 mm ² to 95 mm ² , frame 250 (set of 4).	LV429228
	1 cable 120mm ² to 185mm ² , frame 250 (set of 3).	LV429259
	1 cable 120mm ² to 185mm ² , frame 250 (set of 4).	LV429260
	1 cable 120 to 240 mm ² , frame 250 (set of 3).	TPSCON49 ^b
	1 cable 120 to 240 mm ² , frame 250 (set of 4).	TPSCON50 ^b
	1 cable 35 to 300 mm ² , frame 630 (set of 3).	TPSCON53 ^b
	1 cable 35 to 300 mm ² , frame 630 (set of 4).	TPSCON54 ^b
	2 cables 50 to 120 mm ² , frame 250 (set of 3).	TPSCON51 ^a
	2 cables 50 to 120 mm ² , frame 250 (set of 4).	TPSCON52 ^a
	6 cables 1.5 to 35 mm ² , frame 250 (set of 3).	TPSCON47 ^b
	6 cables 1.5 to 35 mm ² , frame 250 (set of 4).	TPSCON48 ^b
	9 cables for frame 250 (set of 3).	LVS04033 ^a
	9 cables for frame 250 (set of 4).	LVS04034 ^a
	4 cables up to 240mm ² , for frame 1600 (set of 3).	33640
	4 cables up to 240mm ² ,for frame 1600 (set of 4).	33641
	Steel	
 <p>PT03055LV2500.jpg</p>	1 cable 1.5 to 95 mm ² , frame 250, up to 160 A only (set of 3).	LV429242
	1 cable 1.5 to 95 mm ² , frame 250, up to 160 A only (set of 4).	LV429243

- a: Applicable for load side only
- b: Must select terminal shield to ensure incoming and output terminal protection.

Connection accessory-crimp lug

Aluminum			
 <p>TPSCON6_image.png</p>	150 mm ² , frame 250 (set of 3).	LV429504	
	150 mm ² , frame 250 (set of 4).	LV429505	
	185 mm ² , frame 250 (set of 3).	LV429506	
	185 mm ² , frame 250 (set of 4).	LV429507	
	240 mm ² , frame 630 (set of 3).	TPSCON61	
	240 mm ² , frame 630 (set of 4).	TPSCON62	
	300 mm ² , frame 630 (set of 3).	TPSCON63	
	300 mm ² , frame 630 (set of 4).	TPSCON64	
	Copper		
	 <p>TPSCON62_image.png</p>	120 mm ² , frame 250 (set of 3).	LV429252
120 mm ² , frame 250 (set of 4).		LV429256	
150 mm ² , frame 250 (set of 3).		LV429253	
150 mm ² , frame 250 (set of 4).		LV429257	
185 mm ² , frame 250 (set of 3).		LV429254	
185 mm ² , frame 250 (set of 4).		LV429258	
240 mm ² , frame 630 (set of 3).		TPSCON57	
240 mm ² , frame 630 (set of 4).		TPSCON58	
300 mm ² , frame 630 (set of 3).		TPSCON59	
300 mm ² , frame 630 (set of 4).		TPSCON60	

References of TransferPacT Active Automatic and Automatic 32-1600 A

Connection accessory-terminal extensions



edgewise terminal extensions for frame 250 (set of 3)	LV429308
edgewise terminal extensions for frame 250 (set of 4)	LV429309
edgewise terminal extensions for frame 630 (set of 3)	TPSCON55
edgewise terminal extensions for frame 630 (set of 4)	TPSCON56
Straight terminal extensions for frame 250 (set of 3)	LV429263
Straight terminal extensions for frame 250 (set of 4)	LV429264
Spreader for frame 100 (set of 4), load side only	TPSCON35^b
Spreader for frame 160 (set of 4), load side only	TPSCON36^b
35 mm ~ 45 mm Spreader for frame 250 (set of 3)	LV431563
35 mm ~ 45 mm Spreader for frame 250 (set of 4), load side only	LV431564^b
35 mm ~ 45 mm Spreader for frame 250 (set of 4), incomings only	TPSCON39^a
45 mm ~ 55 mm Spreader for frame 630 (set of 3)	TPSCON40
45 mm ~ 55 mm Spreader for frame 630 (set of 4), incomings only	TPSCON41^a
45 mm ~ 55 mm Spreader for frame 630 (set of 4), load side only	TPSCON68^b
70 mm ~ 95 mm Spreader for frame 1600 (set of 3)	33622
70 mm ~ 95 mm Spreader for frame 1600 (set of 4)	33623
70 mm ~ 95 mm Spreader for frame 1600 (set of 3)	LV833622SP
70 mm ~ 95 mm Spreader for frame 1600 (set of 4)	LV833623SP

a: for incomings only
b: for load side only

Connection Accessories - Adapter



vertical connection adapter for frame 1600, set of 3	33642
vertical connection adapter for frame 1600, set of 4	33643
vertical connection adapter for frame 1600, set of 3	LV833642SP
vertical connection adapter for frame 1600, set of 4	LV833643SP
cable lug adapters, connection up to 4 cables with lugs, frame 1600, set of 3	33644
cable lug adapters, connection up to 4 cables with lugs, frame 1600, set of 4	33645
cable lug adapters, connection up to 4 cables with lugs, frame 1600, set of 3	LV833644SP
cable lug adapters, connection up to 4 cables with lugs, frame 1600, set of 4	LV833645SP

Circuit Breaker/Transfer Switching Equipment Coordination

Upstream: Acti9 iC60, C120, NG125
 Downstream: TransferPacT Automatic TA10, TA16

Ue: ≤415 V AC



Load side	TSE		TA10						TA16			
	Rating (A)		32	40	50	63	80	100	80	100	125	160
	Ith (A) 60°C		32	40	50	63	80	100	80	100	125	160
	Icw (kA)		3	3	3	3	3	3	5.5	5.5	5.5	5.5
	Icm (kA)		15	15	15	15	15	15	20	20	20	20
Supply side	Icu											
Circuit breaker:	Rating 415 V	TSE conditional short-circuit current and related making capacity:										
iC60N	≤ 32	10	T	T	T	T	T	T	T	T	T	T
B-C-D Curves	40	10		T	T	T	T	T	T	T	T	T
	50	10			T	T	T	T	T	T	T	T
	63	10				T	T	T	T	T	T	T
iC60H	≤ 32	15	T	T	T	T	T	T	T	T	T	T
B-C-D Curves	40	15		T	T	T	T	T	T	T	T	T
	50	15			T	T	T	T	T	T	T	T
	63	15				T	T	T	T	T	T	T
iC60L	≤ 25	25	T	T	T	T	T	T	T	T	T	T
B-C-D-K-Z Curves	32	20	T	T	T	T	T	T	T	T	T	T
	40	20		T	T	T	T	T	T	T	T	T
	50	15			T	T	T	T	T	T	T	T
	63	15					T	T	T	T	T	T
C120N	63	10				T	T	T	T	T	T	T
B-C-D Curves	80	10					T	T	T	T	T	T
1P 240V	100	10								T	T	T
2,3,4P 415V	125	10									T	T
C120H	63	15				T	T	T	T	T	T	T
B-C-D Curves	80	15					T	T	T	T	T	T
1P 240V	100	15								T	T	T
2,3,4P 415V	125	15									T	T
NG125N	≤ 32	25	T	T	T	T	T	T	T	T	T	T
B-C-D Curves	40	25		T	T	T	T	T	T	T	T	T
	50	25			T	T	T	T	T	T	T	T
	63	25				T	T	T	T	T	T	T
	80	25					T	T	T	T	T	T
	100	25								T	T	T
	125	25									T	T
NG125H	≤ 32	36	T	T	T	T	T	T	T	T	T	T
C- Curve	40	36		T	T	T	T	T	T	T	T	T
	50	36			T	T	T	T	T	T	T	T
	63	36				T	T	T	T	T	T	T
	80	36					T	T	T	T	T	T
NG125L	≤ 32	50	T	T	T	T	T	T	T	T	T	T
C- Curve	40	50		T	T	T	T	T	T	T	T	T
	50	50			T	T	T	T	T	T	T	T
	63	50				T	T	T	T	T	T	T
	80	50					T	T	T	T	T	T

- T : Protection of the Transfer Switching Equipment is ensured but combination not very relevant
- T : Transfer Switching Equipment is totally coordinated up to the Icu of the circuit breaker installed on supply side
- 36/75 : Transfer Switching Equipment is protected up to 36 kA rms / 75 kA peak
- : Protection of the Transfer Switching Equipment is not ensured.

Circuit-Breaker/Transfer Switching Equipment Coordination

Upstream: ComPacT NSXm

Downstream: TransferPacT Automatic TA10, TA16

Ue: ≤440 V AC

Load side		TSE		TA10						TA16			
		Rating (A)		32	40	50	63	80	100	80	100	125	160
		Ith (A) 60 °C		32	40	50	63	80	100	80	100	125	160
		Icw (kA)		3	3	3	3	3	3	5.5	5.5	5.5	5.5
		Icm (kA)		15	15	15	15	15	15	20	20	20	20
Supply side		Icu (kA)											
Circuit breaker:		415 V	440 V	Ir (A)	TSE conditionnal short-circuit current and related making capacity:								
NSXm E TMD Micrologic 4.1	16	10	Ir ≤ 32	T	T	T	T	T	T	T	T	T	T
			Ir ≤ 40		T	T	T	T	T	T	T	T	T
			Ir ≤ 50			T	T	T	T	T	T	T	T
			Ir ≤ 63			T	T	T	T	T	T	T	T
			Ir ≤ 80					T	T	T	T	T	T
			Ir ≤ 100							T		T	T
			Ir ≤ 125										T
NSXm B TMD Micrologic 4.1	25	20	Ir ≤ 32	T	T	T	T	T	T	T	T	T	T
			Ir ≤ 40		T	T	T	T	T	T	T	T	T
			Ir ≤ 50			T	T	T	T	T	T	T	T
			Ir ≤ 63			T	T	T	T	T	T	T	T
			Ir ≤ 80					T	T	T	T	T	T
			Ir ≤ 100							T		T	T
			Ir ≤ 125										T
NSXm F TMD Micrologic 4.1	36	35	Ir ≤ 32	T	T	T	T	T	T	T	T	T	T
			Ir ≤ 40		T	T	T	T	T	T	T	T	T
			Ir ≤ 50			T	T	T	T	T	T	T	T
			Ir ≤ 63			T	T	T	T	T	T	T	T
			Ir ≤ 80					T	T	T	T	T	T
			Ir ≤ 100							T		T	T
			Ir ≤ 125										T
NSXm N TMD Micrologic 4.1	50	50	Ir ≤ 32	36/75	36/75	36/75	36/75	36/75	36/75	T	T	T	T
			Ir ≤ 40		36/75	36/75	36/75	36/75	36/75	T	T	T	T
			Ir ≤ 50			36/75	36/75	36/75	36/75	T	T	T	T
			Ir ≤ 63				36/75	36/75	36/75	T	T	T	T
			Ir ≤ 80					36/75	36/75	T	T	T	T
			Ir ≤ 100						36/75		T	T	T
			Ir ≤ 125										T
NSXm N TMD Micrologic 4.1	70	65	Ir ≤ 32	36/75	36/75	36/75	36/75	36/75	36/75	T	T	T	T
			Ir ≤ 40		36/75	36/75	36/75	36/75	36/75	T	T	T	T
			Ir ≤ 50			36/75	36/75	36/75	36/75	T	T	T	T
			Ir ≤ 63				36/75	36/75	36/75	T	T	T	T
			Ir ≤ 80					36/75	36/75	T	T	T	T
			Ir ≤ 100						36/75		T	T	T
			Ir ≤ 125										T

- T : Protection of the Transfer Switching Equipment is ensured but combination not very relevant
- T : Transfer Switching Equipment is totally coordinated up to the Icu of the circuit breaker installed on supply side
- 36/75 : Transfer Switching Equipment is protected up to 36 kA rms / 75 kA peak
- : Protection of the Transfer Switching Equipment is not ensured.

Circuit-Breaker/Transfer Switching Equipment Coordination

Upstream: ComPacT NSX100-250
 Downstream: TransferPacT Automatic TA10, TA16

Ue: ≤440 V AC



Load side		TSE		TA10						TA16			
		Rating (A)		32	40	50	63	80	100	80	100	125	160
		Ith (A) 60 °C		32	40	50	63	80	100	80	100	125	160
		Icw (kA)		3	3	3	3	3	3	5.5	5.5	5.5	5.5
		Icm(kA)		15	15	15	15	15	15	20	20	20	20
Supply side		Icu (kA)											
Circuit breaker	415 V	440 V	I _r	TSE conditional short-circuit current and related making capacity:									
	NSX100B NSX160B TMD/TMG/ Micrologic	25	20	I _r ≤ 32	T	T	T	T	T	T	T	T	T
			I _r ≤ 40		T	T	T	T	T	T	T	T	T
			I _r ≤ 50			T	T	T	T	T	T	T	T
			I _r ≤ 63				T	T	T	T	T	T	T
			I _r ≤ 80						T		T	T	T
			I _r ≤ 100						T		T	T	T
			I _r ≤ 125									T	T
			I _r ≤ 160										T
NSX250B TMD/TMG/ Micrologic	25	20	I _r ≤ 32	T	T	T	T	T	T	T	T	T	T
			I _r ≤ 40		T	T	T	T	T	T	T	T	T
			I _r ≤ 50			T	T	T	T	T	T	T	T
			I _r ≤ 63				T	T	T	T	T	T	T
			I _r ≤ 80						T		T	T	T
			I _r ≤ 100						T		T	T	T
			I _r ≤ 125									T	T
			I _r ≤ 160										T
NSX100F NSX160F TMD/TMG/ Micrologic	36	35	I _r ≤ 32	T	T	T	T	T	T	T	T	T	T
			I _r ≤ 40		T	T	T	T	T	T	T	T	T
			I _r ≤ 50			T	T	T	T	T	T	T	T
			I _r ≤ 63				T	T	T	T	T	T	T
			I _r ≤ 80						T		T	T	T
			I _r ≤ 100						T		T	T	T
			I _r ≤ 125									T	T
			I _r ≤ 160										T
NSX250F TMD/TMG/ Micrologic	36	35	I _r ≤ 32	25/52	25/52	25/52	25/52	25/52	25/52	T	T	T	T
			I _r ≤ 40		25/52	25/52	25/52	25/52	25/52	T	T	T	T
			I _r ≤ 50			25/52	25/52	25/52	25/52	T	T	T	T
			I _r ≤ 63				25/52	25/52	25/52	T	T	T	T
			I _r ≤ 80					25/52	25/52		T	T	T
			I _r ≤ 100						25/52		T	T	T
			I _r ≤ 125									T	T
			I _r ≤ 160										T
NSX100N/H NSX160N/H TMD/TMG/ Micrologic	50/ 70	50/ 65	I _r ≤ 32	36/75	36/75	36/75	36/75	36/75	36/75	T	T	T	T
			I _r ≤ 40		36/75	36/75	36/75	36/75	36/75	T	T	T	T
			I _r ≤ 50			36/75	36/75	36/75	36/75	T	T	T	T
			I _r ≤ 63				36/75	36/75	36/75	T	T	T	T
			I _r ≤ 80					36/75	36/75		T	T	T
			I _r ≤ 100						36/75		T	T	T
			I _r ≤ 125									T	T
			I _r ≤ 160										T
NSX250N/H TMD/TMG/ Micrologic	50/ 70	50/ 65	I _r ≤ 32	25/52	25/52	25/52				T	T	T	T
			I _r ≤ 40		25/52	25/52	25/52	25/52	25/52	T	T	T	T
			I _r ≤ 50			25/52	25/52	25/52	25/52	T	T	T	T
			I _r ≤ 63				25/52	25/52	25/52	T	T	T	T
			I _r ≤ 80					25/52	25/52		T	T	T
			I _r ≤ 100						25/52		T	T	T
			I _r ≤ 125									T	T
			I _r ≤ 160										T

Circuit-Breaker/Transfer Switching Equipment Coordination

Upstream: ComPacT NSX100-250

Downstream: TransferPacT Automatic TA10, TA16

Ue: ≤440 V AC

Load side		TSE		TA10						TA16				
		Rating (A)		32	40	50	63	80	100	80	100	125	160	
		Ith (A) 60 °C		32	40	50	63	80	100	80	100	125	160	
		Icw (kA)		3	3	3	3	3	3	5.5	5.5	5.5	5.5	
		Icm(kA)		15	15	15	15	15	15	20	20	20	20	
Supply side		Icu (kA)		TSE conditional short-circuit current and related making capacity:										
Circuit breaker		415V	440V	Ir										
NSX100S/L/R NSX160S/L/R TMD/TMG/ Micrologic	100/ 150/ 200	90/ 150/ 200	Ir ≤ 32	36/75	36/75	36/75	36/75	36/75	36/75	36/75	65/143	65/143	65/143	65/143
			Ir ≤ 40		36/75	36/75	36/75	36/75	36/75	36/75	65/143	65/143	65/143	65/143
			Ir ≤ 50			36/75	36/75	36/75	36/75	36/75	65/143	65/143	65/143	65/143
			Ir ≤ 63				36/75	36/75	36/75	36/75	65/143	65/143	65/143	65/143
			Ir ≤ 80					36/75	36/75	36/75	65/143	65/143	65/143	65/143
			Ir ≤ 100						36/75	36/75	65/143	65/143	65/143	65/143
			Ir ≤ 125									65/143	65/143	65/143
NSX250S/L/R TMD/TMG/ Micrologic	100/ 150/ 200	90/ 150/ 200	Ir ≤ 32	25/52	25/52	25/52	25/52	25/52	25/52	25/52	65/143	65/143	65/143	65/143
			Ir ≤ 40		25/52	25/52	25/52	25/52	25/52	25/52	65/143	65/143	65/143	65/143
			Ir ≤ 50			25/52	25/52	25/52	25/52	25/52	65/143	65/143	65/143	65/143
			Ir ≤ 63				25/52	25/52	25/52	25/52	65/143	65/143	65/143	65/143
			Ir ≤ 80					25/52	25/52	25/52	65/143	65/143	65/143	65/143
			Ir ≤ 100						25/52	25/52	65/143	65/143	65/143	65/143
			Ir ≤ 125									65/143	65/143	65/143
												65/143		

- T : Protection of the Transfer Switching Equipment is ensured but combination not very relevant
- T : Transfer Switching Equipment is totally coordinated up to the Icu of the circuit breaker installed on supply side
- 36/75 : Transfer Switching Equipment is protected up to 36 kA rms / 75 kA peak
- : Protection of the Transfer Switching Equipment / circuit breaker is not ensured.

Circuit-Breaker/Transfer Switching Equipment Coordination

Upstream: ComPacT NSX100-630 NS630b NS800L/H/L

Downstream: TransferPacT Automatic TA25, TR25, TA63, TR63, TA80, TR80

Ue: ≤440 V AC



Load side	TSE		TA25, TR25				TA63, TR63				TA80, TR80	
	Rating (A)	Rating (A)	100	160	200	250	320	400	500	630	800	
	Ith (A) 60°C	Ith (A) 60°C	100	160	200	250	320	400	500	630	800	
	Icu (kA)	Icu (kA)	15/0.1s	15/0.1s	15/0.1s	15/0.1s	25/0.1s	25/0.1s	25/0.1s	25/0.1s	25/0.1s	
			10/0.5s	10/0.5s	10/0.5s	10/0.5s	20/0.5s	20/0.5s	20/0.5s	20/0.5s	20/0.5s	
			8/1s	8/1s	8/1s	8/1s	15/1s	15/1s	15/1s	15/1s	15/1s	
	Icm (kA)	Icm (kA)	30	30	30	30	40	40	40	40	40	
Supply side	Icu (kA)	Icu (kA)	TSE conditional short-circuit current and related making capacity:									
Circuit breaker	415V	440V	Ir									
NSX100B/F/N/H/S/L NSX160B/F/N/H/S/L NSX250B/F/N/H/S/L TMD/TMG/ Micrologic	25/36/50/70/100/150	20/35/50/65/90/130	Ir≤100	T	T	T	T	T	T	T	T	T
			Ir≤160		T	T	T	T	T	T	T	T
			Ir≤200			T	T	T	T	T	T	T
			Ir≤250				T	T	T	T	T	T
NSX100R NSX250R TMD/TMG/ Micrologic	200	200	Ir≤100	T	T	T	T	T	T	T	T	T
			Ir≤160		T	T	T	T	T	T	T	
			Ir≤200			T	T	T	T	T	T	
			Ir≤250				T	T	T	T	T	
NSX400F/N/H/S/L NSX630F/N/H/S/L Micrologic Note: Min. In 100 A Max. In 570A	36/50/70/100/150	30/42/65/90/130	Ir=100	T	T	T	T	T	T	T	T	
			Ir≤160		T	T	T	T	T	T	T	
			Ir≤200			T	T	T	T	T	T	
			Ir≤250				T	T	T	T	T	
			Ir≤320					T	T	T	T	
			Ir≤400						T	T	T	
			Ir≤500							T	T	
Ir≤630								T				
NSX400R NSX630R Micrologic Note: Min. In 100 A Max. In 570A	200	200	Ir=100	150/330	150/330	150/330	150/330	T	T	T	T	
			Ir≤160		150/330	150/330	150/330	T	T	T	T	
			Ir≤200			150/330	150/330	T	T	T	T	
			Ir≤250				150/330	T	T	T	T	
			Ir≤320					T	T	T	T	
			Ir≤400						T	T	T	
			Ir≤500							T	T	
Ir≤630								T				
NS630b/800 N	50	50	Ir≤320					20/50	20/50	20/50	20/50	
			Ir≤400						20/50	20/50	20/50	
			Ir≤500							20/50	20/50	
			Ir≤630								20/50	
NS630b/800H	70	65	Ir≤320					20/50	20/50	20/50	20/50	
			Ir≤400						20/50	20/50	20/50	
			Ir≤500							20/50	20/50	
			Ir≤630								20/50	
NS630b/800 L	150	130	Ir≤320					T	T	T	T	
			Ir≤400						T	T	T	
			Ir≤500							T	T	
			Ir≤630								T	
			Ir≤800							T		

T : Transfer Switching Equipment is totally coordinated up to the Icu of the circuit breaker installed on supply side

150/330 : Transfer Switching Equipment is protected up to 150 kA rms / 330 kA peak

: Protection of the Transfer Switching Equipment / circuit breaker is not ensured.

Circuit-Breaker/Transfer Switching Equipment Coordination

Upstream: ComPacT NS630b to 1600/ MasterPact MTZ1/MTZ2
 Downstream: TransferPacT Automatic TA1A

Ue: ≤440 V AC

Load side	TSE			TA1A(1600)			
	Rating (A)	800	1000	1250	1600		
	Ith (A) 60 °C	32	40	50	63		
	Icw (kA)	70/0.1s 50/0.5s	70/0.1s 50/0.5s	70/0.1s 50/0.5s	70/0.1s 50/0.5s		
	Icm(kA)	105	105	105	105		
Supply side	Icu (kA)	TTSE conditionnal short-circuit current and related making capacity:					
Circuit breaker	415 V	440 V	Ir				
NS630b-1600N	50	50	I _r ≤800	T	T	T	T
			I _r ≤1000		T	T	T
			I _r ≤1250			T	T
			I _r ≤1600				T
NS630b/1600H	70	65	I _r ≤800	T	T	T	T
			I _r ≤1000		T	T	T
			I _r ≤1250			T	T
			I _r ≤1600				T
NS630b/1000 L	150	130	I _r ≤800	T	T	T	T
			I _r ≤1000		T	T	T
MTZ1 H1 06-16	42	42	I _r ≤800	T	T	T	T
			I _r ≤1000		T	T	T
			I _r ≤1250			T	T
			I _r ≤1600				T
MTZ1 H2 06-16	50	50	I _r ≤800	T	T	T	T
			I _r ≤1000		T	T	T
MTZ1 H3 06-16	66	66	I _r ≤1250			T	T
			I _r ≤1600				T
			I _r ≤800	T	T	T	T
			I _r ≤1000		T	T	T
			I _r ≤1250			T	T
			I _r ≤1600				T
MTZ1 L1 06-10	150	130	I _r ≤800	T	T	T	T
			I _r ≤1000		T	T	T
MTZ2 N1 08-20	42	42	I _r ≤800	T	T	T	T
			I _r ≤1000		T	T	T
			I _r ≤1250			T	T
			I _r ≤1600				T
MTZ2 H1 08-20	66	66	I _r ≤800	50/105	50/105	50/105	50/105
			I _r ≤1000		50/105	50/105	50/105
			I _r ≤1250			50/105	50/105
			I _r ≤1600				50/105
MTZ2 H2 08-20	100	100	I _r ≤800	50/105	50/105	50/105	50/105
			I _r ≤1000		50/105	50/105	50/105
			I _r ≤1250			50/105	50/105
			I _r ≤1600				50/105

T : Total coordination, Transferpact is protected up to Icu of downstream circuit-breaker

50/105 : Transferpact is protected up to 70 kArms/130 kA peak of presumed short-circuit current

: Protection of the Transfer Switching Equipment / circuit breaker is not ensured.

Fuses/Transfer Switching Equipment Coordination

Upstream: gG Fuse

Downstream: TransferPacT Automatic TA10, TA16

Ue: ≤440 V AC



Load side	TSE	TA10						TA16			
		Rating (A)	32	40	50	63	80	100	80	100	125
Supply side	Rating (A)	32	40	50	63	80	100	80	100	125	160
	Ith (A) 60°C	32	40	50	63	80	100	80	100	125	160
Fuse type	Rating (A)	3	3	3	3	3	3	5.5	5.5	5.5	5.5
	Rating (A)	15	15	15	15	15	15	20	20	20	20
gG fuse link without overload relay	25	T	T	T	T	T	T	T	T	T	T
	32		T	T	T	T	T	T	T	T	T
	40			T	T	T	T	T	T	T	T
	50				T	T	T	T	T	T	T
	63						T		T	T	T
	80						T		T	T	T
	100								T	T	T
	125										T
	160										
gG fuse link with overload relay	≤ 50	T	T	T	T	T	T	T	T	T	T
	63	T	T	T	T	T	T	T	T	T	T
	80		T	T	T	T	T	T	T	T	T
	100			T	T	T	T	T	T	T	T
	125				80/176	80/176	80/176	80/176	T	T	T
	160					36/75	36/75	36/75	50/105	50/105	50/105
	200								36/75	36/75	36/75

T : Protection of the Transfer Switching Equipment is ensured but combination not very relevant

T : Transfer Switching Equipment is totally coordinated up to the Icu of the circuit breaker installed on supply side

36/75 : Transfer Switching Equipment is protected up to 36 kA rms / 75 kA peak

: Protection of the Transfer Switching Equipment is not ensured.

Important Notice : Current limitation characteristics can be significantly different from one manufacturer to another This table can not dispense to check selected fuse characteristics

Fuses/Transfer Switching Equipment Coordination

Upstream: gG Fuse

Downstream: TransferPacT Automatic TA25, TR25, TA63, TR63, TA80, TR80

Ue: ≤440 V AC

Load side	TSE	TA25, TR25				TA63, TR63				TA80, TR80
	Rating (A)	100	160	200	250	320	400	500	630	800
	Ith (A) 60°C	100	160	200	250	320	400	500	630	800
	Icw (kA)	15/0.1s	15/0.1s	15/0.1s	15/0.1s	25/0.1s	25/0.1s	25/0.1s	25/0.1s	25/0.1s
		10/0.5s	10/0.5s	10/0.5s	10/0.5s	20/0.5s	20/0.5s	20/0.5s	20/0.5s	20/0.5s
		8/1s	8/1s	8/1s	8/1s	15/1s	15/1s	15/1s	15/1s	15/1s
	Icm(kA)	30	30	30	30	40	40	40	40	40
Supply side Fuse type	Rating (A)									
gG fuse without other Overload protection	80	T	T	T	T	T	T	T	T	T
	100		T	T	T	T	T	T	T	T
	160			T	T	T	T	T	T	T
	200				T	T	T	T	T	T
	250					T	T	T	T	T
	320						T	T	T	T
	400							T	T	T
	500								T	T
	630								T	T
	800									T
gG fuse for protection against short-circuit only O/L protection ensured by external relay or other means	100	T	T	T	T	T	T	T	T	T
	160		T	T	T	T	T	T	T	T
	200			T	T	T	T	T	T	T
	250				T	T	T	T	T	T
	320					T	T	T	T	T
	400						T	T	T	T
	500							T	T	T
	630								T	T
800									T	

T : Transfer Switching Equipment is totally coordinated up to the Icu of the circuit breaker installed on supply side

150/330 : Transfer Switching Equipment is protected up to 150 kA rms / 330 kA peak

: Protection of the Transfer Switching Equipment / circuit breaker is not ensured.

TransferPacT Remote

TransferPacT Class PC	B-2
General Features	B-3
Electrical and Mechanical Accessories - Frame 250	B-8
Electrical and Mechanical Accessories- Frame 630	B-14
Electrical and Mechanical Accessories- Frame 800	B-18
Terminal Definition and Transfer Process.....	B-22
Remote Transfer Switching Equipment.....	B-23
References of TransferPacT Remote 160-800 A.....	B-36

B

TransferPacT Class PC

R

RTSE: Remote Transfer Switching Equipment

(Non-derived RTSE, PC Type)

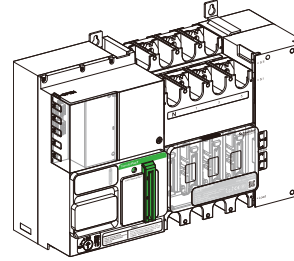
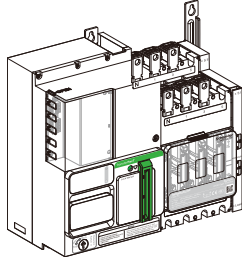

Definition of Class PC

Transfer switch equipment based on mechanical switching devices, that do not need electrical power to hold the main contacts open or closed and capable of making, carrying, and breaking currents under normal circuit conditions including operating overload conditions, and making and withstanding short-circuit currents.

Definition of RTSE(Remote Transfer Switching Equipment)

Transfer switching equipment that is electrically operated and not self-acting.

It is the most commonly used system for transfer loads without direct human intervention. Transfer process is conducted electrically. In some occasions, customers want to use a third-party system to control the TSE from distance (such as control room), or users want to use an intelligent system to operate the TSE, which requires remote control functions.

TransferPacT Remote is a class PC, solenoid drive all in one RTSE.

TransferPacT RTSE has intelligent control with CPU integrated in switch, it is designed to manage the transfer according to the incoming command of the third party. It can work with third party system, like generator-set controllers, PLCs etc.

General Features



Power availability

Vast application:

Utilization category AC-33B without derating, fits the most complicated load types.

Reliable under extreme condition:

Short circuit capabilities including short time withstand current for your power continuity.

Robust design – Extreme Environment Proof:

- Best-in-class electromagnetic protection, exceeding industry standards on class B.
- Designed to perform in harsh environments with operating temperature -25...70 °C
- Successfully passed testing in compliance with IEC 60068-2-6 and IEC 60068-2-27.



Efficiency

Easy installation:

- Built-in DPS and sensing wire, 30% of commissioning time saving.

Easy Operation:

- Simple reliable mechanism, manual and remote operation available
- Input and output terminals to provide product status and operation
- Wide voltage range for multiple grid: 208 VAC-240 VAC, 380 VAC-440 VAC.



Sustainability

Green premium ecolabel.

- Green package for full product range.
- Saving trees - Scan QR code for full version for technical documents.



Cyber security

Designed according to cyber security standard IEC 62443 at the level of SL1.

General Features



TransferPacT Remote

TransferPacT Remote

Frame

Conventional Thermal Current	I _{th}	at 60°C
------------------------------	-----------------	---------

Rated operating current (A)	I _e	AC-33B
-----------------------------	----------------	--------

Number of poles		
-----------------	--	--

Operating positions		
---------------------	--	--

Electrical characteristics as defined by IEC 60947-1 / 60947-6-1 and EN 60947-1 / 60947-6-1

Rated insulation voltage (V)	U _i	
------------------------------	----------------	--

Rated impulse withstand voltage (kV)	U _{imp}	
--------------------------------------	------------------	--

Rated operating voltage (V)	U _e	AC50/60 Hz
-----------------------------	----------------	------------

Rated operating frequency (Hz)	F	
--------------------------------	---	--

Rated short-time withstand current (kA)	I _{cw}	
---	-----------------	--

Rated short-circuit making capacity (400 V, 50 Hz)	I _{cm}	switch alone
		with upstream circuit breaker

Rated duties	Uninterrupted duty
--------------	--------------------

Mechanical durability	
-----------------------	--

Controller life expectancy (years)	
------------------------------------	--

Suitability for Isolation	
---------------------------	--

Installation and connection- Fixed, front connection

Installation	
--------------	--

Wiring	
--------	--

Switch Accessories

Position feedback(Auxiliary contact)	
--------------------------------------	--

Terminal cover	
----------------	--

Rail buckle	
-------------	--

Terminal Shield	
-----------------	--

Connection accessories	Crimp lug
	Connector

Terminal Extension	
--------------------	--

Interphase barrier	
--------------------	--

Tightening torque for electrical connections (Nm)	
---	--

Degree of pollution	
---------------------	--

Upstream protection	Refer to Complementary technical information
---------------------	--

Dimensions and weights	
------------------------	--

Overall dimensions	3pole
--------------------	-------

W x H x D (mm)	4pole
----------------	-------

Approximate weight (kg)	3pole
	4pole

Note:

■ Standard □ Optional

(1). at 50°C

General Features

	TR25	TR63	TR80
	250	630	800
	250	630	800 ⁽¹⁾
	160, 200, 250	320, 400, 500, 630	800
	3/4	3/4	3/4
	3	3	3
	TR25	TR63	TR80
	800	800	1000
	8	12	12
	380/400/415/440 V	380/400/415/440 V	380/400/415/440 V
	50/60 Hz	50/60 Hz	50/60 Hz
	15kA/0.1 s 10kA/0.5 s	25kA/0.1 s 20kA/0.5 s	25kA/0.1 s 20kA/0.5 s
	30 kA	40 kA	40 kA
	330 kA	330 kA	330 kA
	■	■	■
	10,000	10,000	10,000
	10	10	10
	■	■	■
	TR25	TR63	TR80
	base plate	base plate	base plate
	busbar /crimp lug /cable	Busbar/crimp lug / cable	Busbar/crimp lug / cable
	TR25	TR63	TR80
	□	□	□
	Maximum 3 sets	Maximum 3 sets	Maximum 3 sets
	-	-	-
	-	-	-
	□	□	□
	□	□	□
	□	□	□
	□	□	□
	□	□	□
	15±1.5	50±5	50±5
	3	3	3
	370 x 341 x 186	467 x 341 x 186	467 x 341 x 186
	370 x 341 x 186	467 x 341 x 186	467 x 341 x 186
	13.1	20.8	21.4
	13.3	22.1	22.4

B

General Features

Besides the terminals for I/O signals, it also provides power and product state and alarm indication through LED indicator on product front face. TransferPacT Remote is designed to manage the transfer according to the incoming command of the third party. It can work with third party system, like generator-set controllers, PLCs etc.

Controller Type	Remote Version Without HMI
Controller Functional Characteristics	
3P/4P (Phase-Phase)	230 V: 208 V ~ 240 V
3P/4P (Phase-Phase)	400 V: 380 V ~ 440 V
Rated operating frequency (Hz)	50/60
Rated insulation voltage (V)	500 V for 380 ~ 440 V, 300 V for 208 ~ 240 V
Impulse withstand voltage (KV)	6 kV for 380 ~ 440 V, 4 kV for 208 ~ 240 V
Operating temperature	-25 °C to +70 °C
Operating altitude	≤2000 m
Protection degree	IP20
Pollution degree	3
Electrostatic discharge	Level 4
Radio-frequency electromagnetic field	Level 3
Fast transient bursts	Level 4
Surges	Level 4
Harmonic wave	Class 3
Voltage dips and short-time interruptions	Level 3
Vibration	IEC 60068-2-6
Shock	IEC 60068-2-27
Display of Controller	
Display mode	LED + Indicator
Single line diagram	■
Power status	power / mode display
Position feedback	□
Control Function	
Power availability	■ output signal
Remote transfer to A	■ input signal
Remote transfer to N	■ input signal
Remote transfer to O	■ input signal

Note: ■Standard □Optional





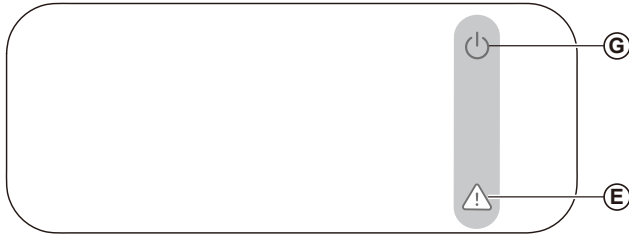

General Features

HMI Description



B

Label	Description
G	Power status indicator
E	Alarm indicator

LED Indication	Status	Description
		Both sources are out of range, or the transfer switch equipment is in manual/lock mode
		Either source is in range and transfer switch equipment is in RUN mode
		No alarm
		Alarm is active (Transfer failure, transfer switch equipment contact position failure, internal error occurred)

Electrical and Mechanical Accessories - Frame 250

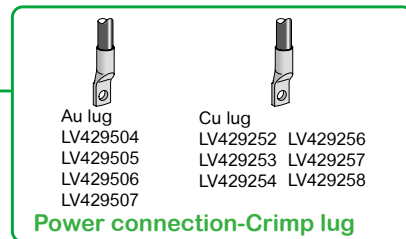
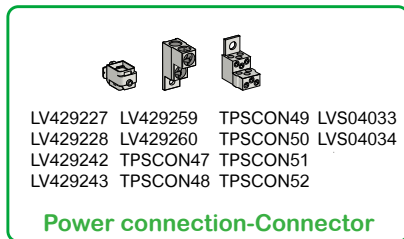
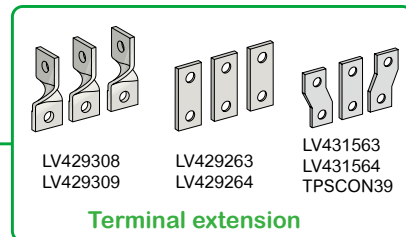
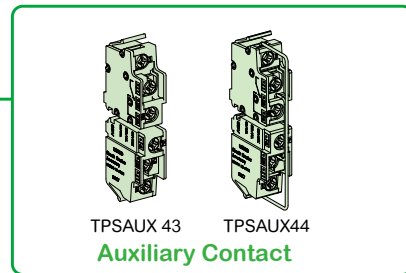
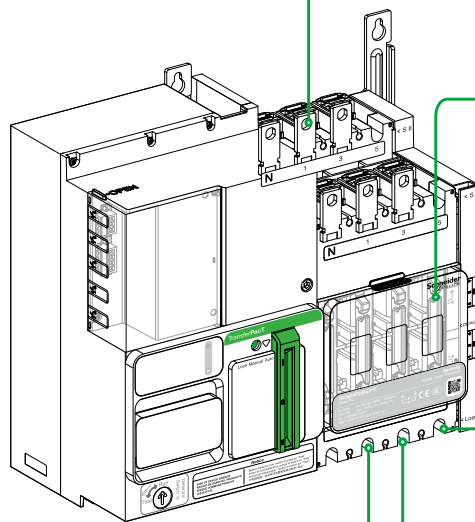
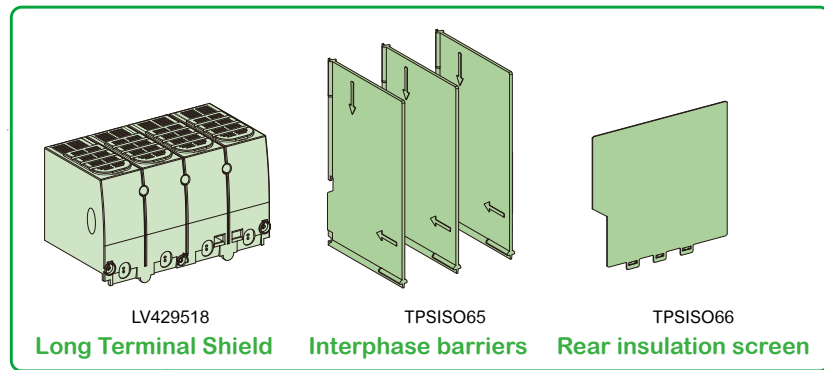

Electrical and mechanical accessories - Frame 250

Auxiliary Contact Module

- TPSAUX43: provide the open and closed status indication for both source I and source II .
- TPSAUX44: provide the open and closed status indication for OFF position.

Insulating Accessories

Terminal Shield

Optional accessory, provide terminal protection on the cable incoming and output.

- LV429518: Terminal shield (set of 1)

Interphase Barrier

Optional accessory, provide protection for the cable incoming and output, effectively avoiding short circuits between phases.

- TPSISO65: Interphase barriers (set of 3)

Insulation Screen

Optional accessory, provide protection for the cable incoming and output.

- TPSISO66: Insulating screen. Applicable for source II only, maximum 1 set.

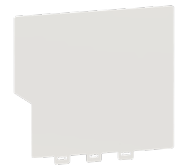

B

Electrical and Mechanical Accessories - Frame 250

Connection Accessories

Bare Cable Connector

Cable Material	number	Cross Section	Pole	Commercial Reference	Quantity
Aluminum	1 cable	25 to 95 mm ²	3P	LV429227	3
			4P	LV429228	4
		120 to 185 mm ²	3P	LV429259	3
			4P	LV429260	4
		120 to 240 mm ²	3P	TPSCON49 ^b	3
			4P	TPSCON50 ^b	4
	2 cables	50 to 120 mm ²	3P	TPSCON51 ^{a,b}	3
			4P	TPSCON52 ^{a,b}	4
	6 cables	1.5 to 35 mm ²	3P	TPSCON47 ^b	3
			4P	TPSCON48 ^b	4
9 cables		3P	LVS04033 ^a	3	
		4P	LVS04034 ^a	4	
steel	1 cable	1.5 to 95 mm ²	3P	LV429242	3
			4P	LV429243	4

^a: Applicable for load side only

^b: Must select terminal shield to ensure incoming and output terminal protection.

Electrical and Mechanical Accessories - Frame 250

Crimp Lug for Cables

- Natively supplied with interphase barriers.

Cable Material	Cross Section	Pole	Commercial Reference	Quantity
Aluminum	150 mm ²	3P	LV429504	3
		4P	LV429505	4
	185 mm ²	3P	LV429506	3
		4P	LV429507	4
Copper	120 mm ²	3P	LV429252	3
		4P	LV429256	4
	150 mm ²	3P	LV429253	3
		4P	LV429257	4
	185 mm ²	3P	LV429254	3
		4P	LV429258	4



B

Terminal Extension

- Natively supplied with interphase barriers.

Type	Pole	Commercial Reference	Quantity
Spreaders			
35-45 mm	3P	LV431563	3
	4P	LV431564 ^b	4
	3P	TPSCON39 ^a	4
	4P	TPSCON39 ^a	4
Straight			
	3P	LV429263	3
	4P	LV429264	4
Edge wise			
	3P	LV429308	3
	4P	LV429309	4

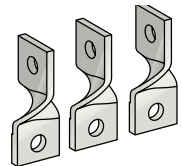
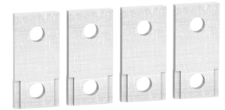

^a: For incomings only

^b: For load only.

Electrical and Mechanical Accessories - Frame 250

Compatibility Matrix

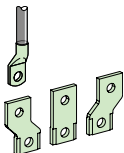
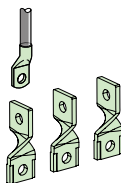
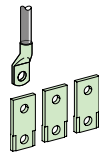
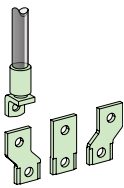
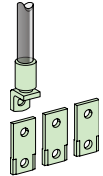
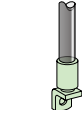

Type of conductor	No insulation	Interphase barrier	Long terminal shield	Insulating screen for 1 lug per terminal	Insulating screen for 2 lugs per terminal
Cables(Al) +crimp lugs	-	Mandatory (Supplied)	Possible	-	-
Cables(Cu) +crimp lugs	-	Mandatory (Supplied)	Possible	Possible	Possible
Cables (Al) + crimp lugs + straight terminal extensions	-	Mandatory (Supplied)	-	Mandatory	-
Cables (Al) + crimp lugs + Spreader terminal extensions	-	Mandatory (Supplied)	-	Mandatory	-
Cables (Cu) + crimp lugs + straight terminal extensions	-	Mandatory (Supplied)	-	Mandatory	NA/Mandatory (120 mm 2 only)
Cables (Cu) + crimp lugs + edgewise terminal extensions	-	Mandatory (Supplied)	-	Possible	-
Cables (Cu) +crimp lugs +Spreader terminal extensions	-	Mandatory (Supplied)	-	Mandatory	NA/Mandatory (120 mm 2 only)

Electrical and Mechanical Accessories - Frame 250

Compatibility Matrix

Type of conductor	No insulation	Interphase barrier	Long terminal shield	Insulating screen
Cables +Steel connectors LV429242 LV429243	Possible	Possible	Possible	-
Cables +Alluminum connectors TPSCON47 TPSCON48 TPSCON49 TPSCON50 TPSCON51 TPSCON52	-	-	Mandatory	-
Cables +connectors +Alluminum connectors LV429227 LV429259 LV429228 LV429260	Possible	Possible	Possible	-
Insulated bars	Possible	Possible	Possible	Possible
Insulated bars +straight terminal extension	Mandatory (supplied)	-	-	Mandatory
Insulated bars +edgewise terminal extension	Mandatory (supplied)	-	-	Possible
Insulated bars +spreader terminal extension	Mandatory (supplied)	-	-	Mandatory

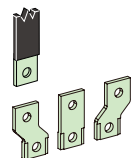
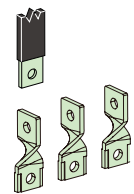
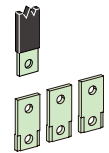
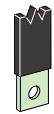
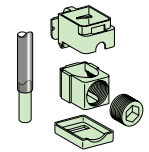
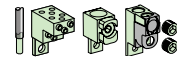
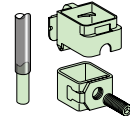

B

Electrical and Mechanical Accessories- Frame 630

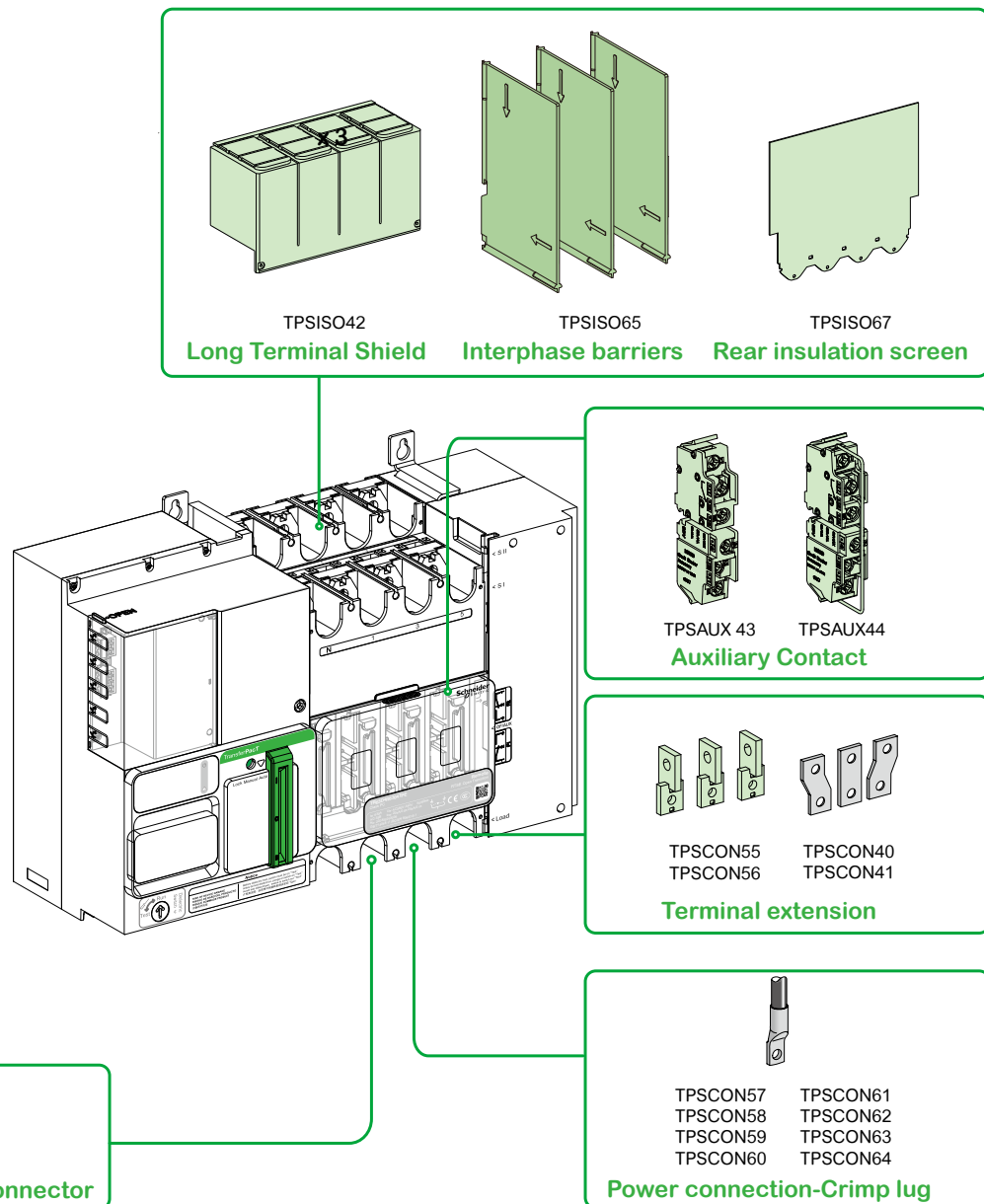

Electrical and Mechanical Accessories- Frame 630

Auxiliary Contact Module

- TPSAUX43: provide the open and closed status indication for both source I and source II .
- TPSAUX44: provide the open and closed status indication for OFF position .

Insulating Accessories

Terminal Shield

Optional accessory, provide terminal protection on the cable incoming and output.

- TPSISO42: Terminal shield (set of 1)

Interphase Barrier

Optional accessory, provide protection for the cable incoming and output, effectively avoiding short circuits between phases.

- TPSISO65: Interphase barriers (set of 3)

Insulation Screen

Optional accessory, provide protection for the cable incoming and output.

- TPSISO67: Insulating screen (set of 1). Applicable for source and load, maximum 3 set.



Electrical and Mechanical Accessories- Frame 630

Connection Accessories

Bare Cable Connector



Cable Material	Number	Cross Section	Pole	Commercial Reference	Quantity
Aluminum	1 cable	35 to 300 mm ²	3P	TPSCON53 ^b	3
			4P	TPSCON54 ^b	4

b: Must select terminal shield to ensure incoming and output terminal protection.

Crimp Lug for Cables

- Natively supplied with interphase barriers.



Cable Material	Cross Section	Pole	Commercial Reference	Quantity
Aluminum	240 mm ²	3P	TPSCON61	3
		4P	TPSCON62	4
	300 mm ²	3P	TPSCON63	3
		4P	TPSCON64	4
Copper	240 mm ²	3P	TPSCON57	3
		4P	TPSCON58	4
	300 mm ²	3P	TPSCON59	3
		4P	TPSCON60	4

Terminal Extension

- Natively supplied with interphase barriers.



Type	Pole	Commercial Reference	Quantity	
Spreaders	45-55 mm	3P	TPSCON40	3
		4P	TPSCON41 ^a	4
		3P	TPSCON68 ^b	4
		4P	TPSCON68 ^b	4
Edge wise	3P	TPSCON55	3	
	4P	TPSCON56	4	

a: For incomings only

b: For load only.

Electrical and Mechanical Accessories- Frame 630

Compatibility Matrix

Type of Conductor	No Insulation	Interphase Barrier	Long Terminal Shield	Insulating Screen for 1 Lug per Terminal	Insulating Screen for 2 Lugs per Terminal
Cables (Al) +crimp lugs	-	Mandatory (Supplied)	Possible (instead of phase barriers)	SI: front screen mandatory Load: front screen mandatory	-
Cables (Cu) +crimp lugs	-	Mandatory (Supplied)	Possible (instead of phase barriers)	SII: rear screen possible	SII: rear screen mandatory
Cables (Alu) +crimp lugs +Spreaders terminal extensions	-	Mandatory (Supplied)	-	SI: front screen mandatory SII: rear screen mandatory Load: front screen mandatory	-
Cables (Cu) +crimp lugs + edgewise terminal extensions	-	Mandatory (Supplied)	-	Possible	-
Cables (Alu) +crimp lugs +Spreaders terminal extensions	-	Mandatory (Supplied)	-	SI: front screen mandatory SII: rear screen mandatory Load: front screen mandatory	SI: front screen mandatory SII: rear screen mandatory Load: front screen mandatory
cables+ aluminum connectors	-	-	Mandatory	-	-
Insulated bars	Possible	Possible	Possible	Possible	-
Insulated bars +edgewise terminal extension	-	Mandatory (supplied)	-	Possible	-
Insulated bars +spreader terminal extension	-	Mandatory (supplied)	-	Mandatory	-

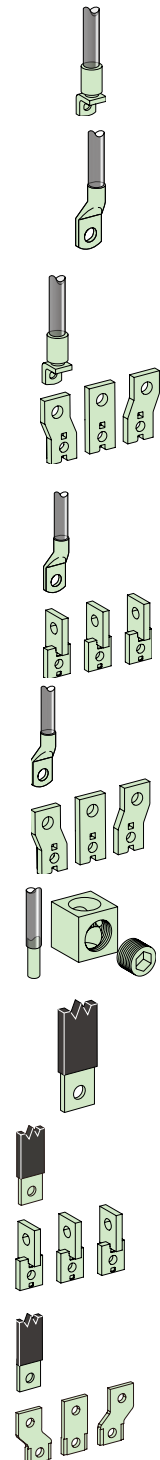

B

Electrical and Mechanical Accessories- Frame 800

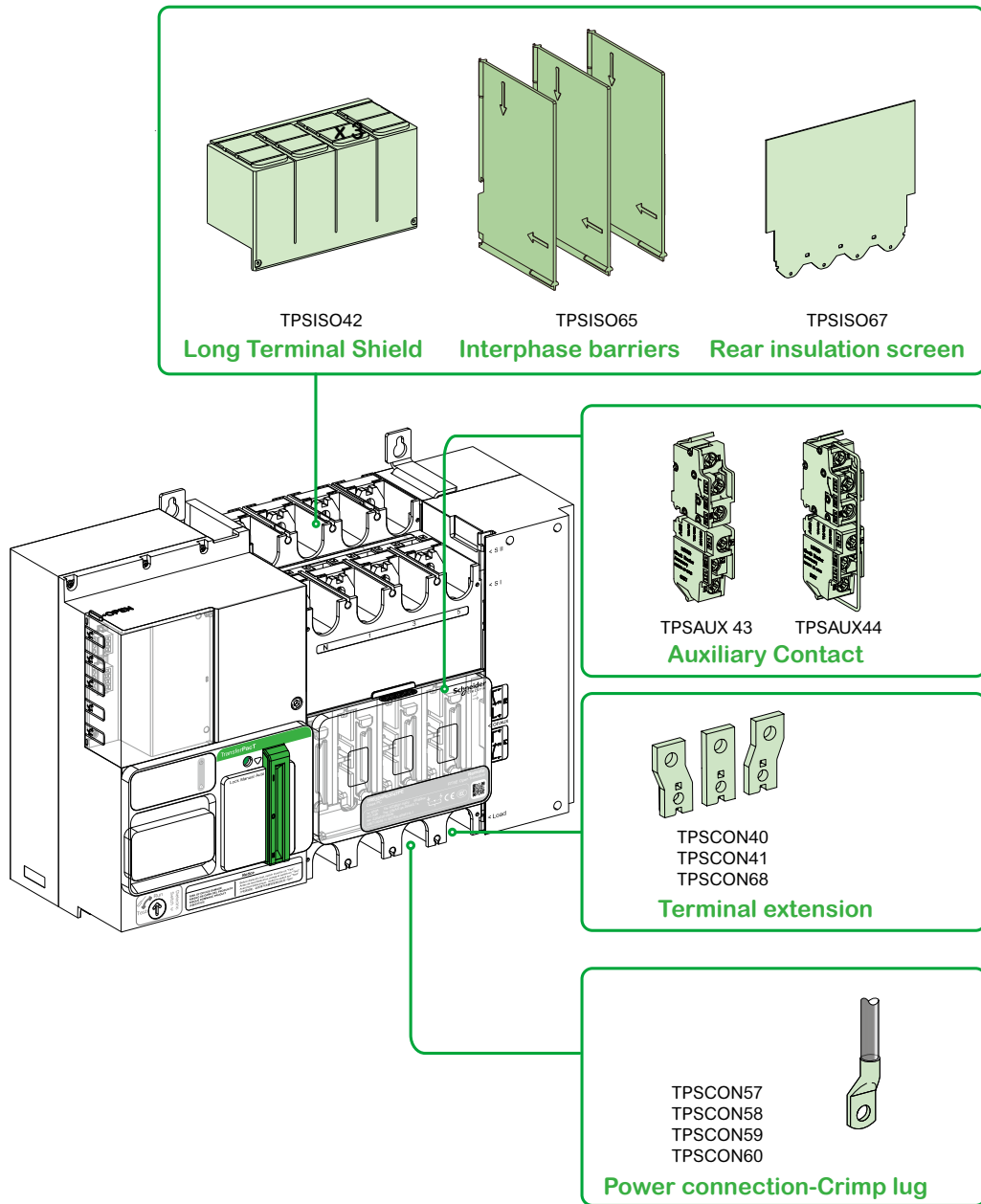

TransferPacT
Remote
Frame 800

Electrical and Mechanical Accessories- Frame 800

Auxiliary Contact Module

- TPSAUX43: Provide the open and closed status indication for both source I and source II .
- TPSAUX44: Provide the open and closed status indication for OFF position .

Insulating Accessories

Terminal Shield

Optional accessory: Provide terminal protection on the cable incoming and output.

- TPSISO42: Terminal shield (set of 1)

Interphase Barrier

Optional accessory: Provide protection for the bar incoming and output, effectively avoiding short circuits between phases.

- TPSISO65: Interphase barriers (set of 3)

Insulation Screen

Optional accessory: Provide protection for the cable incoming and output.

- TPSISO67: Insulating screen (set of 1). Applicable for source and load, maximum 3 set.



Electrical and Mechanical Accessories- Frame 800

Crimp Lug for Cables

- Natively supplied with interphase barriers.



Cable Material	Cross Section	Pole	Commercial Reference	Quantity
Copper	240 mm ²	3P	TPSCON57	3
		4P	TPSCON58	4
	300 mm ²	3P	TPSCON59	3
		4P	TPSCON60	4

Terminal Extension

- Natively supplied with interphase barriers.



Type	Pole	Commercial Reference	Quantity
Spreaders			
45-55 mm	3P	TPSCON40	3
	4P	TPSCON41 ^a	4
	3P	TPSCON68 ^b	4
	4P	TPSCON68 ^b	4

- a:** For incomings only
- b:** For load only.

Electrical and Mechanical Accessories- Frame 800

Compatibility Matrix

Type of Conductor	No Insulation	Interphase Barrier	Long Terminal Shield	Insulating Screen for 1 Lug per Terminal	Insulating Screen for 2 Lugs per Terminal
Cables (Cu) +crimp lugs	-	Mandatory (Supplied)	-	SII: rear screen possible	SII: rear screen mandatory
Insulated bars	Possible	Possible	Possible	Possible	-
Insulated bars +spreader terminal extension	-	Mandatory (supplied)	-	Mandatory	-

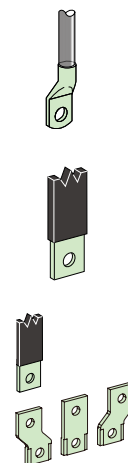

Terminal Definition and Transfer Process

Terminal Definition

TransferPacT Remote provides transfer solutions with input and output terminals.

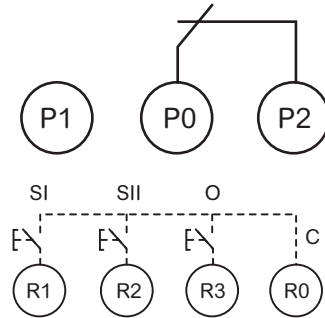

Description	Terminal label	Definition
Product Availability	P0	Common Terminal for P1,P2
	P1	output signal, when either source voltage is in range and product is NOT in manual mode, NO terminal will close.
	P2	output signal, when either source voltage is in range and product is NOT in manual mode, NC terminal will open.
Remote Transfer	R0	Common Terminal for R1,R2,R3
	R1	Passive input signal, remote transfer to position I when closed with R0 and last for at least 200ms.
	R2	Passive input signal, remote transfer to position II when closed with R0 and last for at least 200ms
	R3	Passive input signal, remote transfer to position O when closed with R0 and last for at least 200ms

Remote Transfer Process

The RTSE transfers to a stable position after receiving a rising edge signal. The rising edge signal should last for no less than 200 ms.

The RTSE will remain on the stable position until receiving a new signal. It will not respond to the new signal when:

- Position slider is in the left and transfer switch equipment is in RUN mode.
- Transfer switch equipment is in alarm state.
- Transfer switch equipment is executing the transfer action.

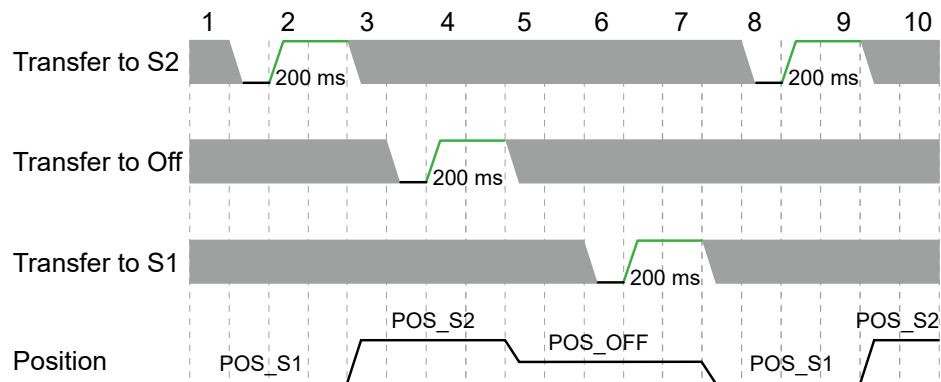

■ : No requirement on the signal voltage level. It can either be high or low level.

Remote Transfer Switching Equipment

Class PC

TransferPacT Remote Frame 250/3P, 4P

Minimum Electrical Clearance

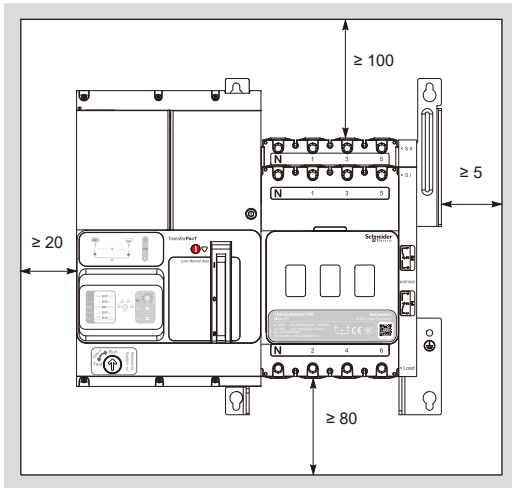

Bare Product

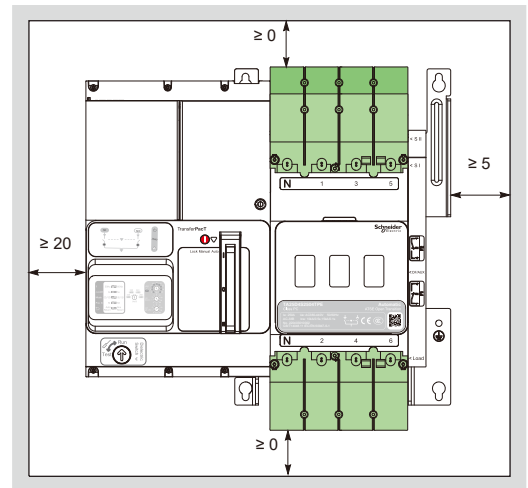

With Terminal Shield

B

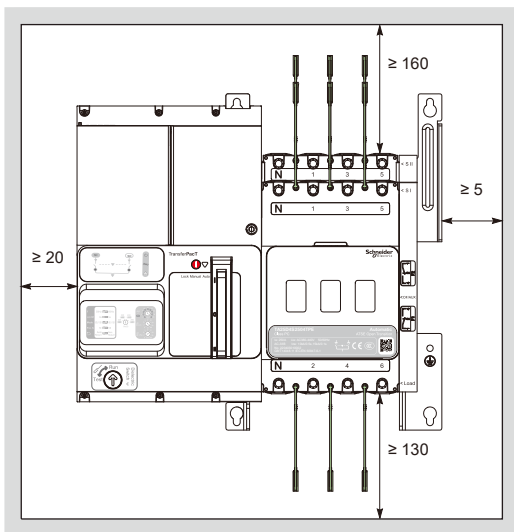

With Interphase Barriers

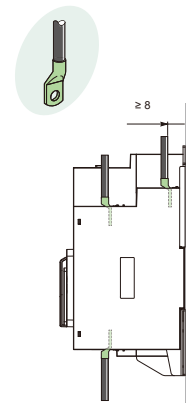

Crimp Lug to Base Plate

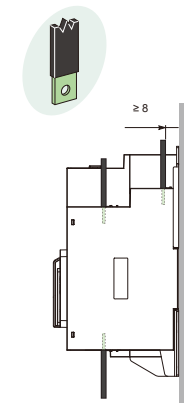

Busbar to Base Plate

Remote Transfer Switching Equipment

Class PC

TransferPacT Remote Frame 630/3P, 4P

Minimum Electrical Clearance

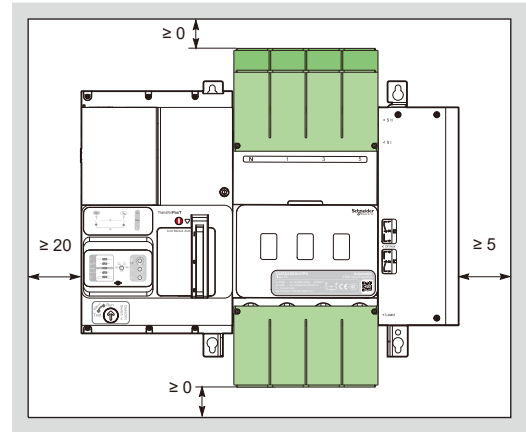
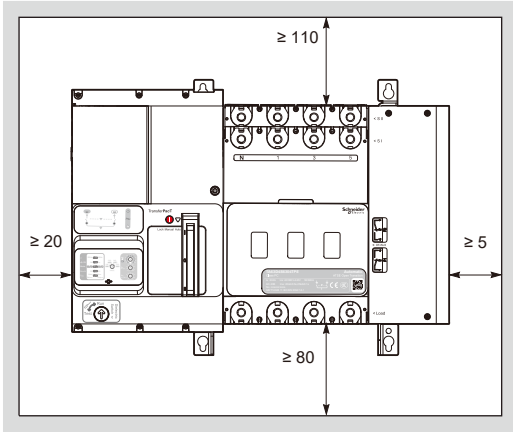

Bare Product

With Terminal Shield

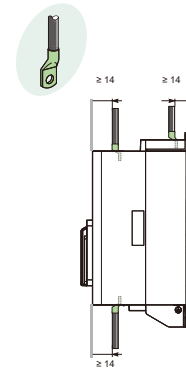
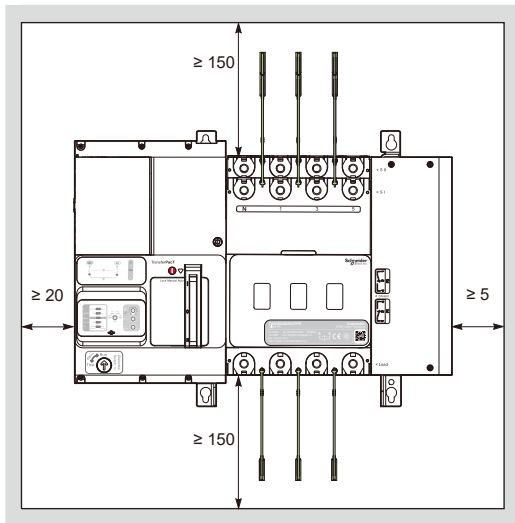

Crimp Lug to Base Plate

With Interphase Barriers



Busbar to Base Plate

Remote Transfer Switching Equipment

Class PC

TransferPacT Remote Frame 800/3P, 4P

Minimum Electrical Clearance

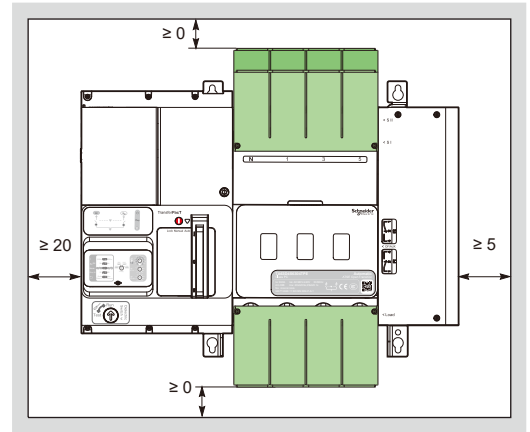
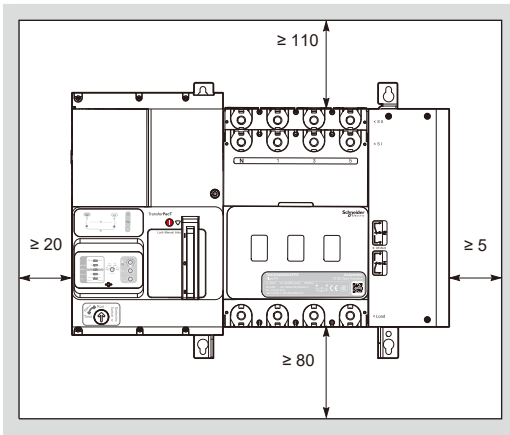

B

Bare Product

With Terminal Shield

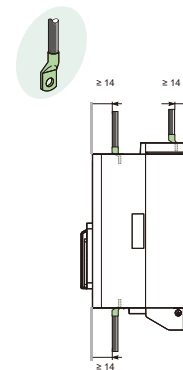
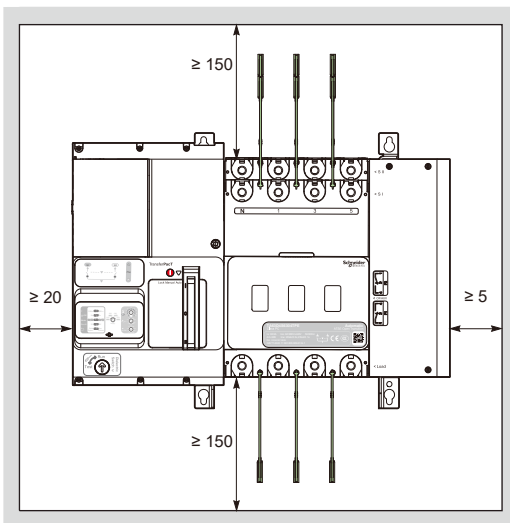

With Interphase Barriers

Crimp Lug to Base Plate

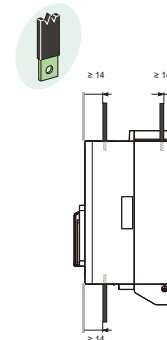

Busbar to Base Plate

Remote Transfer Switching Equipment

Class PC

TransferPacT Remote Frame 250 / 3P, 4P

Dimensions

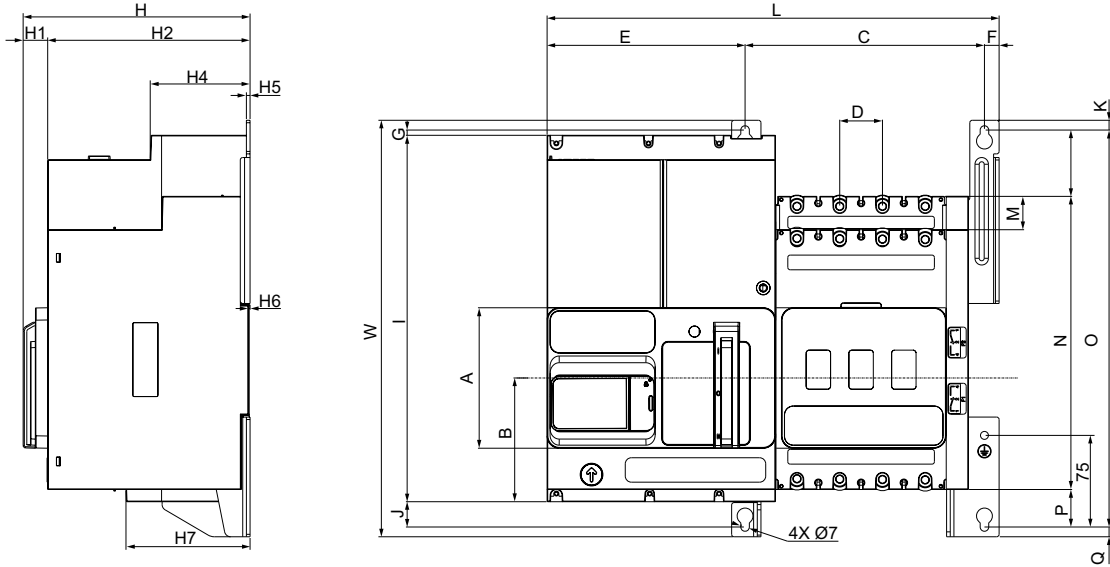

Panel and Front Panel Cut

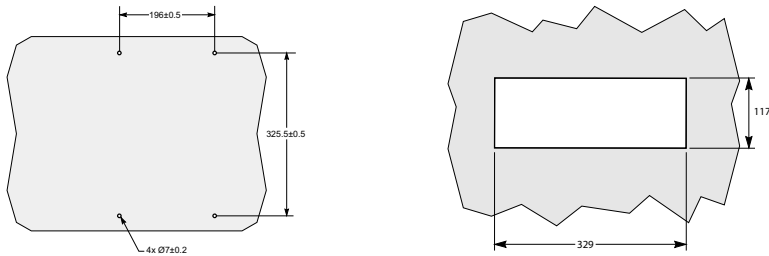

Frame	L	W	H	A	B	C	D	E	F	H1	H2	
250	370	341	185.8	115	101.3	196	35	162	12	20.1	165.7	
Frame	H4	H5	H6	H7	I	J	K	M	N	O	P	Q
250	81.75	3	0.7	101.6	300	20.7	8	27.3	240	325	30.7	8

Remote Transfer Switching Equipment

Class PC

TransferPacT Remote Frame 630 / 3P, 4P

Dimensions

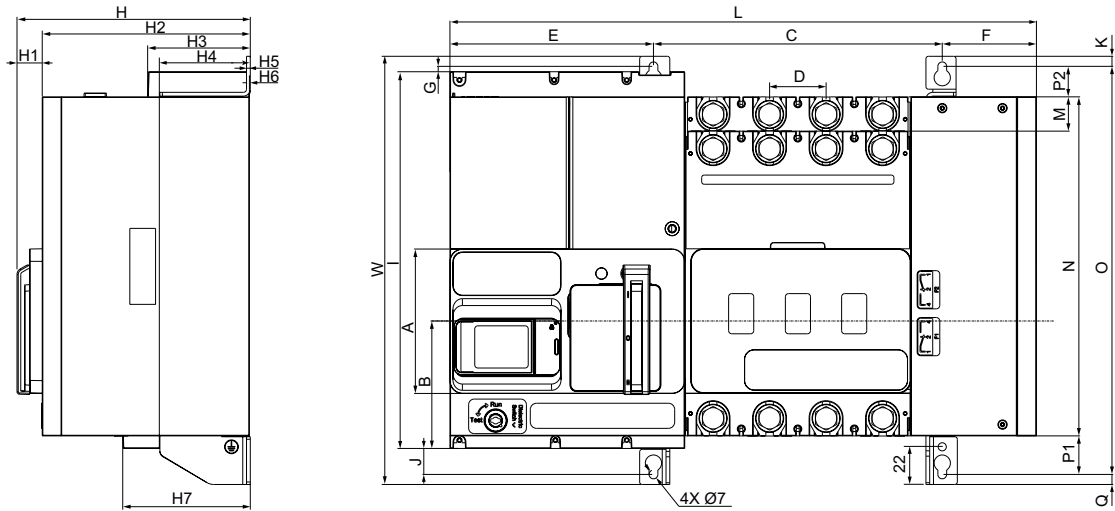

B

Panel and Front Panel Cut

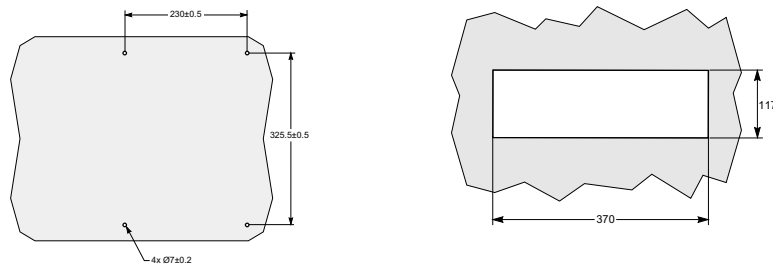

Frame	L	W	H	A	B	C	D	E	F	G	H1	H2	H3
630	467	341	185.8	115	101.5	230	45	162	75	4.3	20.1	165.7	81.7
Frame	H4	H5	H6	H7	I	J	K	M	N	O	P1	P2	Q
630	72.45	3	0.7	101.6	300	20.7	8	27.3	270	325	30.7	24.3	8

Remote Transfer Switching Equipment

Class PC

TransferPacT Remote Frame 800 / 3P, 4P

Dimensions

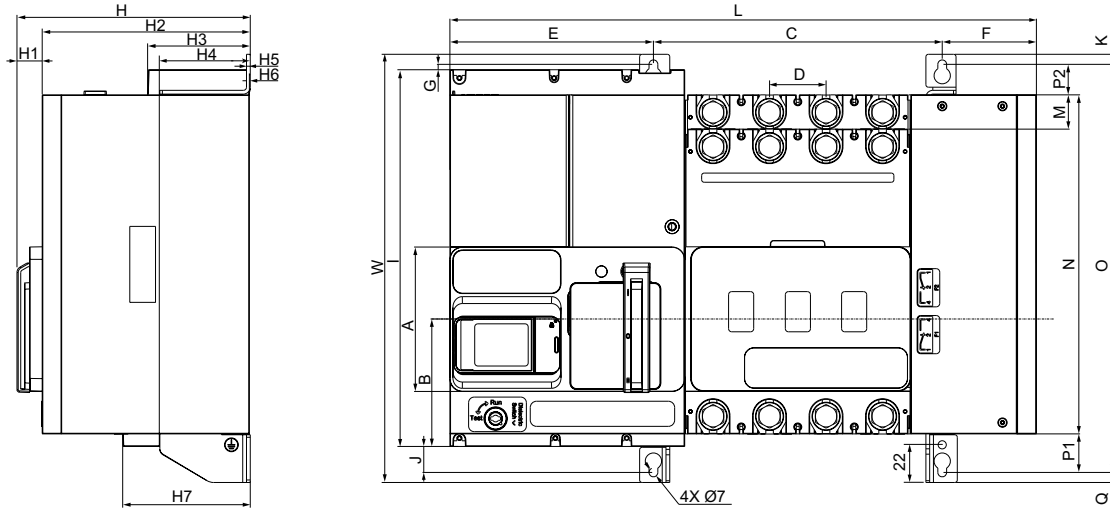

Panel and Front Panel Cut

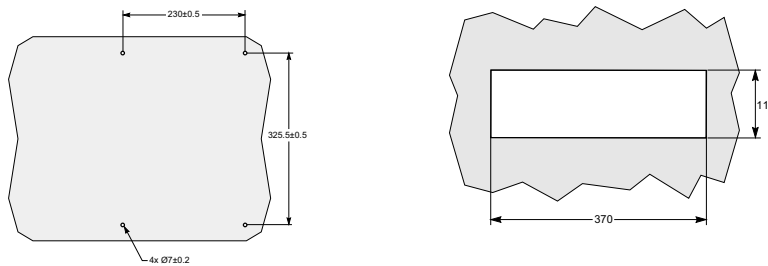

Frame	L	W	H	A	B	C	D	E	F	G	H1	H2	H3
800	467	341	185.8	115	101.5	230	45	162	75	4.3	20.1	165.7	81.7
Frame	H4	H5	H6	H7	I	J	K	M	N	O	P1	P2	Q
800	72.45	3	0.7	101.6	300	20.7	8	27.3	270	325	30.7	24.3	8

Remote Transfer Switching Equipment

Auxiliary Contact for Frame 250 & Frame 630 & Frame 800

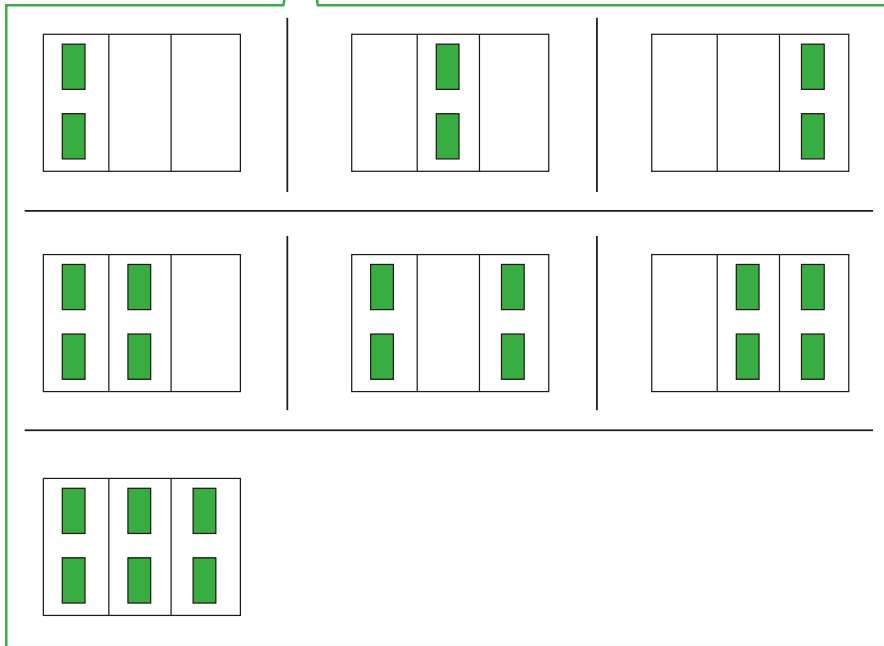
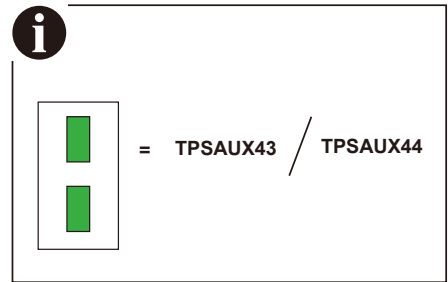
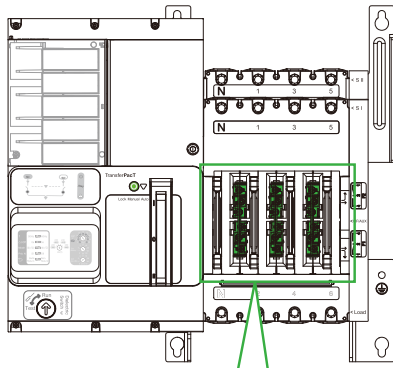

Remote Transfer Switching Equipment

Class PC

TransferPacT Remote , Frame 250, Wiring Capacity

Dimensions for Frame 250

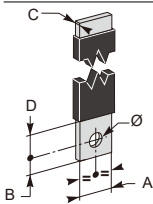
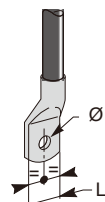
	Pole partition	(mm)	35
	Bars	A (mm)	≤ 25
		B (mm)	≤ 10
		C (mm)	≤ 6
		D (mm)	10 ≤ D ≤ 15
		Ø (mm)	≥ 8
	Cable with Crimp Lug	L (mm)	≤ 25
		Ø (mm)	≥ 8
	Torque	(Nm)	15±1.5

Connection of Bare Cables to Frame 250

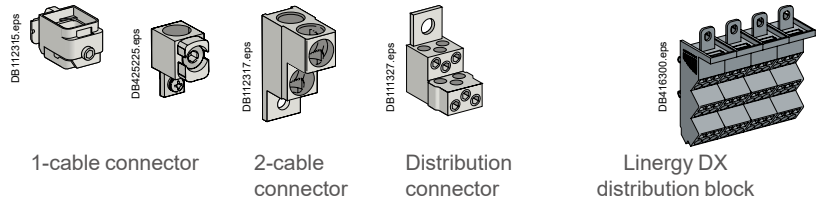

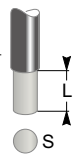
	1-cable connector	Steel ≤ 160 A	Aluminium ≤ 250 A	
	L (mm)	25	25	
	S (mm ²) Cu/Al	1.5 to 95 ^[1]	25 to 50	70 to 95 120 to 240 150 max. flex.
	Torque (Nm)	12	20	26 31
	2-cable connector			
	L (mm)	25 or 50		
	S (mm ²) Cu/Al	2 x 50 to 2 x 120		
	Torque (Nm)	22		
	6-cable distribution connector (aluminium)			
	L (mm)	15 or 30		
	S (mm ²) Cu/Al	1.5 to 6 ^[1]	8 to 35	
	Torque (Nm)	4	6	
	Linergy DP distribution block (9 cables)			
	L (mm)	12	16	
	S (mm ²) Cu/Al	6 x 4 to 10	3 x 6 to 16	

[1] For flexible cables from 1.5 to 4 mm², connection with crimped or self-crimping ferrules.

Remote Transfer Switching Equipment

Class PC

TransferPacT Remote , Frame 630, Wiring Capacity

Dimensions for Frame 630

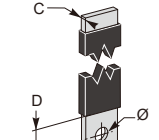
	Pole partition (mm)	45
	Bars	
	A (mm)	≤ 32
	B (mm)	≤ 15
	C (mm)	3 ≤ D ≤ 10
	D (mm)	13 ≤ D ≤ 15
	Ø (mm)	≥ 10

B

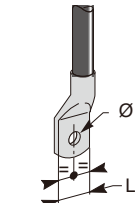
	Cable with Crimp Lug	L (mm)	≤ 25
		Ø (mm)	≥ 10

	Torque (Nm)	50±5
--	-------------	------

Connection of Bare Cabels to Frame 630

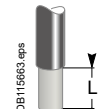

1-cable connector

	1-cable connector	
	L (mm)	30
	S (mm ²) Cu/Al	35 to 300 rigid 240 max. flex.
	Torque (Nm)	31

Remote Transfer Switching Equipment

Class PC

TransferPacT Remote , Frame 800, Wiring Capacity

Dimensions for Frame 800

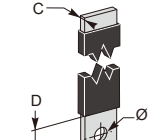
Pole partition	(mm)	45
	A (mm)	≤ 32
	B (mm)	≤ 15
	C (mm)	8 ≤ D ≤ 17
	D (mm)	13 ≤ D ≤ 15
	Ø (mm)	≥ 10

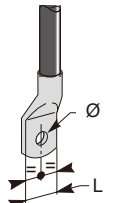
	Cable with Crimp Lug L (mm)	≤ 25
	Ø (mm)	≥ 10

Torque	(Nm)	50±5
--------	------	------

Remote Transfer Switching Equipment

TransferPacT Remote

Wiring Diagrams for Frame 250: 160 A-250 A

B

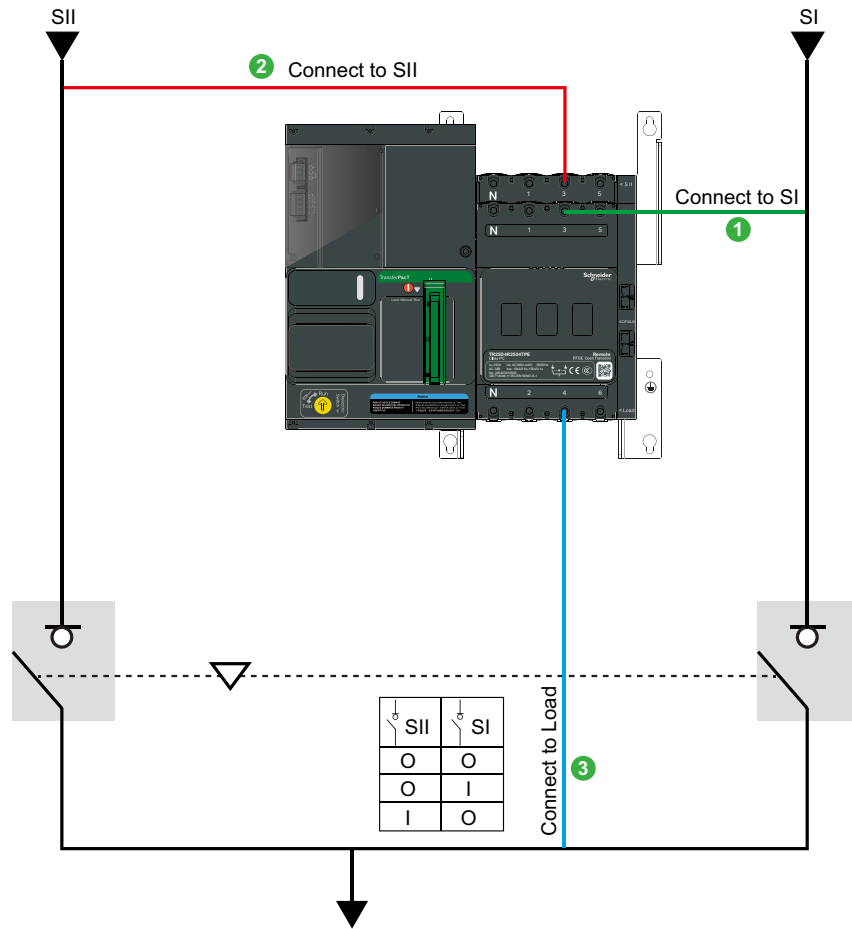

3P/4P

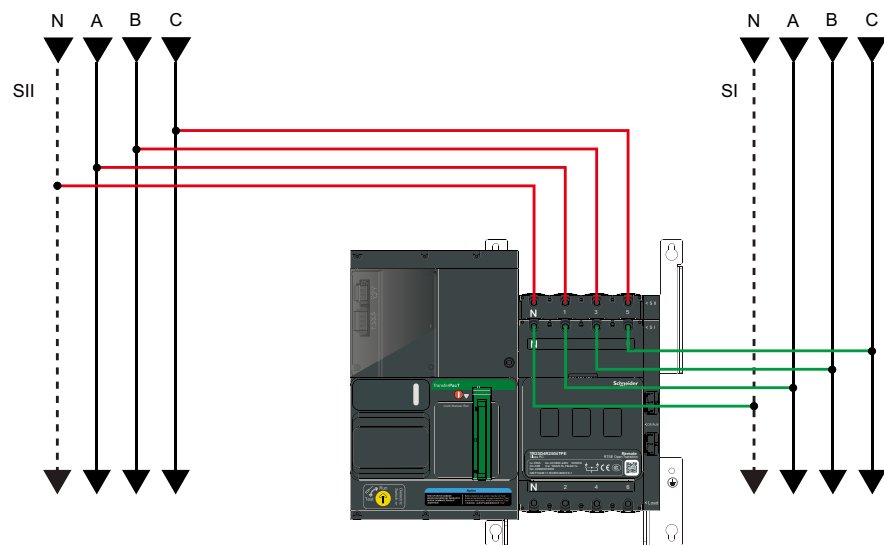

Remote Transfer Switching Equipment

TransferPacT Remote

Wiring Diagrams for Frame 630: 320 A-630 A and Frame 800: 800A

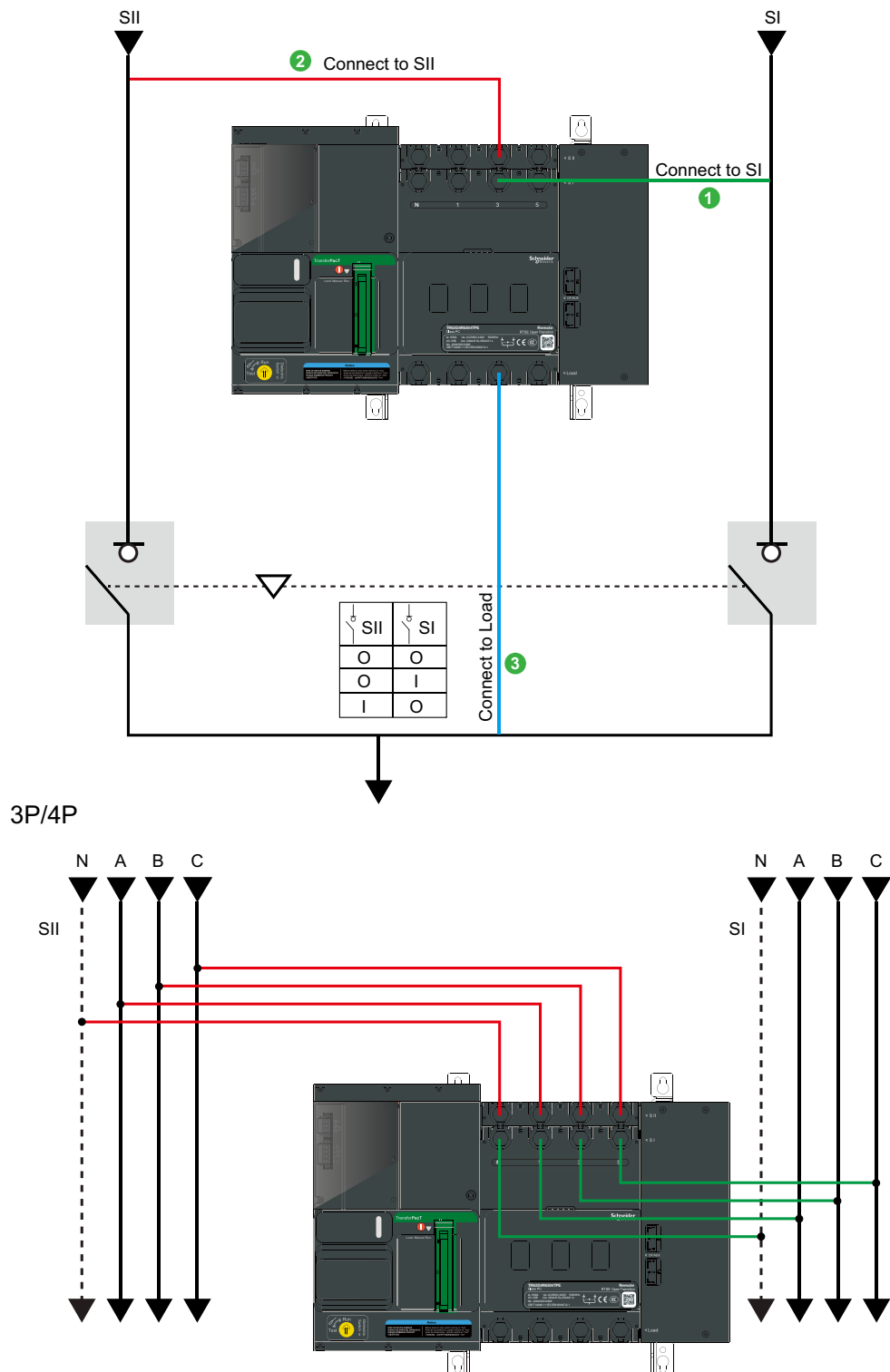

Remote Transfer Switching Equipment Auxiliary Contact



TPSAUX43

B

- (A) SI open
- (B) SI closed
- (C) SII open
- (D) SII closed

Transfer switching equipment is closed at SI:

- F11-F14 is closed
- F11-F12 is opened

Transfer switching equipment is closed at SII:

- F21-F24 is closed
- F21-F22 is opened

Transfer switching equipment is at OFF position:

- F11-F12 and F21-F22 are closed
- F11-F14 and F21-F24 are opened

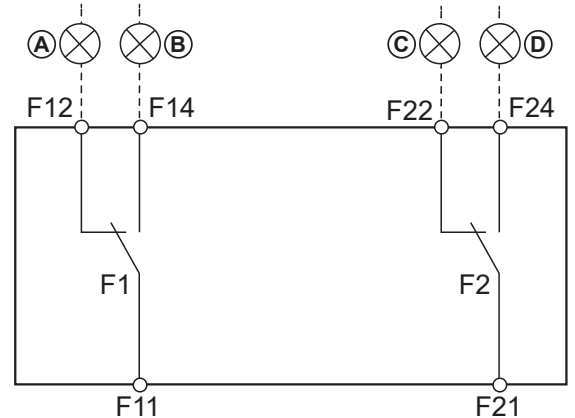

TPSAUX44

Transfer switching equipment is at OFF position:
F12-F22 is closed

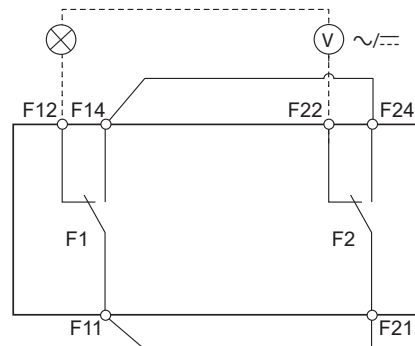

Transfer switching equipment is not at OFF position:
F11-F14 and F21-F24 are closed

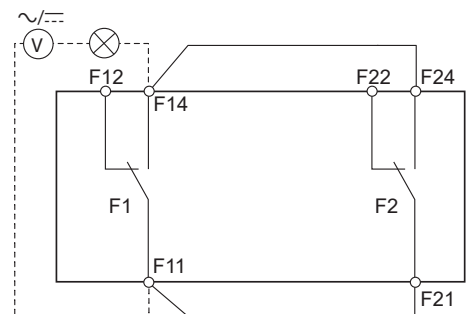

NOTE: terminal capacity for auxiliary contact is AC250 V 2 A.

References of TransferPacT Remote 160-800 A

TransferPacT Remote

TR25D4R2504TPE_image.png



TR63D4R6304TPE.png



	3P	4P
250A ¹	TR25D3R2502TPE	TR25D4R2502TPE
160A	TR25D3R1604TPE	TR25D4R1604TPE
200A	TR25D3R2004TPE	TR25D4R2004TPE
250A	TR25D3R2504TPE	TR25D4R2504TPE
630A ¹	TR63D3R6302TPE	TR63D4R6302TPE
800A ¹	TR80D3R8002TPE	TR80D4R8002TPE
320A	TR63D3R3204TPE	TR63D4R3204TPE
400A	TR63D3R4004TPE	TR63D4R4004TPE
500A	TR63D3R5004TPE	TR63D4R5004TPE
630A	TR63D3R6304TPE	TR63D4R6304TPE
800A	TR80D3R8004TPE	TR80D4R8004TPE

1. For phase to phase 208V/220V/230V/240V application.

Connection Accessory

Auxiliary Contacts

TPSAUX43_image.png



OF for Source position for frame 250 and frame 630	TPSAUX43
OF for Off position for frame 250 and frame 630	TPSAUX44

Insulation Accessory

TPSISO42_image.png



TPSISO29_ISO.png



TPSISO67_image.png



Terminal Shield for frame 250 (100 - 250 A) (set of 1)	LV429518
Terminal Shield for frame 630 (320 - 630 A) (set of 1)	TPSISO42
Interphase barriers for frame 250 (100 - 250 A) and frame 630 (320 - 630 A) (set of 3)	TPSISO65
Insulating screen for frame 250 (100 - 250 A) (set of 1).	TPSISO66
Insulating screen for frame 630 (320 - 630 A) (set of 1).	TPSISO67

References of TransferPacT Remote 160-800 A

B

Connection Accessory - Bare Cable Connector

Aluminum		
 <p>TPSCON49_image.png</p>	1 cable 25 mm ² to 95 mm ² , frame 250 (set of 3).	LV429227
	1 cable 25 mm ² to 95 mm ² , frame 250 (set of 4).	LV429228
	1 cable 120mm ² to 185mm ² , frame 250 (set of 3).	LV429259
	1 cable 120mm ² to 185mm ² , frame 250 (set of 4).	LV429260
	1 cable 120 to 240 mm ² , frame 250 (set of 3).	TPSCON49 ^b
	1 cable 120 to 240 mm ² , frame 250 (set of 4).	TPSCON50 ^b
	1 cable 35 to 300 mm ² , frame 630 (set of 3).	TPSCON53 ^b
	1 cable 35 to 300 mm ² , frame 630 (set of 4).	TPSCON54 ^b
	2 cables 50 to 120 mm ² , frame 250 (set of 3).	TPSCON51 ^{a,b}
	2 cables 50 to 120 mm ² , frame 250 (set of 4).	TPSCON52 ^{a,b}
	6 cables 1.5 to 35 mm ² , frame 250 (set of 3).	TPSCON47 ^b
	6 cables 1.5 to 35 mm ² , frame 250 (set of 4).	TPSCON48 ^b
	9 cables for frame 250 (set of 3).	LVS04033
	9 cables for frame 250 (set of 4).	LVS04034
Steel		
 <p>FB10325LV429243.jpg</p>	1 cable 1.5 to 95 mm ² , frame 250, up to 160 A only (set of 3).	LV429242
	1 cable 1.5 to 95 mm ² , frame 250, up to 160 A only (set of 4).	LV429243

- a: Applicable for load side only
- b: Must select terminal shield to ensure incoming and output terminal protection.

Connection Accessory - Crimp Lug

Aluminum			
 <p>TPSCON61_image.png</p>	150 mm ² , frame 250 (set of 3).	LV429504	
	150 mm ² , frame 250 (set of 4).	LV429505	
	185 mm ² , frame 250 (set of 3).	LV429506	
	185 mm ² , frame 250 (set of 4).	LV429507	
	240 mm ² , frame 630 (set of 3).	TPSCON61	
	240 mm ² , frame 630 (set of 4).	TPSCON62	
	300 mm ² , frame 630 (set of 3).	TPSCON63	
	300 mm ² , frame 630 (set of 4).	TPSCON64	
	Copper		
	 <p>TPSCON57_image.png</p>	120 mm ² , frame 250 (set of 3).	LV429252
120 mm ² , frame 250 (set of 4).		LV429256	
150 mm ² , frame 250 (set of 3).		LV429253	
150 mm ² , frame 250 (set of 4).		LV429257	
185 mm ² , frame 250 (set of 3).		LV429254	
185 mm ² , frame 250 (set of 4).		LV429258	
240 mm ² , frame 630 (set of 3).		TPSCON57	
240 mm ² , frame 630 (set of 4).		TPSCON58	
300 mm ² , frame 630 (set of 3).		TPSCON59	
300 mm ² , frame 630 (set of 4).		TPSCON60	

References of TransferPacT Remote 160-800 A

Connection Accessory - Terminal Extensions



edgewise terminal extensions for frame 250 (set of 3)	LV429308
edgewise terminal extensions for frame 250 (set of 4)	LV429309
edgewise terminal extensions for frame 630 (set of 3)	TPSCON55
edgewise terminal extensions for frame 630 (set of 4)	TPSCON56
Straight terminal extensions for frame 250 (set of 3)	LV429263
Straight terminal extensions for frame 250 (set of 4)	LV429264
Spreader for frame 100(set of 4), load side only	TPSCON35^b
Spreader for frame 160(set of 4), load side only	TPSCON36^b
35 mm ~ 45mm Spreader for frame 250 (set of 3)	LV431563
35 mm ~ 45mm Spreader for frame 250 (set of 4), load side only	LV431564^b
35 mm ~ 45mm Spreader for frame 250 (set of 4), incomings only	TPSCON39^a
45 mm ~ 55mm Spreader for frame 630 (set of 3)	TPSCON40
45 mm ~ 55mm Spreader for frame 630 (set of 4), incomings only	TPSCON41^a
45 mm ~ 55mm Spreader for frame 630 (set of 4), load side only	TPSCON68^b

a: for incomings only

b: for load side only



TransferPacT FXM

Switching Devices.....	C-2
TransferPacT FXM100 to 630.....	C-4
MTSE/Manual Source-Changeover Systems	C-8
References of TransferPacT FXM.....	C-9
Order Form for Manual Source-Changeover Systems ..	C-10

Switching Devices

M

Complete Source-changeover Assembly (or MTSE: Manual Transfer Switching Equipment)

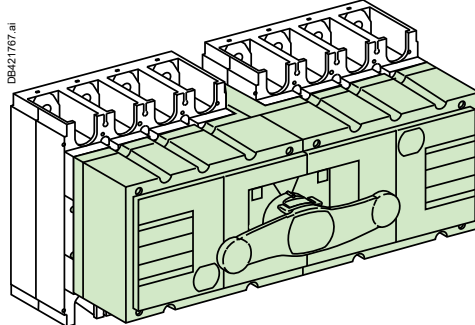

Definition of Class PC

Transfer switch equipment based on mechanical switching devices, that do not need electrical power to hold the main contacts open or closed and capable of making, carrying, and breaking currents under normal circuit conditions including operating overload conditions, and making and withstanding short-circuit currents.

Definition of Derived TSE

TSE based on switching devices that have certain tests required for compliance with IEC 60947-6-1 as defined in Table 9, covered by IEC 60947-3 for Class PC, IEC 60947-2 or IEC 60947-6-2 for Class CB, or IEC 60947-4-1 for Class CC

Definition of MTSE (Manual Transfer Switching Equipment)

Manually operated transfer switching equipment, transfer switching equipment operated manually and non-electrically.

TransferPacT FXM is a Class PC, Derived MTSE (Complete Source-Changeover Assembly)

These assemblies provide an easy way to implement source changeover functions with:

- A single 3-position rotary handle that controls the two switch-disconnectors (Normal source ON, OFF, Replacement source ON)
- A smaller size, taking up less room in the switchboard.

A complete source changeover assembly can be ordered with a single catalog number.

Switching Devices

Complete source changeover assembly

	TransferPacT FXM100 to 250			TransferPacT FXM320 to 630		
	Normal ON	OFF	Replacement ON	Normal ON	OFF	Replacement ON
Locking by padlocks	<input type="radio"/>	<input checked="" type="radio"/>	<input type="radio"/>	<input type="radio"/>	<input checked="" type="radio"/>	<input type="radio"/>
Locking by keylock	-	<input checked="" type="radio"/>	-	-	<input checked="" type="radio"/>	-
Door locking ^[1]	<input checked="" type="radio"/>	-	<input checked="" type="radio"/>	<input checked="" type="radio"/>	-	<input checked="" type="radio"/>
Door lock defeat ^[1]	<input checked="" type="radio"/> ^[2]	-	<input checked="" type="radio"/> ^[2]	<input checked="" type="radio"/> ^[2]	-	<input checked="" type="radio"/> ^[2]
Door locking device padlocked ^[1]	-	<input checked="" type="radio"/>	-	-	<input checked="" type="radio"/>	<input checked="" type="radio"/>
Lead-sealable handle	<input type="radio"/>	<input checked="" type="radio"/>	<input type="radio"/>	<input type="radio"/>	<input checked="" type="radio"/>	<input type="radio"/>

Standard. By simple modification of the standard rotary handle.
^[1] With extended rotary control. ^[2] Using a special tool.



TransferPacT FXM100 to 630

(Complete Source-Changeover Assembly)

3114_image_2.eps



Complete source-changeover assembly.

PB110865_60.eps

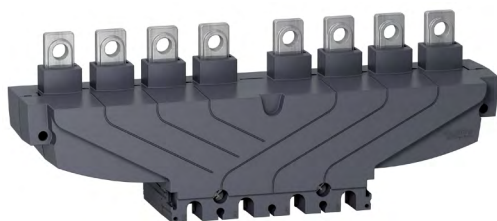

Coupling accessory.

FXM

Number of poles

Electrical characteristics as defined by IEC 60947-1 / 60947-6-1 and EN 60947-1 / 60947-6-1

Conventional thermal current (A)	I_{th}	at 60 °C
Conventional thermal current in enclosure	I_{the}	at 60 °C
Rated insulation level (V)	U_i	AC 50/60 Hz
Impulse-withstand voltage (kV)	U_{imp}	
Rated operational voltage (V)	U_e	AC 50/60 Hz DC
Rated operational voltage AC20 and DC20 (V)		AC 50/60 Hz
Rated operational current (A)	I_e	Electrical AC 50/60 Hz 220-240 V 380-415 V 440-480 V 500-525 V 660-690 V
		Electrical DC 125 V (2P in series) 250 V (4P in series)

Rated duties

Uninterrupted duty

Intermittent duty

Short-circuit making capacity (kA peak)	I_{cm}	Min. (switch-disconnector alone) Max. (with upstream protection circuit breaker)
Short-time withstand current (A rms)	I_{cw}	1 s 3 s 20 s 30 s

Suitability for isolation

Durability (category A) (O - C-O cycles)

Mechanical

Electrical AC 50/60 Hz
440 V
500 V
690 V

Electrical DC

250 V

Positive contact indication

Visible break

Emergency-off switch-disconnector

Degree of pollution

Upstream protection

See the "Complementary technical information".

TransferPacT FXM100 to 630 (Complete Source-Changeover Assembly)

FXM100		FXM160		FXM200		FXM250		FXM320		FXM400		FXM500		FXM630		
3-4		3-4		3-4		3-4		3-4		3-4		3-4		3-4		
100		160		200		250		320		400		500		630		
100		160		200		250		320		400		500		630		
750		750		750		750		750		750		750		750		
8		8		8		8		8		8		8		8		
690		690		690		690		690		690		690		690		
250		250		250		250		250		250		250		250		
750		750		750		750		750		750		750		750		
AC22A	AC23A	AC22A	AC23A	AC22A	AC23A	AC22A	AC23A	AC22A	AC23A	AC22A	AC23A	AC22A	AC23A	AC22A	AC23A	
100	100	160	160	200	200	250	250	320	320	400	400	500	500	630	630	
100	100	160	160	200	200	250	250	320	320	400	400	500	500	630	630	
100	100	160	160	200	200	250	250	320	320	400	400	500	500	630	630	
100	100	160	160	200	200	250	250	320	320	400	400	500	500	630	630	
100	100	160	160	200	200	250	250	320	320	400	400	500	500	630	630	
DC22A	DC23A	DC22A	DC23A	DC22A	DC23A	DC22A	DC23A	DC22A	DC23A	DC22A	DC23A	DC22A	DC23A	DC22A	DC23A	DC23B
100	100	160	160	200	200	250	250	320	320	400	400	500	500	550	550	630
100	100	160	160	200	200	250	250	320	320	400	400	500	500	550	550	630
●		●		●		●		●		●		●		●		
Class 120 - 60 %		Class 120 - 60 %		Class 120 - 60 %		Class 120 - 60 %		Class 120 - 60 %		Class 120 - 60 %		Class 120 - 60 %		Class 120 - 60 %		
30		30		30		30		50		50		50		50		
330		330		330		330		330		330		330		330		
8500		8500		8500		8500		20000		20000		20000		20000		
4900		4900		4900		4900		11500		11500		11500		11500		
2200		2200		2200		2200		4900		4900		4900		4900		
1800		1800		1800		1800		4000		4000		4000		4000		
●		●		●		●		●		●		●		●		
15000		15000		15000		15000		10000		10000		10000		10000		
AC22A	AC23A	AC22A	AC23A	AC22A	AC23A	AC22A	AC23A	AC22A	AC23A	AC22A	AC23A	AC22A	AC23A	AC22A	AC23A	
1500	1500	1500	1500	1500	1500	1500	1500	1500	1500	1500	1500	1500	1500	1500	1500	
1500	1500	1500	1500	1500	1500	1500	1500	1500	1500	1500	1500	1500	1500	1500	1500	
1500	1500	1500	1500	1500	1500	1500	1500	1500	1500	1500	1500	1500	1500	1500	1500	
DC22A	DC23A	DC22A	DC23A	DC22A	DC23A	DC22A	DC23A	DC23A	DC23B	DC23A	DC23B	DC23A	DC23B	DC23A	DC23B	
1500	1500	1500	1500	1500	1500	1500	1500	1000	-	1000	-	1000	-	1000	200	
●		●		●		●		●		●		●		●		
-	-	-	-	-	-	-	-	-	-	-	-	-	-	-	-	
-	-	-	-	-	-	-	-	-	-	-	-	-	-	-	-	
3	3	3	3	3	3	3	3	3	3	3	3	3	3	3	3	
-	-	-	-	-	-	-	-	-	-	-	-	-	-	-	-	



TransferPacT FXM100 to 630

(Complete Source-Changeover Assembly)

FXM

Installation

Fixed, front connection

Fixed, rear connection

On symmetrical rails

On a backplate

Connection

By cables To bare cable connectors

By cables with lugs Directly to terminals

To spreaders

To vertical-connection adapters via cable-lug adapters

Flat-facing bars Directly to terminals

To spreaders

Edgewise bars To vertical-connection adapters

Indication and measurement auxiliaries

Auxiliary contacts

Voltage-presence indicator

Current-transformer module

Ammeter module

Control, locking and interlocking

Control Direct front rotary handle

Extended front rotary handle

Direct lateral rotary handle

Extended lateral rotary handle

Interlocking By keylock

Mechanical

Complete source-changeover assembly

Operating torque (Nm) (typical value for 3-4 poles with front handle)

Installation and connection accessories

Bare cable connectors

Rear connectors

Terminal extensions

Spreaders

One-piece spreader

Terminal shrouds

Terminal shields

Interphase-barrier

Front panel escutcheons

Coupling accessories(downstream, outgoing pitch for FXM100-250 is 35mm, FXM 320-630 is 45mm)

Tightening torque for electrical connections (Nm)

Dimensions and weights

Overall dimensions H x W x D (mm) 3 poles

4 poles

Approximate weight (kg) 3 poles

4 poles

MTSE/Manual Source-Changeover Systems

TransferPacT FXM

Class PC

Complete Manual Source-Changeover Assembly
TransferPacT FXM with direct rotary handle

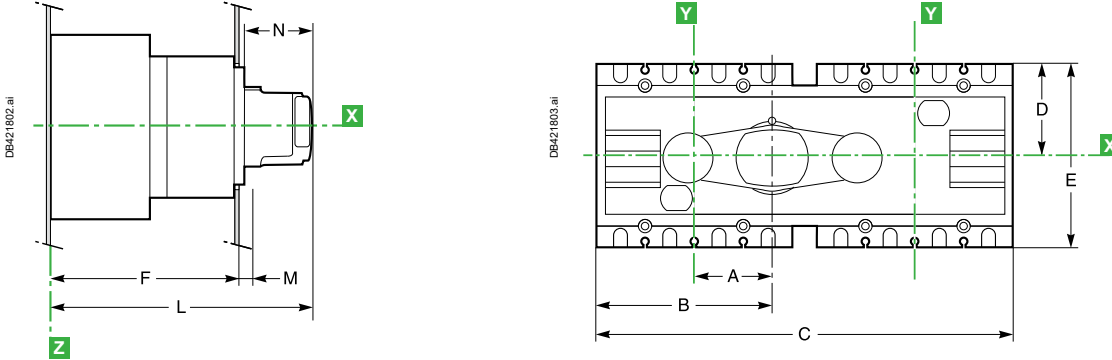

Front Panel Cutout

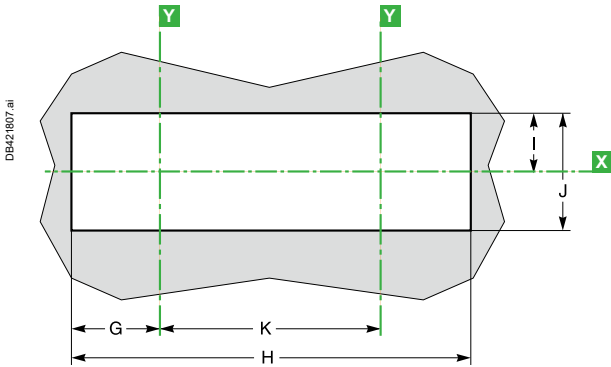

Dimensions (mm)

Type	A	B	C	D	E	F	G	H	I	J	K	L	M	N
FXM 100 to 250 A	60.4	130.4	296	68	136	131	61.8	279.3	42	84	156	186.5	5.5	50
FXM 320 to 630 A	82.5	175	395	102.5	205	155	87	383.7	64	128	210	213	8	50

TransferPacT FXM with Extended Handle

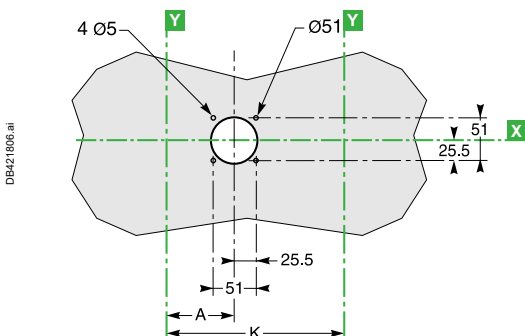
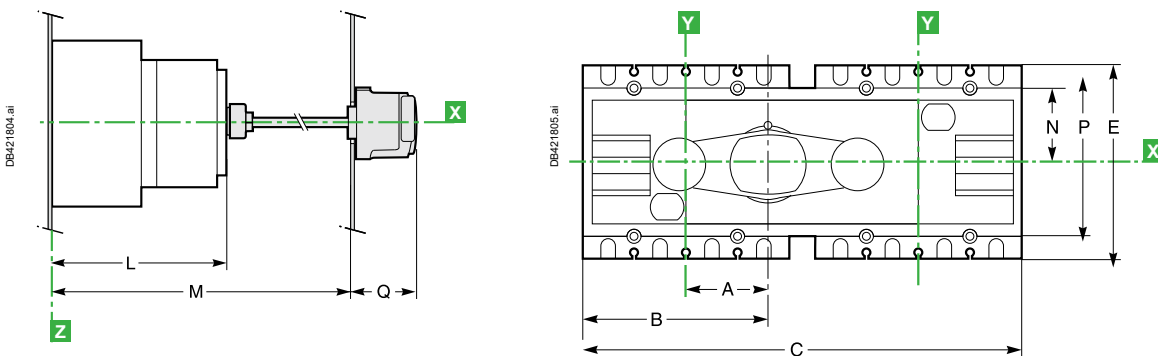

Dimensions (mm)

Type	A	B	C	E	K	L	M	N
FXM 100 to 250 A	60.4	130.4	295	136	156	138.5	631	50
FXM 320 to 630 A	82.5	175	395	205	210	162.5	658	75

Dimensions (mm)

Type	P	Mmax	Mmin	Q
FXM 100 to 250 A	100	567.5	195	64
FXM 320 to 630 A	150	593	220.5	64

Note: lines X and Y indicate the axes of symmetry of the switch-disconnector. Reference plane Z corresponds to the back of the switch-disconnector.

References of TransferPacT FXM

TransferPacT FXM (complete source-changeover assembly)

 DB40470.eps	FXM100	3P	31140	4P	31141
	FXM160		31144		31145
	FXM200		31142		31143
	FXM250		31146		31147
	FXM320		31148		31149
	FXM400		31150		31151
	FXM500		31152		31153
	FXM630		31154		31155

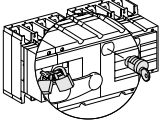
 DB10771.eps	Locking for TransferPacT FXM			
	Handle locking by 1 to 3 padlocks (in OFF position)			Built in
	By keylock	Keylocking device		31097
		+ Ronis 1351B.500 keylock or + Profalux KS5 B24 D4Z keylock		41940 42888

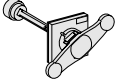
 DB40479.eps	Rotary handle			
	Extended front control for complete source changeover assembly			31055

Connection Accessories

Downstream coupling accessories

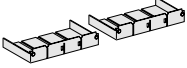
Short terminal shields (1 pair) + "Normal" source/"Replacement" source				
 DB101062.eps				3/4P
		INS250/INS250		LV429359
		INS320 to INS630/INS320 to INS630		LV432620

 DB412622.eps				

 DB403921.eps	Long terminal shields (1 piece)			
	INS250	Long terminal shield		LV429518
	INS320 to INS630	Long terminal shield, 45 mm (1 piece)		LV432594
		Long terminal shield for spreaders, 52.5 mm (1 piece)		LV432596



Order Form for Manual Source-Changeover Systems

To indicate your choices, check the applicable square boxes and enter the appropriate information in the rectangles .

Complete Source-Changeover Assembly			
INS250-100 A	<input type="checkbox"/>	INS250-160 A	<input type="checkbox"/>
INS250-200 A	<input type="checkbox"/>	INS250-250 A	<input type="checkbox"/>
INS320	<input type="checkbox"/>	INS400	<input type="checkbox"/>
INS500	<input type="checkbox"/>	INS630	<input type="checkbox"/>

ATS, RTS and MTS based on ComPacT and MasterPacT range

Manual, Remote and Automatic Transfer Switch	D-2
Switching Devices.....	D-4
TransferPacT	D-10
Mechanical Interlocking.....	D-10
TransferPacT Controllers	D-18
Manual Source-Changeover Systems	D-28
Source-Changeover Systems	D-37
Standard Configurations	D-45
Remote-Operated Source-Changeover Systems	D-47
Source-Changeover Systems with UA Controllers	D-59
Source-Changeover Systems with BA Controllers	D-61
Remote-Operated Source-Changeover Systems.....	D-62
References of Source-Changeover Systems for 2 Devices .	D-71
Order Form for Source-Changeover Systems for 2 Devices.	D-77

Manual, Remote and Automatic Transfer Switch

Schneider Electric offers source change-over systems based on ComPacT and MasterPacT devices. They are made of up to 3 circuit breakers or switch-disconnectors linked by an electrical interlocking system that may have different configurations. Moreover, a mechanical interlocking system must be added to protect against electrical malfunctions or incorrect manual operations. In addition, a controller can be used for automatically control the source transfer.

The following pages present the different solutions for mechanical and electrical interlocking and associated controllers.

M

Manual Source-Changeover System (or MTSE: Manual Transfer Switching Equipment)

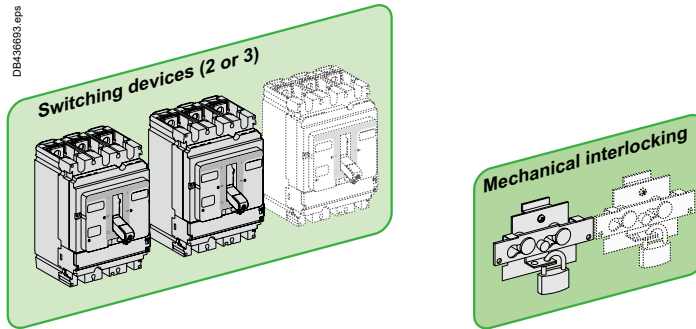

R/A

Remote-Operated Source-Changeover System (or RTSE: Remote Transfer Switching Equipment) Automatic Source-Changeover System (or ATSE: Automatic Transfer Switching Equipment)

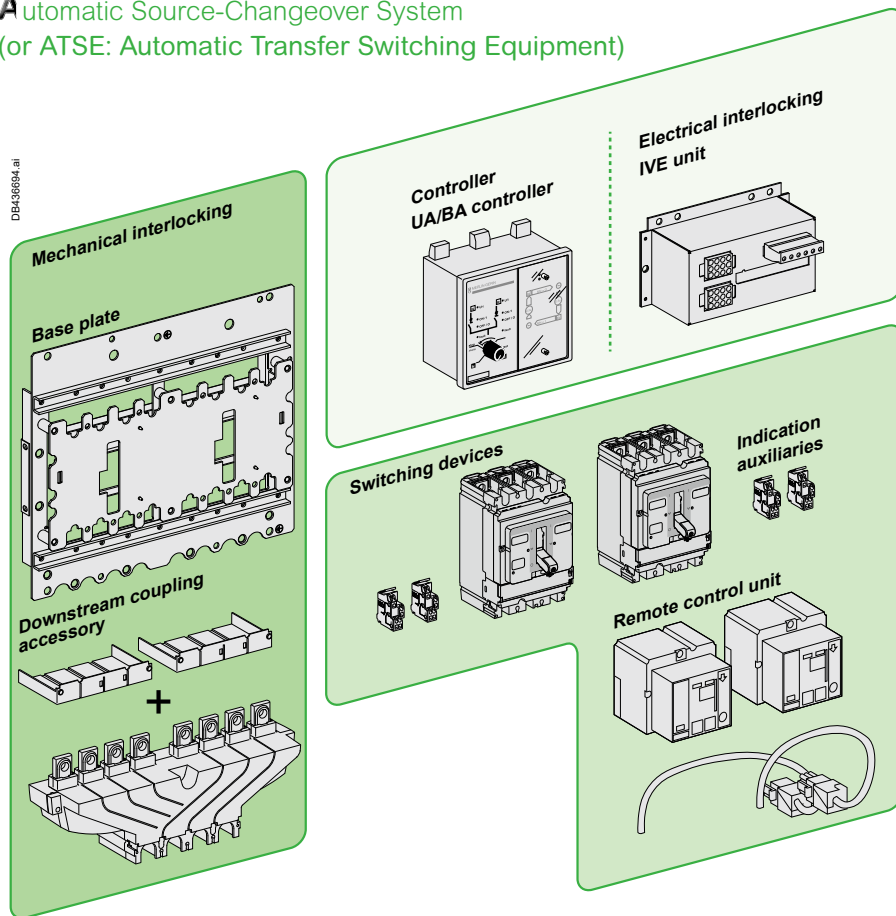

Manual, Remote and Automatic Transfer Switch

Switching Devices

	Class PC	Class CB
ComPacT INS/INV	D-4	-
ComPacT NSX	D-5	D-8
ComPacT NS	D-5	D-9
MasterPacT MTZ1	D-5	D-9
MasterPacT MTZ2/MTZ3	D-5	D-9

Mechanical Interlocking

Mechanical interlocks	D-10
Keylocks with captive keys	D-12
Cables or connecting rods	D-15

TransferPacT

Electrical Interlocking

Electrical interlocking	
IVE unit + base plate	D-16
IVE unit, Operating sequences	D-17

TransferPacT Controller

With automatic controller	
Controller selection	D-18
Controller installation	D-19
BA controller	D-20
BA controller, Operating sequences	D-21
UA controller	D-22
UA controller, Operating sequences, Forced operation mode	D-23
UA controller, Operating sequences, Special-tariff mode	D-24
UA controller, Operating sequences, Test mode and automatic operation	D-25
UA/BA controller, Operating sequences	D-26

Information

IEC 60947-6-1 applies to transfer switching equipment (TSE) to be used in power systems for transferring a load supply between a normal and an alternate source (other power supply or generator).

TSE is classified according to

- The method of controlling the transfer
 - Manually transfer switching equipment (MTSE)
 - Automatic transfer switching equipment (ATSE)
- their short circuit capability
 - Class PC: TSE that is capable of making and withstanding, but not intended for breaking short-circuit currents. Switch and switch-disconnectors are the most useful products used.

□ Class CB: TSE that is capable of making, withstanding, it's intended for breaking short-circuit currents and is provided with over-current releases. Circuit breakers (air circuit breaker or moulded-case circuit breaker) are the most useful products used.

Switching Devices

Class PC

Range	ComPacT INS	ComPacT INS/INV
Types of devices	INS40 to INS80 INS100 to INS160	INS250 to INS630 INV100 to INV630
Mixing possibilities	All devices, not possible with a complete assembly source-changeover	All devices, not possible with a complete assembly source-changeover
Electrical characteristics		
Current rating	40 to 160 A	100 to 630 A
Insulating voltage U_i (V AC)	750	800
Rated operational voltage		
Positive break indication	■	■
Number of poles (N and R devices must have the same number of poles)	3, 4	3, 4
Operating temperature	-25 °C and +70 °C	-25 °C and +70 °C
Additional indication and control auxiliaries		
Indication contacts	OF	OF
Voltage releases		
MX shunt		
MN undervoltage		
Voltage presence indicator	■	■
Voltage transformer		
Ammeter module	■	■
Insulation monitoring module		
Installation and connection		
Fixed front connected	■	■
Fixed rear connected	■	■
Withdrawable, plug-in or drawout		
Installation and connection accessories		
Downstream coupling accessory		■
Bare-cable connectors	■	■
Terminal extensions	■	■
Terminal shields and inter-phase barriers	■	■
Front panel escutcheons		■
Locking		
by padlock	■	■
by keylock	■	■

Switching Devices

Class PC

Range	ComPacT NSX		ComPacT NS	MasterPacT	
Types of devices	NSX100 to NSX250	NSX400 to NSX630	NS630b to NS1600	MTZ1 06 to 16	MTZ2 08 to 40 MTZ3 40 to 63
Mixing possibilities	all devices	all devices	all devices	all mixing possibilities	all mixing possibilities
	NSX100NA to NSX250NA	NSX100NA to NSX630NA	NS630bNA to NSX1600NA	(fixed, drawout or fixed + drawout) HA	(fixed, drawout or fixed + drawout) NA/HA/HA10
	fixed/fixed or plug-in/plug-in	fixed/fixed or plug-in/plug-in	fixed/fixed or plug-in/plug-in		
Electrical characteristics					
Current rating	15 to 250 A	15 to 630 A	250 to 1600 A	600 to 1600 A	800 to 6300 A
Insulating voltage U_i (V AC)	750	750	750	1000	1000
Rated operational voltage					
Positive break indication	■	■		■	■
Number of poles (N and R devices must have the same number of poles)	3, 4	3, 4	3, 4	3, 4	3, 4
Operating temperature	-25 °C to +70 °C (50 °C for 440 V - 60 Hz)		-25 °C to +70 °C (50 °C for 440 V - 60 Hz)	-25 °C to +70 °C	
Control characteristics					
Control voltage	AC	48 V - 50 Hz 110/130, 220/240, 380/440 V - 50/60 Hz	48 V - 50 Hz 110/130, 220/240, 380/440 V - 50/60 Hz	48 to 415 V - 50/60 Hz 440 V - 60 Hz	
	DC	24-250 V	24-250 V	24-250 V	24-250 V
Maximum consumption	AC	500 VA	500 VA	180 VA	180 VA
	DC	500 W	500 W	180 W	180 W
Minimum switching time		800 ms	800 ms	800 ms	800 ms
Protection and measurement					
Earth-leakage protection	by Vigi module	■	■		
	by control unit			■	■
	by add-on VigiPact relay	■	■	■	■
Current measurements			■	■	■
Voltage, frequency, power measurements, etc.				■	■
Additional indication and control auxiliaries					
Indication contacts	OF + SDE (+ SDV)	3 OF + SDE (+ SDV)	2 OF + SDE	2 OF + SDE	2 OF + SDE
Voltage releases	MX shunt	■	■	■	■
	MN undervoltage	■	■	■	■
Voltage presence indicator		■			
Voltage transformer		■			
Ammeter module		■			
Insulation monitoring module		■			
Installation and connection					
Fixed front connected				■	■
Fixed rear connected	■ (long rear connections)	■ (long rear connections)	■ (vertical or horizontal)	■ (vertical or horizontal)	■ (vertical or horizontal)
Withdrawable, plug-in or drawout	■ (plug-in on base)	■ (plug-in on base)	■ (drawout)	■ (drawout)	■ (drawout)
Installation and connection accessories					
Downstream coupling accessory	■	■			
Bare-cable connectors	■	■	■		
Terminal extensions	■	■			
Terminal shields and inter-phase barriers		■	■		
Front panel escutcheons	■	■	■	■	■
Locking	by padlock	■	■	■	■
	by keylock	■	■	■	■

Switching Devices

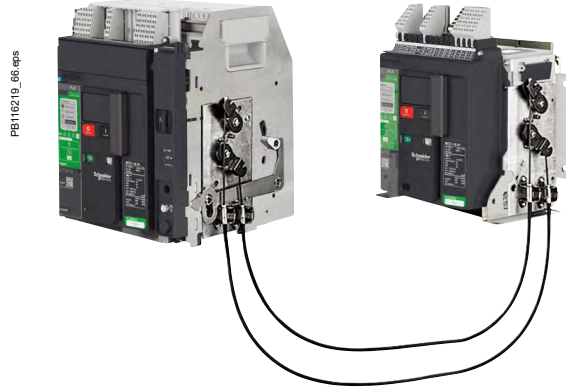
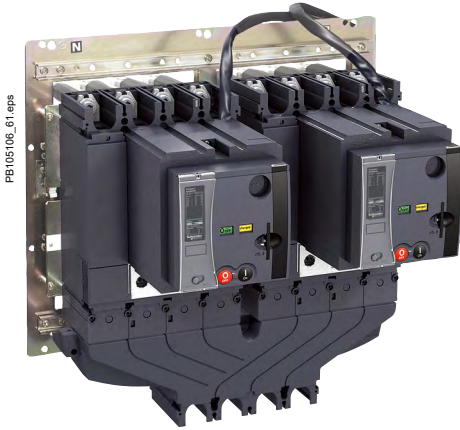

ComPacT NSX and ComPacT NS class PC and CB	NSX100 to 250		NSX400 to NSX630		NS630b to NS1600	
Number of poles	3, 4		3, 4		3, 4	
Rated current In (A)	100 to 250		400 to 630		630 to 1600	
Mechanical durability (O _N -C _R -O _R -C _N cycles)	20000 - 40000 - 50000		15000		8000	
Electrical durability at In (O _N -C _R -O _R -C _N cycles) for ≤ 440 V and 480 V NEMA ^[2]	10000 - 20000 - 30000		4000 - 6000		2000	
Electrical durability at In (O _N -C _R -O _R -C _N cycles) for U = 500 V to 690 V ^[2]	5000 - 7500 - 10000		2000 - 3000		1500	
MasterPacT class PC and CB	MTZ1 06 to 10	MTZ1 12 to 16	MTZ2 08 to 16	MTZ2 20	MTZ2 25 to 40	MTZ3 40 to 63
Number of poles	3, 4	3, 4	3, 4	3, 4	3, 4	3, 4
Rated current In (A)	630 to 1600	1250 to 1600	800 to 1600	2000	2500 to 4000	4000 to 6300
Mechanical durability ^[1] (O _N -C _R -O _R -C _N cycles)	8000	8000	10000	10000	10000	5000
Electrical durability at In (O _N -C _R -O _R -C _N cycles) ^[1] for ≤ 440 V and 480 V NEMA ^[2]	6000	6000 MTZ1 16: 3000	10000	8000	5000	1500
Electrical durability at In (O _N -C _R -O _R -C _N cycles) ^[1] for U = 500 V to 690 V ^[2]	3000	2000 MTZ1 16: 1000	10000	6000	2500	1500

[1] Mechanical and electrical durability not applicable to MasterPacT H3 and L versions.

[2] Electrical durability tests carried out with a power factor of 0.8 as per IEC 947-2.

Note:

- ON: opening of N source
- CR: closing of R source
- OR: opening of R source
- CN: closing of N source



Switching Devices

Class CB

Range		ComPacT NSX	
Types of devices		NSX100 to NSX250	NSX400 to NSX630
Mixing possibilities		all devices NSX100 to NSX250 N/H/L fixed/fixed or plug-in/plug-in	all devices NSX100 to NSX630 N/H/L fixed/fixed or plug-in/plug-in
Electrical characteristics			
Current rating		15 to 250 A	15 to 630 A
Insulating voltage U_i (V AC)		750	750
Rated operational voltage			
Positive break indication		■	■
Number of poles (N and R devices must have the same number of poles)		3, 4	3, 4
Operating temperature		-25 °C to +70 °C (50 °C for 440 V - 60 Hz)	
Motor mechanism			
Control voltage	AC	48 V - 50 Hz 110/130, 220/240, 380/440 V - 50/60 Hz	48 V - 50 Hz 110/130, 220/240, 380/440 V - 50/60 Hz
	DC	24-250 V	24-250 V
Maximum consumption	AC	500 VA	500 VA
	DC	500 W	500 W
Minimum switching time		800 ms	800 ms
Protection and measurement			
Earth-leakage protection	by Vigi module	■	■
	by control unit		
	by add-on VigiPact relay	■	■
Current measurements			
Voltage, frequency, power measurements, etc.			
Additional indication and control auxiliaries			
Indication contacts		OF + SDE (+ SDV)	3 OF + SDE (+ SDV)
Voltage releases	MX shunt	■	■
	MN undervoltage	■	■
Voltage presence indicator		■	■
Voltage transformer		■	■
Ammeter module		■	■
Insulation monitoring module		■	■
Installation and connection			
Fixed front connected			
Fixed rear connected		■ (long rear connections)	■ (long rear connections)
Withdrawable, plug-in or drawout		■ (plug-in on base)	■ (plug-in on base)
Installation and connection accessories			
Downstream coupling accessory		■	■
Bare-cable connectors		■	■
Terminal extensions		■	■
Terminal shields and inter-phase barriers		■	■
Front panel escutcheons		■	■
Locking	by padlock	■	■
	by keylock	■	■
ComPacT NSX			
		NSX100-250	NSX400 to NSX630
Rated current I_n (A)		100 to 250	400 to 630
Mechanical durability ($O_N-C_R-O_R-C_N$ cycles) ^[1]		20000 - 40000 - 50000	15000
Electrical durability at I_n ($O_N-C_R-O_R-C_N$ cycles) ^[1] for ≤ 440 V and 480 V NEMA ^[2]		10000 - 20000 - 30000	4000 - 6000
Electrical durability at I_n ($O_N-C_R-O_R-C_N$ cycles) ^[1] for $U = 500$ V to 690 V ^[2]		5000 - 7500 - 10000	2000 - 3000

[1] Mechanical and electrical durability not applicable to MasterPacT H3 and L1 versions, please refer to the MasterPacT NT/NW catalog.

[2] Electrical durability tests carried out with a power factor of 0.8 as per IEC 947-2.

Note:

ON: opening of N source
 CR: closing of R source
 OR: opening of R source
 CN: closing of N source

Switching Devices

Class CB

ComPacT NS	MasterPacT MTZ1		MasterPacT MTZ2/MTZ3				
NS630b to NS1600 all devices NS630b to 1600 N/H/L fixed/fixed or plug-in/plug-in	MTZ1 06 to 16 all mixing possibilities (fixed, drawout or fixed + drawout) H1/H2/H3/L1		MTZ2 08 to 40 and MTZ3 40 to 63 all mixing possibilities (fixed, drawout or fixed + drawout) N1/H1/H2/H3/L1/H10 for MTZ2 H1/H2 for MTZ3				
250 to 1600 A 750	600 to 1600 A 1000		800 to 6300 A 1000				
3, 4	3, 4		3, 4				
	-25 °C to +70 °C						
24-250 V 180 VA 180 W 800 ms	48 to 415 V - 50/60 Hz 440 V - 60 Hz 24-250 V 180 VA 180 W 800 ms		48 to 415 V - 50/60 Hz 440 V - 60 Hz 24-250 V 180 VA 180 W 800 ms				
■	■		■				
■	■		■				
■	■		■				
2 OF + SDE ■	2 OF + SDE ■		2 OF + SDE ■				
■	■		■				
■ (vertical or horizontal) ■ (drawout)	■ (vertical or horizontal) ■ (drawout)		■ (vertical or horizontal) ■ (drawout)				
■	■		■				
■	■		■				
■	■		■				
■	■		■				
ComPacT NS	MasterPacT MTZ1/MTZ2/MTZ3						
NS630b to NS1600	MTZ1 06 to 10	MTZ1 12 to 16	MTZ2 08 to 16	MTZ2 20	MTZ2 25 to 40	MTZ3 40 to 63	
630 to 1600	630 to 1600	1250 to 1600	800 to 1600	2000	2500 to 4000	4000 to 6300	
8000	8000	8000	10000	10000	10000	5000	
2000	6000	6000	10000	8000	5000	1500	
1500	3000	3000	10000	6000	2500	1500	



TransferPacT

Mechanical Interlocking

Range	ComPact		ComPact
Models	INS40 to INS80 INS100 to INS160	INS250 to INS630 INV250 to INV630	NSX100 to NSX250 NSX400 to NSX630
Current rating (A)	40 to 160	100 to 630	100 to 630
Type of device	Class PC	Class PC	Class PC and Class CB

Interlocking by toggles

M

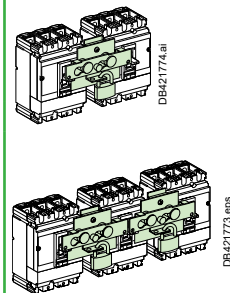

Interlocking by rotary handles

M

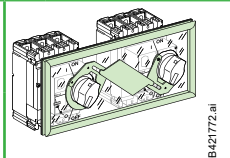
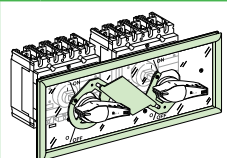
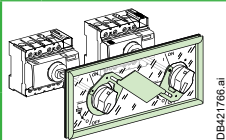

Interlocking by keylocks with captive keys

M

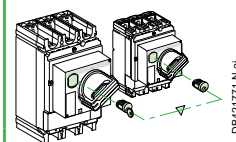
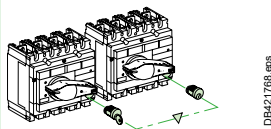

Interlocking by a base plate

A

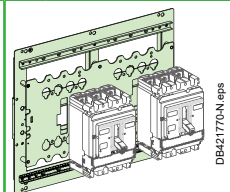

TransferPacT

Mechanical Interlocking

Range	ComPacT	MasterPacT	
Models	NS630b to NS1600	MTZ1 06 to 16	MTZ2 08 to 40 and MTZ3 40 to 63
Current rating (A)	630b to 1600	630 to 1600	800 to 6300
Type of device	Class PC and Class CB	Class PC and Class CB	Class PC and Class CB

Interlocking by extended rotary handles



Interlocking via device keylocks by captive keys

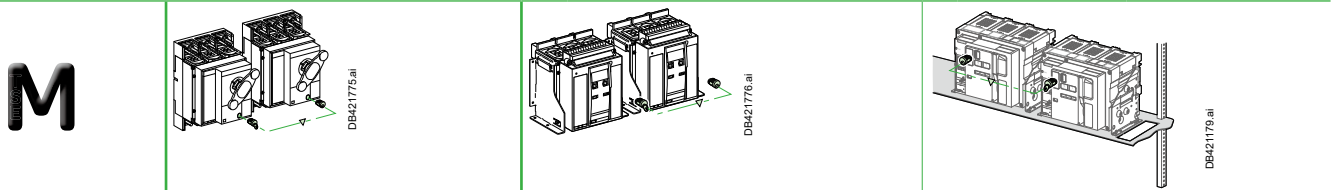

Mechanical interlocking using connecting rods

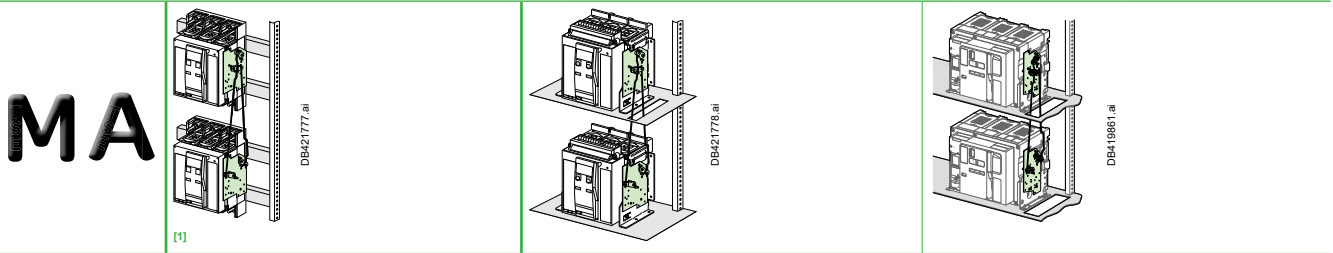

Mechanical interlocking by cables

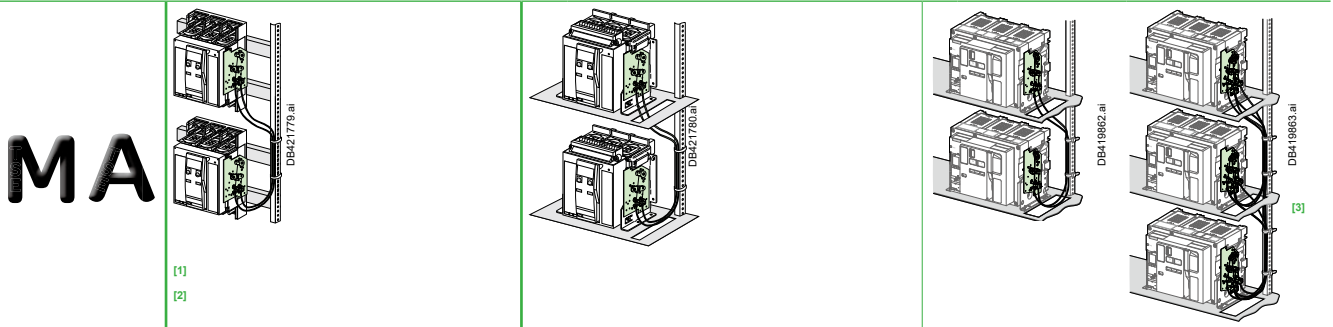

Mechanical interlocking by cables

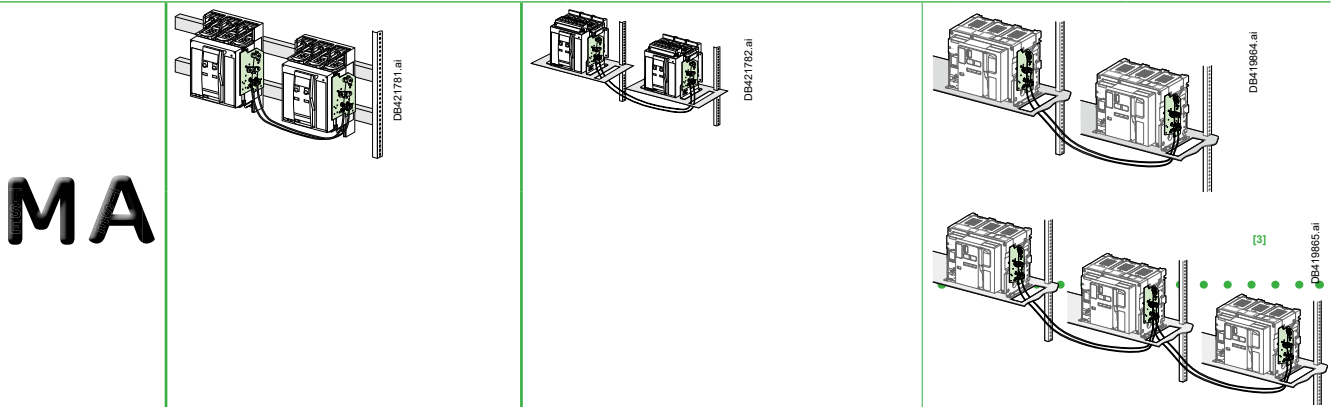

[1] Implemented with NS630b to NS1600 electrically-operated devices only.
 [2] For source-changeover systems using cables, always respect the installation conditions specified on.
 [3] Not compatible with automatic controller.

Note: for other cases, please consult us.



TransferPacT

Mechanical Interlocking



PE113435.eps

Interlocking of two or three toggle-controlled devices.



PE113415-N.eps

Interlocking of two devices by rotary handles.



PE113829.eps

Interlocking with keylocks.

Interlocking of Two or Three Toggle-Controlled Devices

Interlocking system

Two devices can be interlocked using this system. Two identical interlocking systems can be used to interlock three devices installed side by side.

Authorized positions:

- one device closed (ON), the others open (OFF)
- all devices open (OFF).

The system is locked using one or two padlocks (Ø5 to 8 mm).

This system can be expanded to more than three devices.

There are two interlocking-system models:

- one for ComPacT INS/INV
- one for ComPacT NSX100 to NSX250
- one for ComPacT NSX400 to NSX630.

Combinations of Normal and Replacement devices

All toggle-controlled fixed or plug-in ComPacT NSX100 to NSX630 circuit breakers and switch-disconnectors of the same frame size can be interlocked. The devices must be either all fixed or all plug-in versions.

Interlocking of Two Devices By Rotary Handles

Interlocking system

Interlocking involves padlocking the rotary handles on two devices which may be either circuit breakers or switch-disconnectors.

Authorized positions:

- one device closed (ON), the other open (OFF)
- both devices open (OFF).

The system is locked using up to three padlocks (Ø5 to 8 mm).

There are two interlocking-system models:

- one for ComPacT INS/INV
- one for ComPacT NSX100 to NSX250
- one for ComPacT NSX400 to NSX630.

Combinations of Normal and Replacement devices

All rotary-handle fixed or plug-in ComPacT NSX100 to NSX630 circuit breakers and switch-disconnectors of the same frame size can be interlocked. The devices must be either all fixed or all plug-in versions.

Interlocking of Devices by Keylocks (Captive Keys)

Interlocking using keylocks is very simple and makes it possible to interlock two or more devices that are physically distant or that have very different characteristics, for example medium-voltage and low-voltage devices or a ComPacT NSX100 to NSX630 switch-disconnector and circuit breaker.

Interlocking system

Each device is equipped with an identical keylock and the key is captive on the closed (ON) device. A single key is available for all devices. It is necessary to first open (OFF position) the device with the key before the key can be withdrawn and used to close another device.

A system of wall-mounted captive key boxes makes a large number of combinations possible between many devices.

Combinations of Normal and Replacement devices

All rotary-handle ComPacT NSX100 to NSX630 circuit breakers and switch-disconnectors can be interlocked between each other or with any other device equipped with the same type of keylock.

TransferPacT

Mechanical Interlocking

Interlocking of Two Devices by Base Plate

Interlocking system

A base plate designed for two ComPacT NSX devices can be installed horizontally or vertically on a mounting rail. Interlocking is carried out on the base plate by a mechanism located behind the devices. In this way, access to the device controls and trip units is not blocked.

Combinations of Normal and Replacement devices

All rotary-handle and toggle-controlled ComPacT NSX100 to NSX630 circuit breakers and switch-disconnectors can be interlocked. Devices must be either all fixed or all plug-in versions, with or without earth-leakage protection or measurement modules.

An adaptation kit is required to interlock:

- two plug-in devices
- a ComPacT NSX100 to NSX250 with an NSX400 to NSX630.

Connection to the downstream installation can be made easier using a coupling accessory.

Downstream coupling accessory

This accessory simplifies connection to bars and cables with lugs. It may be used to couple two switch-disconnectors and circuit breakers of the same size, ComPacT INS/INV100 to 630 and ComPacT NSX100 to 630.

Pitch between outgoing terminals:

- ComPacT INS250 and INV100 to 250: 35 mm
- ComPacT INS/INV320 to INS/INV630: 45 mm
- ComPacT NSX100 to NSX250: 35 mm
- ComPacT NSX400 to NSX630: 45 mm.

For ComPacT NSX circuit breakers, the downstream coupling accessory can be used only with **fixed versions**.

Connection and Insulation Accessories

The coupling accessory can be fitted with the same connection and insulation accessories as the circuit breakers and switch-disconnectors.

Possible uses	Downstream coupling	
	Possible mounting	Outgoing pitch (mm)
Manual source-changeover systems		
INS250 (100 to 250 A) with rotary handle	■	35
NSX100 to NSX250 with rotary handle	■	35
NSX100 to NSX250 on base plate with toggle control	■	35
INS400 to INS630 (320 to 630 A) with rotary handle	■	45
NSX400 to NSX630 with rotary handle	■	45
NSX400 to NSX630 on base plate with toggle control	■	45



Interlocking on a base plate.

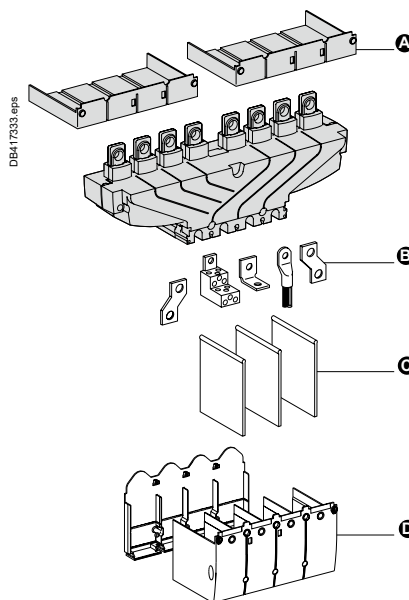

- A** Short terminal shields
- B** Terminals
- C** Interphase barriers
- D** Long terminal shields



TransferPacT

Mechanical Interlocking

For implementing the mechanical interlocking, two different possibilities are offered:

- interlocking with rods
- interlocking with cables.

Note: for mechanical interlocking application with connecting rods and cables, pushbutton cover is mandatory to prevent wrong mechanical close order.

Commercial references for pushbutton cover:

- MasterPacT MTZ1 : LV833897
- MasterPacT MTZ2 and MTZ3 : LV848536
- ComPacT NS630b to 1600: 33897

Interlocking with Rods

Interlocking of Two ComPacT NS630b to 1600 Devices Using Connecting Rods

Both devices must be installed one above the other.

For ComPacT NS, only associations between similar type devices are allowed (2 fixed or 2 drawout devices).

Installation

This function requires:

- an adaptation fixture on the right side of each circuit breaker or switch-disconnector
- a set of connecting rods with no-slip adjustments.

The adaptation fixtures, connecting rods and circuit breakers or switch-disconnectors are supplied separately, ready for assembly.

The maximum vertical distance between the fixing plates is 900 mm.

Possible combinations of "S1" and "S2" source circuit breakers

Combinations are possible between ComPacT NS devices with MasterPacT MTZ1 devices (either 2 fixed or 2 withdrawable/drawout devices).

Interlocking of Two MasterPacT MTZ Using Connecting Rods

Both devices must be installed one above the other.

For MasterPacT MTZ1 only associations between similar type devices are allowed (2 fixed or 2 drawout devices).

For MasterPacT MTZ2 and MTZ3, all mixed associations between fixed type and drawout type devices are possible.

PB110491_R_34.eps

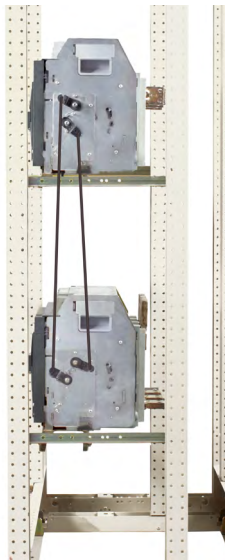

Interlocking of two MasterPacT MTZ1, MTZ2/MTZ3 circuit breakers using connecting rods.

	Source 2							
	Fixed				Drawout			
Source 1	NS630b to NS1600	MTZ1	MTZ2	MTZ3	NS630b to NS1600	MTZ1	MTZ2	MTZ3
Fixed								
NS630b to NS1600	●	●						
MTZ1	●	●						
MTZ2			●	●			●	●
MTZ3			●	●			●	●
Drawout								
NS630b to NS1600					●	●		
MTZ1					●	●		
MTZ2			●	●			●	●
MTZ3			●	●			●	●

Installation

This function requires:

- an adaptation fixture on the right side of each circuit breaker or switch-disconnector
- a set of connecting rods with no-slip adjustments
- a mechanical operation counter CDM (mandatory).

The adaptation fixtures, connecting rods, circuit breakers and switch-disconnectors are supplied separately, ready for assembly.

The maximum vertical distance between the fixing plates is 900 mm.

TransferPacT

Mechanical Interlocking

Interlocking with Cables

Interlocking of Two ComPacT NS630b to 1600 Devices Using Cables

For cable interlocking, the circuit breakers may be mounted one above the other or side-by-side.

The interlocked devices may be fixed or drawout, three-pole or four-pole, and have different ratings and sizes.

Installation

This function requires:

- an adaptation fixture on the right side of each device
- a set of cables with no-slip adjustments.

The maximum distance between the fixing plates (vertical or horizontal) is 2000 mm.

Possible combinations of “S1” and “S2” source circuit breakers

All mixed associations between ComPacT NS 630b to 1600 and MasterPacT MTZ1 or MTZ2 or MTZ3 fixed type and drawout type devices are possible.

Interlocking of Two or Three MasterPacT MTZ Using Cables

For cable interlocking, the circuit breakers can be installed either one above the other or side-by-side. All mixed associations between MasterPacT MTZ1, MTZ2, MTZ3 fixed type and drawout type devices are possible.

Note: mechanical interlocking for 3 devices is only possible with MTZ2 and MTZ3.

Interlocking between two MasterPacT MTZ1, MTZ2, MTZ3 devices

This function requires:

- an adaptation fixture on the right side of each device
- a set of cables without slip adjustments
- a mechanical operation counter CDM (mandatory).

The maximum distance between the fixing plates (vertical or horizontal) is 2000 mm.

Interlocking between three MasterPacT MTZ2, MTZ3 devices

This function requires:

- a specific adaptation fixture installed on the right side of each device
- two sets of cables without slip adjustments
- a mechanical operation counter CDM (mandatory).

The maximum distance between the fixing plates (vertical or horizontal) is 1000 mm.

Installation

The adaptation fixtures, sets of cables and circuit breakers or switch-disconnectors are supplied separately, ready for assembly.

Installation conditions for cable interlocking systems:

- cable length: 2.5 m
- cable bending radius: greater than 100 mm
- maximum number of curves: 3.

Note: for cable length higher than 2.5 m please consult us before ordering the circuit breakers for a customized solution.

Choice Criteria

In applications where the continuity of service is critical^[1] (data centers, airports, hospitals, marine, oil&gas, process industry, etc.), mechanical interlocking by rods and drawout devices are strongly recommended.

Mechanical interlocking by rods is preferred as less energy is consumed by friction, so it has less effect on the circuit breaker closing energy.

In terms of breaker mounting type, the drawout version is preferred as :

- it provides mechanical isolation of the circuit breaker from possible external stress on the terminals by having a flexible connection at cluster level
- it allows simple and total access for periodic maintenance
- it allows quick replacement of the device if necessary.

When not possible, cable interlocking or fixed versions can be used, but the installation rules detailed in the 2 sections below must be strictly respected and mainly:

- the busbars or the cables used for power connection must apply no stress on the circuit breaker terminals.

Their weight must be supported by the switchboard frame.

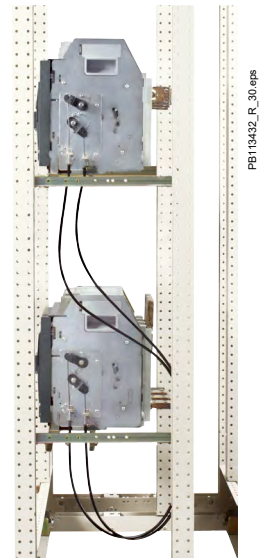

Interlocking of two MasterPacT circuit breakers using cables.

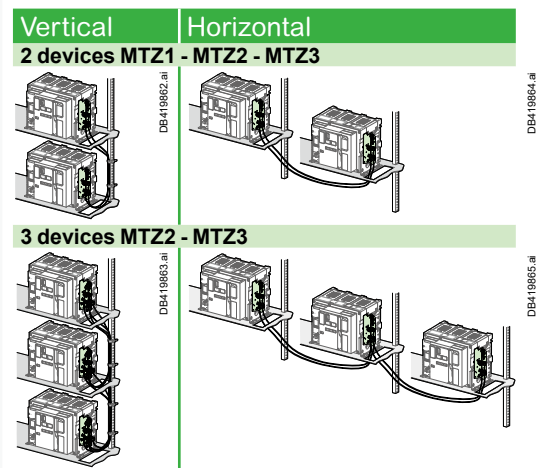

[1] For more details please contact your local support.

Note: for more details on installation rules, please also refer to “MasterPacT MTZ User Guide”.

TransferPacT

Electrical Interlocking - IVE unit

Electrical interlocking is used with a mechanical interlocking system. Moreover, the relays controlling the closing order to the “N” and “R” circuit breakers must be mechanically and/or electrically interlocked to prevent them from giving simultaneous closing commands.

Electrical interlocking is carried out by an electrical control device.

For ComPacT NSX up to 630 A, electrical interlocking is implemented by the IVE unit integrating control circuits and an external terminal block in accordance with the page D-47 of the chapter “Electric diagrams” of this catalog.

The integrated control circuits implement the time delays required for correct source transfer.

For ComPacT NS630b to NS1600 and MasterPacT, this function can be implemented in one of two ways:

- Using the IVE unit
- By an electrician based on the diagrams in accordance with the pages D-61 to D-70 of the chapter “Electric diagrams” of this catalog.

Characteristics of the IVE unit

- External connection terminal block:
 - Inputs: circuit breaker control signals
 - Outputs: status of the SDE contacts on the “N” and “R” source circuit breakers.
- 2 connectors for the two “N” and “R” source circuit breakers:
 - Inputs:
 - Status of the OF contacts on each circuit breaker (ON or OFF)
 - Status of the SDE contacts on the “N” and “R” source circuit breakers
 - Outputs: power supply for operating mechanisms.
- Control voltage:
 - 24 to 250 V DC
 - 48 to 415 V 50/60 Hz - 440 V 60 Hz.

The IVE unit control voltage must be same as that of the circuit breaker operating mechanisms.



IVE unit.

IVE Unit

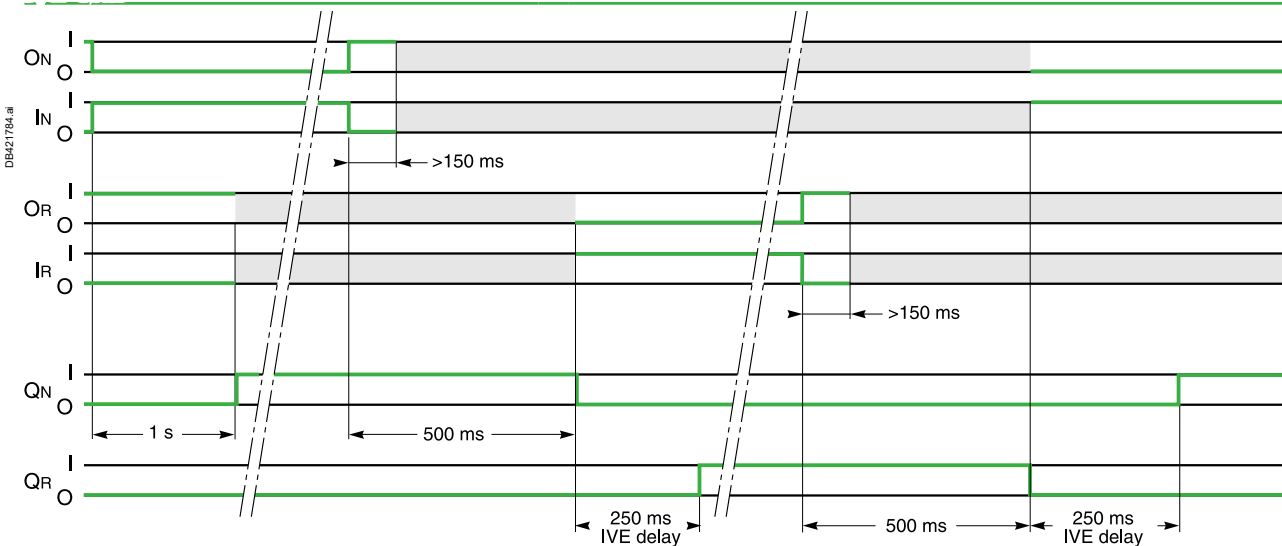

Symbols

- | | |
|---|---|
| QN: “Normal” ComPacT circuit breaker equipped for remote operation (motor mechanism) | IN: Circuit breaker QN closing order |
| QR: “Replacement” ComPacT circuit breaker equipped for remote operation (motor mechanism) | IR: Circuit breaker QR closing order |
| ON: Circuit breaker QN opening order | L1: Faulty “Normal” indication LED |
| OR: Circuit breaker QR opening order | L2: Faulty “Replacement” indication LED |

Key

- O: OFF (circuit open)
- I: ON (circuit closed)
- : either ON or OFF.

Note: following all trips (overload, short-circuit, earth-leakage fault, voluntary trip), a manual reset on the front of the motor mechanism is required.

TransferPacT

Electrical Interlocking - IVE unit

Necessary Equipment

For ComPacT NSX100 to NSX630, each circuit breaker must be equipped with:

- A motor mechanism
- An OF contact
- An SDE contact

The components are supplied ready for assembly and the circuit breakers prewired. The prewiring must not be modified.

For ComPacT NS630b to NS1600, each circuit breaker must be equipped with:

- A motor mechanism
- An available OF contact
- A CE connected-position contact (carriage switch) on withdrawable circuit breakers
- An SDE contact

For MasterPacT MTZ, each circuit breaker must be equipped with:

- A remote-operation system made up of:
 - MCH gear motor
 - MX or MN opening release
 - XF closing release
 - PF "ready to close" contact
- CDM mechanical operation counter (mandatory)
- An available OF contact
- One to three CE connected-position contacts (carriage switches) on drawout circuit breakers (depending on the installation).

DB423006.ai

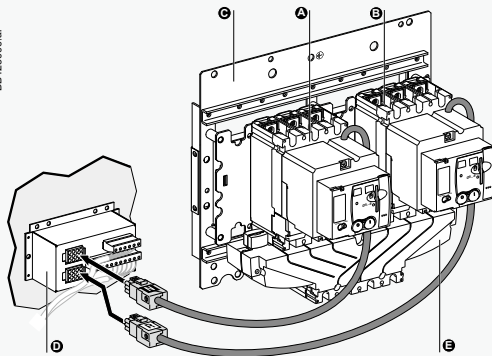

ComPacT NSX

- A** Circuit breaker QS1 equipped with a motor mechanism and auxiliary contacts, connected to the N source
- B** Circuit breaker QS2 equipped with a motor mechanism and auxiliary contacts, connected to the R source
- C** Base plate with mechanical interlocking
- D** Electrical interlocking unit IVE
- E** Coupling accessory (downstream connection)

DB423007.ai

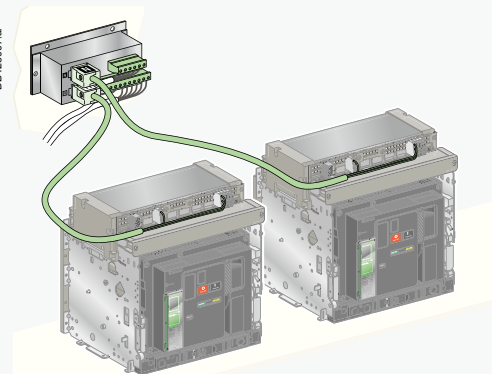

MasterPacT MTZ

D

TransferPacT Controllers

Controller Selection

By combining a remote-operated source-changeover system with an integrated BA or UA automatic controller, it is possible to automatically control source transfer according to user-selected sequences. These controllers can be used on source-changeover systems comprising 2 circuit breakers. For source-changeover systems comprising 3 circuit breakers, the automatic control diagram must be prepared by the installer as a complement to diagrams provided in the “electrical diagrams” section of this catalog.



BA controller.



UA controller.

Controller		BA	UA				
Compatible circuit breakers		All ComPact NS, ComPact NSX and MasterPacT circuit breakers					
4-position switch							
Automatic operation		●	●				
Forced operation on “Normal” source		●	●				
Forced operation on “Replacement” source		●	●				
Stop (both “Normal” and “Replacement” sources off)		●	●				
Automatic operation							
Monitoring of the “Normal” source and automatic transfer		●	●				
Generator set startup control			●				
Delayed shutdown (adjustable) of generator set			●				
Load shedding and reconnection of non-priority circuits			●				
Transfer to the “Replacement” source if one of the phases of the “Normal” phase is absent			●				
Test							
By opening the P25M circuit breaker supplying the controller		●					
By pressing the test button on the front of the controller			●				
Indications							
Circuit breaker status indication on the front of the controller: on, off, fault trip		●	●				
Automatic mode indicating contact		●	●				
Other functions							
Selection of type of “Normal” source: single-phase or three-phase (for example, 220 V single-phase or 220 V three-phase)			●				
Voluntary transfer to “Replacement” source (e.g. energy management commands)		●	●				
During peak-tariff periods (energy management commands) forced operation on “Normal” source if “Replacement” source not operational			●				
Additional contact (not part of controller). Transfer to “Replacement” source only if contact is closed (e.g. used to test the frequency of UR).		●	●				
Setting of maximum startup time for the replacement source			●				
Power supply							
Control voltages ^[1]	110 V	●	●				
	220 to 240 V 50/60 Hz	●	●				
	380 to 415 V 50/60 Hz and 440 V 60 Hz	●	●				
Operating thresholds							
Undervoltage	0.35 Un ≤ voltage ≤ 0.7 Un	●	●				
Phase failure	0.5 Un ≤ voltage ≤ 0.7 Un		●				
Voltage presence	voltage ≥ 0.85 Un	●	●				
IP degree of protection (EN 60529) and IK degree of protection against external mechanical impacts (EN 50102)							
Front	IP40	●	●				
Side	IP30	●	●				
Connectors	IP20	●	●				
Front	IK07	●	●				
Characteristics of output contacts (dry, volt-free contacts)							
Rated thermal current (A)	8						
Minimum load	10 mA at 12 V						
Output contacts:	Position of the Auto/Stop switch	●	●				
	Load shedding and reconnection order		●				
	Generator set start order.		●				
Utilisation category (IEC 947-5-1)		AC				DC	
		AC12	AC13	AC14	AC15	DC12	DC13
Operational current (A)	24 V	8	7	5	5	8	2
	48 V	8	7	5	5	2	-
	110 V	8	6	4	4	0.6	-
	220/240 V	8	6	4	3	-	-
	250 V	-	-	-	-	0.4	-
	380/415 V	5	-	-	-	-	-
	440 V	4	-	-	-	-	-
660/690 V	-	-	-	-	-	-	

[1] The controller is powered by the ACP control plate. The same voltage must be used for the ACP plate, the IVE unit and the circuit breaker operating mechanisms. If this voltage is the same as the source voltage, then the “Normal” and “Replacement” sources can be used directly for the power supply. If not, an isolation transformer must be used.

TransferPacT Controllers

Controller Installation

TransferPacT ACP Control Plate

The control plate provides in a single unit:

- protection for the BA or UA controller with two highly limiting P25M circuit breakers (infinite breaking capacity) for power drawn from the AC source
- control of circuit breaker ON and OFF functions via two relay contactors
- connection of the circuit breakers to the BA or UA controller via a built-in terminal block.

Control voltages

- 110 V 50/60 Hz.
- 220 to 240 V 50/60 Hz.
- 380 to 415 V 50/60 Hz and 440 V 60 Hz.

The same voltage must be used for the TransferPacT ACP control plate, the controller and the circuit breaker operating mechanisms.

Installation

Connection between the TransferPacT ACP control plate and the IVE unit may use:

- wiring done by the installer
- prefabricated wiring (optional).

Installation of the BA and UA Controllers

The BA and UA controllers may be installed in one of two manners:

- directly mounted on the TransferPacT ACP control plate
 - mounted on the front panel of the switchboard
- if the length of the connection between the controller and the control plate (ACP) is less than or equivalent to 1 m, the connecting cable **ref. 29368** can be ordered as an optional extra. Cables longer than 1 m, but not longer than 2 m will be the responsibility of the installer.



TransferPacT ACP control plate.

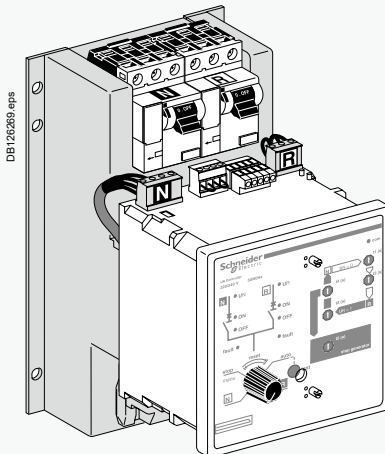

Mounting on the TransferPacT ACP control plate.

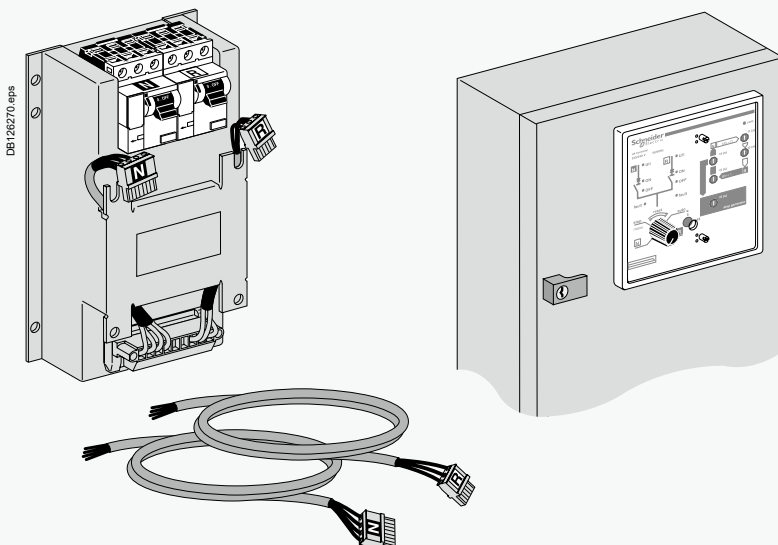

Mounting on the front panel of the switchboard.

TransferPacT Controllers

BA Controller

The BA controller is used to create simple source-changeover systems that switch from one source to another depending on the presence of voltage U_N on the "Normal" source. It is generally used to manage two permanent sources and can control ComPact NS, ComPact NSX and MasterPacT MTZ circuit breakers and switch-disconnectors.

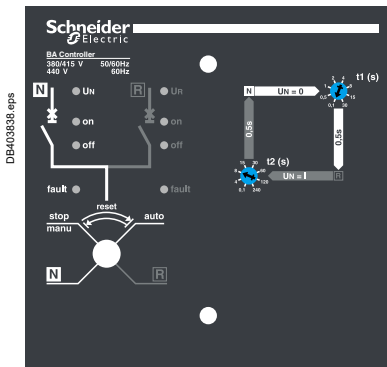

Front of the BA controller.

Operating Modes

A four-position switch may be used to select:

- automatic operation
- forced operation on the "Normal" source
- forced operation on the "Replacement" source
- stop (both "Normal" and "Replacement" sources off).

Setting the Time Delays

Time delays are set on the front of the controller.

t1. delay between detection that the "Normal" source has failed and the transmission of the order to open the "Normal" source circuit breaker (adjustable from 0.1 to 30 seconds).

t2. delay between detection that the "Normal" source has returned and the transmission of the order to open the "Replacement" source circuit breaker (adjustable from 0.1 to 240 seconds).

Circuit Breaker Commands and Status Indications

The status of the circuit breakers is indicated on the front of the controller.

- ON, OFF, fault.

A built-in terminal block may be used to connect the following input/output signals:

- inputs:
 - voluntary order to transfer to source R (e.g. for special tariffs, etc.)
 - additional control contact (not part of the controller). Transfer to the "Replacement" source takes place only if the contact is closed (e.g. used to test the frequency of UR, etc.)
- outputs:
 - indication of operation in automatic or stop mode via changeover contacts.

Test

It is possible to test the operation of the BA controller by turning OFF (opening) the P25M circuit breaker for the "Normal" source and thus simulating a failure of voltage U_N .

TransferPacT Controllers

BA Controller

Operating Sequences

Switch Set to Auto (automatic operation and special-tariff mode)

Switch Set to the "N" Position (forced operation on the "Normal" source)

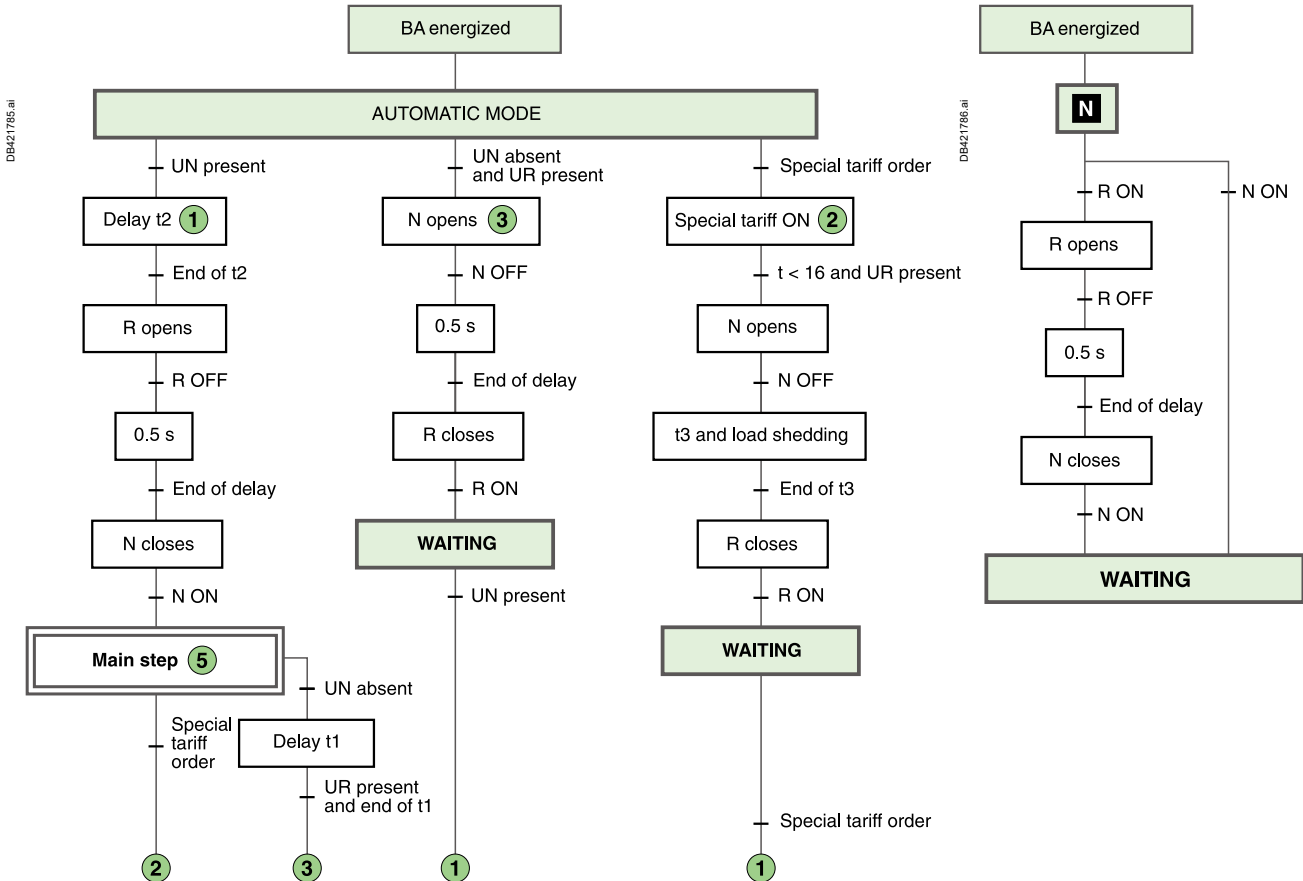

Switch set to the "R" position (forced operation on the "Replacement" source)

Switch set to the "Stop" position



Key

- UN: "Normal" source voltage
- UR: "Replacement" source voltage
- N : "Normal" source circuit breaker
- R: "Replacement" source circuit breaker

WAITING The system exits this mode when the operating mode is modified or when an external event occurs (e.g. failure or return of UN).

① The number sends to the indicated step when the condition is true.



TransferPacT Controllers

UA controller

The UA controller is used to create a source-changeover system integrating the following automatic functions:

- transfer from one source to another depending on the presence of voltage UN on the “Normal” source
- startup of an engine generator set
- shedding and reconnection of non-priority circuits
- transfer to the “Replacement” source if one of the phases on the “Normal” source fails.

The UA controller can control ComPact NS, ComPact NSX and MasterPacT MTZ devices.

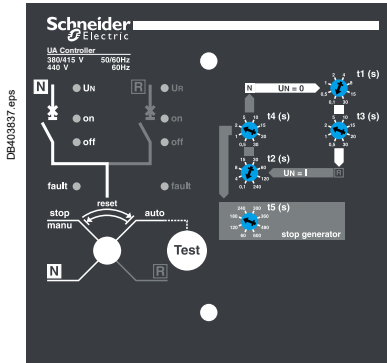

Front of the UA controller.

Operating Modes

A four-position switch may be used to select:

- automatic operation
- forced operation on the “Normal” source
- forced operation on the “Replacement” source
- stop (both “Normal” and “Replacement” sources off, then manual operation).

Setting the Time Delays

Time delays are set on the front of the controller.

- t1.** delay between detection that the “Normal” source has failed and the transmission of the order to open the “Normal” source circuit breaker (adjustable from 0.1 to 30 seconds).
- t2.** delay between detection that the “Normal” source has returned and the transmission of the order to open the “Replacement” source circuit breaker (adjustable from 0.1 to 240 seconds).
- t3.** delay following opening of QN with load shedding and before closing of QR (adjustable from 0.5 to 30 seconds).
- t4.** delay following opening of QR with load reconnection and before closing of QN (adjustable from 0.5 to 30 seconds).
- t5.** delay for confirmation that UN is present before shutting down the engine generator set (adjustable from 60 to 600 seconds).
- t6.** delay before startup of the engine generator set (120 or 180 seconds).

Commands and Indications

Circuit breaker status indications on the front of the controller:

- ON, OFF, fault.

A built-in terminal block may be used to connect the following input/output signals:

- inputs:
 - voluntary order to transfer to source R (e.g. for special tariffs, etc.)
 - additional control contact (not part of the controller). Transfer to the “Replacement” source takes place only if the contact is closed (e.g. used to test the frequency of UR, etc.)
- outputs:
 - control of an engine generator set (ON / OFF)
 - shedding of non-priority circuits
 - indication of operation in automatic mode via changeover contacts.

Distribution-System Settings

Three switches are used to:

- select the type of “Normal” source, whether single-phase or three-phase (e.g. 240 V single-phase or 240 V three-phase)
- select whether to remain (or not) on the “Normal” source if the “Replacement” source is not operational during operation on special tariffs
- select the maximum permissible startup time for the engine generator set during operation on special tariffs (120 or 180 seconds).

Test

A pushbutton on the front of the controller may be used to test transfer from the “Normal” source to the “Replacement” source, then the return to the “Normal” source. The test lasts approximately three minutes.

TransferPacT Controllers

UA Controller

Operating Sequences, Forced Operation Mode

Switch set to the "R" position (forced operation on the "Replacement" source)

Switch set to the "N" position (forced operation on the "Normal" source)

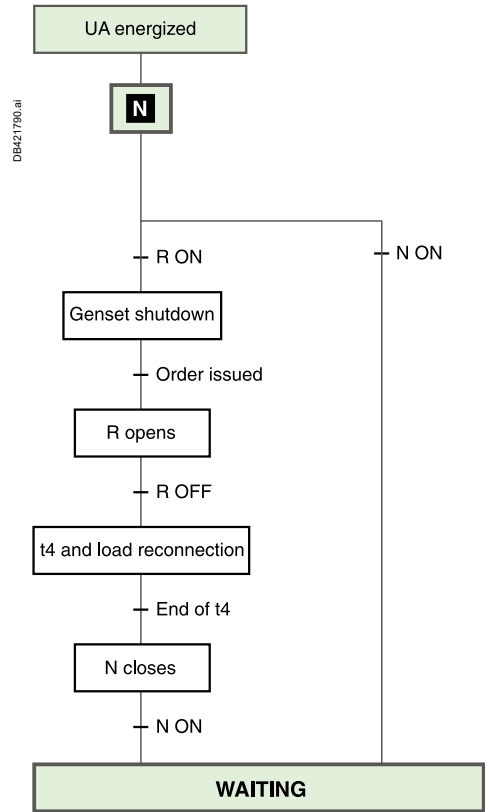
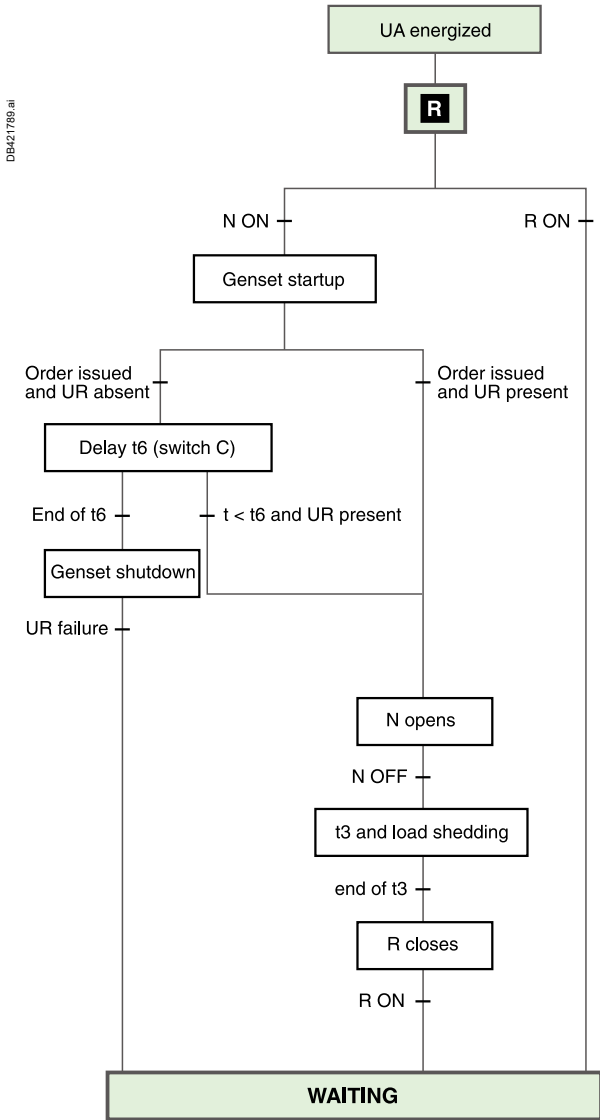

WAITING The system exits this mode when the operating mode is modified or when an external event occurs (e.g. failure or return of UN).

When the UA controller is not energized, the output for generator set startup is activated).

Key

- UN: "Normal" source voltage
- UR: "Replacement" source voltage
- N : "Normal" source circuit breaker
- R: "Replacement" source circuit breaker

Switch set to the "Stop" position

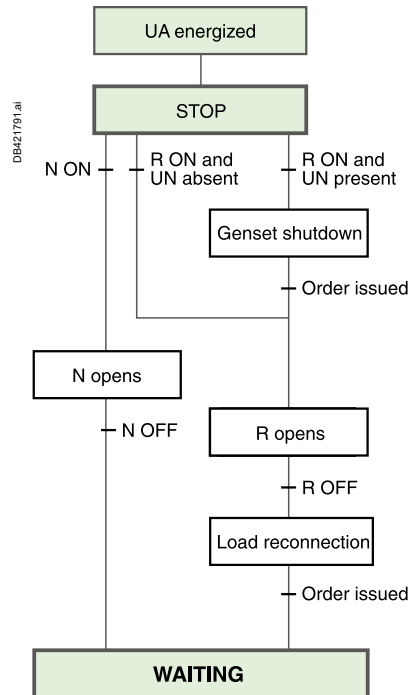

TransferPacT Controllers

UA Controller

Operating Sequences, Special-Tariff Mode

Switch Set to the "Auto" Position (special-tariff mode)

WAITING The system exits this mode when the operating mode is modified or when an external event occurs (e.g. failure or return of UN).

When the UA controller is not energized, the output for generator set startup is activated.

DB421762.ai

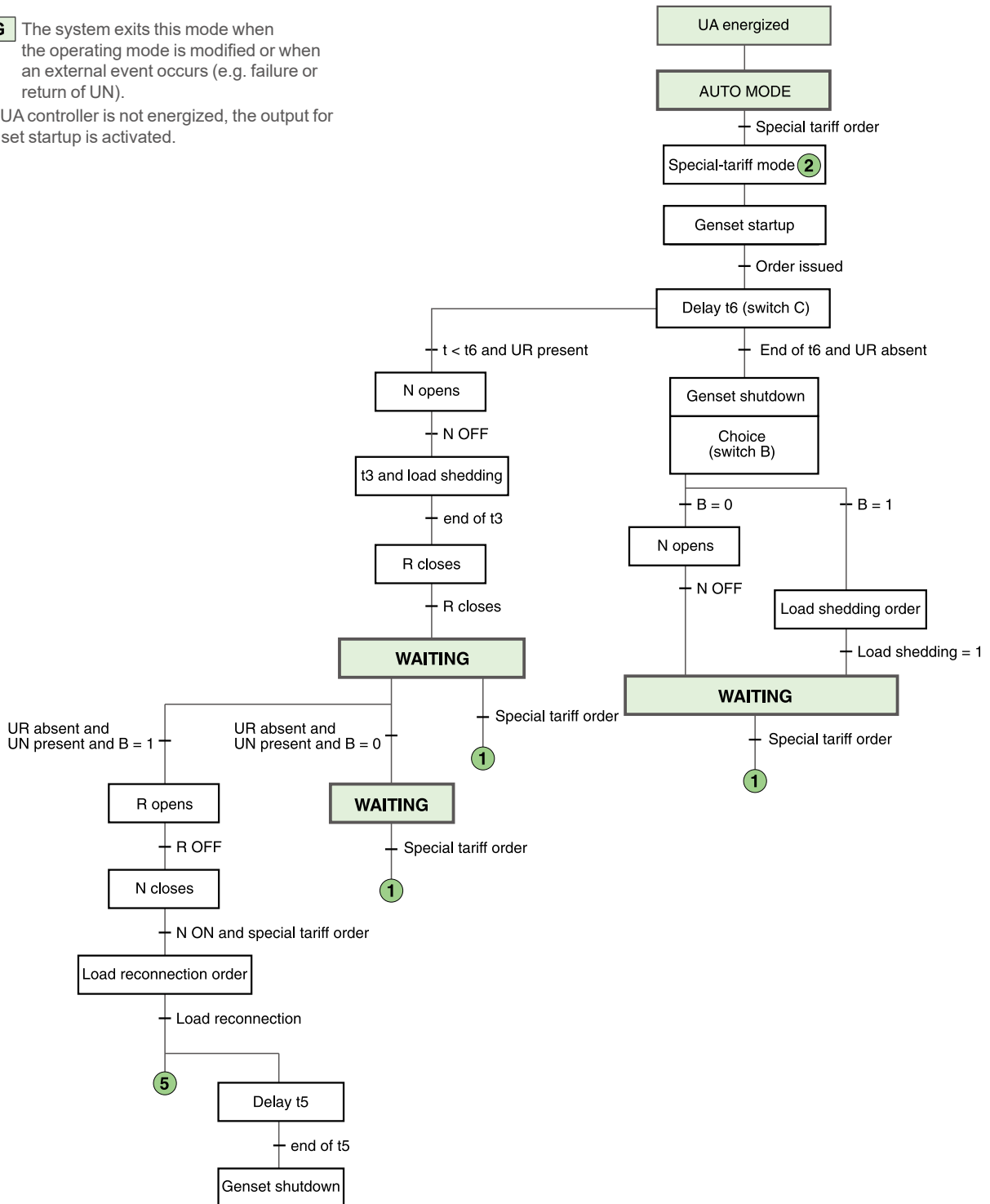

- Key**
- UN: "Normal" source voltage
 - UR: "Replacement" source voltage
 - N: "Normal" source circuit breaker
 - R: "Replacement" source circuit breaker
 - B: Penalties accepted (N ON), i.e. B = 1

① The number sends to the indicated step when the condition is true.

TransferPacT Controllers

UA Controller

Operating Sequences, Test Mode and Automatic Operation

Switch Set to the "Auto" Position (automatic operation and test mode).

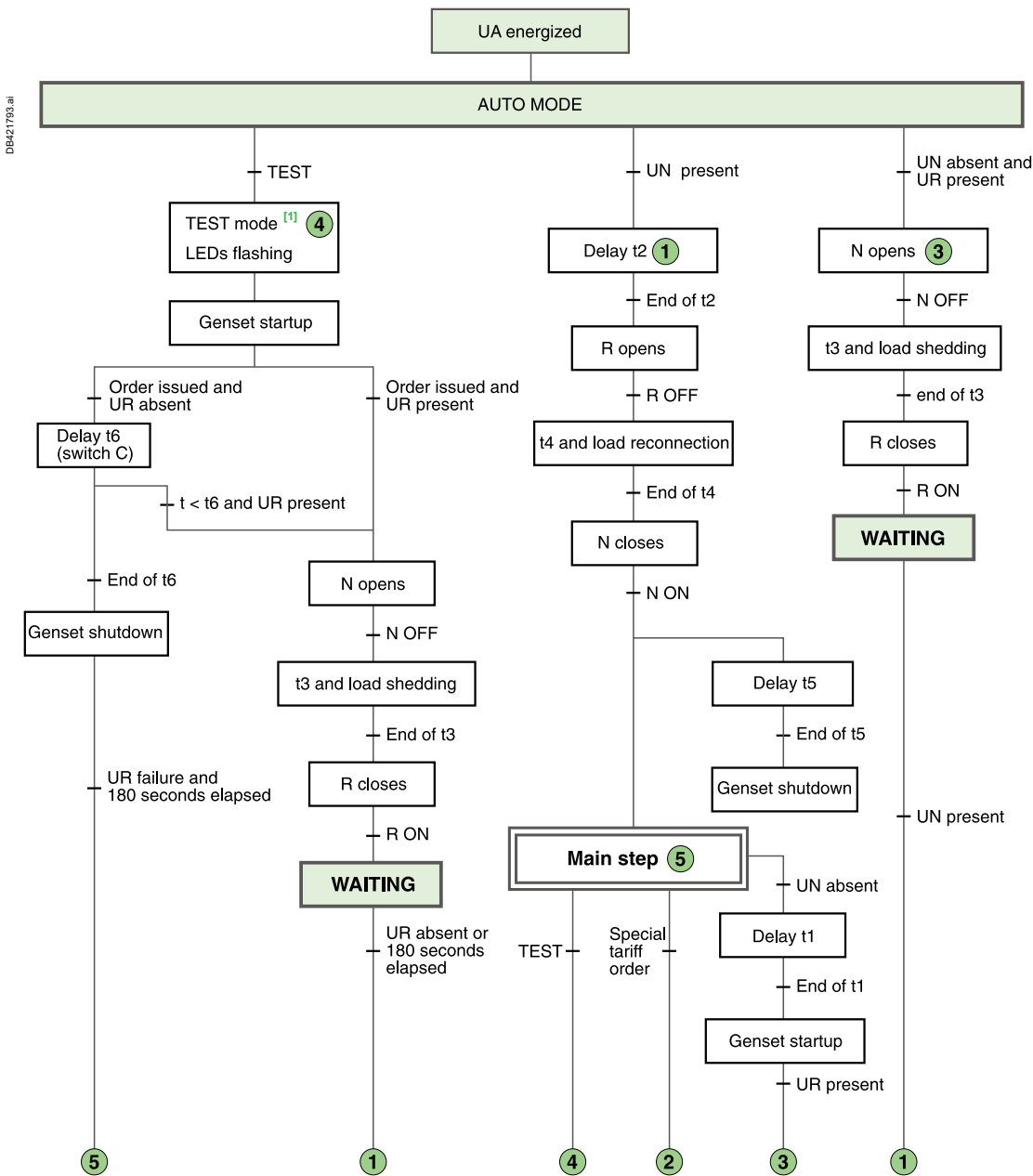

WAITING The system exits this mode when the operating mode is modified or when an external event occurs (e.g. failure or return of UN).

When the UA controller is not energized, the output for generator set startup is activated).

Key

- UN: "Normal" source voltage
- UR: "Replacement" source voltage
- N: "Normal" source circuit breaker
- R: "Replacement" source circuit breaker
- B: Penalties accepted (N ON), i.e. B = 1
- [1] The test lasts 180 seconds.

① The number sends to the indicated step when the condition is true.



TransferPacT Controllers

UA/BA Controller

BA Controller

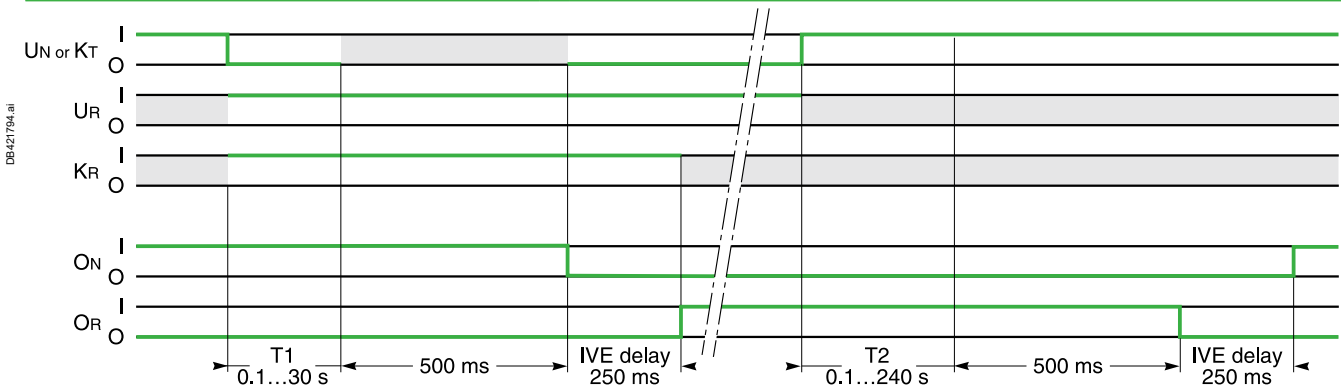

Inputs

UN: "Normal" source voltage
 UR: "Replacement" source voltage
 KT: order for forced-operation on R
 KR: additional check before transfer

Outputs

QN: "Normal" source circuit breaker
 QR: "Replacement" source circuit breaker

UA Controller

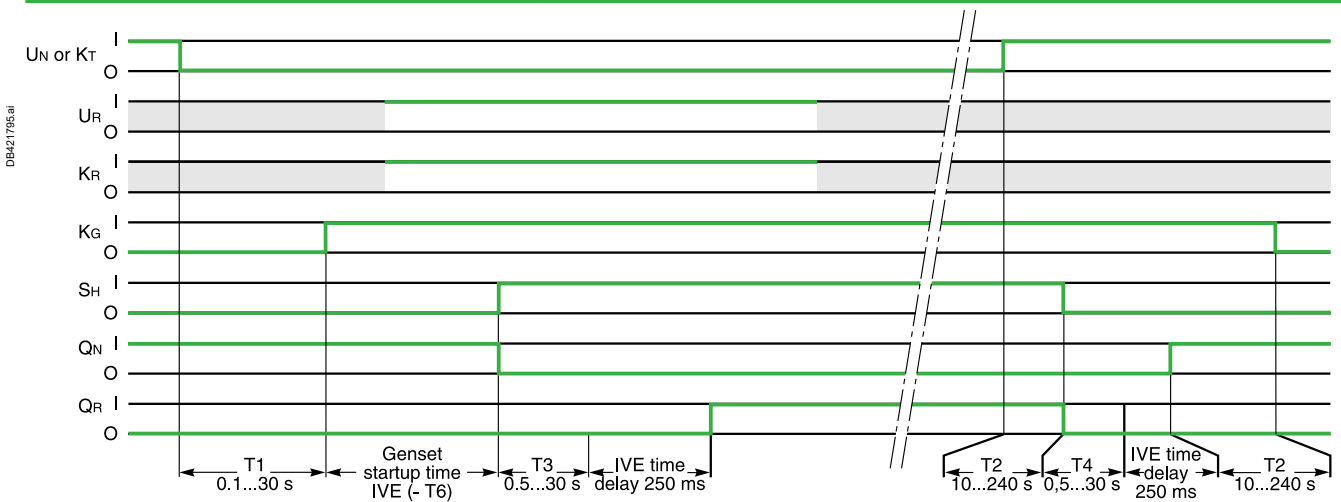

Inputs

UN: "Normal" source voltage
 UR: "Replacement" source voltage
 KT: order for forced-operation on R

Outputs

KG: order to the genset
 SH: load-shedding order
 QN: "Normal" source circuit breaker
 QR: "Replacement" source circuit breaker

Key

O: OFF (circuit open)
 I: ON (circuit closed)
 ■ : either ON or OFF.

Important

If UR is not ON when the transfer order is issued (KT or UN), the sequence is not carried out. If KR status is not ON when the transfer order is issued (KT or UN), the transfer sequence is carried out later when KR status becomes I.

Manual Source-Changeover Systems

ComPacT INS/INV

Class PC

**Interlocking of Direct Rotary Handles
(ComPacT INS/INV250 - 100 to 250 A / ComPacT INS/INV320/400/500/630)**

Dimensions **Front-Panel Cutout**

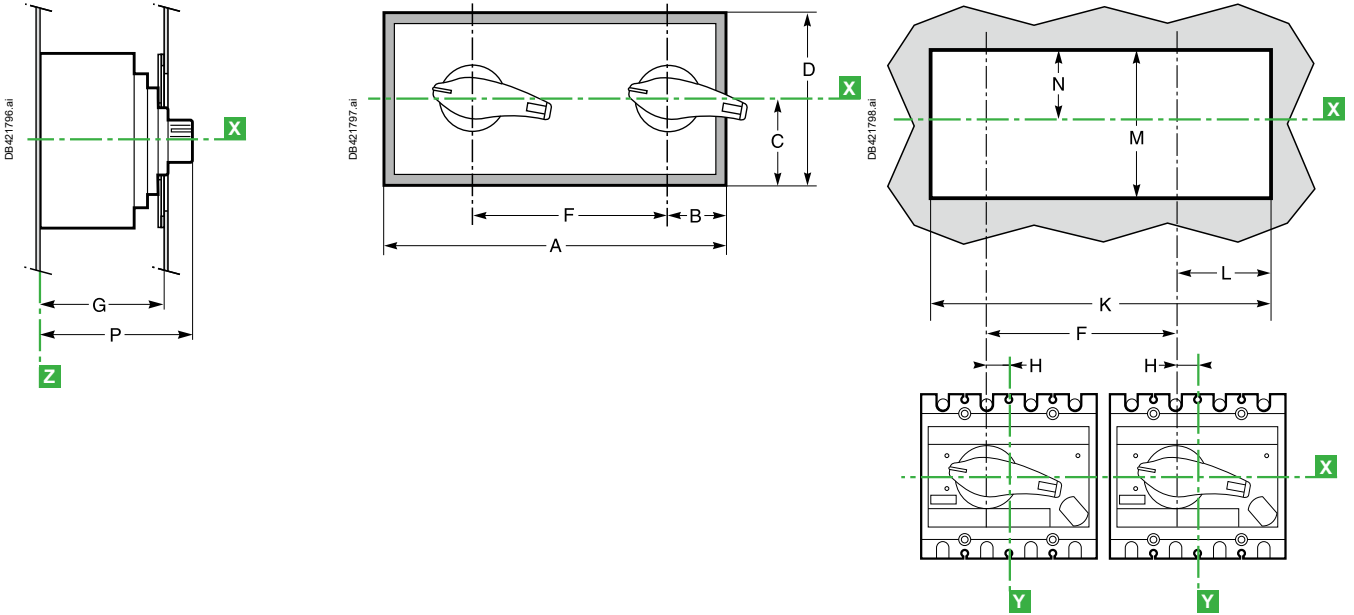

Dimensions (mm)

Type	A	B	C	D	F	G	H	K	L	M	N	P
INS/INV250 - 100 to 250 A	325	90	87.5	175	156	106	17.5	295	75.5	150	75	131
INS/INV320/400/500/630	416	115	100	200	210	130	22.5	386	100	175	74.5	160.4

Note: X and Y are the symmetry planes for a 3-pole device.

**Interlocking of Extended Rotary Handles
(ComPacT INS40/63/80/100/125/160 / ComPacT INS/INV250 - 100 to 250 A / ComPacT INS/INV320/400/500/630)**

Dimensions **Front-Panel Cutout**

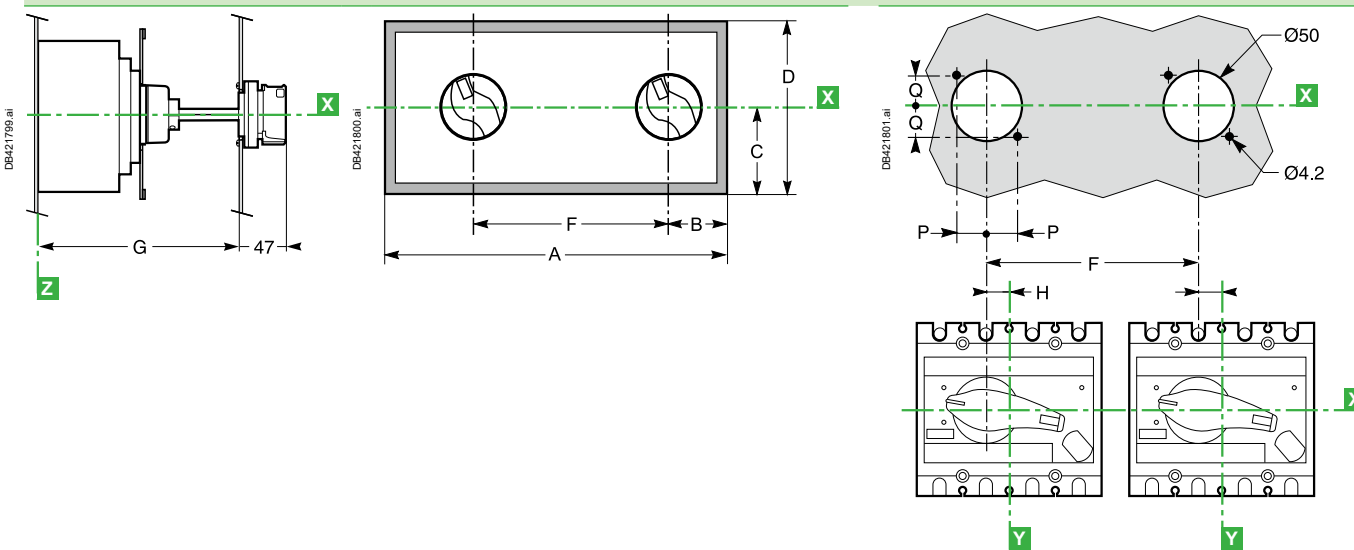

Dimensions (mm)

Type	A	B	C	D	F	G min	G max	H	P	Q
INS40/63/80	325	90	87.5	175	156	155	396	0	25.5	25.5
INS100/125/160	325	90	87.5	175	156	200	441	0	25.5	25.5
INS/INV250 - 100 to 250 A	325	90	87.5	175	156	185	600	17.5	25.5	25.5
INS320/400/500/630	416	115	100	200	210	204	600	22.5	30.8	30.8

Manual Source-Changeover Systems

ComPacT NSX

Class PC and CB

Interlocking of Direct Rotary Handles
 (ComPacT NSX100 to NSX630 and ComPacT NSX100 NA to NSX630 NA)

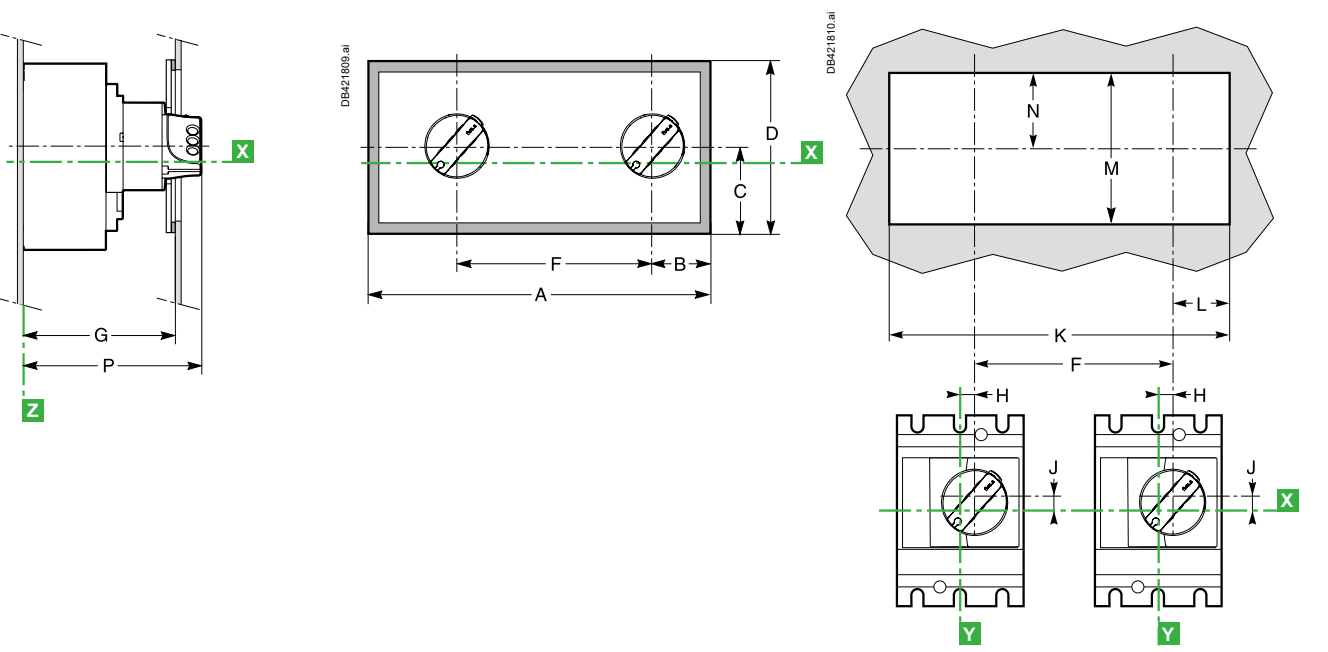

Dimensions (mm)

	A	B	C	D	F	G	H	J	K	L	M	N	P
NSX100/160/250 and NA	325	90	87.5	175	156	133	9.25	9	295	75.5	150	75	155
NSX400/630 and NA	416	115	100	200	210	157	5	24.6	386	100	175	74.5	179

Interlocking of Extended Rotary Handles
 (ComPacT NSX100 to NSX630 and ComPacT NSX100 NA to NSX630 NA)

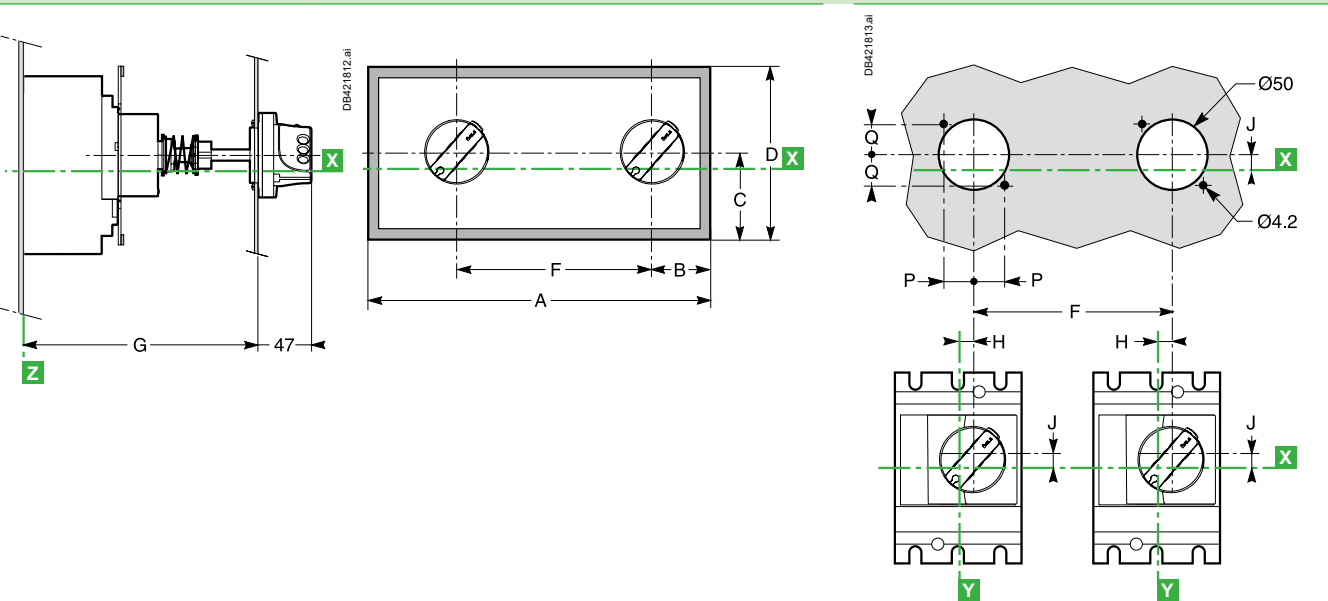

Dimensions (mm)

Type	A	B	C	D	F	G min	G max	H	J	P	Q
NSX100/160/250 and NA	325	90	87.5	175	156	171	600	9.25	9	25.5	25.5
NSX400/630 and NA	416	115	100	200	210	195	600	5	24.6	30.8	30.8



Manual Source-Changeover Systems

ComPacT NSX

Class PC and CB

Interlocking of Toggles (ComPacT NSX100 to NSX630 and ComPacT NSX100 NA to NSX630 NA)

Dimensions 3 Poles 4 Poles

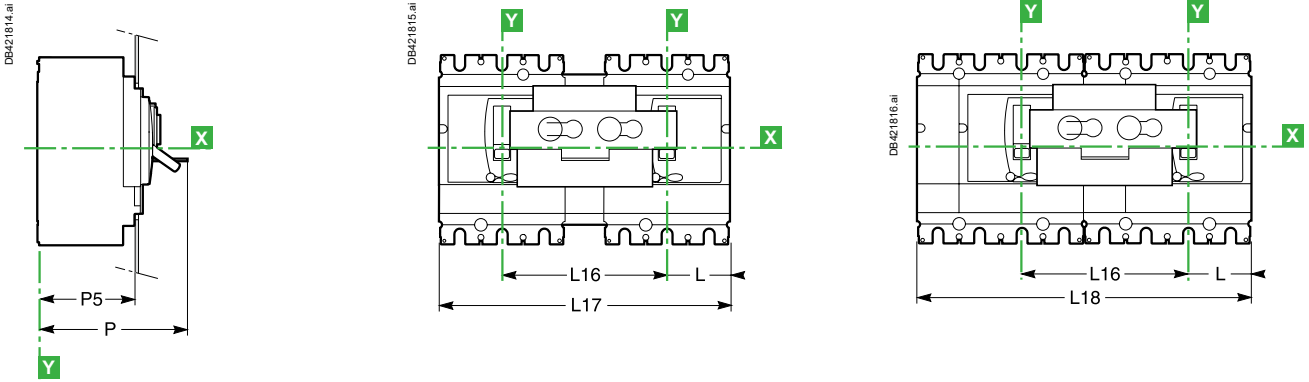

Front-Panel Cutout 3 Poles on Left 4 Poles on Left

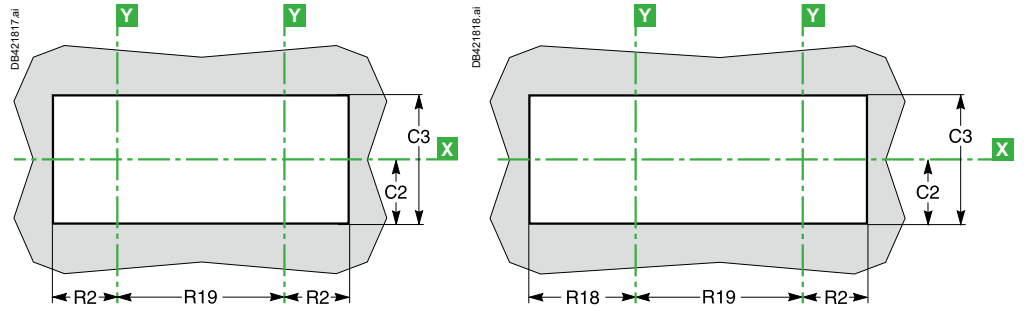

Dimensions (mm)

Type	C2	C3	L	L16	L17	L18	R2	R18	R19	P5	P
NSX100/160/250 and NA	54	108	52.5	140	245	280	54	89	140	83	120
NSX400/630 and NA	92.5	182	70	185	325	370	71.5	116.5	185	107	150

Manual Source-Changeover Systems

ComPacT NSX - Interlocking on a Base Plate

Class PC and CB

ComPacT NSX100 to NSX250 and ComPacT NSX100 NA to NSX250 NA

Dimensions, 3 or 4 Poles **Fixed Device** **Withdrawable Device**

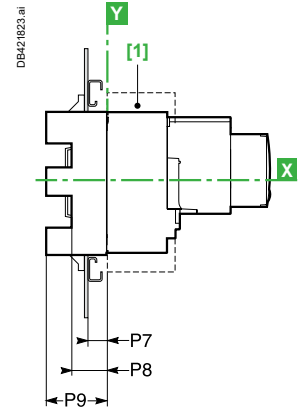
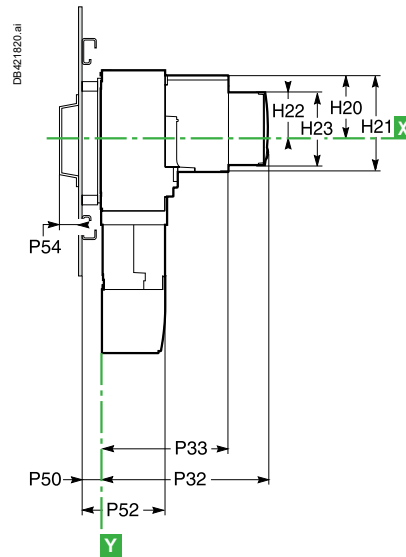
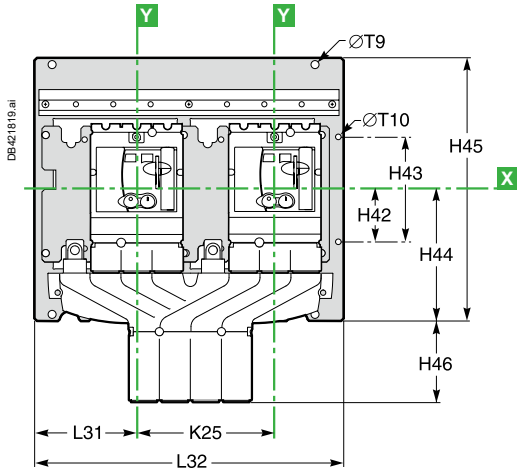

[1] Short terminal shields are mandatory.



Vertical Mounting **Horizontal Mounting**

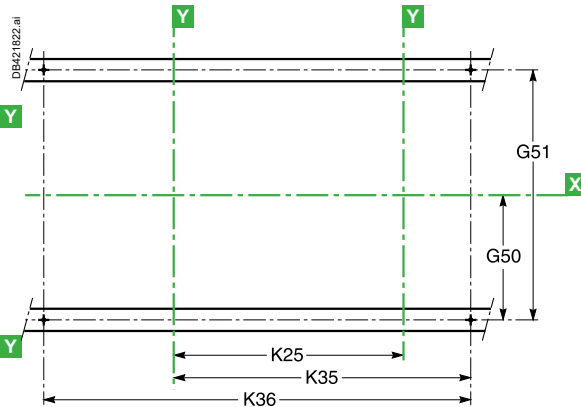
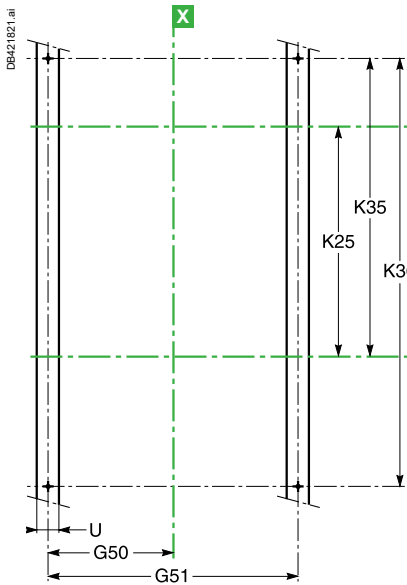

Dimensions (mm)														
Type	G50	G51	H20	H21	H22	H23	H42	H43	H44	H45	H46	K25	K35	K36
NSX100/160/250 and NA	137.5	285	62.5	97	45.5	73	60	120	144.5	300	37	156	210.5	300
NSX400/630 and NA	180	360	100	152	83	123	60	120	189	378	77	210	282.5	400

Dimensions (mm)														
Type	L31	L32	P7	P8	P9	P32	P33	P50	P52	P54	ØT9	ØT10	U	
NSX100/160/250 and NA	110.5	354	25	45	75	182	143	25	99.5	21	9	6	≤ 32	
NSX400/630 and NA	150.5	466	25	45	100	256	215	25	123	21	9	6	≤ 32	

Note: coupling accessory: only for changeover systems using fixed versions of ComPacT NSX circuit breakers.

Manual Source-Changeover Systems

ComPacT NSX - Interlocking on a Base Plate

Class PC and CB

ComPacT NSX400 to NSX630 and ComPacT NSX400 NA to NSX630 NA

Dimensions, 3 or 4 Poles

Fixed Device

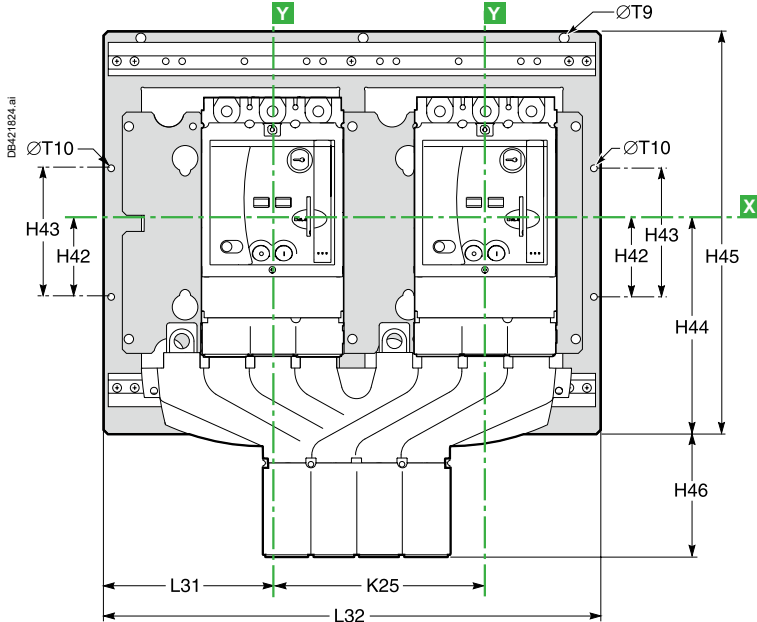

Note: coupling accessory: only for changeover systems using fixed versions of ComPacT NSX circuit breakers.

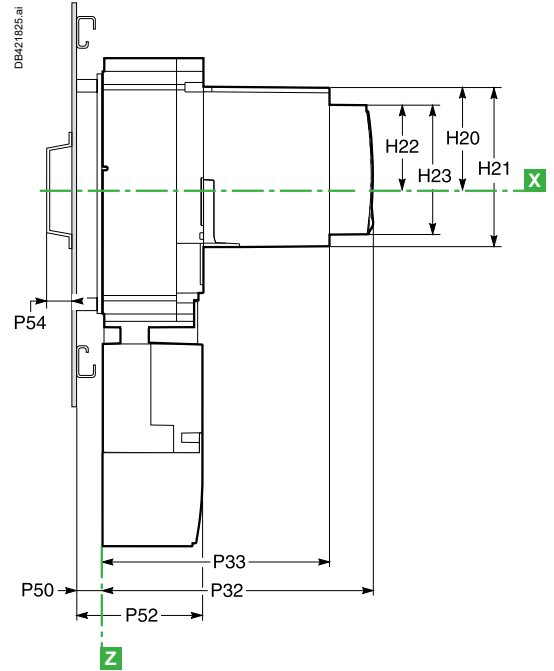

Vertical mounting

Withdrawable device

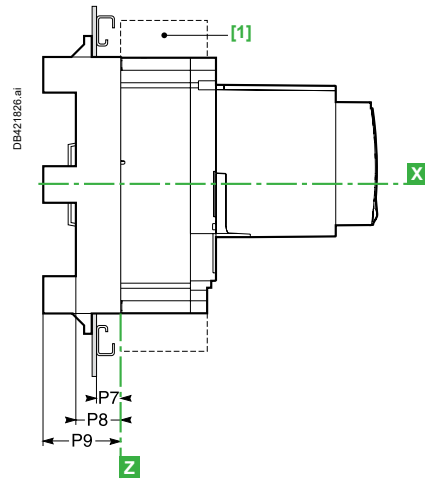
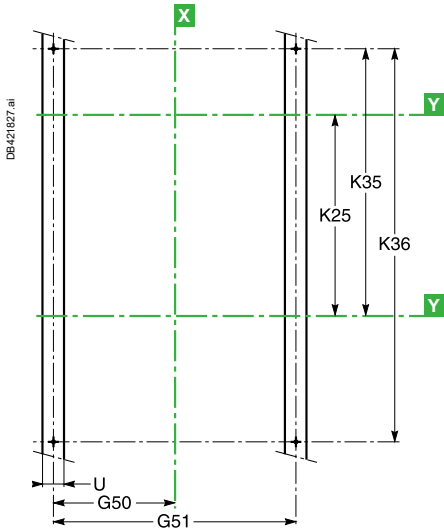

[1] Short terminal shields are mandatory.

Horizontal mounting

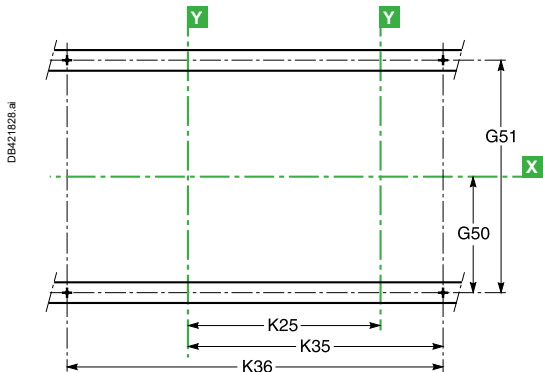

Note: for dimensions see page C-22.

Manual Source-Changeover Systems

ComPacT NSX - Interlocking on a Base Plate

Class PC and CB

“Normal” and “Replacement” source devices: NSX100 to NSX250

Dimensions

Front-Panel Cutout

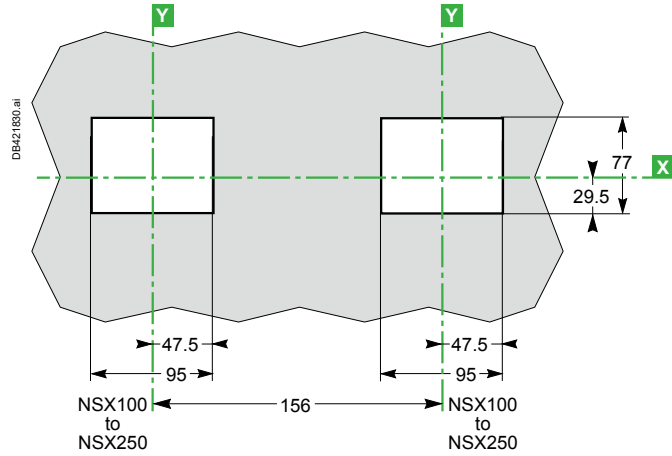
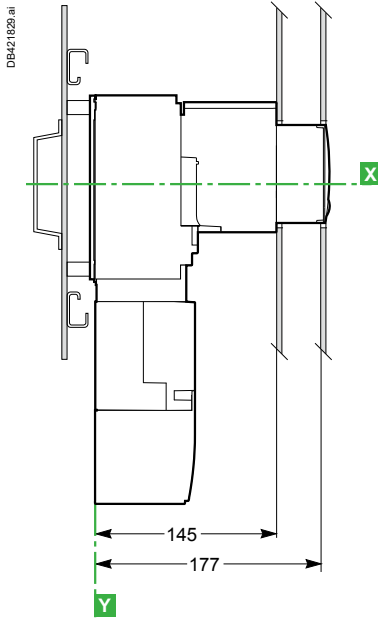

“Normal” and “Replacement” source devices: NSX400 to NSX630

Dimensions

Front-panel cutout

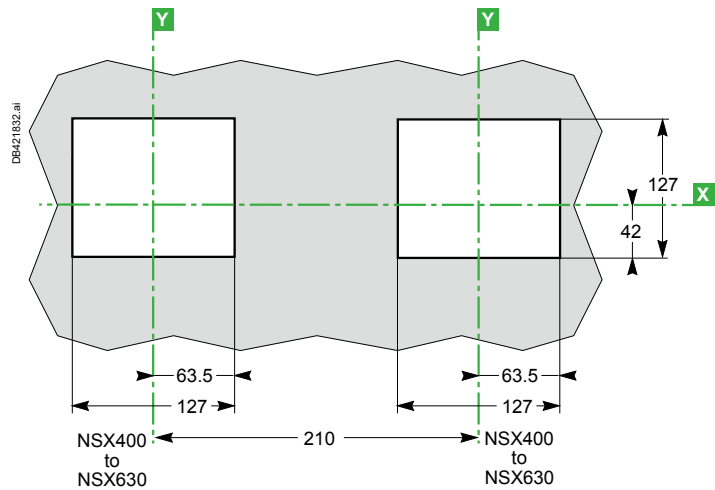
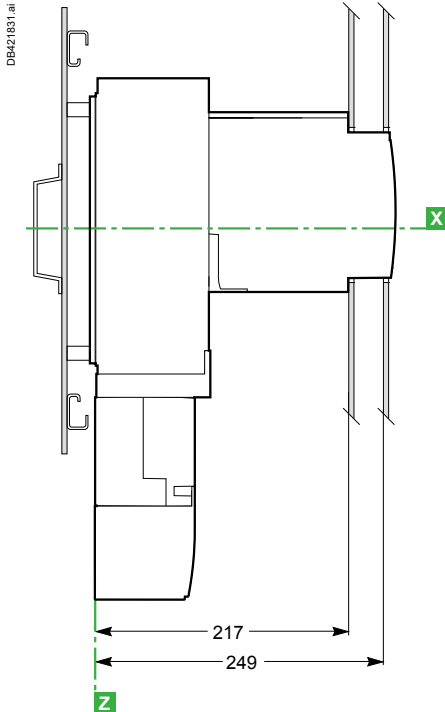

Note for ComPacT NSX: For dimensions with the accessories (IP40 escutcheons and Vigi escutcheon protection collars), see Catalog ComPacT.



Manual Source-Changeover Systems

Downstream Coupling Accessory

Class PC and CB

Downstream Coupling Accessory
ComPacT NSX100 to NSX630, ComPacT NSX100 NA to NSX630 NA and ComPacT INS/INV ^[1]
Dimensions for ComPacT NSX **Dimensions for ComPacT INS/INV**

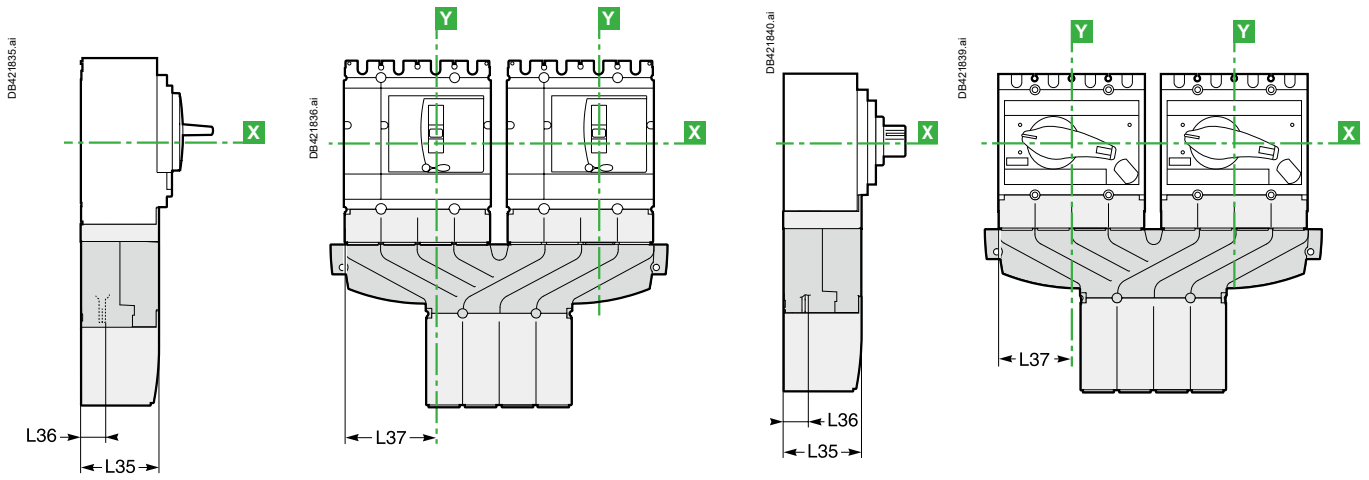

Dimensions **Connection**

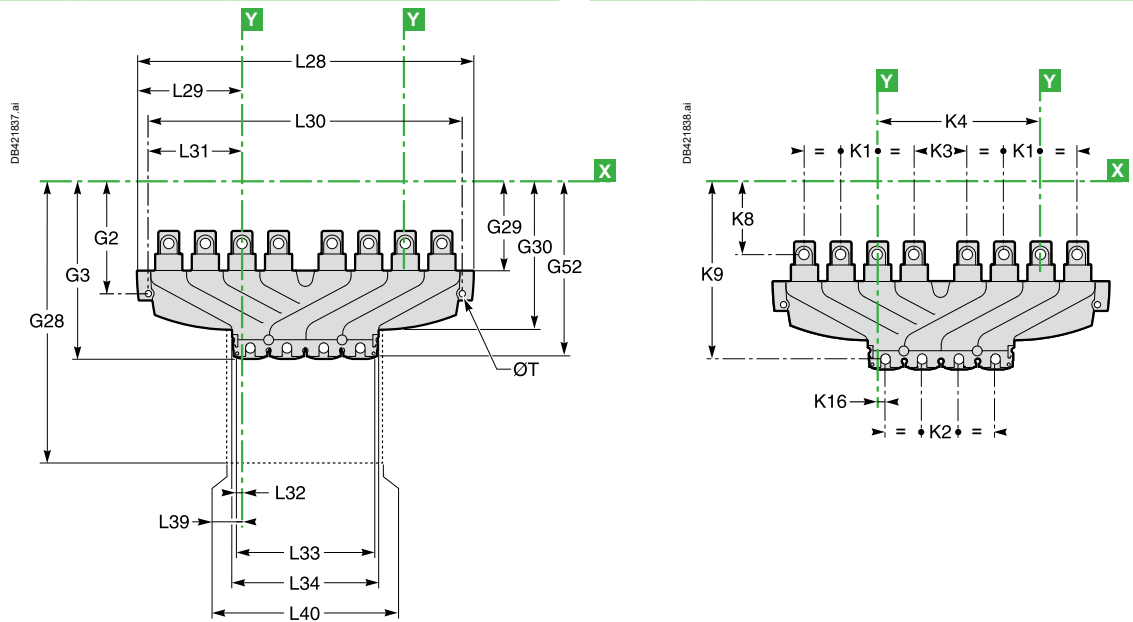

Dimensions (mm)													
Type	G2	G3	G28	G29	G30	G52	K1	K2	K3	K4	K8	K9	K16
NSX100/160/250 and NA	118	181.5	244.5	96	152.5	178	35	35	51	156	70	170	8
NSX400/630 and NA	165.9	264.7	337.5	143.5	220.5	264.7	45	45	75	210	113.5	250.7	15
INS250 - 100 to 250 A	105.5	169	232	83.5	140	165.5	35	35	51	156	57.5	157.5	25.5
INS320/400/500/630	141	240.7	313	119	195.6	240	45	45	75	210	88.5	225.7	37.5

Dimensions (mm)													
Type	L28	L29	L30	L31	L32	L33	L34	L35	L36	L37	L39	L40	ØT
NSX100/160/250 and NA	320	99.5	300	89.5	4.73	130.5	139.5	74.5	19.5	87.5	9.5	140	6
NSX400/630 and NA	425	130	400	117.5	5.15	175.3	184.7	98.5	26	115	9.85	184.7	6
INS250 - 100 to 250 A	320	83	300	72	12.8	130.5	139.5	74.5	21.5	70	8.5	140	6
INS320/400/500/630	425	107.5	400	95	17.35	175.3	184.7	98.5	26	92.5	12.65	184.7	6

[1] coupling accessory: only for changeover systems using fixed versions of ComPacT NSX circuit breakers.



Manual Source-Changeover Systems

ComPacT NS - Interlocking on a Base Plate

Class PC and CB

Interlocking of Extended Rotary Handles
ComPacT NS630b to 1600 and ComPacT NS630b NA to NS1600 NA
 Dimensions

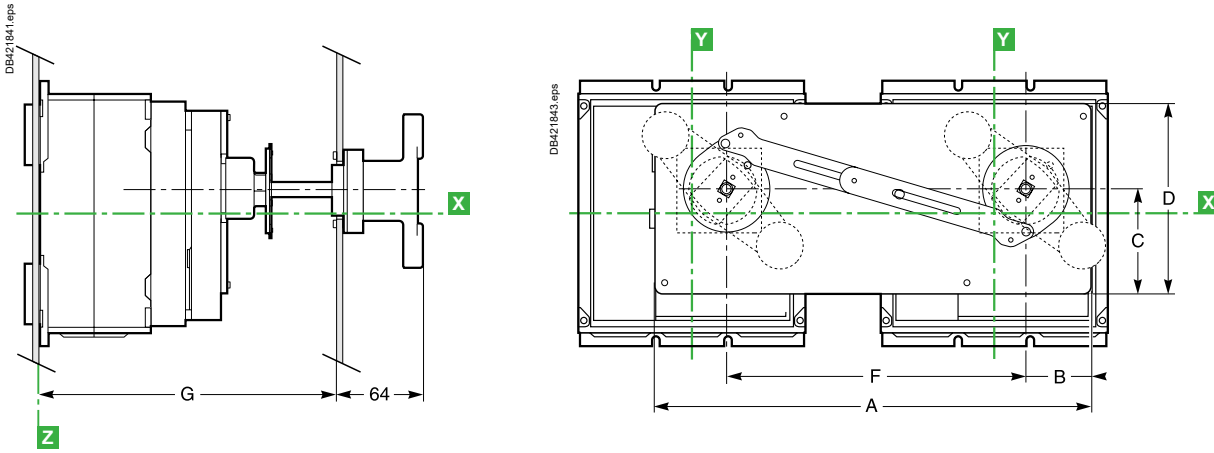

Front-panel cutout

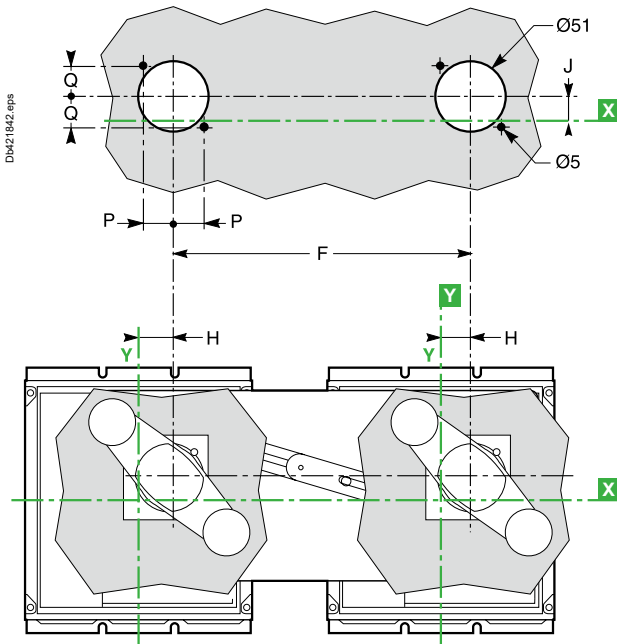

Dimensions (mm)

Type	A	B	C	D	F	G min	G max	H	J	P	Q	R
NS630b/800/1000/1200/1600	411	63.5	98	175	280	218	605	25	24	25.5	25.5	64

Source-Changeover Systems

Mechanical Interlocking Using Connecting Rods

ComPacT NS and MasterPacT MTZ1
Class PC and CB

ComPacT NS630b to NS1600 and ComPacT NS630b NA to NS1600 NA

Devices One Above the Other

Fixed devices

Withdrawable devices

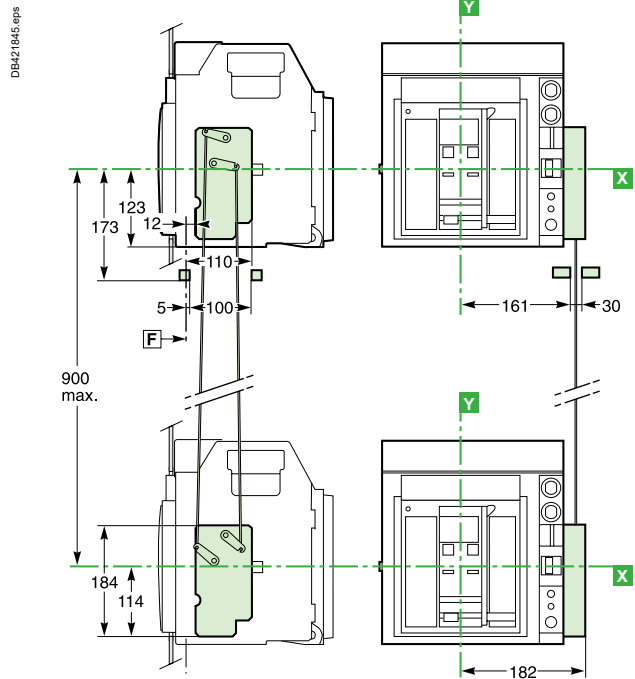
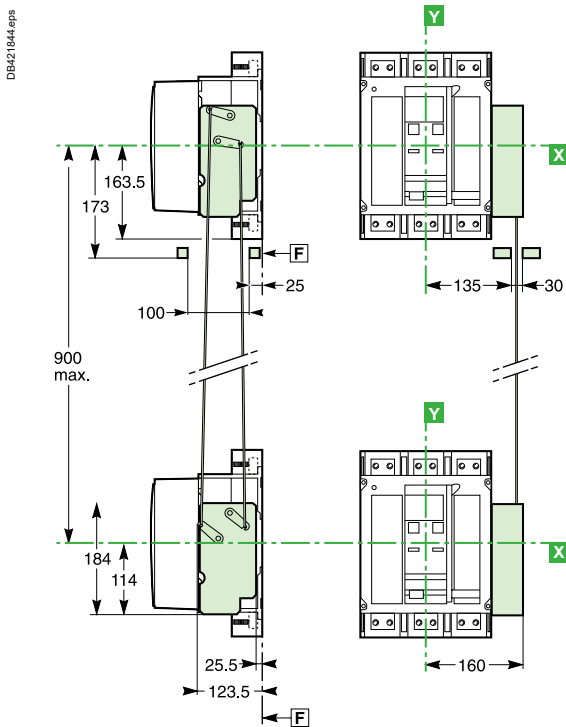

Two MasterPacT MTZ1 devices (switch-disconnectors or circuit breakers)
one above the other

Fixed devices

Withdrawable devices

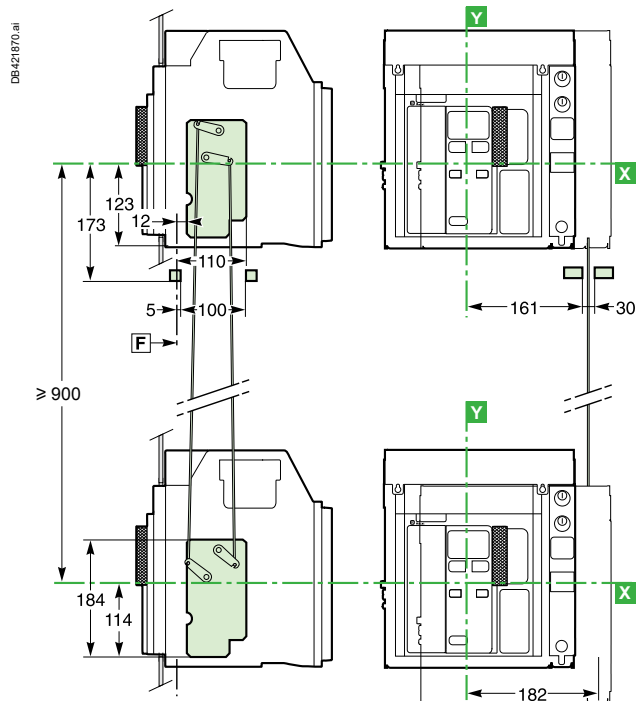
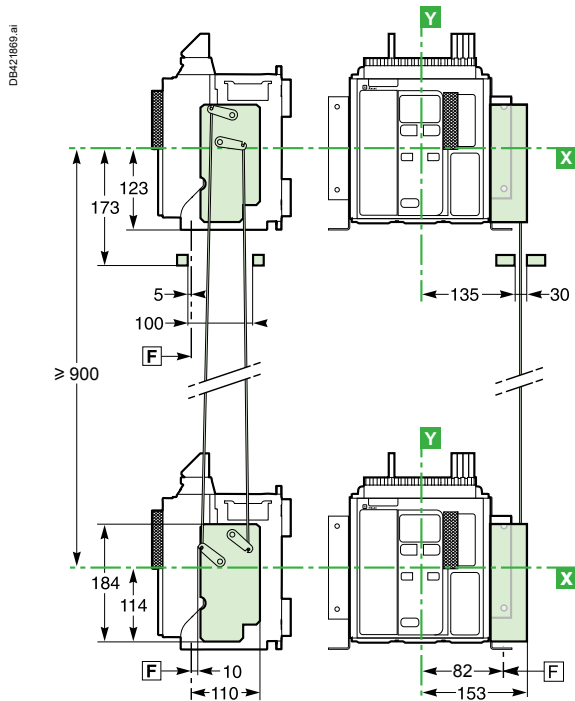

Source-Changeover Systems

Mechanical Interlocking Using Connecting Cables

ComPacT NS and MasterPacT MTZ1

Class PC and CB

**Two ComPacT NS630b to NS1600 and ComPacT NS630b NA to NS1600 NA
Devices One Above the Other**

Fixed Devices

Withdrawable Devices

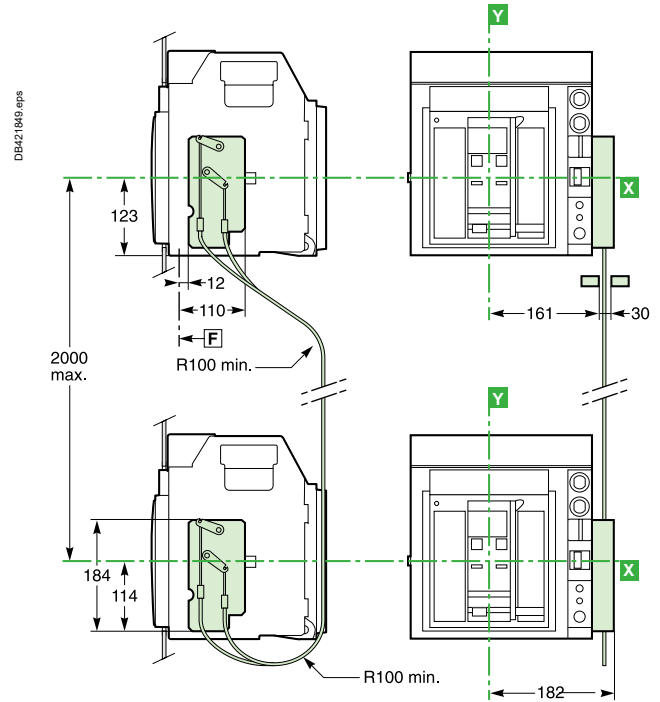
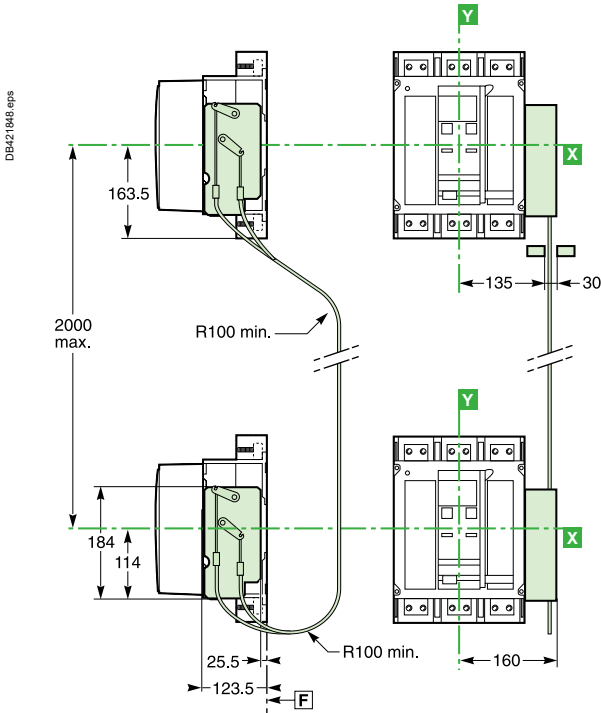

**Two MasterPacT MTZ1 Devices (switch-disconnectors or circuit breakers)
One Above the Other**

Fixed Devices

Drawout Devices

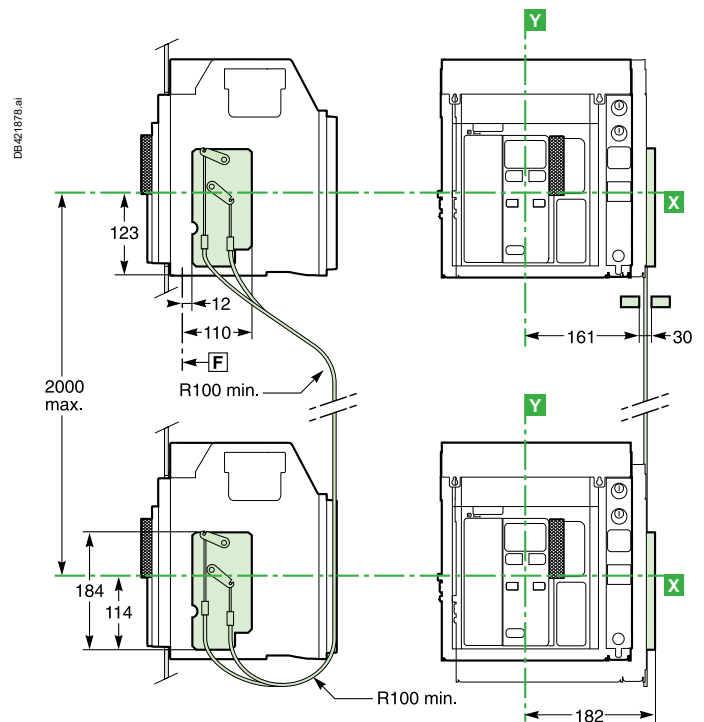
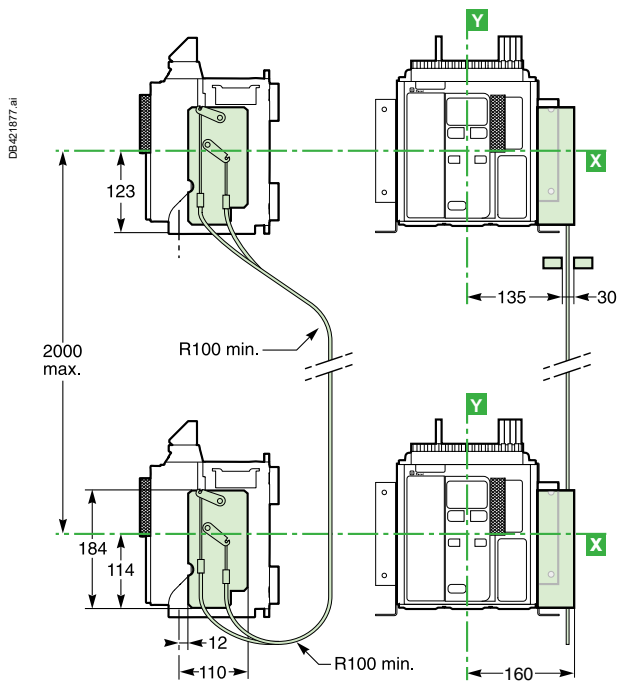

Source-Changeover Systems

Mechanical Interlocking Using Connecting Cables

MasterPacT MTZ

Class PC and CB

Two MasterPacT MTZ2/MTZ3 Devices (switch-disconnectors or circuit breakers)

One Above the Other

Fixed Devices

Drawout devices

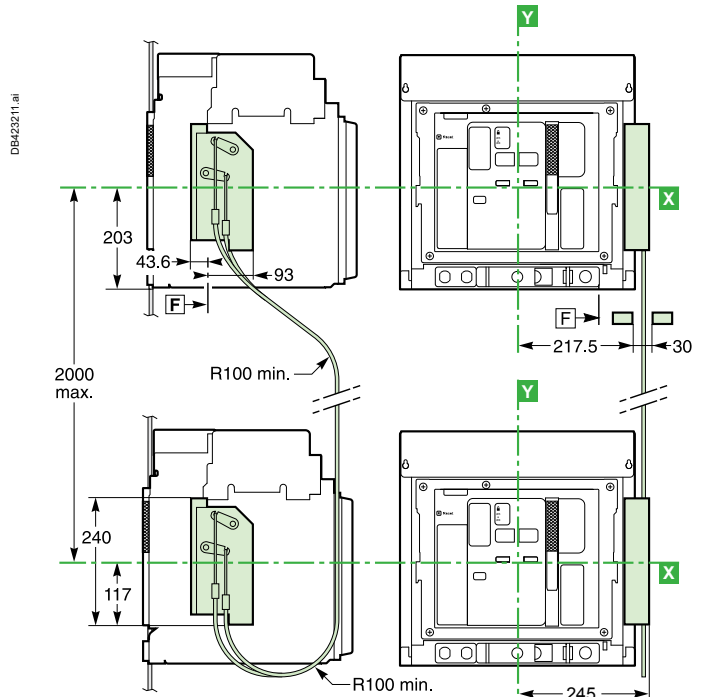
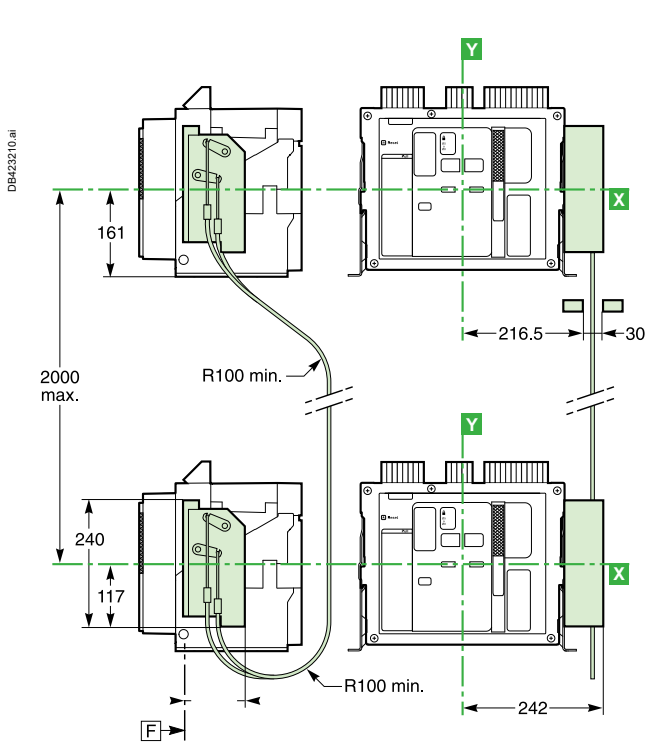

Two MasterPacT MTZ1 and MTZ2/MTZ3 Devices (switch-disconnectors or circuit breakers)

One Above the Other

Fixed Devices

Drawout Devices

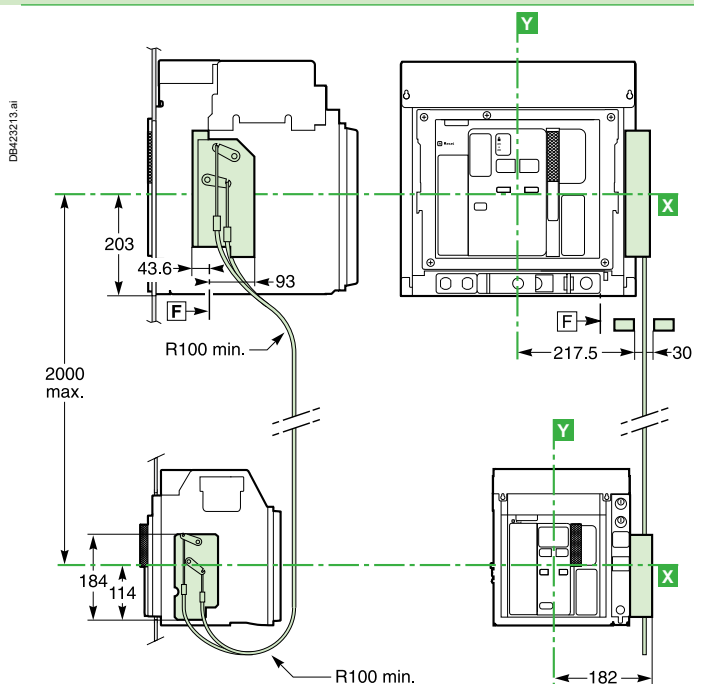
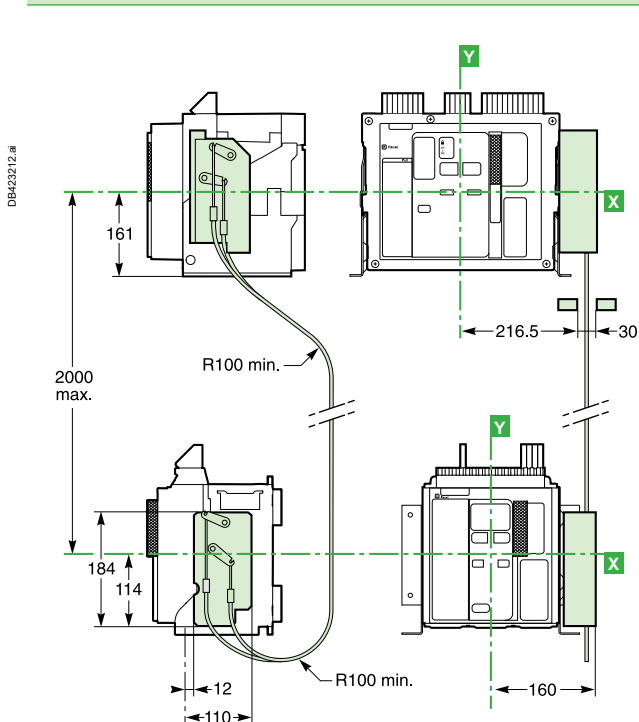

Source-Changeover Systems

Mechanical Interlocking Using Connecting Cables

MasterPacT MTZ2/MTZ3

Class PC and CB

Two MasterPacT MTZ2/MTZ3 Devices Side-by-Side

Fixed Devices

Drawout Devices

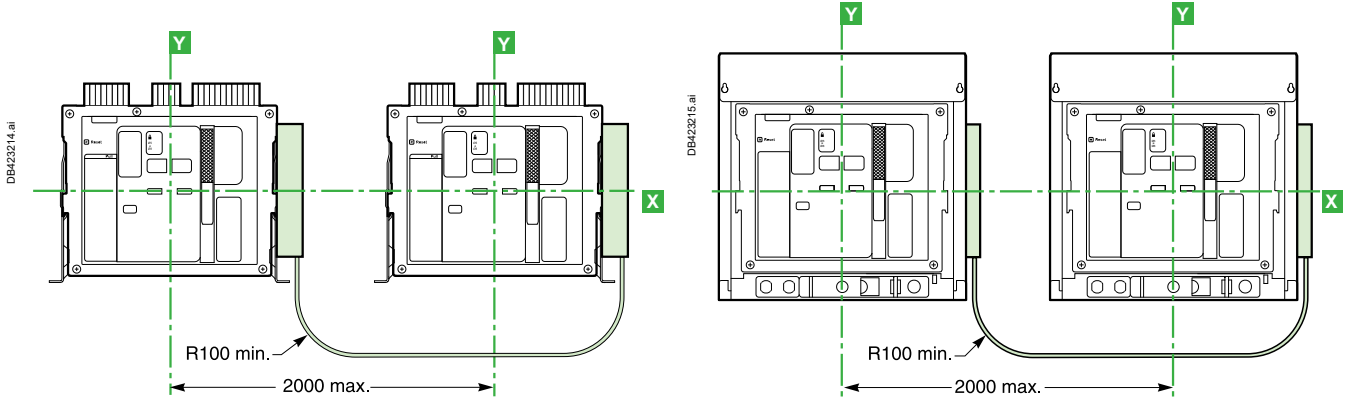

Three MasterPacT MTZ2/MTZ3 Devices (switch-disconnectors or circuit breakers) Side-by-Side

Fixed Devices

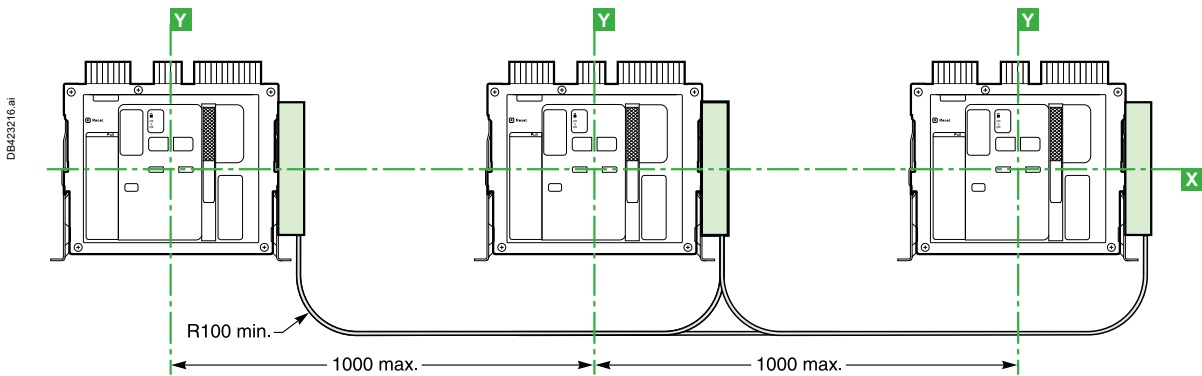

Drawout Devices

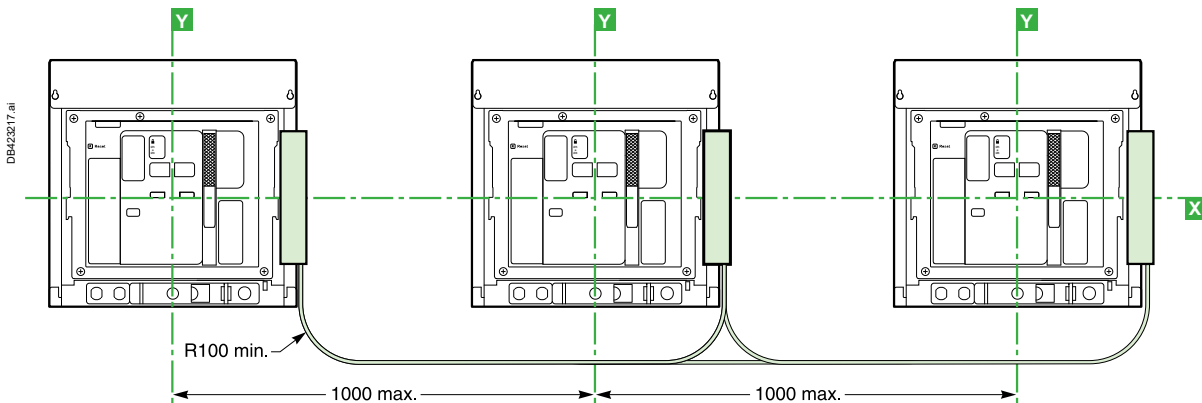

Source-Changeover Systems

Mechanical Interlocking Using Connecting Cables

MasterPacT MTZ2/MTZ3

Class PC and CB

Three MasterPacT MTZ2/MTZ3 Devices (switch-disconnectors or circuit breakers)
One Above the Other

Fixed Devices **Drawout Devices**

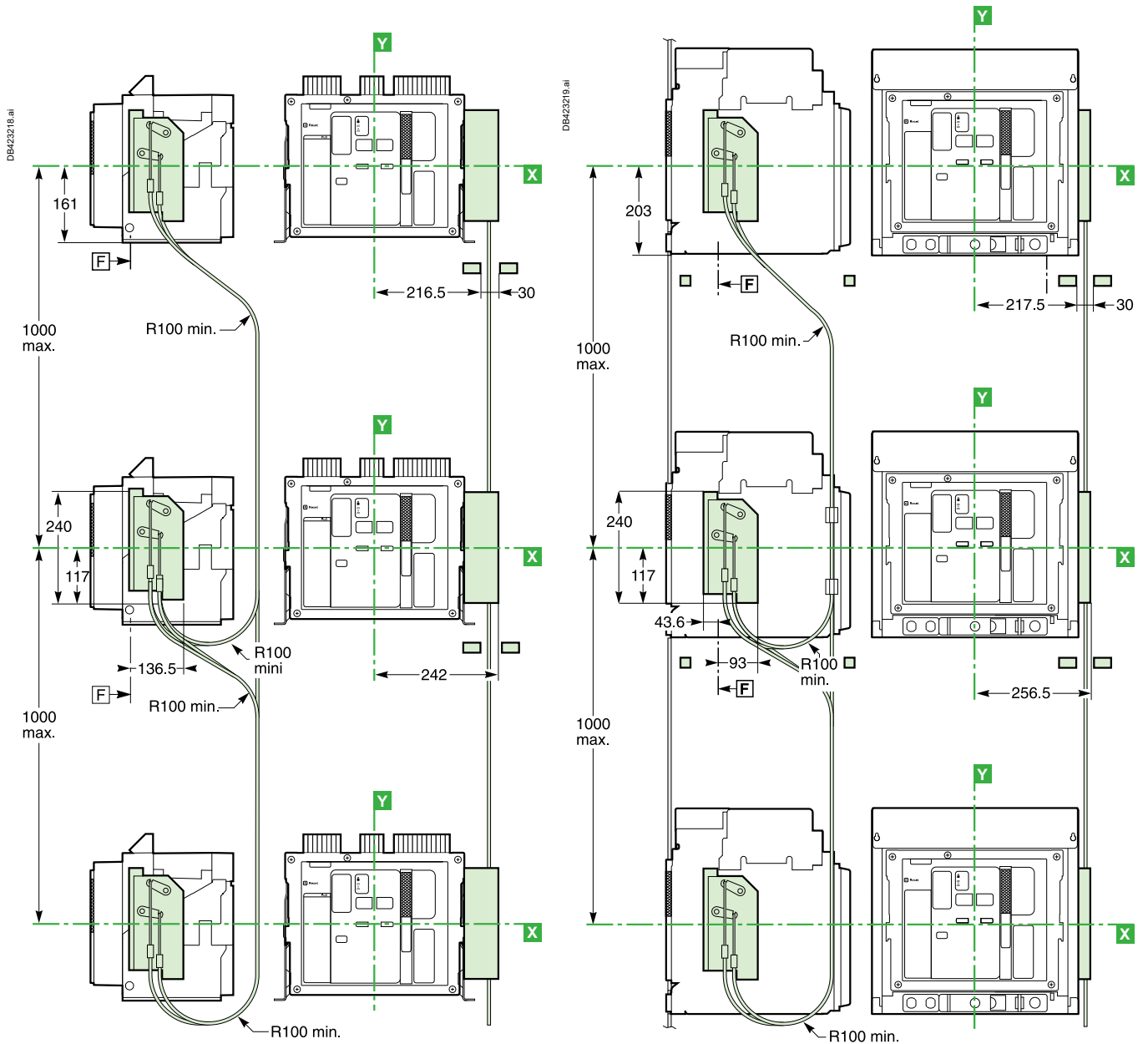

TransferPacT

IVE unit, UA/BA Controllers

IVE Unit

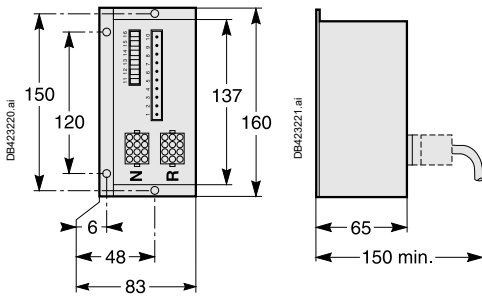

UA/BA Controllers

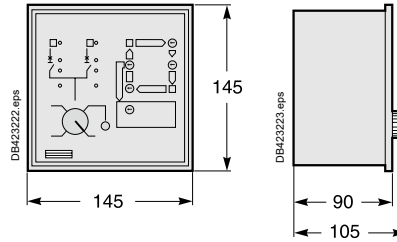

ACP Control Plate and UA/BA Controllers

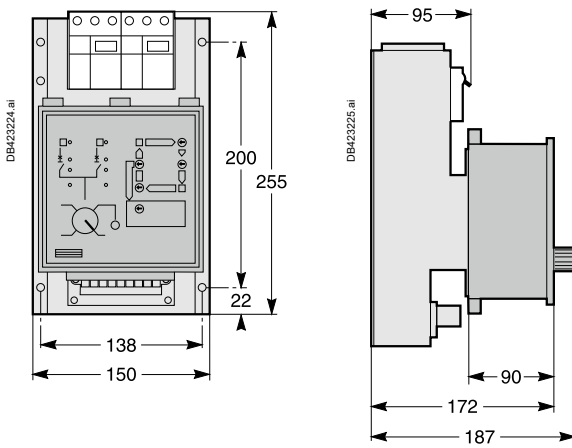

Door Cutout for UA/BA Controllers

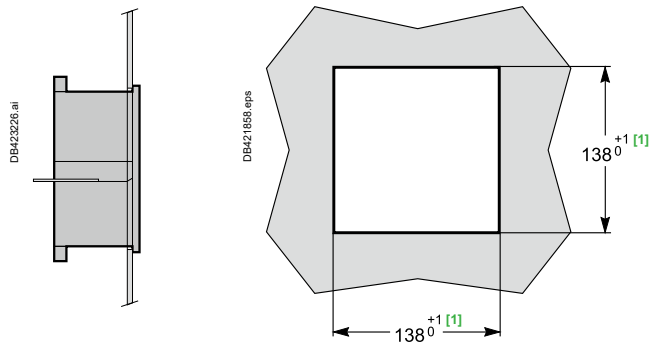

[1] Cutout according to DIN 43700 standard.

Standard Configurations

ComPacT NS, MasterPacT MTZ1 and MTZ2/MTZ3																																							
Types of Mechanical Interlocking	Possible Combinations	Typical Electrical Diagrams	Diagram No. Page																																				
2 devices																																							
	<table border="1"> <thead> <tr> <th>QN</th> <th>QR</th> </tr> </thead> <tbody> <tr> <td>0</td> <td>0</td> </tr> <tr> <td>1</td> <td>0</td> </tr> <tr> <td>0</td> <td>1</td> </tr> </tbody> </table>	QN	QR	0	0	1	0	0	1	<p>ComPacT NSX100 to 630:</p> <ul style="list-style-type: none"> ■ Electrical interlocking without emergency power off (EPO) auxiliaries: <table border="0"> <tr> <td style="padding-left: 20px;"><input type="checkbox"/> With EPO by MN</td> <td style="text-align: right;">51201177</td> <td style="text-align: right;">C-39</td> </tr> <tr> <td style="padding-left: 20px;"><input type="checkbox"/> With EPO by MX</td> <td style="text-align: right;">51201178</td> <td style="text-align: right;">C-40</td> </tr> <tr> <td style="padding-left: 20px;"><input type="checkbox"/> With EPO by MX</td> <td style="text-align: right;">51201179</td> <td style="text-align: right;">C-41</td> </tr> </table> <p>ComPacT NS630b to 1600:</p> <ul style="list-style-type: none"> ■ Electrical interlocking with lockout after fault: <table border="0"> <tr> <td style="padding-left: 20px;"><input type="checkbox"/> Permanent replacement source (with IVE)</td> <td style="text-align: right;">51201183</td> <td style="text-align: right;">C-42</td> </tr> <tr> <td style="padding-left: 20px;"><input type="checkbox"/> With emergency off by shunt release MX (with IVE)</td> <td style="text-align: right;">51201184</td> <td style="text-align: right;">C-43</td> </tr> <tr> <td style="padding-left: 20px;"><input type="checkbox"/> With emergency off by undervoltage release MN (with IVE)</td> <td style="text-align: right;">51201185</td> <td style="text-align: right;">C-44</td> </tr> </table> <p>MasterPacT MTZ1 and MTZ2/3:</p> <ul style="list-style-type: none"> ■ Electrical interlocking with lockout after fault: <table border="0"> <tr> <td style="padding-left: 20px;"><input type="checkbox"/> Permanent replacement source (with IVE)</td> <td style="text-align: right;">C-11</td> </tr> <tr> <td style="padding-left: 20px;"><input type="checkbox"/> With EPO by MX (with IVE)</td> <td style="text-align: right;">C-12</td> </tr> <tr> <td style="padding-left: 20px;"><input type="checkbox"/> With EPO by MN (with IVE)</td> <td style="text-align: right;">C-13</td> </tr> </table> ■ Automatic control with lockout after fault: <table border="0"> <tr> <td style="padding-left: 20px;"><input type="checkbox"/> permanent replacement source (with IVE)</td> <td style="text-align: right;">C-14</td> </tr> <tr> <td style="padding-left: 20px;"><input type="checkbox"/> engine generator set (with IVE)</td> <td style="text-align: right;">C-15</td> </tr> </table> 	<input type="checkbox"/> With EPO by MN	51201177	C-39	<input type="checkbox"/> With EPO by MX	51201178	C-40	<input type="checkbox"/> With EPO by MX	51201179	C-41	<input type="checkbox"/> Permanent replacement source (with IVE)	51201183	C-42	<input type="checkbox"/> With emergency off by shunt release MX (with IVE)	51201184	C-43	<input type="checkbox"/> With emergency off by undervoltage release MN (with IVE)	51201185	C-44	<input type="checkbox"/> Permanent replacement source (with IVE)	C-11	<input type="checkbox"/> With EPO by MX (with IVE)	C-12	<input type="checkbox"/> With EPO by MN (with IVE)	C-13	<input type="checkbox"/> permanent replacement source (with IVE)	C-14	<input type="checkbox"/> engine generator set (with IVE)	C-15	
	QN	QR																																					
	0	0																																					
	1	0																																					
0	1																																						
<input type="checkbox"/> With EPO by MN	51201177	C-39																																					
<input type="checkbox"/> With EPO by MX	51201178	C-40																																					
<input type="checkbox"/> With EPO by MX	51201179	C-41																																					
<input type="checkbox"/> Permanent replacement source (with IVE)	51201183	C-42																																					
<input type="checkbox"/> With emergency off by shunt release MX (with IVE)	51201184	C-43																																					
<input type="checkbox"/> With emergency off by undervoltage release MN (with IVE)	51201185	C-44																																					
<input type="checkbox"/> Permanent replacement source (with IVE)	C-11																																						
<input type="checkbox"/> With EPO by MX (with IVE)	C-12																																						
<input type="checkbox"/> With EPO by MN (with IVE)	C-13																																						
<input type="checkbox"/> permanent replacement source (with IVE)	C-14																																						
<input type="checkbox"/> engine generator set (with IVE)	C-15																																						



Standard Configurations

MasterPacT MTZ2/MTZ3 Only																								
Types of mechanical interlocking	Possible combinations	Typical electrical diagrams	Page																					
3 devices: 2 "Normal" sources and 1 "Replacement" source																								
<p>DB421859.eps</p>	<table border="1"> <thead> <tr> <th>QN1</th> <th>QN2</th> <th>QR</th> </tr> </thead> <tbody> <tr> <td>0</td> <td>0</td> <td>0</td> </tr> <tr> <td>1</td> <td>1</td> <td>0</td> </tr> <tr> <td>0</td> <td>0</td> <td>1</td> </tr> </tbody> </table>	QN1	QN2	QR	0	0	0	1	1	0	0	0	1	<ul style="list-style-type: none"> ■ Electrical interlocking: <ul style="list-style-type: none"> <input type="checkbox"/> Without lockout after fault <input type="checkbox"/> With lockout after fault 	<p>C-19</p> <p>C-20</p>									
	QN1	QN2	QR																					
	0	0	0																					
	1	1	0																					
0	0	1																						
3 devices: 2 "Normal" sources and 1 "Replacement" source with source selection																								
<p>DB421860.eps</p>	<table border="1"> <thead> <tr> <th>QN1</th> <th>QN2</th> <th>QR</th> </tr> </thead> <tbody> <tr> <td>0</td> <td>0</td> <td>0</td> </tr> <tr> <td>1</td> <td>0</td> <td>0</td> </tr> <tr> <td>0</td> <td>0</td> <td>1</td> </tr> <tr> <td>1</td> <td>1</td> <td>0</td> </tr> <tr> <td>0</td> <td>1</td> <td>0</td> </tr> </tbody> </table>	QN1	QN2	QR	0	0	0	1	0	0	0	0	1	1	1	0	0	1	0	<ul style="list-style-type: none"> ■ Automatic control with engine generator set: <ul style="list-style-type: none"> <input type="checkbox"/> Without lockout after fault (with MN) <input type="checkbox"/> With lockout after fault (with MN) 	<p>C-21</p> <p>C-22</p>			
	QN1	QN2	QR																					
	0	0	0																					
	1	0	0																					
	0	0	1																					
1	1	0																						
0	1	0																						
3 devices: 3 sources, only one device																								
<p>DB421861.eps</p>	<table border="1"> <thead> <tr> <th>QS1</th> <th>QS2</th> <th>QS3</th> </tr> </thead> <tbody> <tr> <td>0</td> <td>0</td> <td>0</td> </tr> <tr> <td>1</td> <td>0</td> <td>0</td> </tr> <tr> <td>0</td> <td>1</td> <td>0</td> </tr> <tr> <td>0</td> <td>0</td> <td>1</td> </tr> </tbody> </table>	QS1	QS2	QS3	0	0	0	1	0	0	0	1	0	0	0	1	<ul style="list-style-type: none"> ■ Electrical interlocking: <ul style="list-style-type: none"> <input type="checkbox"/> Without lockout after fault <input type="checkbox"/> With lockout after fault 	<p>C-23</p> <p>C-24</p>						
	QS1	QS2	QS3																					
	0	0	0																					
	1	0	0																					
0	1	0																						
0	0	1																						
3 devices: 2 sources + 1 coupling																								
<p>DB421862.eps</p>	<table border="1"> <thead> <tr> <th>QS1</th> <th>QC</th> <th>QS2</th> </tr> </thead> <tbody> <tr> <td>0</td> <td>0</td> <td>0</td> </tr> <tr> <td>1</td> <td>0</td> <td>1</td> </tr> <tr> <td>1</td> <td>1</td> <td>0</td> </tr> <tr> <td>0</td> <td>1</td> <td>1</td> </tr> <tr> <td>1</td> <td>0</td> <td>0</td> </tr> <tr> <td>0</td> <td>0</td> <td>1</td> </tr> </tbody> </table>	QS1	QC	QS2	0	0	0	1	0	1	1	1	0	0	1	1	1	0	0	0	0	1	<ul style="list-style-type: none"> ■ Electrical interlocking: <ul style="list-style-type: none"> <input type="checkbox"/> Without lockout after fault <input type="checkbox"/> With lockout after fault ■ Automatic control with lockout after fault 	<p>C-25</p> <p>C-26</p> <p>C-27</p>
	QS1	QC	QS2																					
	0	0	0																					
	1	0	1																					
	1	1	0																					
	0	1	1																					
1	0	0																						
0	0	1																						
<p>[1] possible by forcing operation</p>																								

"Lockout after fault" option. This option makes it necessary to manually reset the device following fault tripping.

Remote-Operated Source-Changeover Systems

2 ComPacT NSX100/630, NS630b/1600

or MasterPacT MTZ1/MTZ2/MTZ3 Devices

Electrical Interlocking By The Ive Unit

Independent order to Normal/Replacement source

Simultaneous order to Normal/Replacement source

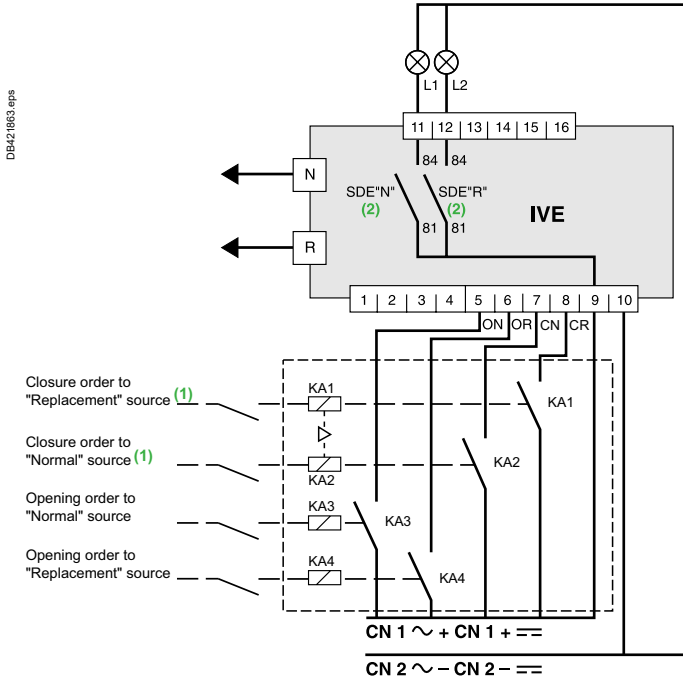

Controlling each circuit breaker independently.

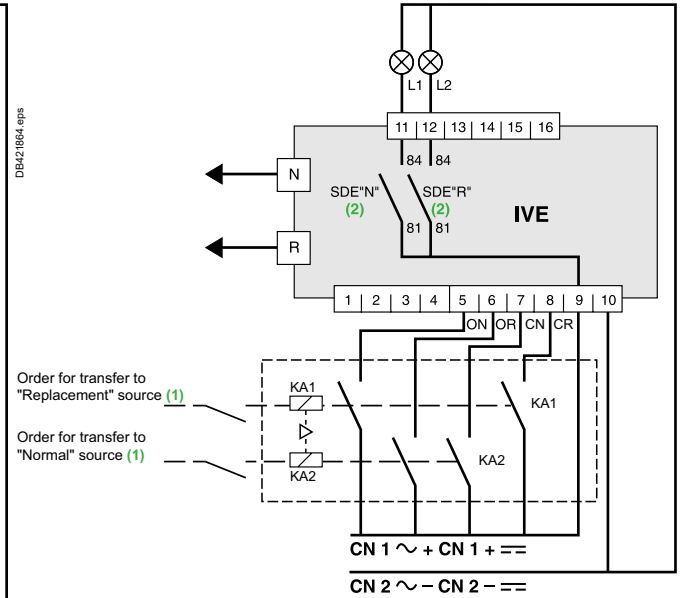

Control of two circuit breakers by "common" transfer order.

[1] See section "IMPORTANT" here after.

[2] Operating diagram: the SDE "fault-trip" signals are transmitted to the IVE unit. The SDE auxiliary contacts are mounted in the circuit breakers.

IMPORTANT

The relays controlling the closing order to the "Normal" and "Replacement" circuit breakers must be mechanically and/or electrically interlocked to prevent them from giving simultaneous closing commands.

It is recommended to use **Tesys K** relays from Schneider Electric reference LC2-K06010●●. These relays are mechanically and electrically interlocked.

Legends

- ON "Normal" source opening order
- OR "Replacement" source opening order
- CN "Normal" source closing order
- CR "Replacement" source closing order
- KA1 auxiliary relay
- KA2 auxiliary relay
- KA3 auxiliary relay
- KA4 auxiliary relay
- L1 "Normal" source "fault-trip" signal
- L2 "Replacement" source "fault-trip" signal
- N "Normal" source auxiliary wiring connector
- R "Replacement" source auxiliary wiring connector

Note: diagram shown with circuits de-energized, circuit breakers open and relays in normal position.



Remote-Operated Source-Changeover Systems

2 ComPacT NSX100/630 Devices

Diagram no. 51201177

Source-Changeover System Without Automatic-Control System

Without auxiliaries for emergency off

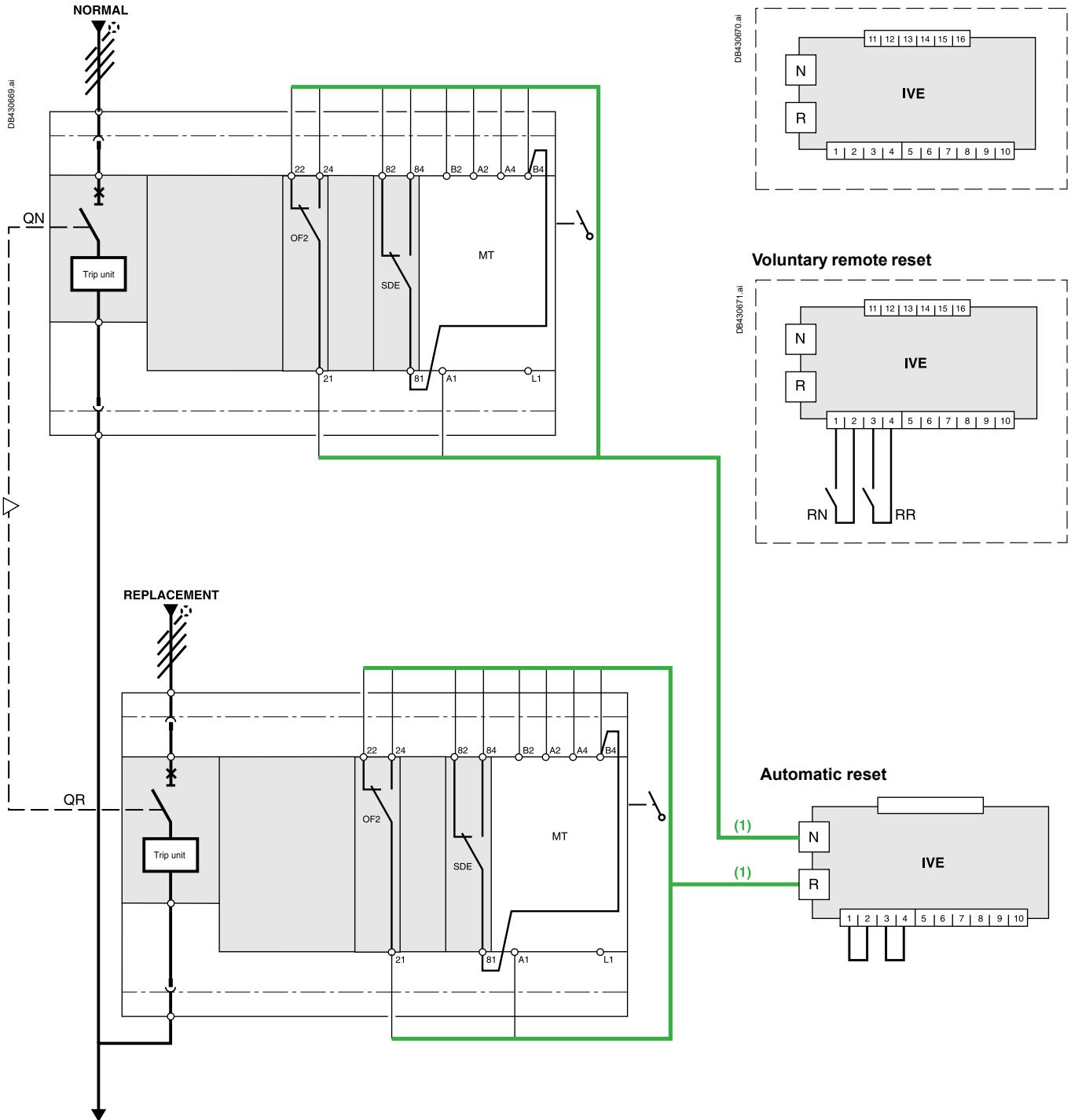

Local reset

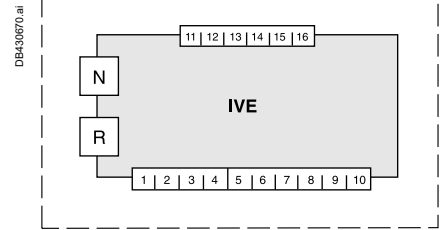

Voluntary remote reset

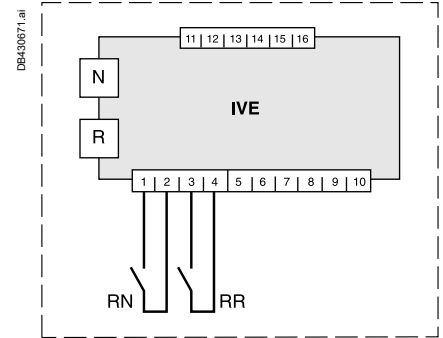

Automatic reset

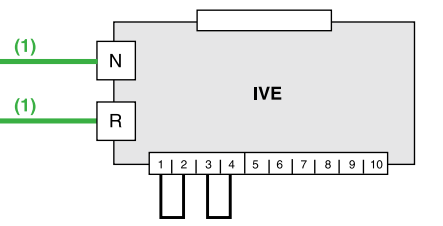

Legends

- QN "Normal" source ComPacT NSX equipped with motor mechanism
- QR "Replacement" source ComPacT NSX equipped with motor mechanism
- SDE "fault-trip" indication contact
- IVE electrical interlocking and terminal block unit
- MT motor mechanism
- OF2 breaker ON/OFF indication contact
- RN reset order for breaker QN
- RR reset order for breaker QR

[1] Prefabricated wiring: cannot be modified.

States permitted by mechanical interlocking system

Normal	Replacement
0	0
1	0
0	1

Note: diagram shown with circuits de-energized, circuit breakers open and relays in normal position.

Remote-Operated Source-Changeover Systems

2 ComPacT NSX100/630 Devices

Diagram no. 51201178

Source-Changeover System without Automatic-Control System

With emergency off by MN release and automatic reset

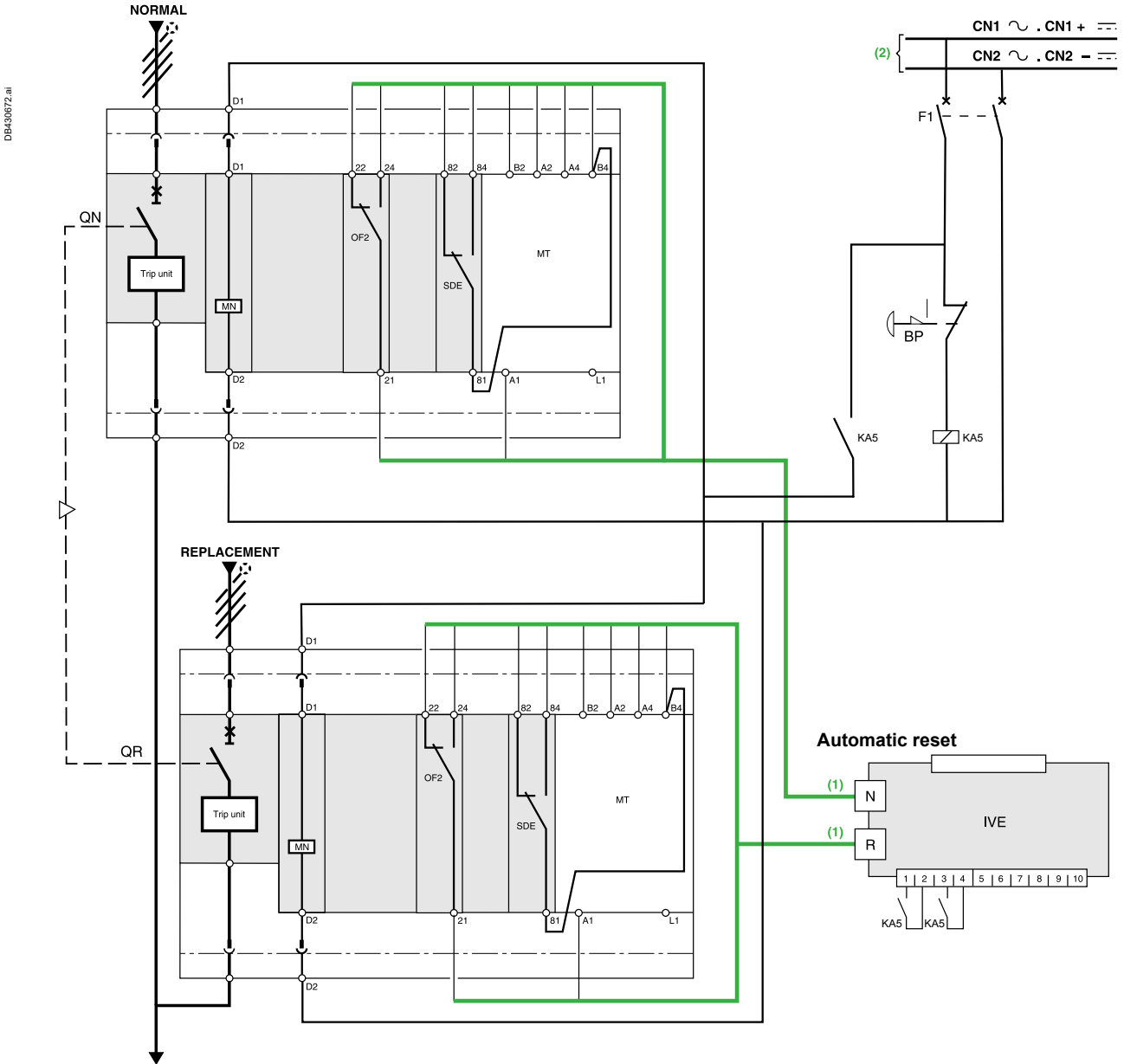

- [1] Prefabricated wiring supplied.
- [2] Independent auxiliary source.

Legends

- Q1 "Normal" source ComPacT NSX equipped with motormechanism
- Q2 "Replacement" source ComPacT NSX equipped with motor mechanism
- MN undervoltage release
- OF2 breaker ON/OFF indication contact
- SDE "fault-trip" indication contact
- MT motor mechanism
- IVE electrical interlocking and terminal block unit
- BP emergency off button with latching
- KA5 auxiliary relay
- F1 auxiliary power supply circuit breaker

States permitted by mechanical interlocking system

Normal	Replacement
0	0
1	0
0	1

Note: after a fault trip, the breaker must be reset manually by pressing its reset button. Diagram shown with circuits de-energized, circuit breakers open and relays in normal position.



Remote-Operated Source-Changeover Systems

2 ComPacT NSX100/630 Devices

Diagram no. 51201179

Source-Changeover System without Automatic-Control System

With emergency off by MX release and automatic reset

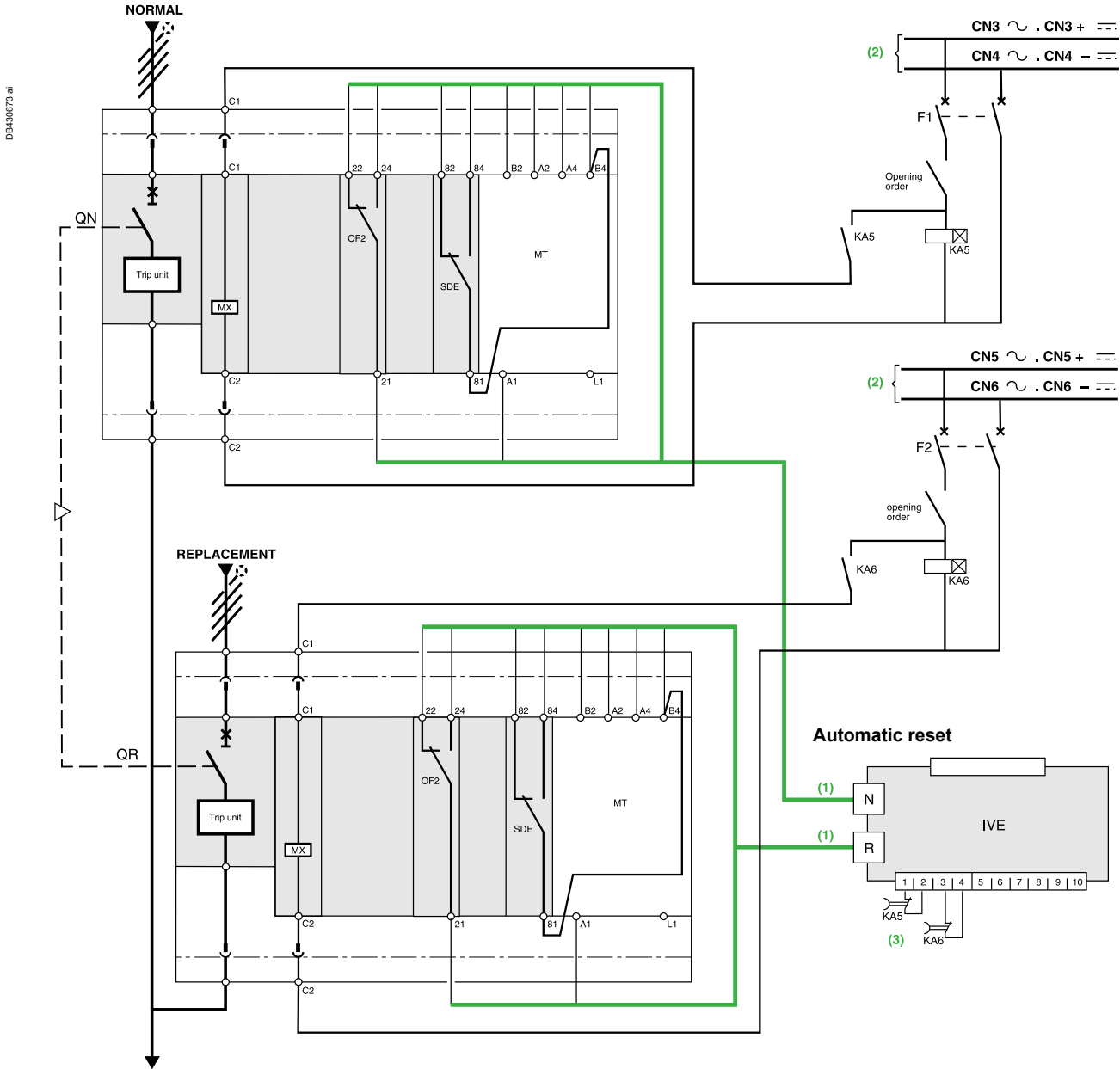

Legends

- Q.N. "Normal" source ComPacT NSX equipped with motor mechanism
- Q.R. "Replacement" source ComPacT NSX equipped with motor mechanism
- SDE "fault-trip" indication contact
- OF2 breaker ON/OFF indication contact
- MX shunt release
- MT motor mechanism
- IVE electrical interlocking and terminal block unit
- KA5 time-delayed auxiliary relays
- KA6 time-delayed auxiliary relays
- F1 auxiliary power supply circuit breaker
- F2 auxiliary power supply circuit breaker

- [1] Prefabricated wiring supplied
- [2] This source can be:
 - the source present in the case of voltage monitoring
 - an independent source.
 In this case, the MX release must be protected.
- [3] The reset orders must be delayed by 0.3 seconds.

States permitted by mechanical interlocking system

Normal	Replacement
0	0
1	0
0	1

Note: after a fault trip, the breaker must be reset manually by pressing its reset button. Diagram shown with circuits de-energized, circuit breakers open and relays in normal position.

Remote-Operated Source-Changeover Systems

2 ComPacT NS630b/1600 Devices

Diagram no. 51201183

Electrical Interlocking by IVE Unit

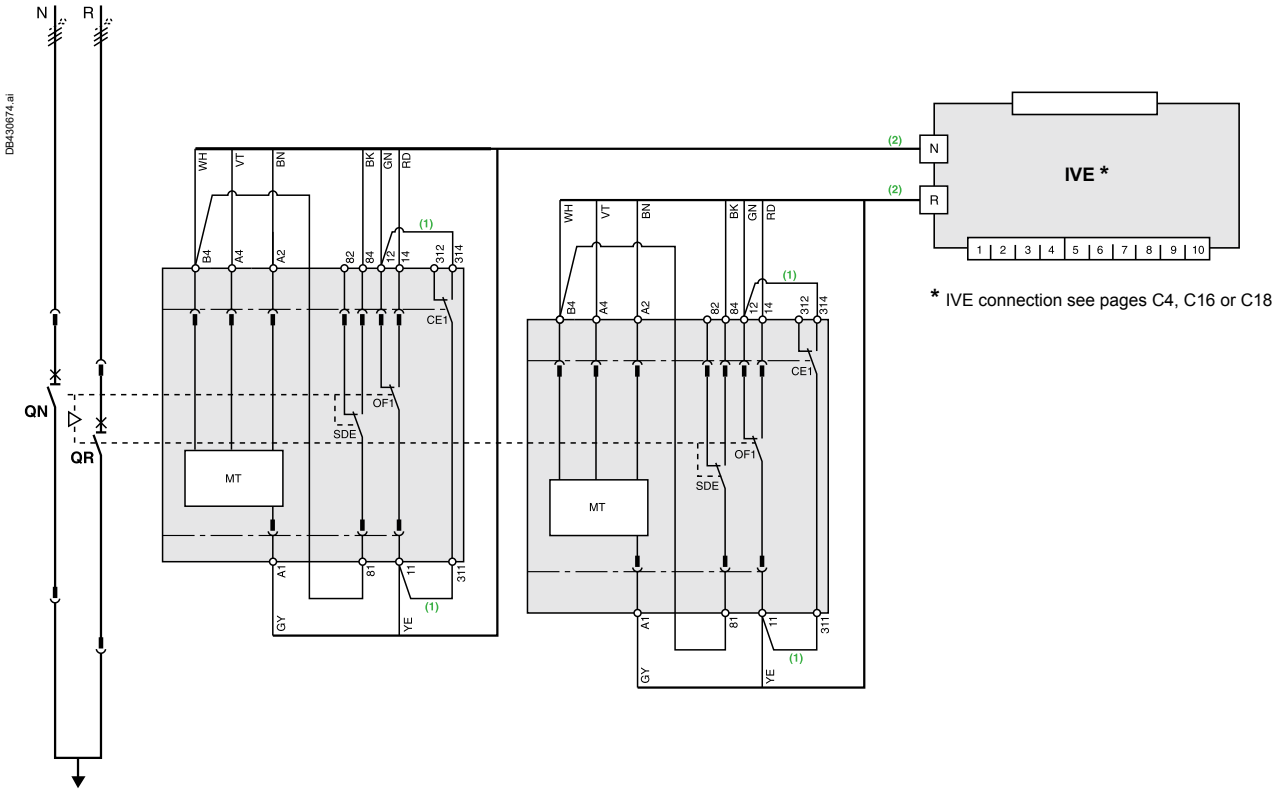

* IVE connection see pages C4, C16 or C18

ATTENTION

The diagram shows the electrical wiring for circuit breakers. When wiring the SDE with **switch-disconnectors**, connect wire BK to terminal 82.

- [1] Not to be wired on fixed version.
- [2] Prefabricated wiring supplied.

Legends

- QN "Normal" source ComPacT NS630b to 1600
- QR "Replacement" source ComPacT NS630b to 1600
- OF... breaker ON/OFF indication contact
- SDE "fault-trip" indication contact
- CE1 "connected-position" indication contact (carriage switch)
- F1 auxiliary power supply circuit breaker
- IVE electrical interlocking and terminal block unit
- ON "Normal" source opening order
- OR "Replacement" source opening order
- CN "Normal" source closing order (0.25 second delay)
- CR "Replacement" source closing order (0.25 second delay)
- MT Motor Mechanism

Wiring colour codes							
RD	GN	BK	VT	YE	GY	WH	BN
red	green	black	violet	yellow	grey	white	brown

States permitted by mechanical interlocking system

Normal	Replacement
0	0
1	0
0	1

Note: after a fault trip, the breaker must be reset manually by pressing its reset button.
 Diagram shown with circuit breakers in connected position, open, charged, and ready to close.
 Auxiliary power supply = supply voltage of auxiliary relays (KA...) = supply voltage of electrical auxiliaries (electrical operation, MT...).



Remote-Operated Source-Changeover Systems

2 ComPacT NS630b/1600 Devices

Diagram no. 51201184

Electrical Interlocking by IVE Unit with Emergency Off by Shunt Release

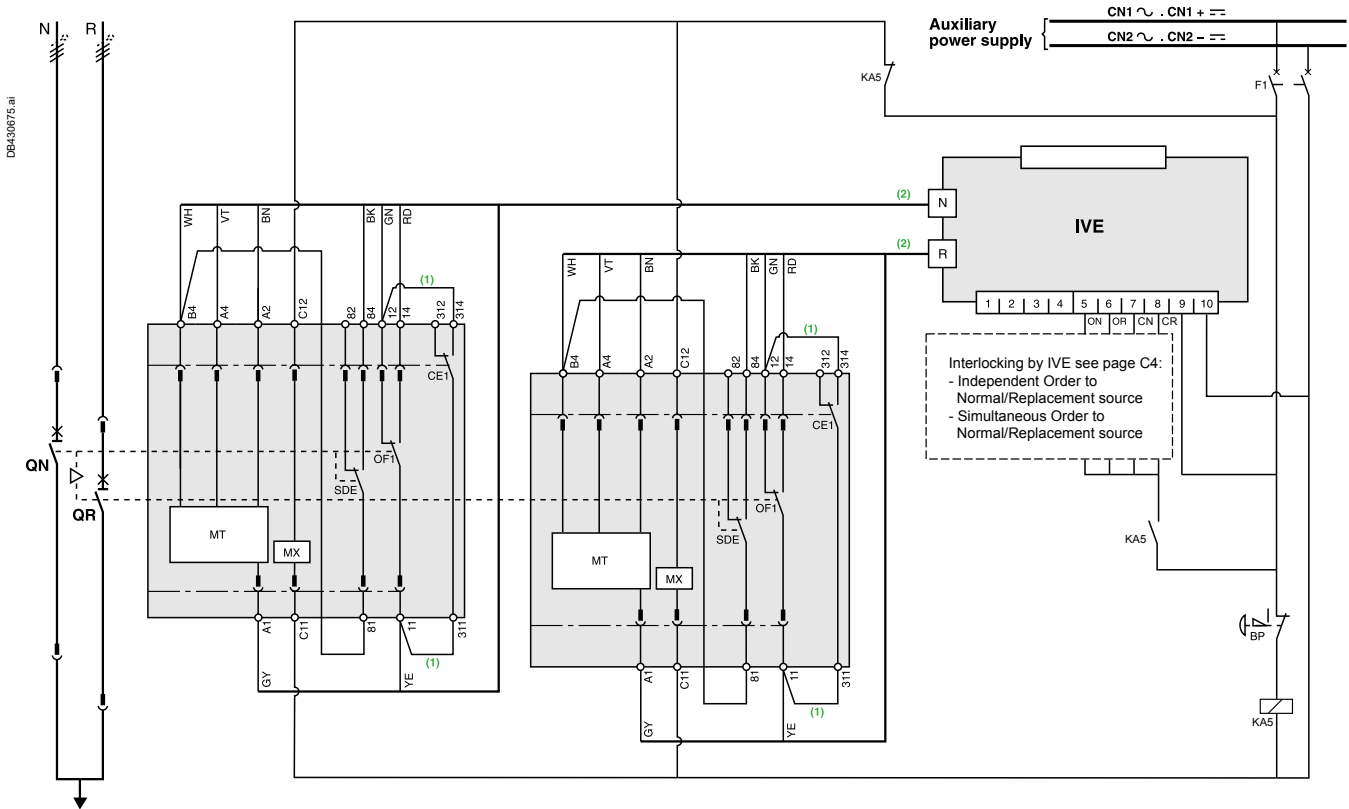

ATTENTION

The diagram shows the electrical wiring for circuit breakers. When wiring the SDE with switch-disconnectors, connect wire BK to terminal 82.

[1] Not to be wired on fixed version.
 [2] Prefabricated wiring supplied.

Legends

- QN "Normal" source ComPacT NS630b to 1600
- QR "Replacement" source ComPacT NS630b to 1600
- OF... breaker ON/OFF indication contact
- SDE "fault-trip" indication contact
- CE1 "connected-position" indication contact (carriage switch)
- F1 auxiliary power supply circuit breaker
- IVE electrical interlocking and terminal block unit
- MX shunt release
- BP emergency off button with latching
- KA5 auxiliary relay
- ON "Normal" source opening order
- OR "Replacement" source opening order
- CN "Normal" source closing order (0.25 second delay)
- CR "Replacement" source closing order (0.25 second delay)
- MT Motor Mechanism

Wiring colour codes

RD	GN	BK	VT	YE	GY	WH	BN
red	green	black	violet	yellow	grey	white	brown

States permitted by mechanical interlocking system

Normal	Replacement
0	0
1	0
0	1

Note: after a fault trip, the breaker must be reset manually by pressing its reset button. Diagram shown with circuit breakers in connected position, open, charged, and ready to close. Auxiliary power supply = supply voltage of auxiliary relays (KA...) = supply voltage of electrical auxiliaries (electrical operation, MX, MT...).

Remote-Operated Source-Changeover Systems

2 ComPacT NS630b/1600 Devices

Diagram no. 51201185

Electrical Interlocking by IVE Unit with Emergency off by Undervoltage Release

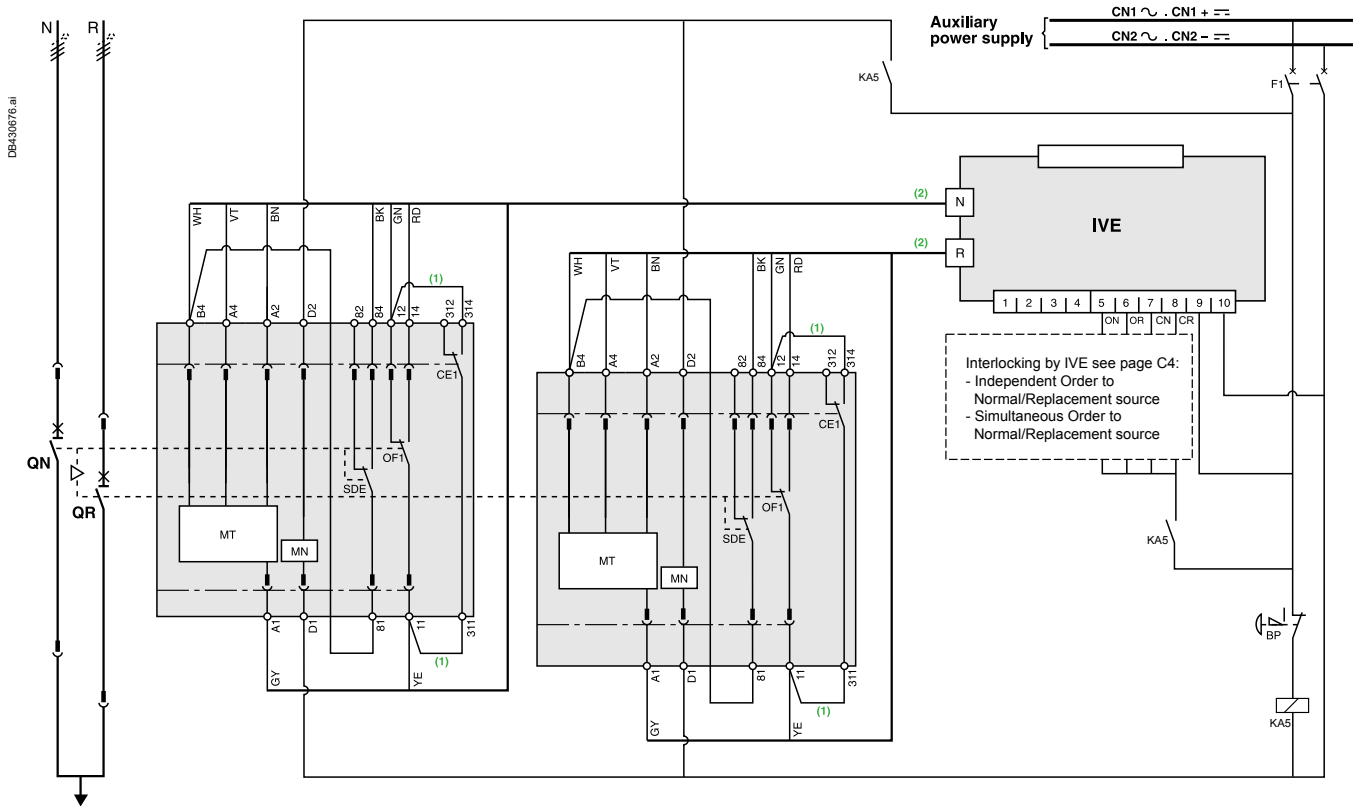

ATTENTION

The diagram shows the electrical wiring for circuit breakers. When wiring the SDE with **switch-disconnectors**, connect wire **BK** to terminal **82**.

- [1] Not to be wired on fixed version.
- [2] Prefabricated wiring supplied.

Legends

- QN "Normal" source ComPacT NS630b to 1600
- QR "Replacement" source ComPacT NS630b to 1600
- OF... breaker ON/OFF indication contact
- SDE "fault-trip" indication contact
- CE1 "connected-position" indication contact (carriage switch)
- F1 auxiliary power supply circuit breaker
- IVE electrical interlocking and terminal block unit
- MN undervoltage release
- BP emergency off button with latching
- KA5 auxiliary relay
- ON "Normal" source opening order
- OR "Replacement" source opening order
- CN "Normal" source closing order (0.25 second delay)
- CR "Replacement" source closing order (0.25 second delay)
- MT Motor Mechanism

Wiring colour codes

RD	GN	BK	VT	YE	GY	WH	BN
red	green	black	violet	yellow	grey	white	brown

States permitted by mechanical interlocking system

Normal	Replacement
0	0
1	0
0	1

Note: after a fault trip, the breaker must be reset manually by pressing its reset button.
 Diagram shown with circuit breakers in connected position, open, charged, and ready to close.
 Auxiliary power supply = supply voltage of auxiliary relays (KA...) = supply voltage of electrical auxiliaries (electrical operation, MN, MT...).

Remote-Operated Source-Changeover Systems

2 MasterPacT MTZ1 or MTZ2/MTZ3 Devices

Electrical interlocking by IVE unit with lockout after a fault

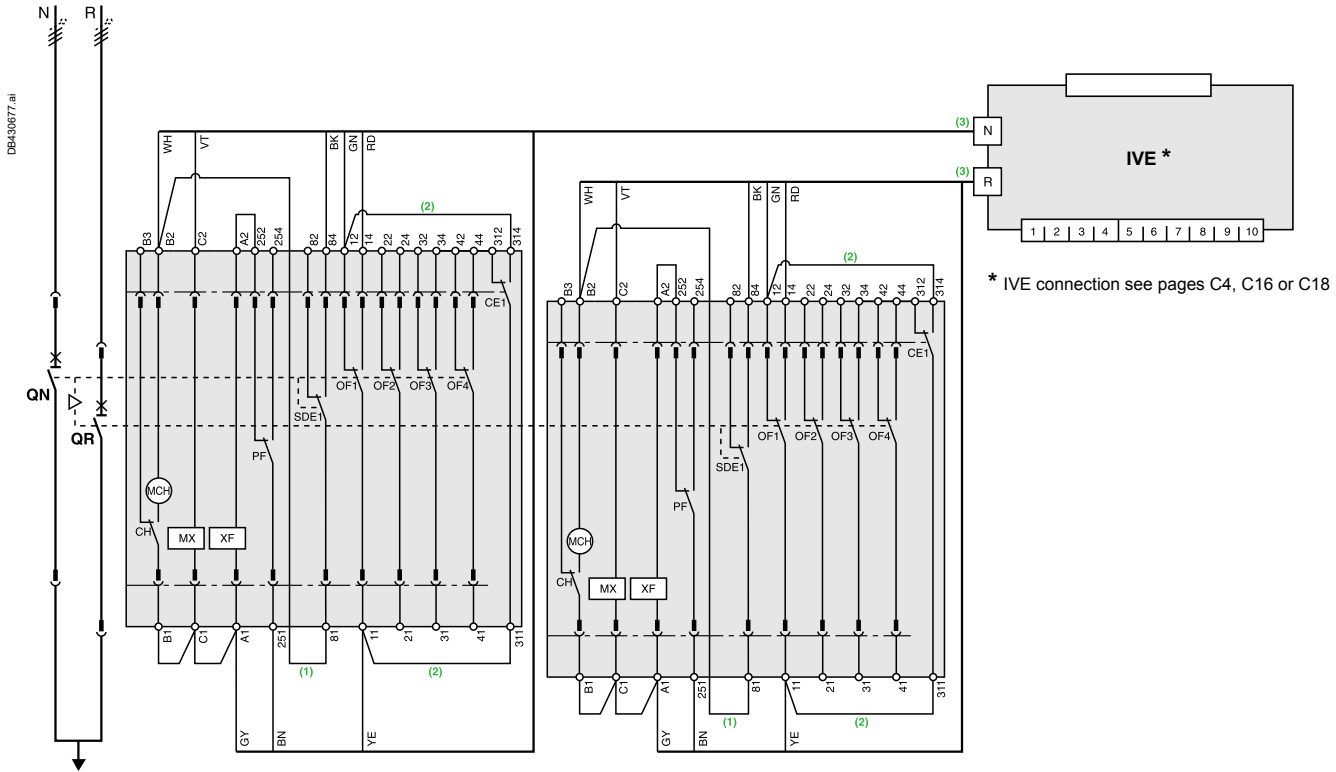

ATTENTION

The diagram shows the electrical wiring for circuit breakers. When wiring the SDE with **switch-disconnectors**, connect wire BK to terminal 82.

- [1] Not to be wired for the “without lockout after a fault” solution.
- [2] Not to be wired on fixed version.
- [3] Prefabricated wiring supplied.

Legends

- QN “Normal” source MasterPacT MTZ1 or MTZ2 or MTZ3
- QR “Replacement” source MasterPacT MTZ1 or MTZ2 or MTZ3
- MCH spring-charging motor
- MX standard opening voltage release
- XF standard closing voltage release
- OF... breaker ON/OFF indication contact
- SDE1 “fault-trip” indication contact
- PF “ready-to-close” contact
- CE1 “connected-position” indication contact (carriage switch)
- CH “springs charged” indication contact
- IVE electrical interlocking and terminal block unit
- F1 auxiliary power supply circuit breaker
- ON “Normal” source opening order
- OR “Replacement” source opening order
- CN “Normal” source closing order (0.25 second delay)
- CR “Replacement” source closing order (0.25 second delay)

Wiring colour codes

RD	GN	BK	VT	YE	GY	WH	BN
red	green	black	violet	yellow	grey	white	brown

States permitted by mechanical interlocking system

Normal	Replacement
0	0
1	0
0	1

Note: diagram shown with circuit breakers in connected position, open, charged, and ready to close. Auxiliary power supply = supply voltage of auxiliary relays (KA...) = supply voltage of electrical auxiliaries (electrical operation, MCH, MX, XF...).

Remote-Operated Source-Changeover Systems

2 MasterPacT MTZ1 or MTZ2 or MTZ3 Devices

Electrical interlocking by IVE unit with lockout after a fault and emergency off by shunt release

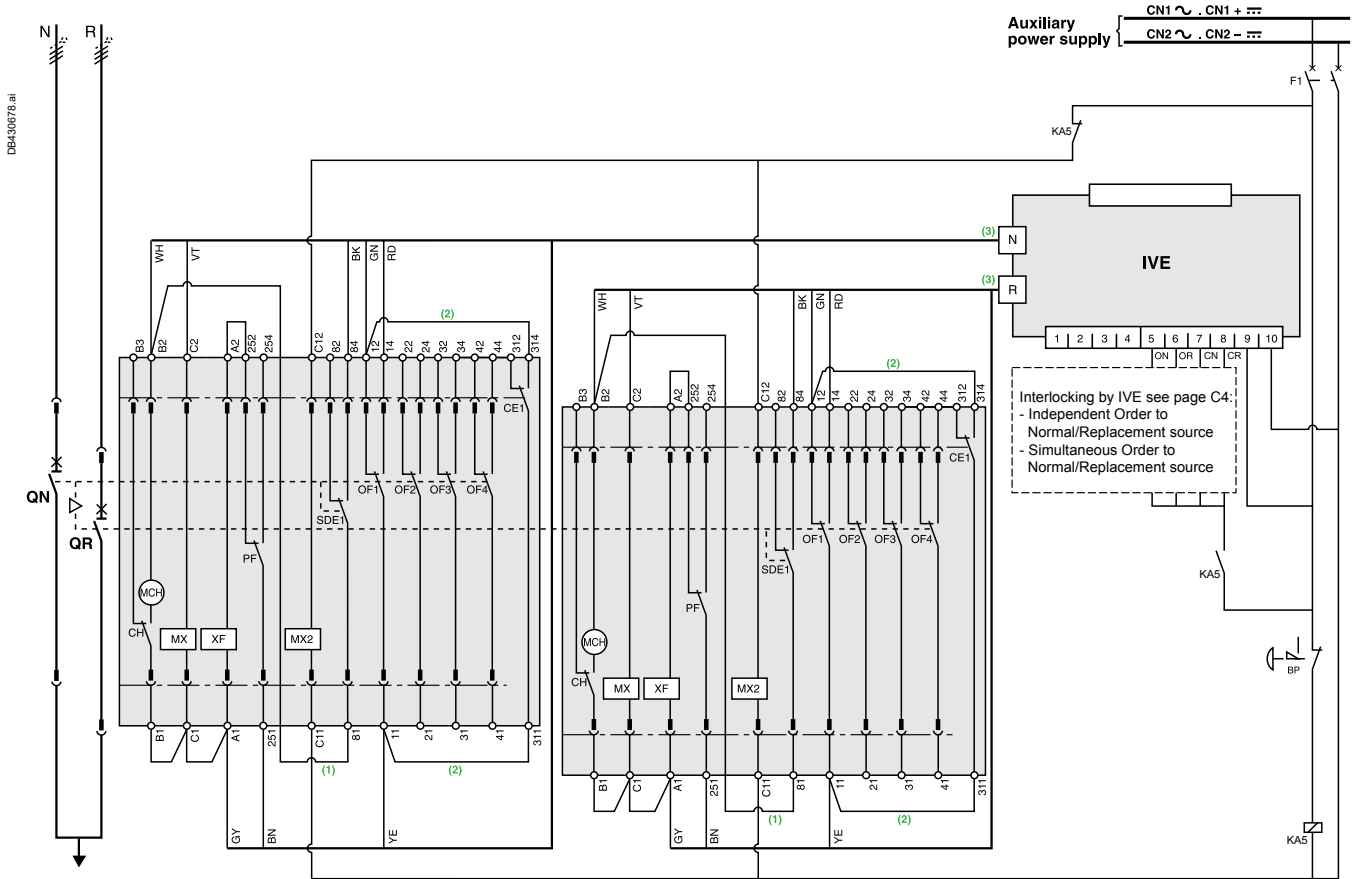

ATTENTION

The diagram shows the electrical wiring for circuit breakers. When wiring the SDE with **switch-disconnectors**, connect wire BK to terminal 82.

- [1] Not to be wired for the "without lockout after a fault" solution.
- [2] Not to be wired on fixed version.
- [3] Prefabricated wiring supplied.

Legends

- QN "Normal" source MasterPacT MTZ1 or MTZ2 or MTZ3
- QR "Replacement" source MasterPacT MTZ1 or MTZ2 or MTZ3
- MCH spring-charging motor
- MX standard opening voltage release
- XF standard closing voltage release
- OF... breaker ON/OFF indication contact
- SDE1 "fault-trip" indication contact
- PF "ready-to-close" contact
- CE1 "connected-position" indication contact (carriage switch)
- CH "springs charged" indication contact
- IVE electrical interlocking and terminal block unit
- KA5 auxiliary relay
- F1 auxiliary power supply circuit breaker
- BP emergency off button with latching
- ON "Normal" source opening order
- OR "Replacement" source opening order
- CN "Normal" source closing order (0.25 second delay)
- CR "Replacement" source closing order (0.25 second delay)

Wiring colour codes

RD	GN	BK	VT	YE	GY	WH	BN
red	green	black	violet	yellow	grey	white	brown

States permitted by mechanical interlocking system

Normal	Replacement
0	0
1	0
0	1

Note: diagram shown with circuit breakers in connected position, open, charged, and ready to close. Auxiliary power supply = supply voltage of auxiliary relays (KA...) = supply voltage of electrical auxiliaries (electrical operation, MCH, MX, XF...).



Remote-Operated Source-Changeover Systems

2 MasterPacT MTZ1 or MTZ2 or MTZ3 Devices

Electrical Interlocking by IVE Unit with Lockout after A Fault and Emergency off by Undervoltage Release

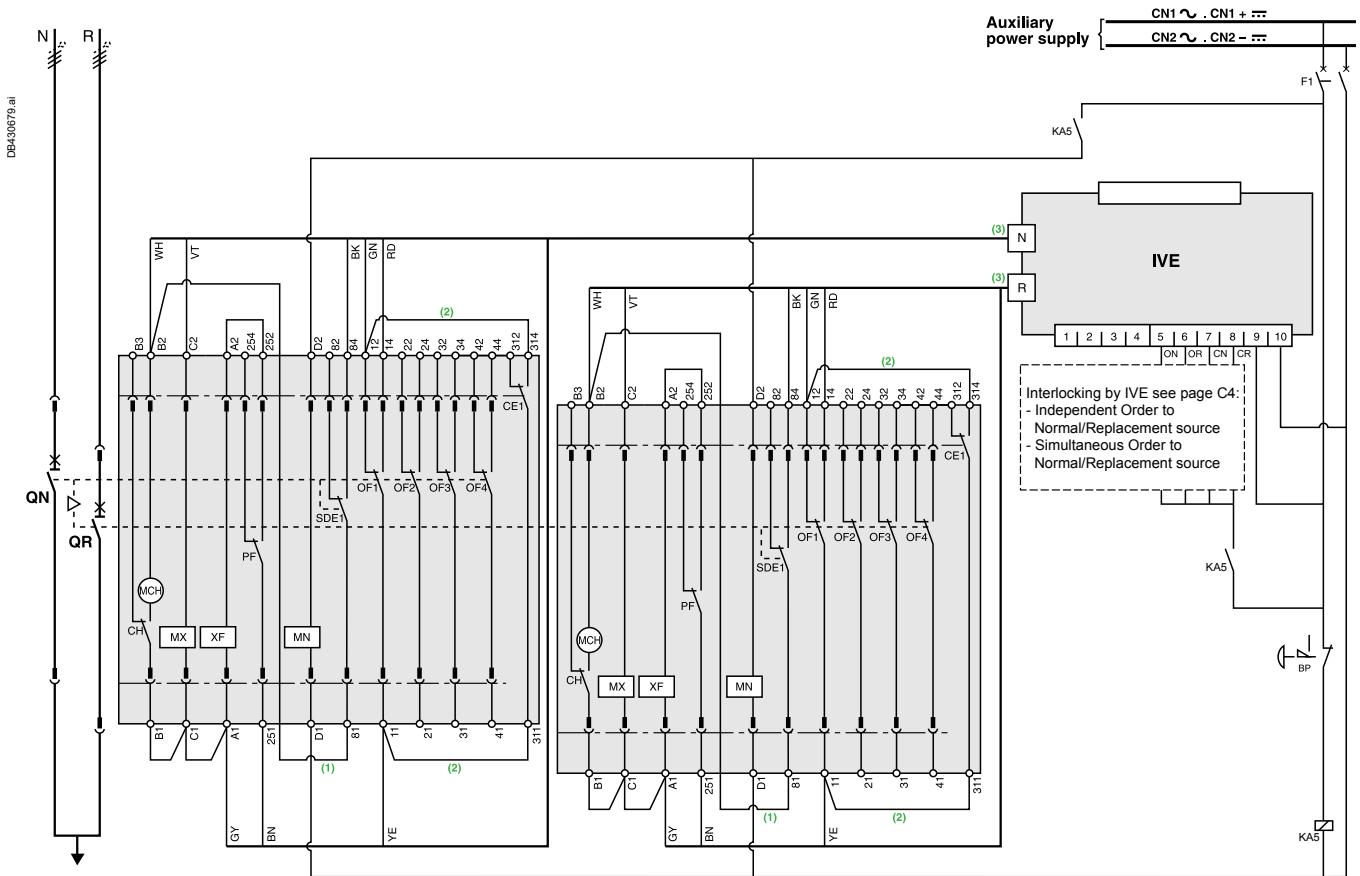

ATTENTION

The diagram shows the electrical wiring for circuit breakers. When wiring the SDE with switch-disconnectors, connect wire BK to terminal 82.

- [1] Not to be wired for the "without lockout after a fault" solution.
- [2] Not to be wired on fixed version.
- [3] Prefabricated wiring supplied.

Legends

- QN "Normal" source MasterPacT MTZ1 or MTZ2 or MTZ3
- QR "Replacement" source MasterPacT MTZ1 or MTZ2 or MTZ3
- MCH spring-charging motor
- MX standard opening voltage release
- XF standard closing voltage release
- MN undervoltage release
- OF... breaker ON/OFF indication contact
- SDE1 "fault-trip" indication contact
- PF "ready-to-close" contact
- CE1 "connected-position" indication contact (carriage switch)
- CH "springs charged" indication contact
- IVE electrical interlocking and terminal block unit
- KA5 auxiliary relay
- F1 auxiliary power supply circuit breaker
- BP emergency off button with latching
- ON "Normal" source opening order
- OR "Replacement" source opening order
- CN "Normal" source closing order (0.25 second delay)
- CR "Replacement" source closing order (0.25 second delay)

Wiring colour codes

RD	GN	BK	VT	YE	GY	WH	BN
red	green	black	violet	yellow	grey	white	brown

States permitted by mechanical interlocking system

Normal	Replacement
0	0
1	0
0	1

Note: diagram shown with circuit breakers in connected position, open, charged, and ready to close. Auxiliary power supply = supply voltage of auxiliary relays (KA...) = supply voltage of electrical auxiliaries (electrical operation, MCH, MX, MN, XF...).

Remote-Operated Source-Changeover Systems

2 MasterPacT MTZ1 or MTZ2 or MTZ3 Devices

Automatic-Control System for Permanent Replacement Source with Lockout after A Fault (with MN)

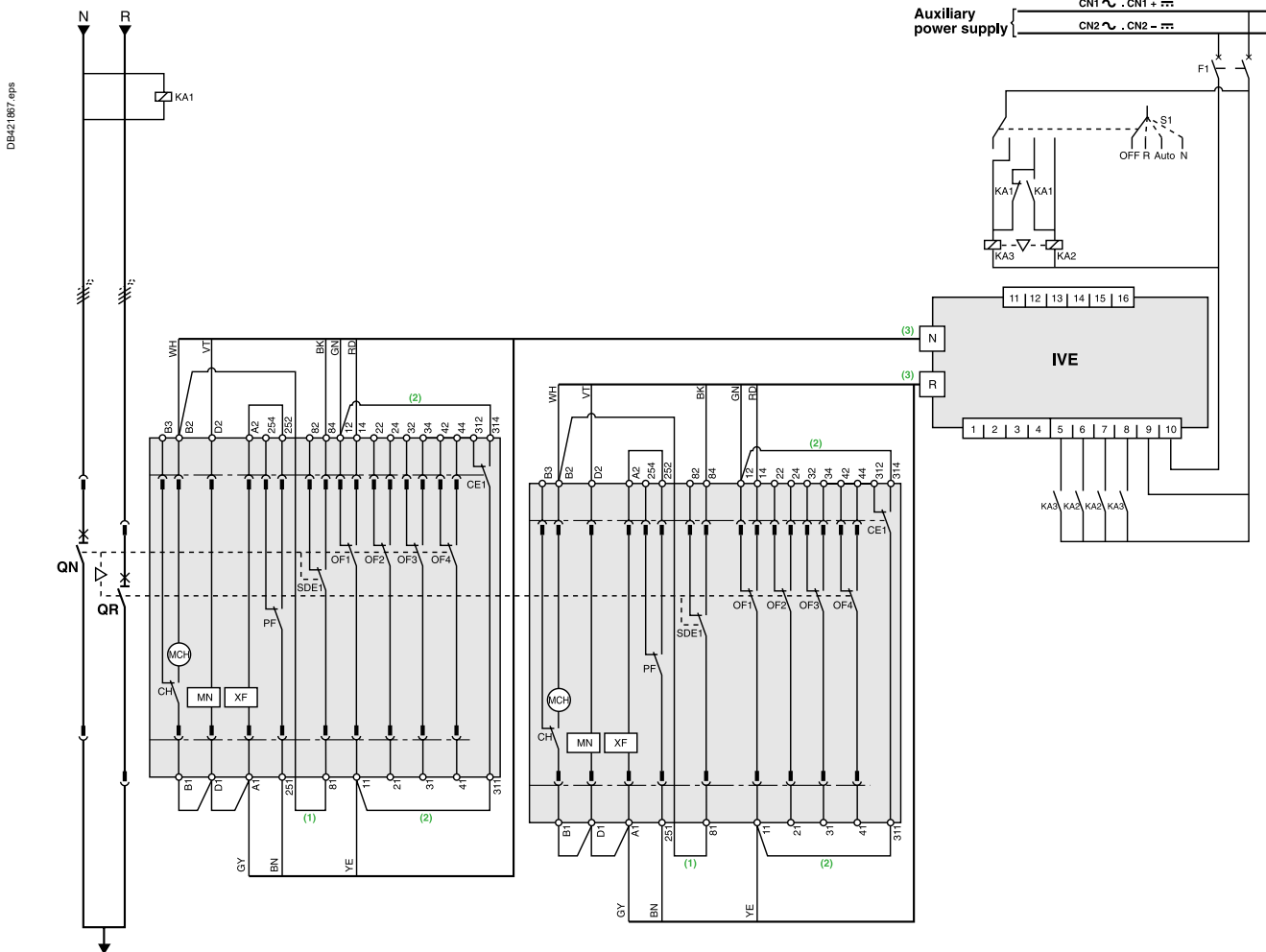

ATTENTION

The diagram shows the electrical wiring for circuit breakers. When wiring the SDE with **switch-disconnectors**, connect wire **BK** to terminal **82**.

- [1] Not to be wired for the "without lockout after a fault" solution.
- [2] Not to be wired on fixed version.
- [3] Prefabricated wiring supplied.

IMPORTANT

The relays controlling the closing order to the "Normal" and "Replacement" circuit breakers must be mechanically and/or electrically interlocked to prevent them from giving simultaneous closing commands.

It is recommended to use **Tesys K** relays from Schneider Electric reference LC2-K06010●●. These relays are mechanically and electrically interlocked.

- Legends
- QN "Normal" source MasterPacT MTZ1 or MTZ2 or MTZ3
 - QR "Replacement" source MasterPacT MTZ1 or MTZ2 or MTZ3
 - MCH spring-charging motor
 - XF standard closing voltage release
 - MN undervoltage release
 - OF... breaker ON/OFF indication contact
 - SDE1 "fault-trip" indication contact
 - PF "ready-to-close" contact
 - CE1 "connected-position" indication contact (carriage switch)
 - CH "springs charged" indication contact
 - IVE electrical interlocking and terminal block unit
 - F1 auxiliary power supply circuit breaker
 - F2 circuit breaker (high breaking capacity)
 - S1 control switches
 - KA1 auxiliary relays
 - KA2 auxiliary relays
 - KA3 auxiliary relays

Wiring colour codes

RD	GN	BK	VT	YE	GY	WH	BN
red	green	black	violet	yellow	grey	white	brown

States permitted by mechanical interlocking system

Normal	Replacement
0	0
1	0
0	1

Note: diagram shown with circuit breakers in connected position, open, charged, and ready to close.
 Auxiliary power supply = supply voltage of auxiliary relays (KA...) = supply voltage of electrical auxiliaries (electrical operation, MCH, MN, XF...).



Remote-Operated Source-Changeover Systems

2 MasterPacT MTZ1 or MTZ2 or MTZ3 Devices

Automatic-Control System for Replacement Source Generator Set with Lockout after A Fault (with MN)

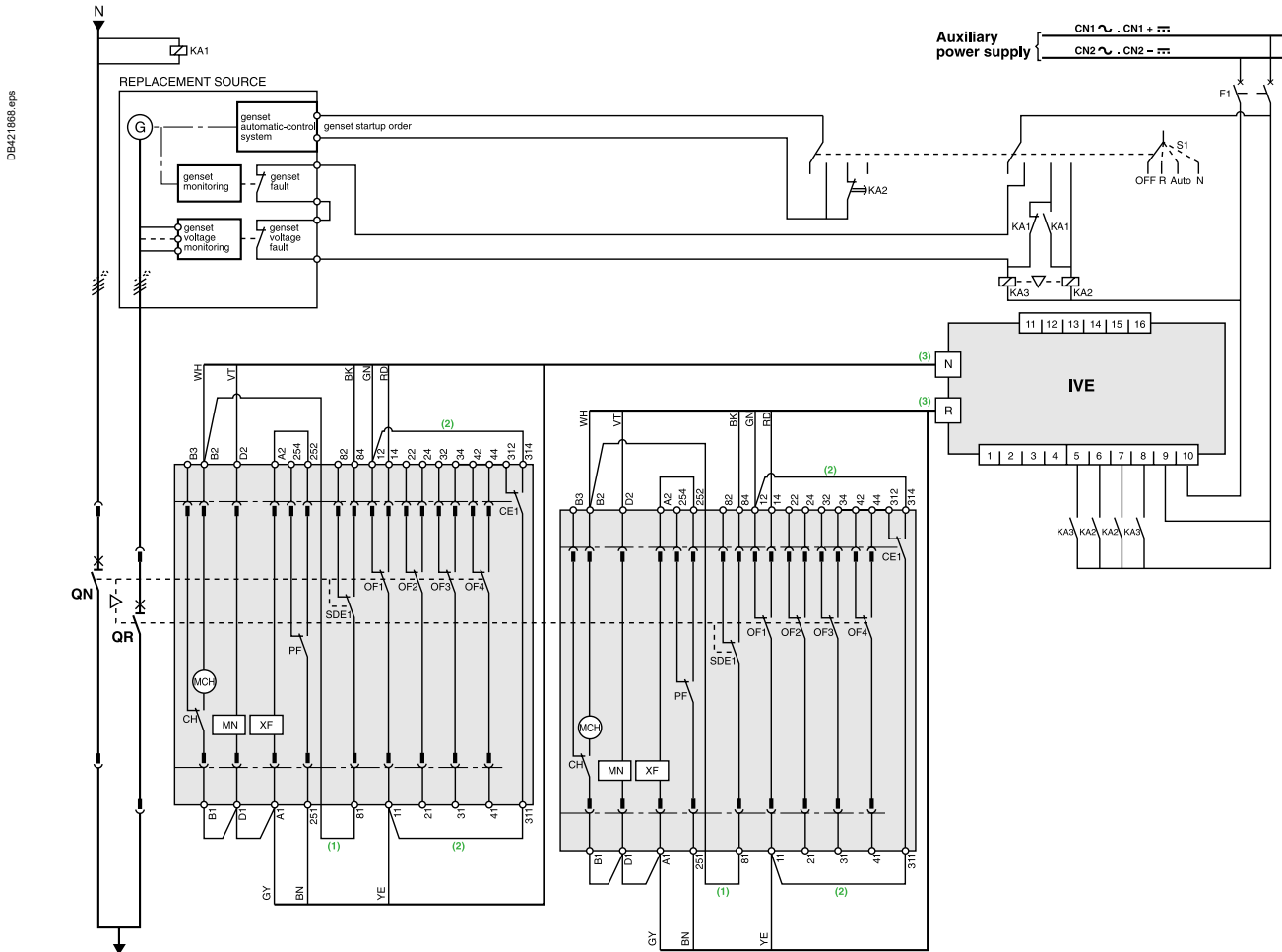

ATTENTION
 The diagram shows the electrical wiring for circuit breakers. When wiring the SDE with switch-disconnectors, connect wire BK to terminal 82.

- [1] Not to be wired for the "without lockout after a fault" solution.
- [2] Not to be wired on fixed version.
- [3] Prefabricated wiring supplied.

IMPORTANT
 The relays controlling the closing order to the "Normal" and "Replacement" circuit breakers must be mechanically and/or electrically interlocked to prevent them from giving simultaneous closing commands.
 It is recommended to use **Tesys K** relays from Schneider Electric reference LC2-K06010●●. These relays are mechanically and electrically interlocked.

- Legends
- QN "Normal" source MasterPacT MTZ1 or MTZ2 or MTZ3
 - QR "Replacement" source MasterPacT MTZ1 or MTZ2 or MTZ3
 - MCH spring-charging motor
 - XF standard closing voltage release
 - MN undervoltage release
 - OF... breaker ON/OFF indication contact
 - SDE1 "fault-trip" indication contact
 - PF "ready-to-close" contact
 - CE1 "connected-position" indication contact (carriage switch)
 - CH "springs charged" indication contact
 - IVE electrical interlocking and terminal block unit
 - F1 auxiliary power supply circuit breaker
 - F2 circuit breaker (high breaking capacity)
 - S1 control switches
 - KA1 auxiliary relay
 - KA2 time delay for genset startup order to avoid starting the genset for transient UN disturbances
 - KA3 auxiliary relay

Wiring colour codes

RD	GN	BK	VT	YE	GY	WH	BN
red	green	black	violet	yellow	grey	white	brown

States permitted by mechanical interlocking system

Normal	Replacement
0	0
1	0
0	1

Note: diagram shown with circuit breakers in connected position, open, charged, and ready to close.
 Auxiliary power supply = supply voltage of auxiliary relays (KA...) = supply voltage of electrical auxiliaries (electrical operation, MCH, MN, XF...).

Source-Changeover Systems with UA Controllers

2 ComPacT NSX100/630, NS630b/1600
or MasterPacT MTZ1/MTZ2/MTZ3 Devices

Source-Changeover System with UA Controller

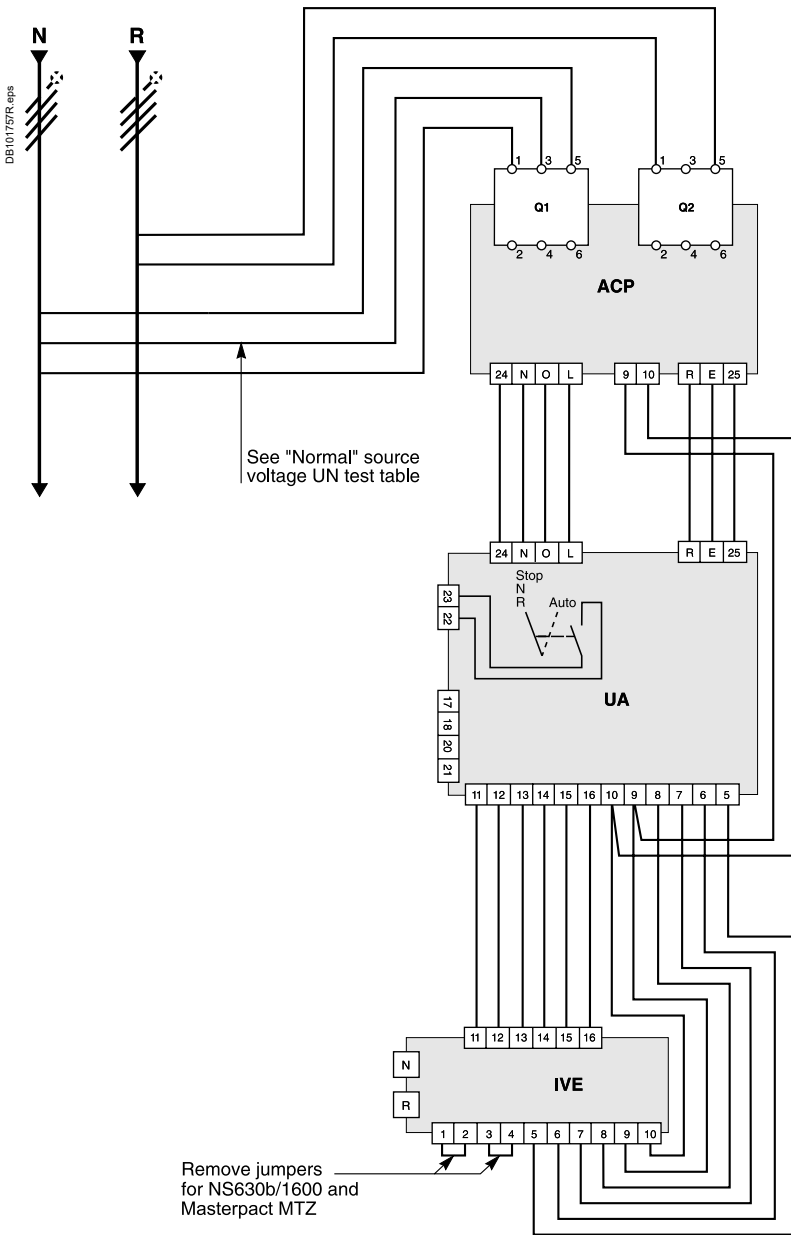

Load shedding and genset management

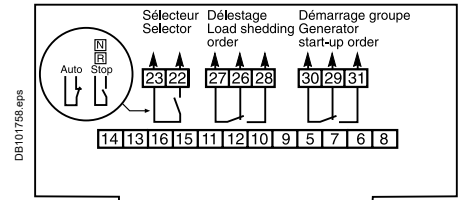

Transfer conditions

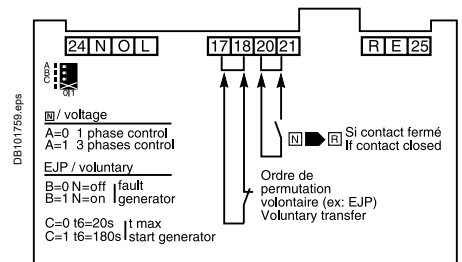

Terminals 20 and 21:
additional control contact (not part of controller).

Tests on "Normal" and "Replacement" source voltages

"Normal" source voltage UN test

Ref. UA	29472 29474	29472 29474	29473 29475
Supply voltage	N / φ 220/240VAC 50/60Hz	φ / φ 220/240VAC 50/60Hz	φ / φ 380/415VAC 50/60Hz
Switch position			
A = 0			
A = 1			

DB101761.eps

"Replacement" source voltage UR test

The single-phase check for UR is implemented across terminals 1 and 5 of circuit breaker Q2.

Legends

- Q1 circuit breaker supplying and protecting the automatic-control circuits for the "Normal" source
- Q2 circuit breaker supplying and protecting the automatic-control circuits for the "Replacement" source
- ACP control plate
- UA automatic controller
- IVE electrical interlocking and terminal block unit

Note: diagram shown with circuits de-energized, circuit breakers open and relays in normal position.

Source-Changeover Systems with UA Controllers

Controller Settings

Source Changeover System with UA Controller

Controller settings

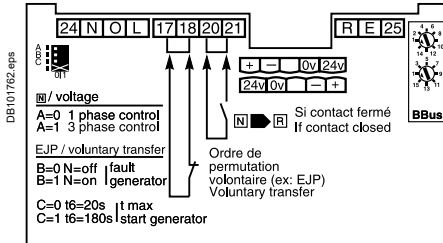

Tests on "Normal" source voltage

A = 0 single-phase test,

A = 1 three-phase test.

Voluntary transfert (e.g. for energy management)

■ action in the event of genset failure

B = 0 circuit breaker N opens,

B = 1 circuit breaker N remains closed.

■ maximum permissible genset startup time (T6)

C = 0 T = 120 s,

C = 1 T = 180 s.

After this time has elapsed, the genset is considered to have failed.

Source-Changeover Systems with BA Controllers

2 ComPacT NSX100/630, NS630b/1600

or MasterPacT MTZ1/MTZ2/MTZ3 Devices

Source-Changeover System with BA Controller

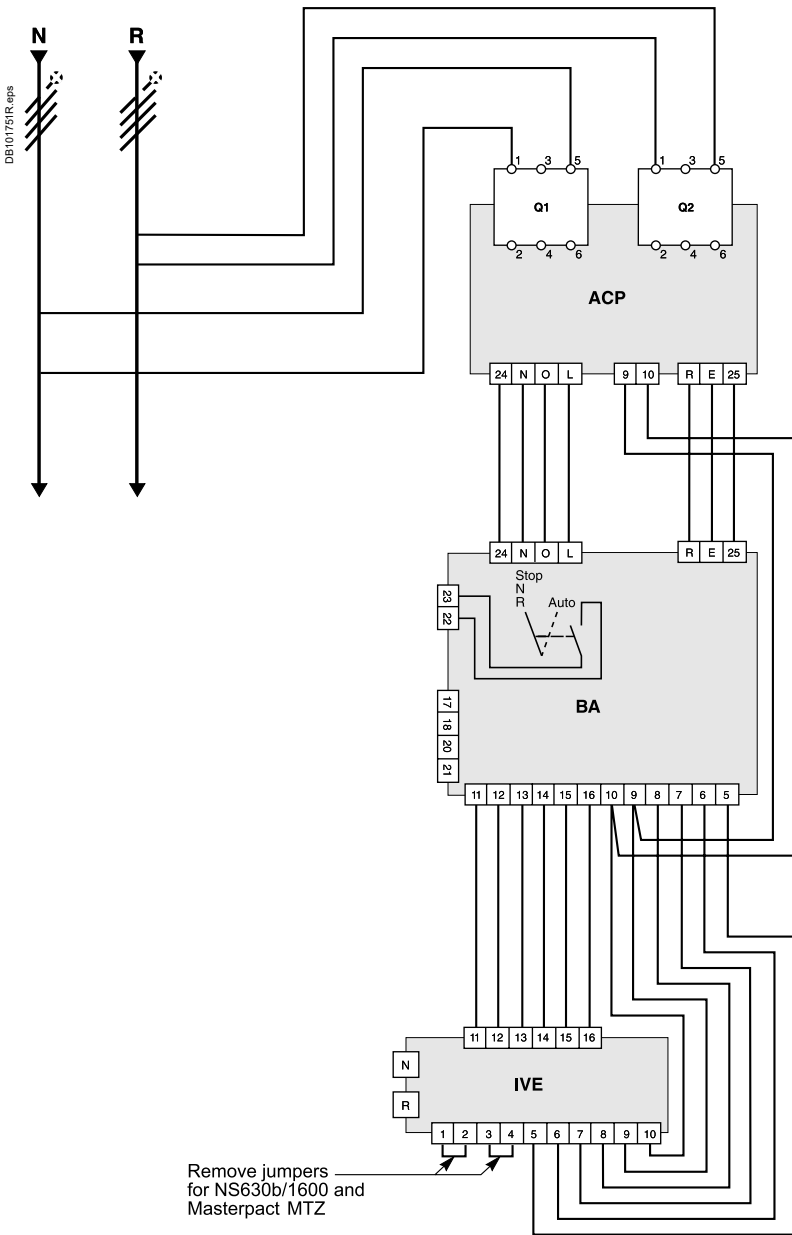

Coupling

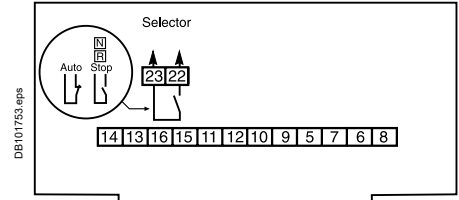

Transfer conditions

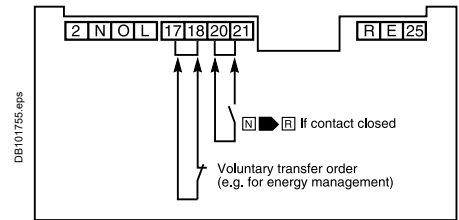

Terminals 20 and 21:
additional control contact (not part of controller).

Tests on "Normal" and "Replacement" source voltages

The single-phase check for UN and UR is implemented across terminals 1 and 5 of circuit breakers Q1 and Q2.

Legends

- Q1 circuit breaker supplying and protecting the automatic-control circuits for the "Normal" source
- Q2 circuit breaker supplying and protecting the automatic-control circuits for the "Replacement" source
- ACP control plate
- BA automatic controller
- IVE electrical interlocking and terminal block unit

Note: diagram shown with circuits de-energized, circuit breakers open and relays in normal position.



Remote-Operated Source-Changeover Systems

3 MasterPacT MTZ2/MTZ3 Devices

2 Normal Sources and 1 Replacement Source: Electrical Interlocking without Lockout after A Fault

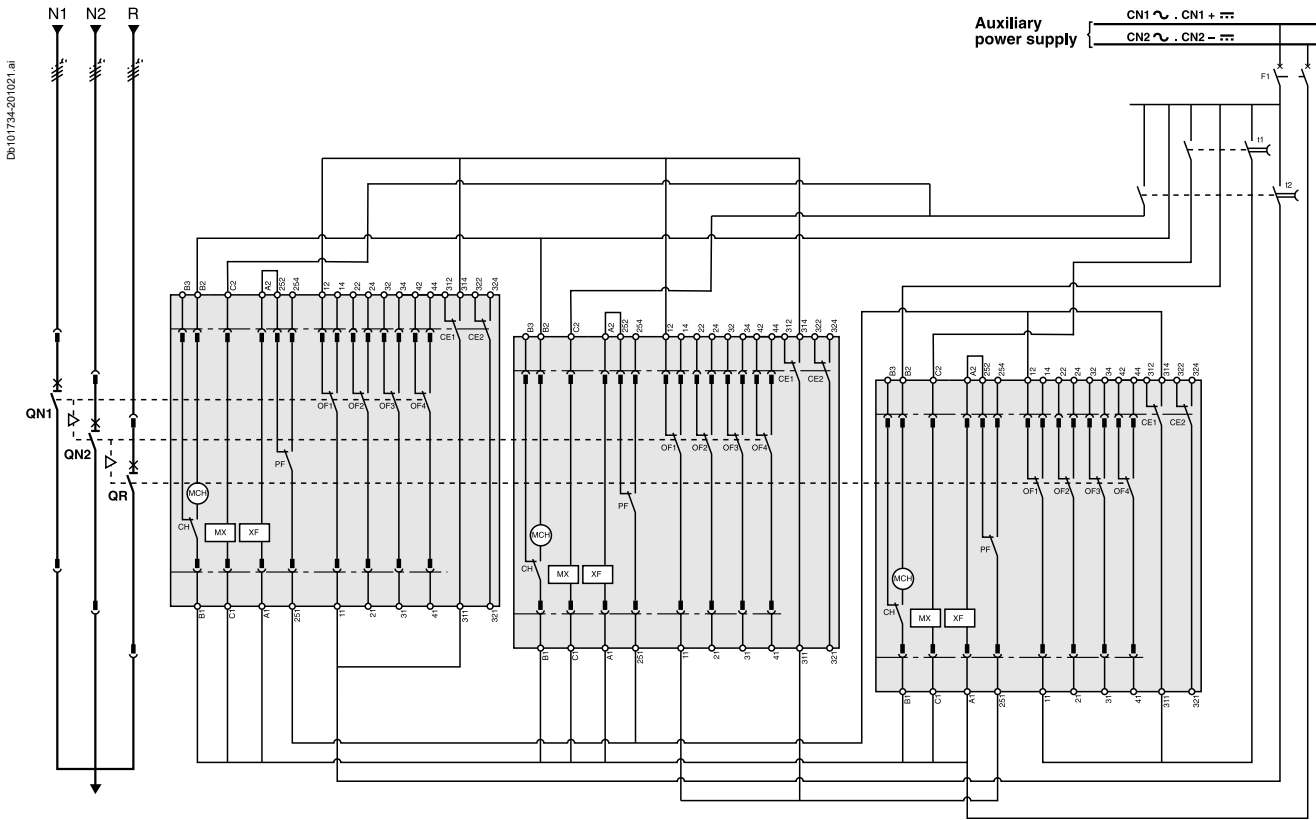

Legends

- QN... "Normal" source MasterPacT MTZ2 or MTZ3
- QR "Replacement" source MasterPacT MTZ2 or MTZ3
- MCH spring-charging motor
- MX standard opening voltage release
- XF standard closing voltage release
- OF... breaker ON/OFF indication contact
- PF "ready-to-close" contact
- CE "connected-position" indication contact (carriage switch)
- CH "springs charged" indication contact
- F1 auxiliary power supply circuit breaker
- t1 order for transfer from "R" to "N1 + N2"
(QN1 and QN2 closing time delay = 0.25 sec. minimum)
- t2 order for transfer from "N1 + N2" to "R"
(QR closing time delay = 0.25 sec. minimum)

States permitted by mechanical interlocking system

Normal 1	Normal 2	Replacement
0	0	0
1	1	0
0	0	1
1	0	0
0	1	0

Note: diagram shown with circuit breakers in connected position, open, charged, and ready to close.
 Auxiliary power supply = supply voltage of auxiliary relays (KA...) = supply voltage of electrical auxiliaries (electrical operation, MCH, MX, XF...).

Remote-Operated Source-Changeover Systems

3 MasterPacT MTZ2/MTZ3 Devices

2 Normal Sources and 1 Replacement Source: Electrical Interlocking with Lockout after A Fault

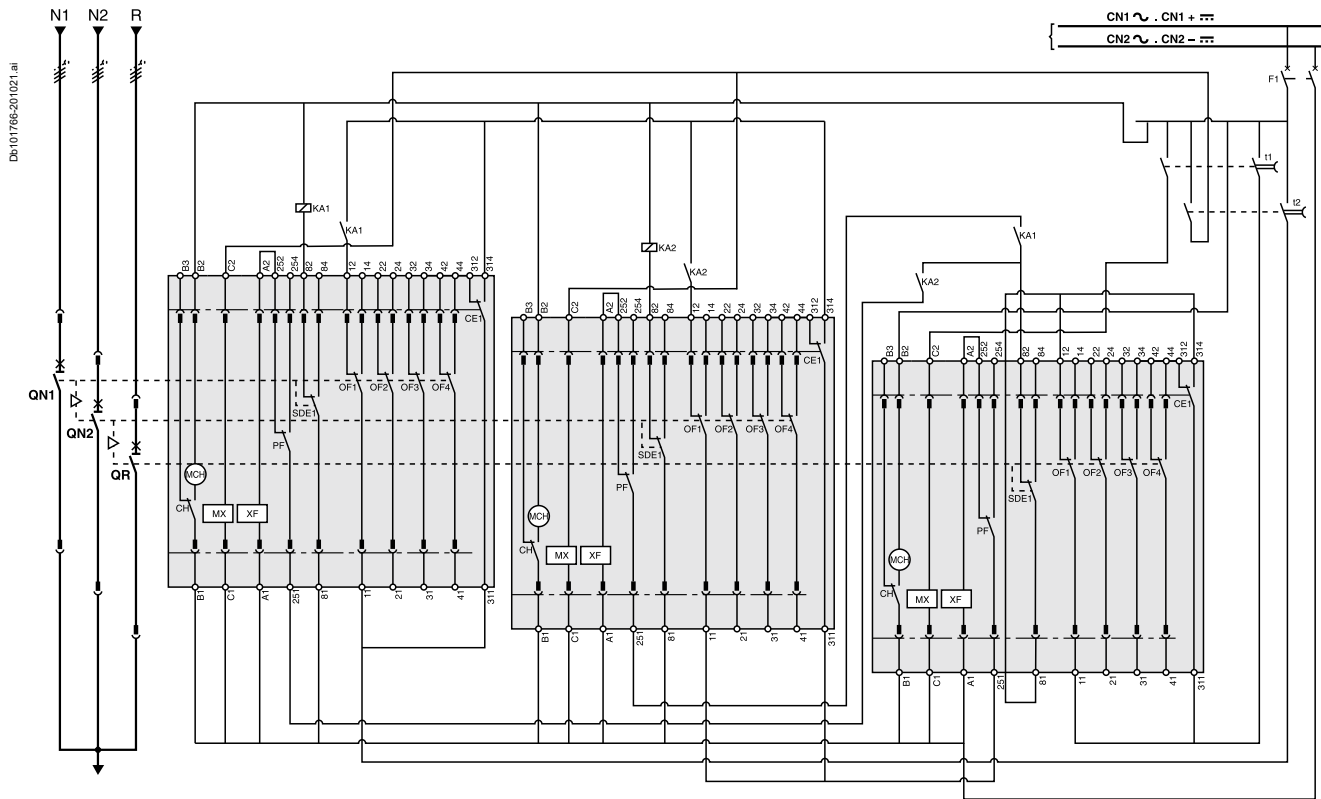

ATTENTION
 The diagram shows the electrical wiring for circuit breakers. When wiring the SDE with **switch-disconnectors**, connect the SDE to terminals 81 and 84.

Legends

- QN... "Normal" source MasterPacT MTZ2 or MTZ3
- QR "Replacement" source MasterPacT MTZ2 or MTZ3
- MCH spring-charging motor
- MX standard opening voltage release
- XF standard closing voltage release
- OF... breaker ON/OFF indication contact
- SDE1 "fault-trip" indication contact
- PF "ready-to-close" contact
- CE1 "connected-position" indication contact (carriage switch)
- CH "springs charged" indication contact
- F1 auxiliary power supply circuit breaker
- S1 control switches
- S2 source selection switches
- KA1 auxiliary relay
- KA2 auxiliary relays with 10 to 180 sec. time delay
- t1 order for transfer from "R" to "N1 + N2"
(QN1 and QN2 closing time delay = 0.25 sec. minimum)
- t2 order for transfer from "N1 + N2" to "R"
(QR closing time delay = 0.25 sec. minimum)

States permitted by mechanical interlocking system

Normal 1	Normal 2	Replacement
0	0	0
1	1	0
0	0	1
1	0	0
0	1	0

Note: diagram shown with circuit breakers in connected position, open, charged, and ready to close. Auxiliary power supply = supply voltage of auxiliary relays (KA...) = supply voltage of electrical auxiliaries (electrical operation, MCH, MX, XF...).



Remote-Operated Source-Changeover Systems

3 MasterPacT MTZ2/MTZ3 Devices

2 Normal Sources and 1 Replacement Source: Automatic-Control System for Generator Set without Lockout after A Fault (with MN)

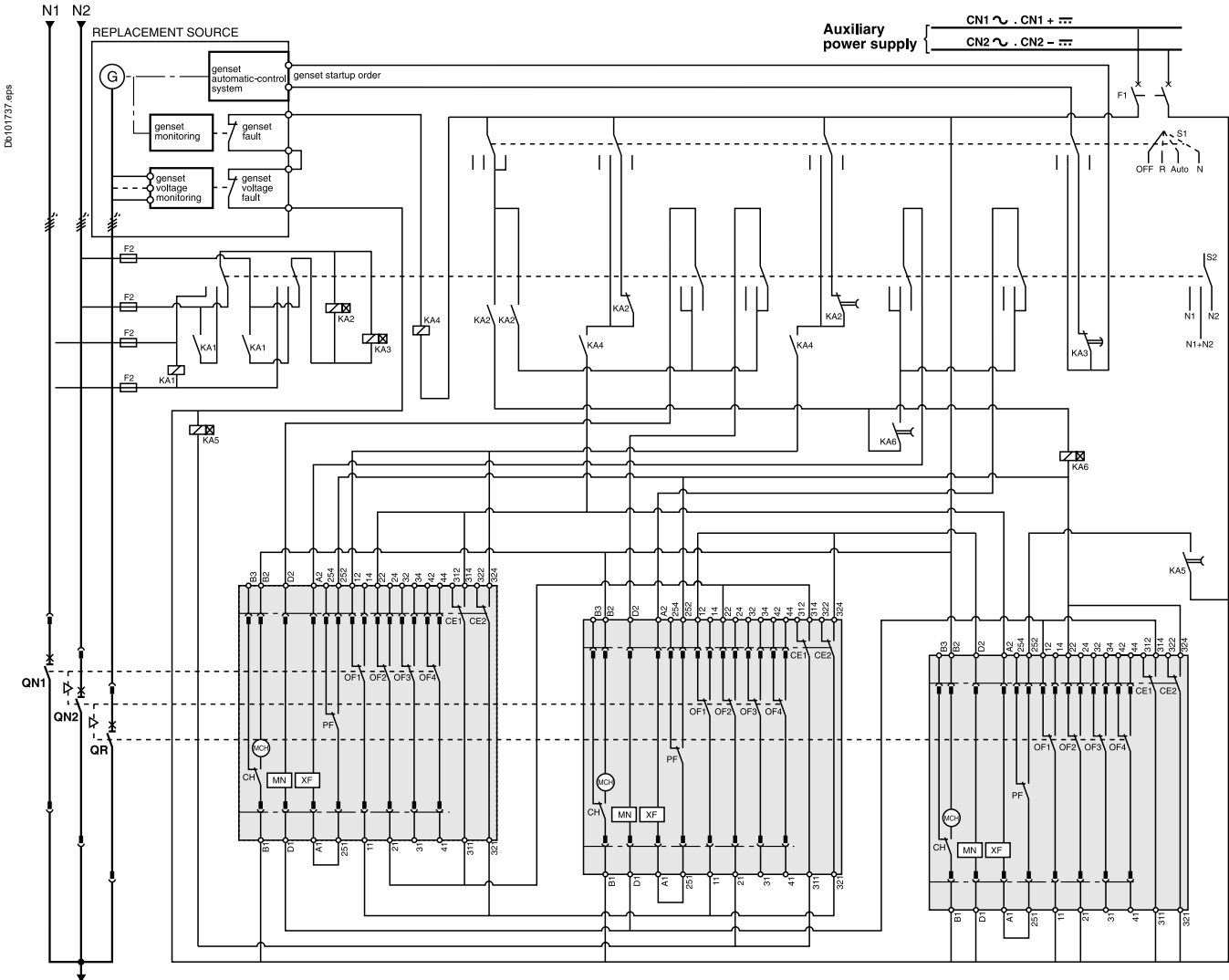

Legends

- QN... "Normal" source MasterPacT MTZ2 or MTZ3
- QR "Replacement" source MasterPacT MTZ2 or MTZ3
- MCH spring-charging motor
- XF standard closing voltage release
- MN undervoltage release
- OF... breaker ON/OFF indication contact
- PF "ready-to-close" contact
- CE... "connected-position" indication contact (carriage switch)
- CH "springs charged" indication contact
- F1 auxiliary power supply circuit breaker
- F2/F3 circuit breaker (high breaking capacity)
- S1 control switches
- S2 source selection switches
- KA1 auxiliary relay
- KA2 auxiliary relays with 10 to 180 sec. time delay
- KA3 auxiliary relays with 0.1 to 30 sec. time delay
- KA4 auxiliary relay
- KA5 auxiliary relays with 0.25 sec. time delay
- KA6 auxiliary relays with 0.25 sec. time delay

States permitted by mechanical interlocking system and with associated automatism

Normal 1	Normal 2	Replacement
0	0	0
1	1	0
0	0	1
1	0	0
0	1	0

Note: diagram shown with circuit breakers in connected position, open, charged, and ready to close. Auxiliary power supply = supply voltage of auxiliaries (electrical operation, MCH, MN, XF...).

Remote-Operated Source-Changeover Systems

3 MasterPacT MTZ2/MTZ3 Devices

2 Normal Sources and 1 Replacement Source: Automatic-Control System for Generator Set with Lockout after A Fault (with MN)

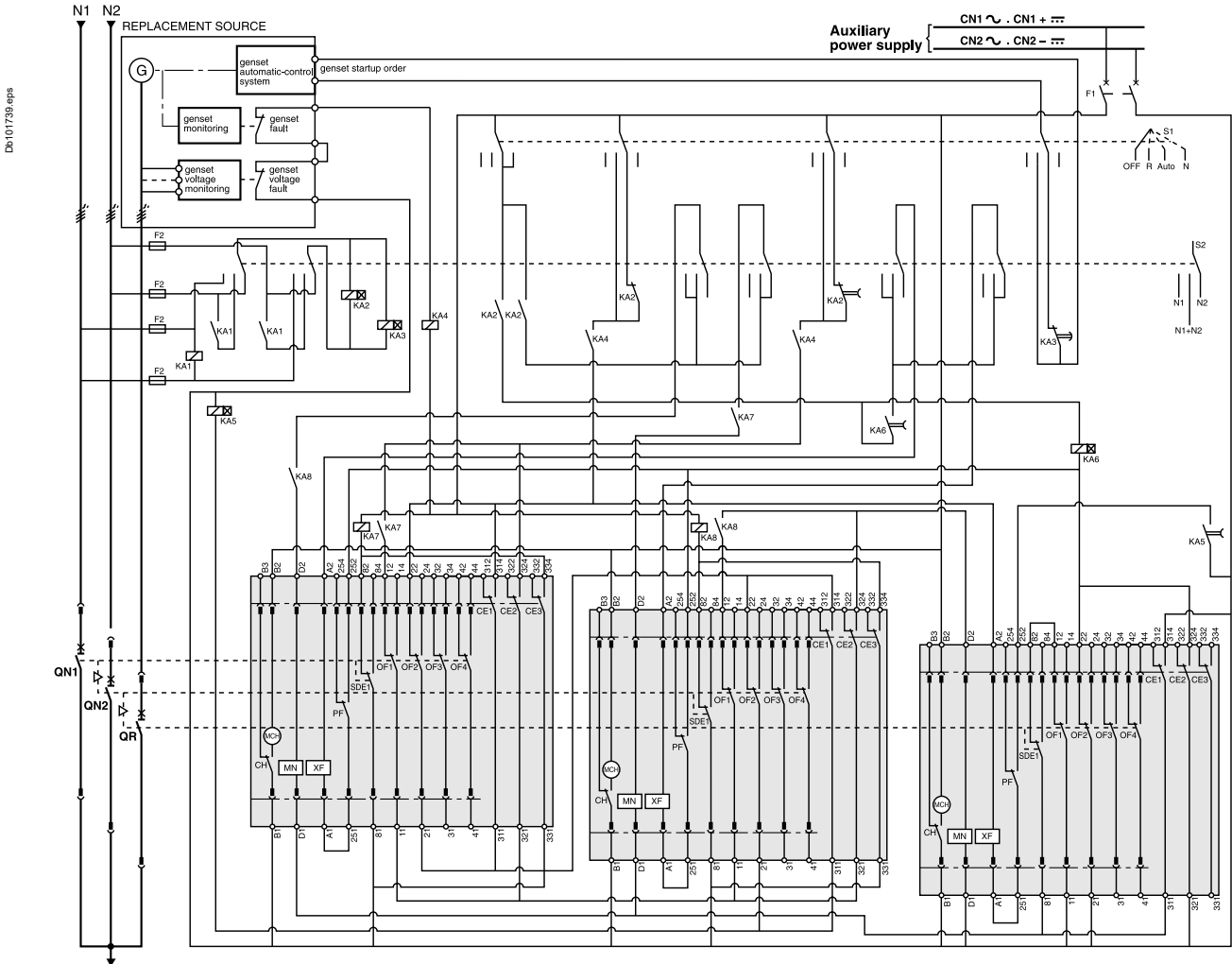

ATTENTION

The diagram shows the electrical wiring for circuit breakers. When wiring the SDE with **switch-disconnectors**, connect the SDE to terminals 81 and 84.

Legends

- QN... "Normal" source MasterPacT MTZ2 or MTZ3
- QR "Replacement" source MasterPacT MTZ2 or MTZ3
- MCH spring-charging motor
- XF standard closing voltage release
- MN undervoltage release
- OF... breaker ON/OFF indication contact
- SDE1 "fault-trip" indication contact
- PF "ready-to-close" contact
- CE... "connected-position" indication contact (carriage switch)
- CH "springs charged" indication contact
- F1 auxiliary power supply circuit breaker
- F2/F3 circuit breaker (high breaking capacity)
- S1 control switches
- S2 source selection switches
- KA1 auxiliary relay
- KA2 auxiliary relays with 10 to 180 sec. time delay
- KA3 auxiliary relays with 0.1 to 30 sec. time delay
- KA4 auxiliary relay
- KA5 auxiliary relays with 0.25 sec. time delay
- KA6 auxiliary relays with 0.25 sec. time delay
- KA7 auxiliary relay
- KA8 auxiliary relay

States permitted by mechanical interlocking system and with associated automatism

Normal 1	Normal 2	Replacement
0	0	0
1	1	0
0	0	1
1	0	0
0	1	0

Note: diagram shown with circuit breakers in connected position, open, charged, and ready to close. Auxiliary power supply = supply voltage of auxiliary relays (KA...) = supply voltage of electrical auxiliaries (electrical operation, MCH, MN, XF...).



Remote-Operated Source-Changeover Systems

3 MasterPacT MTZ2/MTZ3 Devices

3 Sources with only 1 Device Closed: Electrical Interlocking without Lockout after A Fault

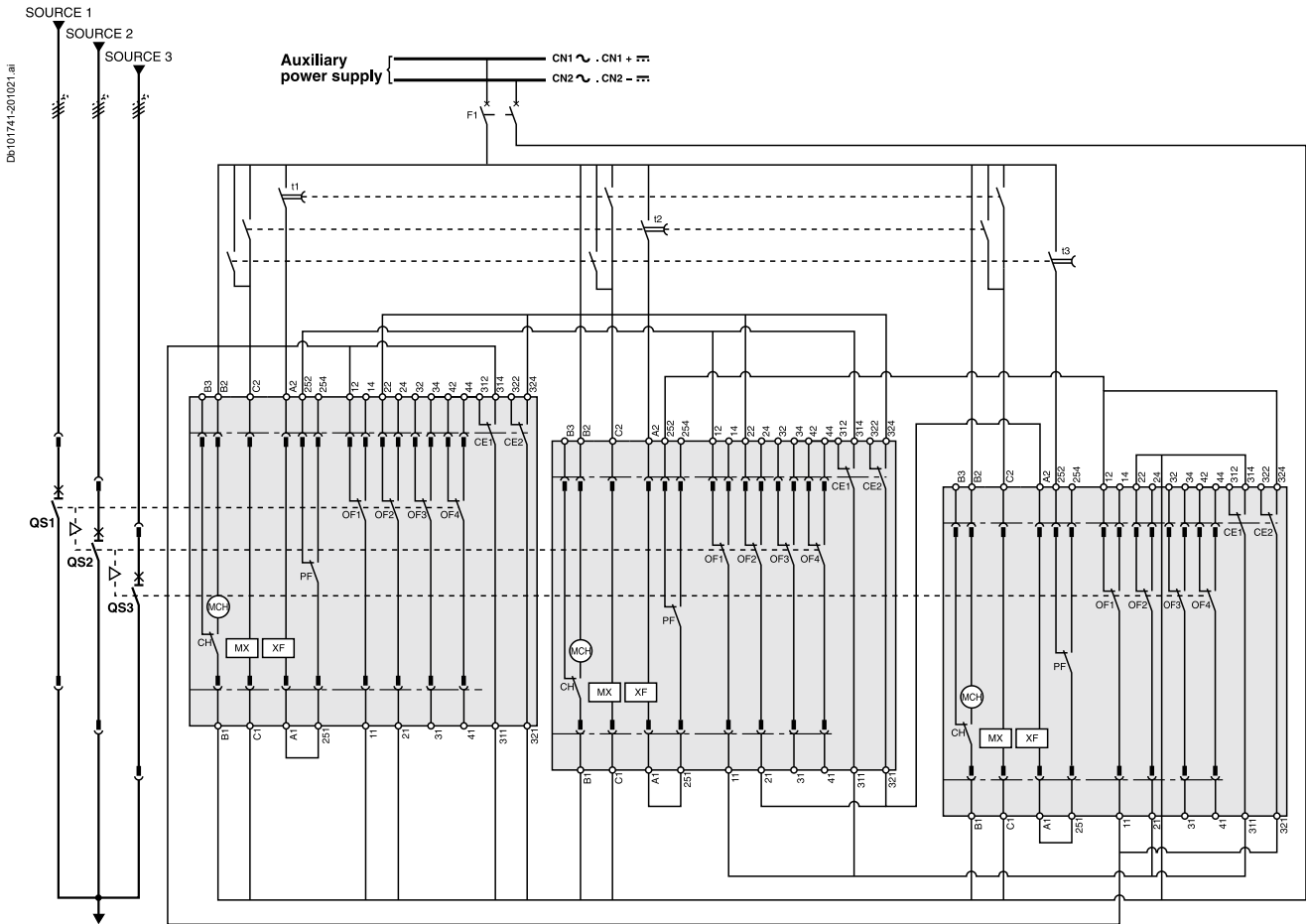

Legends

- QS... "Source" MasterPacT MTZ2 or MTZ3
- MCH spring-charging motor
- MX standard opening voltage release
- XF standard closing voltage release
- OF... breaker ON/OFF indication contact
- PF "ready-to-close" contact
- CE... "connected-position" indication contact (carriage switch)
- CH "springs charged" indication contact
- F1 auxiliary power supply circuit breaker
- t1 order for transfer to "Source 1"
(QS1 closing time delay = 0.25 sec. minimum)
- t2 order for transfer to "Source 2"
(QS2 closing time delay = 0.25 sec. minimum)
- t3 order for transfer to "Source 3"
(QS3 closing time delay = 0.25 sec. minimum)

States permitted by mechanical interlocking system

Source 1	Source 2	Source 3
0	0	0
1	0	0
0	1	0
0	0	1

Note: diagram shown with circuit breakers in connected position, open, charged, and ready to close. Auxiliary power supply = supply voltage of auxiliary relays (KA...) = supply voltage of electrical auxiliaries (electrical operation, MCH, MX, XF...).

Remote-Operated Source-Changeover Systems

3 MasterPacT MTZ2/MTZ3 Devices

3 Sources with only 1 Device Closed: Electrical Interlocking with Lockout after A Fault

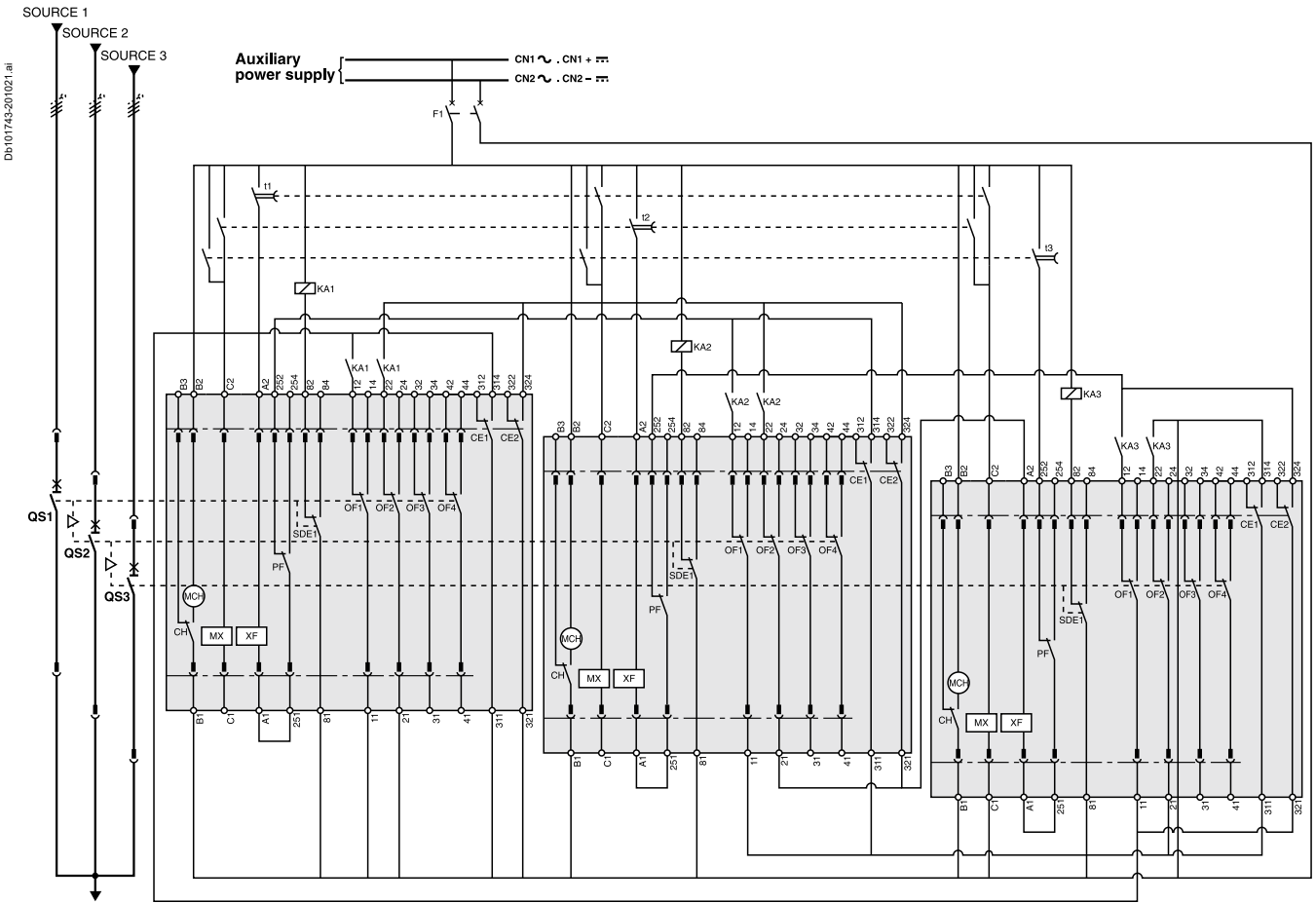

ATTENTION
 The diagram shows the electrical wiring for circuit breakers. When wiring the SDE with **switch-disconnectors**, connect the SDE to terminals 81 and 84.

Legends

- QS... "Source" MasterPacT MTZ2 or MTZ3
- MCH spring-charging motor
- MX standard opening voltage release
- XF standard closing voltage release
- OF... breaker ON/OFF indication contact
- SDE1 "fault-trip" indication contact
- PF "ready-to-close" contact
- CE... "connected-position" indication contact (carriage switch)
- CH "springs charged" indication contact
- F1 auxiliary power supply circuit breaker
- t1 order for transfer to "Source 1"
(QS1 closing time delay = 0.25 sec. minimum)
- t2 order for transfer to "Source 2"
(QS2 closing time delay = 0.25 sec. minimum)
- t3 order for transfer to "Source 3"
(QS3 closing time delay = 0.25 sec. minimum)
- KA1 auxiliary relays
- KA2 auxiliary relays
- KA3 auxiliary relays

States permitted by mechanical interlocking system

Source 1	Source 2	Source 3
0	0	0
1	0	0
0	1	0
0	0	1

Note: diagram shown with circuit breakers in connected position, open, charged, and ready to close. Auxiliary power supply = supply voltage of auxiliary relays (KA...) = supply voltage of electrical auxiliaries (electrical operation, MCH, MX, XF...).



Remote-Operated Source-Changeover Systems

3 MasterPacT MTZ2/MTZ3 Devices

2 Sources and 1 Coupling: Electrical Interlocking without Lockout after A Fault

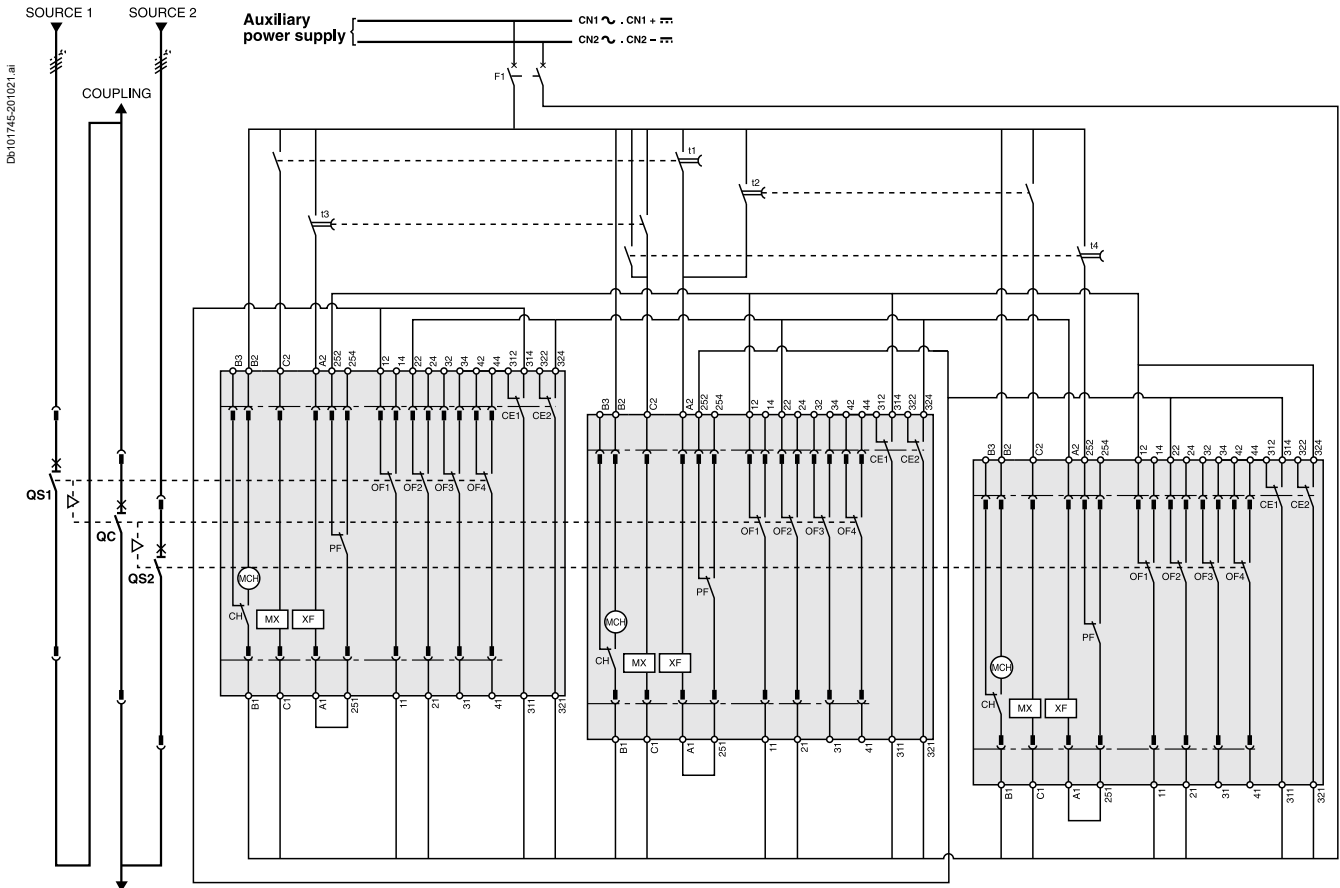

Legends

- QS... "Source" MasterPacT MTZ2 or MTZ3
- QC "Coupling" MasterPacT MTZ2 or MTZ3
- MCH spring-charging motor
- MX standard opening voltage release
- XF standard closing voltage release
- OF... breaker ON/OFF indication contact
- PF "ready-to-close" contact
- CE... "connected-position" indication contact (carriage switch)
- CH "springs charged" indication contact
- F1 auxiliary power supply circuit breaker
- t1 coupling order for "Source 1 failure"
(QC closing time delay = 0.25 sec. minimum)
- t2 coupling order for "Source 2 failure"
(QC closing time delay = 0.25 sec. minimum)
- t3 coupling order for "Source 1 restored"
(QS1 closing time delay = 0.25 sec. minimum)
- t4 coupling order for "Source 2 restored"
(QS2 closing time delay = 0.25 sec. minimum)

States permitted by mechanical interlocking system

Source 1	Source 2	Coupling
0	0	0
1	1	0
1	0	1
0	1	1
1	0	0
0	1	0
0	0	1

Note: diagram shown with circuit breakers in connected position, open, charged, and ready to close.
 Auxiliary power supply = supply voltage of auxiliary relays (KA...) = supply voltage of electrical auxiliaries (electrical operation, MCH, MX, XF...).

Remote-Operated Source-Changeover Systems

3 MasterPacT MTZ2/MTZ3 Devices

2 Sources and 1 Coupling: Electrical Interlocking with Lockout after A Fault

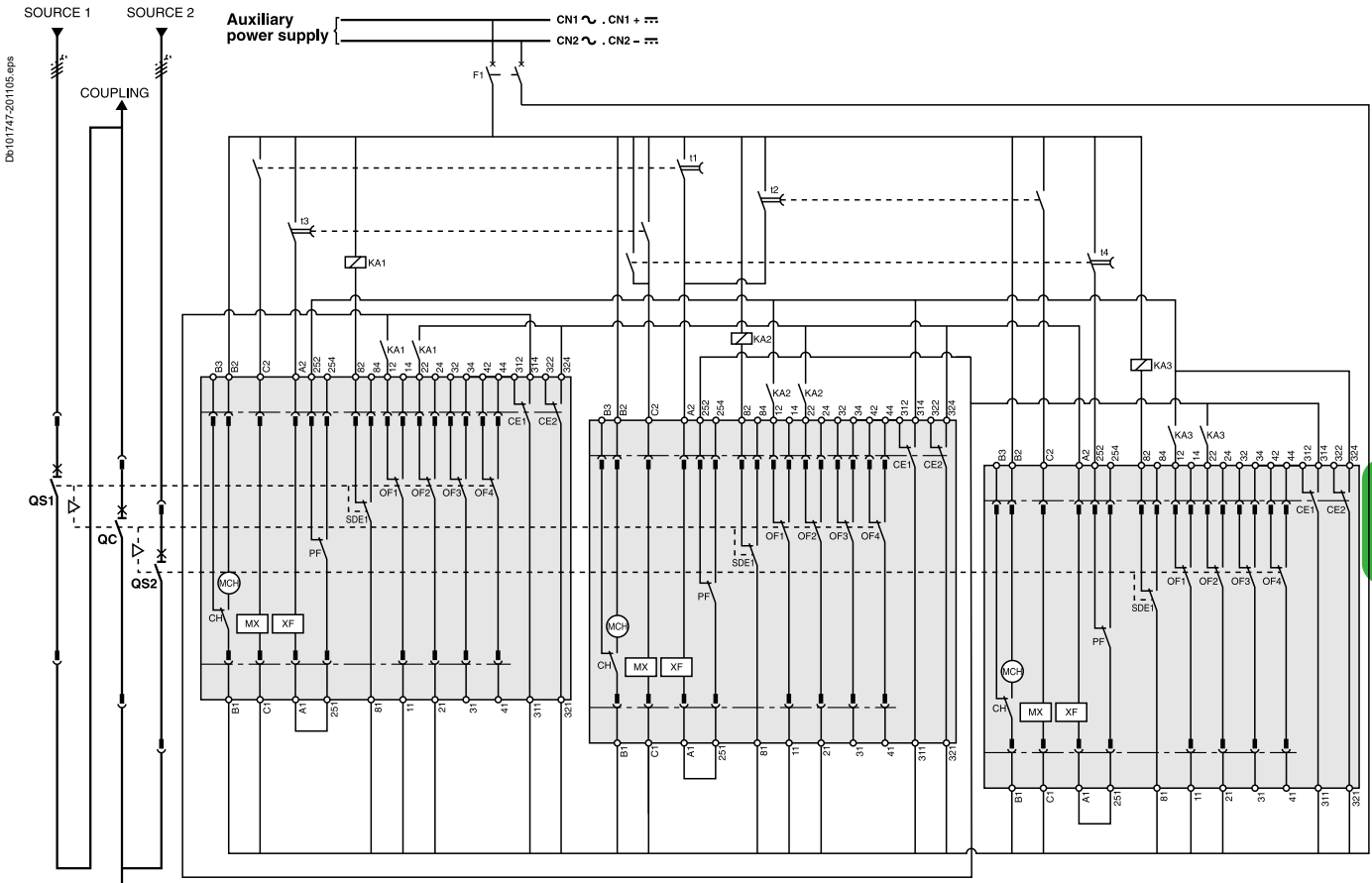

ATTENTION
 The diagram shows the electrical wiring for circuit breakers. When wiring the SDE with **switch-disconnectors**, connect the SDE to terminals 81 and 84.

Legends

- QS... "Source" MasterPacT MTZ2 or MTZ3
- QC "Coupling" MasterPacT MTZ2 or MTZ3
- MCH spring-charging motor
- MX standard opening voltage release
- XF standard closing voltage release
- OF... breaker ON/OFF indication contact
- SDE1 "fault-trip" indication contact
- PF "ready-to-close" contact
- CE... "connected-position" indication contact (carriage switch)
- CH "springs charged" indication contact
- F1 auxiliary power supply circuit breaker
- t1 coupling order for "Source 1 failure"
(QC closing time delay = 0.25 sec. minimum)
- t2 coupling order for "Source 2 failure"
(QC closing time delay = 0.25 sec. minimum)
- t3 coupling order for "Source 1 restored"
(QS1 closing time delay = 0.25 sec. minimum)
- t4 coupling order for "Source 2 restored"
(QS2 closing time delay = 0.25 sec. minimum)
- KA1 auxiliary relays
- KA2 auxiliary relays
- KA3 auxiliary relays

States permitted by mechanical interlocking system

Source 1	Source 2	Coupling
0	0	0
1	1	0
1	0	1
0	1	1
1	0	0
0	1	0
0	0	1

Note: diagram shown with circuit breakers in connected position, open, charged, and ready to close. Auxiliary power supply = supply voltage of auxiliary relays (KA...) = supply voltage of electrical auxiliaries (electrical operation, MCH, MX, XF...).

Remote-Operated Source-Changeover Systems

3 MasterPacT MTZ2/MTZ3 Devices

2 Sources and 1 Coupling: Automatic-Control System with Lockout after A Fault

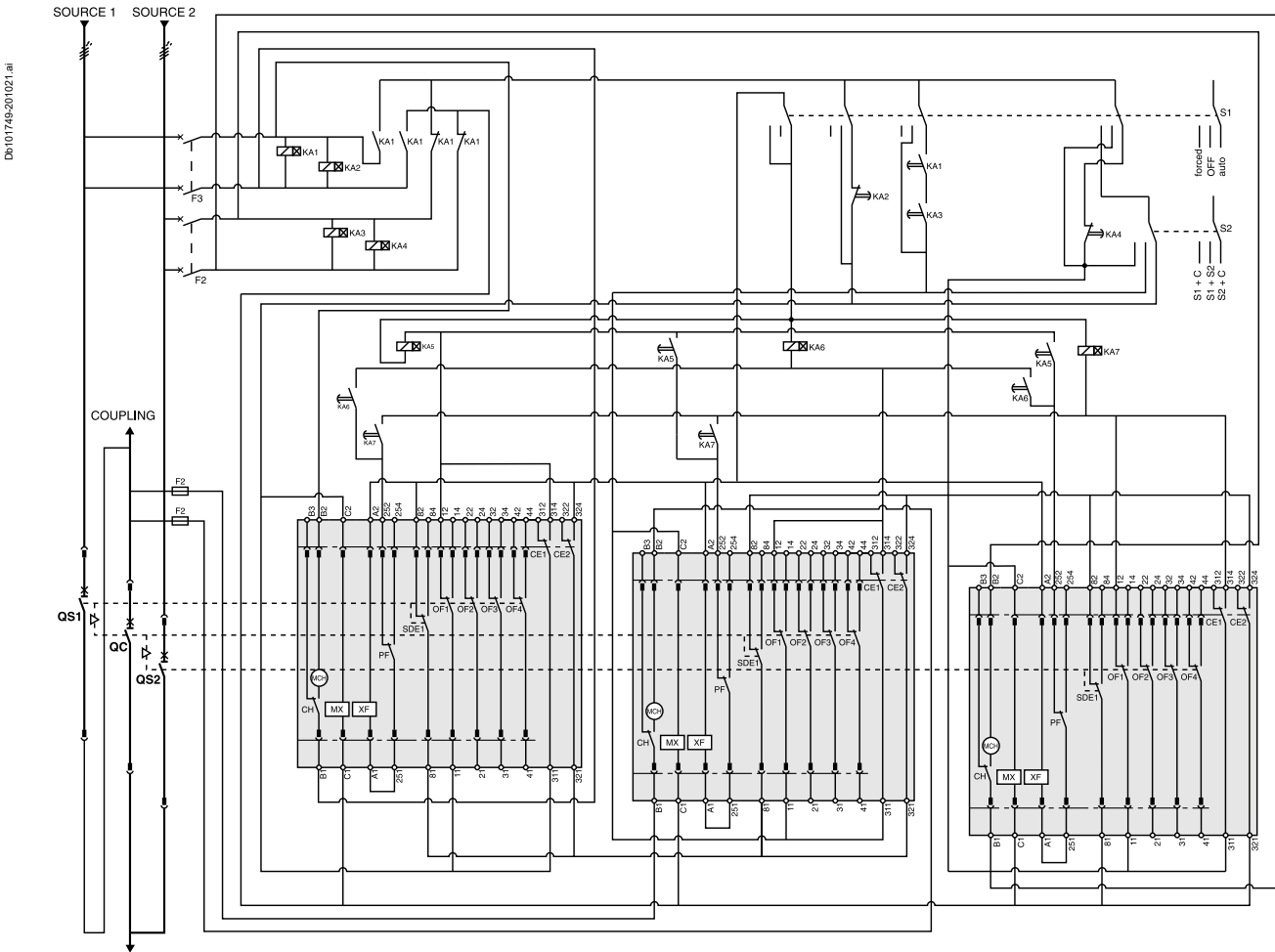

ATTENTION

The diagram shows the electrical wiring for circuit breakers. When wiring the SDE with switch-disconnectors, connect the SDE to terminals 81 and 84.

Legends

- QS... "Source" MasterPacT MTZ2 or MTZ3
- QC "Coupling" MasterPacT MTZ2 or MTZ3
- MCH spring-charging motor
- MX standard opening voltage release
- XF standard closing voltage release
- OF... breaker ON/OFF indication contact
- SDE1 "fault trip" indication contact
- PF "ready-to-close" contact
- CE... "connected-position" indication contact (carriage switch)
- CH "springs charged" indication contact
- F1 auxiliary power supply circuit breaker
- F2/F3 circuit breaker (high breaking capacity)
- S1 control switches
- S2 source selection switches
- KA1 auxiliary relays with 10 to 180 sec. time delay
- KA2 auxiliary relays with 0.1 to 30 sec. time delay
- KA3 auxiliary relays with 10 to 180 sec. time delay
- KA4 auxiliary relays with 0.1 to 30 sec. time delay
- KA5 auxiliary relays with 0.25 sec. time delay
- KA6 auxiliary relays with 0.25 sec. time delay
- KA7 auxiliary relays with 0.25 sec. time delay

States permitted by mechanical interlocking system and with associated automatism

Source 1	Source 2	Coupling
0	0	0
1	1	0
1	0	1
0	1	1
1	0	0
0	1	0
0	0	1

Note: diagram shown with circuit breakers in connected position, open, charged, and ready to close. Auxiliary power supply = supply voltage of auxiliary relays (KA...) = supply voltage of electrical auxiliaries (electrical operation, MCH, MX, XF...).

References of Source-Changeover Systems for 2 Devices

ComPacT INS40 to INS2500, INV100 to INV2500

Manual Source-Changeover Systems

Interlocking for rotary handle

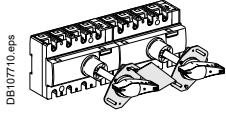
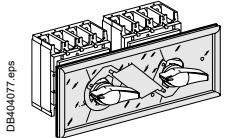
 <p>DB107710.eps</p>	Mechanical device for INS40 to INS160 equipped with an extended rotary handle	3/4P	28953
	Mechanical device for INS250-100 to INS250/INV100 to INV250 equipped with a direct or extended rotary handle	31073	
 <p>DB404077.eps</p>	Mechanical device for INS/INV320 to INS/INV630 equipped with a direct or extended rotary handle	31074	

Interlocking

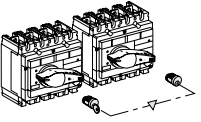
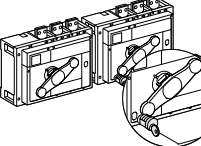
 <p>DB101549.eps</p>	Locking device for Ronis/Profalux keylocks on INS250-100 to INS250/INV100 to INV250	2x	31087
	Locking device for Ronis/Profalux keylocks on INS/INV320 to INS/INV630	2x	31088
 <p>DB404080.eps</p>	Locking device for Ronis/Profalux keylocks on INS/INV630b to INS/INV2500	2x	31291
	+ Ronis 1351B.500 keylock (2 keylocks / 1 key)		41950
	or + Profalux KS5 B24 D4Z keylock (2 keylocks / 1 key)		42878

Connection Accessories

Downstream coupling accessories

Short terminal shields (1 pair) + "Normal" source/"Replacement" source

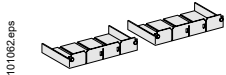
 <p>DB101062.eps</p>	INS250/INS250	3/4P	LV429359
	INS320 to INS630/INS320 to INS630		LV432620

Long terminal shields (1 piece)

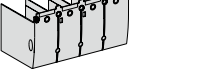
 <p>DB413202.eps</p>	INS250	Long terminal shield	LV429518
	INS320	Long terminal shield, 45 mm (1 piece)	LV432594
	to INS630	Long terminal shield for spreaders, 52.5 mm (1 piece)	LV432596

Terminal Extensions

 <p>DB119652.eps</p>	Spreaders	52.5 mm	4P	LV432491
---	-----------	---------	----	----------



References of Source-Changeover Systems for 2 Devices

ComPacT NSX100 to NSX630

Manual source changeover

Mechanical interlocking

DB404094.eps
DB404094.eps

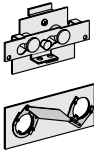

For toggle controlled circuit breakers	NSX100...250	LV429354T	
	NSX400...630	LV432614T	
For rotary handled circuit breakers	With direct rotary handle	NSX100...250	LV429369T
		NSX400...630	LV432621T
	With extended rotary handle	NSX100...250	LV429369ET
		NSX400...630	LV432621ET

Key lock interlocking

DB404095.eps

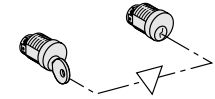

Keylock kit (keylock not included)		LV429344
1 set of 2 keylocks	Ronis 1351B.500	41950
(1 key only, keylock not included)	Profalux KS5 B24 D4Z	42878

Remote controlled source changeover

Plate + IVE unit

DB404086.eps

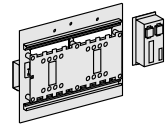

Source "Normal"/source "Replacement" (identical voltages)	24 to 250 V DC	48 to 415 V AC 50/60 Hz 440 V 60 Hz
NSX100...250/NSX100...250		
Plate + IVE unit ^[1]		
Plate	29351	29350
IVE unit	29349	29349
IVE unit	29356	29352
Auxiliary switches 2 OF + 2 SDE	4 x 29450	4 x 29450
Safety trip interlock (for fixed version only)	2 x LV429270	2 x LV429270
Spare wiring system (device/IVE unit)	29365	29365
Back sockets option add: Only long RC	[2]	[2]
Plug in base option add: Plug in kit	[2]	[2]
NSX400...630/NSX100...630		
Plate + IVE unit ^[1]		
Plate	32611	32610
IVE unit	32609	32609
IVE unit	29356	29352
Auxiliary switches 2 OF + 2 SDE	4 x 29450	4 x 29450
Safety trip interlock (for fixed version only)	2 x LV432520	2 x LV432520
Spare wiring system (device/IVE unit)	29365	29365
Back sockets option add: Only long RC	[2]	[2]
Plug in base option add: Plug in kit	[2]	[2]
Adaptator kit for NSX100...250	1 x 32618	1 x 32618

Control unit option

DB404087.eps

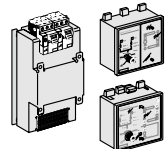

	110/127 V AC 50/60 Hz	220/240 V AC 50/60 Hz	380/415 V AC 50/60 Hz 440 V 60 Hz
ACP + controller BA ^[1]		29470	29471
Plate ACP		29363	29364
Controller BA		29376	29377
ACP + controller UA ^[1]	29448	29472	29473
Plate ACP	29447	29363	29364
Controller UA	29446	29378	29380

Wiring cable between UA/BA and ACP/IVE

Wiring cable (1.5 meter)	29368	29368
--------------------------	-------	-------

Connection Accessories

Downstream coupling accessories

DB101062.eps

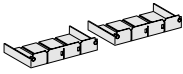

Short terminal shields (1 pair) + "Normal" source/"Replacement" source			
		3P	4P
NSX100...250/NSX100...250 / 250 A	LV429358	LV429358	LV429359
NSX400...630/NSX400...630 / 630 A	LV432619	LV432619	LV432620

DB413273.eps

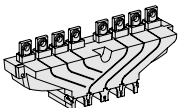

Long terminal shields (1 piece)		
		3/4P
NSX100...250	Long terminal shield	LV429518
NSX400...630	Long terminal shield, 45 mm (1 piece)	LV432594
	Long terminal shield for spreaders, 52.5 mm (1 piece)	LV432596

Terminal extensions

DB118652.eps



Spreaders	52.5 mm	4P	LV432491
-----------	---------	----	----------

[1] The supply voltages UA/BA controller, ACP plate, IVE unit and the remote control must be identical whatever the source changeover type.
[2] See products pages.

References of Source-Changeover Systems for 2 Devices

ComPacT NS630b to NS1600

Circuit Breakers and Switch-Disconnectors

Mechanical Interlocking for Source-Changeover Systems

Interlocking

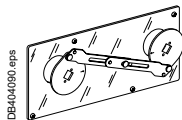

For 2 devices with extended rotary handles	33890
--	--------------

Interlocking using connecting rods

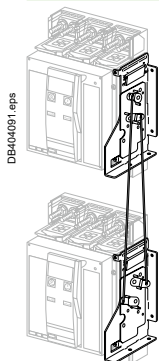

Complete assembly with 2 adaptation fixtures + rods	33910
2 ComPacT fixed devices	33913
2 ComPacT withdrawable devices	2x 33897
Push button cover (mandatory)	

Interlocking using cables

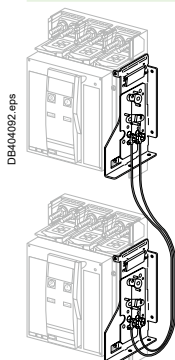

Complete assembly with 2 adaptation fixtures + cables	
2 ComPacT fixed devices	33911
2 ComPacT withdrawable devices	33914
1 ComPacT fixed + 1 ComPacT withdrawable device	33915
Push button cover (mandatory)	2x 33897

Associated controller

The automatic-control option includes:

- an IVE electrical-interlocking unit
- an ACP control plate
- a BA or UA controller, depending on the required functions
- a UA/BA adapter kit.

Note: the circuit breaker auxiliaries (MCH, MX, XF) and the automatic-control components (IVE, ACP, UA or BA) must have the same voltages.

TransferPacT Electrical Interlocking

IVE unit	24 to 250 V DC	48/415 V AC 50/60 Hz 440 V 60 Hz
For 2 devices	29356	29352
Wiring kit for connection of 2 fixed/withdrawable devices to the IVE unit		54655

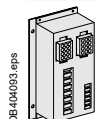

TransferPacT Controllers

Control unit	110/127 V AC 50/60 Hz	220/240 V AC 50/60 Hz	380/415 V AC 50/60 Hz 440 V 60 Hz
ACP + controller BA ^[1]		29470	29471
Plate ACP		29363	29364
Controller BA		29376	29377
ACP + controller UA ^[1]	29448	29472	29473
Plate ACP	29447	29363	29364
Controller UA	29446	29378	29380

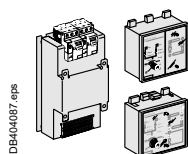

[1] The supply voltages of the UA/BA controller, ACP plate, IVE unit and circuit breaker operating mechanism must be identical whatever the type of source-changeover system.



References of Source-Changeover Systems for 2 Devices

MasterPacT MTZ1

Circuit Breakers and Switch-Disconnectors

Mechanical interlocking for Source-Changeover Systems

Interlocking using connecting rods

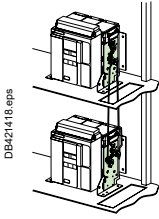

Complete assembly with 2 adaptation fixtures + rods

2 MasterPacT MTZ1 fixed devices	33912
2 MasterPacT MTZ1 drawout devices	33913
Push button cover (mandatory)	2x LV833897

Interlocking using cables ^[1]

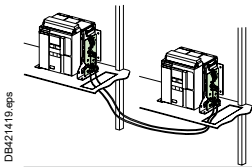

Choose 2 adaptation fixtures (1 for each breaker + 1 set of cables)

1 adaptation fixture for MasterPacT MTZ1 fixed devices	33200
1 adaptation fixture for MasterPacT MTZ1 drawout devices	33201
1 set of 2 cables	33209
Push button cover (mandatory)	2x LV833897

Associated Controller

The automatic-control option includes:

- an IVE electrical-interlocking unit
- an ACP control plate
- a BA or UA controller, depending on the required functions
- a UA/BA adapter kit.

Note: the circuit breaker auxiliaries (MCH, MX, XF) and the automatic-control components (IVE, ACP, UA or BA) must have the same voltages.

TransferPacT Electrical Interlocking

IVE unit	24 to 250 V DC	48/415 V AC 50/60 Hz 440 V 60 Hz
For 2 devices	29356	29352
Wiring kit for connection of 2 fixed/drawout devices to the IVE unit		54655

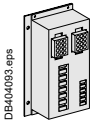

TransferPacT Controllers

Control unit	110/127 V AC 50/60 Hz	220/240 V AC 50/60 Hz	380/415 V AC 50/60 Hz 440 V 60 Hz
ACP + controller BA ^[2]		29470	29471
Plate ACP		29363	29364
Controller BA		29376	29377
ACP + controller UA ^[2]	29448	29472	29473
Plate ACP	29447	29363	29364
Controller UA	29446	29378	29380

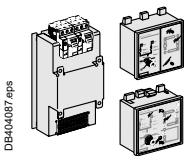

^[1] Can be used with any combination of MTZ1 or MTZ2/MTZ3, fixed or drawout devices.

^[2] The supply voltages of the UA/BA controller, ACP plate, IVE unit and circuit breaker operating mechanism must be identical whatever the type of source-changeover system.

References of Source-Changeover Systems for 2 Devices

MasterPacT MTZ2/MTZ3

Circuit Breakers and Switch-Disconnectors

Mechanical Interlocking for Source-Changeover Systems for 2 Devices

Interlocking of 2 devices using connecting rods

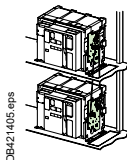

DB421405.eps

Complete assembly with 2 adaptation fixtures + rods	48612
2 MasterPacT MTZ2/MTZ3 fixed devices	48612
2 MasterPacT MTZ2/MTZ3 drawout devices	2x LV848536
Push button cover (mandatory)	
Note: Can be used with 1 MTZ2/MTZ3 fixed + 1 MTZ2/MTZ3 drawout.	

Interlocking of 2 devices using cables ^[1]

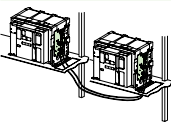

DB421406.eps

Choose 2 adaptation fixtures (1 for each breaker + 1 set of cables)	
1 adaptation fixture for MasterPacT MTZ2/MTZ3 fixed devices	47926
1 adaptation fixture for MasterPacT MTZ2/MTZ3 drawout devices	47926
1 set of 2 cables	33209
Push button cover (mandatory)	2x LV848536

Associated Controller for 2 Devices

- The automatic-control option includes:
- an IVE electrical-interlocking unit
 - an ACP control plate
 - a BA or UA controller, depending on the required functions
 - a UA/BA adapter kit.

Note: the circuit breaker auxiliaries (MCH, MX, XF) and the automatic-control components (IVE, ACP, UA or BA) must have the same voltages.

TransferPacT Electrical Interlocking

IVE unit	24 to 250 V DC	48/415 V AC 50/60 Hz 440 V 60 Hz
For 2 devices	29356	29352
Wiring kit for connection of 2 fixed/drawout devices to the IVE unit		54655

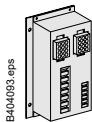

DB404033.eps

TransferPacT Controllers

Control unit	110/127 V AC 50/60 Hz	220/240 V AC 50/60 Hz	380/415 V AC 50/60 Hz 440 V 60 Hz
ACP + controller BA ^[2]		29470	29471
Plate ACP		29363	29364
Controller BA		29376	29377
ACP + controller UA ^[2]	29448	29472	29473
Plate ACP	29447	29363	29364
Controller UA	29446	29378	29380

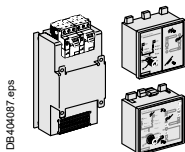

DB404037.eps

^[1] Can be used with any combination of MTZ1 or MTZ2/MTZ3, fixed or drawout devices.

^[2] The supply voltages of the UA/BA controller, ACP plate, IVE unit and circuit breaker operating mechanism must be identical whatever the type of source-changeover system.



References of Source-Changeover Systems for 3 Devices

MasterPacT MTZ2/MTZ3

Circuit Breakers and Switch-Disconnectors

Mechanical interlocking for source-changeover systems for 3 devices

Interlocking of 3 devices using cables

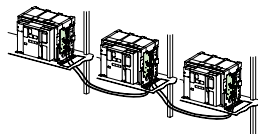
	Choose 3 adaptation fixtures (1 complete set with 3 adaptation fixtures + cables)	48610
	3 sources, only 1 device closed, fixed or drawout devices	48609
	2 sources, 1 coupling, fixed or drawout devices	48608
	2 normal, 1 replacement source, fixed or drawout devices	3x LV848536
	Push button cover (mandatory)	

Order Form for Source-Changeover Systems for 2 Devices

Com**PacT** INS40 to INS630

Switch-Disconnectors

To indicate your choices, check the applicable square boxes and enter the appropriate information in the rectangles .

Mechanical Interlocking of Two INS40 to INS630 Devices
Devices with Front Rotary Handles, Mounted Side by Side

	Two devices with direct rotary handles		
	INS250	<input type="checkbox"/>	INS320/400/500/630 <input type="checkbox"/>
	Two devices with extended rotary handles		
	INS40/63/80	<input type="checkbox"/>	INS100/125/160 <input type="checkbox"/>
	INS250	<input type="checkbox"/>	INS320/400/500/630 <input type="checkbox"/>
Downstream coupling accessory	INS250	<input type="checkbox"/>	INS320/400/500/630 <input type="checkbox"/>
Long terminal shields	INS250	<input type="checkbox"/>	INS320/400/500/630 <input type="checkbox"/>



Order Form for Source-Changeover Systems for 2 Devices

ComPacT INS40 to INS630

Switch-Disconnectors

To indicate your choices, check the applicable square boxes and enter the appropriate information in the rectangles .
 (one sheet per device, make copies if necessary)

Device identification:

Q 1 - NORMAL SOURCE

Q 2 - REPLACEMENT SOURCE

Switch-Disconnecter

ComPacT type	INS40/63/80	<input type="checkbox"/>
	INS100/125/160	<input type="checkbox"/>
	INS250	<input type="checkbox"/>
	INS320/400/500/630	<input type="checkbox"/>
Rating	A	<input type="checkbox"/>
Number of poles	3 or 4	<input type="checkbox"/>

Connections

Front connection	Standard	<input type="checkbox"/>
Rear connection	2 short <input type="checkbox"/> 2 long <input type="checkbox"/>	<input type="checkbox"/>
INS40/80 connectors	Distribution 3x16 [□] rigid/10 [□] flexible	<input type="checkbox"/>
INS100/160 connectors	Snap-on ≤ 95 [□] Distribution 4x25 [□] rigid/16 [□] flexible	<input type="checkbox"/>
INS250 connectors	Snap-on 1.5 [□] to 95 [□] (< 160 A) Snap-on 10 [□] to 185 [□] (< 250 A) Volt. tap connector for 185 [□] connector Clips for connectors Set of 10	<input type="checkbox"/>
INS320/630 connectors	Distribution 6x1.5 [□] to 35 [□] rigid with interphase barriers 1 cable 35 [□] to 300 [□] 2 cables 35 [□] to 240 [□] Voltage tap connector for 185 [□] connector	<input type="checkbox"/>
Distribution blocks	Linergy DX 4P 125 A <input type="checkbox"/> 160 A <input type="checkbox"/> 1P 160 A <input type="checkbox"/> Linergy BS 160 A <input type="checkbox"/> 250 A <input type="checkbox"/> (multi stage) Linergy DP 250 A <input type="checkbox"/>	<input type="checkbox"/>
Rt-angle extension	Set of 3 or 4 250 A <input type="checkbox"/> 630 A <input type="checkbox"/>	<input type="checkbox"/>
Straight extension	INS250	<input type="checkbox"/>
Edgewise ext.	INS630	<input type="checkbox"/>
Spreader	INS250 (45 mm) Front alignment base INS320/630 52.5 mm <input type="checkbox"/> 70 mm <input type="checkbox"/> One-piece INS250 <input type="checkbox"/> INS630 <input type="checkbox"/>	<input type="checkbox"/>
Cu cable lugs supplied with 2 or 3 inter-phase barriers	INS100/160 For 95 [□] cable INS250 For 120 [□] cable For 150 [□] cable For 185 [□] cable INS320/630 For 240 [□] cable For 300 [□] cable	<input type="checkbox"/>
Al cable lugs supplied with 2 or 3 inter-phase barriers	INS250 For 150 [□] cable INS320/630 For 185 [□] cable For 240 [□] cable For 300 [□] cable	<input type="checkbox"/>
Terminal shrouds	INS40/63/80 <input type="checkbox"/> INS100/125/160 <input type="checkbox"/>	<input type="checkbox"/>
Terminal shields	INS40/63/80 <input type="checkbox"/> INS100/125/160 <input type="checkbox"/> INS250 Long <input type="checkbox"/> INS320/630 Long <input type="checkbox"/> Long for 52.5 mm spreaders <input type="checkbox"/>	<input type="checkbox"/>
Interphase barriers	INS100/160 Set of 6 <input type="checkbox"/> INS250 Set of 6 <input type="checkbox"/> INS320/630 Set of 6 <input type="checkbox"/>	<input type="checkbox"/>

Indication and Measurements

4P ammeter module	For INS250	Rating	100 A	<input type="checkbox"/>
			150 A	<input type="checkbox"/>
			250 A	<input type="checkbox"/>
Adaptation kit required for direct handles	For INS320/630	Rating	400 A	<input type="checkbox"/>
			600 A	<input type="checkbox"/>
				<input type="checkbox"/>
4P current-transformer module	For INS250	Rating	100 A	<input type="checkbox"/>
			150 A	<input type="checkbox"/>
			250 A	<input type="checkbox"/>
	For INS320/630	Rating	400 A	<input type="checkbox"/>
			600 A	<input type="checkbox"/>
				<input type="checkbox"/>
Auxiliary contact	For INS40/160	1OF/CAF/CAO	Standard	<input type="checkbox"/>
			Low level	<input type="checkbox"/>
	For INS250/630	1 OF/CAM	Standard	<input type="checkbox"/>
			Low level	<input type="checkbox"/>

Rotary Handles

Extended front handles	INS40 to INS160	Black	<input type="checkbox"/>	Red on yellow front	<input type="checkbox"/>
	INS250	Black	<input type="checkbox"/>	Red on yellow front	<input type="checkbox"/>
	INS320 to INS630	Black	<input type="checkbox"/>	Red on yellow front	<input type="checkbox"/>
	For complete changeover assembly	INS250	<input type="checkbox"/>		<input type="checkbox"/>
		INS320/630	<input type="checkbox"/>		<input type="checkbox"/>

Locking of Rotary Handles

Padlocking	1 to 3 padlocks (in OFF position)	<input type="checkbox"/>
Keylocking	Keylock adapter (keylock not included)	<input type="checkbox"/>
	Keylocks Ronis 1351B.500 <input type="checkbox"/> Profalux KS5 B24 D4Z	<input type="checkbox"/>

Installation Accessories

Front-panel escutcheon	For switch-disconnectors	<input type="checkbox"/>
	For ammeter module, IP40	<input type="checkbox"/>

Order Form for Source-Changeover Systems for 2 Devices

ComPacT NSX100 to NSX630

Circuit Breakers and Switch-Disconnectors

To indicate your choices, check the applicable square boxes and enter the appropriate information in the rectangles .

Diagram for Two ComPacT NSX Devices

Without automatic control, without emergency off auxiliaries	(no. 51201177)	<input type="checkbox"/>
Without automatic control, with emergency off by MN	(no. 51201178)	<input type="checkbox"/>
Without automatic control, with emergency off by MX	(no. 51201179)	<input type="checkbox"/>

Mechanical Interlocking of Two NSX100 to NSX630 Devices

(fixed, plug-in)

Manually operated devices, mounted side by side:

Two devices with toggles	<input type="checkbox"/>
Two devices with rotary handles	<input type="checkbox"/>

Mechanical and Electrical Interlocking of Two NSX100 to NSX630 Devices

(fixed or plug-in)

Electrically operated devices, mounted side by side:

Select 1 base plate + IVE unit, the 4 auxiliary contacts and the options / accessories

Base plate + IVE unit	Identical voltages:	48 to 415 V AC 50/60 Hz	<input type="checkbox"/>	<input type="checkbox"/>
	24 to 250 V DC	440/480 V AC 60 Hz	<input type="checkbox"/>	
	"Normal" NSX100/250	"Replacement" NSX100/250	<input type="checkbox"/>	
	"Normal" NSX400/630	"Replacement" NSX400/630	<input type="checkbox"/>	
	"Normal" NSX400/630	"Replacement" NSX100/250	<input type="checkbox"/>	
	Adapter kit for NSX400/630 with NSX100/250 (plug-in)		<input type="checkbox"/>	
Auxiliary contacts	2 OF + 2 SDE (mandatory)		Quantity	<input type="text" value="4"/>
Options	Long rear connections	Plug-in base	<input type="checkbox"/>	
Downstream coupling accessory (for fixed version)	3P	NSX100/250	<input type="checkbox"/>	
	4P	NSX400/630	<input type="checkbox"/>	
Prefabricated wiring	Between device and IVE	Quantity	<input type="text"/>	

Automatic-Control Option

Power supply 220/240 V - 50/60 Hz:	ACP + BA controller	<input type="checkbox"/>
	ACP + UA controller	<input type="checkbox"/>
	ACP + UA150 controller	<input type="checkbox"/>
Power supply 380/415 V - 50/60 Hz and 440 V - 60 Hz:	ACP + BA controller	<input type="checkbox"/>
	ACP + UA controller	<input type="checkbox"/>
	ACP + UA150 controller	<input type="checkbox"/>



Order Form for Source-Changeover Systems for 2 devices

ComPacT NSX100 to NSX630

Circuit Breakers and Switch-Disconnectors

(One sheet per device, make copies if necessary)

Name of customer: _____
Address for delivery: _____

Requested delivery date: _____
Customer order no.: _____

To indicate your choices, check the applicable square boxes and enter the appropriate information in the rectangles

Q 1 - NORMAL SOURCE
Q 2 - REPLACEMENT SOURCE

Circuit Breaker or Switch Disconnecter

ComPacT type **NSX100/160/250** **NSX400/630**

Rating **A**

Circuit breaker **B, F, N, H, S, L**

Switch-discon. **NA**

No. of poles **2, 3 or 4**

No. of poles protected **2d, 3d or 4d**

Fixed device Front connections

Plug-in/withdr. Plug-in Withdrawable

Earth-leakage protection **ME, MH, MB**

Vigi module Voltage **V**
 4P option on 3P NSX

Trip Unit

Thermal-mag. **TMD** rating (16 ... 250 A)
TMG rating (16 ... 63 A)
MA rating (2.5 ... 220 A)

Electronic **MicroLogic 2.2** **MicroLogic 2.3**
MicroLogic 2.2 G **MicroLogic 2.3 AB**
MicroLogic 2.2 AB **MicroLogic 5.3 A**
MicroLogic 5.2 A **MicroLogic 5.3 E**
MicroLogic 5.2 E **MicroLogic 5.3 A-Z**
MicroLogic 5.2 A-Z **MicroLogic 6.3 A**
MicroLogic 6.2 A **MicroLogic 6.3 E**
MicroLogic 6.2 E **MicroLogic 1.3 M**
MicroLogic 2.2 M **MicroLogic 2.3 M**
MicroLogic 6.2 E-M **MicroLogic 6.3 E-M**
SDTAM module

External neutral CT

24 V DC power supply connector

ZSI wiring accessory for NS630b **MTZ1/MTZ2/MTZ3**

External power supply module 24-30 V DC 48-60 V DC
 100-125 V AC 110-130 V AC
 24 V DC 200-240 V AC 380-415 V AC

Battery module

Connection

Rear-connection kit Short Long
 Mixed

NSX100/250 connectors Snap-on 1.5° to 95° (< 160 A)
 Snap-on 25° to 95° (< 250 A)
 Snap-on 120° to 185° (< 250 A)
 Distribution 6 x 1.5° to 35°
 Aluminium 2 cables 50° to 120°

NSX400/630 connectors 1 cable 35° to 300°
 2 cables 35° to 240°

Right-angle terminal extensions

Straight extensions **NSX100/250**

Edgewise extensions 45° term. ext. Dbl.-L term. ext.

Spreader **NSX100/250** (one piece) (45 mm)
NSX400/630 (52.5 mm) (70 mm)

Cu cable lugs **NSX100/250** 120° 150° 185°
NSX400/630 240° 300°

Al cable lugs **NSX100/250** 150° 185°
NSX400/630 240° 300°

V mesrt Input For lugs NSX100/250 ≤ 185°
 For lugs NSX400/630

Terminal shields **NSX100/250** Long
NSX400/630 Long

Interphase barriers Long for 52.5 mm spreaders Set of 6

2 insulating scm. **NSX100/250** **NSX400/630** 70 pitch

Test Tool

Pocket battery for MicroLogic

Maintenance case

USB maintenance interface

Power supply 110-240 V AC

Spare MicroLogic cord

Indication and Measurement

Ammeter module Standard 3P 4P
 I max 3P

Current-transformer module 3P 4P

Current-transformer module + TCU 3P 4P

Insulation-monitoring module 3P 4P

Voltage-presence indicator

Auxiliary contact OF SD SDE SDV Standard
 OF SD SDE SDV Low level

SDE adapter (TM, MA or MicroLogic 2 trip units)

SDX module

Remote Operation

Electrical operation Motor mechanism AC DC V
 Voltage releases Instantaneous MX AC DC V
 Instantaneous MN AC DC V
 Fixed time delay MN AC DC V
 Adjust. time delay MN AC DC V

Rotary Handles

Direct Black Red and yellow front
 MCC conversion access. CNOMO conversion access.

Extended Black Red and yellow front
 Telescopic handle for withdrawable device

Indication auxiliary 1 early-break switch 2 early-make switches

Locking

Toggle (1 to 3 padlocks) Removable Fixed

Rotary handle Keylock adapter (keylock not included)
 Keylocks Ronis 1351B.500 Profalux KS5 B24 D4Z

Motor mechanism Keylock adapter + keylock Ronis (special) NSX100/250
 Keylock adapter (keylock not included) NSX400/630
 Keylocks Ronis 1351B.500 Profalux KS5 B24 D4Z

Interlocking

Mechanical Toggle operated Rotary Handle

By key (2 keylocks, 1 key) for rotary handle Locking kit without locks
 Keylocks Ronis 1351B.500 Profalux KS5 B24 D4Z

Installation Accessories

IP30 escutcheon for all types (toggle/rotary handle/motor mechanism)

IP30 escutcheon (with access to toggle + trip unit)

IP30 escutcheon for Vigi module

IP40 escutcheon for all types (toggle/rotary handle/motor mechanism)

IP40 escutcheon for Vigi module

IP40 escutcheon for Vigi or ammeter module

Toggle cover

Sealing accessories

DIN rail adapter

3P 60 mm busbar adapter

Plug-In / Withdrawable Configuration Accessories

Auxiliary connections 1 automatic connector fixed part with 9 wires (for base)
 1 automatic connector moving part with 9 wires (for circuit breaker)
 1 sup. for 3 auto. conn. moving parts 1 sup. for 2 auto. conn.
 9-wire manual auxiliary connector (fixed + moving)

Plug-in base accessories Long insulated terminals Set of 2
 2 IP4 shutters for base

Chassis accessories Escutcheon collar Toggle Vigi
 Locking kit (keylock not included)
 2 carriage switches (conn./disconnected position indication)

Parts or plug-in Plug-in base FC/RC 2P 3P 4P

Withdrawable kits Set of two power connections Standard Vigi
 Safety trip for advanced opening
 For 3P/4P chassis Moving part
 Fixed part

Adaptater for plug-in base (for terminal shield or interphase barriers)

Communication

NSX Cord L = 0.35 m NSX Cord L = 1.3 m
 NSX Cord U > 480 V AC L = 0.35 m NSX Cord L = 3 m

BSCM (NSX400/630)

Communicating motor mechanism 220-240 V

Switchboard front display module FDM121

FDM mounting accessory

Modbus interface

Stacking accessory

ULP line termination

RJ45 connectors Wire length RJ45 L = 0.3 m Wire length RJ45 L = 0.6 m
 female/female Wire length RJ45 L = 1 m Wire length RJ45 L = 2 m
 Wire length RJ45 L = 3 m Wire length RJ45 L = 5 m

Order form for source-changeover systems for 2 devices

ComPacT NS630b to NS1600

Circuit breakers and switch-disconnectors

To indicate your choices, check the applicable square boxes and enter the appropriate information in the rectangles .

Diagram for two ComPacT NS devices

Electrical interlocking with lockout after fault:

Permanent replacement source (with IVE unit)	(no. 51201183)	<input type="checkbox"/>
With emergency off by MX (with IVE unit)	(no. 51201184)	<input type="checkbox"/>
With emergency off by MN (with IVE unit)	(no. 51201185)	<input type="checkbox"/>

Interlocking using connecting rods between two NS630b to NS1600 devices

Manually operated devices installed side-by-side:

For two fixed NS devices with extended rotary handles

Electrically operated devices installed one above the other:

Select a complete set including two adaptation fixtures and the connecting rods

Complete set for:	2 fixed NS devices	<input type="checkbox"/>
	2 withdrawable NS devices	<input type="checkbox"/>

Interlocking using cables between two NS630b to NS1600 devices

Electrically operated devices installed one above the other or side-by-side:

Select a complete set including two adaptation fixtures and the cables

Complete set for:	2 fixed NS devices	<input type="checkbox"/>
	2 withdrawable NS devices	<input type="checkbox"/>
	1 fixed NS device + 1 withdrawable NS device	<input type="checkbox"/>

Electrical interlocking between two NS630b to NS1600 devices

1 IVE unit 48/415 V - 50/60 Hz and 440 V - 60 Hz	<input type="checkbox"/>
1 wiring kit for connection between 2 fixed / withdrawable devices to the IVE unit	<input type="checkbox"/>

Automatic-control option

Power supply 110 V - 50/60 Hz:	ACP + BA controller	<input type="checkbox"/>
	ACP + UA controller	<input type="checkbox"/>
	ACP + UA150 controller	<input type="checkbox"/>
Power supply 220/240 V - 50/60 Hz:	ACP + BA controller	<input type="checkbox"/>
	ACP + UA controller	<input type="checkbox"/>
	ACP + UA150 controller	<input type="checkbox"/>
Power supply 380/415 V - 50/60 Hz and 440 V - 60 Hz:	ACP + BA controller	<input type="checkbox"/>
	ACP + UA controller	<input type="checkbox"/>
	ACP + UA150 controller	<input type="checkbox"/>



Order Form for Source-Changeover Systems for 2 Devices ComPacT NS630b to NS1600 Circuit Breakers and Switch-Disconnectors

(One sheet per device, make copies if necessary)

Name of customer: _____
Address for delivery: _____

Requested delivery date: _____
Customer order no.: _____

To indicate your choices, check the applicable square boxes and enter the appropriate information in the rectangles

Device identification:
Q 1 - NORMAL SOURCE
Q 2 - REPLACEMENT SOURCE

Circuit Breaker or Switch Disconnecter

ComPacT type	NS630b to NS1600	<input type="checkbox"/>
Rating	A	<input type="checkbox"/>
Circuit breaker	N, H, L	<input type="checkbox"/>
Switch-disconnector	NA	<input type="checkbox"/>
Number of poles	3 or 4	<input type="checkbox"/>
Device	Fixed	<input type="checkbox"/>
	Withdr. with chassis	<input type="checkbox"/>
	Withdr. without chassis (moving part only)	<input type="checkbox"/>
Chassis alone without connections		<input type="checkbox"/>

MicroLogic Control Unit

Basic protection	2.0	<input type="checkbox"/>	5.0	<input type="checkbox"/>	6.0	<input type="checkbox"/>	7.0	<input type="checkbox"/>
A - ammeter	2.0	<input type="checkbox"/>	5.0	<input type="checkbox"/>	6.0	<input type="checkbox"/>	7.0	<input type="checkbox"/>
E - energy meter	2.0	<input type="checkbox"/>	5.0	<input type="checkbox"/>	6.0	<input type="checkbox"/>	7.0	<input type="checkbox"/>
P - power meter	5.0	<input type="checkbox"/>	6.0	<input type="checkbox"/>	7.0	<input type="checkbox"/>		<input type="checkbox"/>
AD - external power-supply module							V	<input type="checkbox"/>
TCE - external sensor (CT) for neutral protection								<input type="checkbox"/>
Rectangular sensor	280 x 115 mm	<input type="checkbox"/>						<input type="checkbox"/>
TCW - external sensor for SGR protection								<input type="checkbox"/>
LR - long-time rating plug	Standard 0.4 to 1 lr	<input type="checkbox"/>						<input type="checkbox"/>
	Low setting 0.4 to 0.8 lr	<input type="checkbox"/>						<input type="checkbox"/>
	High setting 0.8 to 1 lr	<input type="checkbox"/>						<input type="checkbox"/>
	LT OFF	<input type="checkbox"/>						<input type="checkbox"/>

Communication

Eco COM module Modbus	Device	<input type="checkbox"/>	Chassis	<input type="checkbox"/>
Front Display Module (FDM121)	Mounting accessory	<input type="checkbox"/>		<input type="checkbox"/>
Breaker ULP cord	L = 0.35 m	<input type="checkbox"/>		<input type="checkbox"/>
	L = 1.3 m	<input type="checkbox"/>		<input type="checkbox"/>
	L = 3 m	<input type="checkbox"/>		<input type="checkbox"/>

Connections

Horizontal rear connections	Top	<input type="checkbox"/>	Bottom	<input type="checkbox"/>
Vertical rear connections	Top	<input type="checkbox"/>	Bottom	<input type="checkbox"/>
Front connections	Top	<input type="checkbox"/>	Bottom	<input type="checkbox"/>
4x240 ^o bare cable connectors + shields	NS - FC fixed	<input type="checkbox"/>		<input type="checkbox"/>
Long connection shields	NS - FC fixed	<input type="checkbox"/>		<input type="checkbox"/>
Vertical-connection adapters	NS - FC fixed, withdr.	<input type="checkbox"/>		<input type="checkbox"/>
Cable-lug adapters	NS - FC fixed, withdr.	<input type="checkbox"/>		<input type="checkbox"/>
Arc chute screen	NS - FC fixed	<input type="checkbox"/>		<input type="checkbox"/>
Interphase barriers	NS - FC fixed, withdr.	<input type="checkbox"/>		<input type="checkbox"/>
Spreaders	NS - FC fixed, withdr.	<input type="checkbox"/>		<input type="checkbox"/>
VO - safety shutters on chassis	NS - FC fixed	<input type="checkbox"/>		<input type="checkbox"/>

Indication Contacts

SD trip indication (maximum 1)	6 A-240 V AC	<input type="checkbox"/>	Low level	<input type="checkbox"/>
SDE fault-trip indication (maximum 1) (SDE integrated in electrically operated devices)	6 A-240 V AC	<input type="checkbox"/>	Low level	<input type="checkbox"/>
OF ON/OFF indication contacts (maximum 3)	6 A-240 V AC	qty <input type="checkbox"/>	Low level	qty <input type="checkbox"/>
Carriage switches (possible combinations: 3 CE, 2 CD, 1 CT)				
CE - "connected" position	6 A-240 V AC	qty <input type="checkbox"/>	Low level	qty <input type="checkbox"/>
CD - "disconnected" position	6 A-240 V AC	qty <input type="checkbox"/>	Low level	qty <input type="checkbox"/>
CT - "test" position	6 A-240 V AC	qty <input type="checkbox"/>	Low level	qty <input type="checkbox"/>
Auxiliary terminals for chassis alone			Jumpers (set of 10)	<input type="checkbox"/>
	3-wire terminal (30 parts)	<input type="checkbox"/>	6-wire terminal (10 parts)	<input type="checkbox"/>

Remote Operation

Electrical operation	Standard	<input type="checkbox"/>	Communicating	<input type="checkbox"/>
Power supply	AC	<input type="checkbox"/>	DC	<input type="checkbox"/>
Voltage releases	MX	AC <input type="checkbox"/>	DC <input type="checkbox"/>	V <input type="checkbox"/>
	MN	AC <input type="checkbox"/>	DC <input type="checkbox"/>	V <input type="checkbox"/>
	MN delay unit	Adjustable <input type="checkbox"/>	Non-adjustable	<input type="checkbox"/>

Rotary Handles for Fixed and Withdrawable Device

Direct	Black	<input type="checkbox"/>	Red on yellow front	<input type="checkbox"/>
			CNOMO conversion access.	<input type="checkbox"/>
Extended	Black	<input type="checkbox"/>	Red on yellow front	<input type="checkbox"/>
			Telescopic handle for withdrawable device	<input type="checkbox"/>
Indication auxiliary	6 A-240 V AC		2 early-make switches	<input type="checkbox"/>
			2 early-break switches	<input type="checkbox"/>

Locking

Toggle (1 to 3 padlocks)	Removable system	<input type="checkbox"/>	Fixed system	<input type="checkbox"/>
Rotary handle using a keylock	OFF position	<input type="checkbox"/>	ON and OFF positions	<input type="checkbox"/>
	Ronis 1351B.500	<input type="checkbox"/>	Profalux KS5 B24 D4Z	<input type="checkbox"/>
	Keylock kit (without keylock)	<input type="checkbox"/>		<input type="checkbox"/>
For electrically operated devices	VBP - ON/OFF pushbutton locking	<input type="checkbox"/>		<input type="checkbox"/>
	OFF position locking:			
	VCPO - by padlocks	<input type="checkbox"/>		<input type="checkbox"/>
	VSPO - by keylocks	<input type="checkbox"/>		<input type="checkbox"/>
	Keylock kit (w/o keylock)	Profalux <input type="checkbox"/>	Ronis <input type="checkbox"/>	<input type="checkbox"/>
	1 keylock	Profalux <input type="checkbox"/>	Ronis <input type="checkbox"/>	<input type="checkbox"/>
	2 identical keylocks, 1 key	Profalux <input type="checkbox"/>	Ronis <input type="checkbox"/>	<input type="checkbox"/>
Chassis locking in "disconnected" position:				
VSPD - by keylocks	Keylock kit (w/o keylock)	Profalux <input type="checkbox"/>	Ronis <input type="checkbox"/>	<input type="checkbox"/>
		Kirk <input type="checkbox"/>	Castell <input type="checkbox"/>	<input type="checkbox"/>
	1 keylock	Profalux <input type="checkbox"/>	Ronis <input type="checkbox"/>	<input type="checkbox"/>
	2 identical keylocks, 1 key	Profalux <input type="checkbox"/>	Ronis <input type="checkbox"/>	<input type="checkbox"/>
	2 keylocks, different keys	Profalux <input type="checkbox"/>	Ronis <input type="checkbox"/>	<input type="checkbox"/>
	Optional connected/disconnected/test position locking			<input type="checkbox"/>
VPEC - door interlock			On right-hand side of chassis	<input type="checkbox"/>
			On left-hand side of chassis	<input type="checkbox"/>
VPOC - racking interlock				<input type="checkbox"/>
VDC - mismatch protection				<input type="checkbox"/>

Accessories

CDM - mechanical operation counter	<input type="checkbox"/>
CDP - escutcheon	<input type="checkbox"/>
CP - transparent cover for escutcheon	<input type="checkbox"/>
OP - blanking plate for escutcheon	<input type="checkbox"/>
Mounting brackets for fixed NS	For mounting on horizontal plane <input type="checkbox"/>
Test kits	Mini <input type="checkbox"/> Portable test kit <input type="checkbox"/>

Order Form for Source-Changeover Systems for 2 Devices

MasterPacT MTZ1/MTZ2/MTZ3

Circuit Breakers and Switch-Disconnectors

To indicate your choices, check the applicable square boxes and enter the appropriate information in the rectangles .

Diagram for 2 MasterPacT MTZ1/MTZ2/MTZ3 Devices

Electrical interlocking with lockout after fault:

Permanent replacement source (with IVE unit)	<input type="checkbox"/>
With emergency off by MX (with IVE unit)	<input type="checkbox"/>
With emergency off by MN (with IVE unit)	<input type="checkbox"/>
Automatic control with lockout after fault:	
Permanent replacement source (with IVE unit)	<input type="checkbox"/>
Engine generator set (with IVE unit)	<input type="checkbox"/>

Interlocking Using Connecting Rods (MTZ1/MTZ2/MTZ3 devices one above the other)

Select a complete set including two adaptation fixtures and the connecting rods

Complete set for:	2 drawout MTZ1	<input type="checkbox"/>	2 fixed MTZ1	<input type="checkbox"/>
	2 drawout MTZ2/3	<input type="checkbox"/>	2 fixed MTZ2/3	<input type="checkbox"/>
	1 fixed MTZ1 device + 1 fixed MTZ2/3 device			<input type="checkbox"/>
	1 drawout MTZ1 device + 1 drawout MTZ2/3 device			<input type="checkbox"/>

Interlocking Using Cables (MTZ1/MTZ2/MTZ3 devices one above the other or side-by-side)

Select two adaptation fixtures (one for each device) and a set of two cables

Adaptation fixture for:	1 fixed MTZ1 device	qty	<input type="checkbox"/>
(MTZ1/MTZ2/3 fixed and drawout devices may be mixed)	1 drawout MTZ1 device	qty	<input type="checkbox"/>
	1 fixed MTZ2/3 device	qty	<input type="checkbox"/>
	1 drawout MTZ2/3 device	qty	<input type="checkbox"/>
	1 set of 2 cables (for two devices)		<input type="checkbox"/>

Electrical Interlocking 2 MasterPacT MTZ1/MTZ2/MTZ3 Devices

1 IVE unit 48/415 V - 50/60 Hz and 440 V - 60 Hz	<input type="checkbox"/>
1 wiring kit for connection between 2 fixed / withdrawable devices to the IVE unit	<input type="checkbox"/>

Automatic-Control Option

Power supply 220/240 V - 50/60 Hz:	ACP + BA controller	<input type="checkbox"/>
	ACP + UA controller	<input type="checkbox"/>
	ACP + UA150 controller	<input type="checkbox"/>
Power supply 380/415 V - 50/60 Hz and 440 V - 60 Hz:	ACP + BA controller	<input type="checkbox"/>
	ACP + UA controller	<input type="checkbox"/>
	ACP + UA150 controller	<input type="checkbox"/>



Order Form for Source-Changeover Systems for 2 devices MasterPacT MTZ1/MTZ2/MTZ3 Circuit Breakers and Switch-Disconnectors

(One sheet per device, make copies if necessary)

Name of customer: _____

Address for delivery: _____

Requested delivery date: _____

Customer order no.: _____

To indicate your choices, check the applicable square boxes and enter the appropriate information in the rectangles

Device identification: _____

Q 1 - NORMAL SOURCE

Q 2 - REPLACEMENT SOURCE

Circuit Breaker or Switch Disconnecter

MasterPacT type	MTZ1	MTZ2/MTZ3	<input type="checkbox"/>
Rating	A		<input type="checkbox"/>
Sensor rating	A		<input type="checkbox"/>
Circuit breaker	N1, H1, H2, H3, L1		<input type="checkbox"/>
Switch-disconnector	NA, HA, HF, ES, HA10 (MTZ2/3)		<input type="checkbox"/>
Number of poles	3 or 4		<input type="checkbox"/>
Option: neutral on right side			<input type="checkbox"/>
Device	Fixed		<input type="checkbox"/>
	Withdr. with chassis		<input type="checkbox"/>
	Withdr. without chassis (moving part only)		<input type="checkbox"/>
Chassis alone without connections			<input type="checkbox"/>

MicroLogic Control Unit

LI	2.X	<input type="checkbox"/>
LSI	5.X	<input type="checkbox"/>
LSIG	6.X	<input type="checkbox"/>
LSIV	7.X	<input type="checkbox"/>
AD - external power-supply module		<input type="checkbox"/>
TCE - external sensor (CT) for neutral protection		<input type="checkbox"/>
Rectangular sensor for earth-leakage protection	MTZ1 (280 x 115 mm)	<input type="checkbox"/>
	MTZ2/3 (470 x 160 mm)	<input type="checkbox"/>
LR - long-time rating plug	Standard 0.4 to 1 Ir	<input type="checkbox"/>
	Low setting 0.4 to 0.8 Ir	<input type="checkbox"/>
	High setting 0.8 to 1 Ir	<input type="checkbox"/>
	LT OFF	<input type="checkbox"/>
PTE - external voltage measurement input (required for reverse supply)		<input type="checkbox"/>
BAT - battery module		<input type="checkbox"/>

Communication

Eco COM module	Modbus	Device	<input type="checkbox"/>	Chassis	<input type="checkbox"/>
Front Display Module (FDM121)		Mounting accessory	<input type="checkbox"/>		<input type="checkbox"/>
Breaker ULP cord	L = 0.35 m		<input type="checkbox"/>		<input type="checkbox"/>
	L = 1.3 m		<input type="checkbox"/>		<input type="checkbox"/>
	L = 3 m		<input type="checkbox"/>		<input type="checkbox"/>
ULP port			<input type="checkbox"/>	IFM	<input type="checkbox"/>
ULP cord			<input type="checkbox"/>	EIFE	<input type="checkbox"/>
I/O module			<input type="checkbox"/>	FDM128	<input type="checkbox"/>
IFE			<input type="checkbox"/>		<input type="checkbox"/>

Connections

Horizontal	Top	<input type="checkbox"/>	Bottom	<input type="checkbox"/>
Vertical	Top	<input type="checkbox"/>	Bottom	<input type="checkbox"/>
Front	Top	<input type="checkbox"/>	Bottom	<input type="checkbox"/>
Vertical-connection adapters	MTZ1 - FC fixed, draw.	<input type="checkbox"/>		<input type="checkbox"/>
Cable-lug adapters	MTZ1 - FC fixed, draw.	<input type="checkbox"/>		<input type="checkbox"/>
Arc chute screen	MTZ1 - FC fixed	<input type="checkbox"/>		<input type="checkbox"/>
Interphase barriers	MTZ1 - MTZ2/3 fixed, draw.	<input type="checkbox"/>		<input type="checkbox"/>
Spreaders	MTZ1 fixed, drawout	<input type="checkbox"/>		<input type="checkbox"/>
Disconnectable front connection adapter	MTZ2/3 fixed	<input type="checkbox"/>		<input type="checkbox"/>
Lugs for 240° or 300° cables	MTZ2/3 fixed, drawout	<input type="checkbox"/>		<input type="checkbox"/>
VO - safety shutters on chassis	MTZ1, MTZ2/3			<input checked="" type="checkbox"/>
VIVC - shutter position indication and locking	MTZ2/3			<input type="checkbox"/>

Indication Contacts

OF - ON/OFF indication contacts

Standard	4 OF 6 A-240 V AC (10 A-240 V AC and low-level for MTZ2/3)		
Additional	1 block of 4 OF for MTZ2/3	max. 2	qty <input type="checkbox"/>
EF - combined "connected/closed" contacts			
	1 EF 6 A-240 V AC for MTZ2/3	max. 8	qty <input type="checkbox"/>
	1 EF low-level for MTZ2/3	max. 8	qty <input type="checkbox"/>
SDE - "fault-trip" indication contact			
Standard	1 SDE 6 A-240 V AC		
Additional	1 SDE 6 A-240 V AC	<input type="checkbox"/>	1 SDE Low level <input type="checkbox"/>
Programmable contacts			
Carriage switches	6 A-240 V AC	<input type="checkbox"/>	2 M2C contacts <input type="checkbox"/>
			Low level <input type="checkbox"/>
CE - "connected" position	max. 3 for MTZ2/3 / MTZ1		qty <input type="checkbox"/>
CD - "disconnected" position	max. 3 for MTZ2/3, 2 for MTZ1		qty <input type="checkbox"/>
CT - "test" position	max. 3 for MTZ2/3, 1 for MTZ1		qty <input type="checkbox"/>
AC - MTZ2/3 actuator for 6 CE - 3 CD - 0 CT additional carriage switches			qty <input type="checkbox"/>

Remote Operation

Remote ON/OFF

MCH - gear motor		<input type="checkbox"/>
XF - closing voltage release		<input type="checkbox"/>
MX - opening voltage release		<input type="checkbox"/>
PF - "ready to close" contact	Low level 6 A-240 V AC	<input type="checkbox"/>
BPFE - electrical closing pushbutton		<input type="checkbox"/>
Res - electrical reset option		<input type="checkbox"/>
RAR - automatic reset option		<input type="checkbox"/>
Remote tripping		
MN - undervoltage release		<input type="checkbox"/>
R - delay unit (non-adjustable)		<input type="checkbox"/>
Rr - adjustable delay unit		<input type="checkbox"/>
2nd MX - shunt release		<input type="checkbox"/>

Locking

VBP - ON/OFF pushbutton locking (by transparent cover + padlocks)

OFF position locking:

VCPO - by padlocks

VSP0 - by keylocks

Keylock kit (w/o keylock)	Profalux	<input type="checkbox"/>	Ronis	<input type="checkbox"/>
	Kirk	<input type="checkbox"/>	Castell	<input type="checkbox"/>
1 keylock	Profalux	<input type="checkbox"/>	Ronis	<input type="checkbox"/>
2 identical keylocks, 1 key	Profalux	<input type="checkbox"/>	Ronis	<input type="checkbox"/>
2 keylocks, different keys (MTZ2/3)	Profalux	<input type="checkbox"/>	Ronis	<input type="checkbox"/>

Chassis locking in "disconnected" position:

VSPD - by keylocks

Keylock kit (w/o keylock)	Profalux	<input type="checkbox"/>	Ronis	<input type="checkbox"/>
	Kirk	<input type="checkbox"/>	Castell	<input type="checkbox"/>
1 keylock	Profalux	<input type="checkbox"/>	Ronis	<input type="checkbox"/>
2 identical keylocks, 1 key	Profalux	<input type="checkbox"/>	Ronis	<input type="checkbox"/>
2 keylocks, different keys	Profalux	<input type="checkbox"/>	Ronis	<input type="checkbox"/>
Optional connected/disconnected/test position locking				<input type="checkbox"/>

VPEC - door interlock

	On right-hand side of chassis	<input type="checkbox"/>
	On left-hand side of chassis	<input type="checkbox"/>

VPOC - racking interlock

IPA - cable-type door interlock

IBPO - racking interlock between crank and OFF pushbutton for MTZ2/3

DAE - automatic spring discharge before breaker removal for MTZ2/3

VDC - mismatch protection device - chassis

Accessories

CDM - mechanical operation counter

CB - auxiliary terminal shield for chassis

CDP - escutcheon

CP - transparent cover for escutcheon

OP - blanking plate for escutcheon

Brackets for mounting MTZ2/3 fixed On backplates

Order Form for Source-Changeover Systems for 3 Devices

MasterPacT MTZ2/MTZ3

Circuit Breakers and Switch-Disconnectors

To indicate your choices, check the applicable square boxes and enter the appropriate information in the rectangles .

Diagram for 3 MasterPacT MTZ2/MTZ3 Devices

2 "Normal" sources + 1 "Replacement" source:		
Electrical interlocking without lockout after fault		<input type="checkbox"/>
Electrical interlocking with lockout after fault		<input type="checkbox"/>
2 "Normal" sources + 1 "Replacement" source with source selection:		
Automatic control w/ engine generator set w/o lockout after fault		<input type="checkbox"/>
Automatic control w/ engine generator set w/ lockout after fault		<input type="checkbox"/>
3 sources, only 1 device ON:		
Electrical interlocking without lockout after fault		<input type="checkbox"/>
Electrical interlocking with lockout after fault		<input type="checkbox"/>
2 "Normal" sources + 1 coupling:		
Electrical interlocking without lockout after fault		<input type="checkbox"/>
Electrical interlocking with lockout after fault		<input type="checkbox"/>
Automatic control with lockout after fault:		<input type="checkbox"/>

Interlocking Using Cables (MTZ2/MTZ3 devices one above the other or side-by-side)

Select a complete set including three adaptation fixtures and the cables		
1 complete set for:	3 sources / 1 device ON, fixed or drawout	<input type="checkbox"/>
	2 sources + 1 coupling, fixed or drawout	<input type="checkbox"/>
	2 sources + 1 replacement source, fixed or drawout	<input type="checkbox"/>



Order Form for Source-Changeover Systems for 3 Devices

MasterPacT MTZ2/MTZ3

Circuit Breakers and Switch-Disconnectors

To indicate your choices, check the applicable square boxes and enter the appropriate information in the rectangles .

(one sheet per device, make copies if necessary)

Device identification:

Q 1 - NORMAL SOURCE

Q 2 - REPLACEMENT SOURCE

Circuit breaker or Switch-Disconnecter

MasterPacT type	MTZ2/MTZ3	<input type="checkbox"/>
Rating	A	<input type="checkbox"/>
Sensor rating	A	<input type="checkbox"/>
Circuit breaker	N1, H1, H2, H3, L1	<input type="checkbox"/>
Switch-disconnector	NA, HA, HF	<input type="checkbox"/>
Number of poles	3 or 4	<input type="checkbox"/>
Option: neutral on right side		<input type="checkbox"/>
Device	Fixed	<input type="checkbox"/>
	Drawout with chassis	<input type="checkbox"/>
	Drawout without chassis (moving part only)	<input type="checkbox"/>
Chassis alone without connections		<input type="checkbox"/>

MicroLogic Control Unit

LI	2.X	<input type="checkbox"/>
LSI	5.X	<input type="checkbox"/>
LSIG	6.X	<input type="checkbox"/>
LSIV	7.X	<input type="checkbox"/>
AD - external power-supply module	V	<input type="checkbox"/>
TCE - external sensor (CT) for neutral protection		<input type="checkbox"/>
Rectangular sensor	470 x 160 mm	<input type="checkbox"/>
for earth-leakage protection		<input type="checkbox"/>
TCW - external sensor for SGR protection		<input type="checkbox"/>
LR - long-time rating plug	Standard 0.4 to 1 Ir	<input type="checkbox"/>
	Low setting 0.4 to 0.8 Ir	<input type="checkbox"/>
	High setting 0.8 to 1 Ir	<input type="checkbox"/>
	LT OFF	<input type="checkbox"/>
PTE - external voltage measurement input (required for reverse supply)		<input type="checkbox"/>
BAT - battery module		<input type="checkbox"/>

Communication

Eco COM module Modbus	Device	<input type="checkbox"/>	Chassis	<input type="checkbox"/>
Front Display Module (FDM121)	Mounting accessory	<input type="checkbox"/>		<input type="checkbox"/>
Breaker ULP cord	L = 0.35 m	<input type="checkbox"/>		<input type="checkbox"/>
	L = 1.3 m	<input type="checkbox"/>		<input type="checkbox"/>
	L = 3 m	<input type="checkbox"/>		<input type="checkbox"/>
ULP port		<input type="checkbox"/>	IFM	<input type="checkbox"/>
ULP cord		<input type="checkbox"/>	EIFE	<input type="checkbox"/>
I/O module		<input type="checkbox"/>	FDM128	<input type="checkbox"/>
IFE		<input type="checkbox"/>		<input type="checkbox"/>

Connections

Horizontal	Top	<input type="checkbox"/>	Bottom	<input type="checkbox"/>
Vertical	Top	<input type="checkbox"/>	Bottom	<input type="checkbox"/>
Front	Top	<input type="checkbox"/>	Bottom	<input type="checkbox"/>
Interphase barriers	Fixed, drawout	<input type="checkbox"/>		<input type="checkbox"/>
Disconnectable front connection adapter	Fixed	<input type="checkbox"/>		<input type="checkbox"/>
VO - safety shutters on chassis		<input checked="" type="checkbox"/>		<input type="checkbox"/>
VIVC - shutter position indication and locking		<input type="checkbox"/>		<input type="checkbox"/>

Indication Contacts

OF - ON/OFF indication contacts			
Standard	4 OF 6 A-240 V AC (10 A-240 V AC and low-level)		
Additional	1 block of 4 OF	max. 2	qty <input type="checkbox"/>
EF - combined "connected/closed" contacts			
	1 EF 6 A-240 V AC	max. 8	qty <input type="checkbox"/>
	1 EF low-level	max. 8	qty <input type="checkbox"/>
SDE - "fault-trip" indication contact			
Standard	1 SDE 6 A-240 V AC		
Additional	1 SDE 6 A-240 V AC	<input type="checkbox"/>	1 SDE Low level <input type="checkbox"/>
Programmable contacts			
			2 M2C contacts <input type="checkbox"/>
Carriage switches	6 A-240 V AC	<input type="checkbox"/>	Low level <input type="checkbox"/>
CE - "connected" position	Max. 3		qty <input type="checkbox"/>
CD - "disconnected" position	Max. 3		qty <input type="checkbox"/>
CT - "test" position	Max. 3		qty <input type="checkbox"/>
AC - MTZ2/3 actuator for 6 CE - 3 CD - 0 CT additional carriage switches			qty <input type="checkbox"/>

Remote Operation

Remote ON/OFF	MCH - gear motor	V	<input type="checkbox"/>
	XF - closing voltage release	V	<input type="checkbox"/>
	MX - opening voltage release	V	<input type="checkbox"/>
	PF - "ready to close" contact	Low level	<input type="checkbox"/>
		6 A-240 V AC	<input type="checkbox"/>
Remote tripping	BPFE - electrical closing pushbutton		<input type="checkbox"/>
	Res - electrical reset option	V	<input type="checkbox"/>
	RAR - automatic reset option		<input type="checkbox"/>
	MN - undervoltage release	V	<input type="checkbox"/>
	R - delay unit (non-adjustable)		<input type="checkbox"/>
	Rr - adjustable delay unit		<input type="checkbox"/>
	2^{eme} MX - shunt release	V	<input type="checkbox"/>

Locking

VBP - ON/OFF pushbutton locking (by transparent cover + padlocks)				<input type="checkbox"/>
OFF position locking:				
VCPO - by padlocks				<input type="checkbox"/>
VSP0 - by keylocks	Keylock kit (w/o keylock)	Profalux	<input type="checkbox"/>	Ronis <input type="checkbox"/>
		Kirk	<input type="checkbox"/>	Castell <input type="checkbox"/>
	1 keylock	Profalux	<input type="checkbox"/>	Ronis <input type="checkbox"/>
	2 identical keylocks, 1 key	Profalux	<input type="checkbox"/>	Ronis <input type="checkbox"/>
	2 keylocks (MTZ2/3)	Profalux	<input type="checkbox"/>	Ronis <input type="checkbox"/>
Chassis locking in "disconnected" position:				
VSPD - by keylocks	Keylock kit (w/o keylock)	Profalux	<input type="checkbox"/>	Ronis <input type="checkbox"/>
		Kirk	<input type="checkbox"/>	Castell <input type="checkbox"/>
	1 keylock	Profalux	<input type="checkbox"/>	Ronis <input type="checkbox"/>
	2 identical keylocks, 1 key	Profalux	<input type="checkbox"/>	Ronis <input type="checkbox"/>
	2 keylocks, different keys	Profalux	<input type="checkbox"/>	Ronis <input type="checkbox"/>
	Optional connected/disconnected/test position locking			<input type="checkbox"/>
VPEC - door interlock			On right-hand side of chassis	<input type="checkbox"/>
			On left-hand side of chassis	<input type="checkbox"/>
VPOC - racking interlock				<input type="checkbox"/>
IPA - cable-type door interlock				<input type="checkbox"/>
IBPO - racking interlock between crank and OFF pushbutton for MTZ2/3				<input type="checkbox"/>
DAE - automatic spring discharge before breaker removal for MTZ2/3				<input type="checkbox"/>
VDC - mismatch protection				<input type="checkbox"/>

Accessories

CDM - mechanical operation counter	<input type="checkbox"/>
CB - auxiliary terminal shield for chassis	<input type="checkbox"/>
CDP - escutcheon	<input type="checkbox"/>
CP - transparent cover for escutcheon	<input type="checkbox"/>
OP - blanking plate for escutcheon	<input type="checkbox"/>
Brackets for mounting MTZ2/3 fixed	On backplates <input type="checkbox"/>



Life Is On | **Schneider**
Electric

Schneider Electric Industries SAS

35, rue Joseph Monier
CS 30323
92506 Rueil Malmaison Cedex
France

RCS Nanterre 954 503 439
Capital social 928 298 512 €
www.se.com

07-2024

