

SpaceLogic KNX Hybrid Module

LSS100400

User Guide

This document describes the SpaceLogic KNX Hybrid solution (features and user interface), which consist of a DIN device and the plugin.

Release date 05/2025



Legal Information

The information provided in this document contains general descriptions, technical characteristics and/or recommendations related to products/solutions.

This document is not intended as a substitute for a detailed study or operational and site-specific development or schematic plan. It is not to be used for determining suitability or reliability of the products/solutions for specific user applications. It is the duty of any such user to perform or have any professional expert of its choice (integrator, specifier or the like) perform the appropriate and comprehensive risk analysis, evaluation and testing of the products/solutions with respect to the relevant specific application or use thereof.

The Schneider Electric brand and any trademarks of Schneider Electric SE and its subsidiaries referred to in this document are the property of Schneider Electric SE or its subsidiaries. All other brands may be trademarks of their respective owner.

This document and its content are protected under applicable copyright laws and provided for informative use only. No part of this document may be reproduced or transmitted in any form or by any means (electronic, mechanical, photocopying, recording, or otherwise), for any purpose, without the prior written permission of Schneider Electric.

Schneider Electric does not grant any right or license for commercial use of the document or its content, except for a non-exclusive and personal license to consult it on an "as is" basis.

Schneider Electric reserves the right to make changes or updates with respect to or in the content of this document or the format thereof, at any time without notice.

To the extent permitted by applicable law, no responsibility or liability is assumed by Schneider Electric and its subsidiaries for any errors or omissions in the informational content of this document, as well as any non-intended use or misuse of the content thereof.

Table of Contents

Safety Information.....	4
Before You Begin.....	5
Start-up and Test.....	6
Operation and Adjustments.....	7
About the Book.....	8
Introduction.....	10
Workflow.....	12
Hybrid Module Firmware Upgrade.....	13
Getting Started.....	14
New Wiser for KNX/spaceLYnk Installation.....	14
Existing Wiser for KNX/spaceLYnk Installation.....	15
Launching the Start Page.....	16
Devices.....	17
Preparing Your Module for Pairing.....	17
Pairing the Device.....	17
Device Pairing Mode.....	19
Resetting the Device.....	20
Device Actions.....	20
Help.....	20
Device Firmware Upgrade.....	21
Allow Joining through This Device.....	21
Identify Device.....	22
Device Information.....	22
Device Control and Status.....	23
Setting Device Parameters.....	23
Device Configuration.....	27
Delete ZigBee Devices.....	36
Extend Device Functionality.....	36
Touch Visualization.....	38
Groups.....	39
Monitor.....	40
Configuration.....	41
Add Install Code.....	42
Network Map.....	43
Logs.....	44
Supported Devices.....	45
Actuators.....	45
Battery Push-buttons.....	47
PIR/Actuators.....	48
Sensors.....	48
Sockets.....	48
Thermostats.....	49
Elko Smart.....	49
License Information.....	52

Safety Information

Important Information

Read these instructions carefully, and look at the equipment to become familiar with the device before trying to install, operate, service, or maintain it. The following special messages may appear throughout this documentation or on the equipment to warn of potential hazards or to call attention to information that clarifies or simplifies a procedure.



The addition of this symbol to a “Danger” or “Warning” safety label indicates that an electrical hazard exists which will result in personal injury if the instructions are not followed.



This is the safety alert symbol. It is used to alert you to potential personal injury hazards. Obey all safety messages that follow this symbol to avoid possible injury or death.

DANGER

DANGER indicates a hazardous situation which, if not avoided, **will result in** death or serious injury.

WARNING

WARNING indicates a hazardous situation which, if not avoided, **could result in** death or serious injury.

CAUTION

CAUTION indicates a hazardous situation which, if not avoided, **could result in** minor or moderate injury.

NOTICE

NOTICE is used to address practices not related to physical injury.



The addition of this symbol to a “Danger” or “Warning” safety label indicates that an electrical hazard exists which will result in personal injury if the instructions are not followed.



This is the safety alert symbol. It is used to alert you to potential personal injury hazards. Obey all safety messages that follow this symbol to avoid possible injury or death.

⚠ DANGER
DANGER indicates a hazardous situation which, if not avoided, will result in death or serious injury.

⚠ WARNING
WARNING indicates a hazardous situation which, if not avoided, could result in death or serious injury.

⚠ CAUTION
CAUTION indicates a hazardous situation which, if not avoided, could result in minor or moderate injury.

NOTICE
NOTICE is used to address practices not related to physical injury.

Please Note

Electrical equipment should be installed, operated, serviced, and maintained only by qualified personnel. No responsibility is assumed by Schneider Electric for any consequences arising out of the use of this material.

A qualified person is one who has skills and knowledge related to the construction and operation of electrical equipment and its installation, and has received safety training to recognize and avoid the hazards involved.

Before You Begin

Do not use this product on machinery lacking effective point-of-operation guarding. Lack of effective point-of-operation guarding on a machine can result in serious injury to the operator of that machine.

⚠ WARNING
UNGUARDED EQUIPMENT
<ul style="list-style-type: none"> • Do not use this software and related automation equipment on equipment which does not have point-of-operation protection. • Do not reach into machinery during operation.
Failure to follow these instructions can result in death, serious injury, or equipment damage.

This automation equipment and related software is used to control a variety of industrial processes. The type or model of automation equipment suitable for each application will vary depending on factors such as the control function required, degree of protection required, production methods, unusual conditions,

government regulations, etc. In some applications, more than one processor may be required, as when backup redundancy is needed.

Only you, the user, machine builder or system integrator can be aware of all the conditions and factors present during setup, operation, and maintenance of the machine and, therefore, can determine the automation equipment and the related safeties and interlocks which can be properly used. When selecting automation and control equipment and related software for a particular application, you should refer to the applicable local and national standards and regulations. The National Safety Council's Accident Prevention Manual (nationally recognized in the United States of America) also provides much useful information.

In some applications, such as packaging machinery, additional operator protection such as point-of-operation guarding must be provided. This is necessary if the operator's hands and other parts of the body are free to enter the pinch points or other hazardous areas and serious injury can occur. Software products alone cannot protect an operator from injury. For this reason the software cannot be substituted for or take the place of point-of-operation protection.

Ensure that appropriate safeties and mechanical/electrical interlocks related to point-of-operation protection have been installed and are operational before placing the equipment into service. All interlocks and safeties related to point-of-operation protection must be coordinated with the related automation equipment and software programming.

NOTE: Coordination of safeties and mechanical/electrical interlocks for point-of-operation protection is outside the scope of the Function Block Library, System User Guide, or other implementation referenced in this documentation.

Start-up and Test

Before using electrical control and automation equipment for regular operation after installation, the system should be given a start-up test by qualified personnel to verify correct operation of the equipment. It is important that arrangements for such a check are made and that enough time is allowed to perform complete and satisfactory testing.

▲ WARNING

EQUIPMENT OPERATION HAZARD

- Verify that all installation and set up procedures have been completed.
- Before operational tests are performed, remove all blocks or other temporary holding means used for shipment from all component devices.
- Remove tools, meters, and debris from equipment.

Failure to follow these instructions can result in death, serious injury, or equipment damage.

Follow all start-up tests recommended in the equipment documentation. Store all equipment documentation for future references.

Software testing must be done in both simulated and real environments.

Verify that the completed system is free from all short circuits and temporary grounds that are not installed according to local regulations (according to the National Electrical Code in the U.S.A, for instance). If high-potential voltage testing is necessary, follow recommendations in equipment documentation to prevent accidental equipment damage.

Before energizing equipment:

- Remove tools, meters, and debris from equipment.
- Close the equipment enclosure door.
- Remove all temporary grounds from incoming power lines.

- Perform all start-up tests recommended by the manufacturer.

Operation and Adjustments

The following precautions are from the NEMA Standards Publication ICS 7.1-1995:

(In case of divergence or contradiction between any translation and the English original, the original text in the English language will prevail.)

- Regardless of the care exercised in the design and manufacture of equipment or in the selection and ratings of components, there are hazards that can be encountered if such equipment is improperly operated.
- It is sometimes possible to misadjust the equipment and thus produce unsatisfactory or unsafe operation. Always use the manufacturer's instructions as a guide for functional adjustments. Personnel who have access to these adjustments should be familiar with the equipment manufacturer's instructions and the machinery used with the electrical equipment.
- Only those operational adjustments required by the operator should be accessible to the operator. Access to other controls should be restricted to prevent unauthorized changes in operating characteristics.

About the Book

Document Scope

This document describes the SpaceLogic KNX Hybrid solution (features and user interface), which consist of a DIN device and the plugin.

Validity Note

This user guide is applicable to the Hybrid plugin and the LSS100400 SpaceLogic KNX Hybrid Module. It provides detailed instructions on the installation, configuration, and usage of these components. Ensure you are referring to the latest version of this document to access the most up-to-date information and features. For any updates or additional support, please visit the official Schneider Electric website.

General Cybersecurity Information

In recent years, the growing number of networked machines and production plants has seen a corresponding increase in the potential for cyber threats, such as unauthorized access, data breaches, and operational disruptions. You must, therefore, consider all possible cybersecurity measures to help protect assets and systems against such threats.

To help keep your Schneider Electric products secure and protected, it is in your best interest to implement the cybersecurity best practices as described in the [Cybersecurity Best Practices](#) document.

Schneider Electric provides additional information and assistance:

- [Subscribe to the Schneider Electric security newsletter.](#)
- [Visit the Cybersecurity Support Portal web page to:](#)
 - [Find Security Notifications.](#)
 - [Report vulnerabilities and incidents.](#)
- [Visit the Schneider Electric Cybersecurity and Data Protection Posture web page to:](#)
 - [Access the cybersecurity posture.](#)
 - [Learn more about cybersecurity in the cybersecurity academy.](#)
 - [Explore the cybersecurity services from Schneider Electric.](#)

Available Languages of the Document

The document is available in these languages:

- English
- German

Related Documents

[SpaceLogic KNX Hybrid Module, LSS100400, Installation and connection](#)

To find documents online, visit the Schneider Electric download center (www.se.com/ww/en/download/).

Information on Non-Inclusive or Insensitive Terminology

As a responsible, inclusive company, Schneider Electric is constantly updating its communications and products that contain non-inclusive or insensitive terminology. However, despite these efforts, our content may still contain terms that are deemed inappropriate by some customers.

Trademarks

This guide refers to system and brand names that are trademarks of their relevant owners.

- Zigbee alliance is now rebranded as CSA Connectivity Standards Alliance: <https://csa-iot.org/>.
- Apple® and App Store® are brand names or registered trademarks of Apple Inc.
- Google Play™ Store and Android™ are brand names or registered trademarks of Google Inc.
- Wi-Fi® is a registered trademark of Wi-Fi Alliance®.
- Wiser™ is a trademark and the property of Schneider Electric, its subsidiaries and affiliated companies.

Other brands and registered trademarks are the property of their respective owners.

Introduction

This document describes the Hybrid plugin, the LSS100400 SpaceLogic KNX Hybrid Module features, and user interface.

LSS100400 SpaceLogic KNX Hybrid module (hereinafter referred to as Hybrid Module) is a device that provides wireless connectivity to Wiser for KNX and spaceLYnk logic controllers, allowing them to integrate the ZigBee wireless devices.

Key Features

- Supports most of the Schneider Electric Wiser wireless catalog devices (supported devices may vary by country and will evolve).
- Designed for residential and commercial installations.
- Supports a maximum of 50 direct ZigBee devices connected in the system.

Integration

- Wiser for KNX and spaceLYnk are multi-protocol logic controllers (KNX, Modbus, BACnet...).
- Adding a Hybrid Module lets you integrate ZigBee wireless devices communicating over the ZigBee 3.0 protocol.

Steps to Integrate ZigBee Devices

1. Download the Hybrid plugin from the Marketplace of your Wiser for KNX/ spaceLYnk controller.
2. Pair the ZigBee devices.
3. All configuration steps are done in the plugin running in the controller. No additional software is needed.
4. Control your ZigBee devices from your KNX installation and vice versa (bidirectional communication).
5. Wiser for KNX users can control their ZigBee devices via the Wiser KNX mobile app (Android and iOS). See the user guide for the app [here](#).

Important Notes

ZigBee devices create a mesh network, allowing communication between them.

- Mains-powered wireless devices act as routers and forward information to other wireless devices.
- Battery-powered devices do not act as routers.

Consider the following when installing your device:

- Installation environment: Houses with multiple floors, enclosures in caves or metal, and buildings with large areas may experience communication issues between ZigBee devices.

- **Solutions:**

- Connect the antenna and install it outside the cabinet.
- To extend the mesh network, add a mains-powered device in between (e. g., a Connected Socket, Smart Plug, Micromodule Relay, etc.).



Hybrid Module in the cabinet



Module antenna outside the cabinet

External housing may be cleaned with a damp cloth if it becomes dirty; do not use any cleaning agent, especially alcohol.

Workflow

This overview shows the sequence of the entire process of commissioning the Hybrid Module up to visualization and integration with the Wiser KNX application.

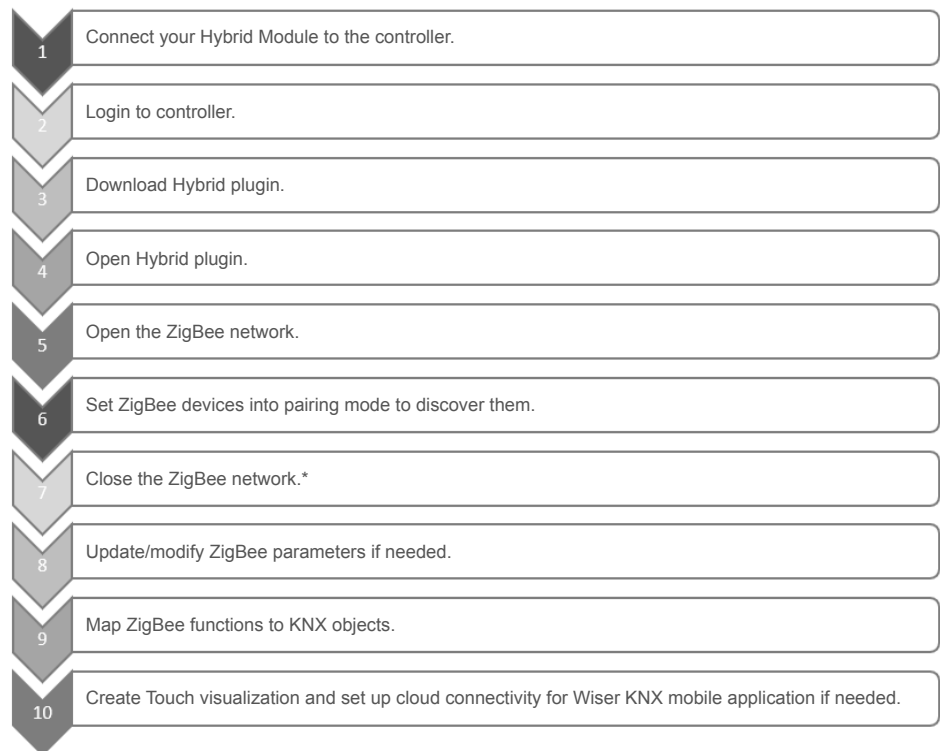

*If the ZigBee device starts updating its firmware, it closes the network, and other ZigBee devices do not appear in the list of discovered ZigBee devices.

The firmware update process can take up to 20 minutes.

After the firmware update is complete, open the network again and continue pairing the other ZigBee devices.

Hybrid Module Firmware Upgrade

The firmware is distributed as part of the Hybrid plugin. Once you have connected the Hybrid Module to your controller and downloaded the Hybrid plugin, a firmware update is automatically triggered to bring new features (new devices, new functionalities) and security patches.

The Module firmware version number displays in the **Configuration** section in the lower left corner of the screen (*Configuration*, page 41). If you are connected via VPN, this information is not visible.

Getting Started

You need a Wiser for KNX or spaceLYnk controller to operate the Hybrid Module.

Before you install the Hybrid plugin into the Wiser for KNX or spaceLYnk controller, make sure your Hybrid Module is:

- **POWERED:** The device is powered by 24 V DC.
- **PROPERLY WIRED TO THE CONTROLLER:** You have to cross the RX and TX wires, as shown in the diagram.

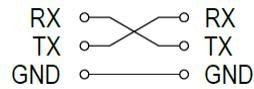

You can find detailed information on the wiring in the installation instructions of the Hybrid Module.

You need a standard web browser to work with the configuration software of the logic controllers, plugin and to set up the Hybrid Module.

Recommended browsers:

- Chrome version 118.0.5993.89 (Official Build) 64-bit
- Firefox version 118.0.2 (64-bit)
- Safari version 15.6.1

Make sure your logic controller has a firmware version of at least 2.8.3 (or higher).

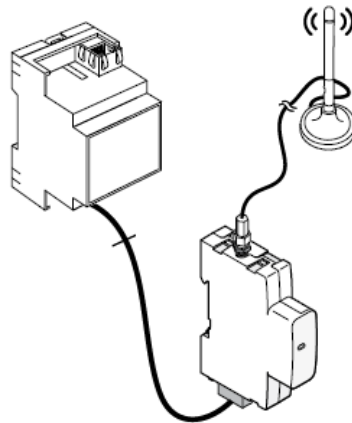

New Wiser for KNX/spaceLYnk Installation

In your web browser:

1. Type the default IP address 192.168.0.10 in the address bar of your web browser.
2. Click **Enter**.
3. Enter the default login details and click **Enter**.
 - username: **admin**
 - password: **admin**

You will get prompted to change your password. Type it and click **Save**.

Your new password has to contain at least one:

- uppercase letter

- lowercase letter
- digit
- special character

Minimum length is 8 characters.

Existing Wiser for KNX/spaceLYnk Installation

In your web browser:

1. Type the IP address you have defined for your controller in the address bar of the web browser.
2. Click **Enter**.
3. Enter your existing login details and click **Enter**.
It is mandatory to access with the administration account.
 - username: **admin**
 - password: ...

Launching the Start Page

The following procedure is the same for both new and existing installations. After successful login, the next step gets you to the start page.



NOTE: It is recommended that you have the latest firmware in your controller.

Install the Hybrid plugin to configure your wireless devices:

1. Click  in the upper right corner.
2. A list of available applications that you can install will open.
3. Find the Hybrid plugin and click the download icon at the end of the line.
4. Click **Yes** to install the plugin.

You can also install the plugin from a file on your computer (for example, if your controller does not have an Internet connection).

The Hybrid plugin will appear in your list of installed items.

When you return to the start page, you will see that the Hybrid plugin icon appears among your available applications as KNX Hybrid:

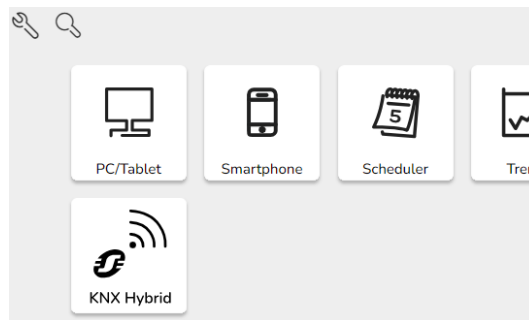

Devices

Preparing Your Module for Pairing

After you install the Hybrid plugin on the controller, you can pair your wireless devices to your controller. You can change parameters and group objects for each device.

1. Open your browser and connect to your controller.
2. Click the KNX Hybrid icon on the start page. This will take you to the plugin start page, which displays a list of the wireless devices.



KNX Hybrid icon on the start page

If you have not added any wireless devices yet, the list is empty.

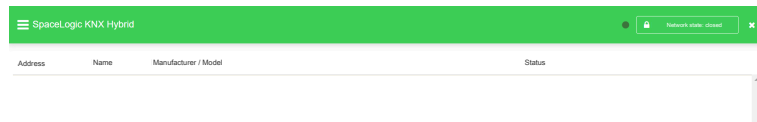

Plugin home page

Make sure the Hybrid Module functionality indicator in the upper right of the home page is green (●). If the indicator is red, or if the **Network state** button next to it is missing, the Hybrid Module is not working properly and you need to reboot your controller.

NOTE: If you are accessing the module remotely via VPN, the indicator flashes red, and the **Network state** button is missing, even if the module is working. You cannot open and close the network remotely.

If there is no communication and the installation does not work, follow these steps:

Reboot your controller:

1. Close the Hybrid plugin with the cross at the top right.
2. On the Start page, click on the **Configurator** → **System** → **System** tab.
3. Select **Reboot** from the menu.

After you reboot your controller:

1. Return to the start page.
2. Prepare your wireless device that you want to pair.

NOTE: If a reboot does not help, try to power your device off and then on.

Pairing the Device

If your wireless device is battery powered, make sure you have a battery inside and remove the plastic film from the battery. If the device is mains powered, make sure it is properly connected to the mains.

Find the Reset/Setup button on the back of your device. With this button, you can pair your device and reset it.

NOTE: If your ZigBee device does not have this button, follow the instructions in the device user manual.

You can also commission the devices using the Schneider Electric eConfigure software tool (see more here https://www.se.com/ww/en/download/document/eConfigure_ETS5_Lite175/).

You have to open your network to add the ZigBee wireless devices.

1. Click the **Network state** button at the top right. The change network state dialog appears:

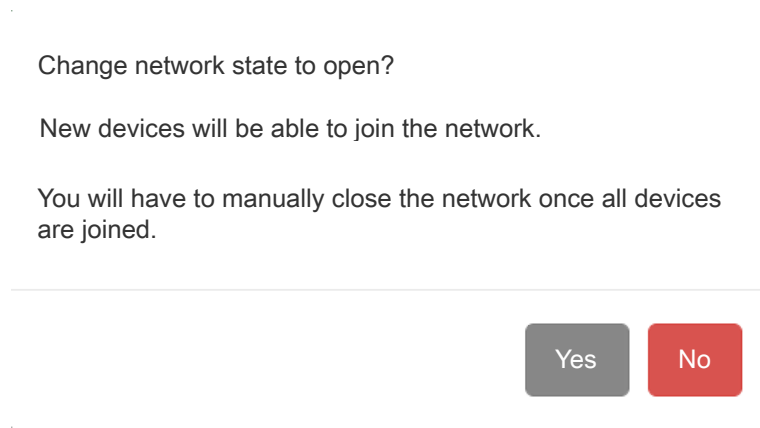

2. Click **Yes** to change the network status to **Open**.
3. Set your device to pairing mode (see [Device Pairing Mode](#), page 19).

NOTE:

Your commissioned wireless device flashes orange after a triple-click. If the network is open, your device flashes green for a few seconds, and a new device line appears in the plugin. Your device is paired.

Address: Short and long address of the device

Manufacturer/Model: Device identification

Status: The time last telegram was sent

IMPORTANT: It is recommended to check pairing procedure of your ZigBee device in the user guide of the device. The pairing process may vary between the devices.

4. If you are not adding any more devices, close the network. Click the **Network state** button at the top right again and click **Yes** to change the network status to **Closed**.

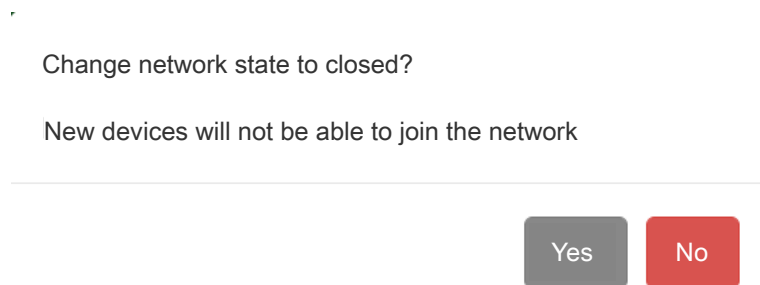

NOTE: The network closes automatically 10 minutes after opening. You can extend this interval. See more in [Configuration](#), page 41.

NOTE: The green background of the status column means that data is being sent or updated.

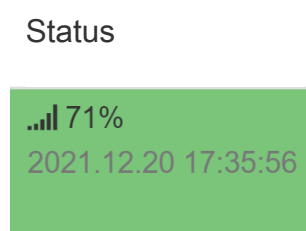

Incomplete commissioning of battery devices

If you see question marks in the **Manufacturer/Model** column in the device line after commissioning, the device is not correctly commissioned, even if it looks like it.

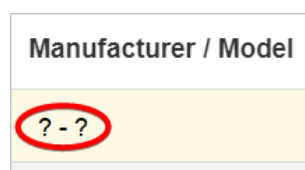

Such a device would not work properly. If this happens, delete the device from the device list and configure it again. It is possible that you will need to commission your device repeatedly.

Do not forget to wake your device before deleting.

Device Pairing Mode

To pair the device with the controller, you need to put it in pairing mode.

Press the Reset/Setup button three times briefly until the LED on the front starts blinking orange.

The device is in pairing mode.

NOTE: If your device is flashing green, it is already paired. If you want to pair your device again or to another device, reset it first and repeat the pairing process.

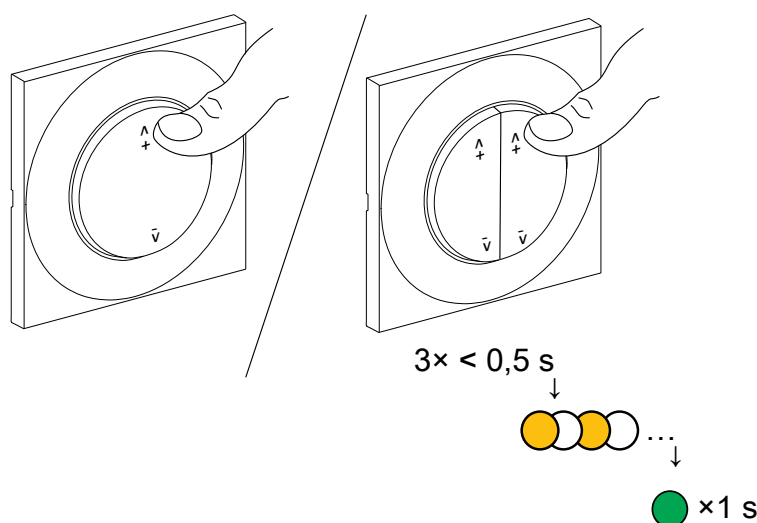

NOTE: For more information on how to pair your wireless device, please refer to its user guide.

Resetting the Device

For most Wiser wireless devices, to reset them, you have to short-press the button three times and then long-press the button once for 10 s. The front LED starts flashing red slowly.

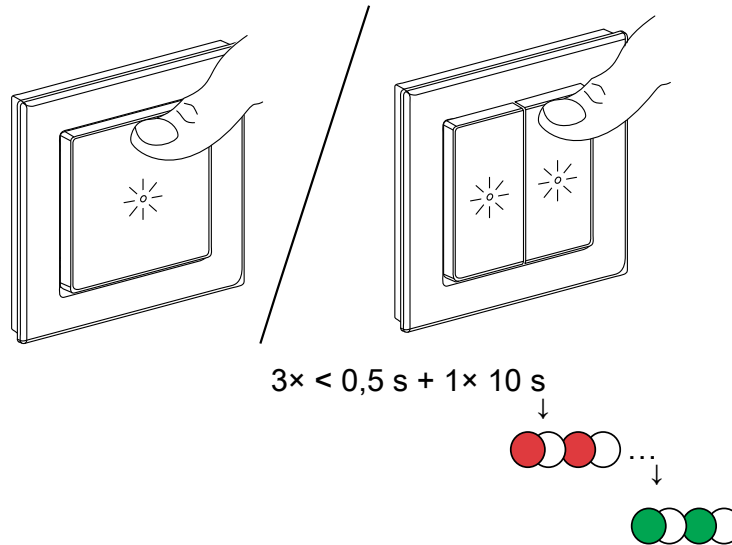

NOTE: For more information on how to reset your wireless device, please refer to its user guide.

Device Actions

There are seven icons at the end of each device line. When you click these icons, you can do the following:

- Upgrade device firmware
- Allow joining through this device
- Identify device
- View device information
- Set device control and status
- Set device parameters
- Configure the device
- Delete device









Help

If you click  in the upper right corner of the screen above the list of devices, you will see a **Help** section where you can find a description of each device action icon and device status background color.

Help

Device states

Configured and operational	 Firmware upgrade
Unconfigured	 Identify device
Firmware upgrade available	 Device information
Firmware upgrade in progress	 Control & status
Left the network	 Parameters
	 Configure
	 Delete

[Close](#)

Device Firmware Upgrade

By default, automatic device firmware update is disabled. With the **Firmware upgrade** icon you can manually upgrade the device firmware.

 New firmware is available.

 There is no new firmware available for the device.

NOTE: After the device is commissioned, the firmware upgrade button is disabled for some time, even if a firmware upgrade is available. It usually takes a few minutes for the upgrade button to become active.

If new firmware is available for the device (the device is colored blue), you can start the firmware upgrade:

Click  > **Yes** > If you want to upgrade a battery device, interact with it to wake it up > click **Continue**.

The device will turn green (**Firmware upgrade in progress**) and then white (**Configured and operational**). Firmware upgrade is completed.

NOTE: You can only manually upgrade one device at a time.

If you do not want to upgrade your device firmware manually, enable automatic firmware upgrade of your device as follows:

Click  > check **Enable automatic firmware upgrade**.

Your device firmware will be automatically upgraded whenever a firmware update is available. You can find information about the firmware version of your device if you click  next to your device (Device Information, page 22).

NOTE: The **Network state** button for opening and closing the network is disabled during the firmware upgrade.

Allow Joining through This Device

This function allows you to initiate the pairing process through a specific device. For example, you can pair a sensor through a nearby socket. New devices can join the network but only through the selected router.

Steps to pair devices

1. Open the pairing dialog:
 - Click .
 - A dialog box will appear asking if you want to change the network status to **Open**.
 - Click **Yes**.
2. Pair the device:
 - Follow the instructions in the [Pairing the Device](#), page 17 chapter to complete the pairing process.
3. Close the network:
 - Once pairing is complete, click the **Network state: open** button at the top right.
 - Click **Yes** to close the network.

Identify Device

The **Identify device** function is used to identify a device on the network.

When you click , the device will start blinking or lighting up for about 15 seconds to identify itself.

This feature is useful when you are unsure which device is which.

Device Information

When you click the **Device information** icon , you will see a list of information about your device:

- Manufacturer
- Device type
- Firmware version
- Power source
- Status for receiving telegrams.
- Input and output ZigBee clusters.
- Reported attributes of the device.

My_device_name - device information x

```

Device type: Router
Power source: Mains
Receive when idle: Yes

Endpoint 1
Profile: 260
Input clusters:
- Basic (0)
- Identify (3)
- Groups (4)
- onOff (6)
- Alarms (9)
- SeMetering (1794)
- HaElectricalMeasurement (2820)
Output clusters:
- Identify (3)
- ota (25)

Reported attributes
- activepower: 62.9
- onoff: true
- powerdivisor: 10000
- powermultiplier: 1
  
```

Close

Device Control and Status

Clicking on the **Control and status** icon allows you to control your device and check its status. Click  and choose the action you want to perform. The control and status dialog box contains the following buttons (the number of buttons varies depending on the type of device):

- **Read:** Display the current status/consumption of the device.
- **Send:** Enter the value you want to send to the device in the input field and click Send.
- **On:** Turn on the device.
- **Off:** Turn off the device.
- **Toggle:** Switch the device between on and off.
- **Up/Open:** Raise/open the blinds/shutters.
- **Down/Close:** Lower/close the blinds/shutters.
- **Stop:** Stop the movement of the blinds/shutters.





For example, if you have commissioned several devices of the same model, and you need to distinguish which one is which, you can turn them on/off with the **Control and status** setting.

You can use **Control and status** for troubleshooting if you have a problem to control your device from **Touch** visualization. Turn your device on/off and check if it works.

NOTE: This feature is not available for battery-powered devices. Battery-powered devices are usually idle.

Setting Device Parameters

With , you can change the device parameters. The function is disabled for devices that do not have configurable parameters ( appears light gray = inactive).

Opening the **Parameters** dialog:

- Click on the **Parameters** icon: .
- A dialog box will open where you can set individual values depending on the type of device.

Troubleshooting:

- If the device does not respond (**Parameters** dialog box does not open):
 1. Check if the device is turned on.
 2. Try waking it up by interacting with it.
 3. If that does not work, press the device's programming button and immediately click **Continue**.

Schneider Electric - Push-Button dimmer (1 gang) - parameters

On/Toggle level (0..254, 255 = previous value)

Start-up level (0..254, 255 = previous value)

Minimum level (1..254)

Maximum level (1..254)

Dimmer mode



LED indicator



List of Parameters

Device	Parameter	Parameter Description
Avatar dimmers	Indicator light level	LED light intensity (%)
	Indicator color	The color of the LED light (white/blue)
	LED indicator	LED lighting period (On when load is On/ Off, Always On/Off)
	Minimum level (1...254)	The minimum dimming level setting
	Maximum level (1...254)	The maximum dimming level setting
	Dimmer mode	Dimming mode setting – Automatic, RC (trailing edge), RL (leading edge), RL-LED.
Merten dimmer	Switch action	Switch function: <ul style="list-style-type: none"> • Light, Light (inverse*) • Dimmer, Dimmer (inverse*) • Standard shutter**, Standard shutter** (inverse*) • Schneider shutter**, Schneider shutter** (inverse*) • Scene – two scene numbers (one up, the other down)
	LED indicator	LED lighting period (On when load is On/ Off, Always On/Off).
	On/Toggle level (1...254, 255 = previous value)	Dimmer lighting level after turning on the dimmer.
	Start-up level (0...254, 255 = previous value)	Starting lighting level after power outage.
	Minimum level (1...254)	Limitation of the bulb function from below - minimum light value.
	Maximum level (1...254)	Limitation of the bulb function from above - maximum light value.
	Dimmer mode	Dimming mode setting – Automatic, RC (trailing edge), RL (leading edge), RL-LED.
Motion sensor dimmer	Device type switch/dimmer	Device type setting – dimmer or switch.
	Occupancy operation mode	Dimmer on and off setting (Manual mode; Auto; Auto on/off, Manual on/off)
	Detection timeout (seconds)	Detection duration.
	Ambience light threshold (lux)	If light intensity \geq ambience light threshold, do not switch on.
Rotary dimmer	On/Toggle level (1...254, 255 = previous value)	Dimmer lighting level after turning on the dimmer.
	Start-up level (0...254, 255 = previous value)	Starting lighting level after power outage.
	Minimum level (1...254)	Limitation of the bulb function from below - minimum light value.
	Maximum level (1...254)	Limitation of the bulb function from above - maximum light value.
	Dimmer mode	Dimming mode setting – Automatic, RC (trailing edge), RL (leading edge), RL-LED.
Free locate switch	Indicator light level	LED light intensity (%).
	Indicator color	The color of the LED light (white/blue).
	Key 1 – 4	Button function setting – No configuration/ Toggle dimmer/ Scene.
	Switch mode	Setting the number of rockers.
	Switch action	Rocker function: <ul style="list-style-type: none"> • Light, Light (inverse*)

Device	Parameter	Parameter Description
		<ul style="list-style-type: none"> • Dimmer, Dimmer (inverse*) • Standard shutter**, Standard shutter** (inverse*) • Schneider shutter**, Schneider shutter** (inverse*) • Scene – two scene numbers (one up, the other down)
Motion sensor	Sensitivity level	Motion detection sensitivity setting – Default, Low, Medium, High
	Detection timeout (seconds)	Detection duration.
Shutter	Switch action	Switch function: <ul style="list-style-type: none"> • Light, Light (inverse*) • Dimmer, Dimmer (inverse*) • Standard shutter**, Standard shutter** (inverse*) • Schneider shutter**, Schneider shutter** (inverse*) • Scene – two scene numbers (one up, the other down)
	Indicator light level	LED light intensity (%).
	Indicator color	The color of the LED light (white/blue).
	LED indicator	LED lighting period (On when load is On/ Off, Always On/Off).
	On/Off transition time	Total movement time of the shutter until fully closed/opened (tenth of a second).
	Motor type channel 1/2	Setting the type of motor - asynchronous or pulse motor.
	Height: time from fully closed to fully open (seconds)	Time from fully closed to fully open (seconds)
	Height: time from fully open to fully closed (seconds)	Time from fully open to fully closed (seconds)
	Tilt: time from fully open to fully closed (seconds, 0 = tilt disabled)	Time from fully open to fully closed (seconds, 0 = tilt disabled)
Scene	Number of scene (button press = trigger).	
Switch	Indicator light level	LED light intensity (%).
	Indicator color	The color of the LED light (white/blue).
	LED indicator	LED lighting period (On when load is On/ Off, Always On/Off).
	Switch action	Switch function: <ul style="list-style-type: none"> • Light, Light (inverse*) • Dimmer, Dimmer (inverse*) • Standard shutter**, Standard shutter** (inverse*) • Schneider shutter**, Schneider shutter** (inverse*) • Scene – two scene numbers (one up, the other down)
Motion sensor switch	Occupancy operation mode	Light on and off setting (Manual mode; Auto; Auto on/off, Manual on/off).
	Detection timeout (seconds)	Detection duration.
	Ambience light threshold (lux)	If light intensity \geq ambience light threshold, do not switch on.

Inverse* = Reverse order of switches (up/down is down/up) or dimming direction.

Schneider shutter** = Schneider shutter data points are supported.

Device Configuration

Key aspects of device configuration include assigning group objects, selecting the device location, and naming the device.

You can perform the configuration either manually or automatically.

Manual Configuration

If you want to configure your devices manually, follow these steps:

1. Access **Settings**:

- Click  located on the right side of the device line. This will open the **Configuration** dialog where you need to set up the parameters for configuring the devices.

2. Name your device:

- Give your device a unique name.

3. Organize devices:

- To organize your devices into rooms or areas, use a **Location** parameter.

NOTE: Before starting the configuration, ensure the device's location (room) is set in the **Touch** application.

You can create a location as follows:

- Type the location name into the **Location** field and press **Enter**.
- Alternatively, select the device location from the drop-down **Location** menu.

4. **Enable automatic firmware update:**

- Enabling automatic firmware updates is recommended. This ensures that your devices always have the latest firmware, which can include important security patches, performance improvements, and new features. Keeping your firmware up-to-date helps maintain your devices' reliability and security.

5. Map ZigBee attributes to KNX group objects:

- You can use the already created group objects to control both ZigBee and KNX devices together by selecting KNX objects from a drop-down menu for each ZigBee attribute.
- You can also create new KNX objects. For detailed steps on creating new objects, refer to the chapter [Create New Object](#), page 34.

NOTE: Battery-powered devices: If you map KNX objects to ZigBee attributes **Low battery detected** and **Battery level**, you can use those in **Touch** visualization. The device widget will show the battery level, and you can receive battery status notifications.

6. Generate widgets:

- Click **Generate in Touch** option to generate widgets in the Touch visualization to control your ZigBee devices.

Schneider Electric - Wiser Motion Sensor - configuration

Name

Location

Tags

Enable automatic firmware upgrade

Illuminance (lux) + Add (2 bytes floating point)

Detection + Add (1 bit) Invert

Sends ON when open contact/occupancy/leak/vibration/gas/smoke is detected

Low battery detected + Add (1 bit)

Battery level + Add (1 byte scale)

Automatic Configuration

The **automatic configuration** feature (also known as “drag and drop”) simplifies your setup process by automatically assigning the correct group objects to your devices and creating widgets in the **Touch** visualization.

What it does:

- Automatically assigns the correct **group objects** to your devices.
- Automatically creates **widgets** in the **Touch** visualization.
- Saves time and reduces manual configuration effort.

How to use automatic configuration:

1. Open the **Hybrid** plugin.
2. In the device list, locate the device you want to configure.
3. Drag the device and drop it into the desired location.

NOTE: Make sure the room is already set in the **Touch** application.
4. After dropping the device, a dialog will appear: **New location Touch: Name of the location**
5. In the dialog:
 - Choose **Automatic configuration**.
 - Optionally rename your device.
 - Enable automatic firmware updates (recommended).

6. The system will:

- Automatically assign the correct group objects (you can verify this by clicking the configuration icon of the device).
- Automatically create a widget in the **Touch** visualization.

Automatic Configuration of HVAC

The automatic configuration feature is beneficial when setting up HVAC systems. In such cases, the **Hybrid** plugin not only assigns the appropriate group objects but also links HVAC devices together to ensure the HVAC system works properly.

What it does:

- Assigns the correct group objects to HVAC devices.
- Automatically links the devices to create a functional HVAC system.
- Creates a widget for the thermostat in the **Touch** visualization with linked iTRV's.

Supported devices

Automatic HVAC configuration supports the following devices:

- iTRV radiator valves
- 16 Amp relay switches
- TCFMT thermostats (2 A or 16 A versions)
- Battery-powered thermostats (CCTFR6100)

When these devices are placed **in the same room**, the system assigns group objects to them to link them together.

Group object assignment

- iTRV valves and 16 Amp relays each receive two group objects from the thermostat:
 - **Remote temperature value**
 - **Occupied heating setpoint control**

Widget creation

- A widget is automatically created **only for the thermostat**.



- To view linked actuators:

1. Click  the thermostat widget in **Touch Config**.
2. In the **Settings** dialog under the **General** tab, you will see all actuators linked to the thermostat.

Monitoring battery and device status of linked devices

- In the **Touch**, click  in the bottom-right corner of the thermostat widget.



- You can:
 - Hover over the device icon to see the device name and battery level as a percentage.
 - Check the actuator status: On = Valve is open / Relay is active.

Dimmers

Device	Object	Object Description
Dimmer	On/Off control (1 bit)	Turning on/off.
	Start/stop dimming (4 bits)	Button press dims 100 percent up or down. Releasing the button stops dimming.
	Up/stop (1 bit; true = up, false = stop)	Button press = dimming up, button release = stop.
	Down/stop (1 bit; true = down, false = stop)	Button press = dimming up, button release = stop.
	Set level directly (1 byte scale)	Set dimming level (%).
	On/Off status (1 bit)	Feedback for on/off.
	Level status (1 byte scale)	Feedback for dimming level.
	Steps per second (supported only on some devices)	Number of steps per second after pressing the button.
	Transition time (seconds) – supported only on some devices	The time during which it is to dim to the set intensity.
	Step size (0 = default) – supported only on some devices	Setting the dimming step range
Motion sensor dimmer	Illuminance (lux)	Light intensity.
	Occupancy (1 bit)	1-bit value for presence detection.
Dimmer button	On/Off/Toggle (1 bit)	Button function – on/off/toggle.
	Set level or step current value (1 byte unsigned)	Dimming by a set step.
	Step size (0 = default)	Setting the dimming step range.

Free Locate Switch

Device	Object	Object Description
Free locate switch	Battery level (1 byte scale)	Device battery level.
	On/Off/Toggle (1 bit)	On/Off/Toggle control.
	Start/stop dimming (4 bits)	Button press dims 100 percent up or down. Releasing the button stops dimming.
	Set level or step current value (1 byte unsigned)	Dimming by a set step.
	Step size (0 = default)	Setting the dimming step range.
	Scene (1 byte unsigned)	Sends number of the scene.
Merten	Up/Down/Stop (4 bits)	Button press dims 100 percent up or down. Releasing the button stops dimming.
	Up/Down (1 bit)	1 = dimming up, 0 = dimming down
	Stop (1 bit)	0 = stop dimming

Sockets

Device	Object	Object Description
Sockets	On/Off control (1 bit)	Turn on/off.
	On/Off status (1 bit)	Feedback for on/off.
	Active power (4 bytes floating point)	Current power consumption.
	RMS voltage (4 bytes floating point)	Value of electric voltage.

Device	Object	Object Description
	RMS current (4 bytes floating point)	Electric current.
	Energy delivered (4 bytes floating point)	Cumulative energy consumption. The value is reset to zero during commissioning.

Switches

Device	Object	Object Description
Switches	On/Off control (1 bit)	Turn on/off.
	On/Off status (1 bit)	Feedback for on/off.
Merten/Motion sensor switch	On/Off/Toggle (Push-button) – 1 bit	On/Off/Toggle control.
Motion sensor switch	Illuminance (lux) – 2 bytes floating point	Light intensity.
	Occupancy – 1 bit	1-bit value for presence detection.

Shutters

Device	Object	Object Description
Shutter	On/Off control (1 bit)	Turning on/off.
	On/Off status (1 bit)	Feedback for on/off.
	Level status (1 byte scale)	Feedback for position level.
Puck shutter	Height control (1 byte scale)	The height of the shutter (%) control.
	Tilt control (1 byte scale)	The tilt of the slats control.
	Up/Open (1 bit; true = up/open, false = stop)	Shutter goes up/opens.
	Down/Close (1 bit; true = down/close, false = stop)	Shutter goes down/closes.
	Up/Down/Stop (4 bits)	Move up/down 100% with two buttons. Pressing the button again stops the movement.
	Height status (1 byte scale)	Status feedback for height of the shutter.
	Tilt status (1 byte scale)	Status feedback for tilt of the slats.
Merten/Wiser shutter	Up/Down/Stop (push-button) – 4 bits	Move up/down 100% with two buttons. Pressing the button again stops the movement.
	Up/Down (push-button) – 1 bit	Up/down control.
	Stop (push-button) – 1 bit	Stop the movement.

Sensors

Device	Object	Object Description
Window/door sensor	Battery level (1 byte scale)	Device battery level
	Low battery detected (1 bit)	Device battery low detection
	Detection (invert) – 1 bit	Detection (sound signal) – sends ON when open contact/occupancy/leak/vibration/gas/smoke is detected.

Device	Object	Object Description
Water leakage sensor	Battery level (1 byte scale)	Device battery level.
	Low battery detected (1 bit)	Device battery low detection.

Device	Object	Object Description
	Detection (invert) – 1 bit	Detection (sound signal) – sends ON when open contact/occupancy/leak/vibration/gas/smoke is detected.

Device	Object	Object Description
Temperature/Humidity sensor	Battery level (1 byte scale)	Device battery level.
	Temperature (2 bytes floating point)	Temperature detection (°C).
	Humidity (1 byte scale)	Humidity detection (%).

Device	Object	Object Description
Motion sensor	Battery level (1 byte scale)	Device battery level.
	Low battery detected (1 bit)	Device battery low detection.
	Detection (invert) – 1 bit	Detection (sound signal) – sends ON when open contact/occupancy/leak/vibration/gas/smoke is detected.
	Illuminance (lux) – 2 bytes floating point	Light intensity.

Device	Smoke Alarm 230V	Object Description
Smoke alarm 230 V	Battery level (1 byte scale)	Device battery level.
	Low battery detected (1 bit)	Device battery low detection.
	Battery defect (1 bit)	Defective battery detection.
	Temperature (2 bytes floating point)	Temperature detection (°C).
	Detection (invert) – 1 bit	Detection (sound signal) – sends ON when open contact/occupancy/leak/vibration/gas/smoke is detected.
	Heat Alarm (1 bit)	Elevated temperature detection.
	Fault warning (1 bit)	Error detection.
	AC mains (1 bit)	230 V connection indicator.
	Test mode (local) – 1 bit	Device test mode (long press) that triggers an alarm (detection is not interrupted).
	Remote Alarm (1 bit)	Multiple sensors linked – one of them detects smoke, the others report a remote alarm.
	Hush mode (1 bit)	Temporarily interrupts the alarm by pressing the button.



Thermostats

Device	Object	Object Description
Thermostat	Battery level (1 byte scale)	Device battery level.
	Keypad lockout control (1 byte unsigned / 8 bit enum.)	Disable/Enable keypad functionality.
	Temperature (2 bytes floating point)	Temperature detection (°C).
	Humidity (1 byte scale)	Humidity detection (%).
	Setpoint (10..30°C) – 2 bytes floating point	Required temperature.
	Occupied heating setpoint control (2 bytes floating point)	Required temperature for heating mode.
	Occupied cooling setpoint control (2 bytes floating point)	Required temperature for cooling mode.
	Heating control (1 bit)	Heating mode de/activation.

Device	Object	Object Description
	Cooling control (1 bit)	Cooling mode activation/deactivation.
	Remote temperature value (2 bytes floating point)	External sensor temperature.
	Local temperature / Temperature (2 bytes floating point)	External sensor temperature or temperature measured by the device.
	Occupied heating setpoint status (2 bytes floating point)	Feedback for required temperature for heating mode.
	Occupied cooling setpoint status (2 bytes floating point)	Feedback for required temperature for cooling mode.
	Heating status (1 bit)	Feedback for heating mode (if active).
	Cooling status	Feedback for cooling mode (if active).
	Heating demand status (1 byte scale)	Valve position or heating pulse width modulation (in percentage).
	Cooling demand status (1 byte scale)	Valve position or cooling pulse width modulation (in percentage).
	Fixed Load Demand (4 bytes unsigned integer)	Nominal load power (for power and energy calculation).

Create New Object

To create a new object:

1. Click  at the end of the device line.
2. Click  above the object drop-down menu.
A dialog will appear in which you can select the type of object.

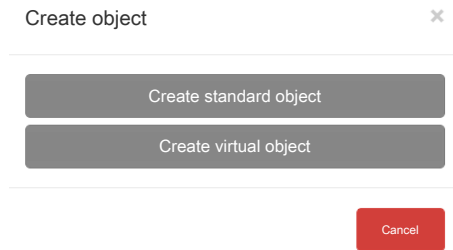

The dialog box titled "Create object" has a close button (x) in the top right corner. It contains two buttons: "Create standard object" and "Create virtual object". At the bottom right, there is a red "Cancel" button.

Types of objects

- **Standard object** – object value changes are sent to the KNX bus.
 - **Virtual object** – object value changes are never sent to the KNX bus. (Virtual objects are usually used for visualization or scripting.)
3. In the **Create object** dialog, click **Create standard/virtual object**.
 4. Fill in the **Add new group address** form > click **Save**.

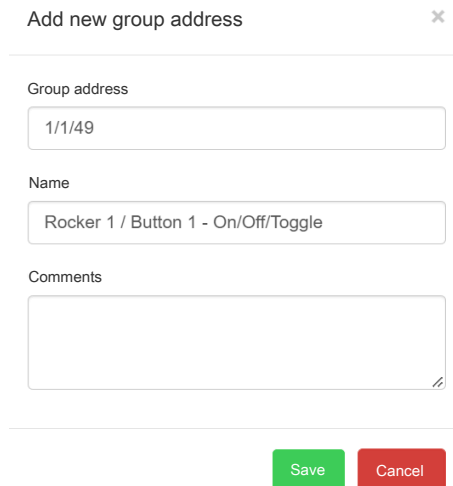

The dialog box titled "Add new group address" has a close button (x) in the top right corner. It contains three input fields: "Group address" with the value "1/1/49", "Name" with the value "Rocker 1 / Button 1 - On/Off/Toggle", and "Comments" which is empty. At the bottom, there are two buttons: a green "Save" button and a red "Cancel" button.

The new object appears in the object field of the **Configuration** form. Click **Save** to save the changes.

Specific Configuration of the ZigBee Devices

Before installing the device, check this table for specific configuration requirements. You can find the list of supported devices here: [Supported Devices](#), page 45.

Device	Issue	Solution															
Avatar Free locate switch	You want to assign different functions to the avatar free locate switch keys.	<p>You can only assign a scene function to the keys of the avatar free locate switch. You assign the desired functions to the scenes.</p> <p>The following example describes how to turn lights off and on with keys 1 and 2 and control shutter with keys 3 and 4.</p> <ol style="list-style-type: none"> Go to your device Parameters in the Hybrid plugin > assign a scene function and a scene number to each key in the Parameters form.. <table border="1" style="margin-left: 40px;"> <thead> <tr> <th>Key Nr.</th> <th>Function</th> <th>Scene Nr.</th> </tr> </thead> <tbody> <tr> <td>1</td> <td>Scene</td> <td>0</td> </tr> <tr> <td>2</td> <td>Scene</td> <td>1</td> </tr> <tr> <td>3</td> <td>Scene</td> <td>2</td> </tr> <tr> <td>4</td> <td>Scene</td> <td>3</td> </tr> </tbody> </table> <ol style="list-style-type: none"> Use the following script to link the key functions: <pre> SC = event.getvalue() Light1 = '0/0/1' Light1_St = '0/0/2' Light2 = '0/0/3' Light2_St = '0/0/4' Cl_Stop4B = '1/1/6' ----- L1 =grp.getvalue(Light1_St) L2 =grp.getvalue(Light2_St) Clstop=grp.getvalue(Cl_Stop4B) if SC==0 then -- FLS button 1 toggle Light 1 grp.write(Light1, not L1) elseif SC==1 then -- FLS button 2 toggle Light 2 grp.write(Light2, not L2) elseif SC==2 then -- FLS button 3 open or stop curtain 1 if Clstop ~= 0 then grp.write(Cl_Stop4B,0) else grp.write(Cl_Stop4B,6) end elseif SC==3 then -- FLS button 4 open or stop curtain 1 if Clstop ~= 0 then grp.write(Cl_Stop4B,0) else grp.write(Cl_Stop4B,13) end end </pre> 	Key Nr.	Function	Scene Nr.	1	Scene	0	2	Scene	1	3	Scene	2	4	Scene	3
Key Nr.	Function	Scene Nr.															
1	Scene	0															
2	Scene	1															
3	Scene	2															
4	Scene	3															
Avatar Blind	You want to move your curtain to a precise (absolute) position.	For this device, absolute positioning only fully closes or fully opens.															
Avatar Blind	You want to open/close slats.	The product supports only the control of curtains. Map Up/Down objects to the Left/Right objects depending on your installation.															
Dimmers and switches	Order of 2-gang keys for dimmers and switches.	For 2-gang dimmers or switches (Avatar range excluded), the right keys are gang/output #1, and the left keys are gang/output #2.															
Dimmers	You want to control the ZigBee dimmer via relative dimming function.	<p>Link the 03.007 dim/blinds step object to 4 bits Start/stop dimming Hybrid object of the free locate switch.</p> <p>NOTE: For the Start/stop dimming object, the dimming speed is irrelevant to the selected value. For example, the object value Up 1% will dim up as quickly as the Up 100% one.</p>															

Device	Issue	Solution
Shutters/Blinds	The shutters/blinds move in reverse. Instead of down, they go up and vice versa.	<ol style="list-style-type: none"> 1. Go to your device Parameters in the Hybrid plugin > select inverse shutter in the Parameters form. 2. Cross the wires leading to the shutter motor. 3. Swap the drive up and down time in the Parameters form.
Motion sensor – Dimmer, Switch, Ceiling	The Illuminance object is sent every 10 seconds and overloads CPU.	<p>Unmap Illuminance objects that are not necessary.</p> <p>Go to Configuration of your device > find 2 bytes Illuminance object field > unmap the object (the object field has to be empty) > click Save.</p>

Delete ZigBee Devices

The last red icon in the device line is for removing ZigBee devices from the network.

If you want to delete your device, click  at the end of the device line > click **Yes**.

The device will be removed from the network.

Reset the device physically so that it can join the network again.

You have to reset battery-powered devices manually to fully remove them from the network.

Extend Device Functionality

Mains-powered ZigBee devices with manual control (push-buttons, rotary knobs) have extended functionality of decoupling the front and back of the device. The front (push-buttons) part of the device can control a completely different device than the one it belongs to.

A blue note in the device Configuration dialog informs you of the extension possibility.

Push-Button functionality can be changed via device parameters.

Devices without a push-button interface, like the Wiser micro-modules, do not support this extended functionality.

To use this functionality, do the following:

1. Go to Hybrid plugin > select a device that supports this functionality > click  to open its **Parameters** setting.

- In device **Parameters** setting, select from a drop-down menu which device type you want to control by switch action.

Schneider Electric - 1 Gang Switch (1 Relay) - parameters ✕

Switch action

Dimmer ▾

Light

Light (inverse)

Dimmer

Dimmer (inverse)

Standard shutter

Standard shutter (inverse)

Schneider shutter

Schneider shutter (inverse)

- Click **Save**.
- Click  to open the **Configuration** dialog > configure your device. There are three sections in the **Configuration** dialog:
 - Name and device location.
 - Configuration of the back part of your device (device control, device status).
 - Push-button configuration (if your device supports it) at the front panel (buttons, knobs).

Schneider Electric - 1 Gang Switch (1 Relay) - configuration ✕

Name

Location

- No location - ▾

Tags

🔍 No tags set

Enable automatic firmware upgrade

Relay control

On/off control + Add (1 bit)

- No group address selected - ▾

Relay status

On/off status + Add (1 bit)

- No group address selected - ▾

Push-button

On/off toggle + Add (1 bit)

- No group address selected - ▾

Push-button functionality can be changed via device parameters

Save
Cancel

- In the **Push-button** section, based on the setting you did in the **Parameters** section, you can see the functionality assigned to the front part of the device. Assign a group address to each functionality.

Touch Visualization

After commissioning the ZigBee device and mapping it into KNX objects, you can use those KNX objects for creating widgets in Touch visualization.

Click the cross at the top right to close the Hybrid plugin to be able to start Touch configuration.



On the Start page, click . You get to the visualization configurator.

For more information check the controller user guide.

Groups

ZigBee groups are suitable for central functions or for bulk operations. For example, you can turn on/off all dimmers or open/close all blinds by sending a single telegram. You can control several devices at the same time and not overload the ZigBee network.

ZigBee groups can be composed of devices with the same functionality. Each device in the group remembers that it is part of the group and will only receive telegrams for its group.

Only one group telegram is always sent to all ZigBee devices in the network. All devices will read the telegram. Only the devices that belong to the group will receive the telegram and perform the required operation.

To create a group, follow these steps:







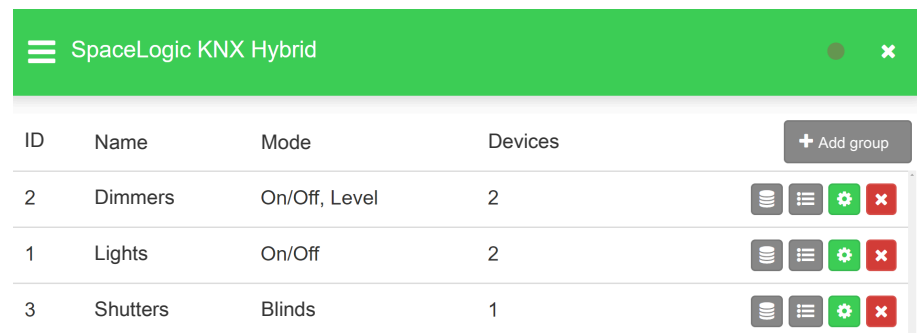





1. Click  > select **Groups**.
2. Click **Add group** and fill in the form (group ID, name, mode).
3. Click **Save and configure** and fill in the form (name, location, assign group object to the control command).
4. Click **Save and add devices** > select the devices you want to add to your group.
5. Click **Add to group** and **Close**.

Your new group of devices appears in the list of groups.

You can further modify each group later, change its parameters, or delete it.



The screenshot shows a software interface for SpaceLogic KNX Hybrid. At the top, there is a green header bar with a menu icon and the text "SpaceLogic KNX Hybrid". Below the header is a table with four columns: ID, Name, Mode, and Devices. To the right of the table is a "+ Add group" button. Each row in the table has four action icons: a stack of papers, a list icon, a gear, and a red 'X'.

ID	Name	Mode	Devices	
2	Dimmers	On/Off, Level	2	   
1	Lights	On/Off	2	   
3	Shutters	Blinds	1	   

Monitor

Monitoring is an information and diagnostic tool that allows you to get an overview of the functionality of the ZigBee network. The **Monitor** function monitors the activity of the device in the network and the values generated/received by the devices.

To run the monitoring, do the following:

1. Click  > select **Monitor**.
2. Click the **Start monitor** button to start monitoring.

Messages start to appear on the screen in chronological order, containing the following information about the devices:

#	Time	Type	Address	Cluster	Action	Data
11	16:09:31.068	RX	-	-	getpermtjoin	addr = -1, max = 50
10	16:09:31.066	TX	-	-	getpermtjoin	-
9	16:09:09.666	RX Δ 25%	000d6f0016450a95	OnOff	ReportAttributes	AttributeReports = [{ Attribute = { Type = bool, Value = false }, AttributeIdentifier = 0 }]
8	16:09:09.607	RX Δ 38%	680ae2ffe1173e1	OnOff	Off	-
7	16:09:05.537	RX Δ 35%	680ae2ffe1173e1	OnOff	On	-
6	16:09:04.543	RX Δ 32%	680ae2ffe1173e1	OnOff	On	-
5	16:09:01.263	RX Δ 41%	680ae2ffe1173e1	OnOff	Off	-
4	16:08:51.833	RX Δ 47%	680ae2ffe1173e1	OnOff	Off	-
3	16:08:50.803	RX Δ 47%	680ae2ffe1173e1	OnOff	On	-
2	16:07:50.373	RX Δ 60%	000d6f0016450a95	HaElectricalMeasurement	ReportAttributes	AttributeReports = [{ Attribute = { Type = int16, Value = 162 }, AttributeIdentifier = 1291 }]

Number: Message serial number.

Time: The time when the message was received by the hybrid module.

Type: Data sent/received (S/R) and signal strength.

Address: MAC address of the device.

Cluster: Type of the ZigBee clusters.

Action: Action taken (related to the cluster).

Data: Data sent/received.

If you want to stop monitoring, click **Stop monitor**.

You can export monitoring values as a CSV file to local storage: click **Export CSV**.

Configuration

Network configuration is the process of setting your network characteristics. Configure the network before pairing the wireless devices:

1. Click  > select **Configuration**.
2. Configure your network as follows:
 - **Channels:** The ZigBee standard defines 15 channels, all within the 2.4 GHz radio band. ZigBee channels are numbered 11-25, but they overlap many of the same frequencies as Wi-Fi channels 1-11.
 - **PAN ID:** Each ZigBee network is defined with a unique PAN (personal area network) identifier (ID), which is common among all devices of the same network. ZigBee devices are either preconfigured with a PAN ID to join, or they can discover nearby networks and select a PAN ID to join.

NOTE: Change the PAN number each time you change the Hybrid Module. If multiple ZigBee networks are operating within range of each other, each should have unique PAN IDs.
 - **Network key:** The network encryption key size is 128 bits which is 16 hexadecimal values between 0 x 00 and 0 x FF. The payload of ZigBee messages is encrypted by the network key. The network key is exchanged with a device on pairing.
 - **Automatic network close time (minutes):** The amount of minutes it takes the network (after opening) to automatically close itself.
 - **Debug logging:** Enable/disable ZigBee debug logging. You can see the debug logs in Logs, page 44.
3. Click **Save**.

Add Install Code

The **Add install code** function enables encrypted commissioning of your devices. It is the secure way how to commission your devices. You do not share the network information, for example, the network key.

You need to find out the following information from the QR code of your device:

- **Address** (EUI-64): MAC address
- **Install code**

To enable encrypted commissioning of your device, follow these steps:

1. Click  > select **Add install code**.
2. Enter the MAC address and install code of your device > click **Add**.

NOTE: If your controller disconnects or reboots while adding the installation code and MAC address, you have to start over.

Now commission your device as described in *Pairing the Device*, page 17.

Network Map

The **Network map** function graphically displays the mesh network topology with color-coded links between individual devices. Each link means communication between the devices (sending telegram).

You can filter links by clicking on the menu on the top left:

- **Child:** The device that reaches controller through another device (through parent device).
 - **Parent:** The root device that other devices connect to as a children.
 - **Sibling:** A device that the other device can “hear”, but is not connected to it.
- Active route:** Active connection.

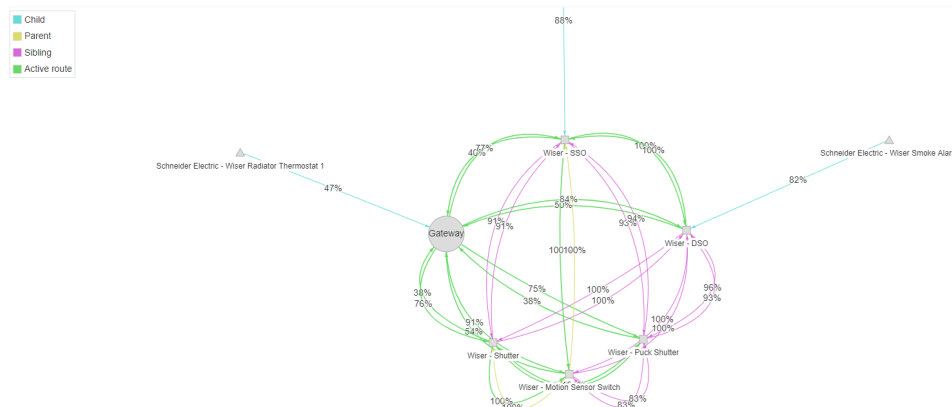

The percentage means the strength of the mesh network signal (this data comes from the router).

Make sure all devices have enough signal to be controllable. Signal strength is also displayed during monitoring – see [Monitor](#), page 40.

Logs

The network log is a direct access data set that stores messages and commands, communications about network functions.

You can gather every packet or a set of packets for further analysis, traffic monitoring, or troubleshooting.

To see the logs, click  > **Logs**:

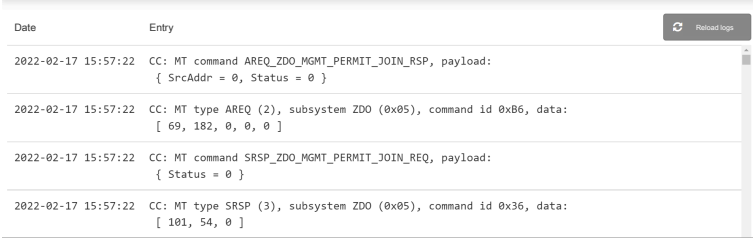

Date	Entry
2022-02-17 15:57:22	CC: MT command AREQ_ZDO_MGMT_PERMIT_JOIN_RSP, payload: { SrcAddr = 0, Status = 0 }
2022-02-17 15:57:22	CC: MT type AREQ (2), subsystem ZDO (0x05), command id 0xB6, data: [69, 182, 0, 0, 0]
2022-02-17 15:57:22	CC: MT command SRSP_ZDO_MGMT_PERMIT_JOIN_REQ, payload: { Status = 0 }
2022-02-17 15:57:22	CC: MT type SRSP (3), subsystem ZDO (0x05), command id 0x36, data: [181, 54, 0]

Several kinds of information can appear in your network log:

- Job time, step time, and data entered by user-written routines.
- Operating data.
- Descriptions of unusual events.

You can reload logs (click **Reload logs**) and export them in a *.txt file to your local storage (click **Export logs**).

Supported Devices

This is a table of devices that have been tested for compatibility. Full compatibility cannot be guaranteed for devices that have not been tested.

Schneider Electric does not provide firmware upgrade for third-party devices.

Find out if your device is supported (Ctrl + F).

IMPORTANT: Before installing the device, check [Specific Configuration of the ZigBee Devices](#), page 35 table for specific configuration requirements.

Actuators

Range	Commercial ref.	Description
Avatar ON	E8331SRYZB_xx	Switch, AvatarOn, Wiser, 1 gang, 1000W
Avatar ON	E8332SRYZB_xx	Switch, AvatarOn, Wiser, 2 gang, 1000W
Avatar ON	E8333SRYZB_xx	Switch, AvatarOn, Wiser, 3 gang, 1000W
Avatar ON	E8331SCN200ZB_xx	Wiser AvatarOn 1G Curtain SW,200W
Avatar ON	E8331DST350ZB_xx	Wiser AvatarOn 1G Dimmer,350W
Avatar ON	E8332SCN300ZB_xx	Wiser AvatarOn 2G Curtain SW,300W
Avatar ON	E8332DST400ZB_xx	Wiser AvatarOn 2G Dimmer,400W
Avatar ON T	E8631SC200ZB_xx_xx	Wiser AvatarOn T 1G Curtain SW,200W
Avatar ON T	E8631DS300ZB_xx_xx	Wiser AvatarOn T 1G Dimmer,300W
Avatar ON T	E8631SR800ZB_xx_xx	Wiser AvatarOn T 1G Switch,800W
Avatar ON T	E8632SC300ZB_xx_xx	Wiser AvatarOn T 2G Curtain SW,300W
Avatar ON T	E8632DS350ZB_xx_xx	Wiser AvatarOn T 2G Dimmer,350W
Avatar ON T	E8632SR800ZB_xx_xx	Wiser AvatarOn T 2G Switch,800W
Avatar ON T	E8633SR800ZB_xx_xx	Wiser AvatarOn T 3G Switch,800W
Exact	WDE00xxxx	Wiser Exxact Push Button relay switch
Exact	WDE00xxxx	Wiser Exxact PushButton LED Dimmer
Exact	WDE00xxxx	Wiser Exxact Rotary LED Dimmer
Exact	WDE00xxxx	Wiser Shutter control switch
FUGA	545D0103 / 545D6103	FUGA® Wiser Multiwire LED Rotary Dimmer
FUGA	545D0102 / 545D6102	FUGA® Wiser Wireless Dimmer
FUGA	545D0111 / 545D6111	FUGA® Wiser Wireless PIR Dimmer with Neutral
FUGA	545D0514 / 545D6514	FUGA® Wiser Wireless Double Relay
FUGA	545D0306 / 545D6306	FUGA® Wiser Wireless Motion Sensor Relay
FUGA	545D0115 / 545D6115	Wiser Relay FUGA® Wiser wireless socket (not fully integrated yet)
Odace	S520567	Connectable Blind Control Switch
Odace	S530567	Connectable Blind Control Switch
Odace	S520513	Connectable Universal Rotary Dimmer
Odace	S530513	Connectable Universal Rotary Dimmer
Odace	S540513	Connectable Universal Rotary Dimmer
Odace	S540567	Wiser blinds & shutters control switch

Range	Commercial ref.	Description
Odace	S520530	Wiser relay switch 10 A
Odace	S530530	Wiser relay switch 10 A
Odace	S540530	Wiser relay switch 10 A
Odace	S520522	Wiser universal push- button dimmer LED
Odace	S530522	Wiser universal push- button dimmer LED
Odace	S540522	Wiser universal push- button dimmer LED
System D	MEG5180-0000 + MEG5116-6000	1G 1-10v Dimmer + 1G Wiser Application Module
System D	MTN5180-0000 + MTN5116-6000	1G 1-10v Dimmer + 1G Wiser Application Module
System D	MEG5185-0000 + MEG5126-6000	1G Dali Dimmer + 1G Wiser Application Module
System D	MEG5151-0000 + MEG5116-6000	1G Electronic Switch + 1G Wiser Application Module
System D	MTN5151-0000 + MTN5116-6000	1G Electronic Switch + 1G Wiser Application Module
System D	MEG5161-0000 + MEG5116-6000	1G Relay Switch + 1G Wiser Application Module
System D	MTN5161-0000 + MTN5116-6000	1G Relay Switch + 1G Wiser Application Module
System D	MEG5165-0000 + MEG5126-6000	1G Shutter + 1G Wiser Application Module
System D	MTN5165-0000 + MTN5126-6000	1G Shutter + 1G Wiser Application Module
System D	MEG5171-0000 + MEG5116-6000	1G Universal Dimmer + 1G Wiser Application Module
System D	MTN5171-0000 + MTN5116-6000	1G Universal Dimmer + 1G Wiser Application Module
System D	MTN5172-0000 + MTN5126-6000	1G Universal Dimmer + 2G Wiser Application Module
System D	MEG5152-0000 + MEG5126-6000	2G Electronic Switch + 2G Wiser Application Module
System D	MTN5152-0000 + MTN5126-6000	2G Electronic Switch + 2G Wiser Application Module
System D	MEG5162-0000 + MEG5126-6000	2G Relay Switch + 2G Wiser Application Module
System D	MTN5162-0000 + MTN5126-6000	2G Relay Switch + 2G Wiser Application Module
System D	MEG5172-0000 + MEG5126-6000	2G Universal Dimmer + 2G Wiser Application Module
System M	MEG5180-0000 + MEG5116-0300	1G 1-10v Dimmer + 1G Wiser Application Module
System M	MTN5180-0000 + MTN5116-0300	1G 1-10v Dimmer + 1G Wiser Application Module
System M	MEG5185-0000 + MEG5126-0300	1G Dali Dimmer + 1G Wiser Application Module
System M	MEG5151-0000 + MEG5116-0300	1G Electronic Switch + 1G Wiser Application Module
System M	MTN5151-0000 + MTN5116-0300	1G Electronic Switch + 1G Wiser Application Module
System M	MEG5161-0000 + MEG5116-0300	1G Relay Switch + 1G Wiser Application Module
System M	MTN5161-0000 + MTN5116-0300	1G Relay Switch + 1G Wiser Application Module
System M	MEG5165-0000 + MEG5126-0300	1G Shutter + 1G Wiser Application Module
System M	MTN5165-0000 + MTN5126-0300	1G Shutter + 1G Wiser Application Module

Range	Commercial ref.	Description
System M	MEG5171-0000 + MEG5116-0300	1G Universal Dimmer + 1G Wiser Application Module
System M	MTN5171-0000 + MTN5116-0300	1G Universal Dimmer + 1G Wiser Application Module
System M	MEG5152-0000 + MEG5126-0300	2G Electronic Switch + 2G Wiser Application Module
System M	MTN5152-0000 + MTN5126-0300	2G Electronic Switch + 2G Wiser Application Module
System M	MEG5162-0000 + MEG5126-0300	2G Relay Switch + 2G Wiser Application Module
System M	MTN5162-0000 + MTN5126-0300	2G Relay Switch + 2G Wiser Application Module
System M	MEG5172-0000 + MEG5126-0300	2G Universal Dimmer + 2G Wiser Application Module
System M	MTN5172-0000 + MTN5126-0300	2G Universal Dimmer + 2G Wiser Application Module
Unica	NU350820	Wiser Antimicrobial blinds & shutters control switch
Unica	NU353720	Wiser Antimicrobial relay switch 10 A
Unica	NU351520	Wiser Antimicrobial universal push-button dimmer LED
Unica	NU351620	Wiser Antimicrobial universal rotary dimmer LED
Unica	NU3508xx	Wiser blinds & shutters control switch
Unica	NU3509xx	Wiser blinds & shutters control switch
Unica	NU3537xx	Wiser relay switch 10 A
Unica	NU3538xx	Wiser relay switch 10 A
Unica	NU3515xx	Wiser universal push- button dimmer LED
Unica	NU3517xx	Wiser universal push- button dimmer LED
Unica	NU3516xx	Wiser universal rotary dimmer LED
Unica	NU3518xx	Wiser universal rotary dimmer LED
Wiser	CCT5010-xxxx	Micromodule Dimmer
Wiser	MEG5010-0001	Micromodule Dimmer
Wiser	CCT5011-xxxx	Micromodule Relay
Wiser	MEG5011-0001	Micromodule Relay
Wiser	CCT5015-xxxx	Micromodule Shutter
Wiser	MEG5015-0001	Micromodule Shutter
Wiser	550B1012	Wiser micromodule dimmer
Wiser	550B1011	Wiser micromodule relay
Wiser	550B1013	Wiser Wireless Blind Control for Build in (Puck)
Wiser	CCT5010-0003	Wiser Multiwire LED Dimmer Puck

Battery Push-buttons

Range	Commercial ref.	Description
Avatar ON	E8332RWMZB_xx	Wiser AvatarOn 2K Freelocate
Avatar ON	E8334RWMZB_xx	Wiser AvatarOn 4K Freelocate

Range	Commercial ref.	Description
Avatar ON T	E8634RWMZB_xx_xx	Wiser AvatarOn T 4K Freelocate
Avatar ON T	E8636RWMZB_xx_xx	Wiser AvatarOn T 6K Freelocate
Exact	WDE002906	Wiser FLS Exxact, 1 gang with rocker white
Exact	WDE002924	Wiser FLS Exxact, 2 gang with rocker white
Odace	S5xx531	Wiser FLS Odace, 1- 2Gang
FUGA	550D0001 / 550D6001	FUGA® Wiser Wireless Battery 4 Button Switch
System D	MEG5001-0600	Wiser FLS System D, 1- 2Gang w/o rocker
System D	MTN5001-0600	Wiser FLS System D, 1- 2Gang w/o rocker
System M	MEG5001-0300	Wiser FLS System M, 1- 2Gang w/o rocker
System M	MTN5001-0300	Wiser FLS System M, 1- 2Gang w/o rocker
Unica	NU557118	Free located wireless switch (1-2 gangs)
Unica	NU557120	Free located wireless switch (1-2 gangs)
Unica	NU557130	Free located wireless switch (1-2 gangs)
Unica	NU557154	Free located wireless switch (1-2 gangs)

PIR/Actuators

Range	Commercial ref.	Description
Exact	WDE00xxxx	Wiser Exxact Motion sensor dimmer
Exact	WDE003367	Wiser Exxact Motion sensor relay
Unica	NU3527xx	Connected Motion sensor & PB dimmer LED
Unica	NU3526xx	Connected Motion sensor with switch 10 A

Sensors

Range	Commercial ref.	Description
Wiser	CCT5950xx/550B1022	Wiser ceiling motion sensor
Wiser	CCT599501/550B1028	Wiser Smoke alarm 230V
Wiser	CCT599001/550B1027	Wiser smoke alarm battery
Wiser	CCT5930xx/550B1024	Wiser temperature and humidity sensor
Wiser	CCT5920xx/550B1021	Wiser water leakage sensor
Wiser	CCT5910xx/550B1023	Wiser door/window sensor

Sockets

Range	Commercial ref.	Description
Avatar ON T	E8631510SSZB_xx_xx	Wiser AvatarOn T 5P switch socket
Exact	WDE00xxxx	Exxact DSO schuko screwles Wiser
Exact	WDE00xxxx	Exxact Wiser Smart single socket outlet 16A

Range	Commercial ref.	Description
Odace	S520559	Wiser Odace Smart socket outlet 16A single outlet - Pin earth type
Odace	S530559	Wiser Odace Smart socket outlet 16A single outlet - Pin earth type
Odace	S540559	Wiser Odace Smart socket outlet 16A single outlet - Pin earth type
System D	MEG2380-603x	Smart socket outlet 16A
System D	MTN2380-603x	Smart socket outlet 16A
System M	MEG2380-0xxx	Smart socket outlet 16A
System M	MTN2380-0xxx	Smart socket outlet 16A
Unica	NU5557xx	Wiser Unica Smart socket outlet 16A single outlet - Schuko type
Unica	NU5559xx	Wiser Unica Smart socket outlet 16A single outlet - Pin earth type
Wiser	CCT711119	Wiser smart plug
Wiser	CCTFR6500	Wiser Plug - FR - Type E
Wiser	CCTFR6501	Wiser Plug (Schuko version)

Thermostats

Range	Commercial ref.	Description
Wiser	CCTFR6100	Wiser Radiator Thermostat
Wiser	CCTFR6100Z3	Wiser Radiator Thermostat (not fully integrated yet)
Wiser	CCTFR6400	Wiser Room Thermostat

Elko Smart

Actuators

Range	Commercial ref.	Description	EL number	Color	Design
NH	EKO30172	SMARTBRYTER 10A RS RH	4540038	Pure white	RS
NH	EKO06996	SMARTBRYTER 10A RS PH	4540037	Polar white	RS
NH	EKO06997	SMARTBRYTER 10A PLUS PH	4540034	Polar white	Plus
NH	EKO06999	SMARTBRYTER 10A PLUS SO	4540036	Black	Plus
LS	EKO07115	SMARTBRYTER TRÅDLØS PLUS PH	4540054	Polar white	Plus
LS	EKO07117	SMARTBRYTER TRÅDLØS PLUS SO	4540056	Black	Plus
LS	EKO07090	SMARTDIM PUCK UNI 200W	4540040		
LS	EKO07144	SMARTRELE PUCK 10AX	4540041		

Range	Commercial ref.	Description	EL number	Color	Design
LS	EKO07145	SMARTSOLSK-JERMING PUCK	4540042		
NH	EKO30166	SMARTDIM 316GLED I RS RH	4540069	Pure white	RS
NH	EKO05669	ESH RS16 316GLED DIMMER RF PH	4523413	Polar white	RS
NH	EKO05821	ESH PLUS 316GLED DIMMER RF PH	4523410	Polar white	Plus
NH	EKO05824	ESH PLUS 316GLED DIMMER RF SO	4523412	Black	Plus
NH	EKO30198	SMARTDIM VRI MULTIWIRES RS RH	4540125	Pure white	RS
NH	EKO07281	SMARTDIM VRI MULTIWIRES PH	4540124	Polar white	RS
NH	EKO07278	SMARTDIM VRI MULTIWIRES PLUS PH	4540121	Polar white	Plus
NH	EKO07280	SMARTDIM VRI MULTIWIRES PLUS SO	4540123	Black	Plus
NH	EKO30169	SMARTMARKISE OPP/NED RS RH	4540048	Pure white	RS
NH	EKO09691	SMARTSOLSK-JERMING BRYTER RS PH	4540047	Polar white	RS
NH	EKO09692	SMARTSOLSK-JERMING BRYTER PLUS PH	4540044	Polar white	Plus
NH	EKO09695	SMARTSOLSK-JERMING BRYTER PLUS SO	4540046	Black	Plus
Wiser	EKO20002	SMARTDIM puck Multiwire	4500098		

PIR/Actuators

Range	Commercial ref.	Description	EL number	Color	Design
NH	EKO30170	SMARTPIR 10A RS RH	4540064	Pure white	RS
NH	EKO06991	SMARTPIR M BRYTER 10A RS PH	4540063	Polar white	RS
NH	EKO06988	SMARTPIR M BRYTER 10A PLUS PH	4540060	Polar white	Plus
NH	EKO06990	SMARTPIR M BRYTER 10A PLUS SO	4540062	Black	Plus
NH	EKO30199	SMARTPIR DIM MULTIWIRES RS RH	4540135	Pure white	RS
NH	EKO07253	SMARTPIR DIM MULTIWIRES PH	4540134	Polar white	RS
NH	EKO07250	SMARTPIR DIM MULTIWIRES PLUS PH	4540131	Polar white	Plus
NH	EKO07252	SMARTPIR DIM MULTIWIRES PLUS SO	4540133	Black	Plus

Sensors

Range	Commercial ref.	Description	EL number
Wiser	EKO07220	SMARTSENSOR BEVEGELSE TRÅDLØS	4540051
Wiser	EKO09764	SMART RØYKVARSLER AC 230V	6210342
Wiser	EKO09761	ELKO SMART RØYKVARSLER BATTERI	6210340
Wiser	EKO07219	SMARTSENSOR TEMP/UKT TRÅDLØS	4540053
Wiser	EKO07218	SMARTSENSOR LEKKASJE TRÅDLØS	4540052
Wiser	EKO07217	SMARTSENSOR DØR/VINDU TRÅDLØS	4540050

Sockets

Range	Commercial ref.	Description	EL number	Color	Design
Wiser	EKO09716	SMARTSTIKK ENKEL 16A PLUS PH	4540088	Polar white	Plus
Wiser	EKO09734	SMARTSTIKK ENKEL 16A PLUS SO	4540090	Black	Plus
Wiser	EKO09738	SMARTSTIKK DOBBEL 16A PLUS PH	4540094	Polar white	Plus
Wiser	EKO09741	SMARTSTIKK DOBBEL 16A PLUS SO	4540096	Black	Plus
Wiser	EKO07699	SMARTPLUGG 16A	4540009	Polar white	Plus

Thermostats

Range	Commercial ref.	Description	EL number	Color	Design
RS16	EKO30465	SmartTermostat RS RH	4523406	Pure white	Plus
Plus	EKO07254	SmartTermostat Plus PH	4523403	Polar white	Plus
Plus	EKO07257	SmartTermostat Plus ALU	4523404	Aluminium	Plus
Plus	EKO07258	SmartTermostat Plus SO	4523405	Black	Plus
RS16	EKO07259	SmartTermostat RS PH	4523402	Polar white	Plus

License Information

Name	License
F-stack-firmware	MIT

Printed in:
Schneider Electric
35 rue Joseph Monier
92500 Rueil Malmaison - France
+ 33 (0) 1 41 29 70 00

Schneider Electric
35 rue Joseph Monier
92500 Rueil Malmaison
France

+ 33 (0) 1 41 29 70 00

www.se.com

As standards, specifications, and design change from time to time, please ask for confirmation of the information given in this publication.

© Schneider Electric. All rights reserved.

2505_LSS100400_SW_04.0