

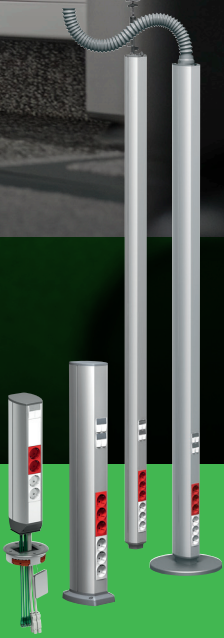

OptiLine 45

Catalogue 2024



se.com

Life Is On

Schneider
Electric

Contents

OptiLine 45 Trunking

Presentation	6
Dimensions.....	9
Cable capacity	10
Choice guide	12
Range.....	15

OptiLine 45 Poles

Presentation	22
Range.....	27
Technical description	32

OptiLine 45 Posts 33

Presentation	33
Range.....	37
Technical description	39

OptiLine 45 Service boxes

Presentation	42
Range.....	43
Technical description	46

OptiLine 45

Reference number overview	48
---------------------------------	----

OptiLine 45

The 45 direct Click-in installation system



Electrical, telephone and data installations must be easy to install, safe to use and flexible enough to ensure that changes are easy to make. The design of the visible parts must also set the right tone in the office.

OptiLine 45 direct click-in installation system provide integrated installation solutions for ceilings, walls, floors and desks.

Together with Unica wiring devices, solutions are created that fulfil the most stringent demands for function, design, convenience and safety.



Direct click-in installation system

- 45 mm front opening
- Direct click-in of Unica 45x45 module wiring devices which gives optimal function and design.

Environment-friendly

- Only lead-free and cadmium-free PVC is used
- The aluminium range offers a halogen-free alternative, including accessories.

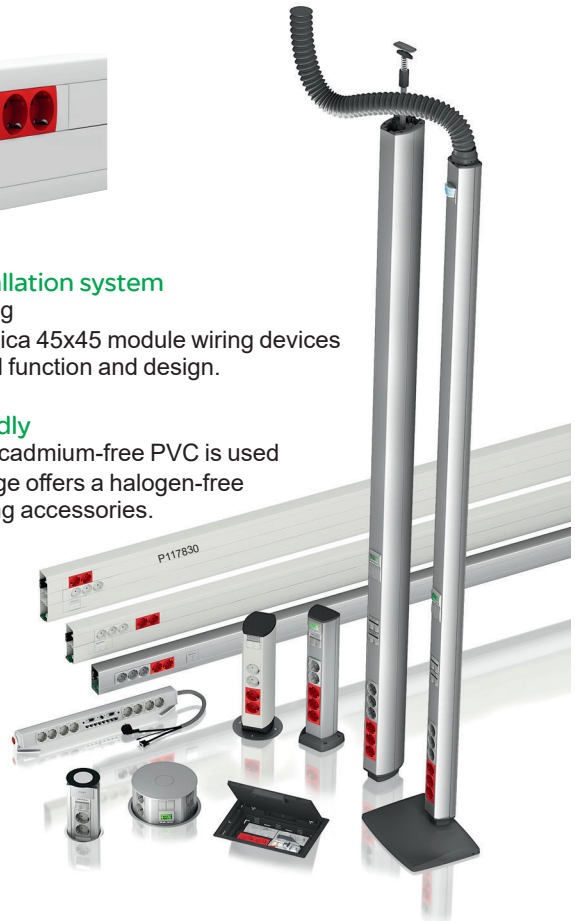

New Unica 45x45 module wiring devices

New Unica is a wiring device series suitable for direct click-in in OptiLine 45 trunking, poles, posts, floor boxes and service boxes.

Range

Unica offers a broad range of socket outlets, switches, VDI outlets and electronic products such as dimmers, movement detectors, thermostats and timers.

Main benefits

- Optional mounting direction for correct user interface in both trunking, poles and posts
- Connection piece for simple interconnection of double and triple outlets without space between
- 45° terminals. Easy to connect even though the outlets are close together
- Dual input and output terminals. For easy loop-through of additional connections such as earthing of trunking.

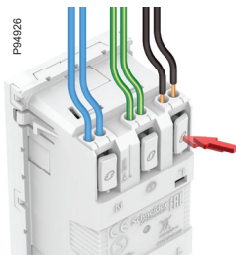
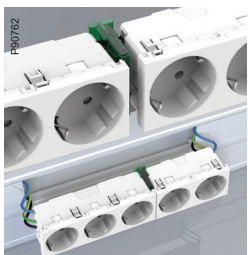



Trunking

A cost-effective installation with high capacity.

The range

Available in PVC or aluminium with one, two or three compartments.



Main benefits:

- Easy installation without the need of instructions. Accessories are mounted directly without adaptation
- 55 mm depth. High cable capacity and space behind the wiring devices
- Pre-punched slots in the partition walls of the PVC trunking. Easy to make holes or openings to feed cables between the compartments
- Trunking base and cover packed together, but not assembled. Easy handling
- Extra-secure click-in function and front locking clip. Gives improved pull-out force.

Poles

The best solution for a truly flexible office, with power, telecom and data services close to the workplaces. Fed from the ceiling, preferably from connection boxes. Free-standing and movable poles give extra freedom. A pole can be moved within a radius of up to 1.5 metres from the connection point in the ceiling.

The range

Available in aluminium, free-standing or tension-mounted. One or two-sided, or with four boxes.



Main benefits:

- Design: Aluminium with a high surface finish. Softly rounded and slender form
- Stable, sturdy design. Several parts are cast
- Movable poles have steady feet. The rectangular foot also allows poles to be installed back-to-back or against a wall
- The adjustable ceiling fixing for tension-mounted poles can be fitted easily without tools. Spring-loaded. Total working range of 400 mm
- Cable separation profile gives the correct spacing between VDI and power cables.

Posts

For power, telecom and data installations close to workplaces, on raised access floors, on screeded floor boxes in concrete floors or on in-cavity floors. Can also be used with other floors, in which case they are supplied via a floor feeder or a floor grommet.

The range

Available in aluminium in one and two-sided versions.

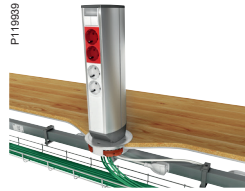

Main benefits:

- Design: Aluminium with a high surface finish. Softly rounded and compact form
- Stable, sturdy design. Several parts are cast
- Accessories for above-floor supply
- Cable separation profile gives the correct spacing between VDI and power cables.

Service boxes

Flexible solutions for the supply of power, telecom and data to desks in offices and conference rooms. The boxes can also be used as connection points in the ceiling for feeding of poles.



The range

- Five box types, all in natural anodised aluminium:
- A six-sided pop-up box, pre-wired with outlets, cable and plug
- A mini pop-up, empty
- A turnable and smoothly rounded one-sided box. Pre-wired with outlets, cables and plugs.
- A one-sided box, empty.
- A flip-up box for flush mounting in desks, empty.

Main benefits:

- The range covers many applications
- Many mounting options including concealed installation
- All products in aluminium and metal – high finish and impact resistant
- Ceiling cable feeder – flexible solution also for movable desks.

OptiLine 45 Trunking Presentation



Installation trunking with 45 mm front opening for direct click-in of Unica wiring devices

OptiLine 45 trunking are available in lead- and cadmium-free PVC or aluminium with a 45 mm front opening. All trunking are 55 mm deep, which gives a high cable capacity and space for cables behind the wiring devices. One of the main advantages is the easy installation. The design is symmetrical and all accessories are click-in mounted without any need of adaptations. It is also very easy to create cross sectional feeding of the cables in the PVC trunking thanks to the pre-punched slots in the partition walls.

Dedicated installation fixings and an extra-secure click-in function for the front and Unica wiring devices give a very reliable installation.

Also the handling is easy. The trunking base and cover are packed together, but not assembled.

PVC Trunking

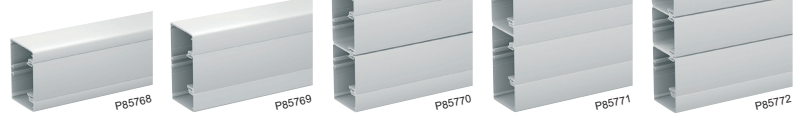

75x55
With one compartment

95x55
With one compartment

140x55
With two compartments

165x55
With two compartments, especially intended for VDI installations

185x55
With three compartments

Aluminium Trunking

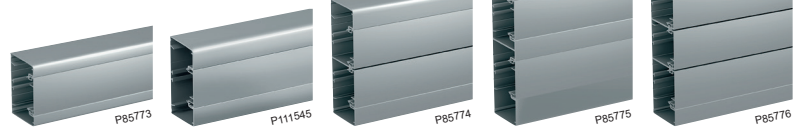

75x55
With one compartment

95x55
With one compartment

140x55
With one compartment

165x55
With two compartments

185x55
With two compartments



Unica 45x45 module wiring devices

The OptiLine 45 range has a front opening for direct click-in of Unica 45x45 module wiring devices which gives optimal function and design.

Unica offers a broad range of socket outlets, switches, VDI outlets and electronic products such as dimmers, movement detectors, thermostats, timers.

The complete trunking system

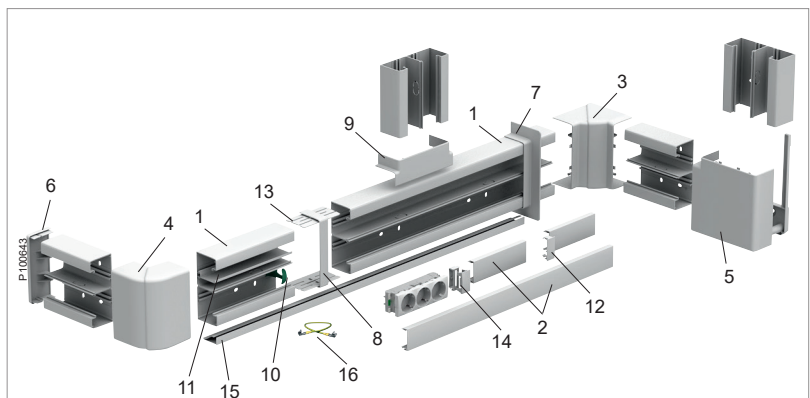

- | | |
|-------------------------------|---------------------------------------|
| 1. Trunking base | 12. Joint cover piece for front cover |
| 2. Front cover | 13. Jointing piece |
| 3. Internal corner | 14. Front locking clip |
| 4. External corner | 15. Sealing strip |
| 5. Bend 90°, incl wall fixing | 16. Earthing kit (Aluminium trunking) |
| 6. Stop end | |
| 7. Wall/ceiling frame | |
| 8. Joint cover piece | |
| 9. T-piece | |
| 10. Cable retainer | |
| 11. Cable shelf | |

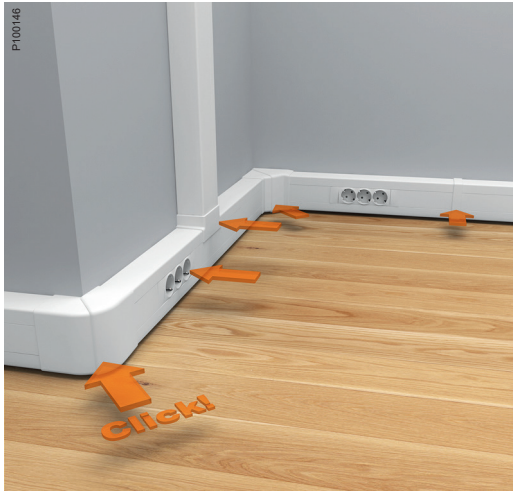

Click-in accessories

All accessories are designed for easy click-in mounting without tools.

- Easy installation without instructions
- Mounted directly without adaptations
- Mounted when trunking is in place.



Efficient mounting support

Both PVC and aluminium trunking profiles are prepared for fast, exact and reliable installation.

- Pre-punched oval holes every 25 cm
- Easy to make X and Y adjustments.

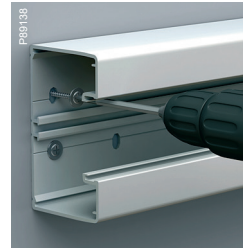

Professional tools and fixings

Dedicated tools and fixings for fast and safe installation.

- Extra long drills and bits to avoid damaging the front when using a drilling machine
- Fixings suitable for any material
- Screws for PVC trunking
- Screws to be used together with single-insulated wires.



Perfect joints

Two jointing pieces for exact levelling and a click-in joint cover piece to hide the gap

- Perfect joints
- No tools needed
- Joint cover piece in one piece
- The jointing pieces can also be used for joints without joint cover piece.

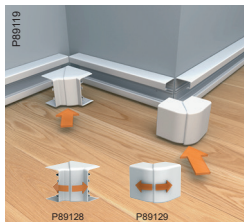

Adjustable corners

The adjustable corners are delivered in one piece.

- Easy and quick to mount
- No adaptations needed.

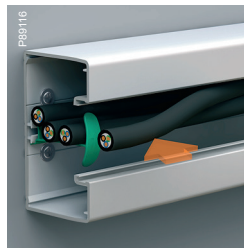

The cable retainer – a helping hand

The cable retainer keeps all the cables in place in the trunking during the installation.

- Faster installation
- One man can do the work
- Green colour for quick identification
- Can remain in place also after the installation.

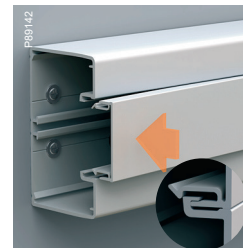

Secure front cover

Auto-guided and extra secure click-in for the front. High-quality material.

- Easy to mount also when kneeling
- Works reliably even at low temperatures
- Can not be opened without a tool
- IP40 classified.

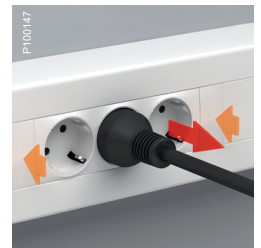

Pull-out safe outlets

Extra secure click-in function combined with a front locking clip.

- High pull-out loads on the wiring devices
- Design aligned with Unica.



Pre-punched slots for easy hole making

Pre-punched slots in the PVC partition walls.

- Easy hole making by hand or with a screwdriver
- Allows cross-sectional feeding of cables.

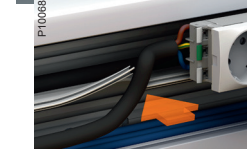
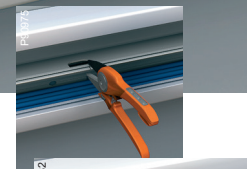

Easy feeding without threading

The pre-punched slots can be cut up with a cutting shears.

- The cables can be laid in without threading
- Very easy to feed cables between the compartments
- Cables and outlets can be separated.



Protective foil

Protective foil on both sides of the trunking base and on the front cover. The main product references including pictures are printed on the foil.

- No surface damages during the installation
- Easy to order new parts.



Dust protection

A sealing strip can be fitted between the trunking and the floor.

- 5-15 mm coverage
- Easy cleaning
- Solid impression.



Smart package

The trunking base and front covers are packed together, but not assembled.

- Easy handling
- No damages. The covers are protected until final installation.

OptiLine 45 Trunking Presentation

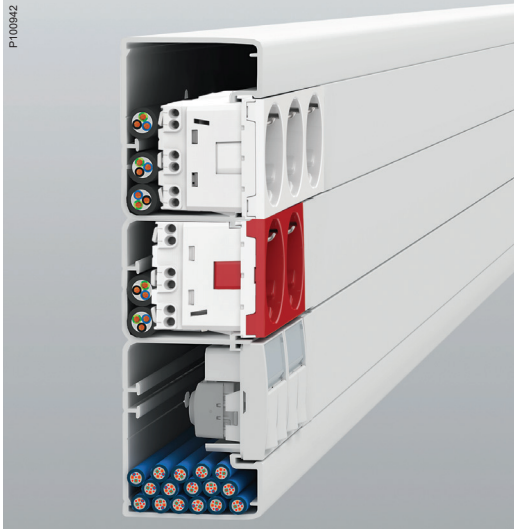

Three-compartment trunking

The three-compartment trunking allows a dedicated space for the wiring devices.

- Maximum distance between VDI and power cables
- High capacity
- Easy installation.



Symmetrical design

The trunking base is symmetrical and has a softly rounded form.

- Easy and safe mounting
- No risk of installing the trunking upside-down
- The trunking form guides the accessories in place.



55 mm depth

All trunking are 55 mm deep.

- High cable capacity
- Space enough for 3x2.5 mm² cables behind the wiring devices.

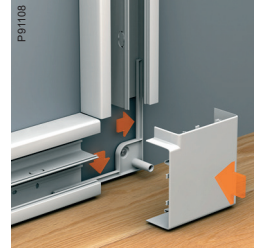

Perfect bends

The bend kit includes an adjustable fixing device to be screw-fitted to the wall.

- Large tolerances when cutting and fixing the trunking
- Self-guiding mounting of the bend piece
- Perfect result and finish.



High classification

The trunking is IP40 and IK07 classified.

- Safe and impact resistant
- Can not be opened without a tool.

The PVC trunking is fire classified in category M1.



One-compartment trunking

Suitable for both installation and distribution. A cable shelf separates VDI cables from power cables.

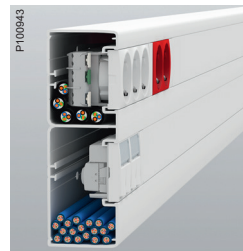

Dedicated VDI trunking

A non-symmetrical two-compartment trunking especially intended for VDI installations.

- Extra space for VDI cables in the larger lower compartment
- Long distance between VDI and power cables.



Easy earthing of aluminium trunking

The aluminium trunking base and front cover has easily accessible earthing rails. A pre-mounted earthing kit is available on one reference number.

- Easy to order
- Quick and easy to mount
- Screwless mounting.



OptiLine 45 Trunking

Dimensions

PVC

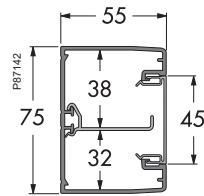

75x55

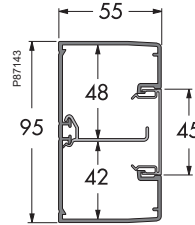

95x55

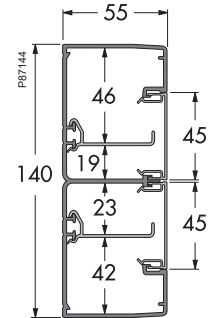

140x55

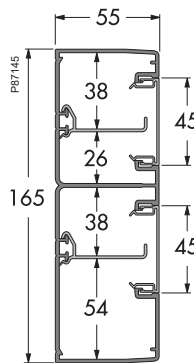

165x55

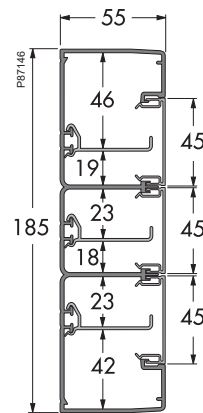

185x55

Aluminium Trunking

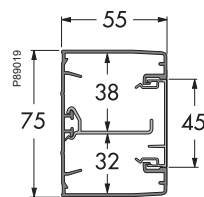

75x55

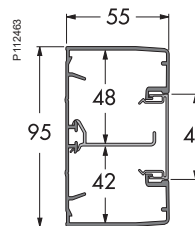

95x55

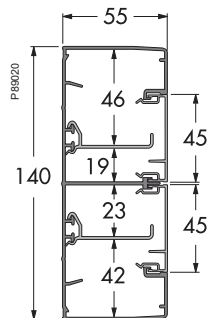

140x55

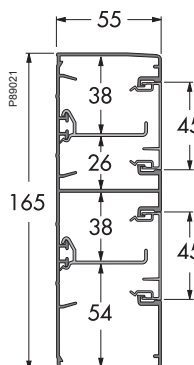

165x55

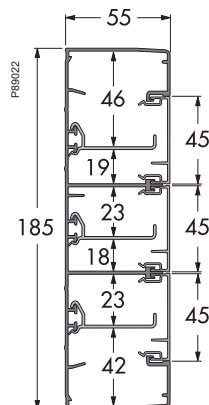

185x55

OptiLine 45 Trunking

Cable capacity

Cable capacity

Installation trunking 75x55 and 95x55 mm

75x55 and 95x55 without outlets
If the trunking is used as a feeder trunking please use this guide to calculate the cable capacity.



Com-part-ment	Fill factor	
	100%	50%
	Inner area	Inner area
■	3508 mm ²	1754 mm ²
■	4505 mm ²	2253 mm ²

75x55 and 95x55 with Unica outlets
If the trunking is used as an installation trunking please use this guide to calculate the cable capacity.

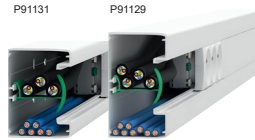

Com-part-ment	Fill factor	
	100%	50%
	Inner area	Inner area
■	2385 mm ²	1193 mm ²
■	3382 mm ²	1691 mm ²

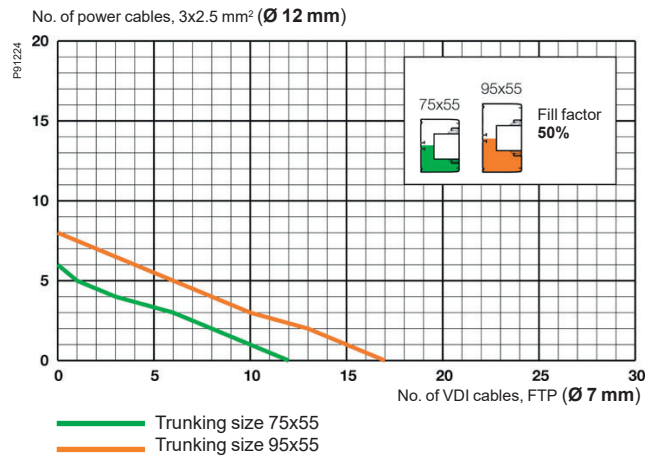
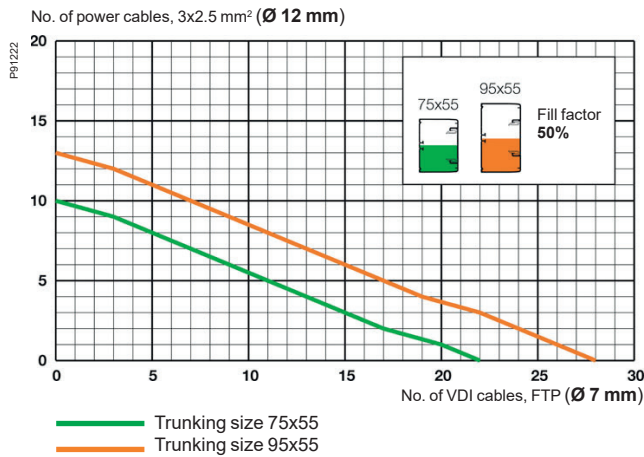

Installation trunking 140x55 mm

140x55 without outlets
If the trunking is used as a feeder trunking please use this guide to calculate the cable capacity.

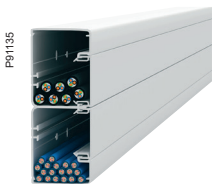

Com-part-ment	Fill factor	
	100%	50%
	Inner area	Inner area
■	3303 mm ²	1652 mm ²
■	3303 mm ²	1652 mm ²

140x55 with Unica outlets
If the trunking is used as an installation trunking please use this guide to calculate the cable capacity.



Com-part-ment	Fill factor	
	100%	50%
	Inner area	Inner area
■	2180 mm ²	1090 mm ²
■	2180 mm ²	1090 mm ²

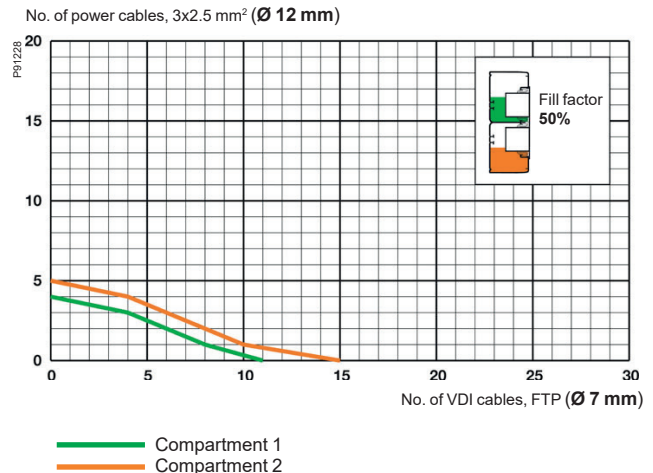
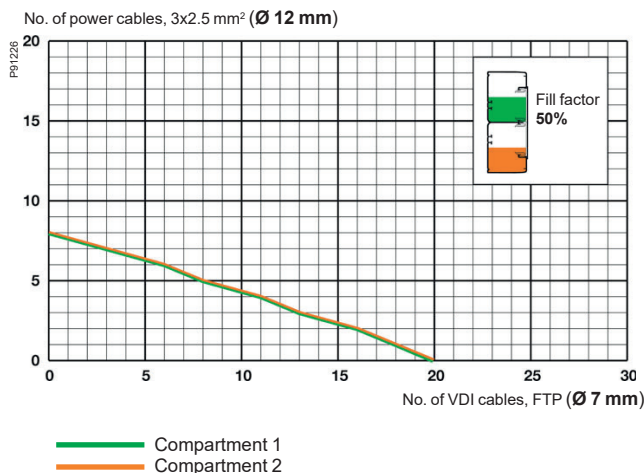

A more detailed calculation can be made in the OptiLine system specification tool.

OptiLine 45 Trunking

Cable capacity

Cable capacity

Installation trunking 165x55 mm

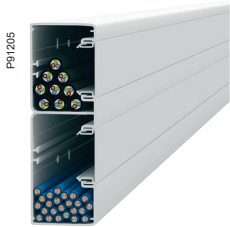

165x55 (VDI) without outlets
If the trunking is used as a feeder trunking please use this guide to calculate the cable capacity.

Com-part-ment	Fill factor	
	100%	50%
	Inner area	Inner area
■	3374 mm ²	1687 mm ²
■	4358 mm ²	2179 mm ²

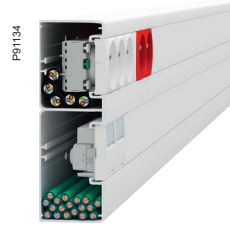

165x55 (VDI) with Unica outlets
If the trunking is used as an installation trunking please use this guide to calculate the cable capacity.

Com-part-ment	Fill factor	
	100%	50%
	Inner area	Inner area
■	2251 mm ²	1126 mm ²
■	3235 mm ²	1618 mm ²

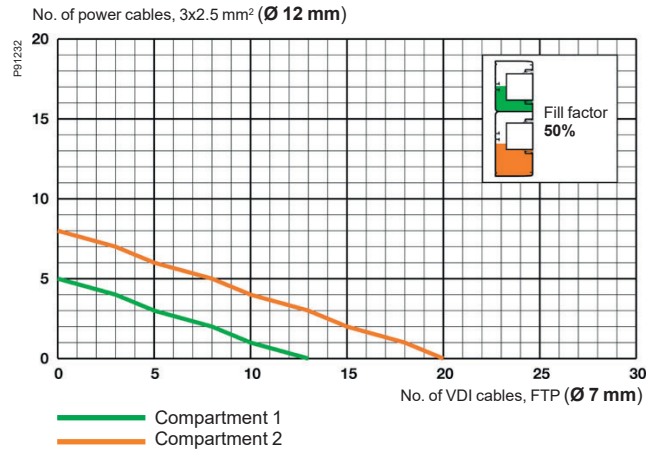
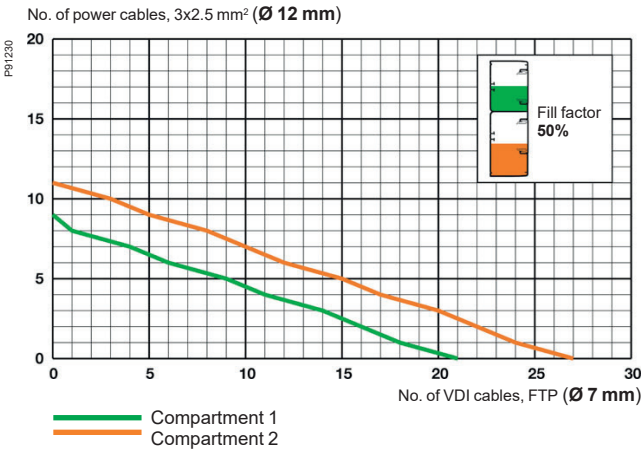

Installation trunking 185x55 mm

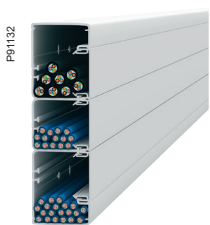

185x55 without outlets
If the trunking is used as a feeder trunking please use this guide to calculate the cable capacity.

Com-part-ment	Fill factor	
	100%	50%
	Inner area	Inner area
■	3218 mm ²	1609 mm ²
■	2187 mm ²	1094 mm ²
■	3218 mm ²	1609 mm ²

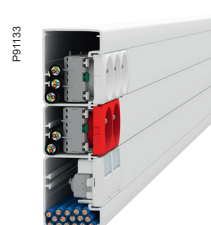

185x55 with Unica outlets
If the trunking is used as an installation trunking please use this guide to calculate the cable capacity.

Com-part-ment	Fill factor	
	100%	50%
	Inner area	Inner area
■	2095 mm ²	1048 mm ²
■	1064 mm ²	532 mm ²
■	2095 mm ²	1048 mm ²

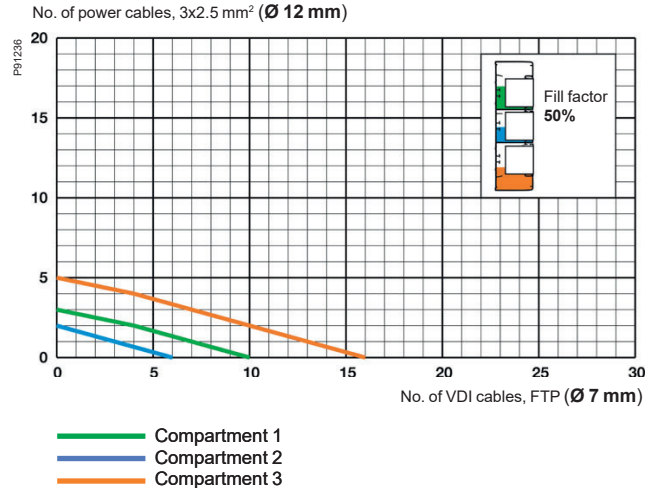
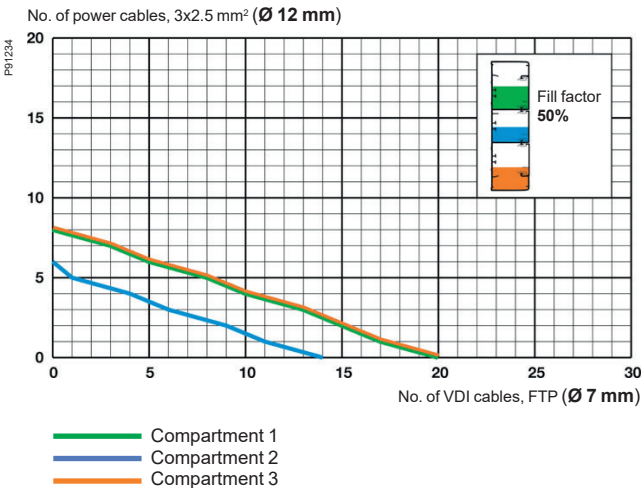











A more detailed calculation can be made in the OptiLine system specification tool.







OptiLine 45 Trunking

Choice guide

Trunking and accessories

Trunking size	Trunking incl. separate front cover		Internal corner		External corner		Bend 90°		Stop end		Wall/ceiling frame	
	Ref. No.	Qty per pack	Ref. No.	Qty per pack	Ref. No.	Qty per pack	Ref. No.	Qty per pack	Ref. No.	Qty per pack	Ref. No.	Qty per pack
PVC												
75x55 	ISM10100P ISM10110P	24 m	ISM10101P	1	ISM10102P	1	ISM10103P	1	ISM10104P	2	ISM10105P	1
95x55 	ISM10200P	12 m	ISM10201P	1	ISM10202P	1	ISM10203P	1	ISM10204P	2	ISM10205P	1
140x55 	ISM10300P ISM10310P	12 m	ISM10301P	1	ISM10302P	1	ISM10303P	1	ISM10304P	2	ISM10305P	1
165x55 	ISM10400P	12 m	ISM10401P	1	ISM10402P	1	-	-	ISM10404P	2	-	-
185x55 	ISM10500P	8 m	ISM10501P	1	-	-	ISM10503P	1	ISM10504P	2	ISM10505P	1
Aluminium												
75x55 	ISM10150	12 m	-	-	-	-	-	-	ISM10154	2	-	-
95x55 	ISM10250	12	-	-	-	-	-	-	-	-	-	-
140x55 	ISM10350	6 m	ISM10351	1	ISM10352	1	ISM10353	1	ISM10354	2	ISM10355	1
165x55 	ISM10450	6 m	-	-	-	-	-	-	-	-	-	-
185x55 	ISM10550	6 m	ISM10551	1	-	-	-	-	ISM10554	2	-	-

P=Polars white

											
Ref. No.	Qty per pack	Ref. No.	Qty per pack	Ref. No.	Qty per pack	Ref. No.	Qty per pack	Ref. No.	Qty per pack	Ref. No.	Qty per pack
ISM10106P	1	ISM10107P	1	ISM10900P	24 m	ISM10950	24 m	ISM10903P	5	ISM10904	10
ISM10206P	1	ISM10207P ISM10208P	1	ISM10900P	24 m	ISM10950	24 m	ISM10903P	5	ISM10904	10
ISM10306P	1	ISM10207P ISM10208P	1	ISM10900P	24 m	ISM10950	24 m	ISM10903P	5	ISM10904	10
-	-	ISM10207P ISM10208P	1	ISM10900P	24 m	ISM10950	24 m	ISM10903P	5	ISM10904	10
ISM10506P	1	ISM10207P ISM10208P	1	ISM10900P	24 m	ISM10950	24 m	ISM10903P	5	ISM10904	10
-	-	-	-	-	-	ISM10950	24 m	ISM10951	5	ISM10904	10
-	-	-	-	-	-	ISM10950	24 m	ISM10951	5	ISM10904	10
ISM10356	1	-	-	-	-	ISM10950	24 m	ISM10951	5	ISM10904	10
-	-	-	-	-	-	ISM10950	24 m	ISM10951	5	ISM10904	10
-	-	-	-	-	-	ISM10950	24 m	ISM10951	5	ISM10904	10

OptiLine 45 Trunking Range

PVC trunking

Type	Colour	Dimensions A/B/C (mm)	Qty per package	EAN code	Ref. No.
------	--------	-----------------------	-----------------	----------	----------

Installation trunking

Installation trunking including one-compartment trunking base and front cover. The trunking base has pre-punched mounting holes every 25th cm and can be provided with cable shelves. 45 mm front opening for direct click-in of Unica 45x45 module wiring devices.

Trunking base and front cover are supplied unassembled under separate protective foil, in lengths of 2 m. Size 75 mm is also available in lengths of 3 m.

Material: PVC.

With one compartment	Polar white	75/55/2000 75/55/3000	24 m	3606480681493 3606480681578	ISM10100P ISM10110P
----------------------	-------------	--------------------------	------	--------------------------------	------------------------

With one compartment	Polar white	95/55/2000	12 m	3606480681585	ISM10200P
----------------------	-------------	------------	------	---------------	-----------

Installation trunking including two or three-compartment trunking base and front covers. The trunking base has pre-punched mounting holes every 25th cm and can be provided with cable shelves. The integrated partition wall has pre-punched slots every 25th cm to facilitate cable laying. 45 mm front opening for direct click-in of Unica 45x45 module wiring devices.

Trunking base and front cover are supplied unassembled under separate protective foil, in lengths of 2 m. Size 140 mm is also available in lengths of 3 m.

Material: PVC.

With two compartments	Polar white	140/55/2000 140/55/3000	12 m	3606480681677 3606480681752	ISM10300P ISM10310P
-----------------------	-------------	----------------------------	------	--------------------------------	------------------------

With two compartments, the lower comp. for VDI appl.	Polar white	165/55/2000	12 m	3606480681769	ISM10400P
--	-------------	-------------	------	---------------	-----------

With three compartments	Polar white	185/55/2000	8 m	3606480681837	ISM10500P
-------------------------	-------------	-------------	-----	---------------	-----------

P85768



P85769



P85770



P85771



P85772



Accessories for PVC trunking

Internal corner

Adjustable internal corner for an 80–100 degree angling of PVC trunking.

Material: PC/ABS.

For trunking 75x55	Polar white	84/117/117	1	3606480681509	ISM10101P
For trunking 95x55	Polar white	104/117/117	1	3606480681592	ISM10201P
For trunking 140x55	Polar white	149/117/117	1	3606480681684	ISM10301P
For trunking 165x55	Polar white	174/117/117	1	3606480681776	ISM10401P
For trunking 185x55	Polar white	194/117/117	1	3606480681844	ISM10501P

External corner

Adjustable external corner for a 75–135 degree angling of PVC trunking.

Material: PC/ABS.

For trunking 75x55	Polar white	84/105/105	1	3606480681516	ISM10102P
For trunking 95x55	Polar white	104/105/105	1	3606480681608	ISM10202P
For trunking 140x55	Polar white	149/105/105	1	3606480681691	ISM10302P
For trunking 165x55	Polar white	174/105/105	1	3606480681783	ISM10402P

P89087



P89088



Accessories for PVC trunking

Type	Colour	Dimensions A/B/C (mm)	Qty per package	EAN code	Ref. No.
Bend, 90°, kit					
90 degree bend kit for angling upwards and downwards of PVC trunking. Including bend piece and fixing device to be screw-fitted to the wall. Material: PC/ABS.					
For trunking 75x55	Polar white	102/57/102	1	3606480681523	ISM10103P
For trunking 95x55	Polar white	122/57/122	1	3606480681615	ISM10203P
For trunking 140x55	Polar white	167/57/167	1	3606480681707	ISM10303P
For trunking 185x55	Polar white	212/57/212	1	3606480681868	ISM10503P
Stop end					
Stop end for PVC trunking. Fast fitting with locking clips. Screw-fixing possible for extra security. Package of two. Material: PC/ABS.					
For trunking 75x55	Polar white	79/56/21	2	3606480681530	ISM10104P
For trunking 95x55	Polar white	99/56/21	2	3606480681622	ISM10204P
For trunking 140x55	Polar white	144/56/21	2	3606480681714	ISM10304P
For trunking 165x55	Polar white	169/56/21	2	3606480681806	ISM10404P
For trunking 185x55	Polar white	189/56/21	2	3606480681875	ISM10504P
Wall/ceiling frame					
Wall/Ceiling frame to be fitted around a PVC trunking at wall or ceiling passage. Easily modified to C or L-profile depending on how the passage is made. Snap-fitted, with a screw-fixing option for high security. Material: PC/ABS.					
For trunking 75x55	Polar white	130/82/22	1	3606480681547	ISM10105P
For trunking 95x55	Polar white	150/82/22	1	3606480681639	ISM10205P
For trunking 140x55	Polar white	195/82/22	1	3606480681721	ISM10305P
For trunking 185x55	Polar white	240/82/22	1	3606480681882	ISM10505P
Joint cover piece, kit					
Joint cover piece, supplied and mounted together with two jointing pieces. Intended to cover joints between two PVC trunking sections. Easy to remove in case of an upgrading of the installation. Material: PC/ABS.					
For trunking 75x55	Polar white	80/57/100	1	3606480681554	ISM10106P
For trunking 95x55	Polar white	100/57/100	1	3606480681646	ISM10206P
For trunking 140x55	Polar white	145/57/100	1	3606480681738	ISM10306P
For trunking 185x55	Polar white	190/57/100	1	3606480681899	ISM10506P

P.85779



P.85780



P.85781













P.85782



OptiLine 45 Trunking Range

Accessories for PVC trunking

Type	Colour	Dimensions A/B/C (mm)	Qty per package	EAN code	Ref. No.
T-piece					
T-piece intended to connect vertical and horizontal PVC trunking of various sizes. Material: PC/ABS.					
	For vertical trunking 75x55 and horizontal trunking 75x55	Polar white	42/57/97	1	3606480681561 ISM10107P
	For vertical trunking 75x55 and horizontal trunking 95x55, 140x55, 165x55 or 185x55	Polar white	52/57/97	1	3606480681653 ISM10207P
	For vertical trunking 95x55 and horizontal trunking 95x55, 140x55, 165x55 or 185x55	Polar white	52/57/117	1	3606480681660 ISM10208P
Front cover					
Front cover to be snap-fitted in trunking with a 45 mm front opening. Supplied with protective foil, in lengths of 2 m. Material: PVC or aluminium.					
	Front cover, PVC	Polar white	45/16/2000	24 m	3606480681905 ISM10900P
	Front cover, aluminium, with earthing slots	Anodized	45/16/2000	24 m	3606480028489 ISM10950
Cable shelf					
Single cable shelf to be mounted in the trunking base, providing separation between power and low voltage cables. Supplied in lengths of 1 m. Material: PVC.					
	Cable shelf	White	17/47/1000	24 m	3606480028410 ISM10902
Joint cover piece for front cover					
Joint cover piece intended to cover joints between two front covers. Package of five. Material: PC/ABS.					
	Joint cover piece for PVC front cover	Polar white	47/20/23	5	3606480681929 ISM10903P
	Joint cover piece for aluminium front cover	Alu metallic	47/20/23	5	3606480028496 ISM10951
Joining piece					
Internal joining piece intended to facilitate jointing of two PVC trunking bases. May also be used to mount the joint cover piece. Package of ten. Material: PC/ABS.					
	Joining piece	White	4/51/100	10	3606480028441 ISM10904
Front locking clip					
Front locking clip to be mounted on either side of an outlet in order to secure pull-out forces. Package of ten. Material: PC/ABS.					
	Front locking clip	Polar white	45/23/23	10	3606489604141 ISM10909P
Cutting shears					
Cutting shears for PVC material. To be used when for instance cutting slots in the partition walls of PVC trunking (sizes 140 and 185) for easy cable laying between compartments. Also suitable when cutting front covers, cable shelves or other PVC length material, instead of using a saw. Material: Steel.					
	Cutting shears	Orange	230/22/80	1	3606480028472 ISM10908
Label holder					
Label holder for marking purposes. Package of ten. Material: PC/ABS.					
	Label holder	White	23/23/45	10	3606489843021 ISM10920P
		Anthracite	23/23/45	10	3606489843038 ISM10921
		Alu metallic	23/23/45	10	3606489843045 ISM10922
		Red	23/23/45	10	3606490159319 ISM10923

Aluminium trunking

Type	Colour	Dimensions A/B/C (mm)	Qty per package	EAN code	Ref. No.
Installation trunking					
Installation trunking including one, two or three-compartment trunking base and front cover(s). The trunking base has pre-punched mounting holes every 25 th cm and can be provided with cable shelves. 45 mm front opening for direct click-in of Unica 45x45 module wiring devices. Trunking base and front cover are supplied unassembled under separate protective foil, in lengths of 2 m. Material: Aluminium.					
With one compartment	Anodized	75/55/2000	12 m	3606480027789	ISM10150
With one compartment	Anodized	95/55/2000	12 m	3606485137728	ISM10250
With two compartments	Anodized	140/55/2000	6 m	3606480028021	ISM10350
With two compartments, the lower comp. for VDI appl.	Anodized	165/55/2000	6 m	3606480028182	ISM10450
With three compartments	Anodized	185/55/2000	6 m	3606480028328	ISM10550

P85773



P111545

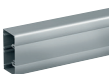

P85774

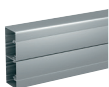

P85775



P85776



Accessories for aluminium trunking

Internal corner					
Adjustable internal corner for an 80–100 degree angling of aluminium trunking. Material: PC/ABS, painted.					
For trunking 140x55	Alu metallic	149/117/117	1	3606480028038	ISM10351
For trunking 185x55	Alu metallic	194/117/117	1	3606480028335	ISM10551
External corner					
Adjustable external corner for a 75–135 degree angling of aluminium trunking. Material: PC/ABS, painted.					
For trunking 140x55	Alu metallic	149/105/105	1	3606480028045	ISM10352
Bend, 90°, kit					
90 degree bend kit for angling upwards and downwards of aluminium trunking. Including bend piece and fixing device to be screw-fitted to the wall. Material: PC/ABS, painted.					
For trunking 140x55	Alu metallic	167/57/167	1	3606480028052	ISM10353

P85797



P85798



P85799

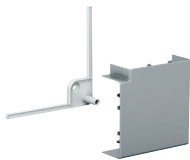

Accessories for aluminium trunking

Type	Colour	Dimensions A/B/C (mm)	Qty per package	EAN code	Ref. No.
Stop end					
Stop end for aluminium trunking. Including screw and nut to fix the stop end in the trunking base. Material: PC/ABS, painted.					
For trunking 75x55	Alu metallic	79/56/21	2	3606480027826	ISM10154
For trunking 140x55	Alu metallic	144/56/21	2	3606480028069	ISM10354
For trunking 185x55	Alu metallic	189/56/21	2	3606480028366	ISM10554
Wall/Ceiling frame					
Wall/Ceiling frame to be fitted around an aluminium trunking at wall or ceiling passage. Easily modified to C or L-profile depending on how the passage is made. Snap-fitted, with a screw-fixing option for high security. Material: PC/ABS, painted.					
For trunking 140x55	Alu metallic	195/82/22	1	3606480028076	ISM10355
Joint cover piece, kit					
Joint cover piece, supplied and mounted together with two jointing pieces. Intended to cover joints between two aluminium trunking sections. Easy to remove in case of an upgrading of the installation. Material: PC/ABS, painted.					
For trunking 140x55	Alu metallic	145/57/100	1	3606480028083	ISM10356
Front cover					
Front cover to be snap-fitted in trunking with a 45 mm front opening. With earthing slots. Supplied with protective foil, in lengths of 2 m. Material: Aluminium.					
Front cover	Anodized	45/16/2000	24 m	3606480028489	ISM10950
Cable shelf					
Single cable shelf to be mounted in the trunking base, providing separation between power and low voltage cables. Supplied in lengths of 1 m. Material: PVC.					
Cable shelf	White RAL 9010	17/47/1000	24 m	3606480028410	ISM10902

P85900



P85801



P85802



P85796

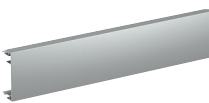

P85788



Accessories for aluminium trunking

Type	Colour	Dimensions A/B/C (mm)	Qty per package	EAN code	Ref. No.
Joint cover piece for front cover					
Joint cover piece intended to cover joints between two aluminium front covers. Package of five. Material: PC/ABS, painted.					
Joint cover piece	Alu metallic	46/20/23	5	3606480028496	ISM10951
Joining piece					
Internal joining piece intended to facilitate jointing of two aluminium trunking bases. May also be used to mount the joint cover piece. Package of ten. Material: PC/ABS.					
Joining piece	White	4/51/100	10	3606480028441	ISM10904
Modular device adaptor					
2-module adaptor for 1-2 modular devices like for instance miniature circuit breakers. With transparent grey cover. Material: PC+ASA.					
Modular device adaptor	Alu metallic	90/72/45	1	3606480028540	ISM10957
Earthing clamp					
Earthing clamp to be used for bonding of front cover, trunking base and accessories to earth. Package of ten. Material: Steel.					
Earthing clamp	—	9/9/9	20	3606480028502	ISM10952
Earthing kit					
Kit including earth wire with flat pin connectors and earthing clamps. To be used to connect the front cover to the base profile or the base profile to another base profile.					
Earthing kit	Yellow/green	L = 200	10	3606480028519	ISM10953
		L = 300	10	3606480028526	ISM10954
Front locking clip					
Front locking clip to be mounted on either side of an outlet in order to secure pull-out forces. Package of ten. Material: PC/ABS.					
Front locking clip	Polar white	45/23/23	10	3606489604141	ISM10909P
Label holder					
Label holder for marking purposes. Package of ten. Material: PC/ABS.					
Label holder	White	23/23/45	10	3606489843021	ISM10920P
	Anthracite	23/23/45	10	3606489843038	ISM10921
	Alu metallic	23/23/45	10	3606489843045	ISM10922
	Red	23/23/45	10	3606490159319	ISM10923

Fixing products

Type	Colour	Dimensions (mm)	Qty per package	EAN code	Ref. No.
Wall plugs					
Wall plug on sprue plate, suitable for use in concrete, stone, lightweight concrete, expanded clay, hollow bricks, solid bricks and plasterboard. Material: PE-HD.					
TP 2	Red	Ø5.5x35	100	7315881003006	1003003
TP 2B	Brown	Ø8x40	100	7315881005000	1005008
Same as above but single. Material: PE-HD.					
TP 6	Red	Ø6x30	100	7315881003020	1003020
Nail plugs					
Nail plug including nail for through installation. Suitable for use in concrete, stone, lightweight concrete, expanded clay, hollow bricks, solid bricks and plasterboard. Material: PA.					
TPS-6/5x35	Clear	Drill Ø6	100	7315881150007	1150002
TPS-6/20x50	Clear	Drill Ø6	100	7315880100027	1150051
Installation screws					
Screw with large thin head and integrated washer. Phillips cross recess. Twin thread. Fully threaded. Gives very good pressure when fixing plastic trunking. Material: Hardened steel, electroplated.					
TSC-32	—	Ø4.2x25	100	7315883782022	3782020
TSC-33	—	Ø4.2x31	100	7315883782039	3782030
Screw with raised countersunk head, Phillips cross recess. Fully threaded. Suitable for mounting directly into plasterboard. Material: Steel, electroplated.					
TSF-25	—	Ø4.8x25	100	7315883782428	3782420
TSF-35	—	Ø4.8x35	100	7315883782435	3782430
TSF-45	—	Ø4.8x45	100	7315883782442	3782440
Installation screw with cup washer					
Screw with cross-slotted head type PH2. Sharp point, fully threaded. High pitch for quick mounting. Provided with a cup washer for screw-head protection. To be used when installing single-insulated wire in the trunking. Material: Hardened steel, electroplated, and PP.					
TFT-IS5x32	—	Ø5x32	100	7332418018203	4020210
Cavity fixings					
Cavity fixing with metal toggle for high load values. Material: Zinc/Steel.					
TPP-10xM4S	—	Drill Ø10	25	7315881200009	1200005
TPP-13xM5S	—	Drill Ø13	25	7315881200405	1200401
Cavity fixing for light installations in plasterboard. Board thickness from 9 mm. Screw size 4.5x35. Material: Zinc.					
TPD-Metal	—	Screw size 4.5x35	100	7315880114291	1220104
Cavity fixing including a 38 mm long screw. The shape of THW prevents it from rotating. No pre-drilling needed, just hammer in. Excellent for porous and thin material. Pull-out load 100 N, safety factor 3, shear load 100N, safety factor 2.5. Board thickness 6-13 mm, max. thickness of fixture 16 mm. Material: Steel, electroplated.					
THW 4.2x38	—	—	50	7315881260171	1260170

Design and dimensions

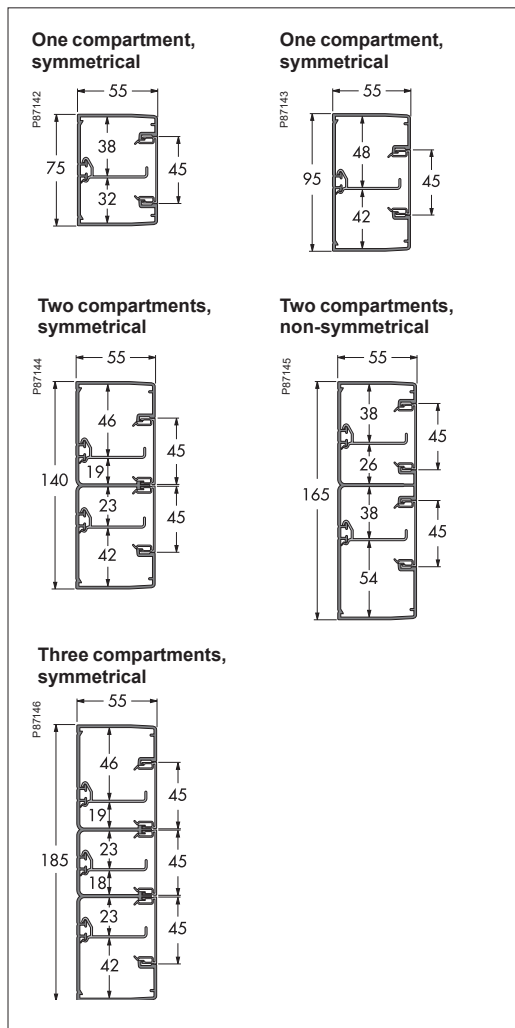

Technical and Material data

PVC (self-extinguishing, lead and cadmium-free)	Fire rating	UL 94 V0 (0.8 mm)
Aluminium	Colour	Polar white (RAL 9003)
PC/ABS	Surface treatment	Natural anodizing
	Fire rating	UL 94 HB
	Colours	<ul style="list-style-type: none"> • Polar white (RAL 9003) • Aluminium metallic (painted)
PA (polyamide), halogen-free	Fire rating	UL 94 V0
	Colours	<ul style="list-style-type: none"> • Green • Clear
PC+ASA	Fire rating	UL 94 HB
	Colours	<ul style="list-style-type: none"> • Polar white (RAL 9003) • Aluminium metallic
PE (polyethylene), halogen-frees	Fire rating	UL 94 HB
	Colours	<ul style="list-style-type: none"> • Red • Brown • Black
Degree of protection	IP40	
Temperature range	Operating temperature from -25°C to +60°C	
Resistance to impact	PVC trunking	2J (IK07)
	PC/ABS accessories	2J (IK07)
Standards and certificates	The products comply with the standards: <ul style="list-style-type: none"> • EN 50085-1:2005 • pr EN 50085-2-1:2002 • NFC 68 102:1990 (French national standard) The products satisfy the provisions for CE marking according to the Low Voltage Directive 73/23/EEC and 93/68/EEC.	

Exploded view

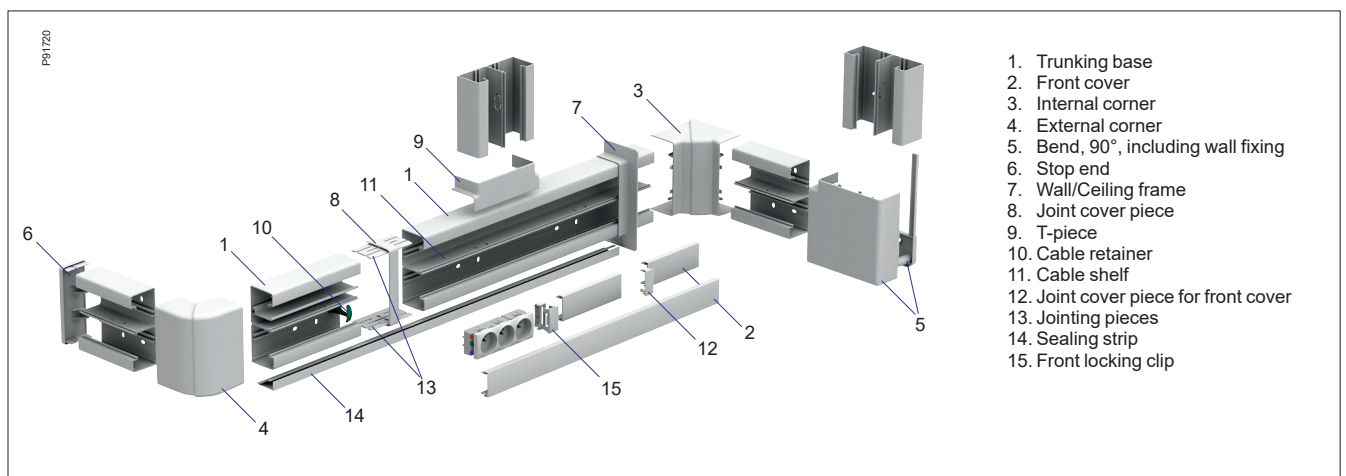

OptiLine 45 Poles

Presentation



Service poles with 45 mm front opening for direct click-in of Unica wiring devices

OptiLine 45 service poles with a 45 mm front opening offer very flexible installation solutions, bringing power, telecom and data directly from the ceiling to the desk.

The poles have a softly rounded and slender form and are made of aluminium with a high surface finish, either natural anodised or powder coated white. They are installed free-standing in the room mounted on a foot and movable within a radius of up to 1.5 metres from the connection point in the ceiling, or tension-mounted between floor and ceiling. Both types are available in one and two-sided versions, or with four boxes.

The spring-loaded and adjustable ceiling fixing for tension-mounted poles can be fitted easily without tools.



Unica 45x45 module wiring devices

The OptiLine 45 range has a front opening for direct click-in of Unica 45x45 module wiring devices which gives optimal function and design.

Unica offers a broad range of socket outlets, switches, VDI outlets and electronic products such as dimmers, movement detectors, thermostats, timers.

One-sided poles

Free-standing



Alu White

Two-sided poles

Free-standing



Alu White

With boxes

Free-standing



Alu White

Tension-mounted



Alu White

Tension-mounted



Alu White

Tension-mounted

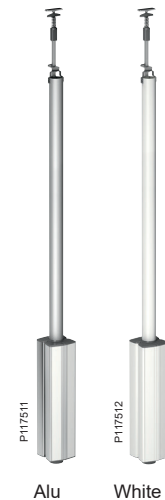

Alu White

OptiLine 45 Poles Presentation

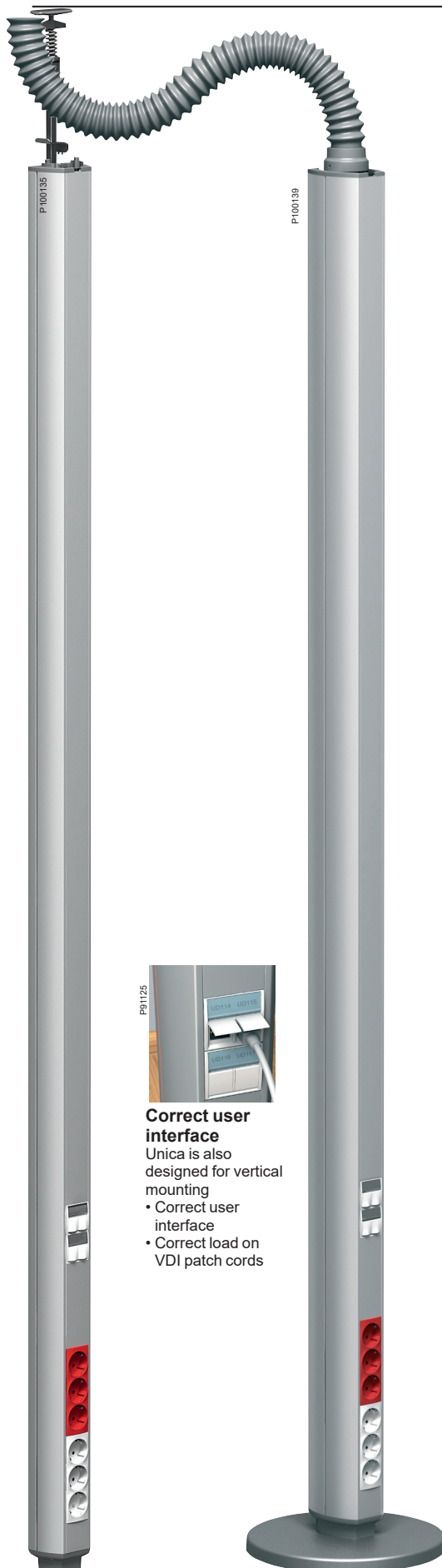

Design, finish and quality

All OptiLine poles are made of aluminium, anodized or powder coated, with a high surface finish. The form is softly rounded and slender. All parts are designed to give reliable function and easy installation.

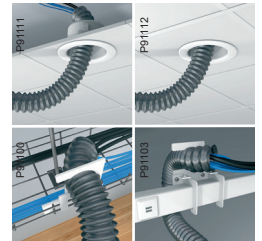
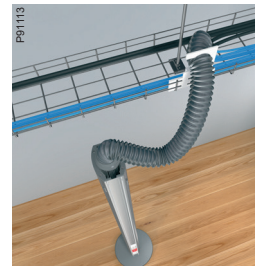

Many mounting options

Accessories for all mounting options. The ceiling frame for the flexible conduit is mounted without a tool and can be adjusted to different ceiling thicknesses.

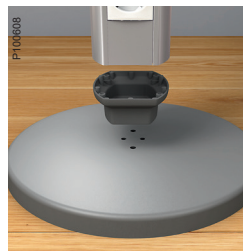

Stable and sturdy

All parts in aluminium, several are die-cast. Foot in sand-cast iron.

- Stable and sturdy design
- Reliable function
- High-quality impression.



Innovative square foot

The foot has a steel clamp that can be unfolded for extra support.

- Steady
- Nice installation close to the wall
- Two poles can be placed back to back.

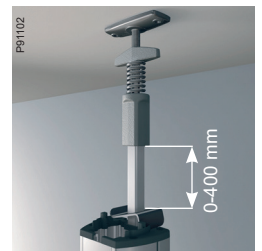

Handy ceiling fixing

Fitted easily without tools.

- Self-locking adjustment.
- Quick and safe installation
- 400 mm working range
- Mechanism outside the pole – does not interfere with the wiring devices.



Correct user interface

Unica is also designed for vertical mounting

- Correct user interface
- Correct load on VDI patch cords

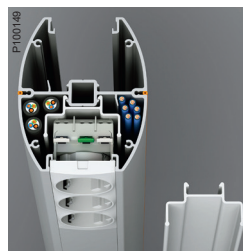

Cable separation

Partition profile for good separation of cables.

- Correct distance between VDI and power cables
- Full isolation between terminations and cables.



Screw slots

Slots along both sides of the pole.

- For decorative colour strips
- For products like spotlights, small shelves etc.

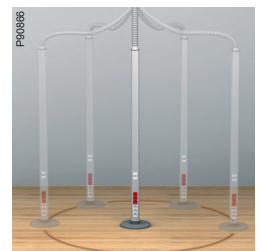

Flexibility

The movable pole has a steady foot and a flexible conduit.

- Easy to move the poles to optimize the office layout
- 1.5 m action radius.













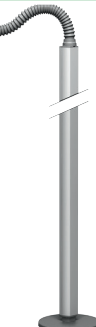

Smooth stop-end

Stop end in cast aluminium with smoothly shaped edges.

- Covers the sharp cut of the base profile
- No risk of damaged cables.

OptiLine 45 Poles & accessories Choice guide

Quantity per pack: 1								
Tension-mounted		Height mm	Anodized aluminium	Polar white				
	One-sided 	2700-3100 3100-3500 3500-3900 3900-4300	ISM20100 ISM20102 ISM20120	ISM20101P ISM20105P	ISM20810P			
	Two-sided 	2700-3100 3100-3500 3500-3900 3900-4300	ISM20106 ISM20108 ISM20110 ISM20122	ISM20107P ISM20109P ISM20111P ISM20123P		ISM20811P		
Tension-mounted with installation boxes		Height mm	Anodized aluminium	Polar white				
		2700-3100 3100-3500 3500-3900	ISM20142				ISM20554	
Free-standing		Height mm	Anodized aluminium	Polar white				
	One-sided 	2150 2450 2900	ISM20130 ISM20112	ISM20131P ISM20113P				
	Two-sided 	2150 2450 2900	ISM20132 ISM20116 ISM20118	ISM20117P				
Free-standing with installation boxes		Height mm	Anodized aluminium	Polar white				
		2150 2450 2900		ISM20147P				

			
	Foot, round	Foot, rectangular	Ceiling frame
	ISM20808	ISM20809	ISM20812P
	ISM20808	ISM20809	ISM20812P
	ISM20808	ISM20809	ISM20812P

OptiLine 45 Poles Range

Poles, empty

Type	Colour	Dimensions A/B/C (mm)	Qty per package	EAN code	Ref. No.
------	--------	-----------------------	-----------------	----------	----------

Pole, tension-mounted

Empty pole for tension mounting between floor and ceiling, one-sided or two-sided. Including front cover, ceiling fixing, ceiling frame, stop end, strain relief, partition profile, floor fixing plate, earthing kit and mounting instruction. Adjustability of ceiling fixing 400 mm. Unearthed. Supplied without service content or cables. 45 mm front opening for direct click-in of Unica 45x45 module wiring devices.

Material: Aluminium, natural anodized or powder coated white.

One-sided, 2.7-3.1 m	Anodized	3100/68/89	1	3606480029561	ISM20100
	Polar white			3606480681974	ISM20101P
One-sided, 3.1-3.5 m	Anodized	3500/68/89	1	3606480029585	ISM20102
One-sided, 3.5-3.9 m	Polar white	3900/68/89	1	3606480681998	ISM20105P
One-sided, 3.9-4.3 m	Anodized	4300/68/89	1	3606480317262	ISM20120
Two-sided, 2.7-3.1 m	Anodized	3100/116/90	1	3606480029622	ISM20106
	Polar white			3606480682001	ISM20107P
Two-sided, 3.1-3.5 m	Anodized	3500/116/90	1	3606480029646	ISM20108
	Polar white			3606480682018	ISM20109P
Two-sided, 3.5-3.9 m	Anodized	3900/116/90	1	3606480029660	ISM20110
	Polar white			3606480682025	ISM20111P
Two-sided, 3.9-4.3 m	Anodized	4300/116/90	1	3606480317286	ISM20122
	Polar white			3606480682087	ISM20123P

Pole, tension-mounted, with installation boxes

Empty pole for tension mounting between floor and ceiling, provided with four installation boxes. Installation box height 558 mm. Including white plastic front cover, ceiling fixing, ceiling frame, stop end, floor fixing, floor fixing plate (zinc), earthing cable and mounting instruction. Adjustability of ceiling fixing 400 mm. Unearthed. Supplied without service content or cables. 45 mm front opening for direct click-in of Unica 45x45 module wiring devices.

Material: Aluminium, natural anodized or powder coated white.

3.1-3.5 m	Anodized	3100-3500/149/140	1	3606480317361	ISM20142
-----------	----------	-------------------	---	---------------	----------

Pole, free-standing

Empty, free-standing and movable pole, one-sided or two-sided. Including front cover, flexible conduit with adaptor, strain relief, partition profile, earthing kit and mounting instruction. Unearthed. Supplied without service content or cables. 45 mm front opening for direct click-in of Unica 45x45 module wiring devices. Length of flexible conduit 2 m, action radius 1.5 m from the connection point in the ceiling. Foot to be ordered separately.

Material: Aluminium, natural anodized or powder coated white.

One-sided, 2.15 m	Anodized	2150+2000/68/89	1	3606480317309	ISM20130
	Polar white			3606480682094	ISM20131P
One-sided, 2.45 m	Anodized	2450+2000/68/89	1	3606480029684	ISM20112
	Polar white			3606480682032	ISM20113P
Two-sided, 2.15 m	Anodized	2150+2000/116/90	1	3606480317323	ISM20132
Two-sided, 2.45 m	Anodized	2450+2000/116/90	1	3606480029721	ISM20116
	Polar white			3606480682056	ISM20117P
Two-sided, 2.9 m	Anodized	2900+2000/116/90	1	3606480029745	ISM20118

P86538
P87199



P117511
P117512



P86536
P87201



OptiLine 45 Poles Range

Poles, empty

P117513
P117514



Type	Colour	Dimensions A/B/C (mm)	Qty per package	EAN code	Ref. No.
Pole, free-standing, with installation boxes					
Empty, free-standing and movable pole, provided with four installation boxes. Installation box height 558 mm. Including white plastic front cover, flexible conduit with adaptor, earthing cable and mounting instruction. Unearthed. Supplied without service content or cables. 45 mm front opening for direct click-in of Unica 45x45 module wiring devices. Length of flexible conduit 2 m, action radius 1.5 m from the connection point in the ceiling. Foot to be ordered separately. Material: Aluminium, natural anodized or powder coated white.					
2.15 m	Polar white	2150+2000/149/140	1	3606480682148	ISM20147P

Pre-wired Poles

P135068
P140080



One-sided Pole					
Free-standing and movable service pole, one-sided. Pre-wired, configured with 3 x double outlets, side-earthed, with cable, and 2 x Cat 6 UTP with cable. Including front cover, flexible conduit with adaptor, strain relief and mounting instruction. Length of flexible conduit 2.0 m, action radius 1.5 m from the connection point in the ceiling. Earthed. Foot to be ordered separately. External cables: one unshielded 3 x 1.5 mm ² cable with side-earthed plug, 2.0 m free length, and two Cat 6 UTP data cables with RJ45 plugs, 6.0 m free length.					
One-sided Pole	White	Aluminum	2150+2000/68/89	1	ISM22204
2 x Cat 6 UTP	Anodized	Aluminum	2150+2000/68/89	1	ISM22205
Free-standing and movable service pole, one-sided. Pre-wired, configured with 3 x double outlets, side-earthed, with cable, and 2 x Cat 6A S/FTP with cable. Including front cover, flexible conduit with adaptor, strain relief and mounting instruction. Length of flexible conduit 2.0 m, action radius 1.5 m from the connection point in the ceiling. Earthed. Foot to be ordered separately. External cables: one unshielded 3 x 1.5 mm ² cable with side-earthed plug, 2.0 m free length, and two Cat 6A S/FTP data cables with RJ45 plugs, 6.0 m free length.					
One-sided Pole	White	Aluminum	2150+2000/68/89	1	ISM22206
2 x Cat 6A S/FTP	Anodized	Aluminum	2150+2000/68/89	1	ISM22207

P140082
P135061



Two-sided Pole					
Free-standing and movable service pole, two-sided. Pre-wired, each side configured with 3 x double outlets, side-earthed, with cable, and 2 x Cat 6 UTP with cable. Including front cover, flexible conduit with adaptor, strain relief and mounting instruction. Length of flexible conduit 2.0 m, action radius 1.5 m from the connection point in the ceiling. Earthed. Foot to be ordered separately. External cables: one unshielded 3 x 1.5 mm ² cable with side-earthed plug, 2.0 m free length, and four Cat 6 UTP data cables with RJ45 plugs, 6.0 m free length.					
Two-sided Pole	White	Aluminum	2150+2000/116/90	1	ISM22208
2 x Cat 6 UTP	Anodized	Aluminum	2150+2000/116/90	1	ISM22209
Free-standing and movable service pole, two-sided. Pre-wired, each side configured with 3 x double outlets, side-earthed, with cable, and 2 x Cat 6A S/FTP with cable. Including front cover, flexible conduit with adaptor, strain relief and mounting instruction. Length of flexible conduit 2.0 m, action radius 1.5 m from the connection point in the ceiling. Earthed. Foot to be ordered separately. External cables: one unshielded 3 x 1.5 mm ² cable with side-earthed plug, 2.0 m free length, and four Cat 6A S/FTP data cables with RJ45 plugs, 6.0 m free length.					
Two-sided Pole	White	Aluminum	2150+2000/116/90	1	ISM22210
2 x Cat 6A S/FTP	Anodized	Aluminum	2150+2000/116/90	1	ISM22211

OptiLine 45 Poles Range

Pre-wired Poles



One-sided Pole

Free-standing and movable service pole, one-sided. Pre-wired, configured with 3 x double outlets, side-earthed, with cable, and two blind covers 45 x 45. Including front cover, flexible conduit with adaptor, strain relief and mounting instruction. Length of flexible conduit 2.0 m, action radius 1.5 m from the connection point in the ceiling. Earthed. Foot to be ordered separately. External cables: one unshielded 3 x 1.5 mm² cable with side-earthed plug, 2.0 m free length.

One-sided Pole	White	Aluminum	2150+2000/68/89	1	ISM22240P
	Anthracite	Aluminum	2150+2000/68/89	1	ISM22241



Two-sided Pole

Free-standing and movable service pole, two-sided. Pre-wired, each side configured with 3 x double outlets, side-earthed, with cable, and two blind covers 45 x 45. Including front cover, flexible conduit with adaptor, strain relief and mounting instruction. Length of flexible conduit 2.0 m, action radius 1.5 m from the connection point in the ceiling. Earthed. Foot to be ordered separately. External cables: one unshielded 3 x 1.5 mm² cable with side-earthed plug, 2.0 m free length.

Two-sided Pole	White	Aluminum	2150+2000/116/90	1	ISM22244P
	Anthracite	Aluminum	2150+2000/116/90	1	ISM22245







Wall-mounted Pole

Service pole intended for wall mounting. Pre-wired, configured with 3 x double outlets, side-earthed, with cable, and two blind covers 45 x 45. Including front cover, wall and floor brackets, strain relief and mounting instruction. External cables: one unshielded 3 x 1.5 mm² cable with side-earthed plug, 2.0 m free length.

Wall-mounted Pole	White	Aluminum	2700+2000/116/90	1	ISM22242P
	Anthracite	Aluminum	2700+2000/116/90	1	ISM22243



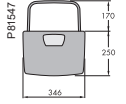

Accessories for poles

P86528		Foot for free-standing, movable pole					
		<p>Rectangular foot for free-standing, movable pole, to be fixed to the bottom plate of the pole by means of two M6 bolts (included). The foot is provided with a steel clamp that can be unfolded for extra support. When not in use, the clamp lies protected in a recess underneath the foot. Specially suited in applications close to the wall or when two poles are positioned back to back. Material: Cast iron, painted.</p>					
		Foot, rectangular	Grey	33/250/346	1	3606480030598	ISM20809
P86529		Foot for free-standing, movable poles					
		<p>Round foot for free-standing, movable poles, to be fixed to the bottom plate of the pole by means of two M6 bolts (included). Suitable both for one and two-sided poles. Material: Cast iron, painted.</p>					
		Foot, round	Grey	29/Ø317	1	3606480030581	ISM20808
P86527		Ceiling frame					
		<p>Ceiling frame intended to lead flexible conduit through false ceiling. To be mounted in circular hole, Ø125 mm, by using three included clamps. Also including a slotted plastic plate to be used to lock the flexible conduit, which is fixed by cable ties. The plate can also be used as a drill template for entrance hole Ø125 mm. Material: PC/ABS.</p>					
		Ceiling frame	Polar white	89/Ø161	1	3606480682216	ISM20812P
P86532		Ceiling frame					
		<p>Ceiling frame for one-sided or two-sided poles. Covers the edge of the hole in a false ceiling. Self-sticking. Material: PS (polystyrene).</p>					
		Ceiling frame for 1-sided pole	Polar white	1/108/129	1	3606480682193	ISM20810P
P86531		Ceiling frame					
		<p>Ceiling frame for one-sided or two-sided poles. Covers the edge of the hole in a false ceiling. Self-sticking. Material: PS (polystyrene).</p>					
		Ceiling frame for 2-sided pole	Polar white	1/156/130	1	3606480682209	ISM20811P



OptiLine 45 Poles Range

Accessories for poles

Type	Colour	Dimensions A/B/C (mm)	Qty per package	EAN code	Ref. No.
Front cover					
Front cover to be snap-fitted in service carriers with a 45 mm front opening. With earthing slots. Supplied with protective foil, in lengths of 2 m. Material: Aluminium, natural anodized or powder coated white.					
P92058 	Anodized	45/16/2000	24 m	3606480028489	ISM10950
Floor fixing with slot for floor feeder					
Floor fixing for one or two-sided pole. Fixed to the floor by screws. With slot for connection of floor feeder 18x75 mm. Material: Aluminium, powder coated.					
P87188 	Grey	38/125/102	1	3606480030703	ISM20820
P87189 	Grey	38/125/156	1	3606480030710	ISM20821
Floor feeder					
Floor feeder made up by a base part with three compartments and a cover. Supplied in lengths of 2 m. To be used for feeding along the floor to a pole provided with a slotted floor fixing for 18x75 mm floor feeder. Material: PVC.					
P86523 	Grey	18/75/2000	28 m	3606480030673	ISM20817
Floor feeder made up by a base part with three compartments and a cover. Supplied in lengths of 2 m. To be used for feeding along the floor to a pole provided with a slotted floor fixing for 18x75 mm floor feeder. Material: Aluminium, natural anodized.					
P11399 	Anodized	18/75/2000	8 m	3606480027536	ISM20857

OptiLine 45 Poles Range

Accessories for poles

Type	Colour	Dimensions A/B/C (mm)	Qty per package	EAN code	Ref. No.
Earthing clamp					
Earthing clamp to be used for bonding of front cover, base profile and accessories to earth. Material: Steel.					
Earthing clamp	—	9/9/9	20	3606480028502	ISM10952
Earthing kit					
Kit including earth wire with flat pin connectors and earthing clamps. To be used to connect the front cover to the base profile.					
Earthing kit	Yellow/green	L = 200 L = 300	10 10	3606480028519 3606480028526	ISM10953 ISM10954
Modular device adaptor					
2-module adaptor for 1-2 modular devices like for instance miniature circuit breakers. With transparent grey cover. Material: ASA+PC, white or alu metallic.					
Modular device adaptor	Alu metallic	90/72/45	1	3606480028540	ISM10957
Front locking clip					
Front locking clip to be mounted on either side of an outlet in order to secure pull-out forces. Material: PC/ABS.					
Front locking clip	Polar white	45/23/23	10	3606489604141	ISM10909P
Label holder					
Label holder for marking purposes. Package of ten. Material: PC/ABS.					
Label holder	White	23/23/45	10	3606489843021	ISM10920P
	Anthracite	23/23/45	10	3606489843038	ISM10921
	Alu metallic	23/23/45	10	3606489843045	ISM10922
	Red	23/23/45	10	3606490159319	ISM10923

Comp.	Max. Ø mm	Cross section area mm ²	Cable capacity (*) mm ²			Diagram
			40%	50%	60%	
One-sided pole						
1	41	4220	1688	2110	2532	
One-sided pole with partition profile						
1	39	1799	720	900	1079	
2	15	1106	442	553	663	
Two-sided pole without and with partition profile						
1	41	3747	1499	1874	2248	
2	16	871	348	435	523	
3	39	1799	720	900	1079	
Pole with four boxes						
1	75	13966	5586	6983	8379	
Pole profile for pole with four boxes						
2	43	2535	1014	1267	1521	

(*) We recommend a 40% utilization of the cable capacity.

OptiLine 45 Poles

Technical description

Exploded views

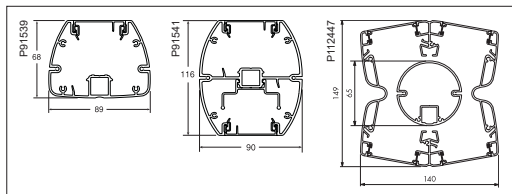
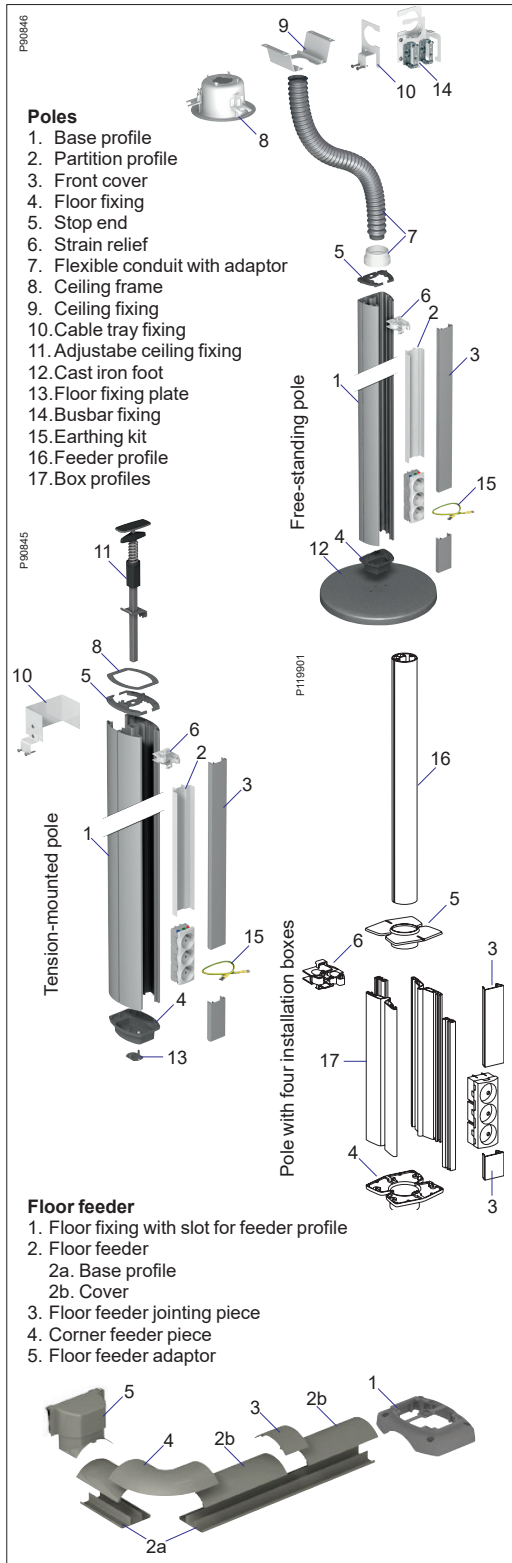

Technical and Material data

Aluminium, extruded	Specification	EN-AW-6063
	Surface treatment	Natural anodizing or powder coating
	Colour	Polar white (RAL 9003)
Aluminium, die cast	Surface treatment	Powder coating
	Colour	Grey (RAL 9007)
Cast iron	Surface treatment	Coated with clear varnish
Zinc	Surface treatment	Untreated
PC/ABS	Fire rating	UL 94 HB
	Colour	White
PS (Polystyrene)	Colour	Polar white (RAL 9003)
	Other info	Halogen-free
PVC	Colour	Grey (RAL 7030)
PC+ASA	Fire rating	UL 94 HB
	Colour	Polar white (RAL 9003)
Steel	Specification	SS 1142
	Surface treatment	Powder coating
Silicone rubber	Colour	<ul style="list-style-type: none"> • Grey • Orange • Polar white

Design and dimensions

Tension-mounted poles		A	B
		Total height	Height without ceiling fixing
P112455 Tension-mounted poles, one-sided and two-sided		Min. 2700 mm	2540 mm
		Max. 3100 mm	
		Min. 3100 mm	2940 mm
		Max. 3500 mm	
		Min. 3500 mm	3340 mm
P112456 Tension-mounted poles with four installation boxes		Max. 3900 mm	3740 mm
		Min. 3900 mm	
		Max. 4300 mm	
		Min. 4300 mm	
Tension-mounted poles with boxes			
P112455 Tension-mounted poles, one-sided and two-sided		Min. 2700 mm	2510 mm
		Max. 3100 mm	2910 mm
		Min. 3500 mm	3310 mm
P112456 Tension-mounted poles with four installation boxes		Max. 3900 mm	
		Min. 3900 mm	
		Max. 4300 mm	
Free-standing poles			
		A	B
		Total height of pole	Length of flex. conduit
P112449 Free-standing poles, one-sided and two-sided		2150 mm	2000 mm
		2450 mm	2000 mm
		2900 mm	2000 mm
P112450 Free-standing poles with one, two and four boxes		2150 mm	2000 mm
		2450 mm	2000 mm
		2900 mm	2000 mm

OptiLine 45 Posts Presentation



Service posts with 45 mm front opening for direct click-in of Unica wiring devices

OptiLine 45 service posts with a 45 mm front opening give a neat installation solution on all types of floors.

The posts have a softly rounded and compact form and are made of aluminium with a high surface finish, either natural anodised or powder coated white. They are available in one and two-sided versions.

On raised access floors and in-cavity floors the posts are fed from under the floor. On concrete floors the feeding comes from a screeded floor box. For other floors a floor feeder is available as an accessory.



Unica 45x45 module wiring devices

The OptiLine 45 range has a front opening for direct click-in of Unica 45x45 module wiring devices which gives optimal function and design.

Unica offers a broad range of socket outlets, switches, VDI outlets and electronic products such as dimmers, movement detectors, thermostats, timers.

One-sided posts

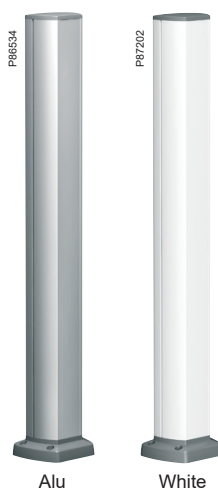

Alu

White

Two-sided posts

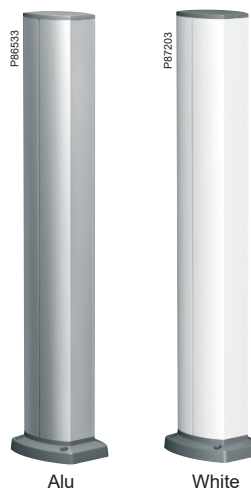

Alu

White

Two-sided posts for floor grommet

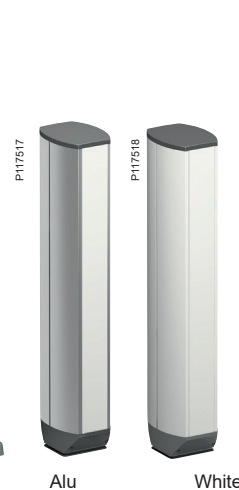

Alu

White

OptiLine 45 Posts Presentation

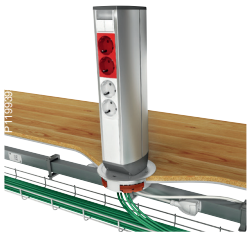

Full flexibility

For a truly flexible solution, go for our two-sided outlet post with a special fixing for the floor grommet. Canalis busbar trunking and mesh trays distribute power and networks under the floor and further up to the post through the floor grommet. The floor grommet suits any type of floor and can be installed where required. Should needs be changed, just remove the post, put the cover back, install a new grommet and move the post to where it is needed.

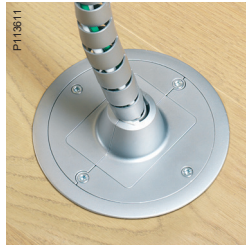

Tube adaptor

With a tube adaptor in the floor grommet you can supply power and data to a furniture box instead.



Stable and tight

When not in use the centre cover makes the floor grommet tight, withstanding both water and high loads.



Design, finish and quality

All OptiLine posts are made of aluminium, anodized or powder coated, with a high surface finish. The form is softly rounded and slender. All parts are designed to give reliable function and easy installation.

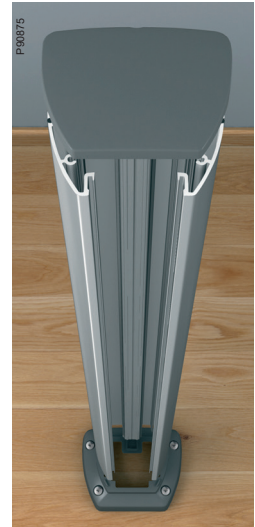

Stable and sturdy

All parts in aluminium, several are die-cast.

- Stable and sturdy design
- Reliable function
- High-quality impression



Feeding along/under the floor

Posts could be fed from the floor or along the floor

- Floor fixing for feeding from the floor as a standard
- Floor fixing with slot for floor feeder as an accessory



Feeding from trunking

The post can be fed from a wall trunking.

- Easy and fast installation
- Floor feeder adaptor with adjustable height

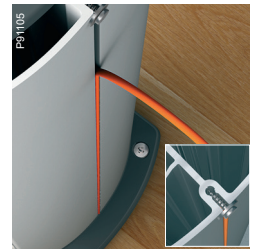

Screw slots

Slots along both sides of the post

- For decorative colour strips
- For products like hooks etc.

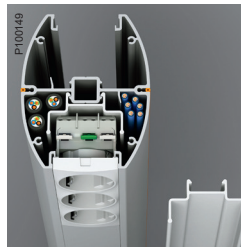

Cable separation

Partition profile for good separation of cables.

- Correct distance between VDI and power cables
- Full isolation between wiring device terminations and cables

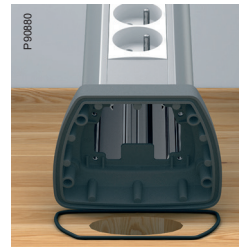

Wet sealing

The floor fixing can be provided with a gasket ring.

- Gasket ring included in the package
- Effective wet sealing
- Stable mounting also on slightly uneven floors

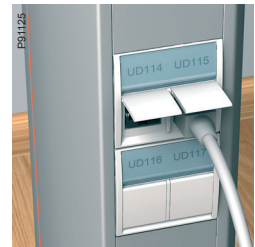







Correct user interface

Unica 45x45 modules are designed also for vertical mounting

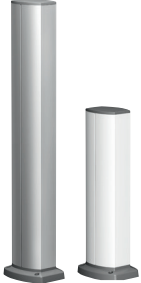





- Correct user interface
- Correct load on VDI patch cords

OptiLine 45 Posts

Choice guide

Posts					
	One-sided	Two-sided	Colour	Height mm	Ref. No.
With floor fixing 			Anodized aluminium	430	ISM20210
			Anodized aluminium	700	ISM20200
			Anodized aluminium	430	ISM20212
			Anodized aluminium Polar white	700 700	ISM20202 ISM20203P
With slotted floor fixing 			Anodized aluminium	700	ISM20207

OptiLine 45 Posts Range

Posts		Type	Colour	Dimensions A/B/C (mm)		Qty per package	EAN code	Ref. No.
		Post with floor fixing						
		Empty, free-standing, one or two-sided post mounted on a floor fixing. Including front cover, floor fixing, stop end, strain relief, partition profile, earthing kit and mounting instruction. Floor fixing provided with gasket ring. Unearthed. Supplied without service content and cables. 45 mm front opening for direct click-in of Unica 45x45 module wiring devices. Material: Aluminum, natural anodized or pow						
 	One-sided For up to six 45x45 module wiring devices	Anodized	430/68/89	1	3606480025532	ISM20210		
	One-sided For up to twelve 45x45 module wiring devices	Anodized	700/68/89	1	3606480029769	ISM20200		
	Two-sided For up to six 45x45 module wiring devices on each side	Anodized	430/116/90	1	3606480025556	ISM20212		
 	Two-sided For up to twelve 45x45 module wiring devices on each side	Anodized Polar white	700/116/90	1	3606480029783 3606480682292	ISM20202 ISM20203P		
	Post with slotted floor fixing							
		Empty, free-standing, one or two-sided post mounted on a floor fixing. Including front cover, floor fixing with slot 18x75 mm, stop end, strain relief, partition profile, earthing kit and mounting instruction. Floor fixing provided with gasket ring. Unearthed. Supplied without service content and cables. 45 mm front opening for direct click-in of Unica 45x45 module wiring devices. Material: Aluminum, natural anodized or powder coated white.						
 	Two-sided For up to twelve 45x45 module wiring devices on each side	Anodized	700/116/90	1	3606480027505	ISM20207		

OptiLine 45 Posts Range

Pre-wired Posts

P111188
P111189



Type	Colour	Material	Dimensions A/B/C (mm)	Qty per package	Ref. No.
One-sided Post					
One-sided Post mounted on a floor fixing. Pre-wired, configured with 3 x double socket outlets, side-earthed, with cable, and 2 x Cat 6 UTP with cable. Including stop end and mounting instruction. Floor fixing provided with gasket ring. Earthed. External cables: one unshielded 3 x 1.5 mm ² cable with side-earthed plug, 2.5 m free length, and two Cat 6 UTP data cables with RJ45 plugs, 9.0 m free length.					
One-sided Post	White	Aluminum	600/68/89	1	ISM22200
2 x Cat 6 UTP	Anodized	Aluminum	600/68/89	1	ISM22201
One-sided Post mounted on a floor fixing. Pre-wired, configured with 3 x double socket outlets, side-earthed, with cable, and 2 x Cat 6A S/FTP with cable. Including stop end and mounting instruction. Floor fixing provided with gasket ring. Earthed. External cables: one unshielded 3 x 1.5 mm ² cable with side-earthed plug, 2.5 m free length, and two Cat 6A S/FTP data cables with RJ45 plugs, 9.0 m free length.					
One-sided Post	White	Aluminum	600/68/89	1	ISM22202
2 x Cat 6A S/FTP	Anodized	Aluminum	600/68/89	1	ISM22203

Accessories for posts

P87188



P87189



P86523



P111399











P103324

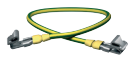

Type	Colour	Dimensions A/B/C (mm)	Qty per package	EAN code	Ref. No.
Floor fixing with slot for floor feeder					
Floor fixing for one or two-sided sided post. Fixed to the floor by screws. With slot for connection of floor feeder 18x75 mm. Material: Aluminium, powder coated.					
For one-sided post	Grey	38/125/102	1	3606480030703	ISM20820
For two-sided post	Grey	38/125/156	1	3606480030710	ISM20821
Floor feeder, PVC					
Floor feeder made up by a base part with three compartments and a cover. Supplied in lengths of 2 m. To be used for feeding along the floor to a post provided with a slotted floor fixing for 18x75 mm floor feeder. Material: PVC.					
Floor feeder	Grey	18/75/2000	28 m	3606480030673	ISM20817
Floor feeder, aluminium					
Floor feeder made up by a base part with three compartments and a cover. Supplied in lengths of 2 m. To be used for feeding along the floor to a post provided with a slotted floor fixing for 18x75 mm floor feeder. Material: Aluminium, natural anodized.					
Floor feeder	Anodized	18/75/2000	8 m	3606480027536	ISM20857
Floor grommet					
Grommet for floor applications, intended to suit a special version of the two-sided post. Including trim frame with fixing devices, two-part cover and sealing foam for protection from dust and wet floor-cleaning. The cover has the function of a water-tight blank plate when no post has been installed. When installing a post, the removed part of the cover remains in the grommet, secured by a strap. Hole diameter 127 mm. Material: Zinc, chromium plated.					
Floor grommet	—	38/Ø147	1	3606480160769	INS40550

OptiLine 45 Posts Range

Accessories for posts

Type	Colour	Dimensions A/B/C (mm)		Qty per package	EAN code	Ref. No.
Front cover						
Front cover to be snap-fitted in service carriers with a 45 mm front opening. With earthing slots. Supplied with protective foil, in lengths of 2 m. Material: Aluminium, natural anodized or powder coated white.						
Front cover	Anodized	45/16/2000		24 m	3606480028489	ISM10950
						
P92658						
Earthing clamp						
Earthing clamp to be used for bonding of front cover, base profile and accessories to earth. Material: Steel.						
Earthing clamp	—	9/9/9		20	3606480028502	ISM10952
						
P87196						
Earthing kit						
Kit including earth wire with flat pin connectors and earthing clamps. To be used to connect the front cover to the base profile.						
Earthing kit	Yellow/green	L = 200 L = 300		10 10	3606480028519 3606480038526	ISM10953 ISM10954
						
P85796						
Modular device adaptor						
2-module adaptor for 1-2 modular devices like for instance miniature circuit breakers. With transparent grey cover. Material: ASA+PC.						
Modular device adaptor	Alu metallic	90/72/45		1	3606480028540	ISM10957
						
P87195						
Front locking clip						
Front locking clip to be mounted on either side of an outlet in order to secure pull-out forces. Material: PC/ABS.						
Front locking clip	Polar white	45/23/23		10	3606489604141	ISM10909P
						
P85792						
Label holder						
Label holder for marking purposes. Package of ten. Material: PC/ABS.						
Label holder	White	23/23/45		10	3606489843021	ISM10920P
	Anthracite	23/23/45		10	3606489843038	ISM10921
	Alu metallic	23/23/45		10	3606489843045	ISM10922
	Red	23/23/45		10	3606490159319	ISM10923
P148190 P148191						
P148192 P148189						

OptiLine 45 Posts

Technical description



Technical and Material data

Aluminium, extruded	Specification	EN-AW-6063
	Surface treatment	Natural anodizing or powder coating
	Colour	Polar white (RAL 9003)
Aluminium, die cast	Surface treatment	Powder coating
	Colour	Grey (RAL 9007)
PVC	Colour	Grey (RAL 7030)
PC/ABS	Fire rating	UL 94 HB
	Colour	<ul style="list-style-type: none"> • Polar white (RAL 9003) • Aluminium metallic (painted)
PC+ASA	Fire rating	UL 94 HB
	Colour	<ul style="list-style-type: none"> • Polar white (RAL 9003) • Aluminium metallic
Steel	Specification	SS 1142
Silicone rubber	Colour	• Grey
		• Orange
		• Polar white
Degree of protection	IP30	
Temperature range	Operating temperature from -25°C to +60°C	
Standards and certificates	The products comply with the standards:	
	<ul style="list-style-type: none"> • EN 50085-1 : 2005 • NFC 68 102 (French national standard) 	
	The products satisfy the provisions for CE marking according to the Low Voltage Directive 73/23/EEC and 93/68/EEC.	

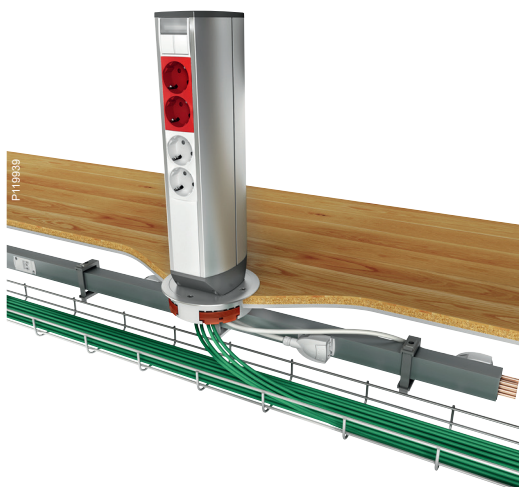

OptiLine 45 Posts

Technical description

Exploded view

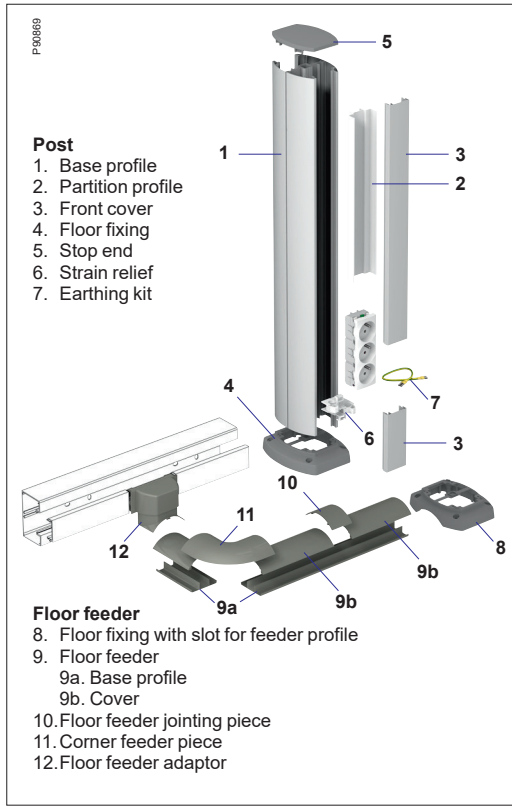

Cable capacity

Comp.	Max Ø mm	Cross section area mm ²	Cable capacity*) mm ²			
			40%	50%	60%	
One-sided post						
1	41	4220	1688	2110	2532	P86032
One-sided post with partition profile						
1	39	1799	720	900	1079	P86031
2	15	1106	442	553	663	
Two-sided post without and with partition profile						
1	41	3747	1499	1874	2248	P86033
2	16	871	348	435	523	
3	39	1799	720	900	1079	

*) We recommend a 40% utilization of the cable capacity.

Design and dimensions

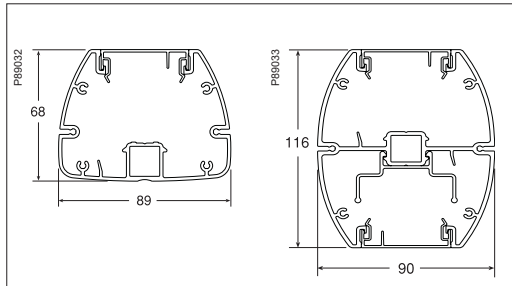

OptiLine 45 Service boxes

Presentation



Service boxes with 45 mm front opening for direct click-in of Unica wiring devices

OptiLine 45 service boxes provide flexible solutions for the supply of power, telecom and data to desks in offices and conference rooms. The basic boxes can also be used as access points in the ceiling for feeding of poles.

Three box types are included in the offer:

- A six-sided pop-up box, pre-wired with outlets, cable and plug.
- A mini pop-up box, empty for three modules, with strain relief.
- A flip-up box, empty for five modules. For flush-mounting in desks. Fixing elements, earthing cable and strain relief included.
- A turnable and smoothly rounded one-sided box. Pre-wired with outlets, cables and plugs.
- A one-sided basic box.

All boxes are made in natural anodised aluminium with a high finish. Many boxes are delivered pre-wired for easy ordering and quick installation.

The pop-up box and the turnable boxes offer unique user advantages in terms of design and accessibility.



Pop-up service box



Mini pop-up service boxes



Flip-up service boxes



Unica 45x45 module wiring devices

The OptiLine 45 range has a front opening for direct click-in of Unica 45x45 module wiring devices which gives optimal function and design.

Unica offers a broad range of socket outlets, switches, VDI outlets and electronic products such as dimmers, movement detectors, thermostats, timers.

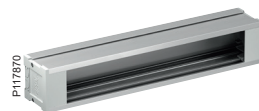

Basic service boxes



OptiLine 45 Service boxes Presentation



Flip-up and Pop-up



Pop-up
Large-capacity box, 6-sided. A light touch activates a gas-operated spring that slowly pushes the box up into working position.



Mini pop-up
A manual pop-up box with a smart membrane on top, enabling the box to be pushed down flush with the desk surface also with connected cables and plugs.

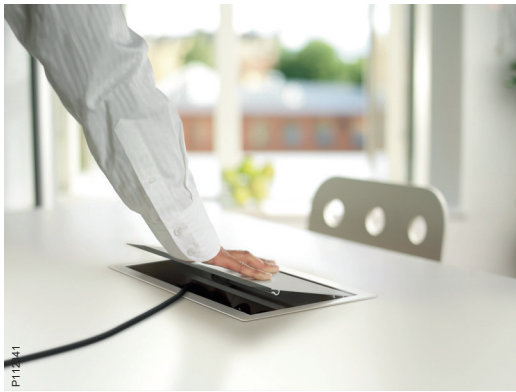

Flip-up



Flip-up
Flush-mounted box with a spring-loaded cover that is opened by a light touch. A cable basket is easily mounted under the box.



Surface mounted

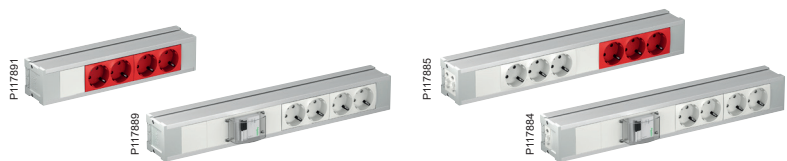

Surface mounted boxes for every need
Universal boxes with smart fixing devices. Can be fixed to a desk, to a wall or to cable trays.

OptiLine 45 Service boxes Range

Basic desk units

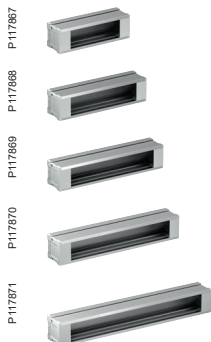

Type	Colour	Dimensions A/B/C (mm)		Qty per package	EAN code	Ref. No.
Basic desk unit, empty						
One-sided desk unit, empty. Including base profile, stop ends, earthing cable and screws. Material: Aluminium, natural anodized.						
3 modules	Anodized	60/60/195		1	3606480273865	ISM20420
4 modules	Anodized	60/60/240		1	3606480273872	ISM20421
5 modules	Anodized	60/60/285		1	3606480273889	ISM20422
6 modules	Anodized	60/60/330		1	3606480273896	ISM20423
8 modules	Anodized	60/60/420		1	3606480273902	ISM20424

OptiLine 45 Service boxes Range

Flush-mounted desk unit

P.117515



Type	Colour	Dimensions A/B/C (mm)		Qty per package	EAN code	Ref. No.
Desk unit with flip lid						
Flush-mounted desk unit provided with a flip lid. Empty, intended for 12 modules (12x22.5 mm). To be mounted in a desk-top. Fixing elements, earthing cable, strain relief and mounting instruction included. Thickness of desk-top: 10-40 mm, hole dimensions: 142x295 mm. Material: Aluminium, steel, powder coated.						
Desk unit with flip lid	Grey	105/160/305		1	3606480317507	ISM20410

Manual pop-up desk units, empty

P.117516



Pop-up desk unit, empty						
Pop-up desk unit, one-sided, manual. Including earthing cable, strain relief and mounting instruction. When inactive, the pop-up unit is flush with the desk-top. By a light pressure on the top, the unit can be lifted up from the desk surface. When not in use, it is easily pressed back to the flush position. Ordinary power and data plugs can remain in the outlets also in the flush position, since the cover is provided with a soft rubber membrane that allows the cables to exit in any direction (360°). Hole dimension: diam 100 mm. Material: Aluminium, anodized.						
Manual pop-up box, 6-module*	Anodized	252/112/-		1	3606480317484	ISM20400
Manual pop-up box, 8-module*	Anodized	297/112/-		1	3606480317491	ISM20401

* 1 module = 22.5 mm

OptiLine 45 Service boxes Range

Accessories for desk units

Type	Colour	Dimensions A/B/C (mm)		Qty per package	EAN code	Ref. No.
Ceiling cable feeder						
Cable feeder including base profile with separation wall and cover. Diameter 52 mm. For cable feeding from ceiling to work-desk. Material: Aluminium, natural anodized or powder coated white.						
Cable feeder	Anodized Polar white	3200/Ø52		1	3606480030505 3606480687112	ISM20800 ISM20801P
Round foot						
Round foot to be fixed to foot adaptor to provide a stable base to the ceiling cable feeder. Fixes to the foot adaptor by means of two M6 bolts (included). Material: Cast iron, painted.						
Foot, round	Grey	29/Ø317		1	3606480030581	ISM20808
Flexible conduit						
Flexible conduit (split tube), Ø25 mm, to be used for cable feeding from ceiling to service carrier or from floor outlet box to desk top. Cables to be laid by using dedicated mounting tool. Material: PP.						
Flexible conduit	Grey metallic	Ø25/2000		2	3606480150340	ISM50850
Ceiling frame						
Ceiling frame intended to lead flexible conduit through false ceiling. To be mounted in circular hole, Ø125 mm, by using three included clamps. Also including a slotted plastic plate to be used to lock the flexible conduit, which is fixed by cable ties. The plate can also be used as a drill template for entrance hole Ø125 mm. Material: PC/ABS.						
Ceiling frame	Polar white	89/Ø161		1	3606480682216	ISM20812P
Floor grommet						
Grommet for floor applications, intended to suit a special version of the two-sided service post. Including trim frame with fixing devices, two-part cover and sealing foam for protection from dust and wet floor-cleaning. The cover has the function of a water-tight blank plate when no service post has been installed. When installing a post, the removed part of the cover remains in the grommet, secured by a strap. Hole diameter 127 mm. Material: Zinc, chromium plated.						
Floor grommet	—	38/Ø147		1	3606480160769	INS40550
Earthing kit						
Kit including earth wire with flat pin connectors and earthing clamps. To be used to connect the front cover to the base profile.						
Earthing kit	Yellow/green	L = 200 L = 300		10 10	3606480028519 3606480028526	ISM10953 ISM10954
Earthing clamp						
Earthing clamp to be used for bonding of front cover, base profile and accessories to earth. Material: Steel.						
Earthing clamp	—	9/9/9		20	3606480028502	ISM10952
Modular device adaptor						
2-module adaptor for 1-2 modular devices like for instance miniature circuit breakers. With transparent grey cover. Material: PC+ASA, white or alu metallic.						
Modular device adaptor	Alu metallic	90/72/45		1	3606480028540	ISM10957

OptiLine 45 Service boxes

Technical description

Exploded view

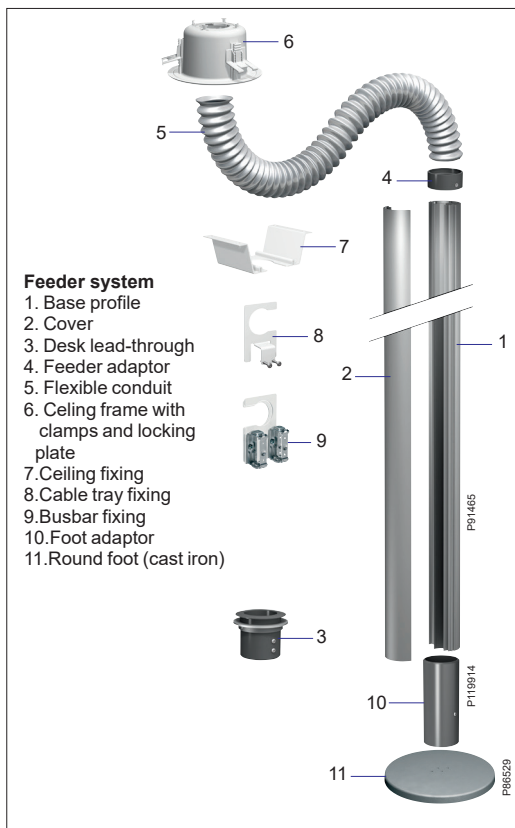

Feeder system

1. Base profile
2. Cover
3. Desk lead-through
4. Feeder adaptor
5. Flexible conduit
6. Ceiling frame with clamps and locking plate
7. Ceiling fixing
8. Cable tray fixing
9. Busbar fixing
10. Foot adaptor
11. Round foot (cast iron)

Cable capacity

Comp.	Max Ø mm	Cross section area mm ²	Cable capacity*) mm ²			
			40%	50%	60%	
Basic desk unit						
1	48	2438	975	1219	1463	P121635
Ceiling cable feeder						
1	18	640	256	320	384	P183350
2	24	1046	418	523	628	

*) We recommend a 40% utilization of the cable capacity.

Dimensions

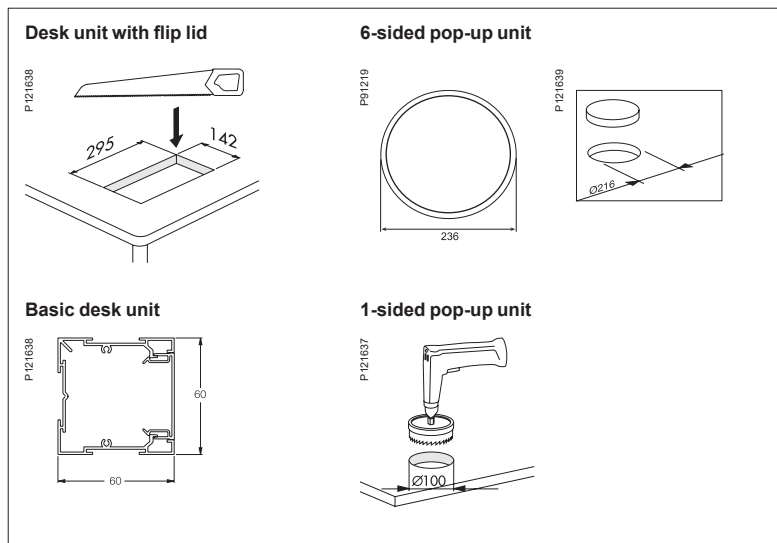

OptiLine 45 Service boxes

Technical description



Description

OptiLine 45 desk units are made of natural anodized aluminium. Three types are included in the offer;

- A basic rectangular one-sided version made up by a base profile with accessories. To be mounted on desk, cable tray or wall by means of dedicated fixings. The unit can be installed in an OptiLine 70 post by incorporating an accessory kit. Supplied in an empty version in five sizes, to be used for customer configuration. Feeder accessories comfortably bring cables from the ceiling to the box.
- A flush-mounted desk unit provided with a flip lid. To be mounted in the desk-top, intended for single user application.
- A turnable one-sided desk unit, with smoothly rounded design. The box is standing on two designed feet and can be turned around its own axis to the desired position. Supplied in different configurations with cables and plugs.
- A one-sided manual pop-up desk unit, intended for single user applications, mounted in the desk-top (office application), or in kitchen table-tops (residential application).
- A round 6-sided pop-up desk unit, supplied in different configurations. The unit is intended for mounting in for instance conference tables, where there is a need for occasional connections to power and VDI.

Benefits

- Made of natural anodized aluminium with a high finish.
- Many desk units are pre-wired for easy ordering and quick installation.
- Pop-up and turnable desk units offer unique user advantages in terms of design and accessibility.

Technical and Material data

Aluminium; desk units	Specification	EN-AW-6063
	Surface treatment	Natural anodizing
Aluminium; accessories	Specification	EN-AW-6063
	Surface treatment	Natural anodizing or powder coating
	Colours	<ul style="list-style-type: none"> • Polar white (RAL 9003) • Grey (RAL 9007)
Steel	Specification	SS 1142
	Surface treatment	Powder coating
	Colour	Aluminium metallic
PUR (polyurethane)	Density	1.2 g/cm ³
	Colour	<ul style="list-style-type: none"> • Polar white (RAL 9003) • Aluminium metallic
PC/ABS	Fire rating	UL 94 HB
	Colour	Polar white (RAL 9003)
PC+ASA	Fire rating	UL 94 HB
	Colour	<ul style="list-style-type: none"> • Polar white (RAL 9003) • Aluminium metallic

Technical and Material data, cont.

Degree of protection	IP30
Temperature range	Operating temperature from -5°C to +60°C
Standards and certificates	The products comply with the standards: <ul style="list-style-type: none"> • IEC 1084-1 (Basic desk unit only) • IEC 1084-2-4 (Basic desk unit only) • SS 424 10 32: 1989
	The products satisfy the provisions for CE marking according to the Low Voltage Directive 73/23/EEC and 93/68/EEC
	The products are approved for installation of the
Unica	range of service content
	All desk units are CE-marked



OptiLine 45

Reference number overview

100●●●●		ISM10921	16, 19, 31, 38
1003003.....	20	ISM10922	16, 19, 31, 38
1003020.....	20	ISM10923	16, 19, 31, 38
1005008.....	20	ISM10950	16, 18, 30, 38
1150002.....	20	ISM10951	16, 19
1150051.....	20	ISM10952	19, 31, 38, 45
120●●●●		ISM10953	19, 31, 38, 45
1200005.....	20	ISM10954	19, 31, 38, 45
1200401.....	20	ISM10957	19, 31, 38, 45
1220104.....	20	ISM20100	26
126●●●●		ISM20101P	26
1260170.....	20	ISM20102	26
378●●●●		ISM20105P	26
3782020.....	20	ISM20106	26
3782030.....	20	ISM20107P	26
3782420.....	20	ISM20108	26
3782430.....	20	ISM20109P	26
3782440.....	20	ISM20110	26
402●●●●		ISM20111P	26
4020210.....	20	ISM20112	26
INS●●●●●		ISM20113P	26
INS40550.....	37, 45	ISM20116	26
ISM●●●●●		ISM20117P	26
ISM10100P	14	ISM20118	26
ISM10101P	14	ISM20120	26
ISM10102P	14	ISM20121P	26
ISM10103P	15	ISM20122	26
ISM10104P	15	ISM20123P	26
ISM10105P	15	ISM20130	26
ISM10106P	15	ISM20131P	26
ISM10107P	16	ISM20132	26
ISM10110P	14	ISM20133P	26
ISM10150	17	ISM20142	26
ISM10154	18	ISM20147P	27
ISM10200P	14	ISM20200	35, 36
ISM10201P	14	ISM20202	35, 36
ISM10202P	14	ISM20203P	35, 36
ISM10203P	15	ISM20207	35, 36
ISM10204P	15	ISM20210	35, 36
ISM10205P	15	ISM20212	35, 36
ISM10206P	15	ISM20400	44
ISM10207P	16	ISM20401	44
ISM10208P	16	ISM20410	44
ISM10250	17	ISM20420	43
ISM10300P	14	ISM20421	43
ISM10301P	14	ISM20422	43
ISM10302P	14	ISM20423	43
ISM10303P	15	ISM20424	43
ISM10304P	15	ISM20800	45
ISM10305P	15	ISM20801P	45
ISM10306P	15	ISM20808	29, 45
ISM10310P	14	ISM20809	29
ISM10350	17	ISM20810P	29
ISM10351	17	ISM20811P	29
ISM10352	17	ISM20812P	29, 45
ISM10353	17	ISM20817	30, 37
ISM10354	18	ISM20820	30, 37
ISM10355	18	ISM20821	30, 37
ISM10356	18	ISM20857	30, 37
ISM10400P	14	ISM22200	37
ISM10401P	14	ISM22201	37
ISM10402P	14	ISM22202	37
ISM10404P	15	ISM22203	37
ISM10450	17	ISM22204	27
ISM10500P	14	ISM22205	27
ISM10501P	14	ISM22206	27
ISM10503P	15	ISM22207	27
ISM10504P	15	ISM22208	27
ISM10505P	15	ISM22209	27
ISM10506P	15	ISM22210	27
ISM10550	17	ISM22211	27
ISM10551	17	ISM22240P	28
ISM10554	18	ISM22241	28
ISM10900P	16	ISM22242P	28
ISM10902	16, 18	ISM22243	28
ISM10903P	16	ISM22244P	28
ISM10904	16, 19	ISM22245	28
ISM10908	16	ISM50850	45
ISM10909P	16, 19, 31, 38		
ISM10920P	16, 19, 31, 38		

OptiLine 45

Notes

OptiLine 45

Notes

OptiLine 45

Notes

Life Is On

Schneider
Electric

Schneider Electric Industries SAS

35, rue Joseph Monier
CS 30323
92506 Rueil Malmaison Cedex
France

RCS Nanterre 954 503 439
Capital social 896 313 776 €
www.schneider-electric.com

05-2024

© 2024 - Schneider Electric. All Rights Reserved.
All trademarks are owned by Schneider Electric Industries SAS or its affiliated companies.
ISC00942_OptiLine 45

This document has been
printed on recycled paper

