

PowerLogic™ PM5500 / PM5600 / PM5700 series

User manual

HRB1684301-16
12/2023



Legal Information

The information provided in this document contains general descriptions, technical characteristics and/or recommendations related to products/solutions.

This document is not intended as a substitute for a detailed study or operational and site-specific development or schematic plan. It is not to be used for determining suitability or reliability of the products/solutions for specific user applications. It is the duty of any such user to perform or have any professional expert of its choice (integrator, specifier or the like) perform the appropriate and comprehensive risk analysis, evaluation and testing of the products/solutions with respect to the relevant specific application or use thereof.

The Schneider Electric brand and any trademarks of Schneider Electric SE and its subsidiaries referred to in this document are the property of Schneider Electric SE or its subsidiaries. All other brands may be trademarks of their respective owner.

This document and its content are protected under applicable copyright laws and provided for informative use only. No part of this document may be reproduced or transmitted in any form or by any means (electronic, mechanical, photocopying, recording, or otherwise), for any purpose, without the prior written permission of Schneider Electric.

Schneider Electric does not grant any right or license for commercial use of the document or its content, except for a non-exclusive and personal license to consult it on an "as is" basis.

Schneider Electric reserves the right to make changes or updates with respect to or in the content of this document or the format thereof, at any time without notice.

To the extent permitted by applicable law, no responsibility or liability is assumed by Schneider Electric and its subsidiaries for any errors or omissions in the informational content of this document, as well as any non-intended use or misuse of the content thereof.

Safety information

Important information

Read these instructions carefully and look at the equipment to become familiar with the device before trying to install, operate, service, or maintain it. The following special messages may appear throughout this manual or on the equipment to warn of potential hazards or to call attention to information that clarifies or simplifies a procedure.



The addition of either symbol to a “Danger” or “Warning” safety label indicates that an electrical hazard exists which will result in personal injury if the instructions are not followed.



This is the safety alert symbol. It is used to alert you to potential personal injury hazards. Obey all safety messages that accompany this symbol to avoid possible injury or death.

DANGER

DANGER indicates a hazardous situation which, if not avoided, **will result in** death or serious injury.

Failure to follow these instructions will result in death or serious injury.

WARNING

WARNING indicates a hazardous situation which, if not avoided, **could result in** death or serious injury.

CAUTION

CAUTION indicates a hazardous situation which, if not avoided, **could result in** minor or moderate injury.

NOTICE



NOTICE is used to address practices not related to physical injury.

Please note

Electrical equipment should be installed, operated, serviced and maintained in restricted access locations only by qualified personnel. No responsibility is assumed by Schneider Electric for any consequences arising out of the use of this equipment. A qualified person is one who has skills and knowledge related to the construction, installation, and operation of electrical equipment and has received safety training to recognize and avoid the hazards involved.

Metering equipment symbols

The following IEC 60417 and ISO 7000 symbols may be used on the metering equipment:

Symbol	Reference	Description
	IEC 60417-5172	Protective class II equipment To identify equipment meeting the safety requirements specified for Class II equipment (double or reinforced insulation).
	ISO 7000-0434B	Caution To indicate that caution is necessary when operating the device or control close to where the symbol is placed. To indicate that the current situation needs operator awareness or operator action in order to avoid undesirable consequences.
	ISO 7000-1641	Operator's manual; operating instructions To identify the location where the operator's manual is stored or to identify information that relates to the operating instructions. To indicate operating instructions should be considered when operating the device or operating controls close to where the symbol is placed.

Notices

FCC

This equipment has been tested and found to comply with the limits for a Class B digital device, pursuant to part 15 of the FCC rules. These limits are designed to provide reasonable protection against harmful interference in a residential installation. This equipment generates, uses, and can radiate radio frequency energy and, if not installed and used in accordance with the instructions, may cause harmful interference to radio communications. However, there is no guarantee that the interference will not occur in a particular installation. If this equipment does cause harmful interference to radio or television reception, which can be determined by turning the equipment off and on, the user is encouraged to try to correct the interference by one or more of the following measures:

- Reorient or relocate the receiving antenna.
- Increase the separation between the equipment and receiver.
- Connect the equipment to an outlet on a circuit different from that to which the receiver is connected.
- Consult the dealer or an experienced radio/TV technician for help.

The user is cautioned that any changes or modifications not expressly approved by Schneider Electric could void the user's authority to operate the equipment.

This digital apparatus complies with CAN ICES-3 (B) /NMB-3(B).

About this manual

This manual discusses features of the PowerLogic™ PM5500 / PM5600 / PM5700 series power meter and provides installation and configuration instructions.

Throughout the manual, the term “meter” refers to all models of the PM5500 / PM5600 / PM5700. All differences between the models, such as a feature specific to one model, are indicated with the appropriate model number or description.

This manual assumes you have an understanding of power metering and are familiar with the equipment and power system in which your meter is installed.

This manual does not provide configuration information for advanced features where an expert user would perform advanced configuration. It also does not include instructions on how to incorporate meter data or perform meter configuration using energy management systems or software, other than ION Setup. ION Setup is a free configuration tool available for download from www.se.com.

The most up-to-date documentation about your meter is available for download from www.se.com. Scan the book QR code below to access documentation related to the PowerLogic™ PM5500 / PM5600 / PM5700 series meters.

Related documents

Document	Number
PowerLogic™ PM5560 / PM5580 / PM5650 instruction sheet	GDE41422
PowerLogic™ PM5561 instruction sheet	HRB14028
PowerLogic™ PM5562 / PM5562MC instruction sheet	NVE52959
PowerLogic™ PM5563 instruction sheet	EAV91010
PowerLogic™ PM5RD instruction sheet	EAV90213
PowerLogic™ PM5570 / PM5570L instruction sheet	MFR70032
PowerLogic™ PM5660 / PM5661 / PM5760 / PM5761 / PM5660L / PM5760L instruction sheet	MFR70030

Table of Contents

Safety precautions	15
Meter overview	17
Overview of meter features	17
Your meter in an energy management system	18
PM5500 / PM5600 / PM5700 meter models and accessories	19
Features differentiation matrix for PM5500 / PM5600 / PM5700 series	20
Data display and analysis tools	21
Power Monitoring Expert	21
Power SCADA Operation	22
Building Operation	22
Modbus command interface	22
Meter Insights and QR code-enabled meters	22
Meter configuration	23
Hardware reference	24
Supplemental information	24
Meter description	24
Alarm / energy pulsing LED	25
Heartbeat / serial communications LED	25
Ethernet communications LEDs	25
Revenue lock LED	26
Terminal covers	26
Removing the PM5563 from the DIN rail	26
Meter wiring considerations	27
Direct connect voltage limits	27
Balanced system considerations	29
Neutral and ground current	29
Control power (auxiliary power)	30
Communications connections	30
RS-485 wiring	30
Ethernet communications connections	31
Digital outputs	31
Digital inputs	31
Analog inputs	32
Display	33
Display overview	33
Default data display screen	33
Notification icons	34
Meter display language	34
Resetting the display language	34
Meter screen navigation	34
Navigation symbols	35
Meter screen menus overview	35
Menu tree	36
Data display screens	36
HMI setup screens	40
Setting up the display	41

Setting up the average voltage (Vavg) on the summary page using the display	41
Basic setup	43
Configuring basic setup parameters using the display	43
Configuring advanced setup parameters using the display	45
Setting up regional settings	45
Resetting the display language	46
Setting up the screen passcodes	46
PM5RD device hardware version Ax/Bx support for PM5563 and PM5563RD meter models	47
Configuring PM5563 meter for PM5RD device hardware version	48
Configuring toroid settings for RCM using the display	49
Cybersecurity	50
Cybersecurity overview	50
Product defense-in-depth	50
Device security capabilities	51
Protected environment assumptions	51
Potential risks and compensating controls	52
Data encryption	53
Default settings	53
User accounts and permissions	54
User account lockout policy	54
Passwords/Passcodes	54
Default passwords/passcodes and user accounts	55
Changing passwords/passcodes	55
Harden the device	56
Enabling/Disabling communication protocols and changing port numbers	56
Reporting a security incident or vulnerability	58
Firmware upgrades	58
Secure disposal guidelines	58
Secure disposal checklist	58
Disposal, reuse, recycling	58
Webpages	60
Webpages (Legacy)	60
Applicability	60
Webpages overview	60
Webpages interface	60
Accessing the meter webpages	61
Default webpages	61
Setting the measurement range for basic parameters	62
User accounts	63
Reading device registers using the webpages	64
Webpages (New)	64
Applicability	64
Webpages overview	65
Webpages interface	65
Accessing the meter webpages	66
Default webpages	66
User accounts	69

Reading device registers using the webpages	72
Communications	73
Ethernet communications	73
Ethernet configuration	73
Serial communications	80
RS-485 network configuration	80
BACnet/IP	83
Supported BACnet features	84
BACnet/IP communications implementation	85
Configuring BACnet/IP settings using the display	85
Configuring BACnet/IP settings using the webpages	86
BACnet objects	87
EtherNet/IP	96
Cyclical Exchanges (Implicit Exchanges)	97
Messaging (Explicit Exchanges)	99
DNP3	112
DNP3 device profile	113
DNP3 implementation objects	115
Default DNP3 configuration	116
Configuring DNP3 setting using the display	117
Configuring DNP3 setting using the webpages	118
Modbus Ethernet gateway	118
Ethernet gateway implementation	118
Ethernet gateway configuration	119
Modbus TCP/IP filtering	121
Modbus TCP/IP filtering implementation	121
Access levels	121
Configuring Modbus TCP/IP filtering using the webpages	122
Simple Network Management Protocol (SNMP)	122
The meter in an SNMP system	123
SNMP implementation	123
SNMP trapping	124
Configuring SNMP using the webpages	125
FTP	126
FTP file structure	126
FTP file permissions	127
FTP filename requirements	127
Enabling and disabling the FTP server using the display	127
Enabling and disabling the FTP server using the webpages	128
Time and timekeeping	129
Setting the clock using the display	129
Setting the meter's clock manually using the webpages	129
Configuring time and time synchronization using the webpages	130
Logging	131
Data log	131
Setting up the data log	131
Saving the data log contents using ION Setup	131
Setting up device log exports using the webpages	132
Alarm log	133
Maintenance log	133

Inputs / outputs	134
I/O overview	134
Digital input applications	134
Digital input wiring considerations	134
WAGES monitoring	134
Configuring digital inputs using ION Setup	135
Configuring digital inputs using the display	136
Input metering	137
Configuring input metering using ION Setup	137
Configuring input metering using the display	138
Demand measurements for input metering	139
Viewing input metering data through the meter's display	140
Digital output applications	140
Digital output application example	140
Configuring digital outputs using ION Setup	140
Configuring digital outputs using the display	141
Energy pulsing	142
Configuring the alarm / energy pulsing LED using the display	143
Configuring the alarm / energy pulsing LED or digital output for energy pulsing using ION Setup	143
Analog inputs	144
Configuring analog inputs using the display	144
Resets	148
Meter resets	148
Meter Initialization	148
Performing global resets using the display	148
Performing single resets using the display	149
Performing user account resets using the display	150
Alarms	151
Alarms overview	151
Alarm types	151
Unary alarms	151
Available unary alarms	151
Digital alarms	152
Available digital alarms	152
Standard alarms	152
Example of over and under setpoint (standard) alarm operation	153
Maximum allowable setpoint	154
Available standard alarms	155
Power factor (PF) alarms	156
Phase loss alarm	157
Logic alarms	158
Custom alarms	158
Custom alarm parameter list	158
Disturbance (sag/swell) alarms	159
Alarm priorities	160
Alarm setup overview	160
Setting up alarms using the display	161
Setting up alarms using ION Setup	161
Unary alarm setup parameters	161
Digital alarm setup parameters	162

Standard (1-Sec) alarm setup parameters	162
Setting up logic alarms using ION Setup	163
Setting up custom alarms using ION Setup	164
Setting up disturbance alarms using display	165
LED alarm indicator	165
Configuring the LED for alarms using the display	166
Configuring the LED for alarms using ION Setup	166
Alarm display and notification	166
Email on alarm	167
Implementation and default configuration	168
Email on alarm examples	168
Configuring the email on alarm feature using the webpages	170
Active alarms list and alarm history log	171
Viewing active alarm details using the display	171
Viewing alarm history details using the display	172
Viewing alarms counters using the display	172
Acknowledging high-priority alarms using the display	172
Resetting alarms using ION Setup	172
Multi-tariffs	174
Multi-tariff	174
Multi-tariff implementation	174
Command mode overview	174
Time of day mode overview	175
Time of day mode tariff validity	175
Time of day tariff creation methods	175
Input mode overview	176
Digital input assignment for input control mode	176
Tariff setup	178
Configuring input mode tariffs using the display	179
Measurements	180
Instantaneous measurements	180
Residual current	180
Energy measurements	181
Configuring the energy scaling using ION Setup	181
Preset energy	182
Configuring the preset energy using ION Setup	182
Min/max values	183
Demand measurements	183
Power demand	183
Current demand	186
Predicted demand	186
Peak demand	186
Input Metering Demand	187
Setting up demand calculations using the display	187
Power and power factor	188
Current phase shift from voltage	189
Real, reactive and apparent power (PQS)	189
Power factor (PF)	190
Power factor sign convention	190
Power factor register format	191
Timers	193

Power quality	194
Power quality measurements	194
Harmonics overview	194
Voltage crest factor	194
K-factor.....	195
Total harmonic distortion %.....	195
Total demand distortion	195
Harmonic content calculations	195
THD% calculations	195
thd calculations	196
TDD calculations	196
Viewing harmonics using the display	196
Viewing TDD, K-factor and Crest factor data	197
Viewing THD/thd using the display	198
Waveform capture	198
Overview of waveform capture	198
Configuring waveform capture using ION Setup	199
Configuring waveform capture using the display	200
Configuring sag/swell using ION Setup	201
Configuring sag/swell using the display.....	202
Monitoring waveform capture on meter's webpages	202
Maintenance	205
Maintenance overview	205
Lost user access	205
Diagnostics information.....	205
Control power (auxiliary power) interruption event	205
Acknowledging control power (auxiliary power) interruption event using the display	206
Wrench icon	206
LED indicators.....	207
Phasors	207
Phasor screens.....	207
Meter memory	208
Meter battery	208
Firmware version, model and serial number.....	208
Firmware upgrades.....	209
Firmware upgrade methods	210
Technical assistance	215
Verifying accuracy	216
Overview of meter accuracy	216
Accuracy test requirements	216
Energy pulsing.....	217
Meter settings for accuracy testing	217
Verifying accuracy test	217
Required pulses calculation for accuracy verification testing.....	219
Total power calculation for accuracy verification testing.....	219
Percentage error calculation for accuracy verification testing.....	219
Accuracy verification test points	220
Energy pulsing considerations	220
VT and CT considerations.....	221
Example calculations	221

Typical sources of test errors	222
Revenue	223
Revenue metering overview	223
Revenue metering components	223
Revenue firmware security features	223
Protected setup parameters and functions	224
Revenue-locking summary	225
Revenue locking	225
Locking or unlocking the PM5561 / PM5661 / PM5761	225
Revenue lock switch	226
Locking and unlocking your meter using the hardware switch	226
Device specifications	228
Restoration of temporarily disabled configuration settings in webpages	235
China Standard Compliance	236

Safety precautions

Installation, wiring, testing and service must be performed in accordance with all local and national electrical codes.

DANGER

HAZARD OF ELECTRIC SHOCK, EXPLOSION, OR ARC FLASH

- Apply appropriate Personal Protective Equipment (PPE) and follow safe electrical work practices. See NFPA 70E, CSA Z462 or other local standards.
- Turn off all power supplying this device and the equipment in which it is installed before working on or in the equipment.
- Always use a properly rated voltage sensing device to confirm that all power is off.
- Follow guidelines in the Wiring section of the related Installation Sheet.
- Assume communications and I/O wiring are hazardous live until determined otherwise.
- Do not exceed the maximum ratings of this device.
- Do not short secondary terminals of Voltage Transformer (VT).
- Do not open secondary terminals of Current Transformer (CT).
- Ground secondary circuit of CTs.
- Do not use the data from the meter to confirm power is off.
- Replace all devices, doors and covers before turning on power to this equipment.
- Do not install CTs or LPCTs in equipment where they exceed 75% of the wiring space of any cross-sectional area in the equipment.
- Do not install CTs or LPCTs in areas where ventilation openings may be blocked or in areas of breaker arc venting.
- Secure CT or LPCT secondary conductors to ensure they do not contact live circuits.
- Do not use water or any liquid material to clean the product. Use a cleaning cloth to remove dirt. If dirt cannot be removed, contact local Technical Support representative.
- The installer is responsible for coordinating the rating and the characteristics of the supply side over current protection devices with the maximum current rating.

Failure to follow these instructions will result in death or serious injury.

NOTE: See IEC 60950-1 for more information on communications and I/O wiring connected to multiple devices.

WARNING

UNINTENDED OPERATION

- Do not use this device for critical control or protection of persons, animals, property or equipment.
- Do not use this device if a wrench icon  appears on the top left corner of the display screen or if the value under **Meter Status** is not "OK".

Failure to follow these instructions can result in death, serious injury, or equipment damage.

▲ WARNING**POTENTIAL COMPROMISE OF SYSTEM AVAILABILITY, INTEGRITY, AND CONFIDENTIALITY**

- Change default passwords/passcodes to help prevent unauthorized access to device settings and information.
- Disable unused ports/services and default accounts, where possible, to minimize pathways for malicious attacks.
- Place networked devices behind multiple layers of cyber defenses (such as firewalls, network segmentation, and network intrusion detection and protection).
- Use cybersecurity best practices (for example: least privilege, separation of duties) to help prevent unauthorized exposure, loss, modification of data and logs, interruption of services, or unintended operation.

Failure to follow these instructions can result in death, serious injury, or equipment damage.

Meter overview

Overview of meter features

The PowerLogic™ PM5500 / PM5600 / PM5700 power meters offer value for the demanding needs of your energy monitoring and cost management applications.

The PM5500 / PM5600 / PM5700 complies to Class 0.2S accuracy standards and feature high quality, reliability and affordability in a compact and easy to install format.

NOTE: Not all features are available on all models.

Hardware

- A fourth current input for direct and accurate measurement of neutral current, to help avoid device overload and network outage.
- Two digital outputs for control and energy pulsing applications.
- Four digital inputs/two digital inputs with input metering support for WAGES monitoring applications.
- LED that can be used for energy pulsing applications.

Applicable for specific meter models:

- Two Residual Current Measurement (RCM) inputs.
- Two analog inputs to interpret an incoming analog current signal from transducers and provide the resulting scaled value.
- Low-voltage DC control power.

Display and user interface

- Onboard webpages for displaying real-time, logged data and waveform capture information using a web browser.
- Multiple language support: The back-lit anti-glare display screen can be switched to display meter information in one of the supported languages (on models with a display screen).
- Graphical display of harmonics and phasor diagrams on models with an integrated or optional remote display.
- QR codes with embedded data for viewing meter information using Meter Insights.

Alarming

- Extensive alarming options like unary, digital, standard, logic, custom, and disturbance alarms.
- The ability to send emails with alarm information.

Communications

- Dual Ethernet switched ports allow fast Ethernet interconnection to other PM5500 / PM5600 / PM5700 meters using only one IP switch.
- Ethernet gateway functionality, allowing a Modbus master using Modbus TCP to communicate through the meter to downstream serial devices using Modbus RTU.

- Support for a variety of Ethernet protocols, such as Modbus TCP, BACnet/IP, EtherNet/IP and DNP3. All the Ethernet protocols can be used at the same time.
- Enhanced Modbus security using TCP/IP filtering to set the specific IP addresses that are permitted to access the meter.

Measurements and logging

- 4-quadrant, Class 0.2S accurate energy metering.
- Present, last, predicted and peak (maximum) demand using a selection of demand calculation methods.
- Highly accurate 1-second measurements.
- Onboard data logging support for up to 14 selectable parameters.
- Complete harmonic distortion metering, recording and realtime reporting, up to the 63rd harmonic for all voltage and current inputs.
- Recording of each new minimum and new maximum value.

Revenue and tariffs

- Multiple tariff support (8 tariffs) for monitoring energy usage.
- Models with features to help you comply with revenue and billing standards.

Compliance to international standards

- IEC 62053-22: 2020, BS/ EN 62053-22 Class 0.5S / Class 0.2S
- ANSI C12.20 Class 0.2
- IEC 61557-12: 2021, BS/ EN 61557-12 PMD/S/K70/0.2
- IEC 62053-23: 2020, BS/ EN 62053-23
- IEC 62052-11: 2020, BS/ EN 62052-11
- IEC 62052-31: 2015, BS/ EN 62052-31
- MID/MIR, BS/ EN 50470-1; BS/ EN 50470-3 – Annex B and Annex D
- CE and cULus as per BS/ EN/ IEC/ UL 61010-1: 2010 + A1: 2019
- BACnet/IP - BTL listed (B-ASC)
- EtherNet/IP - ODVA certified

Your meter in an energy management system

You can use the meter as a stand-alone device, but its extensive capabilities are fully realized when used as part of an energy management system.

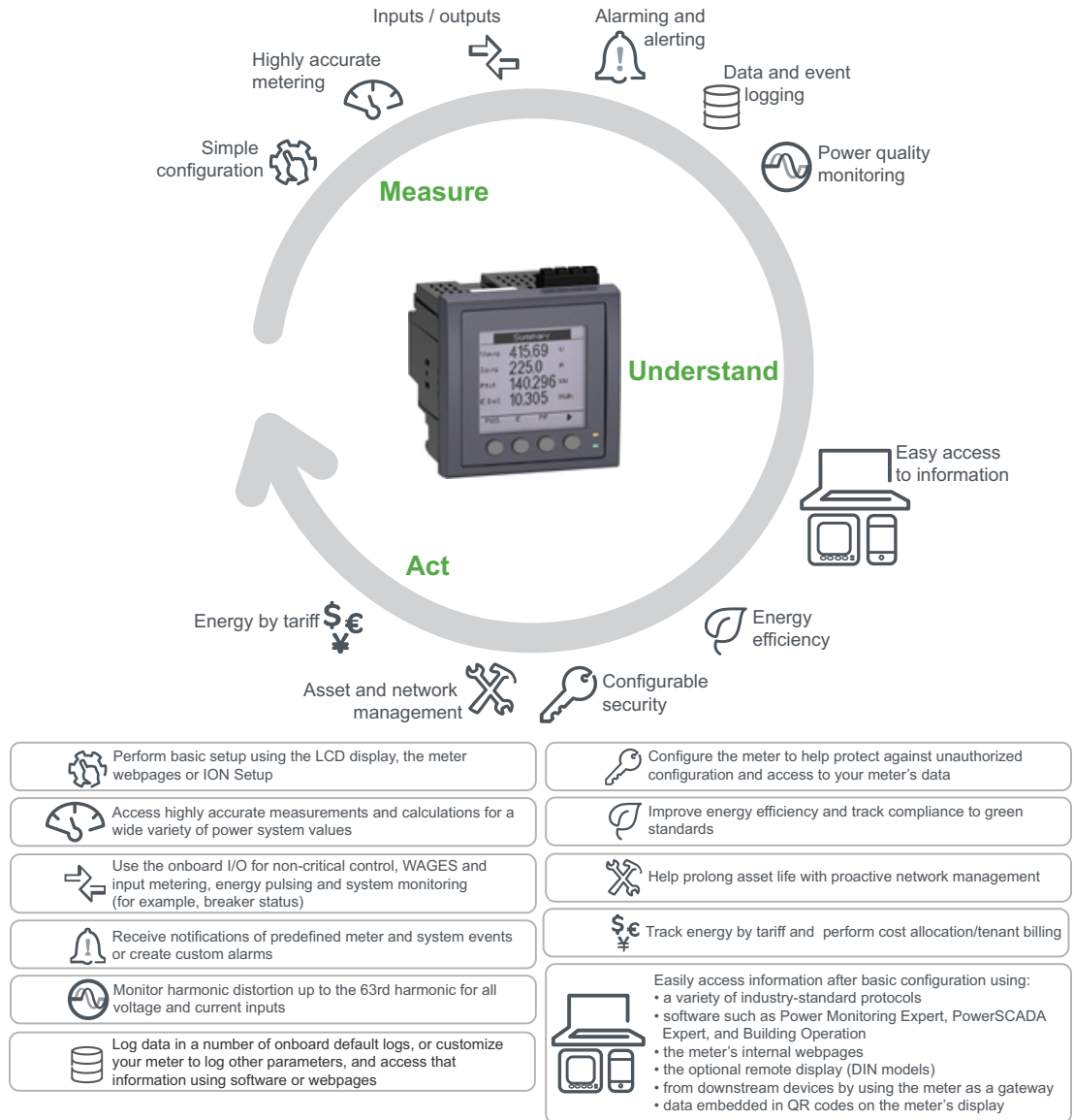

PM5500 / PM5600 / PM5700 meter models and accessories

The meter is available in several different models with optional accessories that provide various mounting options.

Meter models

Model	Commercial reference	Description
PM5560	METSEPM5560	Front panel mount, integrated display, 96 x 96 mm form factor, fits in a 1/4 DIN mounting hole.
PM5561	METSEPM5561	Same as PM5560, except the meter is calibrated to comply to strict MID/MIR standards.
PM5562	METSEPM5562	Same as PM5560 with the addition of a sealable hardware lock which prevents modification of revenue related settings and functions.
PM5562MC	METSEPM5562MC	Same as PM5562, except that it is sealed at the factory.
PM5563	METSEPM5563	Transducer (TRAN) model, no display, mounts on a standard TS35 top hat style DIN rail.
PM5563RD	METSEPM5563RD	Same as PM5563, except that it is package with a remote display (PM5RD).

Model	Commercial reference	Description
PM5650	METSEPM5650	Same as PM5560 with the addition of sag/swell detection and waveform capture.
PM5580	METSEPM5580	Same as PM5560, except for 20 – 60 V DC control power (LVDC).
PM5570	METSEPM5570	Front panel mount, integrated display, 96 x 96 mm form factor, fits in a 1/4 DIN mounting hole with two digital inputs and two analog inputs.
PM5660	METSEPM5660	Front panel mount, integrated display, 96 x 96 mm form factor, fits in a 1/4 DIN mounting hole with two digital inputs and two RCM inputs.
PM5661	METSEPM5661	Same as PM5660, except the meter is calibrated to comply to strict MID/MIR standards.
PM5760	METSEPM5760	Same as PM5660 with the addition of sag/swell detection and waveform capture.
PM5761	METSEPM5761	Same as PM5760, except the meter is calibrated to comply to strict MID/MIR standards.
PM5570L	METSEPM5570L	Same as PM5570, except for 20 – 60 V DC control power (LVDC).
PM5660L	METSEPM5660L	Same as PM5660, except for 20 – 60 V DC control power (LVDC).
PM5760L	METSEPM5760L	Same as PM5760, except for 20 – 60 V DC control power (LVDC).

Meter accessories

Model	Commercial reference	Description
PM5RD	METSEPM5RD	The remote meter display can be used with DIN meters. It has the same buttons, icons and LEDs as the display on an integrated meter, and is powered by the connection to the DIN meter. NOTE: A remote display cannot be used with meters that have an integrated display.

See the PM5500 / PM5600 / PM5700 catalog pages, available from www.se.com, or consult your local Schneider Electric representative for information about mounting adapters available for your meter.

Features differentiation matrix for PM5500 / PM5600 / PM5700 series

NOTE: Features which are not listed is common across all meter models.

Feature	PM5560	PM5561	PM5562 PM5562MC	PM5563 PM5563RD	PM5650	PM5580
100 – 480 V AC; 125 – 250 V DC control power	✓	✓	✓	✓	✓	–
20 – 60 V DC control power	–	–	–	–	–	✓
Digital inputs	4 (S1 to S4)	4 (S1 to S4)	4 (S1 to S4)	4 (S1 to S4)	4 (S1 to S4)	4 (S1 to S4)
RCM inputs	–	–	–	–	–	–
Analog inputs 4 – 20 mA	–	–	–	–	–	–
Digital outputs	2 (D1 & D2)	2 (D1 & D2)	2 (D1 & D2)	2 (D1 & D2)	2 (D1 & D2)	2 (D1 & D2)
DNP3 over Ethernet	✓	✓	–	✓	✓	✓
Sag/Swell detection	–	–	–	–	✓	–

Feature	PM5560	PM5561	PM5562 PM5562MC	PM5563 PM5563RD	PM5650	PM5580
Waveform capture	–	–	–	–	✓	–
Digital alarm	4	4	4	4	4	4
Standard alarm	29	29	29	29	29	29
Disturbance alarm	–	–	–	–	2	–
MID/MIR	–	✓	–	–	–	–

Feature	PM5570	PM5570L	PM5660	PM5660L	PM5661	PM5760	PM5760L	PM5761
100 – 480 V AC; 125 – 250 V DC control power	✓	–	✓	–	✓	✓	–	✓
20 – 60 V DC control power	–	✓	–	✓	–	–	✓	–
Digital inputs	2 (S1 & S2)	2 (S1 & S2)	2 (S1 & S2)	2 (S1 & S2)	2 (S1 & S2)	2 (S1 & S2)	2 (S1 & S2)	2 (S1 & S2)
RCM inputs	–	–	2 (I5 & I6)	2 (I5 & I6)	2 (I5 & I6)	2 (I5 & I6)	2 (I5 & I6)	2 (I5 & I6)
Analog inputs 4 – 20 mA	2 (A1 & A2)	2 (A1 & A2)	–	–	–	–	–	–
Digital outputs	2 (D1 & D2)	2 (D1 & D2)	2 (D1 & D2)	2 (D1 & D2)	2 (D1 & D2)	2 (D1 & D2)	2 (D1 & D2)	2 (D1 & D2)
DNP3 over Ethernet	✓	✓	✓	✓	✓	✓	✓	✓
Sag/Swell detection	–	–	–	–	–	✓	✓	✓
Waveform capture	–	–	–	–	–	✓	✓	✓
Digital alarm	2	2	2	2	2	2	2	2
Standard alarm	29	29	33	33	33	33	33	33
Disturbance alarm	–	–	–	–	–	2	2	2
MID/MIR	–	–	–	–	✓	–	–	✓

Data display and analysis tools

Power Monitoring Expert

EcoStruxure™ Power Monitoring Expert is a complete supervisory software package for power management applications.

The software collects and organizes data gathered from your facility's electrical network and presents it as meaningful, actionable information via an intuitive web interface.

Power Monitoring Expert communicates with devices on the network to provide:

- Real-time monitoring through a multi-user web portal
- Trend graphing and aggregation
- Power quality analysis and compliance monitoring
- Preconfigured and custom reporting

See the EcoStruxure™ Power Monitoring Expert online help for instructions on how to add your device into its system for data collection and analysis.

Power SCADA Operation

EcoStruxure™ Power SCADA Operation is a complete real-time monitoring and control solution for large facility and critical infrastructure operations.

It communicates with your device for data acquisition and real-time control. You can use Power SCADA Operation for:

- System supervision
- Real-time and historical trending, event logging
- Real-time and historical trending, event logging and waveform capture
- PC-based custom alarms

See the EcoStruxure™ Power SCADA Operation online help for instructions on how to add your device into its system for data collection and analysis.

Building Operation

Struxtureware™ Building Operation is a complete software solution for integrated monitoring, control, and management of energy, lighting, fire safety, and HVAC.

It natively supports the major communication standards in building automation and security management, including TCP/IP, LonWorks, BACnet, Modbus and Ethernet.

Modbus command interface

Most of the meter's real-time and logged data, as well as basic configuration and setup of meter features, can be accessed and programmed using a Modbus command interface as published in the meter's Modbus register list.

This is an advanced procedure that should only be performed by users with advanced knowledge of Modbus, their meter, and the power system being monitored. For further information on the Modbus command interface, contact Technical Support.

See your meter's Modbus register list at www.se.com for the Modbus mapping information and basic instructions on command interface.

Meter Insights and QR code-enabled meters

The QR code feature allows you to view meter data using the Meter Insights website by scanning a QR code on the meter's display.

The meter dynamically generates the selected QR code when you navigate to the appropriate screen. The data embedded in the QR code is displayed in Meter Insights using the web browser on your smartphone or tablet.

You can register with Meter Insights to store the results of your scans, which allows you to view:

- Detailed energy usage patterns
- Trends in energy consumption
- Alarms for possible issues

Meter Insights also displays notifications of possible issues or improvements you can make to the meter's configuration or your electrical network. Plus you can share information with colleagues and run reports on stored data.

See the *Meter Insights QR code feature quick start guide*, available from www.se.com, for information on using Meter Insights and the QR code feature on your meter.

Meter configuration

Meter configuration can be performed through the display (if your meter is equipped with one) or meter webpages or ION Setup.

ION Setup is a meter configuration tool that can be downloaded for free at www.se.com.

See the ION Setup online help or in the ION Setup device configuration guide. To download a copy, go to www.se.com and search for ION Setup device configuration guide.

Hardware reference

Supplemental information

This document is intended to be used in conjunction with the instruction sheet that comes in the box with your device and accessories.

See your device's instruction sheet for information related to installation.

See your product's catalog pages at www.se.com for information about your device, its options and accessories.

You can download updated documentation from www.se.com or contact your local Schneider Electric representative for the latest information about your product.

Meter description

All meter models except PM5563

The image contains three technical diagrams of a meter. The top diagram shows the internal terminal block with labels A through G. The middle diagram shows the meter with its cover removed, highlighting features H through K. The bottom diagram shows the front panel with labels L through N.

A	Voltage inputs: V1, V2, V3, VN
B	Control power (auxiliary power): <ul style="list-style-type: none"> All models except PM5580 / PM5570L / PM5660L / PM5760L: L1, L2 PM5580 / PM5570L / PM5660L / PM5760L: +, -
C	Ethernet ports
D	Digital outputs: D1+, D1-, D2+, D2-
E	Current inputs: I1+, I1-, I2+, I2-, I3+, I3-, I4+, I4-
F	Digital inputs: <ul style="list-style-type: none"> PM5560 / PM5561 / PM5562 / PM5562MC / PM5650 / PM5580: S1+, S1-, S2+, S2-, S3+, S3-, S4+, S4- Digital and analog inputs: <ul style="list-style-type: none"> PM5570 / PM5570L: S1+, S1-, S2+, S2-, A1+, A1-, A2+, A2- Digital and RCM inputs: <ul style="list-style-type: none"> PM5660 / PM5661 / PM5760 / PM5761 / PM5660L / PM5760L: S1+, S1-, S2+, S2- / I5+, I5-, I6+, I6-
G	Communication RS-485 port: +, -, \ominus , C
H	Gasket
I	Revenue lock LED indicator (only PM5562 / PM5562MC)
J	Revenue lock switch (only PM5562 / PM5562MC)
K	Ethernet communication LEDs
L	Alarm / energy pulsing LED
M	Heartbeat / serial communications LED
N	Navigation / menu selection buttons

PM5563

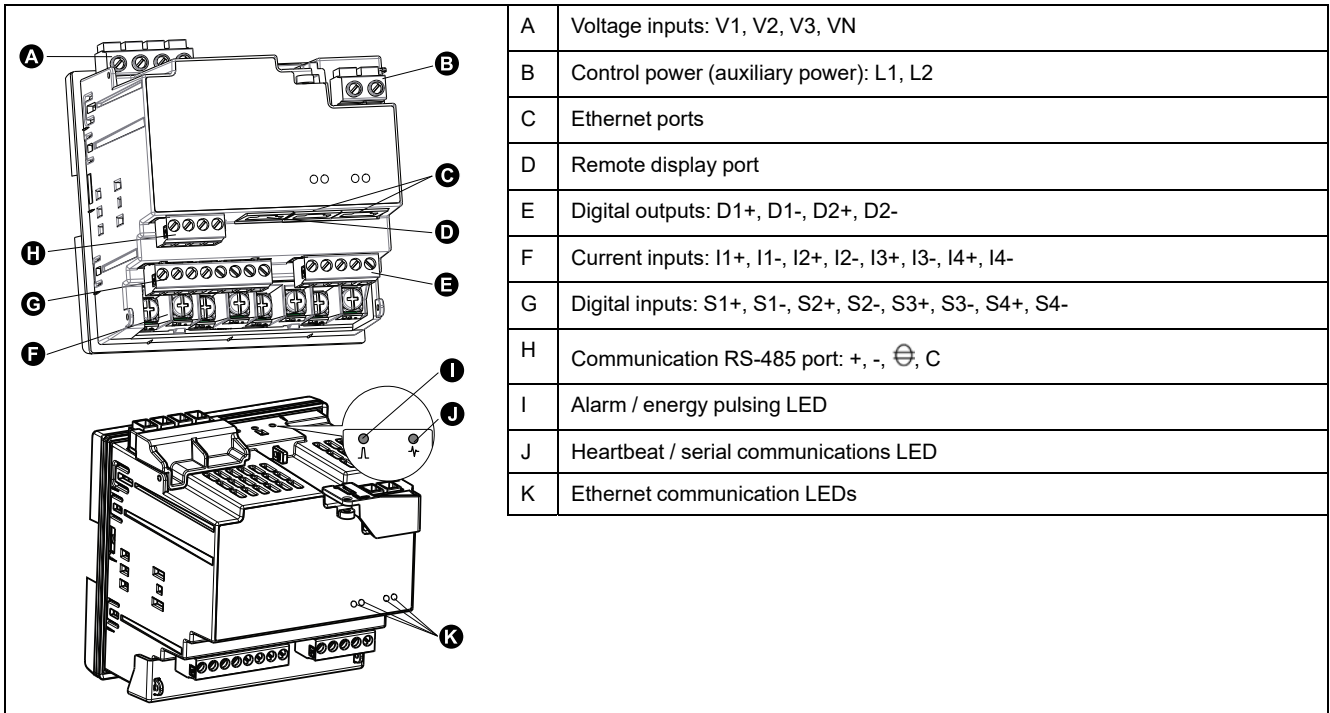

Alarm / energy pulsing LED

The alarm / energy pulsing LED can be configured for alarm notification or energy pulsing.

When configured for alarm notification, this LED flashes when a high, medium or low priority alarm is active. The LED provides a visual indication of an active alarm condition or an inactive but unacknowledged high priority alarm.

When configured for energy pulsing, this LED flashes at a rate proportional to the amount of energy consumed. This is typically used to verify the power meter's accuracy.

NOTE: The alarm / energy pulsing LED on the MID/MIR model is permanently set for energy pulsing and cannot be disabled or used for alarms.

Heartbeat / serial communications LED

The heartbeat / serial communications LED blinks to indicate the meter's operation and serial Modbus communication status.

The LED blinks at a slow, steady rate to indicate the meter is operational. The LED flashes at a variable, faster rate when the meter is communicating over a Modbus serial communications port.

You cannot configure this LED for other purposes.

NOTE: A heartbeat LED that remains lit and does not blink (or flash) can indicate a technical problem. In this case, power down the meter and reapply power. If the LED still does not blink or flash, contact Technical Support.

Ethernet communications LEDs

The meter has two LEDs per port for Ethernet communications.

The Link LED is on when there is a valid Ethernet connection. The Act (active) LED flashes to indicate the meter is communicating through the Ethernet port.

You cannot configure these LEDs for other purposes.

Revenue lock LED

The revenue lock LED indicates the lock status on the PM5562 and PM5562MC.

The LED turns steady green when the revenue lock is enabled.

Terminal covers

The voltage, current and control/auxiliary power terminal covers help prevent and detect tampering with the meter's voltage, current measurement inputs and control/auxiliary power inputs.

The terminal covers enclose the terminals, the conductor fixing screws and a length of the external conductors and their insulation. The terminal covers are to be secured by tamper-resistant meter seals.

These covers are included for meter models where sealable voltage, current and control/auxiliary power covers are required to comply with revenue or regulatory standards.

The meter terminal covers must be installed by a qualified installer.

Refer to your meter's installation sheet or the instructions that came with your terminal covers for instructions on installing the terminal covers.

Removing the PM5563 from the DIN rail

Follow these instructions to remove the meter from a TS35 Top-Hat style DIN rail.

Installation, wiring, testing and service must be performed in accordance with all local and national electrical codes.

DANGER

HAZARD OF ELECTRIC SHOCK, EXPLOSION, OR ARC FLASH

- Apply appropriate Personal Protective Equipment (PPE) and follow safe electrical work practices. See NFPA 70E, CSA Z462 or other local standards.
- Turn off all power supplying this device and the equipment in which it is installed before working on or in the equipment.
- Always use a properly rated voltage sensing device to confirm that all power is off.
- Do not exceed the maximum ratings of this device.
- Do not short secondary terminals of Voltage Transformer (VT).
- Do not open secondary terminals of Current Transformer (CT).
- Ground secondary circuit of CTs.
- Replace all devices, doors and covers before turning on power to this equipment.

Failure to follow these instructions will result in death or serious injury.

1. Turn off all power supplying this device and the equipment in which it is installed before working on it.

2. Always use a properly rated voltage sensing device to confirm that all power is off.
3. Insert a flat-tip screwdriver into the DIN release clip. Pull down the clip until you hear an audible click and the DIN clip is unlocked.

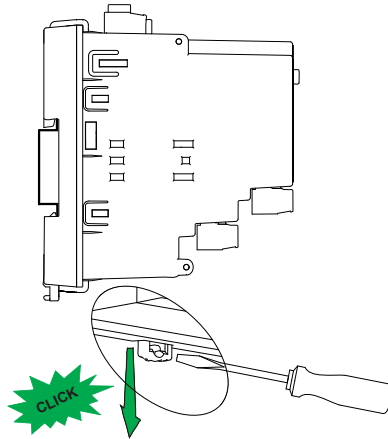

4. Swing the meter out and upwards to remove the meter.

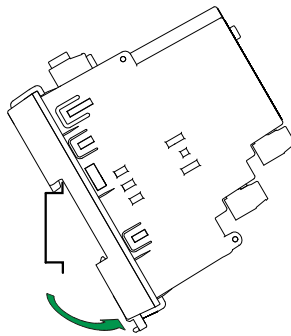

Meter wiring considerations

Direct connect voltage limits

You can connect the meter’s voltage inputs directly to the phase voltage lines of the power system if the power system’s line-to-line or line-to-neutral voltages do not exceed the meter’s direct connect maximum voltage limits.

The meter’s voltage measurement inputs are rated by the manufacturer for up to 400 V L-N / 690 V L-L. However, the maximum voltage allowed for direct connection may be lower, depending on the local electrical codes and regulations. In US and Canada the maximum voltage on the meter voltage measurement inputs may not exceed 347 V L-N / 600 V L-L.

If your system voltage is greater than the specified direct connect maximum voltage, you must use VTs (voltage transformers) to step down the voltages.

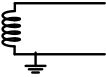
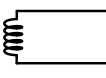
Power system description	Meter setting	Symbol	Direct connect maximum (UL)	Direct connect maximum (IEC)	# of VTs (if required)
Single-phase 2-wire line-to-neutral	1PH2W LN		347 V L-N	400 V L-N	1 VT
Single-phase 2-wire line-to-line	1PH2W LL		600 V L-L	690 V L-L	1 VT

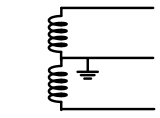
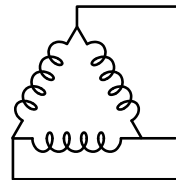
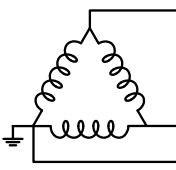
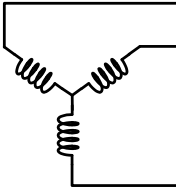
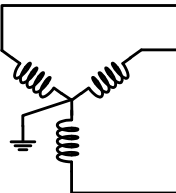
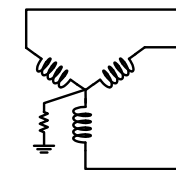
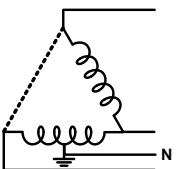
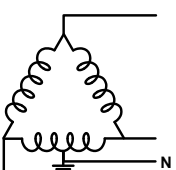
Power system description	Meter setting	Symbol	Direct connect maximum (UL)	Direct connect maximum (IEC)	# of VTs (if required)
Single-phase 3-wire line-to-line with neutral	1PH3W LL with N		347 V L-N / 600 V L-L	400 V L-N / 690 V L-L	2 VT
3-phase 3-wire Delta ungrounded	3PH3W Dlt Ungnd		600 V L-L	600 V L-L	2 VT
3-phase 3-wire Delta corner grounded	3PH3W Dlt Cmr Gnd		600 V L-L	600 V L-L	2 VT
3-phase 3-wire Wye ungrounded	3PH3W Wye Ungnd		347 V L-N / 600 V L-L	400 V L-N / 690 V L-L	2 VT
3-phase 3-wire Wye grounded	3PH3W Wye Gnd		347 V L-N / 600 V L-L	400 V L-N / 690 V L-L	2 VT
3-phase 3-wire Wye resistance-grounded	3PH3W Wye Res Gnd		347 V L-N / 600 V L-L	400 V L-N / 690 V L-L	2 VT
3-phase 4-wire open Delta center-tapped	3PH4W Opn Dlt Ctr Tp		347 V L-N / 600 V L-L	400 V L-N / 690 V L-L	3 VT
3-phase 4-wire Delta center-tapped	3PH4W Dlt Ctr Tp		347 V L-N / 600 V L-L	400 V L-N / 690 V L-L	3 VT

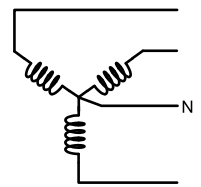
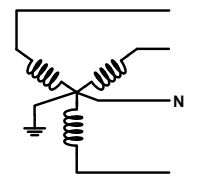
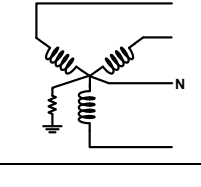
Power system description	Meter setting	Symbol	Direct connect maximum (UL)	Direct connect maximum (IEC)	# of VTs (if required)
3-phase 4-wire ungrounded Wye	3PH4W Wye Ungnd		347 V L-N / 600 V L-L	400 V L-N / 690 V L-L	3 VT or 2 VT
3-phase 4-wire grounded Wye	3PH4W Wye Gnd		347 V L-N / 600 V L-L	400 V L-N / 690 V L-L	3 VT or 2 VT
3-phase 4-wire resistance-grounded Wye	3PH4W Wye Res Gnd		347 V L-N / 600 V L-L	400 V L-N / 690 V L-L	3 VT or 2 VT
<p>NOTE:</p> <ul style="list-style-type: none"> • Use a 500 mA fuse or a circuit breaker for the meter voltage input terminals. • Use a shorting block between the current transformer (CT) and the meter current input terminals. • Use primary fuses and disconnect switch to protect the potential transformer (PT). 					

Balanced system considerations

In situations where you are monitoring a balanced 3-phase load, you may choose to connect only one or two CTs on the phase(s) you want to measure, and then configure the meter so it calculates the current on the unconnected current input(s).

NOTE: For a balanced 4-wire Wye system, the meter’s calculations assume that there is no current flowing through the neutral conductor.

Balanced 3-phase Wye system with 2 CTs

The current for the unconnected current input is calculated so that the vector sum for all three phases equal zero.

Balanced 3-phase Wye or Delta system with 1CT

The currents for the unconnected current inputs are calculated so that their magnitude and phase angle are identical and equally distributed, and the vector sum for all three phase currents equal zero.

NOTE: You must always use 3 CTs for 3-phase 4-wire center-tapped Delta or center-tapped open Delta systems.

Neutral and ground current

The fourth current input (I4) can be used to measure current flow (In) in the neutral conductor, which can then be used to calculate residual current. The meter refers to residual current as ground current (I_g).

For 4-wire Wye systems, ground current is calculated as the difference between the measured neutral current and the vector sum of all measured phase currents.

Control power (auxiliary power)

PM5560 / PM5561 / PM5562 / PM5562MC / PM5563 / PM5650 / PM5570 / PM5660 / PM5661 / PM5760 / PM5761 meter models

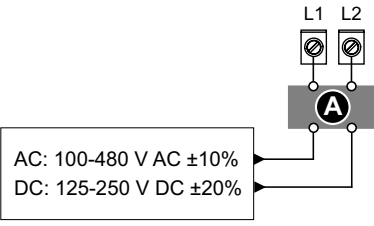
	A	500 mA fuse
	<p>L1 and L2 are non-polarized. If using an AC power supply with neutral, connect neutral to the meter's L2 terminal.</p> <p>Always use a fuse on L1. Fuse L2 when connecting an ungrounded neutral to the control power.</p> <p>If using a control power transformer, fuse both primary and secondary sides of the transformer.</p> <p>The fuses / circuit breakers must be rated for the installation voltage and sized for the available fault current.</p>	

PM5580 / PM5570L / PM5660L / PM5760L meter models

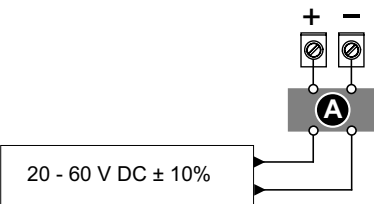
	A	1 A fuse
	<p>The low-voltage DC power connections + and - are polarized. These connections are internally reverse polarity protected.</p> <p>Always use a fuse on +. Fuse - when connecting to a floating DC source.</p> <p>The fuses / circuit breakers must be rated for the installation voltage and sized for the available fault current.</p>	

MID/MIR control power (auxiliary power) requirements

The auxiliary power supply source must not be connected to the load side of the measured circuit.

The auxiliary power supply of the meter must be connected in a way that ensures uninterrupted meter operation in situations where any one or two phases of the measured circuit become de-energized.

It is recommended to use an auxiliary power source, such as a DC station battery or UPS, that is independent of the measured circuit.

An external 3-phase power supply device may be used as an auxiliary power source if it is energized from all three phases of the supply (utility) side of the measured circuit.

Communications connections

RS-485 wiring

Connect the devices on the RS-485 bus in a point-to-point configuration, with the (+) and (-) terminals from one device connected to the corresponding (+) and (-) terminals on the next device.

RS-485 cable

Use a shielded 2 twisted pair or 1.5 twisted pair RS-485 cable to wire the devices. Use one twisted pair to connect the (+) and (-) terminals, and use the other insulated wire to connect the C terminals

The total distance for devices connected on an RS-485 bus should not exceed 1200 m (4000 ft).

RS-485 terminals

C	Common. This provides the voltage reference (zero volts) for the data plus and data minus signals
	Shield. Connect the bare wire to this terminal to help suppress signal noise that may be present. Ground the shield wiring at one end only (either at the master or the last slave device, but not both).
-	Data minus. This transmits/receives the inverting data signals.
+	Data plus. This transmits/receives the non-inverting data signals.

NOTE: If some devices in your RS-485 network do not have the Common terminal, use the bare wire in the RS-485 cable to connect the Common terminal from the meter to the shield terminal on the devices that do not have the Common terminal.

Ethernet communications connections

Use a Cat 5 cable to connect the meter's Ethernet port.

Your Ethernet connection source should be installed in a location that minimizes the overall Ethernet cable routing length.

Digital outputs

The meter is equipped with two Form A digital outputs (D1, D2).

You can configure the digital outputs for use in the following applications:

- switching applications, for example, to provide on/off control signals for switching capacitor banks, generators, and other external devices and equipment
- demand synchronization applications, where the meter provides pulse signals to the input of another meter to control its demand period
- energy pulsing applications, where a receiving device determines energy usage by counting the kWh pulses coming from the meter's digital outputs

Refer to *Device specifications*, page 228 for the voltage limits of the digital outputs. For higher voltage applications, use an external relay as the switching circuit.

Digital inputs

The meter is equipped with four digital inputs (S1 to S4) or two digital inputs (S1 & S2)*.

NOTE: *Available in specific meter models. Refer to *Features differentiation matrix* for PM5500 / PM5600 / PM5700 series, page 20 for the availability.

You can configure the digital inputs for use in status monitoring or input metering applications.

The meter's digital inputs require an external voltage source to detect the digital input's on/off state. The meter detects an on state if the external voltage appearing at the digital input is within its operating range.

Refer to *Device specifications*, page 228 for the external voltage sources to detect the digital input's on/off state.

Analog inputs

The meter is equipped with two analog inputs (A1 & A2)*.

NOTE: *Available in specific meter models. Refer to *Features differentiation matrix* for PM5500 / PM5600 / PM5700 series, page 20 for the availability.

The analog inputs interpret an incoming analog current signal from transducers. For analog input operation, the meter processes an analog input signal and provides the resulting scaled value.

The meter measures the current using standard 4 - 20 mA analog transducers.

Display

Display overview

The display (integrated or remote) lets you use the meter to perform various tasks such as setting up the meter, displaying data screens, acknowledging alarms, or performing resets.

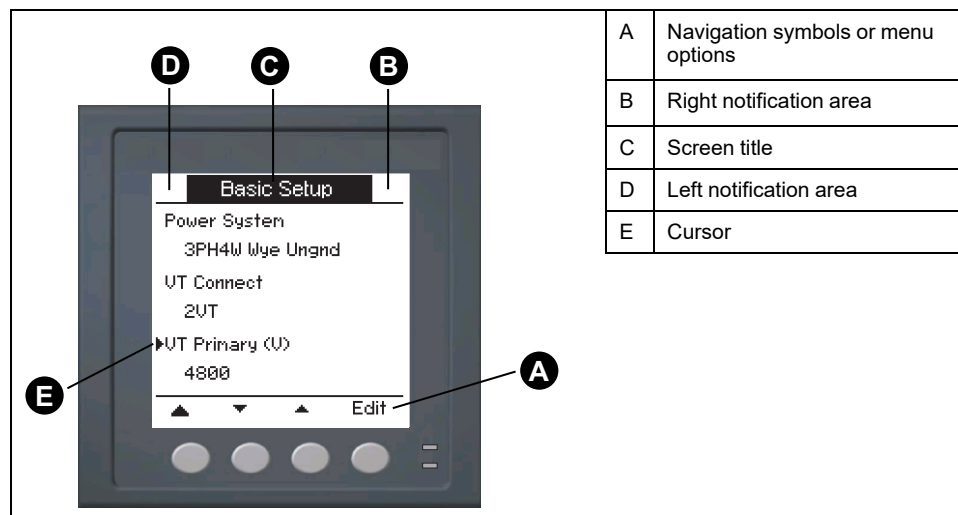

Default data display screen

The default data display screen varies depending on the meter model.

The **Summary** screen is the default screen for all meter models except PM5561 / PM5661 / PM5761.

The **Summary** screen displays real-time values for average voltage and current (Vavg, Iavg), total power (Ptot) and energy consumption (E Del).

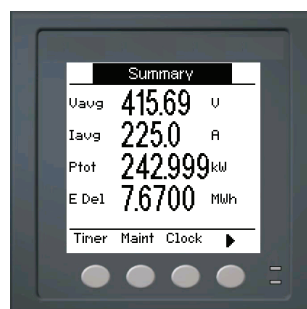



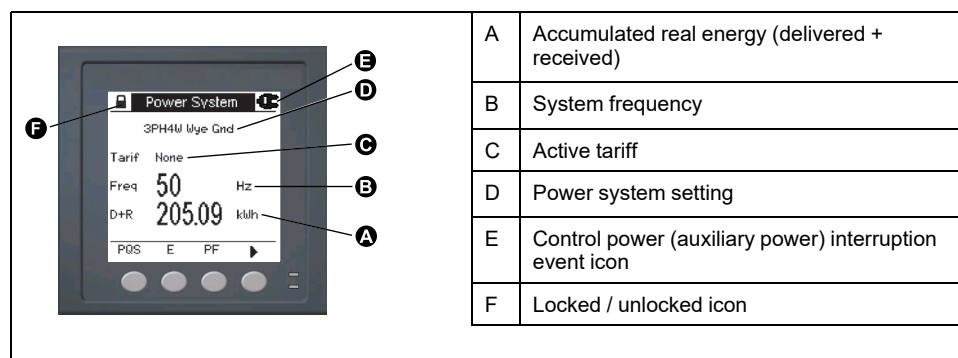

The **Power System** screen is the default screen for PM5561 / PM5661 / PM5761 meter models.



Notification icons

To alert you about meter state or events, notification icons appear at the top left or top right corner of the display screen.

Icon	Description
	The wrench icon indicates that the power meter is in an over voltage condition or requires maintenance. It could also indicate that the energy LED is in an overrun state.
	The alarm icon indicates an alarm condition has occurred.
	The meter's hardware and / or firmware lock is enabled.
 (Displayed only in MID/MIR compliance meter models)	The icon indicates that a control power (auxiliary power) interruption event has occurred.

Meter display language

You can configure the meter to display the information on the display screen in one of several languages.

The following languages are available:

- English
- French
- Spanish
- German
- Italian
- Portuguese
- Russian
- Chinese

Resetting the display language

To reset the meter to the default language (English), press and hold the outermost two buttons for 5 seconds.

Meter screen navigation

The meter's buttons and display screen allow you to navigate data and setup screens, and to configure the meter's setup parameters.

A. Press the button below the appropriate menu to view that screen

B. Press the right arrow to view more screens

C. In setup mode, a small right arrow indicates the selected option

D. In setup mode, a small down arrow indicates that there are additional parameters to display. The down arrow disappears when there are no more parameters to display.

E. In setup mode, press the button under **Edit** to change that setting. If the item is read-only, cannot be configured with the meter's existing setup, or can only be configured using software, **Edit** disappears.

Navigation symbols

Navigation symbols indicate the functions of the associated buttons on your meter's display.

Symbol	Description	Actions
▶	Right arrow	Scroll right and display more menu items or move cursor one character to the right
▲	Up arrow	Exit screen and go up one level
▼	Small down arrow	Move cursor down the list of options or display more items below
▲	Small up arrow	Move cursor up the list of items or display more items above
◀	Left arrow	Move cursor one character to the left
+	Plus sign	Increase the highlighted value or show the next item in the list.
-	Minus sign	Show the previous item in the list

When you reach the last screen, press the right arrow again to cycle through the screen menus.

Meter screen menus overview

All meter screens are grouped logically, according to their function.

You can access any available meter screen by first selecting the Level 1 (top level) screen that contains it.

Level 1 screen menus - IEEE title [IEC title]

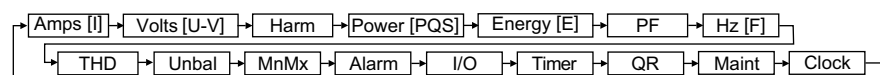

Menu tree

Use the menu tree to navigate to the setting you want to view or configure.

The image below summarizes the available meter screens (IEEE menus shown, with the corresponding IEC menus in parentheses).

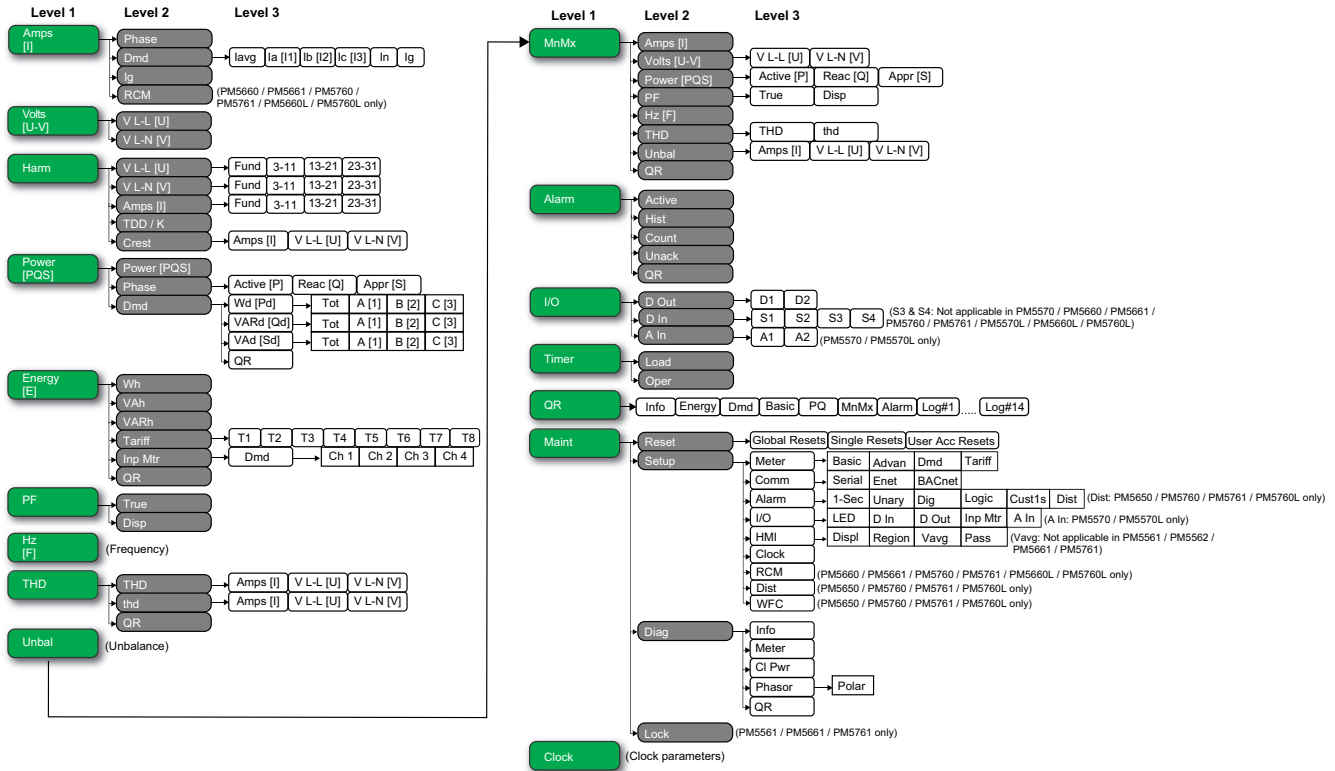

Data display screens

The meter display screens allow you to view meter values and configure settings.

The titles listed are for the HMI mode in IEEE, with the corresponding titles in IEC mode in square brackets [].

- Bulleted items indicate subscreens and their descriptions.

Amps [I]

Phase	Instantaneous current measurements for each phase and neutral (Ia [I1], Ib [I2], Ic [I3], In).
Dmd	Summary of peak current demand values at the last demand interval for each phase and neutral (Ia [I1], Ib [I2], Ic [I3], In). <ul style="list-style-type: none"> • lavg, Ia [I1], Ib [I2], Ic [I3], In, Ig • Real-time demand (Pres), peak demand (Peak) and predicted demand (Pred) for the present interval. Average demand for the previous (Last) interval. • Pk DT • Date and timestamp for the peak demand readings.
Ig	Average (lavg), neutral (In) and residual/ground (Ig) current.
RCM (PM5660 / PM5661 / PM5760 / PM5761 / PM5660L / PM5760L only)	Instantaneous residual current measurement (I5 and I6).

Volts [U-V]

V L-L [U]	Line-to-line phase voltage (Vab [U12], Vbc [U23], Vca [U31]).
V L-N [V]	Line-to-neutral phase voltage (Van [V1], Vbn [V2], Vcn [V3]).

Harm

V L-L [U] <ul style="list-style-type: none"> • Fundamental, 3-11, 13-21, 23-31 	Line-to-line voltage harmonics data: Numeric magnitude and angle for the fundamental harmonic, and graphical representation of harmonics for the 3rd to 11th, 13th to 21st, and 23rd to 31st odd harmonics for each line-to-line phase voltage (Vab [U12], Vbc [U23], Vca [U31]).
V L-N [V] <ul style="list-style-type: none"> • Fundamental, 3-11, 13-21, 23-31 	Line-to-neutral voltage harmonics data: Numeric magnitude and angle for the fundamental harmonic, and graphical representation of harmonics for the 3rd to 11th, 13th to 21st, and 23rd to 31st odd harmonics for each line-to-neutral phase voltage (Van [V1], Vbn [V2], Vcn [V3]).
Amps [I] <ul style="list-style-type: none"> • Fundamental, 3-11, 13-21, 23-31 	Current harmonics data: Numeric magnitude and angle for the fundamental harmonics, and graphical representation of harmonics for the 3rd to 11th, 13th to 21st, and 23rd to 31st odd harmonics for each phase current (Ia [I1], Ib [I2], Ic [I3]).
TDD / K	Total demand distortion and K-factor data for each phase voltage (K-F A [K-F 1], K-F B [K-F 2], K-F C [K-F 3]).
Crest <ul style="list-style-type: none"> • Amps [I], V L-L [U], V L-N [V] 	Crest factor data for each phase current (Ia [I1], Ib [I2], Ic [I3]), line-to-line phase voltage (Vab [U12], Vbc [U23], Vca [U31]), and line-to-neutral phase voltage (Van [V1], Vbn [V2], Vcn [V3]).

Power [PQS]

Power [PQS]	Summary of real-time power consumption values for total active power in kW (Total [Ptot]), total reactive power in kVAR (Total [Qtot]), and total apparent power in kVA (Total [Stot]).
Phase <ul style="list-style-type: none"> • Active [P], Reac [Q], Appr [S] 	Per phase and total power values for active power in kW (A [P1], B [P2], C [P3], Total [Ptot]), reactive power in kVAR (A [Q1], B [Q2], C [Q3], Total [Qtot]) and apparent power in kVA (A [S1], B [S2], C [S3], Total [Stot]).
Dmd <ul style="list-style-type: none"> • Wd [Pd], VARd [Qd], VAd [Sd] • Tot, A [1], B [2], C [3] • Pk DT • QR 	<p>Summary of peak power demand values in the previous (Last) demand interval period for active power in kW, reactive power in kVAR and apparent power in kVA.</p> <ul style="list-style-type: none"> • Total and per phase peak power demand values in the previous (Last) demand interval for active power demand (Wd [P]), reactive power demand (VARd [Q]) and apparent power demand (VAd [S]). • For the selected power demand screen (active, reactive or apparent), each of these sub-screens (total and per phase demand) display demand values for the present demand (Pres) interval, predicted demand (Pred) based on the current power consumption rate, demand for the previous demand (Last) interval period, and recorded peak power demand (Peak) value. • Date and timestamp for the peak power demand (Peak) value. • Power demand parameters embedded in QR code format.

Energy [E]

Wh, VAh, VARh	Delivered (Del), received (Rec), delivered plus received (D+R) and delivered minus received (D-R) accumulated values for active energy (Wh), apparent energy (VAh) and reactive energy (VARh).
Tariff <ul style="list-style-type: none"> • T1, T2, T3, T4, T5, T6, T7, T8 • Del • Rec • InMet 	<ul style="list-style-type: none"> • Displays the available tariffs (T1 through T8). • Active energy delivered in Wh (W [P]), reactive energy delivered in VARh (VAR [Q]) and apparent energy delivered in VAh (VA [S]) energy for the selected tariff. • Active energy received in Wh (W [P]), reactive energy received in VARh (VAR [Q]) and apparent energy received in VAh (VA [S]) energy for the selected tariff • Accumulated values on the input metering channels (Ch 1 to Ch 4) for the selected tariff.
Inp Mtr <ul style="list-style-type: none"> • Dmd • Ch 1, Ch 2, Ch 3, Ch 4 • Pk DT 	<p>Accumulated values on the input metering channels (Ch 1 to Ch 4).</p> <ul style="list-style-type: none"> • Summary of demand values for input metering channels Ch 1 to Ch 4 in the previous (Last) demand interval. • Demand values for present (Pres) and previous (Last) interval periods, predicted demand (Pred) based on the current consumption rate, and recorded peak demand (Peak) value for the selected input metering channel. • Date and timestamp for the peak demand reading.
QR	Energy parameters (Wh, VAh, VARh, Tariff and Input metering) embedded in QR code format.

PF

True	True power factor values per phase and total (PFa [PF1], PFb [PF2], PFc [PF3], Total [Ptot]), PF sign, and load type (capacitive = lead, inductive = lag).
Disp	Displacement power factor values per phase and total (PFa [PF1], PFb [PF2], PFc [PF3], Total [Ptot]), PF sign, and load type (capacitive = lead, inductive = lag).

Hz [F]

Frequency (Freq). This page also displays average voltage (Vavg), average current (Iavg) and total power factor (PF) values.
--

THD

THD • Amps [I], V L-L [U], V L-N [V]	THD (ratio of harmonic content to the fundamental) for phase currents (Ia [I1], Ib [I2], Ic [I3], In), line-to-line voltages (Vab [U12], Vbc [U23], Vca [U31]) and line-to-neutral voltages (Van [V1], Vbn [V2], Vcn [V3]).
thd • Amps [I], V L-L [U], V L-N [V]	thd (ratio of harmonic content to the rms value of total harmonic content) phase currents (Ia [I1], Ib [I2], Ic [I3], In), line-to-line voltages (Vab [U12], Vbc [U23], Vca [U31]) and line-to-neutral voltages (Van [V1], Vbn [V2], Vcn [V3]).
QR	Power quality parameters (THD and thd) embedded in QR code format.

Unbal

Percent unbalance readings for line-to-line voltage (V L-L [U]), line-to-neutral voltage (V L-N [V]) and current (Amps [I]).
--

MnMx

Amps [I]	Summary of minimum and maximum values for phase current.
Volts [U-V] • V L-L [U], V L-N [V]	Summary of minimum and maximum values for line-to-line voltage and line-to-neutral voltage.
Power [PQS] • Active [P], Reac [Q], Appr [S]	Minimum and maximum values for active, reactive, and apparent power.
PF • True, Disp	Minimum and maximum values for true and displacement PF and PF sign.
Hz [F]	Minimum and maximum values for frequency.
THD • THD, thd ◦ Amps [I], V L-L [U], V L-N [V]	Minimum and maximum values for total harmonic distortion (THD or thd). • THD or thd minimum and maximum values for phase or neutral current, line-to-line voltage and line-to-neutral voltage.
Unbal • Amps [I], V L-L [U], V L-N [V]	Minimum and maximum values for current unbalance, line-to-line voltage unbalance and line-to-neutral voltage unbalance.
QR	Minimum and maximum values (phase current, line-to-line voltage, line-to-neutral voltage, power (PQS), PF, frequency, power quality and Unbal) embedded in QR code format.

Alarm

Active, Hist, Count, Unack	Lists all active alarms (Active), past alarms (Hist), the total number of times each standard alarm was tripped (Count), and all unacknowledged alarms (Unack).
QR	Alarm parameters (active, past alarms, the total number of times each standard alarm was tripped, unacknowledged) embedded in QR code format.

I/O

<p>D Out</p> <ul style="list-style-type: none"> • D1, D2 <p>D In</p> <ul style="list-style-type: none"> • S1, S2, S3, S4 <p>A In (PM5570 / PM5570L only)</p> <ul style="list-style-type: none"> • A1, A2 	<p>Current status (on or off) of the selected digital output or digital input. Counter shows the total number of times an off-to-on change of state is detected. Timer shows the total time (in seconds) that a digital input or digital output is in the on state.</p> <p>Summary of analog inputs (A1 & A2).</p> <ul style="list-style-type: none"> • Raw Value (mA) • Scaled Value • Unit
---	---

Timer

<p>Load</p>	<p>Real-time counter that keeps track of the total number of days, hours, minutes and seconds an active load is connected to the meter inputs.</p>
<p>Oper</p>	<p>Real-time counter for the total number of days, hours, minutes and seconds the meter has been powered.</p>

QR

<p>Meter info details, energy parameters, power demand parameters, basic parameter values (current, voltage and power), power quality parameters, minimum / maximum values (phase current, line-to-line voltage, line-to-neutral voltage, power (PQS), PF, frequency, power quality and Unbal), alarm parameters and data log parameters embedded in QR code format.</p> <p>NOTE: The QR code will be automatically refreshed every 5 seconds except for the meter info page.</p>

Maint

<p>Resets</p> <ul style="list-style-type: none"> • Global Resets • Single Resets • User Acc Resets 	<p>Screens to perform global resets, single resets and user account resets.</p>
<p>Setup</p> <ul style="list-style-type: none"> • Meter <ul style="list-style-type: none"> ◦ Basic ◦ Advan ◦ Dmd ◦ Tariff • Comm <ul style="list-style-type: none"> ◦ Serial ◦ Enet ◦ BACnet • Alarm <ul style="list-style-type: none"> ◦ 1-Sec ◦ Unary ◦ Dig ◦ Logic ◦ Cust1s ◦ Dist (PM5650 / PM5760 / PM5761 / PM5760L only) • I/O <ul style="list-style-type: none"> ◦ LED ◦ D In ◦ D Out ◦ Inp Mtr ◦ A In (PM5570 / PM5570L only) 	<ul style="list-style-type: none"> • Meter configuration screens. <ul style="list-style-type: none"> ◦ Screens to define the power system and power system components/elements. ◦ Screens to set up the active load timer and define the peak demand current for inclusion in TDD calculations. ◦ Screens to set up power demand, current demand and input metering demand. ◦ Screens to set up tariffs. • Screens to set up serial, Ethernet and BACnet communications. • Screens to set up standard (1-Sec), unary, digital, logic, custom (Cust1s) and disturbance alarms. • Screens to set up the alarm / energy pulsing LED, digital inputs/outputs, input metering channels and analog inputs.

Maint (Continued)

<ul style="list-style-type: none"> • HMI <ul style="list-style-type: none"> ◦ Displ ◦ Region ◦ Vavg (Not applicable in PM5561 / PM5562 / PM5661 / PM5761) ◦ Pass • Clock • RCM (PM5660 / PM5661 / PM5760 / PM5761 / PM5660L / PM5760L only) • Dist (PM5650 / PM5760 / PM5761 / PM5760L only) • WFC (PM5650 / PM5760 / PM5761 / PM5760L only) 	<ul style="list-style-type: none"> • Screens to configure display settings, edit regional settings, select the type of average voltage you want the meter to display on the summary page and set up meter display access passcodes. • Screens to set up the meter date and time. • Screen to set up I5 toroid and I6 toroid turns. • Screen to set up sag and swell limits. • Screen to set up waveform capture.
<p>Diag</p> <ul style="list-style-type: none"> • Info • Meter • CI Pwr • Phasor <ul style="list-style-type: none"> ◦ Polar • QR 	<p>Diagnostic screens provide meter information for troubleshooting.</p> <ul style="list-style-type: none"> • The Info screen displays the meter model, serial number, date of manufacture, firmware version (including OS - Operating System and RS - Reset System), language version, and OS CRC (Cyclic Redundancy Check). The OS CRC value is a number (Hexadecimal format) that identifies the uniqueness between different OS firmware versions. • Displays the meter status. • Non-MID/MIR meter models: The CI Pwr screen displays how many times the meter lost control power, and the date and time of its last occurrence. • MID/MIR meter models: The CI Pwr screen displays how many times the meter lost control power (auxiliary power), and the last power up and power down events with the timestamp. • Displays a graphical representation of the power system the meter is monitoring. <ul style="list-style-type: none"> ◦ Displays the numeric magnitude and angles of all voltage and current phases. • Meter info details embedded in QR code format.
<p>Lock (PM5561 / PM5661 / PM5761 only)</p>	<p>This locks or unlocks the MID/MIR protected quantities.</p>

Clock

<p>Meter date and time (local or GMT).</p>
--

HMI setup screens

You can configure the meter’s display using the HMI setup screens.

The HMI (human-machine interface) setup screens allow you to:

- control the general appearance and behavior of the display screens,
- change the regional settings,
- select the type of average voltage you want the meter to display on the summary page (Not applicable in PM5561 / PM5562 / PM5661 / PM5761 meter models),
- change the meter passcodes,
- enable or disable the QR code feature for accessing meter data.

See the *Meter Insights QR code feature quick start guide* for more information on accessing meter data using QR codes.

Setting up the display

You can change the display screen’s settings, such as contrast, display and backlight timeout and QR code display.

1. Navigate to **Maint > Setup**.
2. Enter the setup passcode (default is “0”), then press **OK**.
3. Navigate to **HMI > Displ.**
4. Move the cursor to point to the parameter you want to modify, then press **Edit**.
5. Modify the parameter as required, then press **OK**.
6. Move the cursor to point to the next parameter you want to modify, press **Edit**, make your changes, then press **OK**.
7. Press the up arrow to exit.
8. Press **Yes** to save your changes.

Display settings available using the display

Parameter	Values	Description
Contrast	1 - 9	Increase or decrease the value to increase or decrease the display contrast.
Bcklght Timeout (min)	0 - 99	Set how long backlight reduces its brightness after inactivity minutes. Default setting "0" disables the backlight timeout feature (i.e., backlight is always ON).
Screen Timeout (min)	0 - 99	Set how long the screen turns off after inactivity minutes. Default setting "0" disables the screen timeout feature (i.e., display is always ON).
QR Code	Enable, Disable	Set whether or not QR codes with embedded data are available on the display.

See the *Meter Insights QR code feature quick start guide* for more information on accessing meter data using QR codes.

To configure the display using ION Setup, see the section for your meter in the ION Setup online help or in the ION Setup device configuration guide, available for download at www.se.com.

Setting up the average voltage (Vavg) on the summary page using the display

Not applicable in PM5561 / PM5562 / PM5661 / PM5761 meter models.

You can select the type of average voltage you want the meter to display on the summary page.

1. Navigate to **Maint > Setup**.
2. Enter the setup passcode (default is “0”), then press **OK**.
3. Navigate to **HMI > Vavg**.
4. Move the cursor to point to **Vavg** you want to modify, then press **Edit**.
5. Select the parameter (**Auto / Voltage L-L / Voltage L-N**) as required, then press **OK**.

6. Press the up arrow to exit. Press **Yes** to save your changes.

Average voltage (Vavg) settings available using the display

Parameter	Values	Description
Auto	Factory default setting	Vavg on Summary page will show average line-to-line or line-to-neutral voltage based on the wiring configuration.
Voltage L-L	Max 690 V L-L	If the selected wiring configuration does not have line-to-line voltage to be measured, the Vavg parameter on the Summary page will show a sequence of asterisks (*****).
Voltage L-N	Max 400 V L-N	If the selected wiring configuration does not have line-to-neutral voltage to be measured, the Vavg parameter on the Summary page will show a sequence of asterisks (*****).

NOTE: Change in setting will only affect the average voltage value displayed on the Summary page of the meter. The average voltage value displayed on the Frequency (Hz or F) page and encoded into the QR code is always based on Auto mode.

Basic setup

Configuring basic setup parameters using the display

You can configure basic meter parameters using the display.

Proper configuration of the meter's basic setup parameters is essential for accurate measurement and calculations. Use the Basic Setup screen to define the electrical power system that the meter is monitoring.

If standard (1-sec) alarms have been configured and you make subsequent changes to the meter's basic setup, all alarms are disabled to prevent undesired alarm operation.

NOTICE

UNINTENDED EQUIPMENT OPERATION

- Verify all standard alarms settings are correct and make adjustments as necessary.
- Re-enable all configured alarms.

Failure to follow these instructions can result in equipment damage.

After saving the changes, confirm all configured standard alarm settings are still valid, reconfigure them as required, and re-enable the alarms.

1. Navigate to **Maint > Setup**.
2. Enter the setup passcode (default is "0"), then press **OK**.
3. Navigate to **Meter > Basic**.
4. Move the cursor to point to the parameter you want to modify, then press **Edit**.
5. Modify the parameter as required, then press **OK**.
6. Move the cursor to point to the next parameter you want to modify, press **Edit**, make your changes, then press **OK**.

7. Press **Yes** to save your changes.**Basic setup parameters available using the display**

Values	Description
Power System	
Select the power system type (power transformer) the meter is wired to.	
1PH2W LN	Single-phase 2-wire line-to-neutral
1PH2W LL	Single-phase 2-wire line-to-line
1PH3W LL with N	Single-phase 3-wire line-to-line with neutral
3PH3W Dlt Ungnd	3-phase 3-wire ungrounded delta
3PH3W Dlt Crnr Gnd	3-phase 3-wire corner grounded delta
3PH3W Wye Ungnd	3-phase 3-wire ungrounded wye
3PH3W Wye Gnd	3-phase 3-wire grounded wye
3PH3W Wye Res Gnd	3-phase 3-wire resistance-grounded wye
3PH4W Opn Dlt Ctr Tp	3-phase 4-wire center-tapped open delta
3PH4W Dlt Ctr Tp	3-phase 4-wire center-tapped delta
3PH4W Wye Ungnd	3-phase 4-wire ungrounded wye
3PH4W Wye Gnd	3-phase 4-wire grounded wye
3PH4W Wye Res Gnd	3-phase 4-wire resistance-grounded wye
VT Connect	
Select how many voltage transformers (VT) are connected to the electrical power system.	
Direct Con	Direct connect; no VTs used
2VT	2 voltage transformers
3VT	3 voltage transformers
VT Primary (V)	
1 to 1,000,000	Enter the size of the VT primary, in Volts.
VT Secondary (V)	
100, 110, 115, 120	Select the size of the VT secondary, in Volts.
CT on Terminal	
Define how many current transformers (CT) are connected to the meter, and which terminals they are connected to.	
I1	1 CT connected to I1 terminal
I2	1 CT connected to I2 terminal
I3	1 CT connected to I3 terminal
I1 I2	2 CT connected to I1, I2 terminals
I1 I3	2 CT connected to I1, I3 terminals
I2 I3	2 CT connected to I2, I3 terminals
I1 I2 I3	3 CT connected to I1, I2, I3 terminals
I1 I2 I3 IN	4 CT connected to I1, I2, I3, IN terminals
CT Primary (A)	
1 to 32767	Enter the size of the CT primary, in Amps.
CT Secondary (A)	
1, 5	Select the size of the CT secondary, in Amps.
CT Primary Neu. (A)	
1 to 32767	This parameter displays when CT on Terminal is set to I1,I2,I3, IN. Enter the size of the 4th (Neutral) CT primary, in Amps.

Basic setup parameters available using the display (Continued)

Values	Description
CT Sec. Neu. (A)	
1, 5	This parameter displays when CT on Terminal is set to I1,I2,I3, IN. Select the size of the 4th (Neutral) CT secondary, in Amps.
Sys Frequency (Hz)	
50, 60	Select the frequency of the electrical power system, in Hz.
Phase Rotation	
ABC, CBA	Select the phase rotation of the 3-phase system.

Configuring advanced setup parameters using the display

You can configure a subset of advanced parameters using the display.

1. Navigate to **Maint > Setup**.
2. Enter the setup passcode (default is "0"), then press **OK**.
3. Navigate to **Meter > Advan**.
4. Move the cursor to point to the parameter you want to modify, then press **Edit**.
5. Modify the parameter as required, then press **OK**.
6. Move the cursor to point to the next parameter you want to modify, press **Edit**, make your changes, then press **OK**.
7. Press **Yes** to save your changes.

Advanced setup parameters available using the display

Parameter	Values	Description
Label	—	This label identifies the device, e.g., "Power Meter". You cannot use the display to edit this parameter. Use ION Setup to change the device label.
Load Timer Setpt (A)	0 - 18	Specifies the minimum average current at the load before the timer starts. The meter begins counting the number of seconds the load timer is on (i.e., whenever the readings are equal to or above this average current threshold).
Pk I dmd for TDD (A)	0 - 18	Specifies the minimum peak current demand at the load for inclusion in total demand distortion (TDD) calculations. If the load current is below the minimum peak current demand threshold, the meter does not use the readings to calculate TDD. Set this to "0" (zero) if you want the power meter to use the metered peak current demand for this calculation.

Setting up regional settings

You can change the regional settings to localize the meter screens and display data in a different language, using local standards and conventions.

NOTE: In order to display a different language other than those listed in the Language setup parameter, you need to download the appropriate language file to the meter using the firmware upgrade process.

1. Navigate to **Maint > Setup**.
2. Enter the setup passcode (default is "0"), then press **OK**.
3. Navigate to **HMI > Region**.

4. Move the cursor to point to the parameter you want to modify, then press **Edit**.
5. Modify the parameter as required, then press **OK**.
6. Move the cursor to point to the next parameter you want to modify, press **Edit**, make your changes, then press **OK**.
7. Press the up arrow to exit.
8. Press **Yes** to save your changes.

Regional settings available using the display

Parameter	Values	Description
Language	English US, French, Spanish, German, Italian, Portuguese, Chinese, Russian	Select the language you want the meter to display.
Date Format	MM/DD/YY, YY/ MM/DD, DD/ MM/YY	Set how you want the date to be displayed, e.g., month/day/year.
Time Format	24Hr, AM/PM	Set how you want the time to be displayed, e.g., 17:00:00 or 5:00:00 PM.
HMI Mode	IEC, IEEE	Select the standards convention used to display menu names or meter data.

Resetting the display language

To reset the meter to the default language (English), press and hold the outermost two buttons for 5 seconds.

Setting up the screen passcodes

It is recommended that you change the default passcode in order to prevent unauthorized personnel from accessing passcode-protected screens such as the diagnostics and reset screens.

This can only be configured through the front panel. The factory-default setting for all passcodes is "0000" (zero).

If you lose your passcode, contact Schneider Electric technical support for assistance.

NOTICE

IRRECOVERABLE PASSCODE

Record your device's user and passcode information in a secure location.

Failure to follow these instructions can result in data loss.

NOTICE

LOSS OF DATA OR PRODUCT CONFIGURATION

Do not let unauthorized personnel gain physical access to the device.

Failure to follow these instructions can result in data loss and loss of access to the device.

1. Navigate to **Maint > Setup**.
2. Enter the setup passcode (default is "0"), then press **OK**.
3. Navigate to **HMI > Pass**.
4. Move the cursor to point to the parameter you want to modify, then press **Edit**.

Parameter	Values	Description
Setup	0000 - 9999	Sets the passcode for accessing the meter setup screens (Maint > Setup).
Energy Resets	0000 - 9999	Sets the passcode for resetting the meter's accumulated energy values.
Demand Resets	0000 - 9999	Sets the passcode for resetting the meter's recorded peak demand values.
Min/Max Resets	0000 - 9999	Sets the passcode for resetting the meter's recorded minimum and maximum values.
User Acc Resets	0000 - 9999	Sets the passcode for resetting the meter's user accounts.

5. Modify the parameter as required, then press **OK**.
6. Move the cursor to point to the next parameter you want to modify, press **Edit**, make your changes, then press **OK**.
7. Press the up arrow to exit.
8. Press **Yes** to save your changes.

PM5RD device hardware version Ax/Bx support for PM5563 and PM5563RD meter models

The PM5RD device may have one of the following two Hardware (H/W) versions:

- H/W : Ax
 - H/W : Bx
- (x = number)

The PM5563 meter with firmware version older than 2.7.4 supports PM5RD device H/W version Ax only.

The PM5563 and PM5563RD meter models with firmware version 2.7.4 and above (factory-shipped or field-upgraded) supports PM5RD device H/W version Ax or Bx, if the meter is configured accordingly:

- **PM5563 meter without PM5RD device:** You need not make any changes to the configuration.
- **PM5563 meter connected to PM5RD device and the setup is already working:** You need not make any changes to the configuration. This is applicable even after you upgrade the PM5563 meter in this setup from an older firmware version to 2.7.4 and above.
- **PM5563RD meter:** The PM5RD device works with PM5563 meter that is available in the box without the need of any additional configuration for display.
- **PM5563 meter with a separately purchased PM5RD device:** You must follow the below instructions [Configuring PM5563 meter for PM5RD device hardware version](#) to configure.

Configuring PM5563 meter for PM5RD device hardware version

NOTE: Refer to Restoration of temporarily disabled configuration settings in webpages, page 235 to know availability of these features on your meter model.

1. Connect the PM5RD device to PM5563 meter and power-on the meter.

NOTE: If the PM5RD device is operating normally, then the instructions in this section are not applicable until you choose to change the connected PM5RD device to another PM5563 meter. If the connected PM5RD device does not display any content with backlight on, then proceed to next step.

2. Open web browser and enter the meter's IP address in the address box.

3. Enter the **Username** and **Password**.

4. Based on your meter firmware version, click **Diagnostics > Meter Information** OR click **Home > Device Identification**.

If the firmware version is lower than 2.7.4, proceed to Step 5. If the firmware version is 2.7.4 and above, proceed to Step 6.

5. Refer to *Firmware upgrades*, page 209 section under chapter *Maintenance* to upgrade PM5563 meter to latest firmware version (2.7.4 and above).
6. Based on the meter model and firmware version, click **Settings > PM55x3RD Remote Display** OR click **Settings > Communication > PM55x3RD Remote Display**.

The **PM55x3RD Display Settings** window opens.

The default value displayed in the drop-down field indicates the current hardware version setting for the connected PM5RD device. The hardware version information can be found on the label on back side of the PM5RD device. If you need to change the hardware version setting, proceed to next step.



7. Select the appropriate hardware version setting from the drop-down list.

8. After you select the hardware version setting, a warning message displays.
Make sure that you read and understand the message. Select **OK** to proceed or **Cancel** to retain the existing setting.
9. After the new hardware version setting is selected, select **Save changes** or **Apply Changes**. Another warning message displays.
Make sure that you read, understand and follow the instructions to reduce chances of abnormal operation. Select **OK** to proceed or **Cancel** to abort saving changes.
10. Select **OK** to see the new setting on the webpage.
11. Restart the meter for saved changes to take effect, even if display is working after the H/W type change.

Configuring toroid settings for RCM using the display

Applicable only in PM5660 / PM5661 / PM5760 / PM5761 / PM5660L / PM5760L meter models.

You can configure toroid settings for RCM using the display.

1. Navigate to **Maint > Setup**.
2. Enter the setup passcode (default is "0"), then press **OK**.
3. Navigate to **RCM**.
4. Select **I5 Toroid (Turns)** or **I6 Toroid (Turns)** , then press **Edit**.

NOTE: The default toroid turns setting for I5 and I6 is 1000. The **I5 Toroid (Turns)** and **I6 Toroid (Turns)** can be set from 300 to 3000.

5. Modify the parameters as required, then press **OK**.

Toroid turns setting example

Toroid Turns	Residual current measurement starts at (mA)	Measured residual current meets specified accuracy		Primary current through sensor not to exceed (1.5 X Toroid turns) (mA)
		From (0.005 X Toroid turns)* (mA)	To (1.2 X Toroid turns) (mA)	
300	3	5	360	450
600		5	720	900
1000 (Default)		5	1200	1500
1500		7.5	1800	2250
2500		12.5	3000	3750
3000		15	3600	4500

* For toroid sensors with turns less than 1000, the formula is not applicable - measured residual current meets specified accuracy starting from 5 mA.

Cybersecurity

Cybersecurity overview

This chapter contains information about your product's cybersecurity. Network administrators, system integrators and personnel that commission, maintain or dispose of a device should:

- Apply and maintain the device's security capabilities. See "Device security capabilities", page 51 for details.
- Review assumptions about protected environments. See "Protected environment assumptions", page 51 for details.
- Address potential risks and mitigation strategies. See "Potential Risks and compensating controls", page 52 for details.
- Follow recommendations to optimize cybersecurity.

Your device has security capabilities that:

- Allow it to be part of a NERC CIP compliant facility. Go to the North American Electric Reliability Corporation website for information on NERC Reliability Standards.
- Align with cybersecurity standards in the IEC 62443 international standard for business IT systems and Industrial Automation and Control Systems (IACS) products. Go to the International Electrotechnical Commission website for information about the IEC 62443 international standard.

Meters manufactured on and after 1-January-2020 comply with Senate Bill 327 or SB-327 of California connected devices, effective in the state of California from beginning of the year 2020. Go to the https://leginfo.ca.gov/faces/billTextClient.xhtml?bill_id=201720180SB327 website for information about the bill.

To communicate a security topic affecting a Schneider Electric product or solution, go to <http://www.se.com/en/work/support/cybersecurity/vulnerability-policy.jsp>.

⚠ WARNING

POTENTIAL COMPROMISE OF SYSTEM AVAILABILITY, INTEGRITY, AND CONFIDENTIALITY

- Change default passwords/passcodes to help prevent unauthorized access to device settings and information.
- Disable unused ports/services and default accounts, where possible, to minimize pathways for malicious attacks.
- Place networked devices behind multiple layers of cyber defenses (such as firewalls, network segmentation, and network intrusion detection and protection).
- Use cybersecurity best practices (for example: least privilege, separation of duties) to help prevent unauthorized exposure, loss, modification of data and logs, interruption of services, or unintended operation.

Failure to follow these instructions can result in death, serious injury, or equipment damage.

Product defense-in-depth

Use a layered network approach with multiple security and defense controls in your IT and control system to minimize data protection gaps, reduce single-point-of-failure and create a strong cybersecurity posture. The more layers of security in your network, the harder it is to breach defenses, take digital assets or cause disruption.

Device security capabilities

This section describes the security capabilities available with your device.

Information confidentiality

These security capabilities help protect the confidentiality of information through secure protocols that help prevent unauthorized users from reading information in transit.

Physical security

These security capabilities together with perimeter security help prevent unauthorized access to revenue-related parameters and settings or leave clear evidence that the device has been physically tampered with:

- Physical revenue-lock switch on the meter is used to help prevent unauthorized access to the meter, parameter values and settings.
- Meter lock status indicators are used to determine if the meter is revenue locked, i.e. LED lock status indicator on device and revenue lock icon on the display.
- Multiple anti-tamper sealing points are used to help prevent access and leaves evidence of tampering.

See “Revenue locking”, page 225 for details about physically locking and sealing the device.

Configuration

These security capabilities support the analysis of security events, help protect the device from unauthorized alteration and records configuration changes and user account events:

- Internal time synchronization.
- Meter configuration event logging.
- Timestamps, including date and time, match the meter clock.
- Internal FTP site to store files in the meter’s flash memory, such as: webpages, COMTRADE records and firmware files.

User accounts

These security capabilities help enforce authorizations assigned to users, segregation of duties and least privilege:

- User authentication is used to identify and authenticate software processes and devices managing accounts.
- Least privilege configurable in multiple dimensions: read, peak demand reset, time sync, test mode, meter configuration and security communications configuration.
- User account lockout with 5 unsuccessful login attempts.
- Administrators can override user authorizations by deleting their account.

Protected environment assumptions

- Cybersecurity governance – available and up-to-date guidance on governing the use of information and technology assets in your company.

- Perimeter security – installed devices, and devices that are not in service, are in an access-controlled or monitored location.
- Emergency power – the control system provides the capability to switch to and from an emergency power supply without affecting the existing security state or a documented degraded mode.
- Firmware upgrades – meter upgrades are implemented consistently to the current version of firmware.
- Controls against malware – detection, prevention and recovery controls to help protect against malware are implemented and combined with appropriate user awareness.
- Physical network segmentation – the control system provides the capability to:
 - Physically segment control system networks from non-control system networks.
 - Physically segment critical control system networks from non-critical control system networks.
- Logical isolation of critical networks – the control system provides the capability to logically and physically isolate critical control system networks from non-critical control system networks. For example, using VLANs.
- Independence from non-control system networks – the control system provides network services to control system networks, critical or non-critical, without a connection to non-control system networks.
- Encrypt protocol transmissions over all external connections using an encrypted tunnel, TLS wrapper or a similar solution.
- Zone boundary protection – the control system provides the capability to:
 - Manage connections through managed interfaces consisting of appropriate boundary protection devices, such as: proxies, gateways, routers, firewalls and encrypted tunnels.
 - Use an effective architecture, for example, firewalls protecting application gateways residing in a DMZ.
 - Control system boundary protections at any designated alternate processing sites should provide the same levels of protection as that of the primary site, for example, data centers.
- No public internet connectivity – access from the control system to the internet is not recommended. If a remote site connection is needed, for example, encrypt protocol transmissions.
- Resource availability and redundancy – ability to break the connections between different network segments or use duplicate devices in response to an incident.
- Manage communication loads – the control system provides the capability to manage communication loads to mitigate the effects of information flooding types of DoS (Denial of Service) events.
- Control system backup – available and up-to-date backups for recovery from a control system failure.

Potential risks and compensating controls

NOTE: Refer to Restoration of temporarily disabled configuration settings in webpages, page 235 to know availability of these features on your meter model.

Address potential risks using these compensating controls:

Area	Issue	Risk	Compensating controls
User accounts	Default account settings are often the source of unauthorized access by malicious users.	If you do not change the default password, unauthorized access can occur.	Change the default password to help reduce unauthorized access.
Secure protocols	Modbus TCP/IP, EtherNet/IP, BACnet/IP, FTP, HTTP, SNMP, SNTP, SMTP and DNP3 protocols are unsecure. The device does not have the capability to transmit encrypted data using these protocols.	If a malicious user gained access to your network, they could intercept communications.	For transmitting data over an internal network, physically or logically segment the network. For transmitting data over an external network, encrypt protocol transmissions over all external connections using an encrypted tunnel, TLS wrapper or a similar solution.

Data encryption

NOTE: Available only in latest firmware versions:

- PM5560 / PM5562 / PM5563 / PM5580 meter models: 4.0.0 and above
- PM5570 / PM5660 / PM5760 meter models: 6.0.0 and above
- PM5650 meter model: 4.10.0 and above
- PM5561 meter model: 12.0.0 and above
- PM5661 / PM5761 meter models: 14.0.0 and above
- PM5570L / PM5660L / PM5760L meter models: 6.0.0 and above

At Rest

The meter encrypts the user accounts and passwords using SHA-256 and AES-256 cryptography.

The unique key which is dynamically generated during handshake mechanism between server and the web client is used for encryption and decryption. The data that is stored in the meter and configuration settings are not encrypted.

In Transit

The meter uses Transport Layer Security (TLS) 1.2 for an encrypted, authenticated connection using HTTPS between the server and the web clients.

Only self-signed Schneider Electric certificate is configured automatically.

Default settings

NOTE: Refer to Restoration of temporarily disabled configuration settings in webpages, page 235 to know availability of these features on your meter model.

Area	Setting	Default
Communication protocols	Modbus TCP/IP	Enabled
	EtherNet/IP	Enabled
	BACnet/IP	Enabled
	FTP / FTPS*	Disabled
	SNMP	Enabled

Area	Setting	Default
	SNTP	Disabled
	SMTP	Disabled
	DNP3	Disabled
	HTTP / HTTPS*	Enabled
Time and time keeping	Time synchronization	Disabled
Web browser	Webpages	Enabled
Configuration	Using the Display	Enabled
	Using webpages	Enabled
	Using Modbus programming	Enabled

* Available only in latest firmware versions:

- **PM5560 / PM5562 / PM5563 / PM5580 meter models: 4.0.0 and above**
- **PM5570 / PM5660 / PM5760 meter models: 6.0.0 and above**
- **PM5650 meter model: 4.10.0 and above**
- **PM5561 meter model: 12.0.0 and above**
- **PM5661 / PM5761 meter models: 14.0.0 and above**
- **PM5570L / PM5660L / PM5760L meter models: 6.0.0 and above**

User accounts and permissions

Recommendations to optimize cybersecurity in a protected environment:

- Assign users only the essential permissions needed to perform their role.
- Revoke user permissions when no longer needed due to role change, transfer or termination.
- Follow user account management tasks as described by your organization or contact your network administrator.

User account lockout policy

After the 5th consecutive invalid login attempt, the webpage login is locked for 2 minutes. After 2 minutes (expiry), the webpage is unlocked.

Passwords/Passcodes

NOTE: Refer to Restoration of temporarily disabled configuration settings in webpages, page 235 to know availability of these features on your meter model.

Recommendations to optimize cybersecurity in a protected environment:

- Document and store passwords and usernames in a protected location.
- Change the default password/passcode to help reduce unauthorized access. Default account settings are often the source of unauthorized access by malicious users.
- Use complex passwords or passphrases with a minimum length of six characters.
- Follow user account management tasks as described by your organization or contact your network administrator, for example, maximum password age or history policies.

Default passwords/passcodes and user accounts

NOTE: Refer to Restoration of temporarily disabled configuration settings in webpages, page 235 to know availability of these features on your meter model.

Configuration area		Username	Default password/passcode
Display passcode		—	0000 (zero)
For firmware versions: <ul style="list-style-type: none"> PM5560 / PM5562 / PM5563 / PM5580 meter models: 2.9.9 and earlier PM5570 / PM5660 / PM5760 meter models: 3.2.9 and earlier PM5650 meter model: 2.12.9 and earlier PM5561 meter model: 10.9.9 and earlier PM5661 / PM5761 meter models: 11.2.9 and earlier 	Webpages and FTP <ul style="list-style-type: none"> Web master Product master 	user1 user2	pass1 pass2
For firmware versions: <ul style="list-style-type: none"> PM5560 / PM5562 / PM5563 / PM5580 meter models: 4.0.0 and above PM5570 / PM5660 / PM5760 meter models: 6.0.0 and above PM5650 meter model: 4.10.0 and above PM5561 meter model: 12.0.0 and above PM5661 / PM5761 meter models: 14.0.0 and above PM5570L / PM5660L / PM5760L meter models: 6.0.0 and above 	Webpages and FTP/FTPS	Administrator	MAC address which is unique for each meter NOTE: Enter the MAC address of the meter without colon in capital letters (For example: if the MAC address of the meter is 00:80:f4:02:14:38, then password is 0080F4021438). NOTE: Forced to change the default password for system security the first time you log in.
	Webpages	Guest	Powerlogic@1 NOTE: Recommended to change the default password for system security the first time you log in.

Changing passwords/passcodes

NOTE: Refer to Restoration of temporarily disabled configuration settings in webpages, page 235 to know availability of these features on your meter model.

NOTICE
LOSS OF ACCESS Record your device's user and password/passcode information in a secure location. Failure to follow these instructions can result in data loss and loss of access to the device.

NOTICE
LOSS OF DATA OR PRODUCT CONFIGURATION Do not let unauthorized personnel gain physical access to the device. Failure to follow these instructions can result in data loss and loss of access to the device.

Changing display passcode

See Setting up the screen passcodes, page 46 for instructions on how to change the default display passcode.

Changing user account passwords

Based on your firmware version, see [Configuring user accounts for webpages](#), page 63 OR [Changing user account password](#), page 69 for instructions on how to change the default user account password.

Harden the device

NOTE: Refer to [Restoration of temporarily disabled configuration settings in webpages](#), page 235 to know availability of these features on your meter model.

Recommendations to optimize cybersecurity in a protected environment:

- Harden the meter according to your company policies and standards.
- Review assumptions about protected environments and address potential risks and mitigation strategies. See [Product defense-in-depth](#), page 50 for details.
- Logout user account sessions in webpages after usage.
- Limit the number of concurrent user sessions (Refer to table [Protocol, ports, and connections](#), page 73).
- Session lock requires sign in after a minimum time-period of 10 minutes or more of inactivity.

NOTE: Available only in latest firmware versions:

- PM5560 / PM5562 / PM5563 / PM5580 meter models: 4.0.0 and above
- PM5570 / PM5660 / PM5760 meter models: 6.0.0 and above
- PM5650 meter model: 4.10.0 and above
- PM5561 meter model: 12.0.0 and above
- PM5661 / PM5761 meter models: 14.0.0 and above
- PM5570L / PM5660L / PM5760L meter models: 6.0.0 and above
- Change the default passwords/passcodes. See [Changing passwords/passcodes](#), page 55 for details.
- Least functionality can be applied to prohibit and restrict the use of unnecessary functions, protocols and/or services.
- Change the communication protocol ports from their default values. This lowers the predictability of port use.
- Disable communication protocol ports when they are not in use. This reduces the attack surface.

Enabling/Disabling communication protocols and changing port numbers

Changing Ethernet communications using the display

See [Setting up Ethernet communications using the display](#), page 75 for instructions on how to enable/disable HTTP / HTTPS, DPWS, EtherNet/IP and DNP3 settings on your meter.

Changing basic Ethernet settings using the webpages

See [Configuring basic Ethernet settings using the webpages](#), page 77 for instructions on how to change the basic Ethernet settings of your meter.

Changing advanced Ethernet settings using the webpages

See Configuring advanced Ethernet parameters using the webpages, page 77 for instructions on how to change the advanced Ethernet settings of your meter.

Changing BACnet/IP settings using the display

See Configuring BACnet/IP settings using the display, page 85 for instructions on how to change the BACnet/IP settings on your meter.

Changing BACnet/IP settings using the webpages

See Configuring BACnet/IP settings using the webpages, page 86 for instructions on how to change the BACnet/IP settings of your meter.

Enabling/Disabling DNP3 using the display

See Configuring DNP3 setting using the display, page 117 for instructions on how to enable/disable DNP3 on your meter.

Enabling/Disabling DNP3 using the webpages

See Configuring DNP3 setting using the webpages, page 118 for instructions on how to enable/disable DNP3 of your meter.

Enabling/Disabling Modbus TCP/IP filtering using the webpages

See Configuring Modbus TCP/IP filtering using the webpages, page 122 for instructions on how to enable/disable Modbus TCP/IP filtering of your meter.

Changing SNMP settings using the webpages

See Configuring SNMP using the webpages, page 125 for instructions on how to change the SNMP settings of your meter.

Enabling/Disabling FTP / FTPS using the display

See Enabling and disabling the FTP server using the display, page 127 for instructions on how to enable/disable FTP / FTPS on your meter.

Enabling/Disabling FTP / FTPS using the webpages

See Enabling and disabling the FTP server using the webpages, page 128 for instructions on how to enable/disable FTP / FTPS of your meter.

Enabling/Disabling the communication protocols and changing port numbers using the ION Setup

To enable/disable the HTTP / HTTPS, FTP / FTPS, DPWS, SNMP, DNP3, EtherNet/IP and BACnet/IP communication protocols using ION Setup, see the section for your meter in the ION Setup online help or in the ION Setup device configuration guide, available for download at www.se.com.

Reporting a security incident or vulnerability

To report suspicious activity or a cybersecurity incident, go to the Schneider Electric Report an Incident website.

To report a security vulnerability affecting your product or solution, go to the Schneider Electric Report a Vulnerability website.

Firmware upgrades

When meter firmware is upgraded – security configuration remains the same until changed, including usernames and passwords/passcodes. It is recommended to review security configuration after an upgrade to analyze privileges for new or changed device features and revoke or apply them according to your company policies and standards.

See Firmware upgrades, page 209 for information about firmware upgrades.

Secure disposal guidelines

Use the *Secure disposal checklist* when disposing a meter to help prevent potential disclosure of data.

Secure disposal checklist

- **Record activities:** Document disposal actions according to your company policies and standards to keep a record of activities.
- **Decommission related rules and sanitize records:**
 - Follow decommission and sanitization tasks as described by your organization or contact your network administrator.
 - Decommission network and security rules, e.g. a firewall rule that could be used to get past the firewall.
 - Perform records tracking sanitization tasks to remove records in related systems, e.g. monitoring SNMP servers.
- **Disposal and reuse:** See Disposal, reuse, recycling, page 58 for more information.

Disposal, reuse, recycling

Before removing the device from its intended environment, follow the *Secure disposal guidelines* in this document.

Follow device removal tasks described by your organization or contact your network administrator to determine a responsible method of disposal.

Dispose the device according to the legislation of the country. Some regulatory organizations include:

- The United States Environmental Protection Agency (EPA) for guidance on the sustainable management of electronics.
 - The EPA provides an Electronic Product Environmental Assessment Tool (EPEAT) that helps assess the environmental attributes of electronics.
- The European Waste Electrical & Electronic Equipment Directive (WEEE Directive) is the Community directive on Waste Electrical and Electronic Equipment.

- The European Restriction of Hazardous Substances Directive (RoHS) directive on the restriction of the use of certain hazardous substances in electrical and electronic equipment.

NOTICE

UNAUTHORIZED OR UNINTENDED ACCESS TO CONFIDENTIAL DATA

- Store devices that are not in service in an access-controlled or monitored location.
- Physically destroy devices that are decommissioned.

Failure to follow these instructions can result in unauthorized or unintended access to sensitive or secure customer data.

Device disposal

It is recommended that the entire device is physically destroyed. Destroying the device helps prevent potential disclosure of data contained in the device that was not removed.

Device reuse

Store the device in a location that is access controlled or monitored if there is potential for reuse.

Device recycling

Go to www.se.com and search for the Product Environmental Profile for your meter type to get instructions on managing e-waste.

Webpages

Webpages (Legacy)

Applicability

This section is only applicable for the meter models and their firmware versions as shown in the table:

Meter models	Firmware version
PM5560 / PM5562 / PM5563 / PM5580	2.9.9 and earlier
PM5570 / PM5660 / PM5760	3.2.9 and earlier
PM5650	2.12.9 and earlier
PM5561	10.9.9 and earlier
PM5661 / PM5761	11.2.9 and earlier

Webpages overview

The meter's Ethernet connection allows you to access the meter so you can view data and perform some basic configuration and data export tasks using a web browser.

The recommended browsers to use for viewing the webpages from the meter are Microsoft Edge, Google Chrome, Mozilla Firefox, and Apple Safari.

⚠ WARNING

INACCURATE DATA RESULTS

- Do not rely solely on data displayed on the display or in software to determine if this device is functioning correctly or complying with all applicable standards.
- Do not use data displayed on the display or in software as a substitute for proper workplace practices or equipment maintenance.

Failure to follow these instructions can result in death, serious injury, or equipment damage.

Webpages interface

Your meter comes with default webpages.

The graphic below is a representative sample that shows the typical elements. Your meter's webpages may appear differently than shown.

A	Meter brand and model	D	Webpage menu
B	Username	E	Webpage content
C	Main menus	F	Show/hide toggle

Accessing the meter webpages

NOTE: Refer to Restoration of temporarily disabled configuration settings in webpages, page 235 to know availability of these features on your meter model.

Access the meter’s webpages to view data and perform basic configuration and data export tasks using a web browser.

The webpages are accessed through the meter’s Ethernet port so it must be configured properly.

1. Open web browser and enter the meter’s IP address in the address box.
2. Enter your **Username** and **Password**.
The **Username** and **Password** for the default user accounts are **user1 / pass1** and **user2 / pass2**.
3. Use the menus and tabs to select and display the meter's various webpages.
4. Click the up / down arrows to show and hide sections of the webpages and menus.
5. Click **Logout** to exit the meter webpages.

Default webpages

The meter has a comprehensive set of default webpages that enable you to view basic energy and power quality values, I/O and alarm information, and data and maintenance logs.

In addition, you can use the webpages to configure a variety of settings.

Monitoring

This tab allows you to navigate to the following webpages:

Webpage	Description
Basic Readings	<ul style="list-style-type: none"> Basic readings such as Load Current, Power and Voltage in gauge and table display. Demand current and demand power values, including last, present and peak. Accumulated energy values and the date/time of the last reset.
Residual Current*	Displays the instantaneous residual current measurement values.
Power Quality	THD and unbalance values for current and voltage.
Active Alarms ¹	This is a list of active (unacknowledged) alarm events with a date/timestamp for each event, the value that triggered the alarm (e.g., pickup) and a description of the event type.
Alarm History ¹	This is a historical list of (acknowledged) alarm events with a date/timestamp for each event, the value that triggered the alarm (e.g., pickup) and a description of the event type.
Inputs/Outputs*	Displays the current status of the digital inputs/outputs and analog inputs.
Data Log	A list of timestamped data recorded in the meter's data log (energy delivered in Wh, VARh and VAh).
Waveforms*	Displays the waveform capture records caused due to sag/swell events.

*Available in specific meter models. Refer to Features differentiation matrix for PM5500 / PM5600 / PM5700 series, page 20 for the availability.

Diagnostics

This tab allows you to view the following webpages:

Webpage	Description
Meter Information	Displays the meter model, serial number and manufacture date in addition to information on the version numbers of the installed firmware (OS, RS, Ethernet, Language and FPGA)
Communications ²	<p>Contains diagnostics information for Ethernet, HTTP server, HTTP client, Modbus server and SMTP server to aid in troubleshooting communications.</p> <p>Displays the meter's current time and the meter's last boot time.</p>
Registers	Allows you to read a specified block of Modbus registers from the meter or from a slave device when the meter is acting as a gateway.

Maintenance

This tab allows you to view the Maintenance Log webpage.

The Maintenance Log page displays a record of meter events, and in particular, changes to meter setup. Each event is date/timestamped. The **Event Type** field provides a brief description of what changed and the **Event Cause** specifies what triggered the event.

Setting the measurement range for basic parameters

NOTE: Refer to Restoration of temporarily disabled configuration settings in webpages, page 235 to know availability of these features on your meter model.

You can set the ranges that appear on the gauges that display on the **Basic Readings** webpage.

You must login as a web master or product master to change the ranges.

1. Click **Set Range**.

1. Click the event number to display additional details about the alarm, for example, the actual pickup or dropout value and which phase the alarm condition occurred
 2. Click **Reset** to clear the stored information on this page.

2. Set the ranges for the gauges:
 - Type the minimum and maximum ratings (limits) for current, power and voltage (L-L and L-N), or
 - Set **Enable Auto Scale** to automatically set the scale on the gauges.
3. Click **Save Changes**.

User accounts

Default login accounts

NOTE: Refer to Restoration of temporarily disabled configuration settings in webpages, page 235 to know availability of these features on your meter model.

The meter has a set of default login credentials to access the webpages and FTP server.

The following login credentials are configured by default:

Username	Password	User group
user1	pass1	Web Master
user2	pass2	Product Master

In a continuous effort to encourage users on the awareness about the cybersecurity best practices and the meters more cyber secure in their applications, it is recommended for the users to change the default factory-set password to a complex password.

User groups

NOTE: Refer to Restoration of temporarily disabled configuration settings in webpages, page 235 to know availability of these features on your meter model.

Webpages and FTP server access permissions are based on user groups.

User group	Access
Web user	Users in this group can view all information that is displayed on the webpages. In addition, a web user can view most device settings available through the webpages (except user accounts) but cannot change them.
Web master	Users in this group can view all information that is displayed on the webpages. In addition, a web master can change device settings available on the webpages but cannot see or edit user accounts.
Product master	Users in this group can view all information that is displayed on the webpages. In addition, a product master can change device settings available on the webpages, including user accounts. The product master can also access the meter using the FTP server.

Configuring user accounts for webpages

NOTE: Refer to Restoration of temporarily disabled configuration settings in webpages, page 235 to know availability of these features on your meter model.

You can setup user accounts for access to the meter’s data using the webpages or FTP, assign users to a group that determines what each user can access, and set the webpage display language for each user.

You must be logged in as a Product Master to configure user accounts.

NOTE: If you lose your meter's webpage user access information, contact Technical Support.

1. Click **Settings > User Accounts**.
2. Configure the parameters as appropriate for each user.
3. Click **Save changes** to send and save the new settings to the meter.

User account settings available using the webpages

Parameter	Description
Name	Lists the current usernames for accessing the meter. You can add a new user by typing the username in a blank cell. To remove an existing user, select the name and press DELETE on your keyboard.
Password ³	Lists the current password associated with each user. After adding a new username, type a password to associate it with the username. As you enter characters for your password, the status bar changes to indicate the password strength (weak, medium, strong or very strong). Re-type the password in the Confirm Password field.
Group	Select the group the username belongs to: <ul style="list-style-type: none"> • Web User • Web Master • Product Master NOTE: You must have at least one Web Master and one Product Master. User 1 must be a Web Master and user 2 must be a Product Master.
Language	Select the language the webpages are displayed in for the selected username.

Reading device registers using the webpages

You can use the webpages to read a specified block of Modbus registers from the meter or from a slave device when the meter is acting as a gateway.

1. Navigate to **Diagnostics > Registers > Read Device Registers**.
2. Type the address of the device you want to read in the **Device ID** field.
3. Enter values in the **Starting Register** and **Number of Registers** fields.
4. Select data format of the registers you want to read from the **Data Type** field.
5. Select the number format that you want to display the value of the registers in: Decimal, Hexadecimal, Binary, ASCII or Float.
6. Click **Read**.

Go to www.se.com and search for your meter's Modbus register list to download a copy.

Webpages (New)

Applicability

This section is only applicable for the meter models and their firmware versions as shown in the table:

Meter models	Firmware version
PM5560 / PM5562 / PM5563 / PM5580	4.0.0 and above
PM5570 / PM5660 / PM5760	6.0.0 and above

3. Always record changes or additions to the username and password list and store the list in a safe place.

Meter models	Firmware version
PM5650	4.10.0 and above
PM5561	12.0.0 and above
PM5661 / PM5761	14.0.0 and above
PM5570L / PM5660L / PM5760L	6.0.0 and above

Webpages overview

The meter’s Ethernet connection allows you to access the meter so you can view data and perform some basic configuration and data export tasks using a web browser.

The recommended browsers to use for viewing the webpages from the meter are Microsoft Edge, Google Chrome, Mozilla Firefox, and Apple Safari.

⚠ WARNING

INACCURATE DATA RESULTS

- Do not rely solely on data displayed on the display or in software to determine if this device is functioning correctly or complying with all applicable standards.
- Do not use data displayed on the display or in software as a substitute for proper workplace practices or equipment maintenance.

Failure to follow these instructions can result in death, serious injury, or equipment damage.

Webpages interface

Your meter comes with default webpages.

The graphic below is a representative sample that shows the typical elements. Your meter’s webpages may appear differently than shown.

The screenshot shows the PowerLogic™ PM5560 web interface. At the top left is the logo and model name. A navigation bar contains links for Home, Monitoring, Diagnostics, Maintenance, and Settings. The main content area is titled 'General Monitoring' and features a sidebar menu with options like Basic Readings, Power Quality, and Active Alarms. The central display shows a table of 'Basic' parameters with columns for Parameter, Minimum, Present, and Maximum. The table lists Load Current (A) for phases Ia, Ib, Ic, In, Ig, and I Avg, as well as Power (Real, Reactive, Apparent) and Voltage (Vab, Vbc). A legend at the bottom identifies labels A through E on the interface: A (Meter brand and model), B (Username), C (Main menus), D (Webpage menu), and E (Webpage content).

Parameter	Minimum	Present	Maximum
Load Current(A)			
Ia	0.00	0.00	0.00
Ib	0.00	0.00	0.00
Ic	0.00	0.00	0.00
In	0.00	0.00	0.00
Ig	0.00	0.00	0.00
I Avg	0.00	0.00	0.00
Power			
Real(KW)	0.00	0.00	0.00
Reactive (KVAR)	0.00	0.00	0.00
Apparent (KVA)	0.00	0.00	0.00
Power Factor Total	---	---	---
Voltage			
Vab	0.00	0.00	0.00
Vbc	0.00	0.00	0.00
---	---	---	---

A	Meter brand and model	D	Webpage menu
B	Username	E	Webpage content
C	Main menus		

Accessing the meter webpages

NOTE:

- The webpages are accessed through the meter's Ethernet port so it must be configured properly.
- It is mandatory to change the default password when you access the webpages for the first time. You cannot browse through the webpages without the default password change.
- The password must contain between 8 and 16 characters with at least 1 number, 1 capital letter and 1 special character.

1. Open a web browser and enter the meter's IP address in the address box.
2. Enter the **Username** (default: **Administrator**) and **Password** (default: MAC address which is unique for each meter).

NOTE: Enter the MAC address of the meter without colon in capital letters (For example: if the MAC address of the meter is 00:80:f4:02:14:38, then password is 0080F4021438).

▲ WARNING

POTENTIAL COMPROMISE OF SYSTEM AVAILABILITY, INTEGRITY, AND CONFIDENTIALITY

Recommended to change the default password.

Failure to follow these instructions can result in unauthorized personnel accessing the web pages.

3. Click **Login**.
4. Use the menus and tabs to select and display the meter's various webpages.

NOTE: If the user session is inactive for a period of 10 minutes or more, the session gets timed-out and you need to re-login to access the webpages.
5. Click **Logout** to exit the meter webpages.

Default webpages

The meter has a comprehensive set of default webpages that enable you to view basic energy and power quality values, I/O and alarm information, and data and maintenance logs.

In addition, you can use the webpages to configure a variety of settings.

Home

This is the default tab when you access the meter webpages. This tab allows you to view the **Device Identification** parameters as shown in the following table:

Parameter	Description
OEM Name	Name of the Original Equipment Manufacturer (OEM) Schneider Electric
OEM URL	URL link of the OEM www.se.com
Firmware Version	Existing firmware version including OS (Operating System), RS (Reset System), language version and communication card version
FPGA Version	Existing FPGA version

Parameter	Description
Product Range	Name of the device type
Product Model	Device model number
Serial Number	Device serial number
Manufacturing Date & Time	Date and time when the device was manufactured

Monitoring

This tab allows you to navigate to the following menus to view the webpage content:

Webpage menu	Description
Basic Readings	<ul style="list-style-type: none"> Basic readings such as load current, power, power factor total, voltage and frequency(Hz). Demand current (A) and demand power values, including last, present and peak along with the date time at peak and date time of the last reset. Accumulated energy values and the date time of the last reset.
Residual Current*	Displays the instantaneous residual current measurement values.
Power Quality	THD and unbalance values for current and voltage.
Active Alarms	List of active (unacknowledged) alarm events with the date and timestamp for each event, the value that triggered the alarm (e.g., pickup) and a description of the event type. NOTE: You can click the Update button to refresh the active alarms list.
Alarm History	Historical list of (acknowledged) alarm events with the date and timestamp for each event, the value that triggered the alarm (e.g., pickup) and a description of the event type. NOTE: You can click the Update button to refresh the alarm history list.
Inputs/Outputs*	Displays the current status of the digital inputs/outputs and analog inputs.
Data Log	A list of timestamps data recorded in the meter's data log (energy delivered in kWh, kVARh and kVAh). NOTE: You can click the Update button to refresh the data log list.
Waveforms*	Displays the waveform capture records caused due to sag/swell events.

*Available in specific meter models. Refer to Features differentiation matrix for PM5500 / PM5600 / PM5700 series, page 20 for the availability.

Diagnostics

This tab allows you to view the following webpages:

Webpage menu	Webpage submenu	Description
General	Date/Time	Displays the meter's current date, time and the meter's last boot time.
	Meter Status	Displays the meter diagnostics status.
Communication	Ethernet	Displays the Ethernet global statistics. NOTE: You can click the Reset button to reset the Ethernet global statistics.
	IP Network Services	Displays the Modbus TCP port and SMTP client statistics. NOTE: You can click the Reset button to reset the Modbus TCP port and SMTP client statistics.
	Read Device Registers	Allows you to read a specified block of Modbus registers from the meter or from a slave device when the meter is acting as a gateway.

Maintenance

This tab allows you to view the following webpages:

Webpage menu	Webpage submenu	Description
Maintenance Log	Maintenance Log	Displays the maintenance log parameters with record of meter events, and in particular, changes to the meter setup. Each event is date and timestamped. The Event Type field provides a brief description of what changed and the Event Cause specifies what triggered the event. NOTE: Click the Update button to refresh the maintenance log list. You can also click the Next 10 Records or Previous 10 Records to check the maintenance log records.
Upgrade	Firmware	Allows you to upgrade firmware for your meter (Refer to Firmware upgrade using webpages, page 214).
	Upgrade Status	Displays the last firmware upgrade status of the meter.

Settings

This tab allows you to view the following webpages:

Webpage menu	Webpage submenu	Description
Security	Product Certificate	Displays the product certificate details. Allows you to create self-signed certificate of the product. NOTE: You need to re-login to the webpages to view the changes applied (create certificate changes).
Communication	Serial Port Configuration	Allows you to configure serial port and advanced serial port settings.
	Ethernet Settings	Allows you to configure Ethernet settings.
	Advanced Ethernet Settings	Allows you to configure the advanced Ethernet, FTPS and HTTPS settings.
	Date Time Settings	Allows you to configure time synchronization and time settings manually.
	IP Filtering	Allows you to set the level of access for each configured IP address, as well as for anonymous IP addresses. NOTE: By default, the Enable Filtering option is disabled.
	DPWS Settings	Allows you to enable or disable DPWS.
	SNMP Settings	Allows you to configure the SNMP and SNMP trap parameters.
	DNP3 Settings	Allows you to enable or disable DNP3.
	EtherNet/IP Settings	Allows you to enable or disable EtherNet/IP.
	BACnet/IP Settings	Allows you to configure BACnet/IP settings.
	Email On Alarm Settings	Allows you to configure the Email on alarm settings.
	PM55x3RD Remote Display*	Allows you to configure PM5563 meter with PM5RD device hardware version.
User Management	User Accounts	Allows you to add user accounts, delete user accounts, reset user account password, assign user role, and terminate user account sessions.

Webpage menu	Webpage submenu	Description
	Warning Banner	<p>Allows you to configure the warning message (maximum up to 450 characters) appearing on your login screen.</p> <p>NOTE: The warning banner configured for the language can only be seen for that respective language on the login screen of the webpage. Other languages will have the default warning banner "This application is protected by copyright law and international treaties".</p>

*Available only in PM5563 meter model.

User accounts

The meter users are assigned with usernames and passwords. Each user is assigned with a role to access the webpages by the administrator.

There are two pre-defined user accounts:

- Administrator** (default password is MAC address which is unique for each meter)

NOTE: Enter the MAC address of the meter without colon in capital letters (For example: if the MAC address of the meter is 00:80:f4:02:14:38, then password is 0080F4021438).
- Guest** (default password is **Powerlogic@1**)

⚠ WARNING
<p>POTENTIAL COMPROMISE OF SYSTEM AVAILABILITY, INTEGRITY, AND CONFIDENTIALITY</p> <ul style="list-style-type: none"> Change default passwords at first use to help prevent unauthorized access to device settings, controls, and information. <p>Failure to follow these instructions can result in death, serious injury, or equipment damage.</p>

In a continuous effort to encourage users on the awareness about the cybersecurity best practices and the meters more cyber secure in their applications, the users are forced to change the default factory-set password to a complex password.

Changing user account password

NOTE: When you change your user account password, the user sessions get terminated and you need to re-login to access the webpages.

NOTICE
<p>LOSS OF ACCESS</p> <p>Record your device's user and password information in a secure location.</p> <p>Failure to follow these instructions can result in data loss and loss of access to the device.</p>

NOTICE
<p>LOSS OF DATA OR PRODUCT CONFIGURATION</p> <p>Do not let unauthorized personnel gain physical access to the device.</p> <p>Failure to follow these instructions can result in data loss and loss of access to the device.</p>

1. Click the user account on the top right corner of the webpage.
2. Click **Change Password** button.
The **Password Modification** window opens.
3. Enter the **Old Password**, new **Password** and **Confirm Password**.
NOTE: The password must contain between 8 and 16 characters with at least 1 number, 1 capital letter and 1 special character.
4. Click **Apply Changes** to save your new password.

Roles

Webpages access permissions are based on roles. You must be an administrator to assign user access roles.

User account	Password	Role	Access
Administrator	MAC address which is unique for each meter NOTE: Enter the MAC address of the meter without colon in capital letters (For example: if the MAC address of the meter is 00:80:f4:02:14:38, then password is 0080F4021438).	Administrator	Full access to all webpages and its features with read/write permission. NOTE: Forced to change the default password for system security the first time you log in.
Guest	Powerlogic@1	Guest	Read only access to Home, Monitoring, Diagnostics and Maintenance tabs to view or monitor the data. NOTE: <ul style="list-style-type: none"> • Recommended to change the default password for system security the first time you log in. • No modify access to Firmware Upgrade and Settings

Adding user accounts for webpages

In addition to the **two default** user accounts, you can create up to **4** user accounts.

NOTE:

- If the **Username** or **Password** credentials of the **Administrator** user account are lost, you can reset using another **Administrator** user account.
 - You can reset the webpage user account via meter HMI, if the **Username** or **Password** credentials of the **Administrator** user account are lost (Refer to Performing user account resets using the display, page 150).
1. Click **Settings > User Management > User Accounts**.
 2. In the **User Accounts** section, click **Add User**.
The **Add User** section opens.
 3. Enter the **Username, Password** details and assign the user a **Role**.

4. Click **Apply Changes** to save your changes to the meter.

Parameter	Description
Username	Enter a name (1 to 15 characters) for a new user. NOTE: Username is case-sensitive and can contain special characters.
Password	Enter a password (8 to 16 characters) for a new user. NOTE: The password must contain between 8 and 16 characters with at least 1 number, 1 capital letter and 1 special character.
Confirm Password	Confirm the password.
Role • Administrator • Guest	Assign a role for the user.

Deleting user account

NOTE: You must have **Administrator** role access to delete the user accounts.

1. Click **Settings > User Management > User Accounts**.
2. In the **User Accounts** section, click  icon.
The **User Deletion** dialog box opens.
3. Click **Yes** to delete the user account.

Edit user account details

NOTE: You must have **Administrator** role access to change the user account password and assign role to the user:

1. **User account password reset:**
 - a. Click **Settings > User Management > User Accounts**.
 - b. In the **User Accounts** section, click  icon.
The **Edit User** section opens.
 - c. Enter the **New Password** and **Confirm Password** details.
NOTE: The password must contain between 8 and 16 characters with at least 1 number, 1 capital letter and 1 special character.
 - d. Click **Apply Changes** to save your changes to the meter.
2. **Assigning user role:**

NOTE: To assign role to the user, you must also reset the password.

 - a. Click **Settings > User Management > User Accounts**.
 - b. In the **User Accounts** section, click  icon.
The **Edit User** section opens.
 - c. From the drop-down list, assign the **Role** to the user.
 - d. Enter the **New Password** and **Confirm Password** details.
NOTE: The password must contain between 8 and 16 characters with at least 1 number, 1 capital letter and 1 special character.
 - e. Click **Apply Changes** to save your changes to the meter.

Terminating user account sessions

NOTE: You must have **Administrator** role access to terminate the user account sessions.

1. Click **Settings > User Management > User Accounts**.
2. In the **User Accounts** section, click  icon.
The **Terminate User Sessions** dialog box opens with the warning message “**Are you sure you want to terminate sessions ? This will terminate all active sessions for the user**”.
3. Read the warning message and click **Yes** to terminate the user account sessions.

Reading device registers using the webpages

You can use the webpages to read a specified block of Modbus registers from the meter or from a slave device when the meter is acting as a gateway.

1. Navigate to **Diagnostics > Communication > Read Device Registers**.
2. Type the address of the device you want to read in the **Device ID** field.
3. Enter values in the **Starting Register** and **Number of Registers** fields.
4. Select the data format of the registers from the **Data Type** field that you want to read in: **Holding Registers, Input Registers, Output Coils, Input Coils**.
5. Select the number format from the **Display Option** field that you want to display the value of the registers in: **Decimal, Hexadecimal, Binary, ASCII** or **Float**.
6. Click **Read**.

Communications

Ethernet communications

The meter supports Modbus TCP, BACnet/IP, EtherNet/IP, HTTP / HTTPS⁴, SNMP, SMTP, FTP / FTPS⁴, DNP3 protocols and can communicate at data speeds up to 100 Mbps through its Ethernet communications port.

The meter supports a single IP address between two 10/100Base-T Ethernet ports. The second Ethernet port functions as an Ethernet switch, which allows you to have shorter Ethernet cable runs between the meters without requiring additional Ethernet routers or repeaters. This helps simplify network connections and reduce installation time and costs.

The meter supports a maximum of 128 concurrent TCP/IP connections, that are shared between HTTP / HTTPS⁴, FTP / FTPS⁴, Modbus TCP and other TCP/IP protocols.

The meter supports a maximum of three concurrent connections (sessions) using the DNP3 protocol.

Protocol, ports, and connections

Protocol	Port (Default)	Number of connections
Modbus TCP	502	32
HTTP	80	3 per IP
HTTPS	443	3 per IP
FTP	21	3
FTPS	990	3
DHCP	67	3 per IP
BOOTp	67	3 per IP
BACnet/IP	47808	N/A
EtherNet/IP	44818	32
DNP3	20000	3
SNTP	123	1
SNMP	161	N/A
SMTP	25	1

Ethernet configuration

In order to use Ethernet communications, you must configure your device's IP address; you must also configure the subnet and gateway information if required by your network.

NOTE: For meters that do not have a display, you must configure each one separately in order to set a unique IP address for each device.

You need to enter network information for any Ethernet servers used by the device.

4. Available only in latest firmware versions:
 - PM5560 / PM5562 / PM5563 / PM5580 meter models: 4.0.0 and above
 - PM5570 / PM5660 / PM5760 meter models: 6.0.0 and above
 - PM5650 meter model: 4.10.0 and above
 - PM5561 meter model: 12.0.0 and above
 - PM5661 / PM5761 meter models: 14.0.0 and above
 - PM5570L / PM5660L / PM5760L meter models: 6.0.0 and above

NOTE: Contact your network system administrator for your IP address and other Ethernet network configuration values.

Configure your device's Ethernet settings by using the display or directly connecting to your meter and using a web browser to access the device's webpages. Modify your meter's Ethernet settings to those provided by your network system administrator before connecting the device to your local area network (LAN).

After the meter's Ethernet port is configured and connected to the LAN, you can use ION Setup to configure other meter setup parameters.

Ethernet port setup

NOTE: Refer to Restoration of temporarily disabled configuration settings in webpages, page 235 to know availability of these features on your meter model.

The meter is factory-configured with default Ethernet communications settings.

You must modify the default Ethernet settings before connecting the meter to your local area network (LAN) using the meter webpages.

The default Ethernet communications settings are:

- IP method = Stored
- IP address = 169.254.0.10
- Subnet mask = 255.255.0.0
- Gateway = 0.0.0.0
- HTTP server = Enabled
- DPWS = Enabled
- EtherNet/IP = Enabled
- DNP3 = Disabled
- MAC = 00:80:67:8A:F6:64
- Device name = PM55-#xxxxxxxxxx, where xxxxxxxxxxxx is the meter's factory serial number (with leading zeros if serial number is less than 10 characters)

NOTE: Your meter's serial communications port ID (**Com1 ID**) is used in both Ethernet and serial communications; you need to change the **Com1 ID** meter property in ION Setup if you modify the meter's RS-485 address.

Performing initial Ethernet configuration using the webpages

NOTE: Refer to Restoration of temporarily disabled configuration settings in webpages, page 235 to know availability of these features on your meter model.

The meter is factory-configured with default Ethernet settings, which you must change before connecting the meter to your network.

For meters with a display, you can configure basic Ethernet settings using the display. If you want to use Ethernet to communicate to meters without a display, you need to perform the following steps to configure basic Ethernet settings before you connect the meter to your network.

1. Disconnect your computer from the network. If your computer has wireless communications, make sure you disable the wireless network connection as well.

NOTE: After you disconnect your computer from the network, its IP address should automatically update to a default IP address of 169.254.###.### (where ### equals a number from 0 to 255) and a subnet mask of 255.255.0.0. If your computer does not automatically update after several minutes, contact your network administrator to set up a static IP address.

2. Use an Ethernet cable to connect the computer to one of the meter’s Ethernet ports.
3. Open web browser and enter the meter’s IP address in the address box.
4. Enter the **Username** and **Password**.
5. Based on your meter firmware version, click **Settings > Ethernet Settings** OR click **Settings > Communication > Ethernet Settings**.
6. Modify the Ethernet setup parameters with the settings your system administrator assigned for the meter.

Parameter	Description
MAC Address	Displays the meter’s factory-programmed MAC address. This information is read-only and cannot be changed.
IP Address Acquisition Mode	This controls the network protocol for your device (which the meter uses to obtain its IP address): <ul style="list-style-type: none"> • DHCP: Dynamic Host Configuration Protocol • BOOTp: Bootstrap Protocol • Stored: The static value programmed in the IP Address setup register • Default: Use 85.16 as the first two values of the IP address, then convert the last two hexadecimal values of the MAC address to decimal and use this as the last two values of the IP address Example: MAC address = 00:80:67:82:B8:C8 Default IP address = 85.16.184.200
IP Address	The Internet protocol address of your device.
Subnet Mask	The Ethernet IP subnetwork address of your network.
Default Gateway	The Ethernet IP gateway address of your network.

7. Click **Save changes** or **Apply Changes** to send and save the new settings to the meter.
8. Click **Logout** to exit the meter’s webpages.
9. Re-establish the computer’s connection to your LAN (plug the computer’s Ethernet cable back to your LAN connection or re-enable wireless communications to the LAN).

Setting up Ethernet communications using the display

The Ethernet setup screen allows you to assign the meter a unique IP address so you can use software to access the meter’s data or configure the meter remotely through the Ethernet port.

Before configuring the Ethernet parameters, make sure you obtain your meter’s IP address information from your network administrator or IT department.

1. Navigate to **Maint > Setup**.
2. Enter the setup passcode (default is “0”), then press **OK**.
3. Navigate to **Comm > Enet**.
4. Move the cursor to point to the parameter you want to modify, then press **Edit**.
5. Modify the parameter as required, then press **OK**.
6. Move the cursor to point to the next parameter you want to modify, press **Edit**, make your changes, then press **OK**.
7. Press the up arrow to exit.

8. Press **Yes** to save your changes.

Parameter	Values	Description
IP Method	Stored, Default, DHCP, BOOTP	This controls the network protocol for your device (what the meter uses to obtain its IP address). Stored: Use the static value programmed in the IP Address setup register Default: Use 85.16 as the first two values of the IP address, then convert the last two hexadecimal values of the MAC address to decimal and use this as the last two values of the IP address. Example: MAC address = 00:80:67:82:B8:C8 Default IP = 85.16.184.200 DHCP: Dynamic Host Configuration Protocol BOOTP: Bootstrap Protocol
IP Address	Contact your local network administrator for parameter values.	The Internet protocol address of your device.
Subnet	Contact your local network administrator for parameter values.	The Ethernet IP subnetwork address of your network (subnet mask).
Gateway	Contact your local network administrator for parameter values.	The Ethernet IP gateway address of your network.
HTTP Server / HTTPS Server***	Enabled, Disabled	Controls whether your device's webserver and webpages are active or not.
FTP	Enabled, Disabled	Allows you to enable or disable FTP (Auto-disables if idle for 20 minutes)**
DPWS	Enabled, Disabled	Allows you to enable or disable DPWS
EtherNet/IP	Enabled, Disabled	Allows you to enable or disable EtherNet/IP
DNP3*	Enabled, Disabled	Allows you to enable or disable DNP3
MAC	00:80:67:8A:F6:64	Displays the meter's factory-programmed MAC address. This information is read-only and cannot be changed. *** This can be used as a DNS entry that maps the MAC address to the IP address assigned by the DHCP server.
Device Name	(see description)	This is the meter's device name and is factory set to PM55-#xxx (where xxx is the serial number of the meter). This can be used as a DNS entry that maps the device name to the IP address assigned by the DHCP server.

*Available in specific meter models. Refer to Features differentiation matrix for PM5500 / PM5600 / PM5700 series, page 20 for the availability.

**Refer to Restoration of temporarily disabled configuration settings in webpages, page 235 to know availability of these features on your meter model.

***Available only in latest firmware versions:

- PM5560 / PM5562 / PM5563 / PM5580 meter models: 4.0.0 and above
- PM5570 / PM5660 / PM5760 meter models: 6.0.0 and above
- PM5650 meter model: 4.10.0 and above
- PM5561 meter model: 12.0.0 and above
- PM5661 / PM5761 meter models: 14.0.0 and above
- PM5570L / PM5660L / PM5760L meter models: 6.0.0 and above

NOTE:

An exclamation mark beside the IP address can indicate:

- that the IP address is being programmed. Wait a few seconds for the IP address to appear to confirm that it is programmed.
- that there is a problem with the network. Check with your system administrator for network issues.

Configuring basic Ethernet settings using the webpages

NOTE: Refer to Restoration of temporarily disabled configuration settings in webpages, page 235 to know availability of these features on your meter model.

You can use the meter’s webpages to configure Ethernet settings.

1. Login to the meter webpages.
2. Based on your meter firmware version, click **Settings > Ethernet Settings** OR click **Settings > Communication > Ethernet Settings**.
3. Modify the Ethernet setup parameters as required.
4. Click **Save changes** or **Apply Changes** to send and save the new settings to the meter.

Parameter	Description
MAC Address	Displays the meter’s factory-programmed MAC address. This information is read-only and cannot be changed.
IP Address Acquisition Mode	This controls the network protocol for your device (which the meter uses to obtain its IP address): <ul style="list-style-type: none"> • DHCP: Dynamic Host Configuration Protocol <p>NOTE: Fully qualified domain names are not supported. The device name / MAC address* is not automatically sent to a DNS server when a DHCP request is sent. In order to use device name / MAC address* instead of IP address, your IT administrator must manually add the device name / MAC address* to the DNS.</p> • BOOTp: Bootstrap Protocol • Stored: The static value you programmed in the IP Address setup register • Default: Uses 85.16 as the first two values of the IP address, then converts the last two hexadecimal values of the MAC address to decimal and uses this as the last two values of the IP address. Example: MAC address = 00:80:67:82:B8:C8, default IP = 85.16.184.200
IP Address	The Internet protocol address of your device.
Subnet Mask	The Ethernet IP subnetwork address of your network (subnet mask).
Default Gateway	The Ethernet IP gateway address of your network.

*Available only in latest firmware versions:

- PM5560 / PM5562 / PM5563 / PM5580 meter models: 4.0.0 and above
- PM5570 / PM5660 / PM5760 meter models: 6.0.0 and above
- PM5650 meter model: 4.10.0 and above
- PM5561 meter model: 12.0.0 and above
- PM5661 / PM5761 meter models: 14.0.0 and above
- PM5570L / PM5660L / PM5760L meter models: 6.0.0 and above

Configuring advanced Ethernet parameters using the webpages

NOTE: Refer to Restoration of temporarily disabled configuration settings in webpages, page 235 to know availability of these features on your meter model.

You can configure advanced Ethernet parameters, such as TCP keepalive, connection timeouts and idle times, using the Advanced Ethernet Settings webpage.

1. Login to the meter webpages.
2. Based on your meter firmware version, click **Settings > Advanced Ethernet Settings** OR click **Settings > Communication > Advanced Ethernet Settings**.
3. Modify the Ethernet setup parameters as required.

4. Click **Save changes** or **Apply Changes** to send and save the new settings to the meter.

NOTE: Click **Default** to reset the advanced Ethernet parameters to their default values.

Refer to the table below for the following firmware versions:

- **PM5560 / PM5562 / PM5563 / PM5580 meter models: 2.9.9 and earlier**
- **PM5570 / PM5660 / PM5760 meter models: 3.2.9 and earlier**
- **PM5650 meter model: 2.12.9 and earlier**
- **PM5561 meter model: 10.9.9 and earlier**
- **PM5661 / PM5761 meter models: 11.2.9 and earlier**

Parameter	Values	Description
Time to Live	1-255	The maximum number of hops (in other words, devices such as routers) that a TCP packet is allowed to pass through before it is discarded
TCP Keep Alive	0-65000	How frequently (in seconds) the meter sends a TCP keepalive packet. A setting of 0 disables the sending of TCP keepalive packets.
BootP Timeout	0-60	The length of time (in seconds) that the meter waits for a response from a BootP server (the default IP address is used after timeout if no IP address is assigned.)
ARP Cache Timeout	0-65000	The length of time (in minutes) that ARP entries are kept in the ARP cache
FTP Server	Enabled, Disabled	Enables or disables the meter's internal FTP server
FTP Connection Idle Time	30-900	The length of time (in seconds) after which an idle FTP connection is closed
HTTP Connection Idle Time	0-65000	The length of time (in seconds) after which an idle HTTP connection is closed
HTTP Port Number	80, 1024- 65000	The TCP port used for HTTP messages. The following port numbers are reserved for other network protocols and cannot be used: 20 / 21 (FTP), 161 / 162 (SNMP) and 502 (Modbus TCP/IP).
HTTP Maximum Keepalives	0-65000	The number of times the meter sends a keepalive signal if it does not receive a response
Modbus TCP/IP Server Connections	16, 32, 36, 40, 44, 48, 64	The number of TCP connections used for Modbus TCP communications when the meter is functioning as an Ethernet gateway
Modbus TCP/IP Server Connection Idle Time	0-32767	The length of time the meter waits for a Modbus TCP/IP device to respond to a connection request initiated by the meter.

Refer to the table below for the following firmware versions:

- **PM5560 / PM5562 / PM5563 / PM5580 meter models: 4.0.0 and above**
- **PM5570 / PM5660 / PM5760 meter models: 6.0.0 and above**
- **PM5650 meter model: 4.10.0 and above**
- **PM5561 meter model: 12.0.0 and above**
- **PM5661 / PM5761 meter models: 14.0.0 and above**
- **PM5570L / PM5660L / PM5760L meter models: 6.0.0 and above**

Parameter	Values	Description
Time to Live	1-255	The maximum number of hops (in other words, devices such as routers) that a TCP packet is allowed to pass through before it is discarded.
TCP Keep Alive	0-65000	How frequently (in seconds) the meter sends a TCP keepalive packet. A setting of 0 disables the sending of TCP keepalive packets.
BootP Timeout	0-60	The length of time (in seconds) that the meter waits for a response from a BootP server (the default IP address is used after timeout if no IP address is assigned.).

Parameter	Values	Description
ARP Cache Timeout	0-65000	The length of time (in minutes) that ARP entries are kept in the ARP cache.
Enable HTTPS	–	By default the HTTPS is always enabled. Hypertext Transfer Protocol Secure (HTTPS): HTTPS is a variant of the standard web transfer protocol (HTTP) that adds a layer of security on the data in transit through a Secure Socket Layer (SSL) or Transport Layer Security (TLS) protocol connection. HTTPS enables encrypted communication and secure connection between a remote user and the meter.
HTTPS Port	443, 1024- 65000	The TCP port used for HTTPS messages. The following port numbers are reserved for other network protocols and cannot be used: 20 / 21 (FTP), 161 / 162 (SNMP) and 502 (Modbus TCP/IP).
Modbus TCP/IP Server Connections	16, 32, 36, 40, 44, 48, 64	The number of TCP connections used for Modbus TCP communications when the meter is functioning as an Ethernet gateway.
Modbus TCP/IP Server Connection Idle Time	0-32767	The length of time the meter waits for a Modbus TCP/IP device to respond to a connection request initiated by the meter.
FTP	Enabled, Disabled	Enables or disables the meter's internal FTP server.
Control Port	1-65534	Establishes connection between hosts.
Data Port	1-65534	Used for data transfer.
Connection Security Mode	No Encryption, TLS/SSL Implicit Encryption	Encryption for secure mode connection.
Encrypted Control Port	1-65534	Establishes encrypted connection between hosts.
Encrypted Data Port	1-65534	Used for encrypted data transfer.

Using a serial communications converter to set up RS-485

You can use a communications converter (USB to RS-485 or RS-232 to RS-485) to connect to the meter.

NOTE: Configuring the serial communications settings using this method may cause ION Setup to lose communications when the changes are sent to your meter. You must reconfigure ION Setup to match the new settings to re-establish communications with your meter.

1. Configure the serial communications converter's settings to be compatible with the meter's default communications settings.
2. Connect the meter's RS-485 port to the serial communications converter.
3. Connect the communications converter to the computer.
4. Start ION Setup in Network mode.
5. Add a serial site and set its properties:
 - Comm link = Serial
 - Comm port = select which serial (or USB) port the communications converter is attached to
 - Baud rate = 19200
 - Format = select a format with even parity
6. Add a meter to the site and set its properties:
 - Type = PowerLogic™ PM5xxx power meter
 - Unit ID = 1
7. Use the setup screens to modify the meter's setup parameters.
8. Use the **RS-485 Base Comm** setup screen to modify the meter's serial communication settings.

9. Click **Send** to save your changes to the meter. You need to reconfigure ION Setup to match the changed settings in order to re-establish communications with your meter.

NOTE: If you set the protocol to ASCII 7, ASCII 8 or Jbus, you cannot use ION Setup to reconnect to the meter – ION Setup does not communicate using these protocols.

10. Exit ION Setup.

RS-485 port settings

Parameter	Values	Description
Protocol	Modbus RTU, Jbus, ASCII 8, ASCII 7	Select the communications format used to transmit data. The protocol must be the same for all devices in a communications loop. ION Setup does not support ASCII 8, ASCII 7 or Jbus protocols.
Address	1 to 247	Set the address for this device. The address must be unique for each device in a communications loop. For Jbus protocol, set the device ID to 255. This value is used in both Modbus TCP/IP and serial communications.
Baud rate	9600, 10200, 38400	Select the speed for data transmission. The baud rate must be the same for all devices in a communications loop.
Parity	Even, Odd, None	Select None if the parity bit is not used. The parity setting must be the same for all devices in a communications loop.

Serial communications

The meter supports serial communication through the RS-485 port.

In an RS-485 network, there is one master device, typically an Ethernet to RS-485 gateway. It provides the means for RS-485 communications with multiple slave devices (for example, meters). For applications that require only one dedicated computer to communicate with the slave devices, a USB to RS-485 converter can be used to connect to the master device.

Up to 32 devices can be connected on a single RS-485 bus.

RS-485 network configuration

After you have wired the RS-485 port and powered up the meter, you must configure the serial communications port in order to communicate with the meter.

Each device on the same RS-485 communications bus must have a unique address and all connected devices must be set to the same protocol, baud rate, and parity (data format).

NOTE: To communicate with the meter using ION Setup, you must set the serial site and all connected devices in the RS-485 network to the same parity setting.

For meters that do not have a display, you must first wire and configure each one separately before connecting these meters to the same RS-485 bus.

RS-485 port setup

The meter is factory-configured with default serial communications settings that you may need to modify before connecting the meter to the RS-485 bus.

The meter is factory-configured with the following default serial communications settings:

- Protocol = Modbus RTU
- Address = 1
- Baud rate = 19200
- Parity = Even

You can use a communications converter (USB to RS-485 or RS-232 to RS-485) or Ethernet gateway device to connect to the meter.

Setting up serial communications using the display

The Serial setup screen allows you to configure the meter’s RS-485 communications port so you can use software to access the meter’s data or configure the meter remotely.

1. Navigate to **Maint > Setup**.
2. Enter the setup passcode (default is “0”), then press **OK**.
3. Navigate to **Comm > Serial**.
4. Move the cursor to point to the parameter you want to modify, then press **Edit**.
5. Modify the parameter as required, then press **OK**.
6. Move the cursor to point to the next parameter you want to modify, press **Edit**, make your changes, then press **OK**.
7. Press the up arrow to exit. Press **Yes** to save your changes.

Parameter	Values	Description
Mode	Slave, Gateway	Set this to Gateway to enable the Ethernet gateway functionality. Set this to Slave if you are adding the meter as a downstream device to an RS-485 network.
Protocol	Modbus, Jbus, ASCII 8 Bit, ASCII 7 Bit	Select the communications format used to transmit data. The protocol must be the same for all devices in a communications loop.
Address	1 to 247	Set the address for this device. The address must be unique for each device in a communications loop. For Jbus protocol, set the device ID to 255.
Baud Rate	9600, 19200, 38400	Select the speed for data transmission. The baud rate must be the same for all devices in a communications loop.
Parity	Even, Odd, None	Select None if the parity bit is not used. The parity setting must be the same for all devices in a communications loop.

Configuring serial settings using the webpages

NOTE: Refer to Restoration of temporarily disabled configuration settings in webpages, page 235 to know availability of these features on your meter model.

The Serial Settings webpage allows you to configure the meter’s RS-485 communications.

1. Login to the meter webpages.
2. Based on your meter firmware version, click **Settings > Serial Settings** OR click **Settings > Communication > Serial Port Configuration**.
3. Modify the serial settings as required.

4. Click **Save changes** or **Apply Changes**.

NOTE: Click **Defaults** to reset the advanced serial port settings to their default values.

Parameter	Values	Description
Mode	Slave, Gateway	Set this to Gateway to enable the Ethernet gateway functionality. Set this to Slave if you are adding the meter as a downstream device to an RS-485 network.
Protocol	Modbus, Jbus, ASCII 8 Bit, ASCII 7 Bit	Select the communications format used to transmit data. The protocol must be the same for all devices in a communications loop. NOTE: The protocol must be set to Modbus RTU or Jbus if you are using the meter as an Ethernet gateway.
Address	1 to 247	Set the address for this device. The address must be unique for each device in a communications loop.
Baud Rate	9600, 19200, 38400	Select the speed for data transmission. The baud rate must be the same for all devices in a communications loop.
Parity	Even, Odd, None	Select None if the parity bit is not used. The parity setting must be the same for all devices in a communications loop.
Modbus Broadcast	Enabled, Disabled	Set this to Enabled to if you want the gateway meter to forward broadcast messages (sent to Unit ID 0) to the downstream serial devices.
Response Timeout ⁵	0.1, 0.2, 0.3, 0.4, 0.5, 1, 2, 3, 4, 5, 6, 7, 8, 9, 10	Set the time the gateway meter waits for an answer from a downstream serial device before generating an exception response.
Delay Between Frames ⁵	0, 10, 20, 30, 40, 50, 60, 70, 80, 90, 100	The minimum time in milliseconds between the end of a received response and the beginning of a new request. Set this parameter to help improve communications between the gateway and downstream slave devices with slower response times.
Silent Interval Extension ⁵	0 – 15	Set this parameter to extend the silent interval (used to mark the end of a Modbus packet) beyond the default 3.5 characters defined in the Modbus standard. After the defined character time elapses without a new character, the gateway meter treats the next character as the start of a new message.

Using an Ethernet gateway to set up RS-485

You can use an Ethernet gateway to connect to the meter and configure RS-485 settings.

NOTE: Configuring the serial communications settings using this method may cause ION Setup to lose communications when the changes are sent to your meter. You must reconfigure ION Setup to match the new settings to re-establish communications with your meter.

1. Disconnect all serial devices presently connected to the Ethernet gateway's RS-485 port.
2. Configure the Ethernet gateway's serial port settings to match the meter's default serial communications settings:
 - Baud rate = 19200
 - Parity = Even
3. Connect the meter's RS-485 port to the Ethernet gateway.
4. Connect the Ethernet gateway to the LAN.
5. Start ION Setup in Network mode.

⁵ These are advanced settings that you can adjust if you have communications errors when communicating through the gateway to the downstream serial devices. They only apply if the meter is functioning as a gateway, and you should only change these settings if you have an advanced knowledge of Modbus communications and your communications network.

6. Add an Ethernet gateway site and set its properties:
 - IP address = IP address of the Ethernet gateway
 - Port = 502 (for Modbus RTU)
7. Add a meter to the site and set its properties:
 - Type = PowerLogic™ PM5xxx power meter
 - Unit ID = 1
8. Use the **RS-485 Base Comm** setup screen to modify the meter’s serial communications settings.
9. Click **Send** to save your changes to the meter.

NOTE: If you set the protocol to ASCII 7, ASCII 8 or Jbus, you cannot use ION Setup to reconnect to the meter – ION Setup does not communicate using these protocols.

Parameter	Values	Description
Protocol	Modbus RTU, Jbus, ASCII 8, ASCII 7	Select the communications format used to transmit data. The protocol must be the same for all devices in a communications loop. NOTE: ION Setup does not support ASCII 8, ASCII 7 or Jbus protocols.
Address	1 to 247	Set the address for this device. The address must be unique for each device in a communications loop. This value is used in both Modbus TCP/IP and serial communications.
Baud Rate	9600, 19200, 38400	Select the speed for data transmission. The baud rate must be the same for all devices in a communications loop.
Parity	Even, Odd, None	Select None if the parity bit is not used. The parity setting must be the same for all devices in a communications loop.

Post-requisite: Reconfigure ION Setup to match the changed settings in order to re-establish communications with your meter.

BACnet/IP

BACnet/IP protocol allows communication between the components of a building automation and control system (for example, HVAC, lighting control, security systems and related equipment).

The BACnet/IP protocol defines a number of services that are used to communicate between devices and the objects that are acted upon by those services.

Term	Definition
APDU	Application protocol data unit, that data portion of a BACnet message.
Confirmed message	A message for which the device expects an answer.
COV, COV increment	Change of value, sets the amount by which a value has to change in order for the meter to send a subscription notification.
Device	A BACnet device is a unit that is designed to understand and use BACnet protocol (for example, a BACnet-enabled meter or software program). It contains information about the device and device data in objects and object properties. Your meter is a BACnet device.
Object	Represents the device and device data. Each object has a type (for example, analog input or binary input) and has a number of properties.
Present value	The current value of an object.
Property	The smallest piece of information in BACnet communications, it consists of a name, data type and value.

Term	Definition
Service	Messages from one BACnet device to another.
Subscription	A relationship between a BACnet client and the meter, so that when the present value property of an object changes on the meter, a notification is sent to the client.
Subscription notification	The message the meter sends to indicate a COV event has occurred.
Unconfirmed message	A message for which the device does not expect an answer.
BACnet Broadcast Management Device (BBMD)	A BACnet/IP device (or software application) residing on a BACnet/IP subnet that forwards BACnet broadcast messages from devices on its subnet to peer BBMDs and registered foreign devices on other subnets.
Foreign device	A BACnet/IP device (or software application) that resides on a remote IP subnet and registers with a BBMD to facilitate the sending and receiving of broadcast messages to/from devices accessible by the BBMD.

Supported BACnet features

Your meter supports specific BACnet components and standard objects.

The meter's BACnet/IP protocol support is certified by BACnet International. Go to www.bacnetinternational.org or www.se.com and search for your meter model to access the PICS (Protocol Implementation Conformance Statement) for your meter.

Supported BACnet components

BACnet component	Description
Protocol version	1
Protocol revision	14
Standardized device profile (Annex L)	BACnet Application Specific Controller (B-ASC)
BACnet Interoperability Building Blocks (Annex K)	<ul style="list-style-type: none"> • DS-RP-B (Data Sharing - Read Property - B) • DS-RPM-B (Data Sharing - Read Property Multiple - B) • DS-WP-B (Data Sharing - Write Property - B) • DS-WPM-B (Data Sharing - Write Property Multiple - B) • DS-COV-B (Data Sharing - COV - B) • DM-DDB-B (Device Management - Dynamic Device Binding - B) • DM-DOB-B (Device Management - Dynamic Object Binding - B) • DM-DCC-B (Device Management - Device Communication Control - B)
BACnet/IP (Annex J)	BACnet communication internet protocol
Data link layer options	UDP
Character set ANSI	X3.4/UTF-8
Supported services	<ul style="list-style-type: none"> • subscribeCOV • readProperty • readPropertyMultiple • writeProperty • writePropertyMultiple • deviceCommunicationControl • who-HAS • who-Is • I-Am • I-Have • Confirmed COV notification • Unconfirmed COV notification

BACnet component	Description
Segmentation	The meter does not support segmentation
Static device address binding	The meter does not support static device address binding
Networking options	The meter supports registration as a foreign device

Supported standard object types

NOTE: The BACnet protocol allows you to set the out-of-service property of an object to true and write a value to that property for testing purposes. In this case, your BACnet software displays the value you wrote to the object, not the actual value from the meter and the system it is monitoring. Make sure you set the out-of-service property of all objects to false before you put the meter into service.

Object type	Optional properties supported	Writeable properties supported	Conditional writeable properties supported
Device Object	<ul style="list-style-type: none"> Location Description Local_Time Local_Date Active_COV_Subscriptions Profile_Name 	<ul style="list-style-type: none"> Object_Name Object_Identifier Location Description APDU_Timeout Number_Of_APDU_Retries 	—
Analog Input Object	<ul style="list-style-type: none"> Description Reliability COV_Increment 	<ul style="list-style-type: none"> Out_Of_Service COV_Increment 	Present_Value
Binary Input Object	<ul style="list-style-type: none"> Description Reliability 	Out_Of_Service	Present_Value
Multi-state Input Object	<ul style="list-style-type: none"> Description Reliability State_Text 	Out_Of_Service	Present_Value

BACnet/IP communications implementation

Your meter's BACnet implementation includes specific behaviors and configuration.

Basic configuration for BACnet communications

Before communicating with the meter via BACnet protocol, make sure the basic BACnet settings are configured appropriately for your network. The Device ID must be unique in your BACnet IP network.

Change of Value (COV) subscriptions

The meter supports up to 20 COV subscriptions. You can add COV subscriptions to Analog Input, Binary Input and Multi-state Input objects using your BACnet-compatible software.

Configuring BACnet/IP settings using the display

Use the meter's display to configure BACnet/IP settings if required.

1. Navigate to **Maint > Setup**.
2. Enter the setup passcode (default is "0"), then press **OK**.
3. Navigate to **Comm > BACnet**.
4. Move the cursor to point to the parameter you want to modify, then press **Edit**.
5. Modify the parameter as required, then press **OK**.
6. Move the cursor to point to the next parameter you want to modify, press **Edit**, make your changes, then press **OK**.
7. Press the up arrow to exit.

Basic BACnet/IP settings available using the display

Parameter	Values	Description
BACnet Status	Enabled, Disabled	Enable or disable BACnet/IP communications with the meter
Device ID	1 – 4194302	Enter the ID of the meter on your BACnet network. The ID must be unique on the network.
UDP Port	1024 – 65535	Enter the port the meter uses for BACnet/IP communications. The default is the standard BACnet/IP port (47808).

Foreign device settings available using the display

Parameter	Values	Description
BBMD Status	Enabled, Disabled	Enable or disabled registration of the meter as a foreign device.
BBMD IP	Contact your local network administrator for parameter values.	Enter the IP address of the BACnet/IP Broadcast Management Device (BBMD), if you use a BBMD on your network.
BBMD Port	1024 – 65535	Enter the port number that is used for communications with the BBMD. The default is the standard BACnet/IP port (47808)
BBMD TTL (sec)	0 – 65535	The length of time (in seconds) the BBMD keeps an entry for this device in its foreign device table.

Configuring BACnet/IP settings using the webpages

NOTE: Refer to Restoration of temporarily disabled configuration settings in webpages, page 235 to know availability of these features on your meter model.

Use the meter's webpages to configure BACnet/IP settings if required.

1. Login to the meter webpages.
2. Based on your meter firmware version, click **Settings > BACnet/IP Settings** OR click **Settings > Communication > BACnet/IP Settings**.
3. Configure the settings as required for your BACnet network.

4. Click **Save changes** or **Apply Changes**.

Basic BACnet/IP settings available using the webpages

Parameter	Values	Description
BACnet/IP Enable	Yes, No	Enable or disable BACnet/IP communications with the meter
Device ID	1 – 4194302	Enter the ID of the meter on your BACnet network. The ID must be unique on the network.
Port	1024 – 65535	Enter the port the meter uses for BACnet/IP communications. The default is the standard BACnet/IP port (47808).

Foreign device settings available using the webpages

Parameter	Values	Description
BBMD Enable	Yes, No	Enable or disabled registration of the meter as a foreign device.
BBMD IP	Contact your local network administrator for parameter values.	Enter the IP address of the BACnet/IP Broadcast Management Device (BBMD), if you use a BBMD on your network.
BBMD Port	1024 – 65535	Enter the port number that is used for communications with the BBMD. The default is the standard BACnet/IP port (47808).
BBMD TTL (Time To Live)	0 – 65535	The length of time (in seconds) the BBMD keeps an entry for this device in its foreign device table.

BACnet objects

Device object

Your meter has a Device object which describes the meter to the BACnet network.

The following table outlines the properties of the Device object, whether a property is read-only or read-write, and if the value of the property is stored in the meter’s nonvolatile onboard memory.

Device object property	R/W	Stored	Possible values	Description
Object_Identifier	R/W	Y	See description	The unique device ID number for the meter, in the format of <device, #>. The meter ships from the factory with a device ID equal to the last 6 digits of the serial number.
Object_Name	R/W	Y	See description	A configurable name for the meter. The meter ships from the factory with a name of <model name> <serial number> (for example, PM5560_0000000000).
Object_Type	R	—	Device	The object type for the meter.
System_Status	R	—	Operational	This value of this property is always Operational.
Vendor_Name	R	—	Schneider Electric	Meter manufacturer
Vendor_Identifier	R	—	10	The BACnet vendor identifier for Schneider Electric.
Model_Name	R	—	varies	Device model (for example, PM5560) and serial number in the format <model name> <serial number> (for example, PM5560_0000000000).
Firmware_Revision	R	—	varies	BACnet firmware version, stored in an x.x.x format (for example, 1.9.0).
Application_Software_Version	R	—	varies	Meter firmware version, stored in an x.x.x format (for example, 1.0.305).

Device object property	R/W	Stored	Possible values	Description
Description	R/W	Y	configurable	Optional description of the meter, limited to 64 characters.
Location	R/W	Y	configurable	Optional description of the meter's location, limited to 64 characters.
Protocol_Version	R	—	varies	BACnet protocol version (for example, version 1)
Protocol_Revision	R	—	varies	BACnet protocol revision (for example, revision 14)
Protocol_Services_Supported	R	—	0000 0100 0000 1011 1100 1000 0000 0000 0110 0000 0	The BACnet services supported by the meter: subscribeCOV, readProperty, readPropertyMultiple, writeProperty, writePropertyMultiple, deviceCommunicationControl, ReinitializeDevice, who-HAS, who-Is
Protocol_Object_Types_Supported	R	—	1001 0000 1000 0100 0000 0000 0000 0000 0000 0000 0000 0000 0000 000	The BACnet object types supported by the meter: analog input, binary input, multi-state input, device.
Object_list	R	—	See description	List of objects in the meter.
Max_APDU_Length_Accepted	R	—	1476	The maximum packet size (or application protocol data unit) that the meter can accept, in bytes.
Segmentation_Supported	R	—	0x03	The meter does not support segmentation.
Local_Date	R	—	varies	Current date on the meter NOTE: Use the display, the webpages or ION Setup to set the meter's date.
Local_Time	R	—	varies	Current time on the meter NOTE: Use the display, the webpages or ION Setup to set the meter's time. You can also set up SNTP time synchronization using the webpages.
APDU_Timeout	R/W	Y	1000 – 30000	The amount of time (in milliseconds) before the meter tries to resend a confirmed message that has not been answered.
Number_Of_APDU_Retries	R/W	Y	1 – 10	The number of times the meter tries to resend an unanswered confirmed request.
Device_Address_Binding	R	—	—	Device address binding table is always blank because the meter does not initiate the who-Is service.
Database_Revision	R	Y	varies	A number that increments when the object database on the meter changes (for example, when an object is created or deleted or the ID of an object changes).
Active_COV_Subscriptions	R	—	varies	List of COV subscriptions currently active on the meter.
Profile_Name	R	—	varies	Device identifier that records the meter manufacturer, the meter family and the specific meter model (for example, 10-PM5000-PM5560).

Analog Input objects

Your meter has a number of Analog Input objects that provide meter values and information on meter settings.

The following tables list the Analog Input objects along with the units and default COV value for each object (if applicable).

Real-time measurements

Object ID	Object name	Units	Default COV	Description
3000	Current - Ph A	A	50	Current phase A
3002	Current - Ph B	A	50	Current phase B
3004	Current - Ph C	A	50	Current phase C
3006	Current - Neutral	A	50	Neutral current
3008	Current - Ground	A	50	Ground current
3010	Current - Avg	A	50	Current average
3012	Current Unb - Ph A	%	20	Current unbalance phase A
3014	Current Unb - Ph B	%	20	Current unbalance phase B
3016	Current Unb - Ph C	%	20	Current unbalance phase C
3018	Current Unb - Worst	%	20	Current unbalance worst
3020	Voltage - A-B	V	10	Voltage A-B
3022	Voltage - B-C	V	10	Voltage B-C
3024	Voltage - C-A	V	10	Voltage C-A
3026	Voltage - Avg L-L	V	10	Voltage L-L Avg
3028	Voltage - A-N	V	10	Voltage A-N
3030	Voltage - B-N	V	10	Voltage B-N
3032	Voltage - C-N	V	10	Voltage C-N
3036	Voltage - Avg L-N	V	10	Voltage L-N Avg
3038	Voltage Unb - A-B	%	20	Voltage unbalance A-B
3040	Voltage Unb - B-C	%	20	Voltage unbalance B-C
3042	Voltage Unb - C-A	%	20	Voltage unbalance C-A
3044	Voltage Unb - Worst L-L	%	20	Voltage unbalance L-L worst
3046	Voltage Unb - A-N	%	20	Voltage unbalance A-N
3048	Voltage Unb - B-N	%	20	Voltage unbalance B-N
3050	Voltage Unb - C-N	%	20	Voltage unbalance C-N
3052	Voltage Unb - Worst L-N	%	20	Voltage unbalance L-N worst
3110	Frequency	Hz	10	Frequency
3100*	Residual current - I5	mA	0.001	I5 residual current
3102*	Residual current - I6	mA	0.001	I6 residual current
44042*	Analog Input 1 - Raw Value	A	0.001	Raw value of analog input 1
44044*	Analog Input 1 - Scaled Value	—	1	Scaled value of analog input 1
44096*	Analog Input 2 - Raw Value	A	0.001	Raw value of analog input 2
44098*	Analog Input 2 - Scaled Value	—	1	Scaled value of analog input 2

*Available in specific meter models. Refer to Features differentiation matrix for PM5500 / PM5600 / PM5700 series, page 20 for the availability.

Power and power factor

Object ID	Object name	Units	Default COV	Description
3054	Active Power - Ph A	kW	10	Active power phase A
3056	Active Power - Ph B	kW	10	Active power phase B
3058	Active Power - Ph C	kW	10	Active power phase C

Object ID	Object name	Units	Default COV	Description
3060	Active Power - Total	kW	10	Active power total
3062	Reactive Power - Ph A	kVAR	10	Reactive power phase A
3064	Reactive Power - Ph B	kVAR	10	Reactive power phase B
3066	Reactive Power - Ph C	kVAR	10	Reactive power phase C
3068	Reactive Power - Total	kVAR	10	Reactive power total
3070	Apparent Power - Ph A	kVA	10	Apparent power phase A
3072	Apparent Power - Ph B	kVA	10	Apparent power phase B
3074	Apparent Power - Ph C	kVA	10	Apparent power phase C
3076	Apparent Power - Total	kVA	10	Apparent power total
3078	Power Factor - Ph A	—	0.2	Power factor phase A
3080	Power Factor - Ph B	—	0.2	Power factor phase B
3082	Power Factor - Ph C	—	0.2	Power factor phase C
3084	Power Factor - Total	—	0.2	Power Factor Total

Energy and energy by tariff measurements

Object ID	Object name	Units	Default COV	Description
2700	Active Energy Delvd	kWh	100	Active energy delivered
2702	Active Energy Rcvd	kWh	100	Active energy received
2704	Active Energy Delvd + Rcvd	kWh	100	Active energy delivered + received
2706	Active Energy Delvd - Rcvd	kWh	100	Active energy delivered – received
2708	Reactive Energy Delvd	kVARh	100	Reactive energy delivered
2710	Reactive Energy Rcvd	kVARh	100	Reactive energy received
2712	Reactive Energy Delvd + Rcvd	kVARh	100	Reactive energy delivered + received
2714	Reactive Energy Delvd - Rcvd	kVARh	100	Reactive energy delivered – received
2716	Apparent Energy Delvd	kVAh	100	Apparent energy delivered
2718	Apparent Energy Rcvd	kVAh	100	Apparent energy received
2720	Apparent Energy Delvd + Rcvd	kVAh	100	Apparent energy delivered + received
2722	Apparent Energy Delvd - Rcvd	kVAh	100	Apparent energy delivered – received
4191	Applicable Tariff Energy Rate	—	1	Denotes the active tariff: 0 = Multi Tariff feature is disabled 1 = tariff 1 active 2 = tariff 2 active 3 = tariff 3 active 4 = tariff 4 active 5 = tariff 5 active 6 = tariff 6 active 7 = tariff 7 active 8 = tariff 8 active
4800	Active Energy Delvd (Tariff 1)	kWh	100	Tariff 1 active energy import
4802	Active Energy Delvd (Tariff 2)	kWh	100	Tariff 2 active energy import

Object ID	Object name	Units	Default COV	Description
4804	Active Energy Delvd (Tariff 3)	kWh	100	Tariff 3 active energy import
4806	Active Energy Delvd (Tariff 4)	kWh	100	Tariff 4 active energy import
4808	Active Energy Delvd (Tariff 5)	kWh	100	Tariff 5 active energy import
4810	Active Energy Delvd (Tariff 6)	kWh	100	Tariff 6 active energy import
4812	Active Energy Delvd (Tariff 7)	kWh	100	Tariff 7 active energy import
4814	Active Energy Delvd (Tariff 8)	kWh	100	Tariff 8 active energy import

Power demand

Object ID	Object name	Units	Default COV	Description
3764	Dmd - Active Power Last	kW	10	Demand - Active power last
3766	Dmd - Active Power Present	kW	10	Demand - Active power present
3768	Dmd - Active Power Pred	kW	10	Demand - Active power predicted
3770	Dmd - Active Power Peak	kW	10	Demand - Active power peak
3780	Dmd - Reactive Power Last	kVAR	10	Demand - Reactive power last
3782	Dmd - Reactive Power Present	kVAR	10	Demand - Reactive power present
3784	Dmd - Reactive Power Pred	kVAR	10	Demand - Reactive power predicted
3786	Dmd - Reactive Power Peak	kVAR	10	Demand - Reactive power peak
3796	Dmd - Apparent Power Last	kVA	10	Demand - Apparent power last
3798	Dmd - Apparent Power Present	kVA	10	Demand - Apparent power present
3800	Dmd - Apparent Power Pred	kVA	10	Demand - Apparent power predicted
3802	Dmd - Apparent Power Peak	kVA	10	Demand - Apparent power peak
3972	Dmd - Active Power Ph A Last	kW	10	Demand - Active power phase A last
3974	Dmd - Active Power Ph A Present	kW	10	Demand - Active power phase A present
3976	Dmd - Active Power Ph A Pred	kW	10	Demand - Active power phase A predicted
3978	Dmd - Active Power Ph A Peak	kW	10	Demand - Active power phase A peak
3988	Dmd - Reactive Power Ph A Last	kVAR	10	Demand - Reactive power phase A last
3990	Dmd - Reactive Power Ph A Present	kVAR	10	Demand - Reactive power phase A present
3992	Dmd - Reactive Power Ph A Pred	kVAR	10	Demand - Reactive power phase A predicted
3994	Dmd - Reactive Power Ph A Peak	kVAR	10	Demand - Reactive power phase A peak
4004	Dmd - Apparent Power Ph A Last	kVA	10	Demand - Apparent power phase A last
4006	Dmd - Apparent Power Ph A Present	kVA	10	Demand - Apparent power phase A present
4008	Dmd - Apparent Power Ph A Pred	kVA	10	Demand - Apparent power phase A predicted
4010	Dmd - Apparent Power Ph A Peak	kVA	10	Demand - Apparent power phase A peak
4020	Dmd - Active Power Ph B Last	kW	10	Demand - Active power phase B last

Object ID	Object name	Units	Default COV	Description
4022	Dmd - Active Power Ph B Present	kW	10	Demand - Active power phase B present
4024	Dmd - Active Power Ph B Pred	kW	10	Demand - Active power phase B predicted
4026	Dmd - Active Power Ph B Peak	kW	10	Demand - Active power phase B peak
4036	Dmd - Reactive Power Ph B Last	kVAR	10	Demand - Reactive power phase B last
4038	Dmd - Reactive Power Ph B Present	kVAR	10	Demand - Reactive power phase B present
4040	Dmd - Reactive Power Ph B Pred	kVAR	10	Demand - Reactive power phase B predicted
4042	Dmd - Reactive Power Ph B Peak	kVAR	10	Demand - Reactive power phase B peak
4052	Dmd - Apparent Power Ph B Last	kVA	10	Demand - Apparent power phase B last
4054	Dmd - Apparent Power Ph B	kVA	10	Demand - Apparent power phase B present
4056	Dmd - Apparent Power Ph B Pred	kVA	10	Demand - Apparent power phase B predicted
4058	Dmd - Apparent Power Ph B Peak	kVA	10	Demand - Apparent power phase B peak
4068	Dmd - Active Power Ph C Last	kW	10	Demand - Active power phase C last
4070	Dmd - Active Power Ph C Present	kW	10	Demand - Active power phase C present
4072	Dmd - Active Power Ph C Pred	kW	10	Demand - Active power phase C predicted
4074	Dmd - Active Power Ph C Peak	kW	10	Demand - Active power phase C peak
4084	Dmd - Reactive Power Ph C Last	kVAR	10	Demand - Reactive power phase C last
4086	Dmd - Reactive Power Ph C Present	kVAR	10	Demand - Reactive power phase C present
4088	Dmd - Reactive Power Ph C Pred	kVAR	10	Demand - Reactive power phase C predicted
4090	Dmd - Reactive Power Ph C Peak	kVAR	10	Demand - Reactive power phase C peak
4100	Dmd - Apparent Power Ph C Last	kVA	10	Demand - Apparent power phase C last
4102	Dmd - Apparent Power Ph C Present	kVA	10	Demand - Apparent power phase C present
4104	Dmd - Apparent Power Ph C Pred	kVA	10	Demand - Apparent power phase C predicted
4106	Dmd - Apparent Power Ph C Peak	kVA	10	Demand - Apparent power phase C peak

Current demand

Object ID	Object name	Units	Default COV	Description
3812	Dmd - Active Current Ph A Last	A	10	Demand - Active current phase A last
3814	Dmd - Current Ph A Present	A	10	Demand - Current phase A present
3816	Dmd - Active Current Ph A Pred	A	10	Demand - Active current phase A predicted

Object ID	Object name	Units	Default COV	Description
3818	Dmd - Active Current Ph A Peak	A	10	Demand - Active current phase A peak
3828	Dmd - Active Current Ph B Last	A	10	Demand - Active current phase B last
3830	Dmd - Current Ph B Present	A	10	Demand - Current phase B present
3832	Dmd - Active Current Ph B Pred	A	10	Demand - Active current phase B predicted
3834	Dmd - Active Current Ph B Peak	A	10	Demand - Active current phase B peak
3844	Dmd - Active Current Ph C Last	A	10	Demand - Active current phase C last
3846	Dmd - Current Ph C Present	A	10	Demand - Current phase C present
3848	Dmd - Active Current Ph C Pred	A	10	Demand - Active current phase C predicted
3850	Dmd - Active Current Ph C Peak	A	10	Demand - Active current phase C peak
3860	Dmd - Current Neutral Last	A	10	Demand - Current neutral last
3862	Dmd - Current Neutral Present	A	10	Demand - Current neutral present
3864	Dmd - Current Neutral Pred	A	10	Demand - Current neutral predicted
3866	Dmd - Current Neutral Peak	A	10	Demand - Current neutral peak
3876	Dmd - Average Current Last	A	10	Demand - Average current last
3878	Dmd - Avg Current Present	A	10	Demand - Average current present
3880	Dmd - Average Current Pred	A	10	Demand - Average current predicted
3882	Dmd - Average Current Peak	A	10	Demand - Average current peak

Power quality

Object ID	Object name	Units	Default COV	Description
21300	THD Current - Ph A	%	20	THD Current A
21302	THD Current - Ph B	%	20	THD Current B
21304	THD Current - Ph C	%	20	THD Current C
21306	THD Current - Ph N	%	20	THD Current N
21308	THD Current - Ph G	%	20	THD Current G
21310	thd Current - Ph A	%	20	thd Current A
21312	thd Current - Ph B	%	20	thd Current B
21314	thd Current - Ph C	%	20	thd Current C
21316	thd Current - Ph N	%	20	thd Current N
21318	thd Current - Ph G	%	20	thd Current G
21320	Total Dmd Distortion	%	20	Total Demand Distortion
21322	THD Voltage - A-B	%	20	THD Voltage A-B
21324	THD Voltage - B-C	%	20	THD Voltage B-C
21326	THD Voltage - C-A	%	20	THD Voltage C-A
21328	THD Voltage - Avg L-L	%	20	THD Voltage L-L
21330	THD Voltage - A-N	%	20	THD Voltage A-N
21332	THD Voltage - B-N	%	20	THD Voltage B-N
21334	THD Voltage - C-N	%	20	THD Voltage C-N
21338	THD Voltage - Avg L-N	%	20	THD Voltage L-N

Object ID	Object name	Units	Default COV	Description
21340	thd Voltage - A-B	%	20	thd Voltage A-B
21342	thd Voltage - B-C	%	20	thd Voltage B-C
21344	thd Voltage - C-A	%	20	thd Voltage C-A
21346	thd Voltage - Avg L-L	%	20	thd Voltage L-L
21348	thd Voltage - A-N	%	20	thd Voltage A-N
21350	thd Voltage - B-N	%	20	thd Voltage B-N
21352	thd Voltage - C-N	%	20	thd Voltage C-N
21356	thd Voltage - Avg L-N	%	20	thd Voltage L-N

Meter information

The following table lists Analog Input objects that provide information about the meter and its configuration.

NOTE: You can access the meter's configuration information over BACnet communications. However, you must use the display, meter webpages or ION Setup to configure the meter's settings.

Object ID	Object name	Units	Default COV	Description
2000	Time since last meter power up	Seconds	604800	Time since the meter was last powered up
2004	Meter operation timer	Seconds	604800	Total meter operation time
2014	Number of phases	—	1	Number of phases 1, 3
2015	Number of wires	—	1	Number of wires 2, 3, 4
2017	Nominal frequency	Hz	1	Nominal frequency 50, 60
2025	Number of VTs	—	1	Number of VTs 0, 2, 3
2026	VT primary	V	1	VT Primary
2028	VT secondary	V	1	VT Secondary
2029	Number of CTs	—	1	Number of CTs 1, 2, 3, 4
2030	CT primary	A	1	CT Primary
2031	CT secondary	A	1	CT Secondary
2060*	RCM – I5 toroid turns	—	1000	RCM toroid turns of I5
2062*	RCM – I6 toroid turns	—	1000	RCM toroid turns of I6

*Available in specific meter models. Refer to Features differentiation matrix for PM5500 / PM5600 / PM5700 series, page 20 for the availability.

Binary Input objects

Your meter has a number of Binary Input objects that provide the status information from the meter's I/O.

The following table lists the Binary Input (BI) objects available on the meter.

Object ID	Object name	Description
38416 – 38419	Digital Input 1 Digital Input 2 Digital Input 3* Digital Input 4*	Status of digital inputs: 0 = on 1 = off NOTE: This information only applies if the digital input is configured as a status input.
38448, 38449	Digital Output 1 Digital Output 2	Status of digital outputs: 0 = on 1 = off

*Available in specific meter models. Refer to Features differentiation matrix for PM5500 / PM5600 / PM5700 series, page 20 for the availability.

Multi-state Input objects

Your meter has a number of Multi-state Input objects that provide information about the meter's I/O and power system settings.

Meter configuration multi-state input objects

Object ID	Object name	Object name / description
2016	Power System Type	Power system configuration: 0 = 1PH2W L-N 1 = 1PH2W L-L 2 = 1PH3W L-L with N 3 = 3PH3W ungrounded delta 4 = 3PH3W corner grounded delta 5 = 3PH3W ungrounded wye 6 = 3PH3W grounded wye 7 = 3PH3W resistance grounded wye 8 = 3PH4W center-tapped open delta 9 = 3PH4W center-tapped delta 10 = 3PH4W ungrounded wye 11 = 3PH4W grounded wye 12 = 3PH4W resistance grounded wye
2036	VT Connection Type	VT connection type: 0 = Direct connect 1 = Delta (2 VT) 2 = Wye (3 VT) 3 = L-N (1 VT) 4 = L-L (1 VT) 5 = L-L with N (2 VT)
3701	Demand Method - Power	Power demand method: 0 = Thermal demand 1 = Timed interval sliding block 2 = Timed interval block 3 = Timed interval rolling block 4 = Input synchronized block 5 = Input synchronized rolling block 6 = Command synchronized block 7 = Command synchronized rolling block 8 = Clock synchronized block 9 = Clock synchronized rolling block

Object ID	Object name	Object name / description
3711	Demand Method - Current	Current demand method: 0 = Thermal demand 1 = Timed interval sliding block 2 = Timed interval block 3 = Timed interval rolling block 4 = Input synchronized block 5 = Input synchronized rolling block 6 = Command synchronized block 7 = Command synchronized rolling block 8 = Clock synchronized block 9 = Clock synchronized rolling block
3721	Demand Method - Input Metering	Input metering demand method: 0 = Thermal demand 1 = Timed interval sliding block 2 = Timed interval block 3 = Timed interval rolling block 4 = Input synchronized block 5 = Input synchronized rolling block 6 = Command synchronized block 7 = Command synchronized rolling block 8 = Clock synchronized block 9 = Clock synchronized rolling block

I/O multi-state input objects

The following table lists the Multi-state Input objects that provide information about meter's I/O configuration.

Object ID	Object name	Description
7274, 7298, 7322, 7346	Digital Input 1 Mode Digital Input 2 Mode Digital Input 3 Mode* Digital Input 4 Mode*	Digital input control mode 0 = Normal (Alarm) 1 = Demand Interval Sync Pulse 2 = Multi-tariff Control 3 = Input Metering
9673, 9681	Digital Output Mode 1 Digital Output Mode 2	Digital output control mode 0 = External 1 = Demand Sync 2 = Alarm 3 = Energy

*Available in specific meter models. Refer to Features differentiation matrix for PM5500 / PM5600 / PM5700 series, page 20 for the availability.

EtherNet/IP

EtherNet/IP is the name given to the Common Industrial Protocol (CIP), as implemented over standard Ethernet (IEEE 802.3 and the TCP/IP protocol suite).

EtherNet/IP features overview

NOTE: The EtherNet/IP and related features are available in firmware version 10.6.3 and above for PM5561 meter model and firmware version 2.5.4 and above for PM5560 / PM5562 / PM5563 meter models.

The CIP application layer defines a set of application objects and device profiles that define common interfaces and behaviors. In addition, CIP communication services enable end-to-end communication between devices on the different CIP networks.

EtherNet/IP maps the CIP communication services to Ethernet and TCP/IP, enabling multi-vendor interoperability between devices on Ethernet as well as with the other CIP networks.

EtherNet/IP defines two primary types of communications:

- Cyclical Exchanges (Implicit Exchanges)
- Messaging (Explicit Exchanges)

Cyclical Exchanges (Implicit Exchanges)

The tables below gives description of the assembly sets supported by meters.

The size of assembly instances are as follows:

- Assembly input 100: 240 bytes
- Assembly output 150: 4 bytes
- Assembly configuration: 0

Assembly input 100

Word Number	Parameter
0	Current A
2	Current B
4	Current C
6	Current N
8	Current G
10	Current Avg
12	Current Unbalance A
14	Current Unbalance B
16	Current Unbalance C
18	Current Unbalance Worst
20	Voltage A-B
22	Voltage B-C
24	Voltage C-A
26	Voltage L-L Avg
28	Voltage A-N
30	Voltage B-N
32	Voltage C-N
34	–
36	Voltage L-N Avg
38	Voltage Unbalance A-B
40	Voltage Unbalance B-C
42	Voltage Unbalance C-A
44	Voltage Unbalance L-L Worst
46	Voltage Unbalance A-N
48	Voltage Unbalance B-N
50	Voltage Unbalance C-N

Assembly input 100 (Continued)

Word Number	Parameter
52	Voltage Unbalance L-N Worst
54	Active Power A
56	Active Power B
58	Active Power C
60	Active Power Total
62	Reactive Power A
64	Reactive Power B
66	Reactive Power C
68	Reactive Power Total
70	Apparent Power A
72	Apparent Power B
74	Apparent Power C
76	Apparent Power Total
78	Power Factor A
80	Power Factor B
82	Power Factor C
84	Power Factor Total
86	Displacement Power Factor A
88	Displacement Power Factor B
90	Displacement Power Factor C
92	Displacement Power Factor Total
94	Frequency
96	Active Energy Delivered (Into Load)
98	Active Energy Received (Out of Load)
100	Active Energy Delivered + Received
102	Active Energy Delivered- Received
104	Reactive Energy Delivered
106	Reactive Energy Received
108	Reactive Energy Delivered + Received
110	Reactive Energy Delivered - Received
112	Apparent Energy Delivered
114	Apparent Energy Received
116	Apparent Energy Delivered + Received
118	Apparent Energy Delivered - Received

Assembly output 150

Word Number	Parameter
0	Dummy parameter
1	Dummy parameter

Messaging (Explicit Exchanges)

The following objects can be accessed through explicit exchanges by meters.

Object classes

The object classes are detailed in the following table:

Object class	Class ID	No. of instances	Description
Identity	01 hex	1	Supports the reset service
Message router	02 hex	1	Explicit message connection
Assembly	04 hex	2	Defines I/O data format
Connection manager	06 hex	1	Manages the internal resources associated with both I/O and explicit messaging conditions
TCP/IP interface	F5 hex	1	TCP/IP configuration
Ethernet link	F6 hex	1	Counter and status information
Port object	F4 hex	1	Describes the communication interfaces that are present on the device and visible to CIP
Base energy	4E hex	1	Acts as an energy supervisor for CIP energy implementations
Electrical energy	4F hex	1	Provides unified electrical energy reporting capability for CIP enabled devices and processes

Identity object (01 hex)

The identity object provides identification and status information about the meter.

Class code

Hexadecimal	Decimal
01 hex	1

Class attributes

Attribute ID	Access	Name	Data type	Description	Semantics of values
1	Get	Revision	UINT	Revision of this object	The current value assigned to this attribute is one (01). If updates that require an increase in this value are made, then the value of this attribute increases by 1
2	Get	Max instances	UINT	Maximum instance number of an object currently created in this class level of the device	The largest instance number of a created object at this class hierarchy level
3	Get	Number of instances	UINT	Number of object instances currently created at this class level of the device	The number of object instances at this class hierarchy level
6	Get	Max ID number of class attribute	UINT	The attribute ID number of the last class attribute of the class definition implemented in the device	-
7	Get	Max ID number of instance attribute	UINT	The attribute ID number of the last instance attribute of the class definition implemented in the device	-

Instance attributes

Attribute ID	Access	Name	Data type	Description	Semantics of values
1	Get	Vendor ID	UINT	Identification of each vendor by number	-
2	Get	Device type	UINT	Indication of general type of product	-
3	Get	Product code	UINT	Identification of a particular product of an individual vendor	-
4	Get	Revision	STRUCT of:	Revision of the item the identity object represents	Identifies the revision of the item the identity object is representing
		Major revision	USINT		
		Minor revision	USINT		
5	Get	Status	WORD	Summary status of device	This attribute represents the current status of the entire device. Its value changes as the state of the device changes
6	Get	Serial number	UDINT	Serial number of device	This attribute is a number used in conjunction with the Vendor ID to form a unique identifier for each device on any CIP network
7	Get	Product name	SHORT_STRING	Human readable identification	This text string shall represent a short description of the product represented by the Product Code in attribute 3.

Supported class and instance services

Class service code	Instance service code	Service name	Description
01 hex	01 hex	Get_Attribute_All	Return all attributes
0E hex	0E hex	Get_Attribute_Single	Return single attribute
-	05 hex	Reset	Reset the communication module of the device

Message router object (02 hex)**Class code**

Hexadecimal	Decimal
02 hex	2

Class attributes

Attribute ID	Access	Name	Data type	Description	Semantics of values
1	Get	Revision	UINT	Revision of this object	The current value assigned to this attribute is one (01). If updates that require an increase in this value are made, then the value of this attribute increases by 1
2	Get	Max instances	UINT	Maximum instance number of an object currently created in this class level of the device	The largest instance number of a created object at this class hierarchy level
3	Get	Number of instances	UINT	Number of object instances currently created at this class level of the device	The number of object instances at this class hierarchy level
4	Get	Optional attribute list	STRUCT of:	List of optional instance attributes utilized in an object class implementation	A list of attribute numbers specifying the optional

Class attributes (Continued)

Attribute ID	Access	Name	Data type	Description	Semantics of values
					attributes implemented in the device for this class
		Number of attributes	UINT	Number of attributes in the optional attribute list	The number of attribute numbers in the list
		Optional attributes	ARRAY of UINT	List of optional attribute numbers	The optional attribute numbers
6	Get	Max ID number of class attribute	UINT	The attribute ID number of the last class attribute of the class definition implemented in the device	-
7	Get	Max ID number of instance attribute	UINT	The attribute ID number of the last instance attribute of the class definition implemented in the device	-

Instance attributes

Attribute ID	Access	Name	Data type	Description	Semantics of values
1	Get	Object_list	STRUCT of:	A list of supported objects	Structure with an array of object class codes supported by the device
		Number	UINT	Number of supported classes in the classes array	The number of class codes in the classes array
		Classes	ARRAY of UINT	List of supported class codes	The class codes supported by the device
2	Get	Number available	UINT	Maximum number of connections supported	Count of the max number of connections supported

Supported class and instance services

Service code	Service name	Description
01 hex	Get_Attribute_All	Return all attributes
0E hex	Get_Attribute_Single	Return single attribute

Assembly object (04 hex)

Class code

Hexadecimal	Decimal
04 hex	4

Class attributes

Attribute ID	Access	Name	Data type	Description	Semantics of values
1	Get	Revision	UINT	Revision of this object	The current value assigned to this attribute is two (02)

Instance attributes

Attribute ID	Access	Name	Data type	Description	Semantics of values
3	Set	Data	ARRAY of BYTE	-	-

Supported class and instance services

Service code	Service name	Description
0E hex	Get_Attribute_Single	Return single attribute

Connection manager object (06 hex)**Class attributes**

Attribute ID	Access	Name	Data type	Description	Semantics of values
1	Get	Revision	UINT	Revision of this object	The current value assigned to this attribute is one (01). If updates that require an increase in this value are made, then the value of this attribute increases by 1
2	Get	Max instances	UINT	Maximum instance number of an object currently created in this class level of the device	The largest instance number of a created object at this class hierarchy level
3	Get	Number of instances	UINT	Number of object instances currently created at this class level of the device	The number of object instances at this class hierarchy level
4	Get	Optional attribute list	STRUCT of:	List of optional instance attributes utilized in an object class implementation	A list of attribute numbers specifying the optional attributes implemented in the device for this class
		Number of attributes	UINT	Number of attributes in the optional attribute list	The number of attribute numbers in the list
		Optional attributes	ARRAY of UINT	List of optional attribute numbers	The optional attribute numbers
6	Get	Max ID number of class attributes	UINT	The attribute ID number of the last class attribute of the class definition implemented in the device	-
7	Get	Max ID number of instance attributes	UINT	The attribute ID number of the last instance attribute of the class definition implemented in the device	-

Instance attributes

Attribute ID	Access	Name	Data type	Description	Semantics of values
1	Set	Open requests	UINT	Number of forward open service requests received	-
2	Set	Open format rejects	UINT	Number of forward open service requests which were rejected due to bad format	-
3	Set	Open resource rejects	UINT	Number of forward open service requests which were rejected due to lack of resources	-
4	Set	Open other rejects	UINT	Number of forward open service requests which were rejected for reasons other than bad format or lack of resources	-
5	Set	Close requests	UINT	Number of forward close service requests received	-
6	Set	Close format rejects	UINT	Number of forward close service requests which were rejected due to bad format	-
7	Set	Close other rejects	UINT	Number of forward close service requests which were rejected for reasons other than bad format	-
8	Set	Connection timeouts	UINT	Total number of connection timeouts that have occurred in connections controlled by this connection manager	-

Supported class and instance services

Class service code	Instance service code	Service name	Description
01 hex	01 hex	Get_Attribute_All	Return all attributes
0E hex	0E hex	Get_Attribute_Single	Return single attribute
–	54 hex	Forward_Open	Opens a connection
–	4E hex	Forward_Close	Closes a connection

TCP/IP interface object (F5 hex)

Class attributes

Attribute ID	Access	Name	Data type	Description	Semantics of values
1	Get	Revision	UINT	Revision of this object	The current value assigned to this attribute is one (01). If updates that require an increase in this value are made, then the value of this attribute increases by 1
2	Get	Max instances	UINT	Maximum instance number of an object currently created in this class level of the device	The largest instance number of a created object at this class hierarchy level
3	Get	Number of instances	UINT	Number of object instances currently created at this class level of the device	The number of object instances at this class hierarchy level

Instance attributes

Attribute ID	Access	Name	Data type	Description	Semantics of values
1	Get	Status	DWORD	Interface status	Bit 0-3: Indicates the status of the interface configuration attribute <ul style="list-style-type: none"> • 0 = The interface configuration attribute has not been configured 1 = The interface configuration attribute contains configuration obtained from BOOTP, DHCP or non-volatile storage 2 = The IP address member of the interface configuration attribute contains configuration, obtained from hardware settings 3-15 = Reserved for future use
2	Get	Configuration capability	DWORD	Interface capability flags	Bit 0: 1 (TRUE) shall indicate the device is capable of obtaining its network configuration via BOOTP Bit 1: 1 (TRUE) shall indicate the device is capable of resolving host names by querying a DNS server Bit 2: 1 (TRUE) shall indicate the device is capable of obtaining its network configuration via DHCP Bit 3: Shall be 0, behavior to be defined in a future specification edition Bit 4: 1 (TRUE) shall indicate the interface configuration attribute is settable Bit 5: 1 (TRUE) shall indicate the IP address member of the interface configuration attribute can be obtained from hardware settings Bit 6: 1 (TRUE) shall indicate that the device requires a restart in order for a change to the interface configuration attribute to take effect

Instance attributes (Continued)

Attribute ID	Access	Name	Data type	Description	Semantics of values
					<p>Bit 7: 1 (TRUE) shall indicate that the device is ACD capable</p> <p>Bit 8-31: Reserved for future use and shall be set to zero</p>
3	Get	Configuration control	DWORD	Interface control flags	<p>Bit 0-3: Determines how the device shall obtain its IP-related configuration</p> <ul style="list-style-type: none"> • 0 = The device shall use statically-assigned IP configuration values 1 = The device shall obtain its interface configuration values via BOOTP 2 = The device shall obtain its interface configuration values via DHCP 3-15 = Reserved for future use <p>Bit 4: 1 (TRUE) shall resolve host names by querying a DNS server</p> <p>Bit 5-31: Reserved for future use and shall be set to zero</p>
4	Get	Physical link object	STRUCT of:	Path to physical link object	This attribute identifies the object associated with the underlying physical communications interface
		Path size	UINT	Size of path	Number of 16 bit words in path
		Path	Padded EPATH	Logical segments identifying the physical link object	The path is restricted to one logical class segment and one logical instance segment. The maximum size is 12 bytes
5	Get	Interface configuration	STRUCT of:	TCP/IP network interface configuration	The interface configuration attribute contains the configuration parameters required for a device to operate as a TCP/IP node. The contents of the interface configuration attribute shall depend upon how the device has been configured to obtain its IP parameters
		IP address	UDINT	The device's IP address	Value of 0 indicates no IP address has been configured. Otherwise, the IP address shall be set to a valid class A, B, or C address and shall not be set to the loopback address (127.0.0.1)
		Network mask	UDINT	The device's network mask	Value of 0 indicates no network mask address has been configured
		Gateway address	UDINT	Default gateway address	Value of 0 indicates no IP address has been configured. Otherwise, the IP address shall be set to a valid class A, B, or C address and shall not be set to the loopback address (127.0.0.1)
		Name server	UDINT	Primary name server	Value of 0 indicates no name server address has been configured. Otherwise, the name server address shall be set to a valid class A, B, or C address
		Name server 2	UDINT	Secondary name server	Value of 0 indicates no secondary name server address has been configured. Otherwise, the name server address shall be set to a valid class A, B, or C address
		Domain name	STRING	Default domain name	ASCII characters. Maximum length is 48 characters. Shall be padded to an even number of characters (pad not included in length). A length of 0 shall indicate no domain name is configured

Instance attributes (Continued)

Attribute ID	Access	Name	Data type	Description	Semantics of values
6	Get	Host name	STRING	Host name	ASCII characters. Maximum length is 64 characters. Shall be padded to an even number of characters (pad not included in length). A length of 0 shall indicate no host name is configured
13	Set	Encapsulation inactivity timeout	UINT	Number of seconds of inactivity before TCP connection or DTLS session is closed	0 = Disable 1-3600 = timeout in seconds Default = 120

Supported class and instance services

Class service code	Instance service code	Service name	Description
–	01 hex	Get_Attribute_All	Return all attributes
0E hex	0E hex	Get_Attribute_Single	Return single attribute
–	10 hex	Set_Attribute_Single	Write one attribute

Ethernet link object (F6 hex)

Class attributes

Attribute ID	Access	Name	Data type	Description	Semantics of values
1	Get	Revision	UINT	Revision of this object	The current value assigned to this attribute is one (01). If updates that require an increase in this value are made, then the value of this attribute increases by 1
2	Get	Max instances	UINT	Maximum instance number of an object currently created in this class level of the device	The largest instance number of a created object at this class hierarchy level
3	Get	Number of instances	UINT	Number of object instances currently created at this class level of the device	The number of object instances at this class hierarchy level
4	Get	Optional attribute list	STRUCT of:	List of optional instance attributes utilized in an object class implementation	A list of attribute numbers specifying the optional attributes implemented in the device for this class
		Number of attributes	UINT	Number of attributes in the optional attribute list	The number of attribute numbers in the list
		Optional attributes	ARRAY of UINT	List of optional attribute numbers	The optional attribute numbers
6	Get	Max ID number of class attribute	UINT	The attribute ID number of the last class attribute of the class definition implemented in the device	-
7	Get	Max ID number of instance attribute	UINT	The attribute ID number of the last instance attribute of the class definition implemented in the device	-

Instance attributes

Attribute ID	Access	Name	Data type	Description	Semantics of values
1	Get	Interface speed	UDINT	Interface speed currently in use	Speed in Mbps
2	Get	Interface flags	DWORD	Interface status flags	<p>Bit 0: Link status indicates whether the IEEE 802.3 communications interface is connected to an active network. 0 indicates an inactive link; 1 indicates an active link</p> <p>Bit 1: Half/Full duplex indicates the duplex mode currently in use. 0 indicates that the interface is running half duplex; 1 indicates full duplex</p> <p>Bit 2-4: Negotiation status</p> <ul style="list-style-type: none"> • 0 = Auto-negotiation in progress • 1 = Auto-negotiation and speed detection failed • 2 = Auto negotiation failed but speed detected • 3 = Successfully negotiated speed and duplex • 4 = Auto-negotiation not attempted <p>Bit 5: Manual setting requires reset</p> <p>Bit 6: 0 indicates the interface detects no local hardware fault; 1 indicates a local hardware fault is detected</p> <p>Bit 7-31: Reserved shall be set to zero</p>
3	Get	Physical address	Array of 6 USINTs	MAC layer address	The recommended display format is "XX-XX-XX-XX-XX-XX", starting with the first octet
7	Get	Interface type	USINT	Type of interface: twisted pair, fiber, internal	<p>Value 0: Unknown interface type</p> <p>Value 1: The interface is internal to the device</p> <p>Value 2: Twisted-pair</p> <p>Value 3: Optical fiber</p> <p>Value 4-255: Reserved</p>
8	Get	Interface state	USINT	Current state of the interface: operational, disabled	<p>Value 0: Unknown interface state</p> <p>Value 1: The interface is enabled and is ready to send and receive data</p> <p>Value 2: The interface is disabled</p> <p>Value 3: The interface is testing</p> <p>Value 4-255: Reserved</p>
10	Get	Interface label	SHORT_STRING	Human readable identification	The interface label attribute shall be a text string that describes the interface. The content of the string is vendor specific.
11	Get	Interface capability	STRUCT of:	Indication of capabilities of the interface	<p>Bit 0: Manual setting requires reset</p> <ul style="list-style-type: none"> • 0 = Indicates that the device automatically applies changes made to the interface control attribute and, therefore, does not require a reset in order for changes to take effect. • 1 = Indicates that the device does not automatically apply changes made to the interface control attribute and, therefore, will require a reset in order for changes to take effect. <p>Bit 1: Auto-negotiate</p> <ul style="list-style-type: none"> • 0 = Indicates that the interface does not support link auto-negotiation • 1 = Indicates that the interface supports link auto-negotiation <p>Bit 2: Auto-MDIX</p>

Instance attributes (Continued)

Attribute ID	Access	Name	Data type	Description	Semantics of values
					<ul style="list-style-type: none"> 0 = Indicates that the interface does not support auto MDIX operation 1 = Indicates that the interface supports auto MDIX operation Bit 2: Manual speed/duplex <ul style="list-style-type: none"> 0 = Indicates that the interface does not support manual setting of speed/duplex. The interface control attribute shall not be supported 1 = Indicates that the interface supports manual setting of speed/duplex via the interface control attribute Bit 4-31: Reserved. Shall be set to 0
		Capability bits	DWORD	Interface capabilities, other than speed/duplex	Bitmap
		Speed/Duplex options	STRUCT of:	Indicates speed/duplex pairs supported in the interface control attribute	-
			USINT	Speed/Duplex array count	Number of elements
			ARRAY of STRUCT of:	Speed/Duplex array	-
			UINT	Interface speed	Speed in Mbps
			USINT	Interface duplex mode	0 = Half duplex 1 = Full duplex 2-255 = Reserved

Supported class and instance services

Service code	Service name	Description
01 hex	Get_Attribute_All	Return all attributes
0E hex	Get_Attribute_Single	Return single attribute

Port object (F4 hex)

Class code

Hexadecimal	Decimal
F4 hex	299

Class attributes

Attribute ID	Access	Name	Data type	Description	Semantics of values
1	Get	Revision	UINT	Revision of this object	The current value assigned to this attribute is one (01). If updates that require an increase in this value are made, then the value of this attribute increases by 1
2	Get	Max instance	UINT	Maximum instance number of an object currently created in this class level of the device	The largest instance number of a created object at this class hierarchy level
3	Get	Number of instances	UINT	Number of object instances currently created at this class level of the device	The number of object instances at this class hierarchy level

Class attributes (Continued)

Attribute ID	Access	Name	Data type	Description	Semantics of values
8	Get	Entry port	UINT	Returns the instance of the port object that describes the port through which this request entered the device	1
9	Get	Port instance info	ARRAY of STRUCT of	Array of structures containing instance attributes 1 and 2 from each instance	The array is indexed by instance number starting with zero, up to the maximum instance number. The values for instance zero and any non-instantiated instances shall be zero
		Port type	UINT	Enumerates the type of port	The vendor assigns values to these three attributes to indicate the type of the port, whether or not it supports routing, and whether it provides a link specific object to make link specific functionality visible to CIP
		Port number	UINT	CIP port number associated with this port	Manufacturer assigns a unique value to identify each communication port. Value 0 is reserved and cannot be used

Instance attributes

Attribute ID	Access	Name	Data type	Description	Semantics of values
1	Get	Port type	UINT	Enumerates the type of port	The vendor assigns value to this attribute to indicate the type of port
2	Get	Port number	UINT	CIP port number associated with this port	Manufacturer assigns a unique value to identify each communication port. Value 0 is reserved and cannot be used
3	Get	Link object	STRUCT of:		The vendor assigns value to this attribute to indicate whether it supports routing, and whether it provides link specific object to make link specific functionality visible to CIP
		Path length	UINT	Number of 16 bit words in the path	
		Link path	Padded EPATH	Logical path segments that identify the object for this port	
4	Get	Port name	SHORT_STRING	String which names the communications interface. The maximum number of characters in the string is 64	This attribute is the vendor assigned name of the communications interface associated with this instance

Instance attributes (Continued)

Attribute ID	Access	Name	Data type	Description	Semantics of values
7	Get	Port number and node address	Padded EPATH	Port segment containing the port number and the link address of the device on this port	The port number and node address value shall be a port segment containing the port number of this port and the link address of this device on the port
10	Get	Port routing capabilities	DWORD	Bit string that defines the routing capabilities of this port	Bit 0: Routing of incoming unconnected messaging supported Bit 1: Routing of outgoing unconnected messaging supported Bit 2: Routing of incoming transport class 0/1 connections supported Bit 3: Routing of outgoing transport class 0/1 connections supported Bit 4: Routing of incoming transport class 2/3 connections supported Bit 5: Routing of outgoing transport class 2/3 connections supported Bit 6: Routing of outgoing DeviceNet CIP safety connections supported Bit 7-31: Reserved

Supported class and instance services

Service code	Service Name	Description
0x0E	Get_Attribute_Single	Used to read a port class attribute value. This service is required if any of the port class attributes are supported

Base energy object (4E hex)

Class code

Hexadecimal	Decimal
4E hex	78

Class attributes

Attribute ID	Access	Name	Data type	Description	Semantics of values
1	Get	Revision	UINT	Revision of this object	The current value assigned to this attribute is two (2)

Instance attributes

Attribute ID	Access	Name	Data type	Description	Semantics of values
1	Get	Energy/resource type	UINT	Specifies the type of energy managed by this energy instance	0: Generic 1: Electrical 2: Non-electrical 3-99: Reserved 100-199: Vendor specific 200-65535: Reserved
2	Get	Base energy object capabilities	UINT	The energy capabilities of the instance	0: Energy measured 1: Energy derived 2: Energy proxy

Instance attributes (Continued)

Attribute ID	Access	Name	Data type	Description	Semantics of values
					3: Energy aggregated 4: Energy rate fixed 5: Non-electrical aggregated 6-65535: Reserved
3	Get	Energy accuracy	UINT	Specifies the accuracy of power and energy metering results	Typical accuracy in 0.01 percent of reading (default) or 0.01 of other units as specified in the energy accuracy basis attribute 0: Unknown
7	Get	Consumed energy odometer	ODOMETER	The consumed energy value	Energy in kWh
8	Get	Generated energy odometer	ODOMETER	The generated energy value	Energy in kWh
9	Get	Net energy odometer	SIGNED_ODOMETER	The total net energy value	Energy in kWh
10	Get	Energy transfer rate	REAL	The time rate of energy consumption or production	Power in kW
12	Get	Energy type specific object path	STRUCT of:	Path to energy type specific object instance	This attribute may contain a path to an electrical energy object instance (class code 0x4F), a path to a non-electrical energy object instance (class code 0x50) or a null path (a path size value of zero (0))
		Path size	UINT	Size of Path (in words)	-
		Path	Padded EPATH	-	-

Supported class and instance services

Service code	Service name	Description
0E hex	Get_Attribute_Single	Used to read a base energy class attribute value

Odometer and Signed_Odometer structure principle

Data type structure		Description of data type element	Semantics of values
ODOMETER STRUCT of:	SIGNED_ODOMETER STRUCT of:	-	-
UINT	INT	$x10^n$	$\pm Unit \times 10^n$
UINT	INT	$x10^{n+3}$	$\pm Unit \times 10^{n+3}$
UINT	INT	$x10^{n+6}$	$\pm Unit \times 10^{n+6}$
UINT	INT	$x10^{n+9}$	$\pm Unit \times 10^{n+9}$
UINT	INT	$x10^{n+12}$	$\pm Unit \times 10^{n+12}$
The valid range of n shall be a SINT between 0 and -15.			

Odometer type in kilowatt-hour units and n = -3

$x10^{n+12}$	$x10^{n+9}$	$x10^{n+6}$	$x10^{n+3}$	$x10^n$
Terawatt-hours (kWh x 10^9)	Gigawatt-hours (kWh x 10^6)	Megawatt-hours (kWh x 10^3)	Kilowatt-hours (kWh)	Watt-hours (kWh x 10^{-3})

Electrical energy object (4F hex)

Class code

Hexadecimal	Decimal
4F hex	79

Class attributes

Attribute ID	Access	Name	Data type	Description	Semantics of values
1	Get	Revision	UINT	Revision of this object	The current value assigned to this attribute is two (2)

Instance attributes

Attribute ID	Access	Name	Data type	Description	Semantics of values
1	Get	Real energy consumed odometer	ODOMETER	The total real energy consumed	0 kWh to 999,999,999,999.999 kWh
2	Get	Real energy generated odometer	ODOMETER	The total real energy generated	0 kWh to 999,999,999,999.999 kWh
3	Get	Real energy net odometer	SIGNED ODOMETER	The running total of real energy consumed minus real energy generated	-999,999,999,999.999 kWh to 999,999,999,999.999 kWh
4	Get	Reactive energy consumed odometer	ODOMETER	The total reactive power consumed	0 kVARh to 999,999,999,999.999 kVARh
5	Get	Reactive energy generated odometer	ODOMETER	The total reactive power generated	0 kVARh to 999,999,999,999.999 kVARh
6	Get	Reactive energy net odometer	SIGNED ODOMETER	The running total of reactive energy consumed minus reactive energy generated	-999,999,999,999.999 kVARh to 999,999,999,999.999 kVARh
7	Get	Apparent energy odometer	ODOMETER	The total apparent energy consumed	Range from 0 kVAh to 999,999,999,999.999 kVAh
9	Get	Line frequency	REAL	Line Frequency in Hertz	Hz
10	Get	L1 current	REAL	RMS line current in L1	Amps (A)
11	Get	L2 current	REAL	RMS line current in L2	Amps (A)
12	Get	L3 current	REAL	RMS line current in L3	Amps (A)
13	Get	Average current	REAL	RMS line current of three-phase average	Amps (A)
14	Get	Percent current unbalance	REAL	Percentage current deviation between phases	Percent
15	Get	L1-N voltage	REAL	RMS line to neutral voltage of L1	Volts (V)
16	Get	L2-N voltage	REAL	RMS line to neutral voltage of L2	Volts (V)
17	Get	L3-N voltage	REAL	RMS line to neutral voltage of L3	Volts (V)
18	Get	Average L-N voltage	REAL	RMS line to neutral voltage of three-phase average	Volts (V)
19	Get	L1-L2 voltage	REAL	RMS L1 to L2 voltage	Volts (V)
20	Get	L2-L3 voltage	REAL	RMS L2 to L3 voltage	Volts (V)
21	Get	L3-L1 voltage	REAL	RMS L3 to L1 voltage	Volts (V)
22	Get	Average L-L voltage	REAL	RMS line to line voltage three-phase average	Volts (V)

Instance attributes (Continued)

Attribute ID	Access	Name	Data type	Description	Semantics of values
23	Get	Percent voltage unbalance	REAL	Percentage voltage deviation between phases	Percent
24	Get	L1 real power	REAL	L1 real power, signed to show direction	Watts (W)
25	Get	L2 real power	REAL	L2 real power, signed to show direction	Watts (W)
26	Get	L3 real power	REAL	L3 real power, signed to show direction	Watts (W)
27	Get	Total real power	REAL	Total real power, signed to show direction	Watts (W)
28	Get	L1 reactive power	REAL	L1 reactive power, signed to show direction	Volt-amps reactive (VAR)
29	Get	L2 reactive power	REAL	L2 reactive power, signed to show direction	Volt-amps reactive (VAR)
30	Get	L3 reactive power	REAL	L3 reactive power, signed to show direction	Volt-amps reactive (VAR)
31	Get	Total reactive power	REAL	Total reactive power, signed to show direction	Volt-amps reactive (VAR)
32	Get	L1 apparent power	REAL	L1 apparent power	Volt-amps (VA)
33	Get	L2 apparent power	REAL	L2 apparent power	Volt-amps (VA)
34	Get	L3 apparent power	REAL	L3 apparent power	Volt-amps (VA)
35	Get	Total apparent power	REAL	Total apparent power	Volt-amps (VA)
36	Get	L1 true power factor	REAL	L1 ratio between power and apparent power	Percent
37	Get	L2 true power factor	REAL	L2 ratio between power and apparent power	Percent
38	Get	L3 true power factor	REAL	L3 ratio between power and apparent power	Percent
39	Get	Three phase true power factor	REAL	Ratio between power and apparent power	Percent
40	Get	Phase rotation	UINT	The phase rotation of a three-phase system	0 = None 1 = ABC 2 = ACB
41	Get	Associated base energy object path	STRUCT of:	Path to associated base energy object instance	03 00 21 00 4E 00 24 01
		Path size	UINT	Size of path (in words)	
		Path	Padded EPATH	-	

Class and instance services

Service code	Service name	Description
0E hex	Get_Attribute_Single	Used to read a electrical energy class attribute value

DNP3

NOTE: The DNP3 over Ethernet is available in firmware version 10.7.1 and above for PM5561 meter model and firmware version 2.7.4 and above for PM5560 / PM5563 meter models. Not available in PM5562 / PM5562MC meter models.

The Distributed Network Protocol Version 3.0 (DNP3) is a multipoint communication protocol which specifies the coding of data and rules for exchanging the data between a slave device and a master control device. DNP3 is an open protocol which can be implemented on any communication device. The DNP3 is available on Ethernet communication.

The DNP3 protocol specifies the data that can be exchanged and the form in which they are transmitted.

DNP3 device profile

The meter can be integrated into a DNP network as a DNP slave (pre-configured for basic DNP slave functionality).

The meter supports a maximum of three concurrent connections (sessions) using the DNP3 protocol.

The DNP3 is disabled by default. You can modify the meter’s default DNP3 settings using webpages and HMI. The data can be imported into the meter from a DNP control relay or an analog output device.

The primary objects of the DNP3 are as follows:

- Analog input
- Binary counter
- Binary input

DNP3 device profile document

Vendor name: Schneider Electric	
Device name: PM5XXX	
Highest DNP level supported: For requests: Level 2 For responses: Level 2	Device function: Master Slave
For static (non-change-event) object requests, request qualifier codes 07 and 08 (limited quantity), and 17 and 28 (index) are supported. Static object requests sent with qualifiers 07 or 08 are responded with qualifiers 00 or 01. 16-bit, 32-bit and floating point functions are supported.	
Maximum data link frame size (octets): Transmitted: 292 Received: 292	Maximum application fragment size (octets): Transmitted: 50 to 248 Received: 2048
Maximum data link re-tries: None Fixed	Maximum application layer re-tries: None Configurable
Requires data link layer confirmation: Never Always Sometimes	
Requires application layer confirmation: Never Always When reporting event data (Slave devices only) Sometimes	
Timeouts while waiting for:	
Data link confirm:	None Fixed at ____ Variable Configurable None Variable

DNP3 device profile document (Continued)

Complete appl. fragment:	None	Fixed at ____	Variable	Configurable
Application confirm:	None	Fixed at 10 s	Variable	Configurable
Complete appl. response:		Fixed at ____		Configurable
Sends/Executes control operations:				
WRITE binary outputs:	Never	Always	Sometimes	Configurable
SELECT/OPERATE:	Never	Always	Sometimes	Configurable
DIRECT OPERATE:	Never	Always	Sometimes	Configurable
DIRECT OPERATE – NO ACK:	Never	Always	Sometimes	Configurable
Count > 1	Never	Always	Sometimes	Configurable
Pulse on	Never	Always	Sometimes	Configurable
Pulse off	Never	Always	Sometimes	Configurable
Latch on	Never	Always	Sometimes	Configurable
Latch off	Never	Always	Sometimes	Configurable
Queue	Never	Always	Sometimes	Configurable
Clear queue	Never	Always	Sometimes	Configurable
Attach explanation if 'Sometimes' or 'Configurable' was checked for any operation.				
Reports binary input change events when no specific variation requested: Never Only time-tagged Only non-time-tagged	Reports time-tagged binary input change events when no specific variation requested: Never Binary input change with time Binary input change with relative time			
Sends unsolicited responses: Never Configurable - enable/disable Only certain objects Sometimes (attach explanation) ENABLE/DISABLE UNSOLICITED function codes supported	Sends static data in unsolicited responses: Never When device restarts When status flags changes No other options are permitted			
Default counter object/variation: No counters reported Configurable Default object Default variation Point-by-point list attached	Counters roll over at: No counters reported Configurable 16 bits 32 bits Other value ____ Point-by-point list attached			

DNP3 device profile document (Continued)

Sends multi-fragment responses:		
Yes		
No		
Sequential file transfer support:		
Append file mode	Yes	No
Custom status code strings	Yes	No
Permissions field	Yes	No
File events assigned to class	Yes	No
File events send immediately	Yes	No
Multiple blocks in a fragment	Yes	No
Max number of files open	0	

DNP3 implementation objects

Object			Request (Slave must parse)		Response (Master must parse)	
Objects	Variation	Description	Functional codes (dec)	Qualifier codes (hex)	Functional codes (dec)	Qualifier codes (hex)
1	0	Binary input - Any variation	1	00,01,06,07,08,17,28	-	-
1	1	Binary input	1	00,01,06,07,08,17,28	129	00,01,17,28
1	2	Binary input with status	1	00,01,06,07,08,17,28	129	00,01,17,28
20	0	Binary counter - Any variation	1	00,01,06,07,08,17,28	-	-
			7,8	0,01,06,07,08	-	-
20	1	32-bit binary counter	1	00,01,06,07,08,17,28	129	00,01,17,28
20	2	16-bit binary counter	1	00,01,06,07,08,17,28	129	00,01,17,28
20	5	32-bit binary counter without flag	1	00,01,06,07,08,17,28	129	00,01,17,28
20	6	16-bit binary counter without flag	1	00,01,06,07,08,17,28	129	00,01,17,28
30	4	16-bit analog input without flag	1	00,01,06,07,08,17,28	129	00,01,17,28
30	5	Short floating point	1	00,01,06,07,08,17,28	129	00,01,17,28
30	6	Long floating point	1	00,01,06,07,08,17,28	129	00,01,17,28
50	0	Time and date - Any variation	-	-	-	-
			1	00,01,06,07,08	129	00,01,17,28
50	1	Time and date	2	07, quantity = 1	-	-
			-	-	-	-
52	0	Time delay - All variations	-	-	-	-
52	1	Time delay coarse	-	-	129	07, quantity = 1
52	2	Time delay fine	-	-	129	07, quantity = 1
60	0	Not defined	-	-	-	-
60	1	Class 0 data	1	06,07,08	-	-
60	2	Class 1 data	1	06,07,08	-	-
60	3	Class 2 data	1	06,07,08	-	-
60	4	Class 3 data	1	06,07,08	-	-

Default DNP3 configuration

Analog input objects

16-bit analog input without flag (Object 30, Variation 4)	
Point	Measurement
0	VIn a
1	VIn b
2	VIn c
3	VIn avg
4	VII ab
5	VII bc
6	VII ca
7	VII avg
8	I a
9	I b
10	I c
11	I avg
12	kW a
13	kW b
14	kW c
15	kW tot
16	kVAR a
17	kVAR b
18	kVAR c
19	kVAR tot
20	kVA a
21	kVA b
22	kVA c
23	kVA tot
24	PFsign a
25	PFsign b
26	PFsign c
27	PFsign tot
28	V unbal (Voltage unbalance L-L worst)
29	I unbal (Current unbalance worst)
30	I4
31	Freq
32	kW sd del-rec2
33	kVAR sd del-rec3
34	kVA sd del+rec3
35*	I5
36*	I6
37*	A1 Raw value
38*	A1 Scaled value
39*	A2 Raw value

16-bit analog input without flag (Object 30, Variation 4)	
Point	Measurement
40*	A2 Scaled value

*Available in specific meter models. Refer to Features differentiation matrix for PM5500 / PM5600 / PM5700 series, page 20 for the availability.

Binary counter objects

16-bit binary counter without flag (Object 20, Variation 6)	
Point	Measurement
0	kWh del (Import)
1	kWh rec (Export)
2	kWh del+rec (Total)
3	kWh del-rec (Net)
4	kVARh del (Import)
5	kVARh rec (Export)
6	kVARh del+rec (Total)
7	kVARh del-rec (Net)
8	kVAh del+rec (Total)

Binary input objects

16-bit binary input without flag (Object 1)	
Point	Measurement
0	Digital input 1
1	Digital input 2
2	Digital input 3*
3	Digital input 4*
4	Digital output 1
5	Digital output 2

*Available in specific meter models. Refer to Features differentiation matrix for PM5500 / PM5600 / PM5700 series, page 20 for the availability.

Configuring DNP3 setting using the display

The Ethernet setup screen on the meter allows you to configure DNP3 communication.

1. Navigate to **Maint > Setup**.
2. Enter the setup passcode (default is "0"), then press **OK**.
3. Navigate to **Comm > Enet**.
4. Move the cursor to point to the parameter **DNP3** you want to modify, then press **Edit**.
5. Modify the parameter as required (**Enabled/Disabled**), then press **OK**.

6. Press the up arrow to exit.
7. Press **Yes** to save your changes.

Configuring DNP3 setting using the webpages

NOTE: Refer to Restoration of temporarily disabled configuration settings in webpages, page 235 to know availability of these features on your meter model.

You can use the meter's webpages to configure DNP3 settings.

1. Login to the meter webpages.
2. Based on your meter firmware version, click **Settings > DNP3 Settings** OR click **Settings > Communication > DNP3 Settings**.
3. Click **Yes** to enable DNP3 or click **No** to disable DNP3 as required.
4. Click **Save changes** or **Apply Changes** to send and save the new settings to the meter.

Modbus Ethernet gateway

A Modbus Ethernet gateway allows multiple Modbus masters on the LAN/WAN to connect to downstream serial Modbus slave devices.

A Modbus master device, such as an energy management system, can communicate through the gateway meter to a serial network of devices connected to the gateway meter's serial port(s). The meter receives Modbus TCP/IP data on TCP port 502, translates it to Modbus RTU then forwards it to the addressed slave device.

This functionality allows the use of monitoring software to access information from slave devices for data collection, trending, alarm/event management, analysis, and other functions.

Ethernet gateway implementation

There is specific implementation information to consider when using your meter as an Ethernet gateway.

Firmware support

The Ethernet gateway functionality is available on firmware version 2.0.1 or later.

Addressing

You can use slave address 255 or the Unit ID configured in the gateway meter's serial settings to send a request to the gateway-enabled meter itself. Messages addressed with other unit IDs are forwarded by the gateway meter to the RS-485 slave devices.

Broadcast messages

The gateway meter always processes broadcast messages (in other words, messages sent to Unit ID 0). You can configure whether or not broadcast messages are forwarded to the slave devices.

Modbus master TCP/IP connections

The maximum number of Modbus master TCP connections allowed for the Ethernet gateway is configurable. It is the same as the maximum number of total Modbus TCP/IP connections that are configured on the gateway-enabled meter.

Ethernet gateway configuration

Configuring the meter as an Ethernet gateway using the webpages

NOTE: Refer to *Restoration of temporarily disabled configuration settings in webpages*, page 235 to know availability of these features on your meter model.

The meter can function as an Ethernet gateway, allowing Ethernet access to serial devices connected to the meter's RS-485 serial communications port.

You must install the serial Modbus slave devices, configure them and connect them to your Ethernet-connected Modbus gateway meter. Ensure that each serial device is configured to communicate over Modbus with the same baud rate and parity as the gateway device, and that each device, including the gateway, has a unique unit ID.

The only configuration required for the meter to function as a gateway is to set the serial port's mode. You can configure other settings, depending on your requirements and network.

NOTE: The protocol of the serial port must be set to Modbus RTU or Jbus for the meter to function as a gateway.

1. Login to the meter webpages.
2. Based on your meter firmware version, click **Settings > Serial Settings** OR click **Settings > Communication > Serial Port Configuration**.
3. Set **Mode** to **Gateway** to enable the gateway feature or to **Slave** to disable it.
4. Set **Modbus Broadcast** to **Enabled** if you want broadcast messages to be forwarded to the connected slave devices.
5. Configure the other advanced parameters required by your system.

- Based on your meter firmware version, navigate to **Settings > Advanced Ethernet Settings** OR navigate to **Settings > Communication > Advanced Ethernet Settings** and change the **Modbus TCP/IP Server Connections** to adjust the maximum number of Modbus TCP connections allowed.

Modbus Ethernet gateway settings available using the webpages

Parameter	Value	Description
Response Timeout	0.1, 0.2, 0.3, 0.4, 0.5, 1, 2, 3, 4, 5, 6, 7, 8, 9, 10	Set the time the gateway meter waits for an answer from a downstream serial device before generating an exception response.
Delay Between Frames	0, 10, 20, 30, 40, 50, 60, 70, 80, 90, 100	The minimum time in milliseconds between the end of a received response and the beginning of a new request. Set this parameter to help improve communications between the gateway and downstream slave devices with slower response times.
Silent Interval Extension	0 – 15	Set this parameter to extend the silent interval (used to mark the end of a Modbus packet) beyond the default 3.5 characters defined in the Modbus standard. After the defined character time elapses without a new character, the gateway meter treats the next character as the start of a new message.

NOTE: These are advanced settings that you can adjust if you have communication errors when communicating through the gateway to the downstream serial devices. They only apply if the meter is functioning as a gateway, and you should only change these settings if you have an advanced knowledge of Modbus communications and your communications network.

Configuring the meter as an Ethernet gateway using ION Setup

The meter can function as an Ethernet gateway, allowing Ethernet access to serial devices connected to the meter's RS-485 serial communications port.

You must install the serial Modbus slave devices, configure them and connect them to your Ethernet-connected Modbus gateway meter. Ensure that each serial device is configured to communicate over Modbus with the same baud rate and parity as the gateway device, and that each device, including the gateway, has a unique unit ID.

The only configuration required for the meter to function as a gateway is to set the serial port's mode. You can configure other settings, depending on your requirements and network.

NOTE: The protocol of the serial port must be set to Modbus RTU or Jbus for the meter to function as a gateway.

- Start ION Setup and connect to your meter.
- Open the **Advanced Serial Settings** screen in the **RS-485 Comm Setup** folder.
- Set **Mode** to Master Mode to enable the gateway feature or to Slave Mode to disable it.
- Set **Modbus Broadcast** to Enabled if you want broadcast messages to be forwarded to the connected slave devices.
- Configure the other advanced parameters required by your system.
- Click **Send** to save your changes to the meter.

- Use the meter webpages if you want to adjust the maximum number of Modbus TCP connections allowed.

Modbus Ethernet gateway settings available using ION Setup

Parameter	Value	Description
Response Timeout	0.1, 0.2, 0.3, 0.4, 0.5, 1, 2, 3, 4, 5, 6, 7, 8, 9, 10	Set the time the gateway meter waits for an answer from a downstream serial device before generating an exception response.
Delay Between Frames	0, 10, 20, 30, 40, 50, 60, 70, 80, 90, 100	The minimum time in milliseconds between the end of a received response and the beginning of a new request. Set this parameter to help improve communications between the gateway and downstream slave devices with slower response times.
Silent Interval Extension	0 – 15	Set this parameter to extend the silent interval (used to mark the end of a Modbus packet) beyond the default 3.5 characters defined in the Modbus standard. After the defined character time elapses without a new character, the gateway meter treats the next character as the start of a new message.

NOTE: These are advanced settings that you can adjust if you have communication errors when communicating through the gateway to the downstream serial devices. They only apply if the meter is functioning as a gateway, and you should only change these settings if you have an advanced knowledge of Modbus communications and your communications network.

Modbus TCP/IP filtering

The Modbus TCP/IP filtering feature lets you specify the access rights to the meter, using Modbus communications, for specified IP addresses plus the access rights for anonymous IP addresses.

This feature determines the access to the meter and any downstream serial devices if the meter is functioning as a Modbus gateway.

Modbus TCP/IP filtering implementation

You can specify the Modbus access rights for up to 10 unique IP addresses and for anonymous IP addresses.

By default, Modbus TCP/IP filtering is disabled and all IP addresses have full access to the meter and any downstream serial devices.

Access levels

You can set the level of access for each configured IP address, as well as for anonymous IP addresses.

Access level	Description
Read-only	This setting allows only the following function codes to be sent to the meter and any downstream serial devices from the specified IP address: 01 (0x01), 02 (0x02), 03 (0x03), 04 (0x04), 07 (0x07), 08 (0x08), 11 (0x0B), 12 (0x0C), 17 (0x11), 20 (0x14), 24 (0x18), 43 (0x2B) and 100 (0x64)
Full	This setting allows any Modbus function code to be sent to the meter and any downstream serial devices from the specified IP address.
None	This setting denies access to anonymous IP addresses.

Configuring Modbus TCP/IP filtering using the webpages

NOTE: Refer to Restoration of temporarily disabled configuration settings in webpages, page 235 to know availability of these features on your meter model.

You can configure access rights for any valid IP address, plus any anonymous IP addresses.

1. Login to the meter webpages.
2. Based on your meter firmware version, click **Settings > Modbus TCP/IP filtering** OR click **Settings > Communication > IP filtering**.
3. Click **Enable Filtering** to enable Modbus TCP/IP filtering.
The IP address fields become editable, except for the anonymous IP address field, which is indicated by asterisks (**.*.*.*.*).
4. Set the access for anonymous IP addresses.
NOTE: If Modbus TCP/ IP filtering is enabled, anonymous IP addresses can only have read-only or no access; they cannot have full access.
5. Enter the other IP addresses that you want to be able to access the meter and any downstream serial devices.
6. Set the access level for each specified IP address.
NOTE: If duplicate IP addresses are entered, the second listing and its access level are discarded when you save the changes.

Simple Network Management Protocol (SNMP)

Your meter supports SNMP once you have enabled SNMP on your meter. You need to upload the meter's MIB file (available from www.se.com) into the NMS managing your meter.

Simple Network Management Protocol (SNMP) is part of the Transmission Control Protocol/Internet Protocol (TCP/IP) protocol suite. SNMP is an application layer protocol that enables the exchange of network management information between devices, allowing you to manage network performance and to identify and solve problems on networks with devices of various types.

SNMP configuration assumes that you have an advanced understanding of SNMP and the communications network and power system that your meter is connected to.

Key terms

Term	Definition
Agent	Software resident on the managed device which interfaces between the device and the NMS.
Managed device	Your meter in the SNMP network.
Community name/string	A text string that helps authenticate requests between the managed device and the NMS.
Managed object	Any parameter referenced in the MIB file.
MIB	A management information base which organizes the OIDs in a hierarchical tree.
NMS	A network management station, manager or client that executes applications to monitor and control devices. An NMS must have the standard and custom MIB files and SNMP manager software.
OID	An object identifier that uniquely identifies and labels a managed object in the MIB.
Trap receiver	An NMS that is configured to receive traps and whose IP address is an SNMP trap destination.

The meter in an SNMP system

Your meter is a managed device with an SNMP agent in an SNMP network.

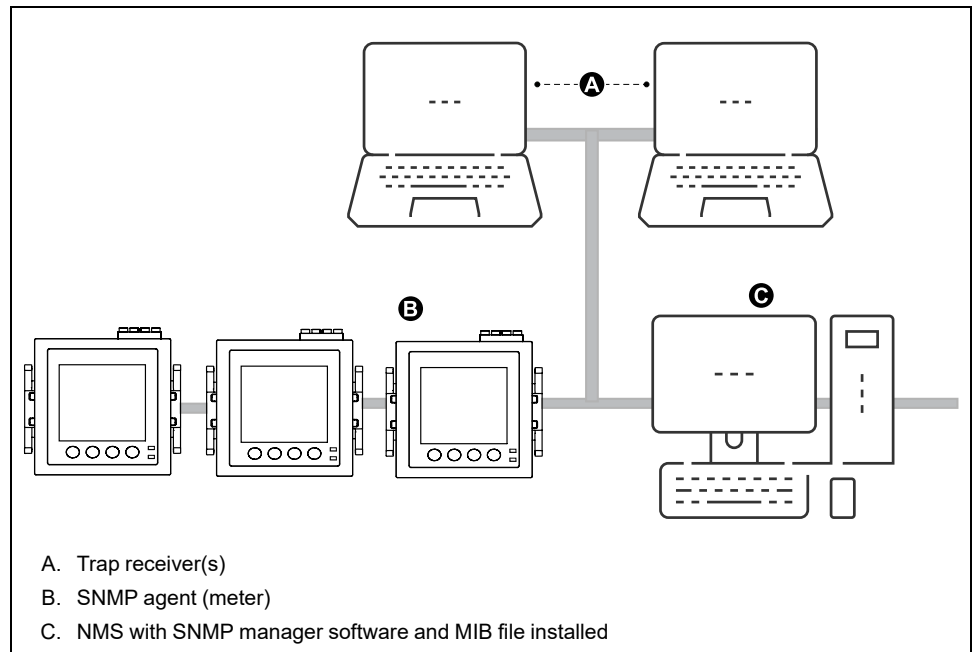

NOTE: The NMS computer can also function as a trap receiver.

SNMP implementation

Your meter supports SNMP after you upload the meter’s MIB file into the NMS managing your meter.

By default, SNMP communication is enabled and SNMP trapping is disabled. Use the meter’s webpages to enable / disable SNMP and configure SNMP parameters.

Supported requests

Your meter supports get and get-next requests (read-only).

MIB file

The MIB file is a human-readable text file. Besides being required by your NMS, you can use it to determine the objects the meter supports and their object IDs.

SNMP requires that you load your meter's MIB file (available for download from www.se.com) into the NMS. The MIB filename is SchneiderPM5xxx_Vyy_zz.MIB, where yy is the major revision and zz is the minor revision.

Your meter is compliant with MIB-II as defined by the standard MIB file RFC 1213. You must install RFC 1213, which is required to read basic network information for the meter (for example, TCP/IP traffic or number of packets received), if it is not included with your SNMP manager software.

Community names

A community name is a text string which acts to help authenticate requests from the NMS to your meter. There are two configurable community names on your meter:

- Read-only Community: this community name's initial factory-set value is public.
- Read-write Community: this community name's initial factory-set value is private.

If your meter receives an incorrect community string, it generates an AuthenticationFailure trap.

System variables

A system variable is a text string which can be configured to provide information about your meter. There are three system variables on your meter:

- System contact: the name of the SNMP system administrator.
- System name: a descriptive name for your meter or the system where it is installed.
- System location: a description of your meter's location.

SNMP ports

The meter is configured to use standard SNMP ports to receive requests.

Port	Description
161	Receives requests When the SNMP agent (the meter) receives a request on port 161, a response is sent to the source port on the NMS.
162	Receives notifications (traps)

The meter sends notifications from any available port.

SNMP trapping

SNMP trapping allows your meter's agent to notify the NMS of events with an unsolicited SNMP message (a "trap" of the meter's alarm event).

SNMP trapping is only supported on SNMP v1.

Supported generic traps

SNMP generic traps supported by your meter are:

- coldStart: the meter (SNMP agent) is starting, and its configuration may have been altered.
- warmStart: the meter (SNMP agent) is starting, and its configuration has not been altered.
- linkDown: there is a failure in the communications link between the meter (SNMP agent) and the NMS.
- linkUp: the SNMP agent is enabled and the communications link is established.
- authenticationFailure: the meter (SNMP agent) has received an incorrect community value.

Supported enterprise-specific traps

Your meter sends SNMP traps to the NMS for all high, medium and low priority alarms configured on the meter. The trap includes information about the alarm, such as the alarm label or description, timestamp, state, priority, value of the parameter when the alarm occurred, and the alarm type.

Trap IP addresses

You can enter up to two IPv4 IP addresses for SNMP trap notification.

Configuring SNMP using the webpages

NOTE: Refer to Restoration of temporarily disabled configuration settings in webpages, page 235 to know availability of these features on your meter model.

You can configure your meter's SNMP settings using the webpages.

1. Login to the meter webpages.
2. Based on your meter firmware version, click **Settings > SNMP Settings** OR click **Settings > Communication > SNMP Settings**.

3. Modify the settings as required.

SNMP parameters available using the webpages

Parameter	Values	Description
Enable SNMP	Yes / No	Enables or disables SNMP on your meter
System Contact	—	Enter the name of your SNMP administrator
System Name	—	Enter a descriptive name for your meter
System Location	—	Enter your meter's location
Read-only Community Name / Write-only Community Name	—	Enter the community name used for SNMP requests NOTE: It is highly recommended to set a community name that best meets your security guidelines. The community Name must contain between 8 and 16 characters with at least 1 uppercase, 1 lowercase and 1 special character. *The special characters allowed are "@#%&".
Enable SNMP Traps	Yes / No	Enables SNMP trapping on your meter
Trap Receiver 1 IP Address / Trap Receiver 2 IP Address	—	Enter up to 2 trap receiver IP addresses where trap messages are sent

*Available only in latest firmware versions:

- PM5560 / PM5562 / PM5563 / PM5580 meter models: 4.0.0 and above
- PM5570 / PM5660 / PM5760 meter models: 6.0.0 and above
- PM5650 meter model: 4.10.0 and above
- PM5561 meter model: 12.0.0 and above
- PM5661 / PM5761 meter models: 14.0.0 and above
- PM5570L / PM5660L / PM5760L meter models: 6.0.0 and above

FTP

Your meter has an internal FTP server that you can use to load files and upgrade your meter and meter accessories.

FTP (File Transfer Protocol) is a standard, client-server network protocol used to transfer files over Ethernet networks.

NOTE: To use FTP service for firmware versions mentioned in column (C) of Table Meter models and firmware versions, page 235, the user must have accessed the meter webpage and set user account credentials at least once. If this is already done, enable FTP (secured or unsecured) through webpage or meter display or ION Setup. Subsequently you can use valid Administrator user account credentials to access the FTP server. After the FTP service is enabled, ensure that the meter display screen is set to **Summary** page.

FTP file structure

Your meter's FTP server contains fw and www / wwwroot folder.

- fw: this folder is where you can load firmware upgrade files for your meter and the meter's Ethernet card.
- www / wwwroot: this folder is where the meter's default webpages are stored.

NOTE: The firmware upgrade process through FTP is only applicable for meter models with firmware versions mentioned in column (A) and column (B) of Table Meter models and firmware versions, page 235.

FTP file permissions

Based on your meter firmware version, you must use an user account assigned to the **Product Master** group or **Administrator** role in order to access the meter's FTP server.

FTP filename requirements

FTP filenames cannot include: spaces, “,” \, /, *, ?, <, >, and are limited to 68 characters in length, including the file extension.

Enabling and disabling the FTP server using the display

NOTE: Refer to Restoration of temporarily disabled configuration settings in webpages, page 235 to know availability of these features on your meter model.

The Ethernet setup screen on the meter allows you to enable/disable FTP server.

1. Navigate to **Maint > Setup**.
2. Enter the setup passcode (default is “0”), then press **OK**.
3. Navigate to **Comm > Enet**.
4. Move the cursor to point to the parameter **FTP** you want to modify, then press **Edit**.
5. Modify the parameter as required (**Enabled/Disabled**), then press **OK**.
6. Press the up arrow to exit.
7. Press **Yes** to save your changes.

NOTE: The FTP goes to default state (**Disabled**):

- After 20 mins of being idle
- After every power-on
- After every firmware upgrade

To retain the FTP in **Enabled** state even after any of the above conditions have occurred, upgrade your meter to the latest firmware version:

- **PM5560 / PM5562 / PM5563 / PM5580 meter models: 4.0.0 and above**
- **PM5570 / PM5660 / PM5760 meter models: Firmware upgrade not supported. Contact Schneider Electric Technical Support for help**
- **PM5650 meter model: 4.10.0 and above**
- **PM5561 meter model: 12.0.0 and above**
- **PM5661 / PM5761 meter models: Firmware upgrade not supported. Contact Schneider Electric Technical Support for help**

NOTE: For the following firmware versions, the FTP is always retained in **Enabled** state once you have enabled the FTP:

- **PM5560 / PM5562 / PM5563 / PM5580 meter models: 4.0.0 and above**
- **PM5570 / PM5660 / PM5760 meter models: 6.0.0 and above**
- **PM5650 meter model: 4.10.0 and above**
- **PM5561 meter model: 12.0.0 and above**
- **PM5661 / PM5761 meter models: 14.0.0 and above**
- **PM5570L / PM5660L / PM5760L meter models: 6.0.0 and above**

Enabling and disabling the FTP server using the webpages

NOTE: Refer to Restoration of temporarily disabled configuration settings in webpages, page 235 to know availability of these features on your meter model.

The FTP server on the meter needs to be enabled for certain meter functionality.

NOTE: The FTP server is **Disabled** by default for security reasons. You can **Enable** the FTP server, if required. It is recommended to use encrypted FTP (FTPS).

1. Login to the meter webpages.
2. Based on your meter firmware version, click **Settings > Advanced Ethernet Settings** OR click **Settings > Communication > Advanced Ethernet Settings**.
3. Set **FTP Server** to Enabled or Disabled.
4. Click **Save Changes** or **Apply Changes** to save your changes to the meter.

Time and timekeeping

Setting the clock using the display

The Clock setup screens allow you to set the meter's date and time.

NOTE: You must always set or sync the meter time to UTC (GMT, Greenwich Mean Time), not local time. Use the **GMT Offset (h)** setup parameter to display the correct local time on the meter.

1. Navigate to **Maint > Setup**.
2. Enter the setup passcode (default is "0"), then press **OK**.
3. Navigate to **Clock**.
4. Move the cursor to point to the parameter you want to modify, then press **Edit**.
5. Modify the parameter as required, then press **OK**.
6. Move the cursor to point to the next parameter you want to modify, press **Edit**, make your changes, then press **OK**.
7. Press the up arrow to exit.
8. Press **Yes** to save your changes.

Parameter	Values	Description
Date	DD/MM/YY MM/DD/YY YY/MM/DD	Set the current date using the format displayed on screen, where DD = day, MM = month and YY = year.
Time	HH:MM:SS (24 hour format) HH:MM:SS AM or PM	Use the 24-hour format to set the current time in UTC (GMT).
Meter Time	GMT, Local	Select GMT if you set the current time to Greenwich Mean Time zone. Otherwise, select Local.
GMT Offset (h) ⁶	± HH.0	Available only when Meter Time is set to Local. Set the GMT Offset between ± 00.0 and ± 12.0

To configure the clock using ION Setup, see the section for your meter in the ION Setup online help or in the ION Setup device configuration guide, available for download at www.se.com.

Setting the meter's clock manually using the webpages

NOTE: Refer to Restoration of temporarily disabled configuration settings in webpages, page 235 to know availability of these features on your meter model.

You can set the meter's clock manually using the webpages.

NOTE: You can only set the time manually if **Enable Network Time Synchronization** is set to **No**.

1. Login to the meter webpages.
2. Based on your meter firmware version, click **Settings > Date/Time Settings** OR click **Settings > Communication > Date Time Settings**.

⁶ Currently supports whole integers only.

- Use the dropdown lists to set the time and date you want to send to the meter.

NOTE: The default entry is the current date and time on the meter.

- Click **Save changes** or **Apply Changes** to save the time to your meter.

Configuring time and time synchronization using the webpages

NOTE: Refer to Restoration of temporarily disabled configuration settings in webpages, page 235 to know availability of these features on your meter model.

You can configure time and time synchronization using the webpages.

- Login to the meter webpages.
- Based on your meter firmware version, click **Settings > Date/Time Settings** OR click **Settings > Communication > Date Time Settings**.
- Click **Yes** beside **Enable Network Time Synchronization** if you want to use an SNTP server to synchronize the meter's clock.

- Set the **Poll Interval** to specify how often the meter synchronizes over SNTP.
- Enter the IP address for the **Primary SNTP server** and **Secondary SNTP server**.

NOTE: **Last Successful Time Synchronization** displays the date and time of the last synchronization over SNTP and the IP address of the server that sent the signal.

- Enter the meter's clock settings and click **Save changes** or **Apply Changes**.

Parameter	Values	Description
Time Zone Offset	UTC, UTC±H	Select UTC to display the current time in UTC (Greenwich Mean Time zone). To display local time, set this parameter to the UTC offset for your local time. For example, to display the local standard time in San Fransisco on the meter, select UTC-8. NOTE: You must either enable automatic daylight savings time adjustment or manually update this setting to account for daylight savings time.
Enable Automatic Daylight Savings Time Adjustment	Yes, No	Set this to Yes to automatically update the time to account for daylight savings time, then enter the start and end date and time for daylight savings time.
Daylight Savings Time Begins / Daylight Savings Time Ends	—	Select the start and end date and time for daylight savings time in the meter's location.

Logging

Data log

The meter is shipped from the factory with data logging enabled for selected values.

Typically, delivered energy (kWh, kVARh and kVAh) is logged by default, but you can configure the meter to record other measurements, such as received energy, input metering accumulations and peak demand values from previous demand intervals.

Setting up the data log

You can select up to 14 items to record in the data log and the frequency (logging interval) that you want those values updated.

Use ION Setup to configure data logging.

<i>NOTICE</i>
DATA LOSS
Save the contents of the data log before configuring it.
Failure to follow these instructions can result in data loss.

1. Start ION Setup and open your meter in setup screens mode (**View > Setup Screens**). See the ION Setup Help for instructions.
2. Double-click **Data Log #1**.
3. Set up the logging frequency and measurements/data to log.
4. Click **Send** to save the changes to the meter.

Parameter	Values	Description
Status	Enable, Disable	Set this parameter to enable or disable data logging in the meter.
Interval	1 minute, 5 minutes, 10 minutes, 15 minutes, 30 minutes, 1 hour, 24 hours	Select a time value to set the logging frequency.
Channels	Items available for logging can vary based on the meter type.	Select an item to record from the "Available" column, then click the double-right arrow button to move the item to the "Selected" column. To remove an item, select it from the "Selected" column then click the double-left arrow button.

Saving the data log contents using ION Setup

You can use ION Setup to save the contents of the data log.

1. Start ION Setup and open your meter in data screens mode (**View > Data Screens**). See the ION Setup help for instructions.
2. Double-click **Data Log #1** to retrieve the records.

3. Once the records have finished uploading, right-click anywhere in the viewer and select **Export CSV** from the popup menu to export the entire log.
NOTE: To export only selected records in the log, click the first record you want to export, hold down the SHIFT key and click the last record you want to export, then select **Export CSV** from the popup menu.
4. Navigate to the folder where you want to save the data log file, then click **Save**.

Setting up device log exports using the webpages

NOTE: Refer to Restoration of temporarily disabled configuration settings in webpages, page 235 to know availability of these features on your meter model.

You can set up the meter to export its logs to a web server, either on a schedule or manually.

NOTE: Device log export times can vary, depending on the number of records to export. To avoid long log export times, consider reducing the logging frequency for the recorded items or selecting a more frequent log export schedule (e.g., weekly instead of monthly).

1. Login to the meter webpages.
2. Based on your meter firmware version, click **Settings > Device Log Export** OR click **Settings > Communication > Device Log Export**.
3. Click **Yes** to **Enable HTTP Device Log Export**.
4. Set the **Frequency** and configure the schedule as required.
 - **Daily:** select Daily to set the meter data log export to once a day. Use the Time of Day field to select what time the data log export occurs each day.
 - **Weekly:** select Weekly to set the meter data log export to once a week. Use the Time of Day and Day of the Week fields to select what time and day the data log export occurs each week.
 - **Monthly:** select Monthly to set the meter data log export to once a month. Use the Time of Day and Day of the Month fields to select what time and day the data log export occurs each month.

NOTE: You can leave the default settings if you are exporting the data logs manually.
5. Configure the HTTP parameters as appropriate.
You can use the **Test HTTP** button to test the meter connection to the web server.

- Click **Save changes** or **Apply Changes** to send and save the new settings to the meter if you are configuring an export schedule, or click **Manual Export** to export the data logs immediately.

Log export HTTP parameters available using the webpages

Parameter	Description
Server IP Address ⁷	Enter the IP address of the server for the data log export.
Server TCP Port ⁷	Enter the server port number for HTTP communications.
Proxy Server IP Address ⁷	Enter the proxy server IP address, if required by your network.
Proxy Server TCP Port ⁷	Enter the proxy server TCP port number, if required by your network.
PATH	Enter the network path of the folder where the data logs are to be exported.
Field Name	Enter the name of the exported data log.
Host Name	If using a virtual host name, enter the name here.
Username	Enter the username for accessing the server.
Password	Enter the password for accessing the server.

Alarm log

Alarm records are stored in the meter's alarm history log.

You can use the meter's display or a web browser to view the alarm history log.

Maintenance log

The meter records maintenance-type events such as changes to meter setup.

You can use a web browser to view the contents of the maintenance log.

⁷ Contact your local network administrator for parameter values.

Inputs / outputs

I/O overview

The meter is equipped with digital I/O, RCM, and analog inputs.

The meter has:

- 4 digital inputs (S1 to S4)*
OR
2 digital inputs (S1 & S2) and 2 analog inputs (A1 & A2)*
OR
2 digital inputs (S1 & S2) and 2 RCM inputs (I5 & I6)*
- 2 Form A digital outputs (D1 & D2)

NOTE: *Available in specific meter models. Refer to Features differentiation matrix for PM5500 / PM5600 / PM5700 series, page 20 for the availability.

NOTICE

RISK OF DAMAGE TO THE METER

- Do not exceed the specified ratings.
- Refer to details in **Device specifications** section of this document.

Failure to follow these instructions can result in equipment damage.

Digital input applications

Digital inputs are typically used for monitoring the status of external contacts or circuit breakers. They can also be used for pulse counting or input metering applications, such as WAGES (water, air, gas, electricity, steam) monitoring.

Digital input wiring considerations

The meter's digital inputs require an external voltage source to detect the digital input's on/off state.

The meter detects an on state, if the external voltage appearing at the digital input is within its operating range.

WAGES monitoring

WAGES monitoring allows you to record and analyze all energy sources and utilities usage.

Your system may use several different types of energy. For example, you may consume steam or compressed air for industrial processes, electricity for lights and computers, water for cooling and natural gas for heating. WAGES monitoring collects the usage information from all these different energy sources to enable a more complete energy analysis.

WAGES information can help you:

- Identify losses or inefficiencies.
- Modify demand to reduce costs.

- Optimize energy source usage.

WAGES example

This example shows WAGES monitoring for a water flow meter.

You can connect your meter’s digital input to a transducer that sends a pulse for every 15 kiloliters (4000 US Gal) of water. After configuring an input metering channel and assigning it to the digital input, the meter is able to detect and record the incoming pulses. An energy management system can then use the information from the meter to perform WAGES analysis.

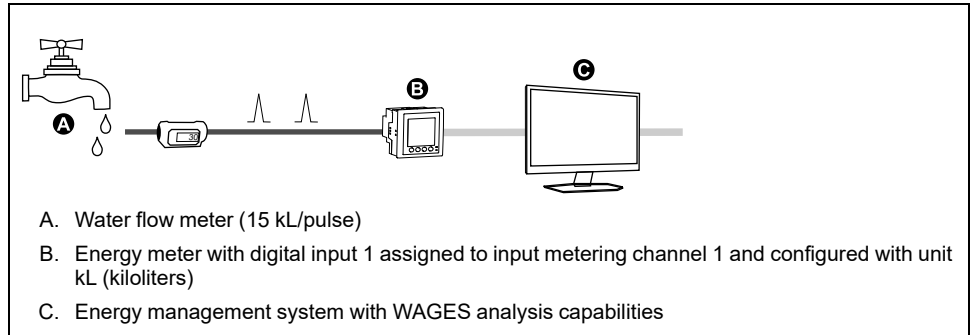

Configuring digital inputs using ION Setup

You can use ION Setup to configure the digital inputs.

1. Start ION Setup.
2. Connect to your meter.
3. Configure the control mode you want to use for the digital input.

Option	Description
Normal	
Input Metering	<ol style="list-style-type: none"> 1. Navigate to I/O configuration > Input Metering. 2. Select the input metering channel you want to configure and click Edit. 3. Configure the input metering channel parameters as required. 4. Select the digital input you want to associate with the input metering channel and click the arrows to add it to the assigned inputs.
Multi-Tariff	<ol style="list-style-type: none"> 1. Navigate to Multi-Tariff. 2. Proceed through the Multi-Tariff configuration wizard, setting the control mode to Input and selecting the digital input(s) you want to associate.
Demand Sync	<ol style="list-style-type: none"> 1. Navigate to Demand Setup. 2. Select the demand type that you want to associate with the digital input and click Edit. 3. Configure the demand mode parameters as required, setting the mode to one of the input options. 4. Click the Digital Input Association button to associate a digital input.

4. Navigate to **I/O configuration > I/O Setup**.
5. Select a digital input to configure and click **Edit**.
The setup screen for that digital input is displayed.
6. Configure the setup parameters as required.

- Click **Send** to save your changes.

Digital input setup parameters

Parameter	Values	Description
Label	—	Use this field to change the default label and assign a descriptive name to this digital input.
Control Mode	Normal Demand Sync Input Metering Multi-Tariff	<p>This field displays how the digital input functions.</p> <ul style="list-style-type: none"> Normal: the digital input is either associated with a digital input alarm, or it is not associated with another meter function. The meter counts and records the number of incoming pulses normally. Demand Sync: the digital input is associated with one of the input sync demand functions. The meter uses the incoming pulse to synchronize its demand period with the external source. Input Metering: the digital input is associated with one of the input metering channels. The meter counts and records the number of incoming pulses and related consumption data associated with the pulses. Multi-Tariff: the digital input is associated with the multi-tariff function. <p>NOTE: The control mode is set in the ION Setup where you configure the feature.</p>
Debounce	0 to 1000	Debounce is the time delay that compensates for mechanical contact bounce. Use this field to set how long (in milliseconds) the external signal must remain in a certain state to be considered a valid state change. Allowable values are increments of 10 (i.e., 10, 20, 30, etc., up to 1000 ms).
Associations	—	This field displays additional information if the digital input is already associated with another meter function.

Configuring digital inputs using the display

You can use the display to configure the digital inputs.

NOTE: It is recommended you use ION Setup to configure the digital inputs, as setup parameters that require text entry can only be modified using ION Setup.

- Navigate to **Maint > Setup**.
- Enter the setup passcode (default is “0”), then press **OK**.
- Navigate to **I/O > D In**.
- Move the cursor to point to the digital input you want to set up, then press **Edit**.
- Move the cursor to point to the parameter you want to modify, then press **Edit**.

NOTE: If **Edit** is not displayed, it means the parameter is either read-only or can only be modified through software.
- Modify the parameter as required, then press **OK**.
- Move the cursor to point to the next parameter you want to modify, press **Edit**, make your changes, then press **OK**.

8. Press the up arrow to exit. Press **Yes** to save your changes.

Digital input setup parameters available using the display

Parameter	Values	Description
Label	—	This can be modified only through software. Use this field to assign names to the digital inputs.
Debounce Time (ms)	0 to 1000	Debounce is the time delay that compensates for mechanical contact bounce. Use this field to set how long (in milliseconds) the external signal must remain in a certain state to be considered a valid state change. Allowable values are increments of 10 (i.e., 10, 20, 30, etc., up to 1000 ms).
Control Mode	Normal Demand Sync Input Metering Multi-Tariff	This field displays how the digital input functions. <ul style="list-style-type: none"> • Normal: the digital input is either associated with a digital input alarm, or it is not associated with another meter function. The meter counts and records the number of incoming pulses normally. • Demand Sync: the digital input is associated with one of the input sync demand functions. The meter uses the incoming pulse to synchronize its demand period with the external source. • Input Metering: the digital input is associated with one of the input metering channels. The meter counts and records the number of incoming pulses and related consumption data associated with the pulses. • Multi-Tariff: the digital input is associated with the multi-tariff function.

Input metering

Your meter’s digital inputs can be used to count pulses from transducers and convert the pulses to energy measurements.

Your meter’s input metering channels count pulses received from the digital inputs assigned to that channel. The incoming pulses are used in calculating and measuring consumption data (e.g., BTU, kWh, L, kg). Each channel must have the following values configured to match the pulse data:

- Pulse Weight: the pulses per unit value.
- Unit Code: the unit of measure associated with the monitored value.
- Demand Code: for time-based values (such as kWh), this provides the associated demand units (kW) for demand calculations; for other values (such as kg), this can be configured to provide rate information (kg/h or kg/s).
- Mode: whether a pulse is based on a complete pulse or a transition.

For example, if each complete pulse represents 125 Wh, you can configure for Wh pulsing as follows:

- Pulse Weight = pulses/Wh = 1/125 = 0.008
- Unit Code = Wh
- Demand Code = kW (this is automatically set)
- Mode = pulse

If you want to configure for kWh pulsing, you must adjust the pulse weight calculation and unit code as follows:

- Pulse Weight = pulses/kWh = 1/0.125 = 8
- Unit Code = kWh

Configuring input metering using ION Setup

You can use ION Setup to configure the input metering channels.

1. Start ION Setup.
2. Connect to your meter.

3. Navigate to **I/O configuration > Input metering**
4. Select an input metering channel to configure and click **Edit**.
The **Channel Setup** screen is displayed.
5. Enter a descriptive name for the metering channel's **Label**.
6. Configure the input metering parameters as required.
7. Click **Send** to save your changes.

Parameter	Values	Description
Label	—	Use this field to change the default label and assign a descriptive name to this input metering channel.
Pulse Weight	0 to 99.99999	Use this field to specify the quantity or value each pulse represents.
Units	No units, Wh, kWh, MWh, VARh, kVARh, MVARh, VAh, kVAh, MVAh, gal, BTU, L, m ³ , MCF, lbs, kg, klbs, Therm	Select the unit of measurement associated with the monitored value.
Rate	Varies (based on the units selected)	For time-based values (such as kWh), this provides the associated demand units (kW) for demand calculations. For other values (such as kg), this can be configured to provide rate information (kg/h).
Mode	Pulse or Transition	Set Mode to Pulse to count only complete pulses. Set Mode to Transition to count each ON-to-OFF or OFF-to-ON status change.
Available Inputs / Assigned Inputs	Digital input DI1, DI2, DI3*, DI4*	Select the digital input from the Available inputs box and use the right arrow button to assign the input metering channel to that digital input.

*Available in specific meter models. Refer to Features differentiation matrix for PM5500 / PM5600 / PM5700 series, page 20 for the availability.

Configuring input metering using the display

You can use the meter's display to configure the input metering channels.

NOTE: It is recommended you use ION Setup to configure input metering, as setup parameters that require text entry can only be modified using ION Setup.

1. Navigate to **Maint > Setup**.
2. Enter the setup passcode (default is "0"), then press **OK**.
3. Navigate to **I/O > Inp Mtr**.
4. Move the cursor to point to the input metering channel you want to set up, then press **Edit**.
5. Move the cursor to the parameter you want to modify, then press **Edit**.
NOTE: If **Edit** is not displayed, it means the parameter is either read-only or can only be modified through software.
6. Modify the parameter as required, then press **OK**.

7. Press the up arrow to exit. Press **Yes** to save your changes.

Parameter	Values	Description
Label	—	Use this field to change the default label and assign a descriptive name to this input metering channel.
Pulse Weight	0 to 99.99999	Use this field to specify the quantity or value each pulse represents.
Unit Code	None, Wh, kWh, MWh, VARh, kVARh, MVARh, VAh, kVAh, MVAh, gal, BTU, L, m ³ , MCF, lbs, kg, klbs, Therm	Select the unit of measurement associated with the monitored value.
Demand Code	Varies (based on the units selected)	For time-based values (such as kWh), this provides the associated demand units (kW) for demand calculations. For other values (such as kg), this can be configured to provide rate information (kg/h).
Mode	Pulse, Transition	Set Mode to Pulse to count only complete pulses. Set Mode to Transition to count each ON-to-OFF or OFF-to-ON status change.
Digital Inputs	None, Digital input	Select the digital input from the Available inputs box and use the right arrow button to assign the input metering channel to that digital input.

Demand measurements for input metering

The demand codes available for input metering are based on the unit code selected when you configure input metering on your meter.

Input metering unit and demand codes

Unit Code	Demand Code	Description
None	None	Default setting for the input metering channels
Wh	kW	Watt-hour, kiloWatt-hour and MegaWatt-hour measurements are converted to calculate demand in kW
kWh		
MWh		
VARh	kVAR	VAR-hour, kiloVAR-hour and MegaVAR-hour measurements are converted to calculate demand in kVAR.
kVARh		
MVARh		
VAh	kVA	VA-hour, kiloVA-hour and MegaVA-hour measurements are converted to calculate demand in kVA.
kVAh		
MVAh		
gal	GPH, GPM	Select GPH to set rate to gallons per hour or GPM to set it to gallons per minute.
BTU	BTU/h	BTU (British thermal unit) energy measurements are set to calculate BTUs per hour consumption rate.
L	l/hr, l/min	Select liters per hour or per minute consumption rate.
m ³	m ³ /hr, m ³ /s, m ³ /m	Select cubic meters per hour, per second, or per minute consumption rate.
MCF	cfm	Thousand cubic foot volume measurements are converted to calculate cubic feet per minute consumption rate.
lbs	lb/hr	Kilopounds (klbs) measurements are converted to calculate pounds per hour consumption rate.
klbs		
kg	kg/hr	Kilogram measurements are set to calculate kilogram per hour consumption rate.
Therm	Thm/h	British therm (equivalent to 100,000 BTU) heat measurements are set to calculate therm per hour consumption rate.

Viewing input metering data through the meter's display

You can use the meter's display to view input metering data.

1. Navigate to **Energy > Inp Mtr > Dmd**.
2. Select an input metering channel to view the input metering data.

NOTE: The display shows accumulation values from 0 to 99999. The display rolls over to zero when the accumulated value reaches 100,000 and starts incrementing again.

Digital output applications

Digital outputs are typically used in switching applications, for example, to provide on/off control signals for switching capacitor banks, generators, and other external devices and equipment.

The digital output can also be used in demand synchronization applications, where the meter provides pulse signals to the input of another meter to control its demand period. The digital output can also be used in energy pulsing applications, where a receiving device determines energy usage by counting the kWh pulses coming from the meter's digital output.

The digital outputs on the meter are internally designed using solid-state devices with an open-collector configuration. These outputs must be connected to the specified power supply with a current limiter to function. Refer to the *digital output application example* below for more information.

Digital output application example

You can connect one of your meter's digital outputs to a relay that switches on a generator and the other digital output to send a demand sync pulse to other meters.

In the following example, the first meter (Meter 1) controls and sets the demand period (900 seconds) of the other meters (Meter 2, Meter 3, Meter 4) through the output pulse occurring at the end of the first meter's demand interval.

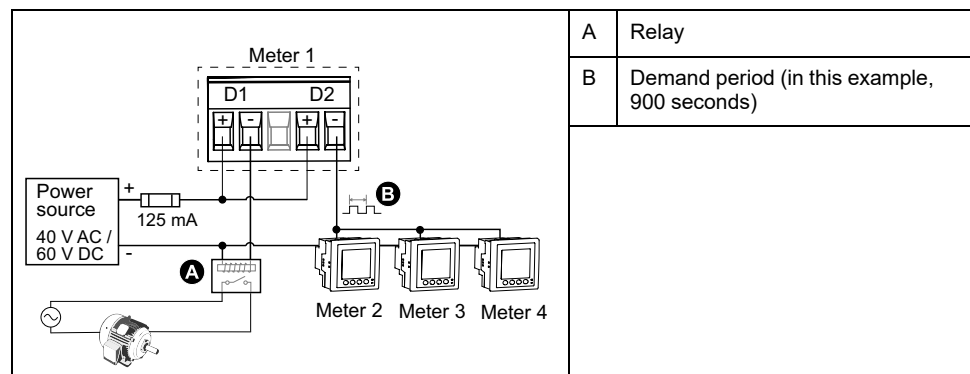

Configuring digital outputs using ION Setup

You can use ION Setup to configure the digital outputs (D1 and D2).

1. Start ION Setup.
2. Connect to your meter.

3. Configure the control mode you want to use for the digital output.

Option	Description
External or Energy Pulsing	<ol style="list-style-type: none"> 1. Navigate to I/O configuration > Energy Pulsing. 2. Select the digital output you are configuring and click Edit. 3. Select External or Energy from the Control dropdown list. 4. For Energy, configure the energy pulsing parameters as required.
Alarm	<ol style="list-style-type: none"> 1. Navigate to Alarming. 2. Select the alarm type of the alarm you want to associate with the digital output and click Edit. 3. Configure the alarm parameters as required. 4. Select the digital output you want to associate with the alarm. <p>NOTE: You may need to enable the alarm before you can associate the digital output.</p>
Demand	<ol style="list-style-type: none"> 1. Navigate to Demand Setup. 2. Select the demand type that you want to associate with the digital output and click Edit. 3. Configure the demand mode parameters as required. 4. Click the Digital Output Association button to associate a digital output.

4. Navigate to **I/O configuration > I/O Setup**.
5. Select a digital output to configure and click **Edit**.
The setup screen for that digital output is displayed.
6. Enter a descriptive name for the digital output in the **Label** field.
7. Configure the **Behavior Mode** and **On Time** parameters as required, depending on the control mode.
8. Click **Send** to save your changes.

Digital output setup parameters available using ION Setup

Parameter	Values	Description
Label	—	Use this field to change the default label and assign a descriptive name to this digital output.
Control Mode	External, Demand, Alarm, Energy	<p>This field displays how the digital output functions.</p> <ul style="list-style-type: none"> • External: the digital output is controlled remotely either through software or by a PLC using commands sent through communications. • Demand: the digital output is associated with one of the demand systems. The meter sends a pulse to the digital output at the end of every demand interval. • Alarm: the digital output is associated with the alarm system. The meter sends a pulse to the digital output when the alarm is triggered. • Energy: the digital output is associated with energy pulsing. When this mode is selected, you can select the energy parameter and the set the pulse rate (pulses/kW). <p>NOTE: The control mode is set in the ION Setup where you configure the feature.</p>
Behavior Mode	Normal, Timed, Coil Hold	<ul style="list-style-type: none"> • Normal: this mode applies when control mode is set to External or Alarm. The digital output remains in the ON state until an OFF command is sent by the computer or PLC. • Timed: the digital output remains ON for the period defined by the On Time setup register. • Coil Hold: this mode applies when control mode is set to External or Alarm. For a unary alarm that is associated with a digital output, you must set Behavior Mode to Coil Hold. The output turns on when the “energize” command is received and turns off when the “coil hold release” command is received. In the event of a control power loss, the output remembers and returns to the state it was in when control power was lost.
On Time (s)	0 to 9999	This setting defines the pulse width (ON time) in seconds.
Associations	—	This field displays additional information if the digital output is already associated with another meter function.

Configuring digital outputs using the display

You can use the display to configure the digital outputs.

NOTE: It is recommended you use ION Setup to configure the digital outputs, as setup parameters that require text entry can only be modified using software.

1. Navigate to **Maint > Setup**.
2. Enter the setup passcode, then press **OK**.
3. Navigate to **I/O > D Out**.
4. Move the cursor to point to the digital output you want to set up, then press **Edit**.
5. Edit the parameters as required.
 - a. Move the cursor to point to the parameter you want to modify, then press **Edit**
 - b. Modify the parameter as required, then press **OK**.
 - c. Move the cursor to point to the next parameter you want to modify, press **Edit**, make your changes, then press **OK**.

NOTE: If **Edit** is not displayed, it means the parameter is either read-only or can only be modified through software.

6. Press the up arrow to exit. Press **Yes** to save your changes.

Setting	Option or range	Description
Label	—	This can be modified only through software. Use this field to change the default label and assign a descriptive name to this digital output.
Control Mode	External, Demand Sync, Alarm, Energy	This field displays how the digital output functions. <ul style="list-style-type: none"> • External: the digital output is controlled remotely either through software or by a PLC using commands sent through communications. • Demand Sync: the digital output is associated with one of the demand systems. The meter sends a pulse to the digital output at the end of every demand interval. • Alarm: the digital output is associated with the alarm system. The meter sends a pulse to the digital output when the alarm is triggered. • Energy: the digital output is associated with energy pulsing. When this mode is selected, you can select the energy parameter and the set the pulse rate (pulses/kW).
Behavior Mode	Normal, Timed, Coil Hold	<ul style="list-style-type: none"> • Normal: this mode applies when control mode is set to External or Alarm. The digital output remains in the ON state until an OFF command is sent by the computer or PLC. • Timed: the digital output remains ON for the period defined by the On Time setup register. • Coil Hold: this mode applies when control mode is set to External or Alarm. For a unary alarm that is associated with a digital output, you must set Behavior Mode to Coil Hold. The output turns on when the “energize” command is received and turns off when the “coil hold release” command is received. In the event of a control power loss, the output remembers and returns to the state it was in when control power was lost.
On Time (s)	0 to 9999	This setting defines the pulse width (ON time) in seconds.
Select Dmd System	Power, Current, Input Metering	Applies when Control Mode is set to Demand Sync. Select the demand system to monitor.
Select Alarms	All available alarms	Applies when Control Mode is set to Alarm. Select one or more alarms to monitor.

Energy pulsing

You can configure the meter’s energy pulsing LED or digital output for energy pulsing applications.

When the LED is set to energy pulsing, the meter sends a readable pulse or signal based on the measured energy. This pulse can be used for accuracy verification or as an input to another energy monitoring system. You must calculate your pulse

values as either pulses per kWh or as kWh per pulse, as defined by your meter, and set the energy value as delivered or received active, reactive, or apparent energy.

Configuring the alarm / energy pulsing LED using the display

You can use the display to configure your meter's LED for alarming or energy pulsing applications.

NOTE: The alarm / energy pulsing LED on the PM5561 / PM5661 / PM5761 is permanently set for energy pulsing.

1. Navigate to **Maint > Setup**.
2. Enter the setup passcode (default is "0"), then press **OK**.
3. Navigate to **I/O > LED**.
4. Move the cursor to point to the parameter you want to modify, then press **Edit**.
5. Press the plus or minus buttons to modify the parameter as required, then press **OK**.
6. Press the up arrow to exit. Press **Yes** to save your changes.

Setting	Option or range	Description
Mode	Off, Alarm, Energy	Off disables the LED completely. Alarm sets the LED for alarm notification. Energy sets the LED for energy pulsing.
Pulses per k__h	1 to 9999999	When configured for energy pulsing, this setting defines how many pulses are sent to the LED for every 1 kWh, 1 kVARh or 1kVAh accumulated energy. This setting is ignored when the LED mode is set to Alarm.
Channel	Active Del, Active Rec, Active Del + Rec, Reactive Del, Reactive Rec, Reactive Del + Rec, Apparent Del, Apparent Rec, Apparent Del + Rec	Select which accumulated energy channel to monitor and use for energy pulsing. This setting is ignored when the LED mode is set to Alarm.

Configuring the alarm / energy pulsing LED or digital output for energy pulsing using ION Setup

You can use ION Setup to configure your meter's alarm / energy pulsing LED or digital output for energy pulsing.

NOTE: The alarm / energy pulsing LED on the PM5561 / PM5661 / PM5761 is permanently set for energy pulsing and cannot be disabled or used for alarms.

1. Start ION Setup.
2. Connect to your meter.
3. Navigate to **I/O configuration > Energy Pulsing**.

4. Select the LED or a digital output to configure and click **Edit**.
The setup screen is displayed.
5. Enter a descriptive name for the digital output's **Label**.
6. Configure the other setup parameters as required.
7. Click **Send** to save your changes.

Alarm / energy pulsing setup parameters available using ION Setup

Parameter	Values	Description
Mode	LED: Disabled, Alarm, Energy Digital output: External, Energy	LED: <ul style="list-style-type: none"> • LED is disabled. • Alarm sets the LED for alarm notification. • Energy sets the LED for energy pulsing. Digital output: <ul style="list-style-type: none"> • Energy: associates the digital output with energy pulsing. • External: disassociates the digital output from energy pulsing.
Pulse rate (pulses/kW)	1 to 9999999	When configured for energy pulsing, this defines how many pulses are sent to the LED for every 1 kWh, 1 kVARh or 1kVAh of accumulated energy.
Parameter	Active Energy Delivered Active Energy Received Active Energy Del+Rec Reactive Energy Delivered Reactive Energy Received Reactive Energy Del+Rec Apparent Energy Delivered Apparent Energy Received Apparent Energy Del+Rec	Select which accumulated energy channel to monitor and use for energy pulsing.

Analog inputs

Applicable only in PM5570 / PM5570L meter models.

The analog inputs are typically used to measure flow rates, temperatures, pressures, rotations, and fluid levels through electrical signals from transducers.

For analog input operation, your meter processes an analog input signal and provides the resulting scaled value. Your meter's analog inputs can measure current using standard 4 - 20 mA analog transducers.

You need to configure analog inputs minimum and maximum values. Analog inputs may show a value below zero scale if an open circuit is detected on the input.

Configuring analog inputs using the display

You can use the display to configure the analog inputs.

NOTE: It is recommended you use ION Setup to configure **Label** details (**Analog Input 1 / Analog Input 2**), as setup parameters that require text entry can only be modified using ION Setup.

1. Navigate to **Maint > Setup**.
2. Enter the setup passcode (default is "0"), then press **OK**.

3. Navigate to **I/O > A In** and press **A In**.
4. Move the cursor to point to **Analog Input 1 / Analog Input 2** you want to modify, then press **Edit**.

NOTE: If **Edit** is not displayed, it means the parameter is either read-only or can only be modified through software.

5. Modify the parameters as required, then press **OK**.
6. Press the up arrow to exit. Press **Yes** to save your changes.

Analog input setup parameters available using the display

Parameter	Values	Description
Label	–	This can be modified only through ION Setup. Use this field to assign names to the analog inputs.
Scale	0.001 (Default) 1 10 100 1000 0.010 0.100	Select the scaling value from the list.
Unit	Refer to Configurable units, page 145 table	Select the unit of measurement associated with the monitored value.
Minimum Value	-999999	The minimum source value that matches the minimum analog input signal.
Maximum Value	+999999	The maximum source value that matches the maximum analog input signal.

NOTE: The meter LCD displays a maximum of 5 digits for the **Scaled Value of Analog Inputs A1 and A2**. If the **Minimum Value**, **Maximum Value**, and **Scale** settings result in a **Scaled Value** longer than 5 digits, the **Scaled Value** on the LCD may appear clipped or blank. It is advised to check the sensor's range and units during selection.

Configurable units

Code	Unit	Description
0	–	No unit
1	%	Percentage
2	°C	Degrees Celsius
3	°F	Degrees Fahrenheit
4	Deg	Degrees Angular
5	Hz	Hertz
6	A (Default)	Amperes
7	kA	Kilo Amperes
8	V	Volts
9	kV	Kilo Volts
10	MV	Mega Volts
11	W	Watts
12	kW	Kilowatts
13	MW	Megawatts
14	VAR	Volt-Ampere Reactive

Code	Unit	Description
15	kVAR	Kilo Volt-Ampere Reactive
16	MVAR	Mega Volt-Ampere Reactive
17	VA	Volt-Amperes
18	kVA	Kilo Volt-Amperes
19	MVA	Mega Volt-Amperes
20	WH	Watt-Hour
21	kWH	Kilowatt-Hour
22	MWH	Megawatt-Hour
23	VARH	Reactive Volt-Ampere Hour
24	kVARH	Reactive Kilo Volt-Ampere Hour
25	MVARH	Reactive Mega Volt-Ampere Hour
26	VAH	Volt-Ampere Hours
27	kVAH	Kilo Volt-Ampere Hours
28	MVAH	Mega Volt-Ampere Hours
29	Seconds	Seconds
30	Minutes	Minutes
31	Hours	Hours
32	Bytes (RAM)	Bytes
33	kBytes (RAM)	Kilobytes
34	\$	Dollars
35	gal	Gallons
36	gal/hr	Gallons/hour
37	gal/min	Gallons/minute
38	cfm	Cubic feet/min
39	PSI	PSI
40	BTU	BTU
41	L	Liters
42	ton-hours	Ton-hours
43	l/hr	Liters/hour
44	l/min	Liters/min
45	€	Euros
46	ms	Milliseconds
47	m ³	Cubic-meters
48	m ³ /sec	Cubic-meters/sec
49	m ³ /min	Cubic-meters/min
50	m ³ /hr	Cubic-meters/hour
51	Pa	Pascals
52	Bars	Bar
53	RPM	Revolutions/min
55	BTU/hr	BTU/hour
56	PSIG	Pounds/square inch gauge
57	SCFM	Standard cubic feet/min
58	MCF	Thousand cubic feet
59	Therm	Therm

Code	Unit	Description
60	SCFH	Standard cubic feet/hour
61	PSIA	Pounds/square inch absolute
62	lbs	Pounds
63	kg	Kilogram
64	klbs	Kilopounds
65	lb/hr	Pound/hour
66	ton/hr	Ton/hour
67	kg/hr	Kilogram/hour
68	in. Hg	Inch of Mercury
69	kPa	KiloPascals
70	%RH	Percentage of relative humidity
71	MPH	Miles per hour
72	m/sec	Meters/sec
73	mV/cal/(cm ² /min)	MilliVolts/calorie/(square centimeters/min)
74	in	Inches
75	mm	Millimeter
76	GWH	GigaWatt-Hour
77	GVARH	Reactive Giga Volt-Ampere Hour
78	GVAH	Giga Volt-Ampere Hours
79	AH	Ampere-Hours
80	kAH	Kiloamp-Hours
81	Therm/hr	Therm/hour

Resets

Meter resets

Resets allow you to clear various accumulated parameters stored on your meter or reinitialize the meter or meter accessories.

Meter resets clear your meter's onboard data logs and other related information. Resets are typically performed after you make changes to the meter's basic setup parameters (such as frequency, VT/PT or CT settings) to clear invalid or obsolete data in preparation for putting the meter into active service.

Meter Initialization

Meter Initialization is a special command that clears the meter's logged data, counters and timers.

It is common practice to initialize the meter after its configuration is completed, before adding it to an energy management system.

After configuring all the meter setup parameters, navigate through the different meter display screens and make sure the displayed data is valid then perform meter initialization.

Performing global resets using the display

Global resets allow you to clear all data of a particular type, such as all energy values or all minimum/maximum values.

1. Navigate to **Maint > Resets**.
2. Move the cursor to point to **Global Resets**, then press **Select**.
3. Move the cursor to point to the parameter you want to reset, then press **Reset**.

Option	Description
Meter Initialization	Clears all data listed in this table (energy, demand, min/max values, counters, logs, timers and input metering data).
Energies	Clears all accumulated energy values (kWh, kVARh, kVAh).
Demands	Clears all the demand registers.
Min/Max	Clears all the minimum and maximum registers.
Alarm Counts & Logs	Clears all the alarm counters and alarm logs.
I/O Counts & Timers	Clears all the I/O counters and resets all the timers.
Input Metering	Clears all input metering energy data.

4. Enter the reset passcode (default is "0"), then press **OK**.

5. Press **Yes** to confirm the reset or **No** to cancel and return to the previous screen.

To perform resets using ION Setup, see the “PM5500 / PM5600 / PM5700” topic in the ION Setup online help or in the ION Setup device configuration guide, available from www.se.com.

Performing single resets using the display

Single resets allow you clear data only in a specific register or register type.

Single resets are often combined to allow you to clear all data of a similar type, for example, a kWh, kVAR and kVA reset may be combined into an energy reset that clears all of the meter's energy logs.

1. Navigate to **Maint > Resets**.
2. Move the cursor to point to **Single Resets**, then press **Select**.
3. Move the cursor to point to the parameter you want to reset, then press **Reset**.

If there are additional options for the parameter, press **Select**, move the cursor to point to the option you want, then press **Reset**.

4. Enter the reset passcode (default is “0”), then press **OK**.

5. Press **Yes** to confirm the reset or **No** to cancel and return to the previous screen.

Available single resets using the display

Parameter	Option	Description
Energy	Accumulated	Clears all accumulated energy values (kWh, kVARh, kVAh).
Demand	Power, Current, Input Metering	Select which demand registers to clear (power demand, current demand or input metering demand).
Alarms	Event Queue	Clears the alarm event queue register (active alarms list).
	History Log	Clears the alarm history log.
	Counters	Select Counters and then select which alarm counter to clear. See the Alarm counter reset options table.
Digital Inputs	Timers	Select Timers then select which digital input timer to clear (chose all or individual digital input timers): All Dig In Timers, Digital Input DI1, Digital Input DI2, Digital Input DI3*, Digital Input DI4*
	Counters	Select Counters then select which digital input counter to clear (chose all or individual digital input timers): All Dig In Counters, Digital Input DI1, Digital Input DI2, Digital Input DI3*, Digital Input DI4*
Digital Outputs	Timers	Select Timers then select which digital output timer to clear (chose all or individual digital input timers): All Dig Out Timers, Digital Output DO1, Digital Output DO2
	Counters	Select Counters then select which digital output counter to clear (chose all or individual digital input timers): All Dig Out Counters, Digital Output DO1, Digital Output DO2
Active Load Timer	—	Clears and restarts the load operation timer.
Multi-Tariff	—	Clears accumulated values in all tariff registers.
Input Metering	Reset All InpMtr Reset InpMtr Chan 1 Reset InpMtr Chan 2 Reset InpMtr Chan 3 Reset InpMtr Chan 4	Select which input metering channel (InpMtr Chan) to clear (chose all or individual input metering channels).

*Available in specific meter models. Refer to Features differentiation matrix for PM5500 / PM5600 / PM5700 series, page 20 for the availability.

To perform resets using ION Setup, see the “PM5500 / PM5600 / PM5700” topic in the ION Setup online help or in the ION Setup device configuration guide, available from www.se.com.

Performing user account resets using the display

If the **Username** or **Password** credentials for **Administrator** role account or for multiple **Administrator** role accounts are lost, you can reset user accounts and roles using the meter display.

NOTE: For PM5563 meter model without PM5RD remote display, you must buy PM5RD to perform this user account reset.

1. Navigate to **Maint > Resets**.
2. Move the cursor to point to **User Acc Resets**, then press **Select**.
3. Press **Reset**.
4. Enter the reset passcode (default is “0”), then press **OK to reset the user accounts and roles to factory default settings**.
5. Press **Yes** to confirm the reset or **No** to cancel and return to the previous screen.

Alarms

Alarms overview

An alarm is the meter's means of notifying you when an alarm condition is detected, such as an error or an event that falls outside of normal operating conditions. Alarms are typically setpoint-driven and can be programmed to monitor certain behaviors, events or unwanted conditions in your electrical system.

You can configure your meter to generate and display high, medium and low priority alarms when predefined events are detected in the meter's measured values or operating states. Your meter also logs the alarm event information.

The meter ships with some alarms already enabled from the factory. Other alarms need to be configured before the meter can generate alarms.

Customize meter alarms as required, such as changing the priority. You can also create custom alarms using the advanced features of your meter.

Alarm types

Your meters supports a number of different alarm types.

Type	Number
Unary	4
Digital	4 or 2*
Standard	29 or 33*
Logic	10
Custom	5
Disturbance (Sag/swell)	2*

*Available in specific meter models. Refer to Features differentiation matrix for PM5500 / PM5600 / PM5700 series, page 20 for the availability.

Unary alarms

A unary alarm is the simplest type of alarm — it monitors a single behavior, event or condition.

Available unary alarms

Your meter has a set of 4 unary alarms.

Alarm label	Description
Meter Powerup	Meter powers on after losing control power.
Meter Reset	Meter resets for any reason.
Meter Diagnostic	Meter's self-diagnostic feature detects a problem.
Phase Reversal	Meter detects a phase rotation different than expected.

Digital alarms

Digital alarms monitor the ON or OFF state of the meter’s digital / status inputs.

Digital alarm with setpoint delay

To prevent false triggers from erratic signals, you can set up pickup and dropout time delays for the digital alarm.

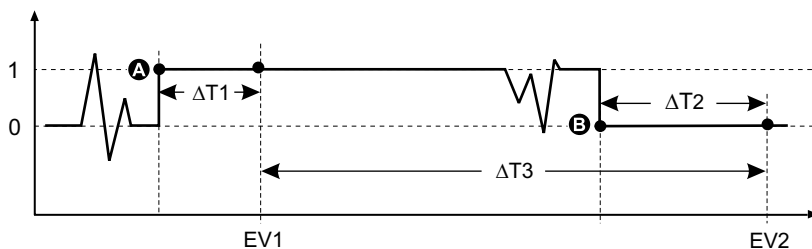

A	Pickup setpoint (1 = ON)	$\Delta T2$	Dropout time delay (in seconds)
B	Dropout setpoint (0 = OFF)	EV2	End of alarm condition
$\Delta T1$	Pickup time delay (in seconds)	$\Delta T3$	Alarm duration (in seconds)
EV1	Start of alarm condition		

NOTE: To prevent filling the alarm log with nuisance alarm trips, the digital alarm is automatically disabled if the digital / status input changes state more than 4 times in one second or more than 10 times in ten seconds. In this case, you must re-enable the alarm using the display or ION Setup.

Available digital alarms

Your meter has a set of 4 or 2 digital alarms.

Alarm label	Description
Digital Alarm S1	Digital input 1
Digital Alarm S2	Digital input 2
Digital Alarm S3	Digital input 3*
Digital Alarm S4	Digital input 4*

*Available in specific meter models. Refer to Features differentiation matrix for PM5500 / PM5600 / PM5700 series, page 20 for the availability.

Standard alarms

Standard alarms are setpoint-driven alarms which monitor certain behaviors, events or unwanted conditions in your electrical system.

Standard alarms have a detection rate equal to the 50/60 meter cycle, which is nominally 1 second if the meter’s frequency setting is configured to match the system frequency (50 or 60 Hz).

Many of the standard alarms are three-phase alarms. Alarm setpoints are evaluated for each of the three phases individually, but the alarm is reported as a single alarm. The alarm pickup occurs when the first phase exceeds the alarm pickup magnitude for the pickup time delay. The alarm is active as long as any

phase remains in an alarm state. The alarm dropout occurs when the last phase drops below the dropout magnitude for the dropout time delay.

Example of over and under setpoint (standard) alarm operation

The meter supports over and under setpoint conditions on standard alarms.

A setpoint condition occurs when the magnitude of the signal being monitored crosses the limit specified by the pickup setpoint setting and stays within that limit for a minimum time period specified by the pickup time delay setting.

The setpoint condition ends when the magnitude of the signal being monitored crosses the limit specified by dropout setpoint setting and stays within that limit for a minimum time period specified by dropout time delay setting.

Over setpoint

When the value rises above the pickup setpoint setting and remains there long enough to satisfy the pickup time delay period ($\Delta T1$), the alarm condition is set to ON. When the value falls below the dropout setpoint setting and remains there long enough to satisfy the dropout time delay period ($\Delta T2$), the alarm condition is set to OFF.

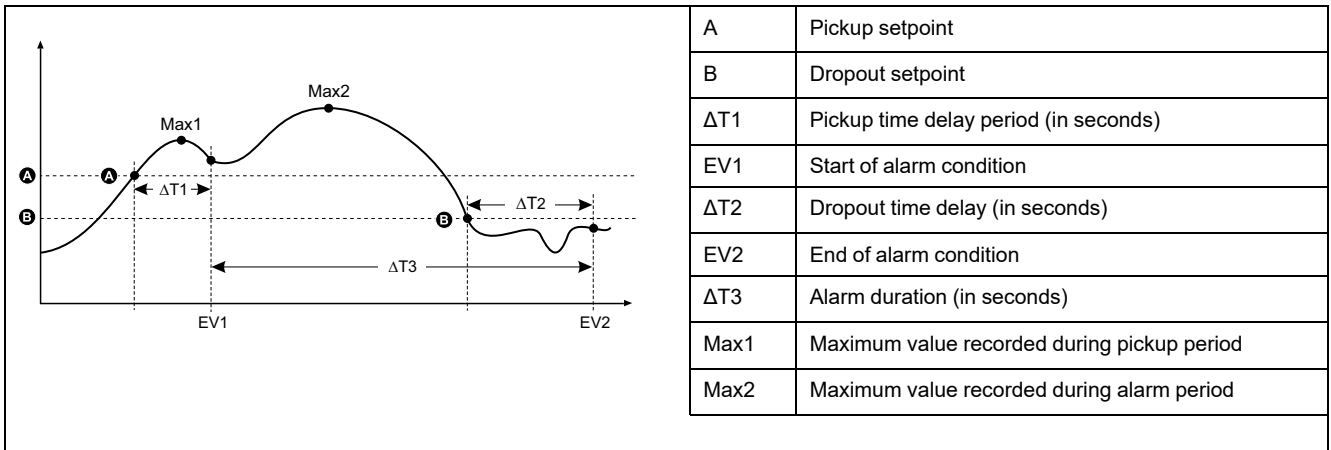

The meter records the date and time when the alarm event starts (EV1) and when it ends (EV2). The meter also performs any task assigned to the event, such as operating a digital output. The meter also records maximum values (Max1, Max2) before, during or after the alarm period.

Under setpoint

When the value falls below the pickup setpoint setting and remains there long enough to satisfy the pickup time delay period ($\Delta T1$), the alarm condition is set to ON. When the value rises above the dropout setpoint setting and remains there long enough to satisfy the dropout time delay period ($\Delta T2$), the alarm condition is set to OFF.

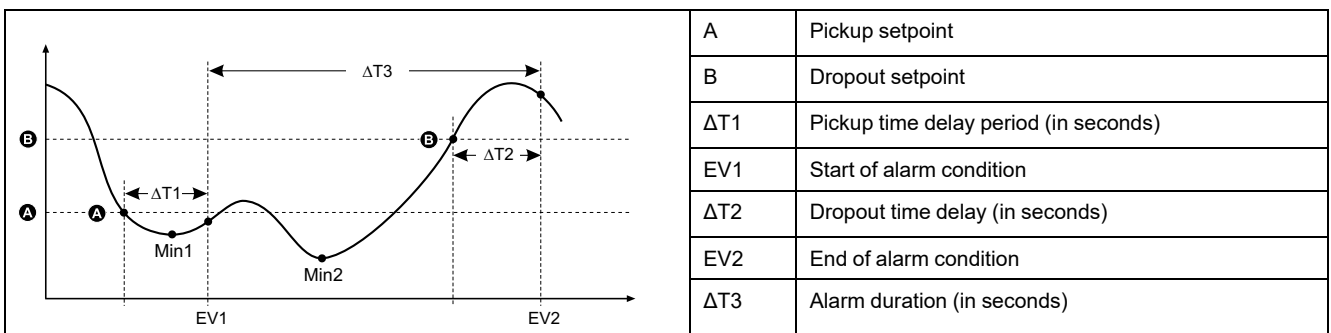

	Min1	Minimum value recorded during pickup period
	Min2	Minimum value recorded during alarm period

The meter records the date and time when the alarm event starts (EV1) and when it ends (EV2). The meter also performs any task assigned to the event, such as operating a digital output. The meter also records minimum values (Min1, Min2) before, during or after the alarm period.

Maximum allowable setpoint

The meter is programmed to help prevent user data entry errors, with set limits for the standard alarms.

The maximum setpoint value you can enter for some of the standard alarms depends on the voltage transformer ratio (VT ratio), current transformer ratio (CT ratio), system type (i.e., number of phases) and/or the maximum voltage and maximum current limits programmed at the factory.

NOTE: VT ratio is the VT primary divided by the VT secondary and CT ratio is the CT primary divided by the CT secondary.

Standard alarm	Maximum setpoint value
Over Phase Current	(maximum current) x (CT ratio)
Under Phase Current	(maximum current) x (CT ratio)
Over Neutral Current	(maximum current) x (CT ratio) x (number of phases)
Over Ground Current	(maximum current) x (CT ratio)
Over Voltage L-L	(maximum voltage) x (VT ratio)
Under Voltage L-L	(maximum voltage) x (VT ratio)
Over Voltage L-N	(maximum voltage) x (VT ratio)
Under Voltage L-N	(maximum voltage) x (VT ratio)
Over Active Power	(maximum voltage) x (maximum current) x (number of phases)
Over Reactive Power	(maximum voltage) x (maximum current) x (number of phases)
Over Apparent Power	(maximum voltage) x (maximum current) x (number of phases)
Over Present Active Power Demand	(maximum voltage) x (maximum current) x (number of phases)
Over Last Active Power Demand	(maximum voltage) x (maximum current) x (number of phases)
Over Predicted Active Power Demand	(maximum voltage) x (maximum current) x (number of phases)
Over Present Reactive Power Demand	(maximum voltage) x (maximum current) x (number of phases)
Over Last Reactive Power Demand	(maximum voltage) x (maximum current) x (number of phases)
Over Predicted Reactive Power Demand	(maximum voltage) x (maximum current) x (number of phases)
Over Present Apparent Power Demand	(maximum voltage) x (maximum current) x (number of phases)
Over Last Apparent Power Demand	(maximum voltage) x (maximum current) x (number of phases)
Over Predicted Apparent Power Demand	(maximum voltage) x (maximum current) x (number of phases)
Over Voltage Unbalance	(maximum voltage) x (VT ratio)
Phase Loss	(maximum voltage) x (VT ratio)
Over Current Residual*	4500 mA

*Available in specific meter models. Refer to Features differentiation matrix for PM5500 / PM5600 / PM5700 series, page 20 for the availability. For over current residual alarms, the maximum setpoint value is limited to 4500 mA independent of the toroid turns setting.

NOTE: For toroid used, the pick-up and drop-out values for over current AL1 I5/I6 and over current AL2 I5/I6 should be set within the range of residual current measurement meeting specified accuracy as mentioned in table Toroid turns setting example, page 49.

Available standard alarms

Your meter has a set of standard alarms.

NOTE: Some alarms do not apply to all power system configurations. For example, line-to-neutral voltage alarms cannot be enabled on 3-phase delta systems. Some alarms use the system type and the VT or CT ratio to determine the maximum allowed setpoint.

Alarm label		Valid range and resolution		Units
ION Setup	Display	ION Setup	Display	
Over Phase Current	Over Current, Ph	0.000 to 99999.000	0 to 99999	A
Under Phase Current	Under Current, Ph	0.000 to 99999.000	0 to 99999	A
Over Neutral Current	Over Current, N	0.000 to 99999.000	0 to 99999	A
Over Ground Current	Over Current, Gnd	0.000 to 99999.000	0 to 99999	A
Over Voltage L-L	Over Voltage, L-L	0.00 to 999999.00	0 to 999999	V
Under Voltage L-L	Under Voltage, L-L	0.00 to 999999.00	0 to 999999	V
Over Voltage L-N	Over Voltage, L-N	0.00 to 999999.00	0 to 999999	V
Under Voltage L-N	Under Voltage L-N	0.00 to 999999.00	0 to 999999	V
Over Active Power	Over kW	0.0 to 9999999.0	0 to 9999999	kW
Over Reactive Power	Over kVAR	0.0 to 9999999.0	0 to 9999999	kVAR
Over Apparent Power	Over kVA	0.0 to 9999999.0	0 to 9999999	kVA
Leading True PF	Lead PF, True	-1.00 to -0.01 and 0.01 to 1.00		—
Lagging True PF	Lag PF, True	-1.00 to -0.01 and 0.01 to 1.00		—
Leading Disp PF	Lead PF, Disp	-1.00 to -0.01 and 0.01 to 1.00		—
Lagging Disp PF	Lag PF, Disp	-1.00 to -0.01 and 0.01 to 1.00		—
Over Present Active Power Demand	Over kW Dmd, Pres	0.0 to 9999999.0	0 to 9999999	kW
Over Last Active Power Demand	Over kW Dmd, Last	0.0 to 9999999.0	0 to 9999999	kW
Over Predicted Active Power Demand	Over kW Dmd, Pred	0.0 to 9999999.0	0 to 9999999	kW
Over Present Reactive Power Demand	Over kVAR Dmd, Pres	0.0 to 9999999.0	0 to 9999999	kVAR
Over Last Reactive Power Demand	Over kVAR Dmd, Last	0.0 to 9999999.0	0 to 9999999	kVAR
Over Predicted Reactive Power Demand	Over kVAR Dmd, Pred	0.0 to 9999999.0	0 to 9999999	kVAR
Over Present Apparent Power Demand	Over kVA Dmd, Pres	0.0 to 9999999.0	0 to 9999999	kVA
Over Last Apparent Power Demand	Over kVA Dmd, Last	0.0 to 9999999.0	0 to 9999999	kVA
Over Predicted Apparent Power Demand	Over kVA Dmd, Pred	0.0 to 9999999.0	0 to 9999999	kVA
Over Frequency	Over Frequency	0.000 to 99.000		Hz
Under Frequency	Under Frequency	0.000 to 99.000		Hz
Over Voltage Unbalance	Over Voltage Unbal	0 to 99		%
Over Voltage THD*	Over Voltage THD	0 to 99		%
Phase Loss	Phase Loss	0.00 to 999999.00	0 to 999999	—
Over Current AL1, I5**	Over Current AL1, I5	3 to 4500		mA
Over Current AL2, I5**	Over Current AL2, I5	3 to 4500		mA
Over Current AL1, I6**	Over Current AL1, I6	3 to 4500		mA
Over Current AL2, I6**	Over Current AL2, I6	3 to 4500		mA

*The Over Voltage THD alarm is only applicable for L-L voltage.

Alarm label		Valid range and resolution		Units
ION Setup	Display	ION Setup	Display	

**Available in specific meter models. Refer to Features differentiation matrix for PM5500 / PM5600 / PM5700 series, page 20 for the availability.

NOTE: For toroid used, the pick-up and drop-out values for over current AL1 I5/I6 and over current AL2 I5/I6 should be set within the range of residual current measurement meeting specified accuracy as mentioned in table Toroid turns setting example, page 49.

RCM alarm application

You can choose:

- Any one alarm (AL1 or AL2) for notification and one for operating digital output.
- OR
- Both AL1 and AL2 alarms for notification.
- OR
- Both AL1 and AL2 alarms for operating digital output.

Typical dual alarm application for I5 or I6:

NOTE: It may take up to 30 s for RCM values to populate after meter reset or power-up.

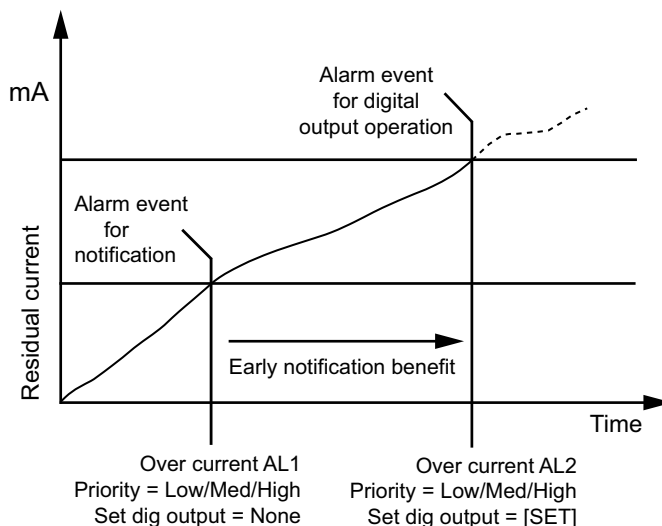

Power factor (PF) alarms

You can set up a Leading PF or Lagging PF alarm to monitor when the circuit's power factor goes above or below the threshold you specify.

The Leading PF and Lagging PF alarms use the power factor quadrants as the values on the y-axis, with quadrant II on the lowest end of the scale, followed by quadrant III, quadrant I, and finally quadrant IV on the highest end of the scale.

Quadrant	PF values	Lead/Lag
II	0 to -1	Leading (capacitive)
III	-1 to 0	Lagging (inductive)
I	0 to 1	Lagging (inductive)
IV	1 to 0	Leading (capacitive)

Leading PF alarm

The Leading PF alarm monitors an over setpoint condition.

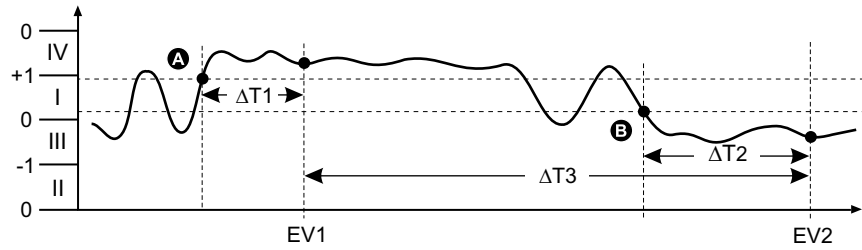

A	Pickup setpoint	$\Delta T2$	Dropout time delay (in seconds)
B	Dropout setpoint	EV2	End of alarm condition
$\Delta T1$	Pickup delay period (in seconds)	$\Delta T3$	Alarm duration (in seconds)
EV1	Start of alarm condition		

Lagging PF alarm

The Lagging PF alarm monitors an under setpoint condition.

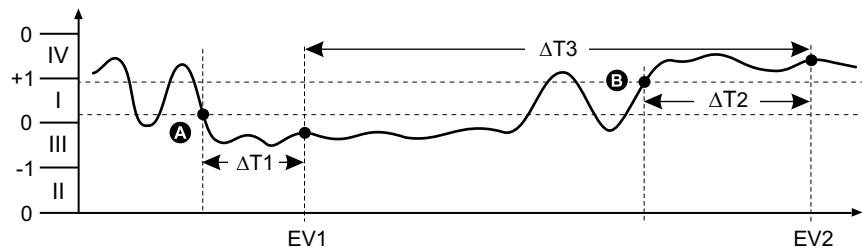

A	Pickup setpoint	$\Delta T2$	Dropout time delay (in seconds)
B	Dropout setpoint	EV2	End of alarm condition
$\Delta T1$	Pickup delay period (in seconds)	$\Delta T3$	Alarm duration (in seconds)
EV1	Start of alarm condition		

Phase loss alarm

The phase loss alarm is an under setpoint alarm that monitors the voltages on a 3-phase system and triggers the alarm when one or two phases fall below the pickup setpoint setting and remain there long enough to satisfy the pickup time delay period.

When all of the phases rise above the dropout setpoint setting and remain there long enough to satisfy the dropout time delay period, the alarm condition is set to OFF.

*In 1PH3W LL with N system configuration, if any one phase of V L-N falls below the 20 V pickup setpoint setting and remain there long enough to satisfy the pickup time delay period, the phase loss alarm is triggered.

NOTE: *In 1PH system configuration, no phase loss alarm is triggered because it is considered as no load condition.

*In 3PH3W system configuration, if any two phases of V L-L falls below the pickup setpoint setting and remain there long enough to satisfy the pickup time delay period, the phase loss alarm is triggered.

*In 3PH4W system configuration, if any two phases of V L-N falls below the 20 V pickup setpoint setting and remain there long enough to satisfy the pickup time delay period, the phase loss alarm is triggered.

*Available only in latest firmware versions:

- PM5560 / PM5562 / PM5563 / PM5580 meter models: 4.0.0 and above
- PM5570 / PM5660 / PM5760 meter models: 6.0.0 and above
- PM5650 meter model: 4.10.0 and above
- PM5561 meter model: 12.0.0 and above
- PM5661 / PM5761 meter models: 14.0.0 and above
- PM5570L / PM5660L / PM5760L meter models: 6.0.0 and above

Logic alarms

A logic alarm is used to monitor up to four different inputs or parameters.

The logic alarm is tripped when the individual state of all the inputs (A, B, C, D) cause the output (Y) of a logic operation to be true.

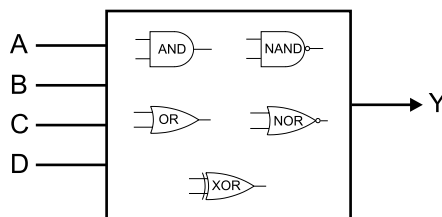

The logic alarm inputs can only be linked using software.

Custom alarms

Custom alarms (Cust1s) are setpoint-driven alarms, similar to the standard (1-Sec) alarms.

A custom alarm's input parameters and setpoint subtypes can only be configured using software.

Custom alarm parameter list

You can configure custom alarms to monitor over and under conditions on a variety of different parameters.

The pickup setpoint and dropout setpoint limits are set to -999999 to 999999.

Alarm parameter	Unit	Alarm parameter	Unit
Current A	A	Active Energy Delivered	kW
Current B	A	Active Energy Received	kW
Current C	A	Active Energy Delivered+Received	kW
Current N	A	Active Energy Delivered-Received	kW
Current G	A	Reactive Energy Delivered	kVAR
Current Avg	A	Reactive Energy Received	kVAR
Current Unbalance A	%	Reactive Energy Delivered+Received	kVAR
Current Unbalance B	%	Reactive Energy Delivered-Received	kVAR
Current Unbalance C	%	Apparent Energy Delivered	kVA
Current Unbalance Worst	%	Apparent Energy Received	kVA
Voltage A-B	V	Apparent Energy Delivered+Received	kVA

Alarm parameter	Unit	Alarm parameter	Unit
Voltage B-C	V	Apparent Energy Delivered-Received	kVA
Voltage C-A	V	Input Metering CH 01 Accumulation	—
Voltage L-L Avg	V	Input Metering CH 02 Accumulation	—
Voltage A-N	V	Input Metering CH 03 Accumulation	—
Voltage B-N	V	Input Metering CH 04 Accumulation	—
Voltage C-N	V	Active Power Last Demand	kW
Voltage L-N Avg	V	Active Power Present Demand	kW
Voltage Unbalance A-B	%	Active Power Predicted Demand	kW
Voltage Unbalance B-C	%	Reactive Power Last Demand	kVAR
Voltage Unbalance C-A	%	Reactive Power Present Demand	kVAR
Voltage Unbalance L-L Worst	%	Reactive Power Predicted Demand	kVAR
Voltage Unbalance A-N	%	Apparent Power Last Demand	kVA
Voltage Unbalance B-N	%	Apparent Power Present Demand	kVA
Voltage Unbalance C-N	%	Apparent Power PredicatedDemand	kVA
Voltage Unbalance L-N Worst	%	Current A Last Demand	A
Active Power A	kW	Current A Present Demand	A
Active Power B	kW	Current A Precidated Demand	A
Active Power C	kW	THD Current A	%
Active Power Total	kW	THD Current B	%
Reactive Power A	kVAR	THD Current C	%
Reactive Power B	kVAR	THD Current N	%
Reactive Power C	kVAR	THD Current G	%
Reactive Power Total	kVAR	thd Current A	%
Apparent Power A	kVA	thd Current B	%
Apparent Power B	kVA	thd Current C	%
Apparent Power C	kVA	thd Current N	%
Apparent Power Total	kVA	thd Current G	%
Frequency	Hz	Min Freq	Hz
Temperature	°C	Max Active Power A	kW
		Max Total Demand Distortion	%
		Max Freq	Hz

Disturbance (sag/swell) alarms

The disturbance (sag/swell) alarms is applicable only in PM5650 / PM5760 / PM5761 meter models.

The meter monitors system's voltage for sags or swell events. It reports the disturbance magnitude and timestamp when the event occurs.

You must configure voltage level, sag limit, swell limit and hysteresis for these alarms to function.

Your meter has two disturbance alarms:

Alarm label	Description
Sag Alarm	Disturbance alarm triggered due to sag events
Swell Alarm	Disturbance alarm triggered due to swell events

Alarm priorities

Each alarm has a priority level that you can use to distinguish between events that require immediate action and those that do not require action.

Alarm priority	Alarm display notification and recording method			
	Alarm LED	Alarm icon	Alarm details	Alarm logging
High	Blinks while the alarm is active.	Blinks while the alarm is active. Alarm icon remains displayed until acknowledged.	Click Details to display what caused the alarm to pickup or drop off. Click Ack to acknowledge the alarm.	Recorded in alarm log.
Medium	Blinks while the alarm is active.	Blinks while the alarm is active.	Click Details to display what caused the alarm to pickup or drop off.	Recorded in alarm log.
Low	Blinks while the alarm is active.	Blinks while the alarm is active.	Click Details to display what caused the alarm to pickup or drop off.	Recorded in alarm log.
None	No activity	None	None	Recorded in event log only.

NOTE: The alarm LED notification only occurs if the alarm / energy pulsing LED is configured for alarming.

Multiple alarm considerations

If multiple alarms with different priorities are active at the same time, the display shows the alarms in the order they occurred.

Alarm setup overview

You can use the meter display or ION Setup to configure unary, digital or standard (1-Sec) alarms. To configure logic and custom alarms, you must use ION Setup.

If you make changes to the basic power meter setup, all alarms are disabled to prevent undesired alarm operation. If you configure Standard or Custom alarm setpoints using the display, any decimals previously configured using ION Setup are lost.

NOTICE

UNINTENDED EQUIPMENT OPERATION

- Verify all alarm settings are correct and make adjustments as necessary.
- Re-enable all configured alarms.

Failure to follow these instructions can result in incorrect alarm functions.

Built-in error-checking

ION Setup dynamically checks incorrect setup combinations. When you enable an alarm, you must set up the pickup and dropout limits to acceptable values first in order to exit the setup screen.

Setting up alarms using the display

You can use the display to create and set up standard (1-Sec), unary, digital and disturbance alarms, and to configure logic and custom alarms after they are created in ION Setup.

NOTE:

- You must use ION Setup to create logic and custom (Cust1s) alarms. After the alarm is created, you can use ION Setup or the display to modify the alarm parameters.
 - It is recommended that you use ION Setup to configure standard (1-Sec) alarms. ION Setup supports a higher resolution to allow you to specify more decimal places when setting up the pickup setpoint and dropout setpoint values for certain measurements.
1. Navigate to the alarms setup menu screens and select the alarm you want to set up.
 2. Configure the setup parameters as explained in the different alarm setup sections.

NOTE: If you use ION Setup to program decimal values on a standard (1-Sec) alarm, do not use the meter display to make subsequent changes to any alarm parameters (including enable/disable), as doing so will cause removal of all decimals previously programmed through ION Setup.
 3. Click **Yes** to save the changes to the meter when prompted.

Setting up alarms using ION Setup

You can use ION Setup to create and set up alarms.

1. Start ION Setup and connect to your meter.
2. Open the **Alarming** screen.
3. Select the alarm you want to configure and click **Edit**.
4. Configure the setup parameters as explained in the different alarm setup sections.

See the ION Setup Device Configuration guide for more information.

Unary alarm setup parameters

Configure the unary alarm setup parameters as required.

ION Setup controls are shown in parentheses.

Setting	Option or range	Description
Enable	Yes (checked) or No (cleared)	This enables or disables the alarm.
Priority	High, Medium, Low, None	This sets the alarm priority and notification options.

Setting	Option or range	Description
Select Dig Output (Outputs)	None Digital Output D1 Digital Output D2 Digital Output D1 & D2	Select the digital output(s) you want to control when the alarm is triggered.
Behaviour	Normal Timed Coil Hold	Select the required behaviour mode NOTE: When you select Normal value, Digital Output is not triggered

Digital alarm setup parameters

Configure the digital alarm setup parameters as required.

ION Setup controls are shown in parentheses.

Setting	Option or range	Description
Enable	Yes (checked) or No (cleared)	This enables or disables the alarm.
Priority	High, Medium, Low, None	This sets the alarm priority and notification options.
Pickup Setpoint (Setpoint Pickup)	On, Off	Use this setting to control when to trip the alarm, based on the state of the digital input (On or Off).
Pickup Time Delay (Delay)	0 to 999999	This specifies the number of seconds the digital input must be in the alarm pickup state before the alarm is tripped.
Dropout Time Delay (Setpoint Dropout Delay)	0 to 999999	This specifies the number of seconds the digital input must be out of the alarm pickup state before the alarm turns off.
Select Dig Output (Outputs)	None Digital Output D1 Digital Output D2 Digital Output D1 & D2	Select the digital output(s) you want to control when the alarm is triggered.

Standard (1-Sec) alarm setup parameters

Configure the standard alarm setup parameters as required.

ION Setup controls are shown in parentheses.

NOTE: It is recommended that you use ION Setup to configure standard (1-Sec) alarms. ION Setup supports a higher resolution to allow you to specify more decimal places when setting up the pickup setpoint and dropout setpoint values for certain measurements.

Setting	Option or range	Description
Enable	Yes (checked) or No (cleared)	This enables or disables the alarm.
Priority	High, Medium, Low, None	This sets the alarm priority and notification options.
Pickup Setpoint mA (Pickup Limit)	Varies depending on the standard alarm you are setting up	This is the value (magnitude) you define as the setpoint limit for triggering the alarm. For "over" conditions, this means the value has gone above the Pickup limit. For "under" conditions, this means the value has gone below the Pickup limit.

Setting	Option or range	Description
Pickup Time Delay (Delay)	0 to 999999	This specifies the number of seconds the signal must stay above the pickup setpoint (for "over" conditions), or below the pickup setpoint (for "under" conditions) before the alarm is tripped.
Dropout Setpoint mA (Dropout Limit)	Varies depending on the standard alarm you are setting up	This is the value (magnitude) you define as the limit for dropping out of the alarm condition. For "over" conditions, this means the value has gone below the Dropout limit. For "under" conditions, this means the value has gone above the Pickup limit.
Dropout Time Delay (Delay)	0 to 999999	This specifies the number of seconds the signal must stay below the dropout setpoint (for "over" conditions), or above the dropout setpoint (for "under" conditions) before the alarm condition is ended.
PU Set Point Lead/Lag (Lead, Lag)	Lead or Lag	Applies to PF (power factor) alarms only. Use this to set the PF value and quadrant to set the pickup setpoint for an over PF condition (PF Leading) or under PF condition (PF Lagging).
DO Set Point Lead/Lag (Lead, Lag)	Lead or Lag	Applies to PF (power factor) alarms only. Use this to set the PF value and quadrant to set the dropout setpoint for an over PF condition (PF Leading) or under PF condition (PF Lagging).
Select Dig Output (Outputs)	None Digital Output D1 Digital Output D2 Digital Output D1 & D2	Select the digital output(s) you want to control when the alarm is triggered.

Setting up logic alarms using ION Setup

Use ION Setup to configure logic alarms.

NOTE: You must first configure the alarms you want to use as inputs to a logic alarm. For example, if you use a standard (1-Sec) alarm as one of the inputs, you must set up its setpoint pickup, dropout and delay parameters.

1. Select the logic alarm you want to set up, then click **Edit**.
2. Select the alarms you want to use as inputs to the logic alarm.
3. Click the double-arrow button to move the selected alarm(s) to the **Selected (max 4)** box, then click **OK**.
4. Configure the rest of the alarm setup parameters.
5. Click **OK** then **Send** to save your changes to the meter.

Logic alarm setup parameters

Configure the logic alarm setup parameters as required.

Setting	Option or range	Description
Enable	Yes (checked) or No (cleared)	This enables or disables the alarm.
Label	Logic Alarm 1 to Logic Alarm 10 (default labels)	ION Setup lets you modify the default label so it more clearly identifies your logic alarm. You can only use letters, numbers and underscores. Spaces are not allowed.
Type	AND	Output of AND operation is True only if all inputs are True.
	NAND	Output of NAND operation is True if one or more inputs are False.

Setting	Option or range	Description
	OR	Output of OR operation is True if one or more inputs are True.
	NOR	Output of NOR operation is True only if all inputs are False.
	XOR	Output of XOR operation is True if only one input is True, and all other inputs are False.
Priority	High, Medium, Low, None	This sets the alarm priority and notification options.
Select Dig Output (Outputs)	None, Digital Output D1, Digital Output D2, Digital Output D1 & D2	Select the digital output(s) you want to control when the alarm is triggered.

Logic alarm setup error prompts

Both the meter and ION Setup have error-checking provisions, and alert you with an error message if there is an error in the logic alarm setup.

You are alerted if the following actions are attempted:

- The output of a logic alarm is used as an input to itself.
- The same source is duplicated as another input on the same logic alarm.
- The source register used is invalid or is a nonexistent parameter.

Setting up custom alarms using ION Setup

Use ION Setup to configure custom (Cust1s) alarms.

1. Select the custom alarm you want to set up, then click **Enable** to display the available setup options.
2. Use the dropdown list to select the parameter you want to set for your custom alarm.
3. Use the **Label** box to define a name for your custom alarm.
4. Use the dropdown list to select the setpoint condition you want to monitor:
 - Over: Alarm condition occurs when the value goes above the pickup setpoint setting.
 - Under: Alarm condition occurs when the value goes below the pickup setpoint setting.
 - Over (absolute): Alarm condition occurs when the absolute value goes above the pickup setpoint setting.
 - Under (absolute): Alarm condition occurs when the absolute value goes below the pickup setpoint setting.
5. Configure the rest of the alarm setup parameters.
6. Click **OK** then **Send** to save your changes to the meter

Custom alarm setup parameters

Configure the custom alarm parameters as required.

Setting	Option or range	Description
Enable	Yes (checked) or No (cleared)	This enables or disables the alarm.
Setpoint Pickup	Varies depending on the custom alarm you are setting up	This is the value (magnitude) you define as the setpoint limit for triggering the alarm. For "over" conditions, this means the value has

Setting	Option or range	Description
		gone above the Pickup limit. For “under” conditions, this means the value has gone below the Pickup limit.
Delay (Setpoint Pickup)	0 to 999999	This specifies the number of seconds the signal must stay above the pickup setpoint (for “over” conditions), or below the pickup setpoint (for “under” conditions) before the alarm is tripped.
Setpoint Dropout	Varies depending on the custom alarm you are setting up	This is the value (magnitude) you define as the limit for dropping out of the alarm condition. For “over” conditions, this means the value has gone below the Dropout limit. For “under” conditions, this means the value has gone above the Pickup limit.
Delay (Setpoint Dropout)	0 to 999999	This specifies the number of seconds the signal must stay below the dropout setpoint (for “over” conditions), or above the dropout setpoint (for “under” conditions) before the alarm condition is ended.
Priority	High, Medium, Low, None	This sets the alarm priority and notification options.
Select Dig Output (Outputs)	None, Digital Output D1, Digital Output D2, Digital Output D1 & D2	Select the digital output(s) you want to control when the alarm is triggered.

Setting up disturbance alarms using display

The disturbance (sag/swell) alarms is applicable only in PM5650 / PM5760 / PM5761 meter models.

NOTE: Before you enable sag/swell alarm, make sure you configure sag/swell setup parameters as mentioned in Table Sag and swell setup parameters available using the display, page 202.

You can use the display to configure the disturbance alarms.

1. Navigate to **Maint > Setup**.
2. Enter the setup passcode (default is “0”), then press **OK**.
3. Navigate to **Alarm > Dist**.
4. Move the cursor to point to **Sag Alarm** or **Swell Alarm** you want to modify, then press **Edit**.
5. Modify the parameters as required, then press **OK**.
6. Press the up arrow to exit. Press **Yes** to save your changes.

Sag alarm/Swell alarm setup parameters available using the display

Parameter	Values	Description
Enable	Yes, No	This enables or disables the alarm
Priority	High, Medium, Low, None	This sets the alarm priority and notification options
Select Dig Output	None Digital Output D1 Digital Output D2 Digital Output D1 & D2	Select the digital output(s) you want to control when the alarm is triggered

LED alarm indicator

You can use the meter’s alarm / energy pulsing LED as an alarm indicator.

When set to detect alarms, the LED blinks to indicate an alarm condition.

NOTE: The alarm / energy pulsing LED on the PM5561 / PM5661 / PM5761 is permanently set for energy pulsing and cannot be used for alarms.

Configuring the LED for alarms using the display

You can use the meter display to configure the alarm / energy pulsing LED for alarming.

NOTE: The alarm / energy pulsing LED on the PM5561 / PM5661 / PM5761 is permanently set for energy pulsing and cannot be used for alarms.

1. Navigate to the **LED** setup menu screen.
2. Set the mode to **Alarm**, then press **OK**.
3. Press the up arrow to exit. Press **Yes** to save your changes.

Configuring the LED for alarms using ION Setup

You can use ION Setup to configure your meter's LED for alarming.

NOTE: The alarm / energy pulsing LED on the PM5561 / PM5661 / PM5761 is permanently set for energy pulsing and cannot be used for alarms.

1. Open ION Setup and connect to your meter. See the ION Setup Help for instructions.
2. Navigate to **I/O configuration > Energy Pulsing**.
3. Select **Front Panel LED** and click **Edit**.
4. Set the control mode to **Alarm**.
5. Click **Send** to save your changes.

Alarm display and notification

The meter notifies you when an alarm condition is detected.

Alarm icon

When a low, medium or high priority alarm is tripped, this symbol appears at the top right corner of the display screen, indicating that an alarm is active:



For high priority alarms, the alarm icon remains displayed until you acknowledge the alarm.

Alarm / energy pulsing LED

If configured for alarming, the alarm / energy pulsing LED also flashes to indicate the meter has detected an alarm condition.

Alarm screens

You can use the display buttons to navigate to the alarm setup or display screens.

Active alarms

When a pickup event occurs, the active alarm list appears on the meter display's Active Alarms screen. Press **Detail** to see more event information.

Alarm details

Details about the alarms can be viewed using:

- the active alarms (Active), alarm history (Hist), alarm counters (Count) and unacknowledged alarms (Unack) screens on the meter display, or
- the Active Alarms and Alarm History screens on the meter webpages.

Email on alarm

You can configure the meter to send an email or email-to-text message when alarm conditions are detected, and set the alarm types and priorities that trigger the email.

Both the email and the text messages provide the label and the address of the meter's main webpage.

- The text message notifies you that there is an alarm condition. You can then view the active alarms on the meter webpages for details.
- The email message contains additional information about the alarm condition, such as the alarm name, type, value, priority, and date and time.

In addition, if the connection to the email server is lost, the meter sends a message once the connection is reestablished so you can check if you missed any alarm notifications.

Example email

Schneider Electric		
High and Medium and Low Priority Alarms: Power Meter		
12/05/2014 09:40:27		
From: Schneider Electric		
Alarm Summary Report		
HTTP://000.000.000.000		
Alarm	Value	Comment
09:39:19 12/05/2014 Low Digital Alarm S1	1	Pickup
09:39:19 12/05/2014 High Digital Alarm S4	1	Pickup
09:39:31 12/05/2014 High Digital Alarm S4	0	Dropout
09:39:31 12/05/2014 Low Digital Alarm S1	0	Dropout
09:40:00 12/05/2014 Medium Over Current, Phase - Current A	8.0000	Pickup
09:40:00 12/05/2014 Medium Over Current, Phase - Current B	8.0000	Pickup
09:40:00 12/05/2014 Medium Over Current, Phase - Current C	8.0000	Pickup

Implementation and default configuration

NOTE: Refer to Restoration of temporarily disabled configuration settings in webpages, page 235 to know availability of these features on your meter model.

The email on alarm feature is disabled by default.

Use the meter’s webpages to enable the feature, configure up to 3 email or email-to-text addresses and set up related parameters.

Email on alarm examples

There are some differences between the email and email-to-text message functionality for the email on alarm feature.

Overview of the email on alarm feature: email

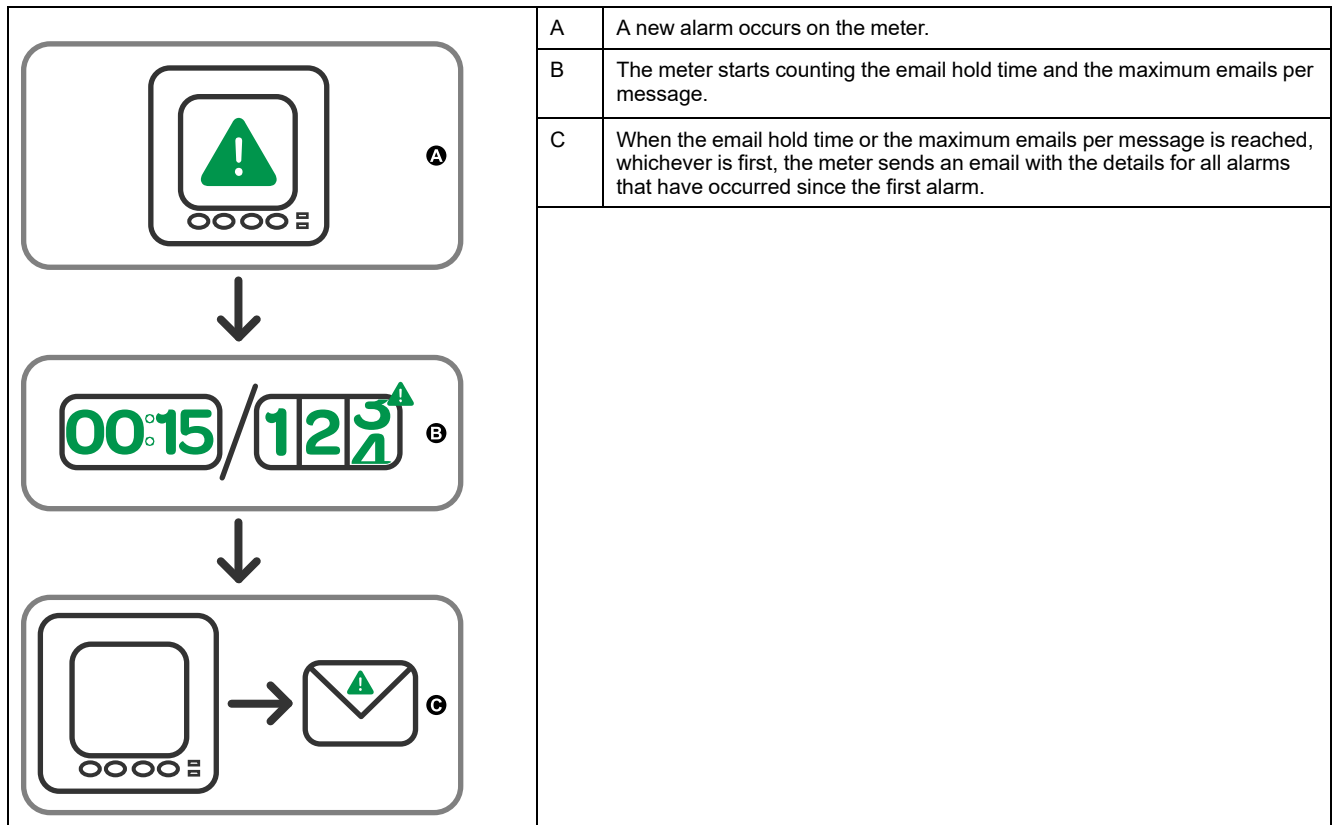

Overview of the email on alarm feature: email-to-text

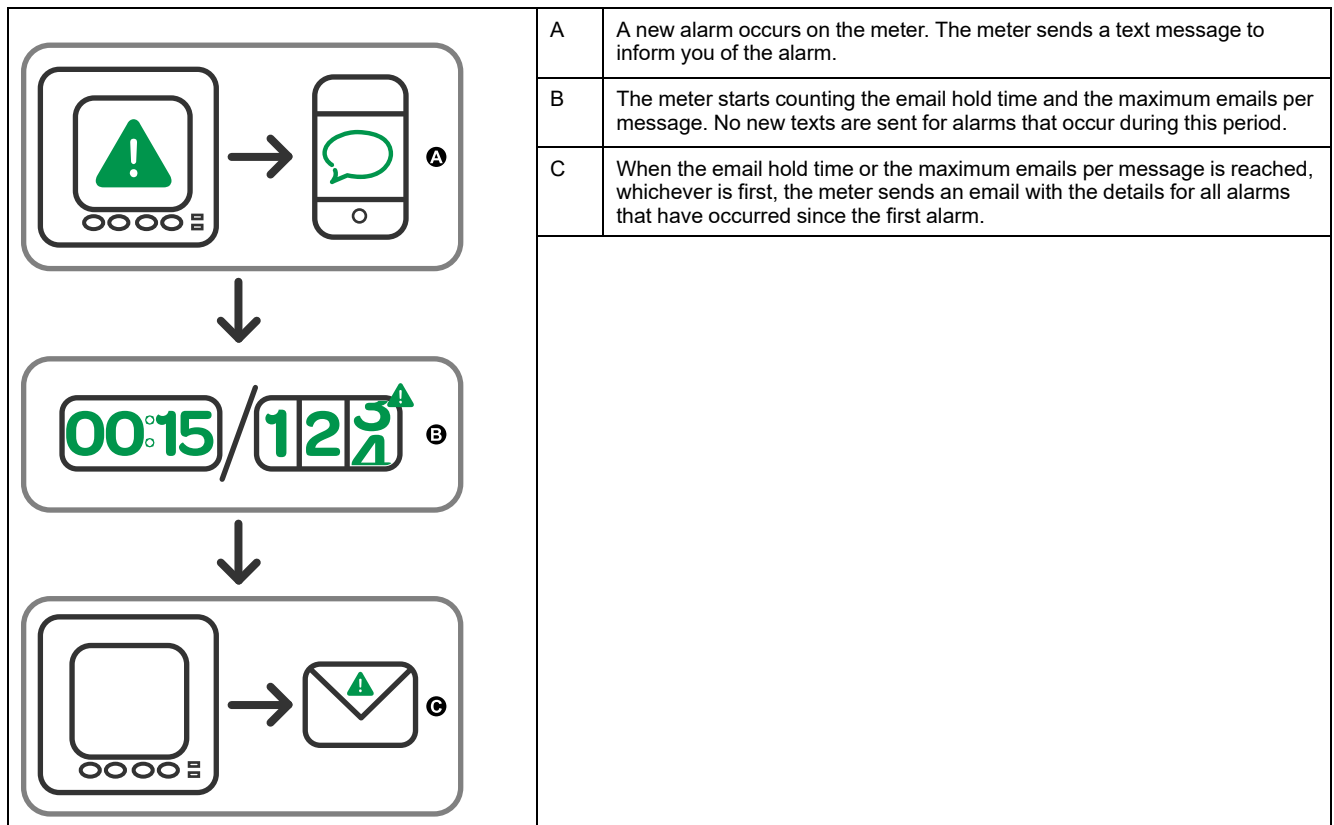

Configuring the email on alarm feature using the webpages

NOTE: Refer to Restoration of temporarily disabled configuration settings in webpages, page 235 to know availability of these features on your meter model.

Use the meter webpages to configure the email on alarm feature. In order to configure the feature, you need the connection information for your SMTP server, available from your network administrator.

NOTE: The email is sent in the language set for the Product Master or Administrator account on the meter webpages.

1. Login to the meter webpages.
2. Based on your meter firmware version, click **Settings > Email On Alarm Settings** OR click **Settings > Communication > Email On Alarm Settings**.
3. Configure one or more email addresses to send the alarm notification to.
 - a. Click **Yes** to enable that email address.
 - b. Select **Email** or **Text** from the **Email/Text** list.
 - c. Type a valid email address in the **Email Address** field.

NOTE: To receive text notifications, you must enter the email-to-text address in the correct format. Contact your mobile provider for the correct format for your mobile device.

4. Configure the types of alarms you want to receive notifications for.
 - Click **Yes** beside the alarm priorities that you want to receive notifications for: **High, Medium** and **Low**.
 - Click **Yes** beside the types of alarms you want to receive notifications for: **Pickup, Dropout** and **Diagnostic**.
5. Configure the SMTP server parameters.
6. Click **Send Test Email** to validate the email on alarm configuration.

If configured correctly, you will receive an email or text informing you that you successfully configured the email settings.

7. Configure the advanced email on alarm parameters, if required.

NOTE: You can click **Defaults** to reset the advance parameters to their default values.

Email on alarm SMTP server parameters available using the webpages

Parameter	Values	Description
SMTP Server IP address	—	Enter the IP address of the SMTP server used to send the email, available from your network administrator
SMTP Port Number	—	The port on the SMTP server that the meter the email to
SMTP Server Requires Login	Yes / No	Click Yes if the SMTP server requires login then type in the username and password for the server

Email on alarm advanced parameters available using the webpages

Parameter	Values	Description
Max Alarms per Email	1 – 60	The maximum number of alarms the meter accumulates before sending an email. After the meter accumulates the maximum number, it sends an email even if the max email hold time has not elapsed.
Max Email Hold Time	1 – 300	The maximum time, in seconds, that the meter waits before sending an email. After the max email hold time elapses, the meter sends any accrued alarms even if there are less than the Max Alarms per Email.
Server Connection Timeout	30 – 600	The maximum time, in seconds, that the meter tries to connect to the SMTP server.
Email Retry Attempts	1 – 100	The number of times the meter tries to send an email if the first attempt is unsuccessful.

Active alarms list and alarm history log

Each occurrence of a low, medium or high priority alarm is stored in the active alarms list and recorded in the alarm history log.

The active alarm list holds 40 entries at a time. The list works as a circular buffer, replacing old entries as new entries over 40 are entered into the active alarms list. The information in the active alarms list is volatile and reinitializes when the meter resets.

The alarm history log holds 40 entries. The log also works as a circular buffer, replacing old entries with new entries. The information in the alarm history log is nonvolatile and is retained when the meter resets.

Viewing active alarm details using the display

When an alarm condition becomes true (alarm = ON), the alarm is displayed on the active alarms screen.

Alarms are displayed sequentially in the order of their occurrence, regardless of priority. The alarm details show the date and time of the alarm event, the type of event (for example, pickup or unary), which phase the alarm condition was detected on, and the value that caused the alarm condition.

NOTE: Alarm details are not available if the alarm priority is set to None.

The alarm details (for low, medium and high priority alarms) are also recorded in the alarm history log.

1. Navigate to **Alarm > Active**.
2. Select the alarm you want to view (the latest ones appear on top).

3. Press **Detail**.

NOTE: For unacknowledged high priority alarms, the Ack option appears on this screen. Press **Ack** to acknowledge the alarm, or return to the previous screen if you do not want to acknowledge the alarm.

Viewing alarm history details using the display

The alarm history log keeps a record of active alarms and past alarms.

When an active alarm condition becomes false (alarm = OFF), the event is recorded in the alarm history log and alarm notification (alarm icon, alarm LED) is turned off.

Alarms are displayed sequentially in the order of their occurrence, regardless of priority. The alarm details show the date and time of the alarm event, the type of event (for example, dropout or unary), which phase the alarm condition was detected on, and the value that caused the alarm condition to turn ON or OFF.

NOTE: Alarm details are not available if the alarm priority is set to None.

1. Navigate to **Alarm > Hist**.
2. Select the alarm you want to view (the latest ones appear on top).
3. Press **Detail**.

NOTE: For unacknowledged high priority alarms, the **Ack** option appears on this screen. Press **Ack** to acknowledge the alarm, or return to the previous screen if you do not want to acknowledge the alarm.

Viewing alarms counters using the display

Every occurrence of each type of alarm is counted and recorded in the meter.

NOTE: The alarm counters roll over to zero after reaching the value 9999.

1. Select **Alarm > Count**.
The **Alarms Counter** screen displays.
2. Scroll through the list to view the number of alarm occurrences for each type of alarm.

Acknowledging high-priority alarms using the display

You can use the meter display to acknowledge high-priority alarms.

1. Navigate to **Alarm > Unack**.
2. Select the alarm you want to acknowledge.
3. Press **Detail**.
4. Press **Ack** to acknowledge the alarm.
5. Repeat for other unacknowledged alarms.

Resetting alarms using ION Setup

Use ION Setup to reset alarms.

You can also reset alarms using the meter display.

1. Connect to your meter in ION Setup.
2. Open the **Meter Resets** screen.
3. Select the alarm parameters to clear and click **Reset**.

Multi-tariffs

Multi-tariff

The multi-tariff feature allows you to set up different tariffs for storing energy values.

The energy values for different tariffs are stored in registers that correspond to each of those tariffs.

Multi-tariff example

The multi-tariff feature can be used when a utility has set up tariff schedules with different rates based on what day or time of day energy is consumed.

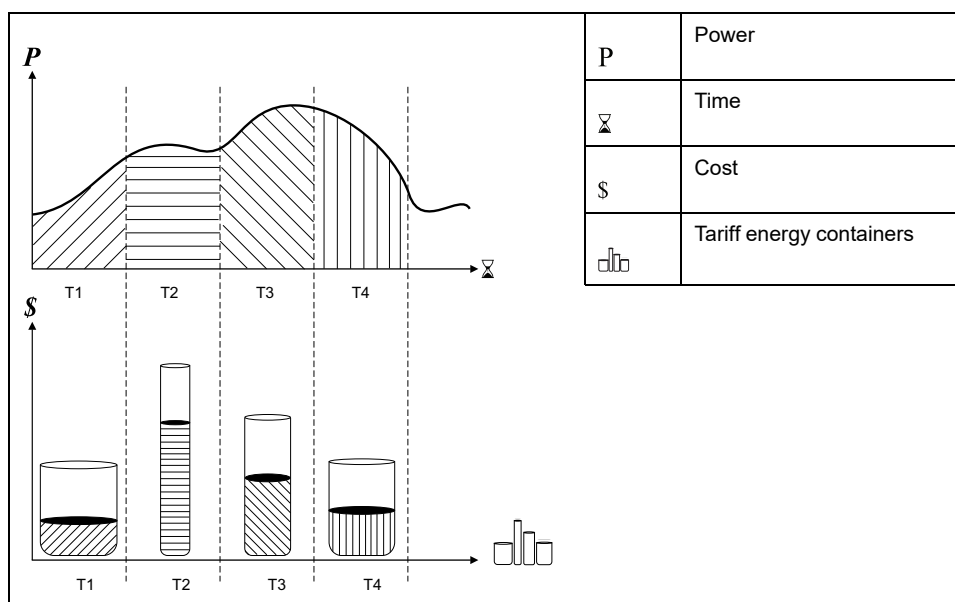

In the above illustration, the area under the power curve equals the energy consumed.

Typically, the utility sets tariff schedules so the cost of energy is higher during high demand or high energy consumption times. How these “tariff energy containers” are configured determines how fast these containers fill, which correlates to increasing energy costs. The price per kWh is lowest at tariff T1 and highest at tariff T2.

Multi-tariff implementation

The meter supports configuration of up to 8 different tariffs to measure and monitor energy usage that can be used in billing or cost applications.

There are different tariff modes you can use to determine what tariff is applied and when: Command mode, Time of Day mode, and Input mode.

Command mode overview

You can use command mode to send a Modbus command to the device which sets the active tariff.

The active tariff is applied to the measured energy until you send another Modbus command that sets a different tariff.

Search for your meter's Modbus register list at www.se.com to download the Modbus map.

Time of day mode overview

You can use time of day mode to create a tariff schedule that specifies where the meter stores energy or input metered data, based on the time of year (month, day), the type of day (every day, weekend, weekday or a specific day of the week), or time of day.

The data collected from the different tariffs can then be used in energy audits or similar costing and budget planning purposes.

Time of day mode tariff validity

A valid time of day tariff has certain conditions and limitations:

- Each tariff must cover a unique time period (tariffs cannot overlap), but there can be periods with no tariff.
- Any number of tariffs, from none to the maximum number of tariffs, can be applied.
- Time of day tariffs do not adjust for daylight savings time.
- Time of day tariffs include February 29th in leap years (however, it is not recommended to have February 29th as a start or end date, as that tariff would be invalid for non-leap years).
- Except for leap years, tariff dates are not year-specific; if you wanted to create a tariff that starts on the first Monday in August, you need to enter the date for that year, then manually update the tariff information for the subsequent years.

Your device performs validation checks as you enter tariff information; it prompts you to change the information that you have entered or set the tariff to disabled if the tariff configuration is invalid. These checks can include:

- Start and end times must be different (for example, you cannot create a tariff that starts at 02:00 and also ends at 02:00).
- Start time can only be earlier than end time for tariffs that are applied every day. You can create a daily tariff that starts at 06:00 and ends at 02:00, but these times are only valid for the Everyday tariff and invalid for the other tariff types.
- Start day must be earlier than end day if the days are in the same month. You cannot create a tariff that starts June 15 and ends June 12.

Time of day tariff creation methods

You can create time of day tariffs using one of two methods, or a combination of these methods.

The two methods of creating tariffs are:

- Time of year tariffs divide the year into multiple sections (usually seasons), where each section has one or more day types. For example, an eight tariff configuration using this method could have Spring, Summer, Fall and Winter seasons that also use different weekend and weekday tariffs.

- Daily tariffs can divide days by day of the week, a weekday, a weekend, or every day, and can specify the time of day. For example, an eight tariff configuration could have every day in the year divided into three-hour tariff periods or could have four tariffs for weekends and four tariffs for weekdays.

You can combine these methods if, for example you wanted to create a tariff that applies on Mondays from January 1 to June 30, from 09:00 to 17:00. However, since only one tariff can be applied at any time, you cannot use an everyday or weekday tariff type because you already specified a tariff for the time periods 09:00 to 17:00.

Depending on how you configure the tariffs and the maximum number of tariffs supported by your meter, you may not be able to assign tariffs for the entire year, potentially leaving time gaps that do not have any tariff assigned to them.

Input mode overview

You can use input mode to have the digital inputs of the device set to know which tariff is applied to the energy that is presently being consumed.

The number of different tariffs that can be applied is determined by the number of available digital inputs and the total number of tariffs supported by your device.

Digital input assignment for input control mode

You need to assign one or more digital inputs with non-exclusive associations to define the active tariff.

If a digital input is used for multi-tariff, it cannot be used for an exclusive association (such as Demand Sync or Input Metering), but digital inputs can be shared with a non-exclusive association (such as Alarms). To make a digital input available for setting tariffs, any conflicting associations must be manually removed at the source of the original association.

You cannot configure any digital input tariff if digital input 1 is not available for association. Likewise, digital input 2 must be available to select more than two tariffs.

The status of the digital inputs is used to calculate the binary value of the active tariff, where off = 0 and on = 1. The calculation of the number of tariffs value can differ, depending on the number of digital inputs that can be selected (i.e., inputs that can be associated with multi-tariff).

Digital input requirements for required number of tariffs

Applicable for PM5650 meter model and PM5500 series except PM5570 and PM5570L

Number of tariffs required	Digital inputs required	
	Configuration 1	Configuration 2
1	—	1 (digital input 1)
2	1 (digital input 1)	2 (digital input 1 and 2)
3	—	2 (digital input 1 and 2)
4	2 (digital input 1 and 2)	3 (digital input 1, 2 and 3)
5	—	3 (digital input 1, 2 and 3)
6	—	3 (digital input 1, 2 and 3)

Number of tariffs required	Digital inputs required	
	Configuration 1	Configuration 2
7	—	3 (digital input 1, 2 and 3)
8	3 (digital input 1, 2 and 3)	4 (digital input 1, 2, 3 and 4)

Applicable for PM5570 / PM5660 / PM5661 / PM5760 / PM5761 / PM5570L / PM5660L / PM5760L meter models

Number of tariffs required	Digital inputs required	
	Configuration 1	Configuration 2
1	—	1 (digital input 1)
2	1 (digital input 1)	2 (digital input 1 and 2)
3	—	2 (digital input 1 and 2)
4	2 (digital input 1 and 2)	2 (digital input 1 and 2)

Configuration 1: 8 tariff assignment using 3 digital inputs

Applicable for PM5650 meter model and PM5500 series except PM5570 and PM5570L

NOTE: There is no inactive tariff with this configuration.

Tariff	Digital input 4	Digital input 3	Digital input 2	Digital input 1
T1	N/A	0	0	0
T2	N/A	0	0	1
T3	N/A	0	1	0
T4	N/A	0	1	1
T5	N/A	1	0	0
T6	N/A	1	0	1
T7	N/A	1	1	0
T8	N/A	1	1	1

Configuration 1: 4 tariff assignment using 2 digital inputs

Applicable for PM5570 / PM5660 / PM5661 / PM5760 / PM5761 / PM5570L / PM5660L / PM5760L meter models

NOTE: There is no inactive tariff with this configuration.

Tariff	Digital input 2	Digital input 1
T1	0	0
T2	0	1
T3	1	0
T4	1	1

Configuration 2: 8 tariff assignment using 4 digital inputs

Applicable for PM5650 meter model and PM5500 series except PM5570 and PM5570L

NOTE: Digital input configuration 0000 means there are no active tariffs (all tariffs are disabled).

NOTE: Any configuration above T8 (i.e., 1001 and higher) is invalid and therefore ignored by the meter (the active tariff does not change).

Tariff	Digital input 4	Digital input 3	Digital input 2	Digital input 1
None	0	0	0	0
T1	0	0	0	1
T2	0	0	1	0
T3	0	0	1	1
T4	0	1	0	0
T5	0	1	0	1
T6	0	1	1	0
T7	0	1	1	1
T8	1	0	0	0

Configuration 2: 3 tariff assignment using 2 digital inputs

Applicable for PM5570 / PM5660 / PM5661 / PM5760 / PM5761 / PM5570L / PM5660L / PM5760L meter models

NOTE: Digital input configuration 0000 means there are no active tariffs (all tariffs are disabled).

Tariff	Digital input 2	Digital input 1
None	0	0
T1	0	1
T2	1	0
T3	1	1

Tariff setup

You can change tariffs and the tariff mode using the display and/or ION Setup.

You can change the tariff mode using the display. You can configure input mode and time of day mode using the display or ION Setup. It is recommended that you use ION Setup to configure time of day mode.

The active tariff is controlled based on the tariff mode.

- When the meter is set to command mode for tariffs, the active tariff is controlled by Modbus commands sent from your energy management system or other Modbus master.
- When the meter is set to input mode for tariffs, the active tariff is controlled by the status of the digital inputs.
- When the meter is set to time of day mode for tariffs, the active tariff is controlled by the day type, the start and end times, and the start and end dates.

Time of day mode tariff configuration considerations

The time of day tariff is not a calendar; the meter does not calculate the corresponding day of the week to a specific date, but February 29th is considered a valid date if you are programming the meter during a leap year.

When you enter tariff times using the display, be aware that the displayed minute value includes the entire minute. For example, an end time of 01:15 includes the

time from 01:15:00 through 01:15:59. To create a tariff period that starts right after this, you must set the next tariff's start time to 01:16. Although it may appear that there is a gap between these tariffs, there is not.

NOTE: You must always set the tariff times to UTC (GMT, Greenwich Mean Time), not local time. The GMT Offset (h) setup parameter does not apply to tariff times.

Input mode tariff configuration considerations

Digital inputs are available for tariffs if they are not used, or if they are only associated with alarms (Normal). To make a digital input available, you must manually disconnect the conflicting association before configuring tariffs.

NOTE: You must always set the tariff times to UTC (GMT, Greenwich Mean Time), not local time. The GMT Offset (h) setup parameter does not apply to tariff times.

To configure the tariffs using ION Setup, see the "PM5500 / PM5600 / PM5700" topic in the ION Setup online help or in the ION Setup device configuration guide, available for download at www.se.com.

Configuring input mode tariffs using the display

Use the display to configure input mode tariffs. You can also configure input mode tariffs using ION Setup.

You cannot configure any digital input tariff if digital input 1 is not available for association. Likewise, digital input 2 must be available to select more than two tariffs.

The status of the digital inputs is used to calculate the binary value of the active tariff, where off = 0 and on = 1. The calculation of the number of tariffs value can differ, depending on the number of digital inputs that can be selected (i.e., inputs that can be associated with multi-tariff).

1. Navigate to **Maint > Setup**.
2. Enter the setup passcode (default is "0"), then press **OK**.
3. Navigate to **Meter > Tariff**.
4. Select **Mode** and press **Edit**.
5. Press **+** or **-** to change the setting to **Input**, then press **OK**.
NOTE: If a digital input association error prompt displays, you must exit from the tariff setup screens and remove the digital input association.
6. Navigate to **Tariffs**, then press **Edit**.
7. Press **+** or **-** to change the number of tariffs you want to set up and press **OK**.
The maximum number of tariffs that you can apply is determined by the number of available digital inputs.
8. Navigate to **Inputs**, then press **Edit**.
If applicable, press **+** or **-** to change how many digital inputs you want to use to control which tariff is selected (active). Press **OK**.
9. Press the up arrow to exit, then **Yes** to save your changes.

Measurements

Instantaneous measurements

The meter provides highly accurate 1-second measurements.

These measurements include true RMS, per phase and total for:

- 3-phase voltage (line-to-line, line-to-neutral)
- 3-phase current, neutral and ground current
- Active (kW), reactive (kVAR) and apparent (kVA) power
- True PF (power factor)
- Displacement PF
- System frequency
- Voltage (line-to-line, line-to-neutral) and current unbalance

The voltage and current inputs are continuously monitored at a sampling rate of 128 points per cycle. This amount of resolution helps enable the meter to provide reliable measurements and calculated electrical values for various commercial, buildings and industrial applications.

Residual current

Available in specific meter models. Refer to Features differentiation matrix for PM5500 / PM5600 / PM5700 series, page 20 for the availability.

Residual current is an unintended flow of current to ground typically resulting from an issue with electrical insulation within a load or connecting wiring.

Residual current may be measured as:

- The sum total of all currents flowing through the phase (and neutral) conductors
- The current flowing through the Protective Earth (PE) conductor in TT and TN earthing systems

The RCM meter models can be used to continuously measure residual currents in an electrical system. The RCM meter models are equipped with two input channels (I5 and I6) that require specific toroid current sensors. Each RCM channel is capable of dual alarm configuration allowing a warning alert level and a higher level over alarm. The residual current measurements are processed once per second.

⚠ WARNING

UNINTENDED OPERATION OR METER DAMAGE

- Do not use this device for critical control or protection applications where human or equipment safety relies on the operation of the control circuit.
- Do not exceed the specified current through I5 and I6 terminals.

Failure to follow these instructions can result in death, serious injury, or equipment damage.

Typical applications for meters with RCM capability include:

- Leakage current measurement
- Earth (Ground) current measurement
- Automatic notification and/or digital output operation in event of leakage current alarm
- Electrical installation reliability profiling

Energy measurements

The meter provides fully bi-directional, 4-quadrant, Class 0.2S accurate energy metering.

The meter calculates and stores all accumulated active, reactive and apparent energy measurements in non-volatile memory:

- Wh, VARh, VAh (delivered and received)
- Wh, VARh, VAh net (delivered - received)
- Wh, VARh, VAh absolute (delivered + received)

Energy registers can be logged automatically on a programmed schedule. All energy parameters represent the total for all three phases. You can view accumulated energy from the display.

Configuring the energy scaling using ION Setup

You can use ION Setup to configure the energy scaling. Based on the scaling, the energy overflow happens upon reaching the threshold value.

1. Start ION Setup.
2. Connect to your meter.
3. Open the **Energy Scaling** screen.
4. Click **Edit** to configure the **Setup** parameters as required.
5. Use the drop-down list to select the parameter you want to set for your **Energy Scaling**.

NOTE: If you set **Energy Scaling** parameter, for which the threshold value is less than the accumulated energy, the accumulated energy resets to zero.

6. Click **Send** to save your changes to the meter.

Energy Scaling parameters available using the ION Setup

Parameter	Values	Description
Auto (Default)	0 to 9.2233 E	The energy value units automatically change, based on the quantity of energy accumulated, from Kilo to Mega, Mega to Giga, Giga to Tera, Tera to Peta and Peta to Exa. When any one of the energy parameter (delivered or received) exceeds 9.2233 E, all the energy parameters reset to 0.
Kilo (k)	0 to 999.99 k	When any one of the energy parameter (delivered or received) exceeds 999.99 k, all the energy parameters reset to 0.
Mega (M)	0 to 999.99 M	The energy value units automatically change, based on the quantity of energy accumulated, from Kilo to Mega. When any one of the energy parameter (delivered or received) exceeds 999.99 M, all the energy parameters reset to 0.
Giga (G)	0 to 999.99 G	The energy value units automatically change, based on the quantity of energy accumulated, from Kilo to Mega and Mega to Giga. When any one of the energy parameter (delivered or received) exceeds 999.99 G, all the energy parameters reset to 0.
Tera (T)	0 to 999.99 T	The energy value units automatically change, based on the quantity of energy accumulated, from Kilo to Mega, Mega to Giga and Giga to Tera. When any one of the energy parameter (delivered or received) exceeds 999.99 T, all the energy parameters reset to 0.
Peta (P)	0 to 999.99 P	The energy value units automatically change, based on the quantity of energy accumulated, from Kilo to Mega, Mega to Giga, Giga to Tera and Tera to Peta. When any one of the energy parameter (delivered or received) exceeds 999.99 P, all the energy parameters reset to 0.
Exa (E)	0 to 9.2233 E	The energy value units automatically change, based on the quantity of energy accumulated, from Kilo to Mega, Mega to Giga, Giga to Tera, Tera to Peta and Peta to Exa. When any one of the energy parameter (delivered or received) exceeds 9.2233 E, all the energy parameters reset to 0.

Preset energy

NOTE: Not applicable for MID/MIR meter models.

You can input the previous energy values when you replace the meter. Preset energy value cannot be set more than maximum energy overflow value (9.2233 E).

The preset energy values include active energy (Wh), reactive energy (VARh), apparent energy (VAh) (delivered and received).

Configuring the preset energy using ION Setup

NOTE: Not applicable for MID/MIR meter models.

You can use ION Setup to configure the preset energy values.

1. Start ION Setup.
2. Connect to your meter.
3. Open the **Preset Energy** screen.
4. Click **Edit** to configure the **Setup** parameters as required.
5. From the list, set the **Preset Energy** value for each parameter.

6. Click **Send** to save your changes to the meter.

Preset Energy parameters available using the ION Setup

Parameter	Values	Description
Active Energy Delivered	0 to 9.2233 E	Use this field to enter the preset energy values
Active Energy Received		
Reactive Energy Delivered		
Reactive Energy Received		
Apparent Energy Delivered		
Apparent Energy Received		

Min/max values

When the readings reach their lowest or highest value, the meter updates and saves these min/max (minimum and maximum) quantities in non-volatile memory.

The meter's real-time readings are updated once every 50 cycles for 50 Hz systems, or once every 60 cycles for 60 Hz systems.

Demand measurements

The meter provides present, last, predicted and peak (maximum) demand, and a date/timestamp when the peak demand occurred.

The meter supports standard demand calculation methods, including sliding block, fixed block, rolling block, thermal and synchronized.

Peak demand registers can be reset manually (passcode protected) or logged and reset automatically on a programmed schedule.

Demand measurements include:

- kW, kVAR, kVA demand total and per phase
- Amps demand average, per phase and neutral (4th CT)
- Demand calculation for pulse input metering (WAGES)

Power demand

Power demand is a measure of average power consumption over a fixed time interval.

NOTE: If not specified, references to demand are assumed to mean power demand.

The meter measures instantaneous consumption and can calculate demand using various methods.

Power demand calculation methods

Power demand is calculated by dividing the energy accumulated during a specified period by the length of that period.

How the meter performs this calculation depends on the method and time parameters you select (for example, timed rolling block demand with a 15-minute interval and 5-minute subinterval).

To be compatible with electric utility billing practices, the meter provides the following types of power demand calculations:

- Block interval demand
- Synchronized demand
- Thermal demand

You can configure the power demand calculation method from the display or software.

Block interval demand

For block interval demand method types, you specify a period of time interval (or block) that the meter uses for the demand calculation.

Select/configure how the meter handles that interval from one of these different methods:

Type	Description
Timed Sliding Block	Select an interval from 1 to 60 minutes (in 1-minute increments). If the interval is between 1 and 15 minutes, the demand calculation <i>updates every 15 seconds</i> . If the interval is between 16 and 60 minutes, the demand calculation <i>updates every 60 seconds</i> . The meter displays the demand value for the last completed interval.
Timed Block	Select an interval from 1 to 60 minutes (in 1-minute increments). The meter calculates and updates the demand at the end of each interval.
Timed Rolling Block	Select an interval and a subinterval. The subinterval must divide evenly into the interval (for example, three 5-minute subintervals for a 15-minute interval). Demand is <i>updated at the end of each subinterval</i> . The meter displays the demand value for the last completed interval.

Block interval demand example

The following illustration shows the different ways power demand is calculated using the block interval method. In this example, the interval is set to 15 minutes.

Timed Sliding Block

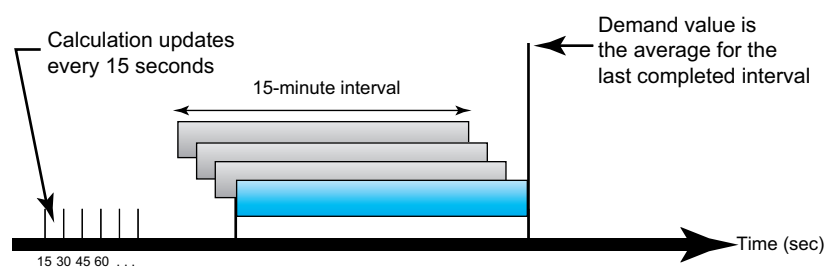

Timed Block

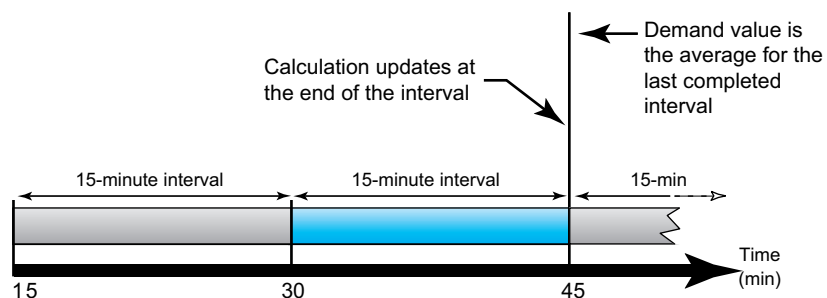

Timed Rolling Block

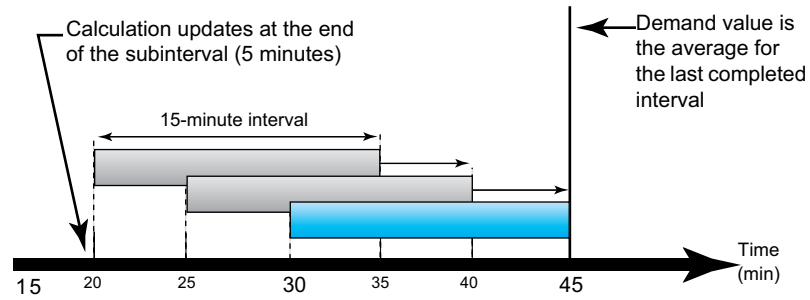

Synchronized demand

You can configure the demand calculations to be synchronized using an external pulse input, a command sent over communications, or the device’s internal real-time clock.

Type	Description
Input synchronized demand	This method allows you to synchronize the demand interval of your meter with an external digital pulse source (such as another meter’s digital output) connected to your meter’s digital input. This helps synchronize your meter to the same time interval as the other meter for each demand calculation.
Command synchronized demand	This method allows you to synchronize the demand intervals of multiple meters on a communications network. For example, if a programmable logic controller (PLC) input is monitoring a pulse at the end of a demand interval on a utility revenue meter, you can program the PLC to issue a command to multiple meters whenever the utility meter starts a new demand interval. Each time the command is issued, the demand readings of each meter are calculated for the same interval.
Clock synchronized demand	This method allows you to synchronize the demand interval to the meter’s internal real-time clock. This helps you synchronize the demand to a particular time, typically on the hour (for example, at 12:00 am). If you select another time of day when the demand intervals are to be synchronized, the time must be specified in minutes from midnight. For example, to synchronize at 8:00 am, select 480 minutes.

NOTE: For these demand types, you can choose block or rolling block options. If you select a rolling block demand option, you need to specify a subinterval.

Thermal demand

Thermal demand calculates the demand based on a thermal response, which imitates the function of thermal demand meters.

The demand calculation updates at the end of each interval. You can set the demand interval from 1 to 60 minutes (in 1-minute increments).

Thermal demand example

The following illustration shows the thermal demand calculation. In this example, the interval is set to 15 minutes. The interval is a window of time that moves across the timeline. The calculation updates at the end of each interval.

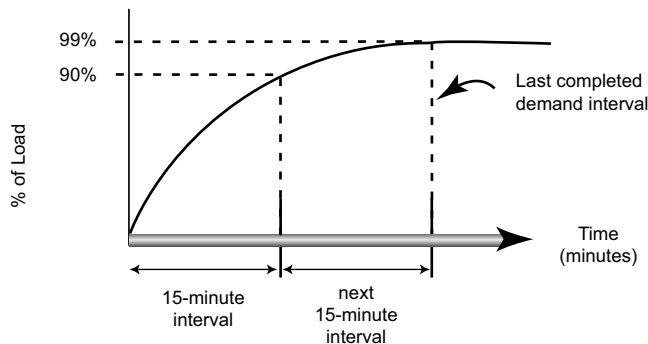

Current demand

The meter calculates current demand using the block interval, synchronized or thermal demand methods.

You can set the demand interval from 1 to 60 minutes in 1 minute increments (for example, 15 minutes).

Predicted demand

The meter calculates predicted demand for the end of the present interval for kW, kVAR, and kVA demand, taking into account the energy consumption so far within the present (partial) interval and the present rate of consumption.

Predicted demand is updated according to the update rate of your meter.

The following illustration shows how a change in load can affect predicted demand for the interval. In this example, the interval is set to 15 minutes.

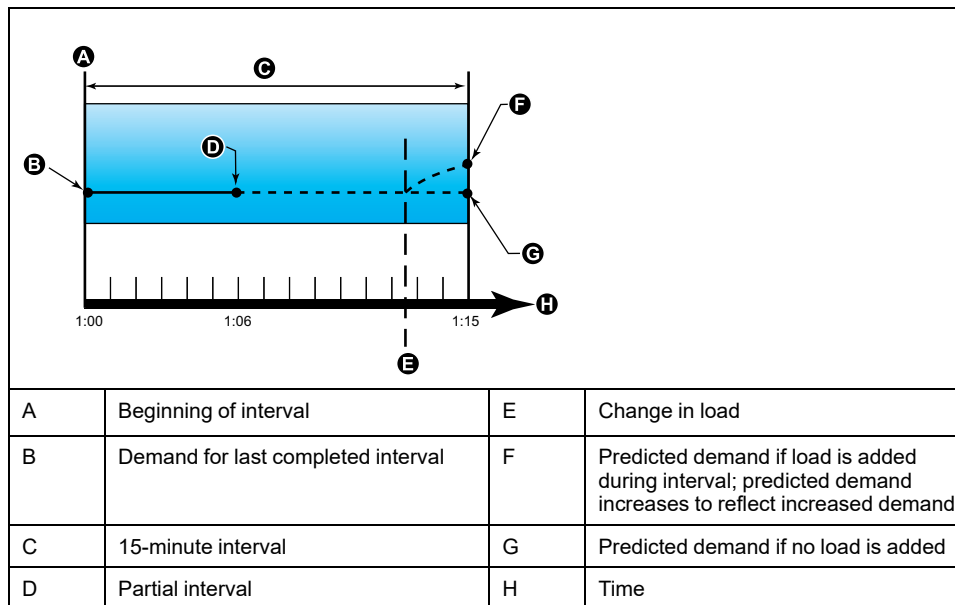

Peak demand

The meter records the peak (or maximum) values for kW, kVAR, and kVA power (or peak demand).

The peak for each value is the highest average reading since the meter was last reset. These values are maintained in the meter's non-volatile memory.

The meter also stores the date and time when the peak demand occurred. In addition to the peak demand, the meter also stores the coinciding average 3-phase power factor. The average 3-phase power factor is defined as “demand kW/demand kVA” for the peak demand interval.

Input Metering Demand

The input metering channels can be used to measure water, air, gas, electric and steam utilities (WAGES).

The number of available metering input channels equals the number of unused digital inputs.

Typical WAGES utility meters have no communications capabilities, but they usually have a pulse output. The utility meter sends a pulse to its output each time a preset quantity or amount of (WAGES) energy is consumed or delivered. This preset quantity or amount is referred to as the pulse weight.

To monitor the utility meter, connect its pulse output to the power meter's digital input. Associate the digital input for input metering and configure the input metering operation mode, pulse weight, consumption units and demand units.

Setting up demand calculations using the display

Use the Demand setup screens to define power demand, current demand or input metering demand.

Demand is a measure of average consumption over a fixed time interval.

1. Navigate to **Maint > Setup**.
2. Enter the setup passcode (default is “0”), then press **OK**.
3. Navigate to **Meter > Dmd**.
4. Move the cursor to select **Power Demand**, **Current Demand** or **Input Demand**.

5. Move the cursor to point to the parameter you want to modify, then press **Edit**.

Values	Description
Method	
Timed Sliding Block Timed Block Timed Rolling Block Input Sync Block Input Sync Roll Block Cmd Sync Block Cmd Sync Roll Block Clock Sync Block Clock Sync Roll Block Thermal	Select the appropriate demand calculation method for your needs
Interval	
1–60	Set the demand interval, in minutes.
Subinterval	
1–60	Applies only to rolling block methods. Define how many subintervals the demand interval should be equally divided into.
Select Dig Output	
None Digital Output D1 Digital Output D2	Select which digital output the end of demand interval pulse should be sent to.
Select Dig Input	
None Digital Input S1 Digital Input S2 Digital Input S3* Digital Input S4*	Applies only to input sync methods. Select which digital input is used to sync the demand.
Clock Sync Time	
0 - 2359	Applies only to clock sync methods (these synchronize the demand interval to the meter's internal clock). Define what time of day you want to synchronize the demand, from the start of the day. For example, set this setting to 0730 to synchronize demand at 7:30 AM.

*Available in specific meter models. Refer to Features differentiation matrix for PM5500 / PM5600 / PM5700 series, page 20 for the availability.

6. Modify the parameter as required, then press **OK**.
7. Move the cursor to point to the next parameter you want to modify, press **Edit**, make your changes, then press **OK**.
8. Press **Yes** to save your changes.

Power and power factor

The sampled measurements taken at the meter's voltage and current inputs provide data for calculating power and power factor.

In a balanced 3-phase alternating current (AC) power system source, the AC voltage waveforms on the current-carrying conductors are equal but offset by one-third of a period (a phase angle shift of 120 degrees between the three voltage waveforms).

Current phase shift from voltage

Electrical current can lag, lead, or be in phase with the AC voltage waveform, and is typically associated with the type of load — inductive, capacitive or resistive.

For purely resistive loads, the current waveform is in phase with the voltage waveform. For capacitive loads, current leads voltage. For inductive loads, current lags voltage.

The following diagrams show how voltage and current waveforms shift based on load type under ideal (laboratory) conditions.

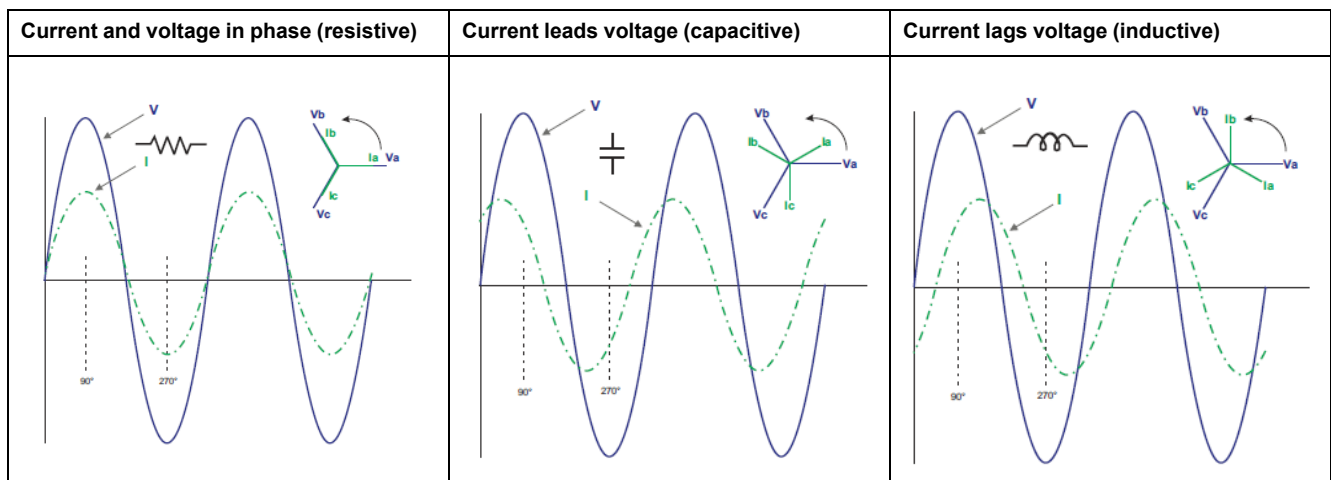

Real, reactive and apparent power (PQS)

A typical AC electrical system load has both resistive and reactive (inductive or capacitive) components.

Real power, also known as active power (P) is consumed by resistive loads. Reactive power (Q) is either consumed by inductive loads or generated by capacitive loads.

Apparent power (S) is the capacity of your measured power system to provide real and reactive power.

The units for power are watts (W or kW) for real power P, vars (VAR or kVAR) for reactive power Q, and volt-amps (VA or kVA) for apparent power S.

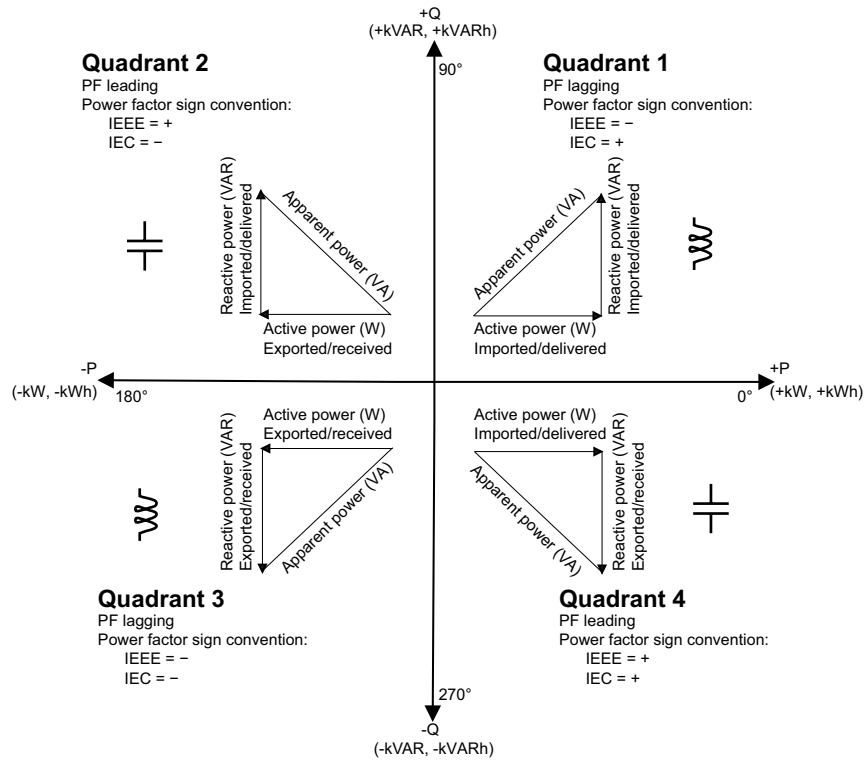

Power flow

Positive real power P(+) flows from the power source to the load. Negative real power P(-) flows from the load to the power source.

Power factor (PF)

Power factor (PF) is the ratio of real power (P) to apparent power (S).

PF is provided as a number between -1 and 1 or as a percentage from -100% to 100%, where the sign is determined by the convention.

$$PF = \frac{P}{S}$$

A purely resistive load has no reactive components, so its power factor is 1 (PF = 1, or unity power factor). Inductive or capacitive loads introduce a reactive power (Q) component to the circuit which causes the PF to become closer to zero.

True PF and displacement PF

The meter supports true power factor and displacement power factor values:

- True power factor includes harmonic content.
- Displacement power factor only considers the fundamental frequency.

NOTE: Unless specified, the power factor displayed by the meter is true power factor.

Power factor sign convention

Power factor sign (PF sign) can be positive or negative, and is defined by the conventions used by the IEEE or IEC standards.

You can set the power factor sign (PF sign) convention that is used on the display to either IEC or IEEE.

PF sign convention: IEC

PF sign correlates with the direction of real power (kW) flow.

- Quadrant 1 and 4: Positive real power (+kW), the PF sign is positive (+).
- Quadrant 2 and 3: Negative real power (-kW), the PF sign is negative (-).

PF sign convention: IEEE

PF sign is correlates with the PF lead/lag convention, in other words, the effective load type (inductive or capacitive):

- For a capacitive load (PF leading, quadrant 2 and 4), the PF sign is positive (+).
- For an inductive load (PF lagging, quadrant 1 and 3), the PF sign is negative (-).

Power factor register format

The meter provides power factor values in a variety of formats to suit your energy management software.

Power factor in IEC and lead/lag (IEEE) formats: Float32 and Int16U registers

The meter provides total power factor in IEC and lead/lag (IEEE) formats in both Float32 and Int16U data types. You can use these registers to bring power factor information into third-party software. These registers are interpreted using the standard IEC and IEEE sign conventions.

NOTE: For information on how to calculate actual power factor values from the values in Int16U registers, see your meter's Modbus register list, available from www.se.com.

Four quadrant power factor information: floating point registers

The meter also provides PF information (including sign and quadrant) in single floating point registers for each of the PF values (for example, per-phase and total values for true and displacement PF, and associated minimums and maximums). The meter performs a simple algorithm to the PF value then stores it in the appropriate PF register.

The meter and software (such as Power Monitoring Expert or ION Setup) interpret these PF registers for reporting or data entry fields according to the following diagram:

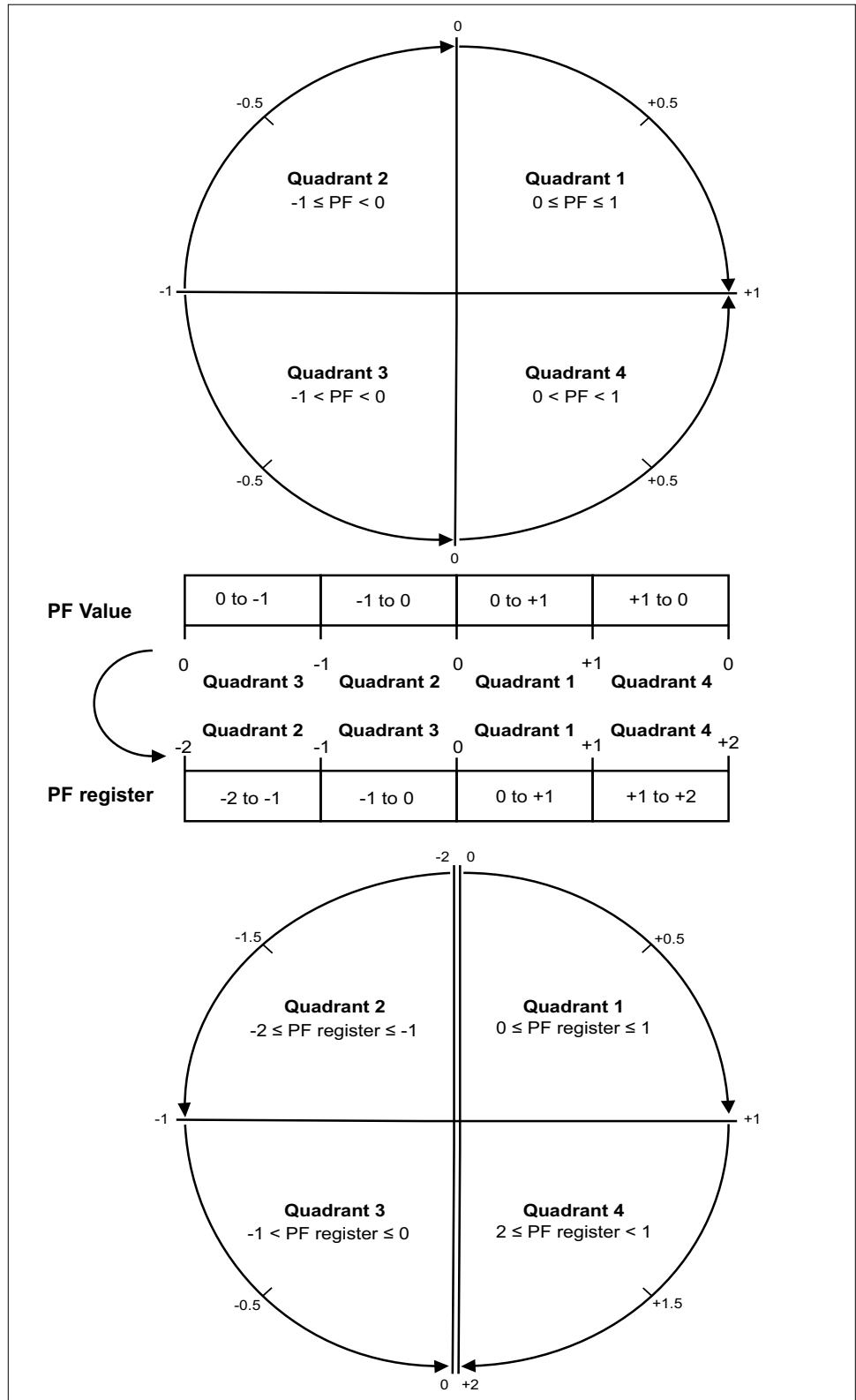

The PF value is calculated from the PF register value using the following formulas:

Quadrant	PF range	PF register range	PF formula
Quadrant 1	0 to +1	0 to +1	PF value = PF register value
Quadrant 2	-1 to 0	-2 to -1	PF value = (-2) - (PF register value)
Quadrant 3	0 to -1	-1 to 0	PF value = PF register value
Quadrant 4	+1 to 0	+1 to +2	PF value = (+2) - (PF register value)

Go to www.se.com and search for your meter's Modbus register list to download a copy.

Timers

The meter supports an I/O timer, active load timer and an operating timer.

Use the meter display to navigate to the Timer and I/O screens to view timer information.

Operating Timer

The operating timer (**Timer > Oper**) keeps track of how long the meter has been powered up.

Load Timer

The load timer keeps track of how much time the input current exceeds the specified load timer setpoint current.

I/O timer

The I/O timer shows how long an input or output has been ON.

Power quality

Power quality measurements

The meter provides complete harmonic distortion metering, recording and real-time reporting, up to the 63rd harmonic for all voltage and current inputs.

The following power quality measurements are available:

- Individual harmonics (odd harmonics up to 63rd)
- Total harmonic distortion (THD, thd) for current and voltage (line-to-line, line-to-neutral)
- Total demand distortion (TDD)
- K-factor, Crest factor
- Neutral current metering and ground current calculation

The following harmonics data is available on the display:

- Numeric magnitude and angle of the fundamental (first) harmonic.
- Graphical display of the 3rd to 31st harmonics, expressed as a percentage of the fundamental harmonic.

Harmonics overview

Harmonics are integer multiples of the fundamental frequency of the power system.

Harmonics information is valuable for power quality analysis, determining properly rated transformers, maintenance and troubleshooting. Evaluation of harmonics is required for compliance to system power quality standards such as EN50160 and meter power quality standards such as IEC 61000-4-30.

Harmonics measurements include per-phase magnitudes and angles (relative to the fundamental frequency of the phase A voltage) for the fundamental and higher order harmonics relative to the fundamental frequency. The meter's power system setting defines which phases are present and determines how line-to-line or line-to-neutral voltage harmonics and current harmonics are calculated.

Harmonics are used to identify whether the supplied system power meets required power quality standards, or if non-linear loads are affecting your power system. Power system harmonics can cause current flow on the neutral conductor, and damage to equipment such as increased heating in electric motors. Power conditioners or harmonic filters can be used to minimize unwanted harmonics.

Voltage crest factor

Crest factor is the ratio of peak to RMS voltage values.

For a pure sinusoidal waveform, crest factor is equal to 1.414. The meter uses the following equation to calculate crest factor:

$$C = \frac{V_{\text{peak}}}{V_{\text{RMS}}}$$

C = Crest factor

V_{peak} = Voltage peak

V_{RMS} = Voltage RMS

K-factor

K-factor relates the heating effect of a distorted current in a transformer to a sinusoidal current with the same RMS magnitude — it describes a transformer's ability to serve non-linear loads without exceeding rated temperature rise limits.

The K-factor is equal to the sum of the squares of the harmonic currents multiplied by the squares of the harmonic order. The meter uses the following equation to calculate K-factor:

$$K = \frac{\sum_{n=1}^h (I_n^2 \times h^2)}{\sum_{n=1}^h I_n^2}$$

Where K is the K-factor, h is the harmonic order and I_h is the true RMS current of harmonic order h .

Total harmonic distortion %

Total harmonic distortion (THD%) is a measure of the total per-phase voltage or current harmonic distortion present in the power system.

THD% provides a general indication of the quality of a waveform. THD% is calculated for each phase of both voltage and current.

Total demand distortion

Total demand distortion (TDD) is the per-phase harmonic current distortion against the full load demand of the electrical system.

TDD indicates the impact of harmonic distortion in the system. For example, if your system is showing high THD values but a low demand, the impact of harmonic distortion on your system might be insignificant. However at full load, the THD value for the current harmonics is equal to TDD, so this could negatively impact your system.

Harmonic content calculations

Harmonic content (H_C) is equal to the RMS value of all the non-fundamental harmonic components in one phase of the power system.

The meter uses the following equation to calculate H_C :

$$H_C = \sqrt{(H_2)^2 + (H_3)^2 + (H_4)^2 \dots}$$

THD% calculations

THD% is a quick measure of the total distortion present in a waveform and is the ratio of harmonic content (H_C) to the fundamental harmonic (H_1).

By default, the meter uses the following equation to calculate THD%:

$$THD = \frac{H_C}{H_1} \times 100\%$$

thd calculations

thd is an alternate method for calculating total harmonic distortion that uses the RMS value for the total harmonic content rather than the fundamental content.

The meter uses the following equation to calculate thd:

$$\text{thd} = \frac{\text{HC}}{\sqrt{(\text{H1})^2 + (\text{HC})^2}} \times 100$$

TDD calculations

TDD (total demand distortion) evaluates the harmonic currents between an end user and a power source.

The harmonic values are based on a point of common coupling (PCC), which is a common point where each user receives power from the power source.

The meter uses the following equation to calculate TDD:

$$\text{TDD} = (\sqrt{(\text{HCIA})^2 + (\text{HCIB})^2 + (\text{HCIC})^2}) / (\text{ILoad}) \times 100$$

Where I_{Load} is equal to the maximum demand load on the power system.

Viewing harmonics using the display

You can view harmonics data using the display.

1. Navigate to **Harm**.

The **Harmonics %** screen displays:

2. Press the voltage or current harmonics you want to view.

IEEE mode	IEC mode	Description
V L-L	U	Line-to-line voltage harmonics data
V L-N	V	Line-to-neutral voltage harmonics data
Amps	I	Current harmonics data
TDD/K	TDD/K	Total demand distortion and K-factor data
Crest	Crest	Crest factor data

The fundamental (1st) harmonics numeric magnitudes and angles for all phases are displayed.

- Press **3-11**, **13-21**, or **21-31** to view the graphs for the 3rd to the 11th, 13th to 21st, or 23rd to 31st harmonics, respectively.

For example, to display the 13th to 21st harmonics screen, press **13-21**.

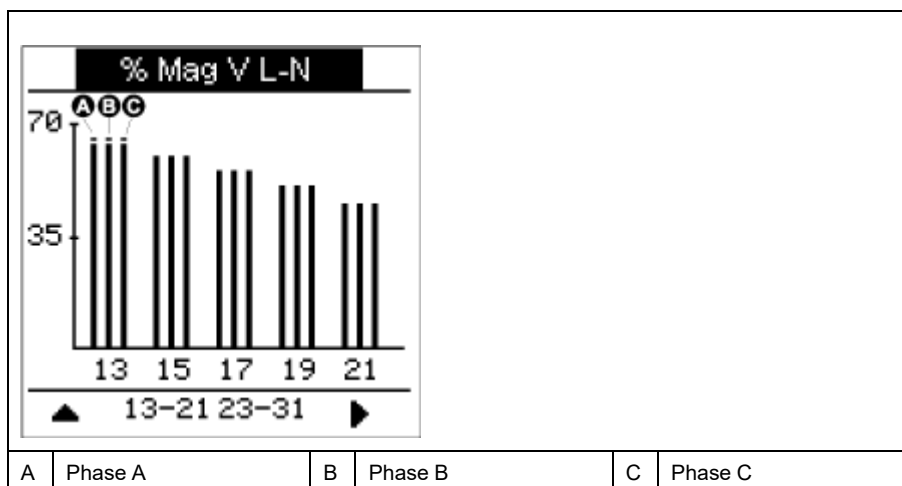

The vertical axis of the harmonics graph indicates the harmonic’s magnitude as a percentage of the fundamental harmonic, and is scaled based on the largest harmonic displayed. At the top of each vertical bar is a marker that shows the maximum value of the harmonic. If the harmonic is greater than the fundamental harmonic, this marker is triangular-shaped to show that the value is out of range.

NOTE: The display screen only shows odd harmonics up to the 31st harmonic. However, all individual odd and even harmonics data up to the 63rd harmonic is available through communications and software. Individual harmonics data include current harmonics per phase, neutral and ground, and voltage harmonics line-to-line, line-to-neutral and neutral to ground.

Viewing TDD, K-factor and Crest factor data

The meter display provides screens that show TDD, K-factor and Crest factor values.

NOTE: Your meter’s Modbus map includes registers for harmonics data for integration into your power or energy management system.

- Navigate to **Harm > TDD/K**.

The TDD and K-factor per phase information displays.

Value	Description
TDD	Total demand distortion
K-F A	K factor for phase A
K-F B	K factor for phase B
K-F C	K factor for phase C

- Navigate to **Harm > Crest**.

The Crest factor information displays.

IEEE mode	IEC mode	Description
V L-L	U	Crest factor data for line-to-line voltage
V L-N	V	Crest factor data for line-to-neutral voltage
Amps	I	Crest factor data for current

3. Press the up arrow to return to the main display screens.

Viewing THD/thd using the display

You can view THD/thd data using the display.

NOTE: Your meter's Modbus map includes registers for total harmonic distortion data for integration into your power or energy management system.

1. Navigate to **THD** to view the **THD/thd Select** screen.
2. Press **THD** to display values that use the calculation method based on the fundamental harmonic or **thd** to display values that use the calculation method based on the RMS value of all harmonics in that phase (including the fundamental).

IEEE mode	IEC mode	Description
Amps	I	Total harmonic distortion data for per phase and neutral currents.
V L-L	U	Total harmonic distortion data line-to-line voltage.
V L-N	V	Total harmonic distortion data line-to-neutral voltage.

3. Press the current or voltage THD or thd values you want to view.
The total harmonic distortion percentage values are displayed.
4. Press the up arrow to return to the main display screens.

Waveform capture

Overview of waveform capture

Applicable only in PM5650 / PM5760 / PM5761 meter models.

Your meter is able to record voltage and current waveform information.

Waveform capture information is used to help identify power system disturbances, which are an increasing concern for industrial plants, hospitals, data centers and other facilities where the equipment is sensitive to voltage sags and swells.

In addition to measuring and recording numerical values for voltage and current, your meter can also capture the sinusoidal waveform data. The current and voltage waveform capture data provides additional information for analysis of the system's power quality event.

You can manually trigger waveform capture or configure them to trigger automatically when there is a power quality event. For waveform capture to trigger automatically, you must enter your system's nominal (normal) voltage values, and then the amount of deviation from the nominal required to trigger waveform capture.

Waveform capture data storage format

The waveform capture records are stored in the form of COMTRADE files.

The meter can store up to 10 COMTRADE files in its internal FTP / FTPS server.

Default waveform capture configuration

Your meter's waveform capture of sag/swell events is functional once the nominal values are configured through ION Setup or any tool using the Modbus commands specified in the register list of PM5xxx model.

Your meter has the following default waveform capture events:

Waveform capture events	Description
V1-Sg/Sw	Captures V1, V2, V3 and I1, I2, I3 waveforms during a defined voltage sag or swell event
V2-Sg/Sw	
V3-Sg/Sw	

NOTE: The minimum duration between two sag/swell events to record is 3 s.

COMTRADE

COMTRADE stands for COMMon format for TRAnsient Data Exchange defined by IEC 60255-24, and defines a common format for power quality event (disturbance) data in order to simplify retrieval, analysis and exchange of disturbance data between multiple sources and vendors.

COMTRADE is configured as part of the default waveform framework. COMTRADE records are generated for waveform records triggered by power quality events or manually.

COMTRADE files can be accessed from the meter's internal FTP / FTPS server or through Modbus TCP (not available on serial), and is composed of two files:

File name extension	Description
.cfg	Configuration of event data
.dat	Event data records per .cfg file <ul style="list-style-type: none"> Data samples of events Time stamped digital samples Number of entries (depends on sampling rate and sample duration)

By default:

- The meter is configured to generate COMTRADE records for any sag/swell event.
- The oldest COMTRADE record is overwritten by the newest record when the COMTRADE limit of 10 files is exceeded.

NOTE: COMTRADE files can only be downloaded using an Ethernet connection. They cannot be downloaded using serial, modem or Ethernet gateway connections.

See the *COMTRADE and ION technology* technical note, available from www.se.com, for detailed information about COMTRADE file formats.

Configuring waveform capture using ION Setup

You can configure your meter to capture waveforms when it experiences a sag or swell event or a manual trigger without any events, and to export the waveform data to COMTRADE files.

NOTE: See your meter's Modbus register list at www.se.com for the Modbus mapping information and basic instructions on command interface.

- Start ION Setup and connect to your meter.
- Open the **Waveform Configuration** screen in the **Power Quality** folder.

3. Click **Edit** to configure the **Setup** parameters as required.
4. Click **Send** to save your changes to the meter.

Waveform capture parameters available using the ION Setup

Parameter	Values	Description
Status	Enable Disable	Enables or disables waveform capture on your meter
Samples per Cycle	Samples per cycle: <ul style="list-style-type: none"> • 128 samples/cycle • 64 samples/cycle • 32 samples/cycle • 16 samples/cycle Pre/Post allocation: <ul style="list-style-type: none"> • Pre-cycles: Number of cycles that will be captured in waveforms prior to waveform trigger • Post-cycles : Number of cycles that will be captured in waveforms post waveform trigger 	Select the Samples per cycle based on the requirement <ul style="list-style-type: none"> • Maximum 8 cycles for 128 samples/cycle • Maximum 16 cycles for 64 samples/cycle • Maximum 32 cycles for 32 samples/cycle • Maximum 64 cycles for 16 samples/cycle The Pre-cycles can be configured based on the Samples per cycle <ul style="list-style-type: none"> • 1 – 8 (for 128 samples/cycle, sum of pre and post cycles must be 8) • 1 – 16 (for 64 samples/cycle, sum of pre and post cycles must be 16) • 1 – 32 (for 32 samples/cycle, sum of pre and post cycles must be 32) • 1 – 64 (for 16 samples/cycle, sum of pre and post cycles must be 64) The Post-cycles will be automatically configured based on the Pre-cycles NOTE: It is recommended for the end user to configure equal number of pre and post cycles to visualize sag/swell events in waveform.
Mode	Circular	Select Circular

Configuring waveform capture using the display

You can use the display to configure the waveform capture.

1. Navigate to **Maint > Setup**.
2. Enter the setup passcode (default is “0”), then press **OK**.
3. Navigate to **WFC**.
4. Move the cursor to point to the parameter you want to modify, then press **Edit**.
5. Modify the parameters as required, then press **OK**.

6. Press the up arrow to exit. Press **Yes** to save your changes.

Waveform capture setup parameters available using the display

Parameter	Values	Description
Enable	Yes, No	Enables or disables the waveform capture on your meter
Samples Per Cycle	128 64 32 16	Select the samples per cycle based on the requirement
Pre Cycles	The pre cycles can be configured based on the samples per cycle <ul style="list-style-type: none"> • Maximum 1 – 8 pre cycles for 128 samples per cycle • Maximum 1 – 16 pre cycles for 64 samples per cycle • Maximum 1 – 32 pre cycles for 32 samples per cycle • Maximum 1 – 64 pre cycles for 16 samples per cycle 	Select the pre cycles based on the requirement The Post-cycles will be automatically configured based on the Pre-cycles NOTE: It is recommended for the end user to configure equal number of pre and post cycles to visualize sag/swell events in waveform. <ul style="list-style-type: none"> • Pre-cycles: Number of cycles that will be captured in waveforms prior to waveform trigger • Post-cycles : Number of cycles that will be captured in waveforms post waveform trigger

Configuring sag/swell using ION Setup

You can configure your meter to monitor sag/swell data as a trigger to capture waveforms, and to export the waveform data to COMTRADE files.

NOTE: For waveform recording to trigger automatically, enter your system’s nominal (normal) voltage values and the amount of deviation from the nominal that is considered a sag or a swell using the **Power Quality** screen.

1. Start ION Setup and connect to your meter.
2. Open the **Voltage Sag/Swell** screen in the **Power Quality** folder.
3. Click **Edit** to configure the **Setup** parameters as required.
4. Click **Send** to save your changes to the meter.

Voltage sag/swell parameters available using the ION Setup

Parameter	Values	Description
PQ Voltage Level	100 – 1000000	Set the voltage level to the required value NOTE: The user must configure the nominal voltage L-L for 3PH3W or L-N for other power system configurations.
Sag Limit %	1 – 99	Set the sag limit values NOTE: Sag limit + hysteresis must be ≤100
Swell Limit %	101 – 199	Set the swell limit values NOTE: Swell limit - hysteresis must be ≥100
Hysteresis %	1 – 100	Set the hysteresis value The hysteresis is the difference in magnitude between the start and end thresholds for sag/swell. For example, a hysteresis of 5% means that a sag with a threshold of 90% needs to reach 95% before the sag is over and a swell with a limit of 110% needs to reach 105% before the swell is over.

Configuring sag/swell using the display

You can use the display to configure sag/swell data as a trigger to capture waveforms.

1. Navigate to **Maint > Setup**.
2. Enter the setup passcode (default is "0"), then press **OK**.
3. Navigate to **Dist**.
4. Move the cursor to point to the parameter you want to modify, then press **Edit**.
5. Modify the parameters as required, then press **OK**.
6. Press the up arrow to exit. Press **Yes** to save your changes.

Sag and swell setup parameters available using the display

Parameter	Values	Description
Sag Limit	1 – 99	Set the sag limit values in % NOTE: Sag limit + hysteresis must be ≤ 100
Swell Limit	101 – 199	Set the swell limit values in % NOTE: Swell limit - hysteresis must be ≥ 100
Hysteresis	1 – 100	Set the hysteresis value The hysteresis is the difference in magnitude between the start and end thresholds for sag/swell. For example, a hysteresis of 5% means that a sag with a threshold of 90% needs to reach 95% before the sag is over and a swell with a limit of 110% needs to reach 105% before the swell is over.
PQ Voltage Level	100 – 1000000	Set the system nominal voltage level NOTE: The user must configure the nominal voltage L-L for 3PH3W or L-N for other power system configurations.

Monitoring waveform capture on meter's webpages

NOTE: Refer to Restoration of temporarily disabled configuration settings in webpages, page 235 to know availability of these features on your meter model.

Before you can view waveforms on the meter's webpages, you need to perform some basic configuration using ION Setup to enable waveform capture and store the waveforms in COMTRADE format.

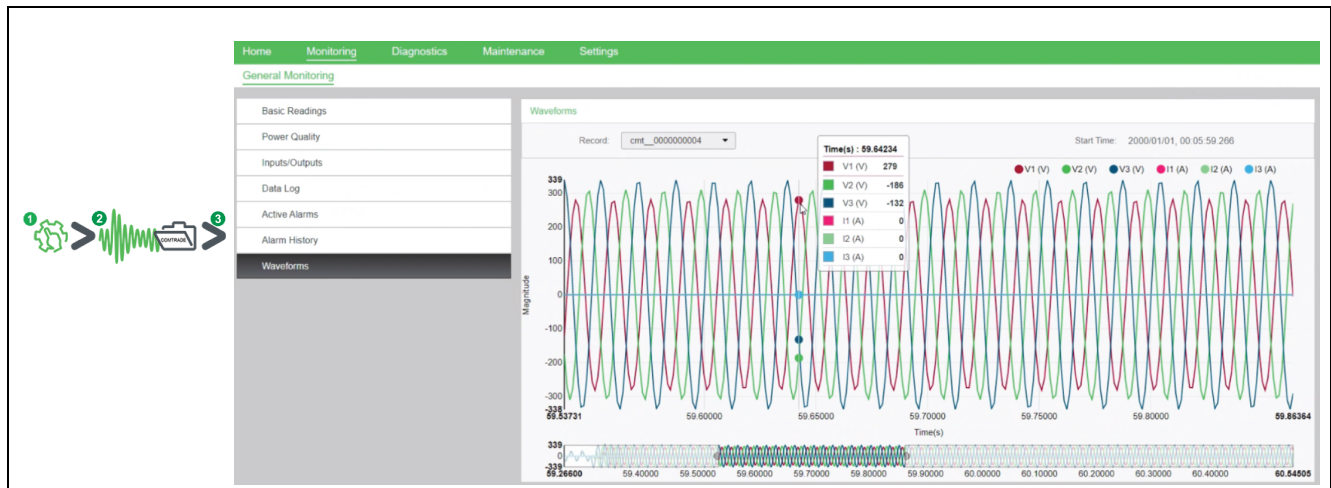

Manual trigger

1. Enable waveform capture on your meter

Set the status to **Enable** using ION Setup.

2. A waveform is captured when it is manually triggered using Modbus command or ION Setup

A COMTRADE record is generated and saved to your meter's FTP / FTPS site.

3. View the waveform on the meter's webpages

Login to the meter webpages.

Based on your meter firmware version, click **Monitoring > General Monitoring > Waveforms** to explore the waveform data.

Automatic trigger

1. Enable waveform capture on your meter

Set the meter's nominal voltage and sag/swell parameters using ION Setup.

2. A waveform is captured when a power quality event occurs

A COMTRADE record is generated and saved to your meter's FTP / FTPS site.

3. View the waveform on the meter's webpages

Login to the meter webpages.

Based on your meter firmware version, click **Monitoring > General Monitoring > Waveforms** to explore the waveform data.

Viewing waveform capture on meter's webpages

After COMTRADE files are generated by your meter, you can view them using the webpages.

1. Select the file you want to view from the record dropdown on meter's webpages.

Screenshot of the waveform capture on webpages



- A. Select the COMTRADE waveform to view
- B. Show / hide parameters
- C. View details
- D. Zoom in / out

2. Click or tap an individual voltage or current channel in the legend to show or hide it in the waveform viewer.
 - Visible
 - Hidden
3. Use the bar at the bottom to zoom in / zoom out on a particular section of the waveform, or to scan through the waveform with the selected zoom level.



- Draw a window over a particular area to zoom in on that section of the waveform.
 - Drag the selected area to move the zoom across the waveform.
 - Drag the start and end points to expand or narrow the zoom.
4. Hover over or tap a spot on the waveform to view the values associated with that particular moment in time.

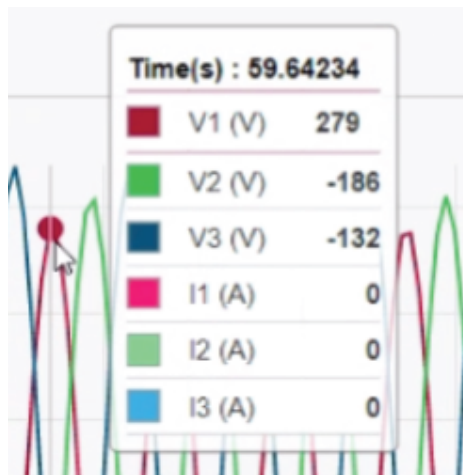

Maintenance

Maintenance overview

The meter does not contain any user-serviceable parts. If the meter requires service, contact your local Schneider Electric Technical Support representative.

NOTICE

METER DAMAGE

- Do not open the meter case.
- Do not attempt to repair any components of the meter.

Failure to follow these instructions can result in equipment damage.

Do not open the meter. Opening the meter voids the warranty.

Lost user access

If you lose your meter's user access (passcode) information, contact your local Schneider Electric representative for instructions on how to return your meter for factory reconfiguration.

NOTE: Have your meter's serial number available for reference.

Diagnostics information

The meter provides you with diagnostics information to help with troubleshooting.

Navigate to **Maint > Diag > Info** to view the meter model, serial number, date of manufacture, firmware version (including OS - Operating System and RS - Reset System), language version, and OS CRC (Cyclic Redundancy Check). The OS CRC value is a number (Hexadecimal format) that identifies the uniqueness between different OS firmware versions.

Navigate to **Maint > Diag > Meter** to view details of the meter status.

Navigate to **Maint > Diag > CI Pwr** to view the control power information.

- **Non-MID/MIR meter models:** The **CI Pwr** screen displays how many times the meter lost control power, and the date and time of its last occurrence.
- **MID/MIR meter models:** The **CI Pwr** screen displays the **Number of Losses**, the **Last Power Up** and the **Last Power Down** events with the timestamp.

Navigate to **Maint > Diag > Phasor** to view the graphical representation of the power system the meter is monitoring.

Navigate to **Maint > Diag > Phasor > Polar** to view the numeric magnitude and angles of all voltage and current phases.

You can access the meter's maintenance log using the webpages.

Control power (auxiliary power) interruption event

For MID/MIR compliant models.

When the meter is in OFF state and control power supply is applied OR when the meter is in ON state and the control power is cycled:

- If the 4-digit MID/MIR / **Revenue Lock** is enabled, an icon  which indicates the control power loss blinks on the top right corner of the screen.
- When the meter is in ON state and the control power goes below the operating range, the meter logs the **Last Power Down** event with timestamp before power-off.
- When the meter is in OFF state and the control power is applied, the meter logs the **Last Power Up** event with timestamp after power-on.
- When there are multiple events along with control power interruption event, then the control power interruption event icon blinks taking precedence over all other icons.

NOTE: The meter displays only the **Number of Losses**, the **Last Power Down** and **Last Power Up** events. The last 20 control power interruption event logs (10 **Power Down** and 10 **Power Up** events) can be read only through communication.

Acknowledging control power (auxiliary power) interruption event using the display

For MID/MIR compliance on applicable models.

NOTE: When the control power interruption event icon displays on the meter, the facility manager must assess the reason and its duration.

Use the **CI Pwr** screen to acknowledge the control power interruption event.

You can acknowledge (dismiss) the control power interruption event only after entering the 4-digit MID/MIR / **Revenue Lock** password.

NOTE:

- You cannot acknowledge the alarms and the control power interruption events at the same time.
- The control power interruption event icon  blinks until you acknowledge the **Number of Losses**, the **Last Power Up** and **Last Power Down** events.

1. Navigate to **Maint > Diag > CI Pwr**.

The **Number of Losses**, the **Last Power Up** and **Last Power Down** events with the timestamp are displayed on the same page.

2. Press **Ack**.

3. Enter the **Revenue Lock** password, then press **OK**.

NOTE: The default password is **0000**.

4. Read the **Attention!** message on the display and press **Yes** to acknowledge or press **No** to go back to previous screen.

The **Ack** and control power interruption event icon  disappears only when you press **Yes**.

NOTE: You can reset the **Number of Losses** to **0** only through the Modbus communication. To perform this reset, you need to disable the 4-digit MID/MIR / **Revenue Lock** password in the meter HMI.

Wrench icon

The wrench icon appears on the top left corner of the display screen.

The wrench icon  alerts you when there is an overvoltage condition or a potential hardware or firmware problem in the meter that requires attention. It could also indicate that the energy pulsing LED is in an overrun state.

Navigate to **Maint > Diag > Meter** to view details of the meter status. Make note of the information shown on the screen, then contact Technical Support.

LED indicators

Abnormal heartbeat / serial communications LED behavior could mean potential problems with the meter.

Problem	Probable causes	Possible solutions
LED flash rate does not change when data is sent from the host computer.	Communications wiring	If using a serial-to-RS-485 converter, trace and check that all wiring from the computer to the meter is properly terminated.
	Internal hardware problem	Perform a hard reset: turn off control power to the meter, then re-apply power. If the problem persists, contact Technical Support.
Heartbeat / serial communications LED remains lit and does not flash ON and OFF	Internal hardware problem	Perform a hard reset: turn off control power to the meter, then re-apply power. If the problem persists, contact Technical Support.
Heartbeat / serial communications LED flashes, but the display is blank.	Display setup parameters incorrectly set	Review display parameter setup.

If the problem is not fixed after troubleshooting, contact Technical Support for help. Make sure you have your meter's firmware version, model and serial number information available.

Phasors

Phasors are used to represent the voltage and current relative magnitude and angles.

The length of the lines in the phasor diagram represent the relative magnitude of the voltages with respect to the other phase voltages, and the currents with respect to the other phase currents. All angles are measured with respect to the V_a/V_1 phase. The V_a/V_1 phasor is fixed to the right-hand horizontal axis (positive x-axis). Positive angles are measured counterclockwise.

Numeric values are provided for the magnitude and relative angle for each voltage and current phase.

Phasor information can be used to troubleshoot incorrect connections on the meter's voltage and current inputs (for example, switched phase wiring or polarity errors), if you know how the phasors should be oriented for your power system.

Phasor screens

Phasor information is available on the meter's display.

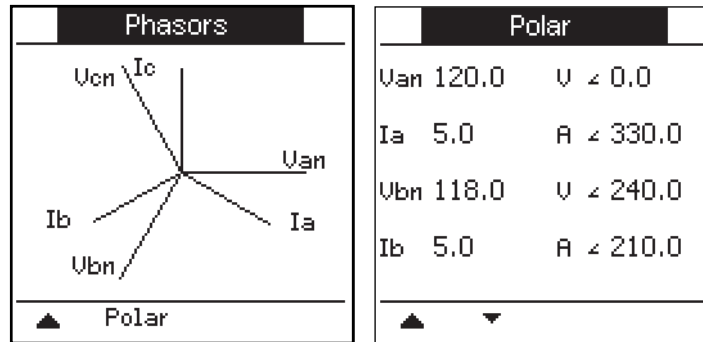

The graph on the Phasors screen shows a representation of the phase angles in degrees. The Polar screen shows the RMS value and phase angle of each voltage and current phases.

NOTE: If two phasor lines overlap (i.e. if they have the same relative phase angle), only one phase label is visible as phasor diagram labels are overwritten dynamically on the display panel.

Meter memory

The meter stores configuration and logging information in non-volatile memory and a long-life memory chip.

The meter uses its non-volatile memory (NVRAM) to retain all data and metering configuration values. Under the operating temperature range specified for the meter, the NVRAM has an anticipated life of 45 years or longer. The meter stores its data logs in a memory chip, which has a life expectancy of up to 20 years under the operating temperature range specified for the meter.

Meter battery

The internal battery in the meter keeps the meter's clock running when it is powered down to help maintain the meter time.

The life expectancy of the meter's internal battery is estimated to be over 10 years at 25 °C under typical operating conditions.

Firmware version, model and serial number

You can view the meter model, serial number, date of manufacture, firmware version (including OS - Operating System and RS - Reset System), language version, and OS CRC (Cyclic Redundancy Check) from the display panel or through the meter webpages.

- Using the display panel: Navigate to **Maint > Diag > Info**.
- Using the meter webpages: Based on your meter firmware version, click **Diagnostics > Meter Information** OR click **Home > Device Identification**.

NOTE: The OS CRC value is a number that identifies the uniqueness between different OS firmware versions.

Firmware upgrades

Upgrade your meter's firmware for the following reasons:

- Improve meter performance (e.g., optimize processing speed)
- Enhance existing meter features and functions
- Add new functionality to the meter
- Achieve compliance to new industry standards
- Enhance meter Cybersecurity

NOTE: Based on your meter model and firmware version, refer to the appropriate sections of this chapter for the firmware upgrade procedure as shown in table below:

Meter models, firmware versions and firmware upgrade methods

Meter models	Source firmware version	Target firmware version	Firmware upgrade method via
PM5560 / PM5562 / PM5563 / PM5580	2.X.Y	2.9.9 and earlier	FTP server (Refer Firmware upgrade using FTP server, page 210)
	2.5.X to 2.9.9	4.0.X and above	Firmware upgrade tool (Refer Firmware upgrade using firmware upgrade tool, page 212) NOTE: If the meters are upgraded to their target firmware version, you cannot go back (downgrade) to their source firmware version.
	4.0.X and above	4.X.Y and above	Webpages (Refer Firmware upgrade using webpages, page 214)
PM5570 / PM5660 / PM5760	3.1.X	3.2.9 and earlier	FTP server (Refer Firmware upgrade using FTP server, page 210)
	3.2.9 and earlier	6.0.X and above	Firmware upgrade not supported. Contact Schneider Electric Technical Support for help.
	6.0.X and above	6.X.Y and above	Webpages (Refer Firmware upgrade using webpages, page 214)
PM5650	2.11.X	2.12.9 and earlier	FTP server (Refer Firmware upgrade using FTP server, page 210)
	2.12.9 and earlier	4.10.X and above	Firmware upgrade tool (Refer Firmware upgrade using firmware upgrade tool, page 212) NOTE: If the meters are upgraded to their target firmware version, you cannot go back (downgrade) to their source firmware version.
	4.10.X and above	4.10.Y and above	Webpages (Refer Firmware upgrade using webpages, page 214)
PM5561	10.6.X	10.9.9 and earlier	FTP server (Refer Firmware upgrade using FTP server, page 210)
	10.9.9 and earlier	12.0.X and above	Firmware upgrade tool (Refer Firmware upgrade using firmware upgrade tool, page 212) NOTE: If the meters are upgraded to their target firmware version, you cannot go back (downgrade) to their source firmware version.
	12.0.X and above	12.X.Y and above	Webpages (Refer Firmware upgrade using webpages, page 214)
PM5661 / PM5761	11.0.X	11.2.9 and earlier	FTP server (Refer Firmware upgrade using FTP server, page 210)
	11.2.9 and earlier	14.0.X and above	Firmware upgrade not supported. Contact Schneider Electric Technical Support for help.
	14.0.X and above	14.X.Y and above	Webpages (Refer Firmware upgrade using webpages, page 214)
PM5570L / PM5660L / PM5760L	6.0.X and above	6.X.Y and above	Webpages (Refer Firmware upgrade using webpages, page 214)

Firmware upgrade methods

Meter upgrade requirements for FTP server

NOTE: To know the applicable firmware upgrade method for your meter model with firmware version, refer to table Meter models, firmware versions and firmware upgrade methods, page 209.

NOTE: Refer to Restoration of temporarily disabled configuration settings in webpages, page 235 to know availability of these features on your meter model.

There are some requirements to consider before you upgrade your meter's firmware.

In order to upgrade the meter, you need to:

- Be connected to the meter using Ethernet.
 - NOTE:** It is recommended that you change the IP Address Acquisition Mode to Stored during the firmware upgrade. If the mode is set to DHCP, the IP address might change during the upgrade, which will result in a loss of communications with the meter.
- Make sure the meter's FTP server is enabled.
- Have Product Master credentials to login to the meter's FTP server. The FTP server uses the same user accounts as the meter's webpages.
- Download the latest upgrade files from www.se.com. The upgrade files include:
 - App2.out: this file contains the files needed to upgrade the code and initialization files that run the Ethernet communications.
 - PM5xxx_vX.Y.Z.fwa (where xxx is your meter model and X.Y.Z is the specific firmware version): this file contains all the files needed to upgrade other meter components, such as the meter's operating system, language files and webpages.
 - PM5500StartUpgrade.shtml

Save these files to a location you can access from the computer you use to perform the upgrade.

NOTE: After you use the FTP meter upgrade process, you can no longer use DLF3000 software to upgrade the meter.

NOTE: The PM5561 meter model running on firmware version 10.6.3 or later and PM5661 / PM5761 meter models running on firmware version 11.0.X or later can be upgraded to a compatible higher firmware version. The firmware upgrade (successful or unsuccessful) is limited to 10 attempts in PM5561 / PM5661 / PM5761. Any further attempt to upgrade is blocked.

Firmware upgrade using FTP server

NOTE: To know the applicable firmware upgrade method for your meter model with firmware version, refer to table Meter models, firmware versions and firmware upgrade methods, page 209.

NOTE: Refer to Restoration of temporarily disabled configuration settings in webpages, page 235 to know availability of these features on your meter model.

NOTE: The firmware upgrade process for PM5561 / PM5661 / PM5761 meter models cannot be performed when MID/MIR lock is enabled. You need to remove the MID/MIR lock using the meter display (Refer to Locking or unlocking the PM5561 / PM5661 / PM5761, page 225) to perform the firmware upgrade process.

You can upgrade the meter's firmware, language files, webpages and Ethernet communications card using the meter's internal FTP server.

Your meter, Ethernet card and accessories do not operate normally during firmware upgrade, and your meter's digital outputs may change state during a firmware upgrade.

▲ WARNING

UNINTENDED OPERATION OR METER DAMAGE

- Do not use this device for critical control or protection applications where human or equipment safety relies on the operation of the control circuit.
- Do not turn off power to the meter while the firmware upgrade is in progress.

Failure to follow these instructions can result in death, serious injury, or equipment damage.

This example walks through upgrading your meter using Windows Explorer to access the meter's FTP server. You can also use other FTP clients, such as FileZilla.

1. Open Windows Explorer and connect to your meter by entering `ftp:\\<meter IP address>` replacing `<meter IP address>` with the IP address of the meter you want to upgrade.
2. Enter a Product Master **Username** and **Password** when prompted.
The FTP server appears, containing the folders `fw` and `www`.
3. Open another instance of Windows Explorer and navigate to the location where you saved the firmware upgrade files.
4. Copy the `PM5500StartUpgrade.shtml` file and paste it into the `www` folder on the meter's FTP server.
5. Copy the `App2.out` and `PM5xxx_vX.Y.Z.fwa` files and paste them into the `fw` folder on the meter's FTP server.

NOTE: If a file with the same name already exists on the meter, you are prompted to confirm whether or not you want to replace that file. Click **Yes** (to replace that one file) or **Yes to All** (to replace all files).

NOTE: If you have added a large number of custom files (such as webpages) to the meter's FTP server, there may not be enough memory on the meter's Ethernet communications card to paste the files, and you may receive an error when you try to paste the files. You may need to temporarily move some of these custom files before proceeding.

6. Exit Windows Explorer after the file copying is complete.
7. Open your browser and enter `http://<meter IP address>/PM5500StartUpgrade.shtml` to trigger the upgrade, where `<meter IP address>` is replaced with your meter's IP address.

Enter your login credentials when prompted.

NOTE: Accessing this webpage restarts the meter's Ethernet communications card, which initiates the upgrade process. It might take a minute or two while the meter's Ethernet communications card is reset and the upgrade initialized.

From the `PM5500StartUpgrade.shtml` page, you are redirected to a firmware upgrade status page where you can view information about the upgrade process.

NOTE: If the status page indicates that one of the upgrade processes failed, restart the upgrade process from the beginning by reconnecting to the meter's FTP server, recopying the files then following the rest of the procedure.

Meter upgrade requirements for firmware upgrade tool

NOTE: To know the applicable firmware upgrade method for your meter model with firmware version, refer to table Meter models, firmware versions and firmware upgrade methods, page 209.

Following pre-requisites are required for firmware upgrade:

- Latest compatible firmware upgrade package (Download the latest firmware upgrade package from www.se.com).
- Latest firmware upgrade tool which is included in firmware upgrade package.

▲ CAUTION
POTENTIAL FOR PRODUCT DAMAGE AND IRRECOVERABLE
Always use the firmware upgrade tool version which is available with the compatible firmware upgrade package.
Failure to follow these instructions may result in product being damaged and irrecoverable.

- PC with Windows 10 and above operating system connected to meter via Ethernet cable.
- Uninterrupted power supply to the control power input of the meter, with stable Ethernet communication.
- Meters configured with STATIC IP under **Stored** method.
- ION Setup configuration tool.

Firmware upgrade using firmware upgrade tool

NOTE: To know the applicable firmware upgrade method for your meter model with firmware version, refer to table Meter models, firmware versions and firmware upgrade methods, page 209.

NOTE: The firmware upgrade process for PM5561 meter models cannot be performed when MID/MIR lock is enabled. You need to remove the MID/MIR lock using the meter display (Refer to Locking or unlocking the PM5561 / PM5661 / PM5761, page 225) to perform the firmware upgrade process.

NOTE: For this firmware upgrade method to be successful, do not change the file names.

▲ CAUTION
POTENTIAL FOR PRODUCT DAMAGE AND IRRECOVERABLE
Do not disrupt the auxiliary control power when the firmware upgrade is in progress.
Failure to follow these instructions may result in product being damaged and irrecoverable.

If the meter is connected to network and configured with STATIC IP address, proceed to [Step 2, page 212](#).

If the meter is connected to network and configured in DHCP mode:

- Disconnect the meter from the network.
 - Switch the IP method to **Stored**.
1. Configure the meter HTTP port number to 80 using the webpage (**Settings > Advanced Ethernet Settings**) or through ION Setup.
 2. Connect the PC directly to the meter and check that the IP domain of the PC is set to same as meter, and that the meter is communicating with the PC (for example, by running a ping test).

3. Open the **Config.csv** file which is part of the firmware upgrade tool package.
4. Modify the **Config.csv** file in **Notepad** and enter the meter's configuration in below order without the <> brackets and without any spaces around the commas:

<IP Address>,<Modbus Slave ID>,<Web-master username>,<Web-master password>,<Product-Master username>,<Product-Master password>

NOTE: Before saving the Config.csv file, ensure that the file contains only one line text, and the last character of this line is the Product-Master password without space, dot, comma etc.

Example: 192.168.0.10,255,user1,pass1,user2,pass2

5. Save and close the **.csv** file
6. Double click the **PM5000fwupgrade.exe** to open the firmware upgrade tool.

7. Select **File > Open** OR click the  icon.
8. Browse and select the updated **Config.csv** file. The tool displays the details entered in **config.csv** file. Proceed to next step if the details mentioned as follows match:
 - IP Address (modified in the **.csv** file)
 - Current firmware version of the meter
 - Product name
 - Status (Example: **Firmware upgrade applicable**)

NOTE: If the firmware upgrade tool displays status message other than **Firmware upgrade applicable**, recheck the connection, meter, and the details provided in **config.csv** file.

9. Select **Tools > Select Firmware** OR click the  icon.

10. Click  to browse and select the latest firmware file (**.sedp**). Selected firmware file (VX.Y.Z.**sedp**) details will be displayed.

11. Select **Tools > Upload Firmware** OR click the  icon.
12. A warning message displays. Make sure that you read and understand the message. Select **Yes** to proceed or **No** to cancel upgrade process.

The firmware upgrade process starts. Depending on several factors like network speed etc., the firmware upgrade process of the meter can take about 10 minutes or more.

After the firmware upgrade process is completed, the status message displays **Device upgrade success**.
13. Login to the webpage with the user credentials to find the latest upgraded firmware version in the **Home** tab under the **Device Identification** window.
14. If the error message **Device upgrade failed** is displayed during the firmware upgrade process:
 - a. Delete the downloaded copy of the latest firmware upgrade package from the PC. Download the package from www.se.com again and retry the firmware upgrade process. If the same issue occurs, contact Schneider Electric Technical Support.

15. If the firmware upgrade process is interrupted or becomes unresponsive (more than 10 minutes have elapsed since beginning the upgrade process and the meter has not finished the upgrade attempt):
 - a. Remove the auxiliary control power to the meter and restore it after 10 s. If the meter powers up normally and is able to establish Ethernet communication, retry the firmware upgrade process.
If the firmware upgrade process is unsuccessful or if the meter does not power up normally or if the Ethernet communication is not established with the meter, contact Schneider Electric Technical Support.

Meter upgrade requirements for webpages

NOTE: To know the applicable firmware upgrade method for your meter model with firmware version, refer to table Meter models, firmware versions and firmware upgrade methods, page 209.

Following pre-requisites are required for firmware upgrade:

- Latest compatible firmware upgrade package (Download the latest firmware upgrade package from www.se.com).
- PC with Windows 10 and above operating system connected to meter via Ethernet network.
- Uninterrupted power supply to the control power input of the meter, with stable Ethernet communication.

Firmware upgrade using webpages

NOTE: To know the applicable firmware upgrade method for your meter model with firmware version, refer to table Meter models, firmware versions and firmware upgrade methods, page 209.

NOTE: The firmware upgrade process for PM5561 / PM5661 / PM5761 meter models cannot be performed when MID/MIR lock is enabled. You need to remove the MID/MIR lock using the meter display (Refer to Locking or unlocking the PM5561 / PM5661 / PM5761, page 225) to perform the firmware upgrade process.

▲ CAUTION

POTENTIAL FOR PRODUCT DAMAGE AND IRRECOVERABLE

Do not disrupt the auxiliary control power when the firmware upgrade is in progress.

Failure to follow these instructions may result in product being damaged and irrecoverable.

NOTE: Meter firmware includes a digital signature which helps ensure authenticity.

1. Click **Maintenance > Upgrade > Firmware**.
2. In the **Firmware Upgrade** section, click **Browse** button.
The **Choose File Open** dialog box opens.
3. Select the **.sedp** file from the firmware release folder.
4. Click **Upgrade** button.

The pop-up message **Do you want to apply the firmware upgrade now? The product will be restarted and all users will be disconnected from the application** opens.

5. Click **Yes** to apply the firmware upgrade.

NOTE: The device will check the firmware compatibility before upgrade.

Depending on several factors like network speed etc., the firmware upgrade process of the meter can take about 5 minutes or more.

After successful firmware upgrade, the meter can take up to 40 s to resume communication.

6. After the firmware upgrade process, navigate to **Maintenance > Upgrade > Upgrade Status** to check the last firmware upgrade status of your meter.
7. If the error message **The firmware upgrade failed. The selected firmware is either invalid or corrupted.** is displayed during the firmware upgrade process:
 - a. Click the **Close** button on the pop-up message.
 - b. Delete the downloaded copy of the latest firmware upgrade package from the PC. Download the package from www.se.com again and retry the firmware upgrade process. If the same issue occurs, contact Schneider Electric Technical Support.
8. If the firmware upgrade process is interrupted or becomes unresponsive (more than 5 minutes have elapsed since beginning the upgrade process and the meter has not finished the upgrade attempt):
 - a. Remove the auxiliary control power to the meter and restore it after 10 s. If the meter powers up normally and is able to establish Ethernet communication, retry the firmware upgrade process.

If the firmware upgrade process is unsuccessful or if the meter does not power up normally or if the Ethernet communication is not established with the meter, contact Schneider Electric Technical Support.

NOTE: The PM5561 meter model running on firmware version 12.0.X or later and PM5661 / PM5761 meter models running on firmware version 14.0.X or later can be upgraded to a compatible higher firmware version. The firmware upgrade (successful or unsuccessful) is limited to 25 attempts in PM5561/ PM5661 / PM5761. Any further attempt to upgrade is blocked.

Technical assistance

Visit www.se.com for support and assistance with lost passcodes or other technical problems with the meter.

Make sure you include your meter's model, serial number and firmware version in your email or have it readily available if calling Technical Support.

Verifying accuracy

Overview of meter accuracy

All meters are tested and verified at the factory in accordance with International Electrotechnical Commission (IEC) and American National Standards Institute (ANSI) standards.

Your digital power meter typically does not require re-calibration. However, in some installations a final accuracy verification of the meters is required, especially if the meters will be used for revenue or billing applications.

For a list of accuracy standards that your meter complies to, contact your local Schneider Electric representative or download the meter brochure from www.se.com.

Accuracy test requirements

The most common method for testing meter accuracy is to apply test voltages and currents from a stable power source and compare the meter's readings with readings from a reference device or energy standard.

Signal and power source

The meter maintains its accuracy during voltage and current signal source variations but its energy pulsing output needs a stable test signal to help produce accurate test pulses. The meter's energy pulsing mechanism needs approximately 10 seconds to stabilize after every source adjustment.

The meter must be connected to control power in order to conduct accuracy verification testing. Refer to your meter's installation documentation for power supply specifications.

DANGER

HAZARD OF ELECTRIC SHOCK, EXPLOSION, OR ARC FLASH

Verify the device's power source meets the specifications for your device's power supply.

Failure to follow these instructions will result in death or serious injury.

Control equipment

Control equipment is required for counting and timing the pulse outputs from an energy pulsing LED or digital output.

- Most standard test benches have an arm equipped with optical sensors to detect LED pulses (the photodiode circuitry converts detected light into a voltage signal).
- The reference device or energy standard typically has digital inputs that can detect and count pulses coming from an external source (i.e., the meter's digital output).

NOTE: The optical sensors on the test bench can be disrupted by strong sources of ambient light (such as camera flashes, florescent tubes, sunlight reflections, floodlights, etc.). This can cause test errors. Use a hood, if necessary, to block out ambient light.

Environment

The meter should be tested at the same temperature as the testing equipment. The ideal temperature is about 23 °C (73 °F).

A warm-up time of 30 minutes is recommended before beginning energy accuracy verification testing. At the factory, the meters are warmed up to their typical operating temperature before calibration to help ensure that the meters will reach their optimal accuracy at operating temperature.

Most high precision electronic equipment requires a warm up time before it reaches its specified performance levels.

Reference device or energy standard

To help ensure the accuracy of the test, it is recommended that you use a reference device or reference energy standard with a specified accuracy that is 6 to 10 times more accurate than the meter under test. Before you start testing, the reference device or energy standard should be warmed up as recommended by the manufacturer.

NOTE: Verify the accuracy and precision of all measurement equipment used in accuracy testing (for example, voltmeters, ammeters, power factor meters).

Energy pulsing

You can configure the meter's alarm /energy LED or the digital output(s) for energy pulsing.

- The meter is equipped with an alarm / energy pulsing LED. When configured for energy pulsing, the LED emits pulses that are then used to determine the accuracy of the meter's energy measurements.
- The meter sends the pulses from the configured digital output(s) port, which are then used to determine the accuracy of the meter's energy measurements by pulse counter.

Meter settings for accuracy testing

Your meter's power system and other parameters must be configured for accuracy testing.

Meter parameter	Value
Power system	3PH4W Wye Gnd (3-phase, 4 wire Wye with ground)
Energy pulse constant (alarm/energy pulsing LED or digital output)	In sync with reference test equipment

Verifying accuracy test

The following tests are guidelines for accuracy testing your meter; your meter shop may have specific testing methods.



HAZARD OF ELECTRIC SHOCK, EXPLOSION, OR ARC FLASH

- Apply appropriate Personal Protective Equipment (PPE) and follow safe electrical work practices. See NFPA 70E, CSA Z462 or other local standards.
- Turn off all power supplying this device and the equipment in which it is installed before working on or in the equipment.
- Always use a properly rated voltage sensing device to confirm that all power is off.
- Do not exceed the maximum ratings of this device.
- Verify the device's power source meets the specifications for your device's power supply.

Failure to follow these instructions will result in death or serious injury.

1. Turn off all power supplying this device and the equipment in which it is installed before working on the device or equipment.
2. Use a properly rated voltage sensing device to confirm that all power is off.
3. Connect the test voltage and current source to the reference device or energy standard. Ensure all voltage inputs to the meter under test are connected in parallel and all current inputs are connected in series.

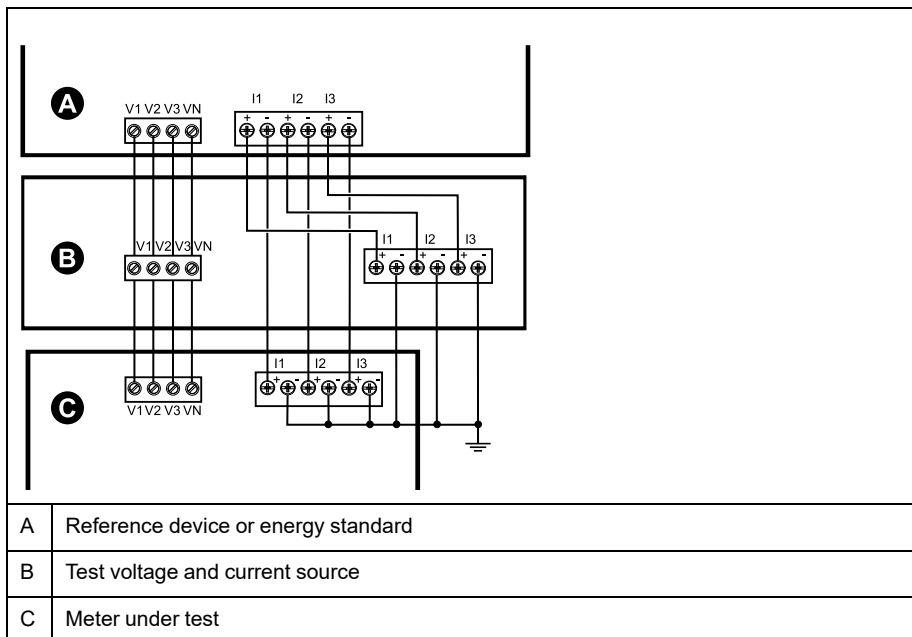

4. Connect the control equipment used for counting the standard output pulses using one of these methods:

Option	Description
Energy pulsing LED	Align the red light sensor on the standard test bench armature over the energy pulsing LED.
Digital output	Connect the meter's digital output to the standard test bench pulse counting connections.

NOTE: When selecting which method to use, be aware that energy pulsing LEDs and digital output(s) have different pulse rate limits.

5. Before performing the verification test, let the test equipment power up the meter and apply voltage for at least 30 seconds. This helps stabilize the internal circuitry of the meter.
6. Configure the meter's parameters for verifying accuracy testing.

7. Depending on the method selected for counting the energy pulses, configure the meter's energy pulsing LED or one of the digital output(s) to perform energy pulsing. Set the meter's energy pulse constant so it is in sync with the reference test equipment.
8. Perform accuracy verification on the test points. Run each test point for at least 30 seconds to allow the test bench equipment to read an adequate number of pulses. Allow 10 seconds of dwell time between test points.

Required pulses calculation for accuracy verification testing

Accuracy verification test equipment typically requires you to specify the number of pulses for a specific test duration.

The reference test equipment typically requires you to specify the number of pulses required for a test duration of "t" seconds. Normally, the number of pulses required is at least 25 pulses, and the test duration is greater than 30 seconds.

Use the following formula to calculate the required number of pulses:

$$\text{Number of pulses} = P_{\text{tot}} \times K \times t/3600$$

Where:

- P_{tot} = total instantaneous power in kilowatts (kW)
- K = the meter's pulse constant setting, in pulses per kWh
- t = test duration, in seconds (typically greater than 30 seconds)

Total power calculation for accuracy verification testing

Accuracy verification testing supplies the same test signal (total power) to both the energy reference/standard and the meter under test.

Total power is calculated as follows, where:

- P_{tot} = total instantaneous power in kilowatts (kW)
- V_{LN} = test point line-to-neutral voltage in volts (V)
- I = test point current in amps (A)
- PF = power factor

The result of the calculation is rounded up to the nearest integer.

For a balanced 3-phase Wye system:

$$P_{\text{tot}} = 3 \times V_{\text{LN}} \times I \times \text{PF} \times 1 \text{ kW}/1000 \text{ W}$$

NOTE: A balanced 3-phase system assumes that the voltage, current and power factor values are the same for all phases.

For a single-phase system:

$$P_{\text{tot}} = V_{\text{LN}} \times I \times \text{PF} \times 1 \text{ kW}/1000 \text{ W}$$

Percentage error calculation for accuracy verification testing

Accuracy verification testing requires you to calculate the percentage error between the meter being tested and the reference/standard.

Calculate the percentage error for every test point using the following formula:

$$\text{Energy error} = (EM - ES) / ES \times 100\%$$

Where:

- EM = energy measured by the meter under test

- ES = energy measured by the reference device or energy standard.
- NOTE:** If accuracy verification reveals inaccuracies in your meter, they may be caused by typical sources of test errors. If there are no sources of test errors present, please contact your local Schneider Electric representative.

Accuracy verification test points

The meter should be tested at full and light loads and at lagging (inductive) power factors to help ensure testing over the entire range of the meter.

The test amperage and voltage input rating are labeled on the meter. Refer to the installation sheet or data sheet for your meter’s nominal current, voltage and frequency specifications.

Watt-hour test point	Sample accuracy verification test point
Full load	100% to 200% of the nominal current, 100% of the nominal voltage and nominal frequency at unity power factor or one (1).
Light load	10% of the nominal current, 100% of the nominal voltage and nominal frequency at unity power factor or one (1).
Inductive load (lagging power factor)	100% of the nominal current, 100% of the nominal voltage and nominal frequency at 0.50 lagging power factor (current lagging voltage by 60° phase angle).

VAR-hour test point	Sample accuracy verification test point
Full load	100% to 200% of the nominal current, 100% of the nominal voltage and nominal frequency at zero power factor (current lagging voltage by 90° phase angle).
Light load	10% of the nominal current, 100% of the nominal voltage and nominal frequency at zero power factor (current lagging voltage by 90° phase angle).
Inductive load (lagging power factor)	100% of the nominal current, 100% of the nominal voltage and nominal frequency at 0.87 lagging power factor (current lagging voltage by 30° phase angle).

Energy pulsing considerations

The meter’s energy pulsing LED and pulse outputs are capable of energy pulsing within specific limits.

Description	Energy pulsing LED	Pulse output
Maximum pulse frequency	2.5 kHz	25 Hz
Minimum pulse constant	1 pulse per k_h	
Maximum pulse constant	9,999,000 pulses per k_h	

The pulse rate depends on the voltage, current and PF of the input signal source, the number of phases, and the VT and CT ratios.

If Ptot is the instantaneous power (in kW) and K is the pulse constant (in pulses per kWh), then the pulse period is:

$$\text{Pulse period (in seconds)} = \frac{3600}{K \times P_{tot}} = \frac{1}{\text{Pulse frequency (Hz)}}$$

VT and CT considerations

Total power (P_{tot}) is derived from the values of the voltage and current inputs at the secondary side, and takes into account the VT and CT ratios.

The test points are always taken at the secondary side, regardless of whether VTs or CTs are used.

If VTs and CTs are used, you must include their primary and secondary ratings in the equation. For example, in a balanced 3-phase Wye system with VTs and CTs:

$$P_{tot} = 3 \times V_{LN} \times \frac{V_{T_p}}{V_{T_s}} \times I \times \frac{C_{T_p}}{C_{T_s}} \times PF \times \frac{1 \text{ kW}}{1000 \text{ W}}$$

where P_{tot} = total power, V_{T_p} = VT primary, V_{T_s} = VT secondary, C_{T_p} = CT primary, C_{T_s} = CT secondary and PF = power factor.

Example calculations

This example calculation shows how to calculate power, pulse constants and maximum pulse frequency, and how to determine a pulse constant that reduces the maximum pulse frequency.

A balanced 3-phase Wye system uses 480:120 volt VTs and 100:5 amp CTs. The signals at the secondary side are 119 volts line-to-neutral and 4.99 amps, with a power factor of 0.85. The desired pulse output frequency is 20 Hz (20 pulses per second).

1. Calculate the typical total output power (P_{tot}):

$$P_{tot} = 3 \times 119 \times \frac{480}{120} \times 4.99 \times \frac{100}{5} \times 0.85 \times \frac{1 \text{ kW}}{1000 \text{ W}} = 141.14 \text{ kW}$$

2. Calculate the pulse constant (K):

$$K = \frac{3600 \times (\text{pulse frequency})}{P_{tot}} = \frac{3600 \text{ seconds/hour} \times 20 \text{ pulses/second}}{141.14 \text{ kW}}$$

$$K = 594.4 \text{ pulses / kWh}$$

3. At full load (200% of nominal current = 10 A) and power factor (PF = 1), calculate the maximum total output power (P_{max}):

$$P_{max} = 3 \times 119 \times \frac{480}{120} \times 10 \times \frac{100}{5} \times 1 \times \frac{1 \text{ kW}}{1000 \text{ W}} = 285.6 \text{ kW}$$

4. Calculate the maximum output pulse frequency at P_{max}:

$$\text{Maximum pulse frequency} = \frac{K \times P_{max}}{3600} = \frac{594.4 \text{ pulses / kWh} \times 285.6 \text{ kW}}{3600 \text{ seconds/hour}}$$

$$\text{Maximum pulse frequency} = 47.2 \text{ pulses/second} = 47.2 \text{ Hz}$$

5. Check the maximum pulse frequency against the limits for the LED and digital outputs:

- 47.2 Hz ≤ LED maximum pulse frequency (2.5 kHz)
- 47.2 Hz > digital output maximum pulse frequency (25 Hz)

NOTE: The maximum pulse frequency is within the limits for LED energy pulsing. However, the maximum pulse frequency is greater than the limits for digital output energy pulsing. Pulse output frequencies greater than 25 Hz will saturate the digital output and cause it to stop pulsing. Therefore in this example, you can only use the LED for energy pulsing.

Adjustments to allow energy pulsing at the digital outputs

If you want to use the digital output, you must reduce the output pulse frequency so it is within the limits.

Using the values from the above example, the maximum pulse constant for the digital output is:

$$K_{\max} = \frac{3600 \times (\text{digital output maximum pulse frequency})}{P_{\max}} = \frac{3600 \times 2.5}{285.6}$$

$$K_{\max} = 315.13 \text{ pulses per kWh}$$

1. Set the pulse constant (K) to a value below K_{\max} , for example, 300 pulses/kWh. Calculate the new maximum output pulse frequency at P_{\max} :

$$\text{New maximum pulse frequency} = \frac{K \times P_{\max}}{3600} = \frac{300 \text{ pulses/kWh} \times 285.6 \text{ kW}}{3600 \text{ seconds/hour}}$$

$$\text{New maximum pulse frequency} = 23.8 \text{ pulses/second} = 23.8 \text{ Hz}$$

2. Check the new maximum pulse frequency against the limits for the LED and digital outputs:
 - 23.8 Hz ≤ LED maximum pulse frequency (2.5 kHz)
 - 23.8 Hz ≤ digital output maximum frequency (25 Hz)

As expected, changing K to a value below K_{\max} allows you to use the digital output for energy pulsing.

3. Set the new pulse constant (K) on your meter.

Typical sources of test errors

If you see excessive errors during accuracy testing, examine your test setup and test procedures to eliminate typical sources of measurement errors.

Typical sources of accuracy verification testing errors include:

- Loose connections of voltage or current circuits, often caused by worn-out contacts or terminals. Inspect terminals of test equipment, cables, test harness and the meter under test.
- Meter ambient temperature is significantly different than 23 °C (73 °F).
- Floating (ungrounded) neutral voltage terminal in any configuration with unbalanced phase voltages.
- Inadequate meter control power, resulting in the meter resetting during the test procedure.
- Ambient light interference or sensitivity issues with the optical sensor.
- Unstable power source causing energy pulsing fluctuations.
- Incorrect test setup: not all phases connected to the reference device or the energy standard. All phases connected to the meter under test should also be connected to the reference meter/standard.
- Moisture (condensing humidity), debris or pollution present in the meter under test.

Revenue

Revenue metering overview

A revenue meter provides, over a defined range of operating conditions, measurements that are within international and national defined standards and industry-accepted accuracy limits.

It also provides protection against unauthorized alteration of these measured quantities. National and utility-based standards regulate protection against unauthorized alteration of measured quantities.

Revenue metering components

To meet government regulations and utility security requirements, the meter incorporates three types of security systems:

- Traditional anti-tamper mechanical seals on the meter
- Passcode entry to reset meter values, for example, Master reset.
- Hardware locking mechanism that prevents modification of revenue quantities after they are locked.

Revenue firmware security features

Your revenue-specific meter has additional firmware security features.

You cannot perform resets or configure some revenue-specific parameters on your meter while it is revenue-locked.

Revenue meters and firmware upgrades

Meter model	Upgrade information
PM5561 / PM5661 / PM5761	<p>The OS CRC value is a number that identifies the uniqueness between different OS firmware versions.</p> <p>You cannot upgrade a locked meter. In order to upgrade, you must:</p> <ul style="list-style-type: none"> • Follow the unlocking / locking procedure to unlock the meter. • Perform the upgrade. • Follow the unlocking / locking procedure to lock the meter.
PM5562 / PM5562MC	<p>You cannot upgrade a locked meter.</p> <p>In order to upgrade, you must:</p> <ul style="list-style-type: none"> • Remove the meter from service and unseal it. • Follow the unlocking / locking procedure to unlock the meter. • Perform the upgrade. • Follow the unlocking / locking procedure to lock the meter. • Re-seal and re-certify your meter with the appropriate revenue metering authorities.

NOTICE**LOSS OF COMPLIANCE**

Ensure that you re-certify your meter with the appropriate revenue metering authorities after re-enabling the hardware-based security.

Failure to follow these instructions may render your device non-compliant for billing purposes.

Protected setup parameters and functions

Your meter has features and settings that cannot be changed while the meter is revenue-locked.

In order to prevent modifications to revenue-related settings and data on your meter, some of the features and parameters on your meter cannot be edited once the meter is revenue-locked.

Protected setup parameters

Settings	Protected status	Description
Power system settings ⁸	Yes	You cannot change any power system settings while the meter is locked (for example, power system type, VT and CT connections, VT and CT primary and secondary values, system frequency and phase rotation)
Meter label	Yes	You cannot change the meter label while the meter is locked
Meter date	Yes	You cannot change the meter's date while the meter is locked
Energy pulsing	PM5561 / PM5661 / PM5761: See description PM5562 /PM5562MC: Not locked	The alarm / energy pulsing LED on the PM5561 / PM5661 / PM5761 is permanently set for energy pulsing and cannot be disabled or used for alarms. All other setup parameters for the energy pulsing LED are also permanently set and cannot be modified. The settings are fixed at: <ul style="list-style-type: none"> Mode (Control) = Energy (energy pulsing) Pulses per k_h (Pulse Rate) = 10,000 (pulses per kWh) <p>NOTE: The pulses per kWh reflect uncompensated values only. This means that the PT and CT values are ignored and the pulses represent the raw energy calculated from the metering inputs.</p> <ul style="list-style-type: none"> Channel (Parameter) = Active Energy Del+Rec
Multi-tariff and input metering settings	Yes	You cannot change multi-tariff mode or settings while the meter is locked. PM5561 / PM5661 / PM5761: You can only configure a subset of input metering settings when the meter is locked (channel label and demand code cannot be configured). PM5562 /PM5562MC: You cannot configure input metering settings when the meter is locked.
Energy reset passcode	Yes	You cannot change the energy reset passcode while the meter is locked
Data Log 1	PM5561 / PM5661 / PM5761: Not locked PM5562 /PM5562MC: Yes	You cannot configure Data Log 1 on the PM5562 /PM5562MC when the meter is locked.

8. For compliance, the Power System on the PM5561 / PM5562 / PM5562MC / PM5661 / PM5761 must be set to either 3PH4W Wye Gnd (three-phase 4-wire wye grounded) or 3PH3W Dlt Ungnd (three-phase 3-wire delta ungrounded).

Protected functions

Meter	Functions	Description
PM5561 / PM5661 / PM5761	Resets	After the meter is locked, the following resets are disabled: <ul style="list-style-type: none"> • Global resets: Meter Initialization (all) and Energies • Single resets: Energy and Multi-Tariff
	Control power (auxiliary power) interruption event	After the meter is locked, the control power (auxiliary power) interruption event is acknowledged only after entering the 4-digit MID/MIR / Revenue Lock password.
PM5562 / PM5562MC	Resets	After the meter is locked, the following resets are disabled: <ul style="list-style-type: none"> • Global resets: Meter Initialization (all), Energies and Input metering • Single resets: All energy, multi-tariff and input metering resets

For a complete list of protected functions and settings, see your meter's Modbus register list, available from www.se.com.

Revenue-locking summary

You must configure and revenue lock your meter before installing it.

- Unlock your revenue meter if it is locked.
- Configure the required revenue settings specific for installation.

NOTE: If you are using ION Setup to configure your meter, allow for any communication delays before removing power to your meter.
- Verify the revenue settings have been implemented.
- Clear all accumulated meter data.
- Revenue lock your meter.
- Verify the meter is revenue-locked.
- Install the meter and install the terminal covers according to your meter's installation sheet.

Revenue locking

Revenue locking your meter helps prevent modifications to revenue-related settings and data on your meter, or tampering with your meter's voltage and current connections.

Revenue locking may be required to help meet government regulations and utility security requirements, or can be used to help ensure the validity of revenue data.

You must configure all the lock-protected setup parameters before locking the meter.

Locking or unlocking the PM5561 / PM5661 / PM5761

After you initialize the meter, you must lock it in order to conform to MID/MIR standards.

Before you lock your meter:

- Make sure you have completed all necessary configuration.
- Perform a meter initialization reset to clear any previously accumulated meter data.

A lost lock passcode cannot be recovered.

NOTICE

PERMANENTLY LOCKED DEVICE

Record your device's user and passcode information in a secure location.

Failure to follow these instructions can result in data loss.

1. Navigate to **Maint > Lock**.
2. Set **Security Lock** by entering a non-zero passcode (a number between 1 and 9999).
3. Select **Yes** to confirm locking the meter, then exit the screen.
A lock icon appears on the upper left corner of the screen.
4. Make sure you record and store the lock passcode in a secure location.

NOTE: To change the lock passcode, unlock the meter then lock it again using a different passcode. Make sure you record this new passcode and store it in a secure place.

Revenue lock switch

The revenue lock switch is used to lock the PM5562 / PM5562MC meters.

The revenue lock switch located on top of the meter base and has a hole through which you can install an anti-tamper seal after you lock your meter.

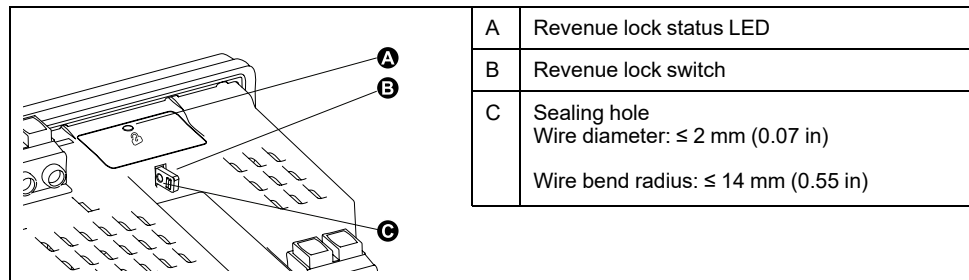

Locking and unlocking your meter using the hardware switch

You must lock PM5562 / PM5562MC meters using the hardware switch in order to comply with certain revenue standards.

Before you lock your meter:

- Make sure you have completed all necessary configuration.
- Perform a meter initialization reset to clear any previously accumulated meter data.

⚠ ⚠ DANGER**HAZARD OF ELECTRIC SHOCK, EXPLOSION, OR ARC FLASH**

- Apply appropriate Personal Protective Equipment (PPE) and follow safe electrical work practices. See NFPA 70E, CSA Z462 or other local standards.
- Turn off all power supplying this device and the equipment in which it is installed before working on or in the equipment.
- Always use a properly rated voltage sensing device to confirm that all power is off.
- Do not exceed the maximum ratings of this device.
- Verify the device's power source meets the specifications for your device's power supply.
- Use a non-conductive or insulated seal.

Failure to follow these instructions will result in death or serious injury.

1. Turn off all power supplying this device and the equipment in which it is installed before working on the device or equipment.
2. Use a properly rated voltage sensing device to confirm that all power is off.
3. Uninstall the meter if it is currently installed.
4. Locate the revenue lock switch.
5. Remove any anti-tamper seals from the revenue switch.
6. Place the meter base on a non-skid surface and make sure the meter is secure during the lock / unlock process.
7. Apply control power to the meter.
8. Press and hold the switch for 10 seconds to toggle revenue locking on and off.
9. Confirm the revenue lock status using the revenue lock icon on the display.
10. Remove control power from the meter.
11. Thread your seal through the hole on the revenue lock switch, if required, and seal.

Make sure you do not over-tighten the seal

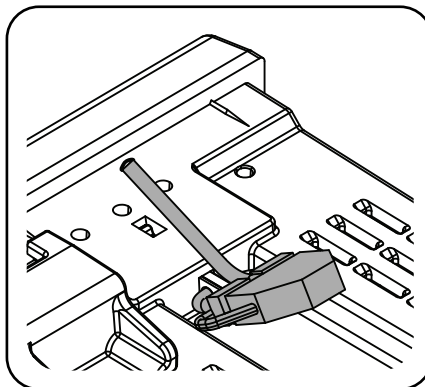

12. Follow the instructions in the installation sheet to Install the meter and apply the anti-tamper voltage and current terminal covers.

Device specifications

Mechanical characteristics

Applicable for all meter models except PM5563

IP degree of protection (IEC 60529)	Display: IP54 (Upgrade to IP65 with optional accessory kit METSEIP65OP96X96FF) Meter body: IP30 (except connectors) Connectors: IP20 with terminal covers installed, IP10 without terminal covers
Enclosure rating	Display: UL Type 12 For UL Type 12 applications, install meter and remote display on a flat surface of a Type 12 enclosure
Mounting position	Vertical
Display type	Monochrome graphics LCD, 128 x 128 resolution
Display backlight	White LED
Viewable area	67 x 62.5 mm (2.64 x 2.46 in)

Applicable only for PM5563 meter model

IP degree of protection (IEC 60529)	Meter body: IP30 (except connectors) Connectors: IP20 with terminal covers installed, IP10 without terminal covers
Mounting position	35 mm DIN rail

Electrical characteristics

Measurement accuracy

- Measurement type: True RMS up to the 63rd harmonic on three-phase (3P, 3P + N); 128 samples per cycle, zero blind
- IEC 61557-12: 2021, BS/ EN 61557-12: PMD/[SD|SS]/K70/0.2

Measurement type	Class of accuracy as per IEC 61557-12: 2021, BS/ EN 61557-12	Error
Active energy	Class 0.2S (Class 0.2S as per IEC 62053-22: 2020, BS/ EN 62053-22 at 5 A $I_{nominal}$ (for 1 A $I_{nominal}$ when $I > 0.15$ A))	±0.2%
Reactive energy	Class 2 (Class 2 as per IEC 62053-23: 2020, BS/ EN 62053-23 at 5 A $I_{nominal}$ (for 1 A $I_{nominal}$ when $I > 0.15$ A))	±2%
Apparent energy	Class 0.5	±0.5%
Active power	Class 0.2	±0.2%
Reactive power	Class 1	±1%
Apparent power	Class 0.5	±0.5%
Current	Class 0.2	±0.15%
Voltage (L-N)	Class 0.1	±0.1%
Frequency	Class 0.05	±0.05%
Power factor	Class 1	±0.005 Count

Power quality accuracy

Measurement type	Class of accuracy as per IEC 61557-12: 2021, BS/ EN 61557-12	Error
Voltage unbalance	Class 2	±2%
Voltage harmonics	Class 2	±2%
Voltage THD	Class 2	±2%

Power quality accuracy (Continued)

Measurement type	Class of accuracy as per IEC 61557-12: 2021, BS/ EN 61557-12	Error
Current harmonics	Class 2	±2%
Current THD	Class 2	±2%

Voltage inputs

Maximum VT/PT primary	1.0 MV AC
Specified accuracy range	20 – 400 V L-N / 20 – 690 V L-L (Wye) or 20 – 600 V L-L (Delta) UL Listed up to 347 V L-N / 600 V L-L
Measurement category	CAT III (6 kV rated impulse voltage)
Overload	480 V L-N / 828 V L-L
Impedance	5 MΩ
Specified accuracy frequency	50 or 60 Hz ±10% (45 – 70 Hz)
Burden	< 0.2 VA at 240 V AC L-N

Current inputs

Maximum CT primary	32767 A
CT secondary	Nominal: 5 A (Class 0.2S) or 1 A (Class 0.5S)
Measured current with over range and crest factor	50 mA – 10 A
Starting current	5 mA
Withstand	20 A continuous 50 A at 10 sec/hr 500 A at 1 sec/hr
Impedance	0.3 mΩ
Frequency	50 or 60 Hz ±10% (45 – 70 Hz)
Burden	< 0.024 VA at 10 A

RCM inputs (Applicable for PM5660 / PM5661 / PM5760 / PM5761 / PM5660L / PM5760L meter models)

Type	A (as per IEC 62020 Clause 9.19.2)
Frequency	45 – 65 Hz
Range Allowed range of RCM input terminals from toroid output signal	5 μA to 1200 μA (nominal), 1500 μA max (continuous)
Burden	150 Ω
Default toroid turns	1000

AC control power (Applicable for PM5560 / PM5561 / PM5562 / PM5562MC / PM5563 / PM5650 meter models)

Nominal AC voltage	480 V (Range: 100 to 480 V ±10%)
Installation category	CAT III 600 V class per BS/ EN/ IEC/ UL 61010-1: 2010 + A1: 2019
Burden	5.0 W / 16.0 VA / 15.2 VAR max at 480 V AC
Nominal frequency	50/60 Hz (Range: 45 to 65 Hz)
Ride-through time	35 ms typical at 120 V L-N and maximum burden 129 ms typical at 230 V L-N and maximum burden

AC control power (Applicable for PM5570 / PM5660 / PM5661 / PM5760 / PM5761 / PM5570L / PM5660L / PM5760L meter models)

Nominal AC voltage	480 V (Range: 100 to 480 V ±10%)
Installation category	CAT III 600 V class per BS/ EN/ IEC/ UL 61010-1: 2010 + A1: 2019
Burden	Maximum 13.1 VA / 4 W, Typical 10.6 VA at 230 V L-N
Nominal frequency	50/60 Hz (Range: 45 to 65 Hz)
Ride-through time	35 ms typical at 120 V L-N and maximum burden 129 ms typical at 230 V L-N and maximum burden

DC control power

Nominal DC voltage	250 V (Range: 125 to 250 V ±20%)
Burden	Maximum 5 W, Typical 3.1 W at 125 V DC (Applicable for PM5560 / PM5561 / PM5562 / PM5562MC / PM5563 / PM5650 meter models) Maximum 4 W, Typical 3.6 W at 125 V DC (Applicable for PM5570 / PM5660 / PM5661 / PM5760 / PM5761 meter models)
Ride-through time	29 ms typical at 125 V DC and maximum burden

Low-voltage DC control power (Applicable only for PM5580/ PM5570L / PM5660L / PM5760L meter models)

Operating range	20 – 60 V DC ±10%
Burden	4.1 W maximum
Ride-through time	15 ms typical at 18 – 60 V DC and maximum burden

Digital outputs

Number	2
Type	Form A solid-state digital outputs
Maximum load voltage	40 V AC / 60 V DC (Applicable for PM5500 series and PM5650 meter model) 30 V AC / 40 V DC (Applicable for PM5660 / PM5661 / PM5760 / PM5761 / PM5660L / PM5760L meter models)
Maximum load current	125 mA
ON resistance	8 Ω
Pulse frequency	25 Hz maximum
Pulse weight	1 to 9999999 pulses per k_h
Pulse width	50% duty cycle (20 ms minimum ON time) *Configurable pulse width for energy pulsing application: 20 ms, 25 ms, 50 ms, 100 ms
Leakage current	1 μA
Isolation	2.5 kV RMS for 60 seconds

*Available only in latest firmware versions:

- PM5560 / PM5562 / PM5563 / PM5580 meter models: 4.0.0 and above
- PM5570 / PM5660 / PM5760 meter models: 6.0.0 and above
- PM5650 meter model: 4.10.0 and above
- PM5561 meter model: 12.0.0 and above
- PM5661 / PM5761 meter models: 14.0.0 and above
- PM5570L / PM5660L / PM5760L meter models: 6.0.0 and above

Digital inputs (Applicable for PM5650 meter model and PM5500 series except PM5570 and PM5570L)

Number	4
Type	Externally excited

**Digital inputs (Applicable for PM5650 meter model and PM5500 series except PM5570 and PM5570L)
(Continued)**

Voltage OFF	0 – 6 V AC / 0 – 6 V DC
Voltage ON	15 – 30 V AC / 15 – 60 V DC
Input resistance	100 k Ω
Frequency	25 Hz maximum
Isolation	2.5 kV RMS for 60 seconds
Pulse width	50% duty cycle (20 ms minimum ON time)
Response time	10 ms
Input burden	2 mA at 24 V AC/DC 2.5 mA at 60 V AC/DC

Digital inputs (Applicable for PM5570 / PM5660 / PM5661 / PM5760 / PM5761 / PM5570L / PM5660L / PM5760L meter models)

Number	2
Type	Externally excited
Voltage OFF	0 – 6 V AC / 0 – 6 V DC
Voltage ON	18 – 30 V AC / 12 – 40 V DC
Input resistance	100 k Ω
Frequency	25 Hz maximum
Isolation	2.5 kV RMS for 60 seconds
Pulse width	50% duty cycle (20 ms minimum ON time)
Response time	10 ms
Input burden	2 mA at 24 V AC/DC 2.5 mA at 60 V AC/DC

Analog inputs (Applicable only for PM5570 / PM5570L meter models)

Number	2
Type	DC current
Range	4 – 20 mA
Accuracy	\pm 1% of full scale (0.2 mA)
Impedance	< 20 Ω
Operating voltage	24 V DC maximum

Environmental characteristics

Operating temperature	Meter: -25 to 70 °C (-13 to 158 °F) Display: -20 to 70 °C (-4 to 158 °F) Display functions to -25 °C (-13 °F) with reduced performance
Storage temperature	-40 to 85 °C (-40 to 185 °F)
Humidity rating	Operating: 5% to 95% RH non-condensing Storage: 5% to 80% RH non-condensing Maximum dew point 37 °C (99 °F)
Pollution degree	2
Altitude	\leq 3000 m (9843 ft) CAT III

Location / mounting	For indoor use in a stationary panel Must be permanently connected and fixed
Product life	> 15 years, 45 °C (113 °F) 60% RH

LEDs

LED indicators

Heartbeat / communications activity	Green LED (front panel on display or remote display, top on DIN model)
Alarm / energy pulsing LED	Amber LED (front panel on display or remote display, top on DIN model)
Revenue lock status	Green LED (top on PM5562 / PM5562MC)

Active alarm / energy pulsing LED

Type	Amber LED, optical
Maximum pulse frequency	50 Hz
Pulse width	50% duty cycle (200 µs minimum ON time)
Meter constant	10000 pulses per kWh/kVARh Configurable from 1 to 9999999 pulses per k_h (k_h = kWh, kVARh or kVAh) (Fixed at 10,000 pulses per kWh on MID/MIR meter models)
Wavelength	590 to 635 nm

EMC (electromagnetic compatibility)

Harmonic current emissions	IEC 61000-3-2
Flicker (voltage fluctuation) limits	IEC 61000-3-3
Immunity to electrostatic discharge	IEC 61000-4-2
Immunity to radiated fields	IEC 61000-4-3
Immunity to fast transients	IEC 61000-4-4
Immunity to surges	IEC 61000-4-5
Immunity to conducted disturbances, 150 kHz to 80 MHz	IEC 61000-4-6
Immunity to magnetic fields	IEC 61000-4-8
Immunity to voltage dips and interruptions	IEC 61000-4-11
Immunity to damped oscillatory waves	IEC 61000-4-12
Radiated and conducted emissions	FCC part 15 Class B, EN 55022 Class B

Safety and product standards

Safety	BS/ EN/ IEC/ UL 61010-1: 2010 + A1: 2019	
Protective class	Protective class II Double insulated for user accessible parts	
Standard compliance	IEC 62052-31: 2015 IEC 62052-11: 2020 IEC 62053-22: 2020 IEC 62053-23: 2020 IEC 61557-12: 2021	BS/ EN 62052-31 BS/ EN 62052-11 BS/ EN 62053-22 BS/ EN 62053-23 BS/ EN 61557-12 BS/ EN 50470-1 BS/ EN 50470-3

MID/MIR compliance

Applicable for PM5561 / PM5661 / PM5761 meter models

Applicable MID/MIR standards and class index	<ul style="list-style-type: none"> BS/ EN 50470-1 Class C BS/ EN 50470-3 Class C
Type of measuring equipment	Static watt-hour meter
Intended use	For indoor use in a stationary panel, permanently mounted in residential, commercial or light industrial applications, where levels of vibration and shock are of low significance
Mechanical environment	M1
Electromagnetic (EMC) environment	E2
Applicable measurements	Active energy metering only (kWh or MWh)
Voltage at voltage terminals	<ul style="list-style-type: none"> 3-phase 4-wire Wye grounded: 3 x 57.7 (100) to 3 x 400 (690) V AC 3-phase 3-wire Delta ungrounded: 3 x 100 to 3 x 600 V L-L
Electrical network frequency	50 Hz

RS-485 communications

Number of ports	1
Maximum cable length	1219 m (4000 ft)
Maximum number of devices (unit loads)	Up to 32 devices on the same bus
Parity	Even, Odd, None (1 stop bit for Odd or Even parity; 2 stop bits for None)
Baud rate	9600, 19200, 38400 baud
Protocol	Modbus RTU, Modbus ASCII (7 or 8 bit), Jbus
Isolation	2.5 kV RMS, double insulated

Ethernet communications

Number of ports	2
Maximum cable length	100 m (328 ft), per TIA/EIA 568-5-A
Mode	10Base-T, 100Base-TX, Auto-MDIX
Protocol	Modbus TCP, HTTP / HTTPS**, FTP / FTPS**, DHCP, BOOTP, BACnet/IP, EtherNet/IP, DNP3*

*Available in specific meter models. Refer to Features differentiation matrix for PM5500 / PM5600 / PM5700 series, page 20 for the availability.

**Available only in latest firmware versions:

- PM5560 / PM5562 / PM5563 / PM5580 meter models: 4.0.0 and above
- PM5570 / PM5660 / PM5760 meter models: 6.0.0 and above
- PM5650 meter model: 4.10.0 and above
- PM5561 meter model: 12.0.0 and above
- PM5661 / PM5761 meter models: 14.0.0 and above
- PM5570L / PM5660L / PM5760L meter models: 6.0.0 and above

Real-time clock

Clock drift	~ 0.4 seconds per day (typical)
Battery backup time	3 years without control power (typical)

Conformal coating

PCBAs assembled in this product are treated with UL approved conformal coating chemical.

Restoration of temporarily disabled configuration settings in webpages

For the meter models with firmware versions mentioned in column (B) of table, the configuration settings and login requirements in the webpages have been limited to meet updated cybersecurity best practices. With additional cybersecurity measures incorporated into the product, the functionalities have now been restored with the latest firmware versions mentioned in column (C) of table.

NOTE: If your meter is presently running on firmware version mentioned in columns (A) or (B) of table, upgrade your meter to the latest released version of firmware as mentioned in column (C) of table to enhance your product’s cybersecurity and to use all the features of the webpages (Refer to Firmware upgrades, page 209).

NOTE:

- For the meter models with the firmware versions mentioned in column (B) of table, the **HTTP** service is accessible without user credentials.
- To access **FTP** service, navigate to **Maint > Setup > Comm > Enet** and set the **FTP** parameter to **Enabled** using the meter’s display.

Meter models and firmware versions

Meter models	Firmware version series		
	(A) No webpage limitations	(B) Webpage limitations	(C) No webpage limitations
PM5560	2.7.7 and earlier	2.7.8 to 2.9.9	4.0.0 and above
PM5563	Not applicable		
PM5580	2.7.7 and earlier		
PM5562	2.5.4 and earlier	Not applicable	4.0.0 and above
PM5650	Not applicable	2.10.0 to 2.12.9	4.10.0 and above
PM5570	Not applicable	3.0.0 to 3.2.9	Firmware upgrade not supported. Contact Schneider Electric Technical Support for help
PM5660			
PM5760			
PM5561	Not applicable	10.7.3 to 10.9.9	12.0.0 and above
PM5661	Not applicable	11.0.0 to 11.2.9	Firmware upgrade not supported. Contact Schneider Electric Technical Support for help
PM5761			

China Standard Compliance

This product complies with the following standard(s) in China:

PM5560 / PM5563

BS/ EN/ IEC 62053-22 Electricity metering equipment (A.C.) - Particular requirements - Part 22: Static meters for active energy (Classes 0,2 S and 0,5 S)

BS/ EN/ IEC 61557-12 Electrical safety in low voltage distribution systems up to 1 000 V a.c. and 1 500 V d.c. - Equipment for testing, measuring or monitoring of protective measures - Part 12: Performance measuring and monitoring devices

BS/ EN/ IEC/ UL 61010-1 Safety requirements for electrical equipment for measurement, control, and laboratory use - Part 1: General requirements

GB/T 22264.7-2008 安装式数字显示电测量仪表 第7部分：多功能仪表的特殊要求

PM5561 / PM5562 / PM5650 / PM5570 / PM5580 / PM5660 / PM5760 / PM5661 / PM5761 / PM5570L / PM5660L / PM5760L

BS/ EN/ IEC 62053-22 Electricity metering equipment (A.C.) - Particular requirements - Part 22: Static meters for active energy (Classes 0,2 S and 0,5 S)

BS/ EN/ IEC 61557-12 Electrical safety in low voltage distribution systems up to 1 000 V a.c. and 1 500 V d.c. - Equipment for testing, measuring or monitoring of protective measures - Part 12: Performance measuring and monitoring devices

BS/ EN/ IEC/ UL 61010-1 Safety requirements for electrical equipment for measurement, control, and laboratory use - Part 1: General requirements

Schneider Electric
35 rue Joseph Monier
92500 Rueil Malmaison
France

+ 33 (0) 1 41 29 70 00

www.se.com

As standards, specifications, and design change from time to time,
please ask for confirmation of the information given in this publication.

© 2023 – Schneider Electric. All rights reserved.

HRB1684301-16