

# Modicon TM4 Expansion Modules Programming Guide

12/2019



---

The information provided in this documentation contains general descriptions and/or technical characteristics of the performance of the products contained herein. This documentation is not intended as a substitute for and is not to be used for determining suitability or reliability of these products for specific user applications. It is the duty of any such user or integrator to perform the appropriate and complete risk analysis, evaluation and testing of the products with respect to the relevant specific application or use thereof. Neither Schneider Electric nor any of its affiliates or subsidiaries shall be responsible or liable for misuse of the information contained herein. If you have any suggestions for improvements or amendments or have found errors in this publication, please notify us.

You agree not to reproduce, other than for your own personal, noncommercial use, all or part of this document on any medium whatsoever without permission of Schneider Electric, given in writing. You also agree not to establish any hypertext links to this document or its content. Schneider Electric does not grant any right or license for the personal and noncommercial use of the document or its content, except for a non-exclusive license to consult it on an "as is" basis, at your own risk. All other rights are reserved.

All pertinent state, regional, and local safety regulations must be observed when installing and using this product. For reasons of safety and to help ensure compliance with documented system data, only the manufacturer should perform repairs to components.

When devices are used for applications with technical safety requirements, the relevant instructions must be followed.

Failure to use Schneider Electric software or approved software with our hardware products may result in injury, harm, or improper operating results.

Failure to observe this information can result in injury or equipment damage.

© 2019 Schneider Electric. All rights reserved.

---

# Table of Contents

---



	<b>Safety Information</b> .....	<b>5</b>
	<b>About the Book</b> .....	<b>7</b>
<b>Chapter 1</b>	<b>General Description</b> .....	<b>11</b>
	General Description .....	<b>12</b>
	TM4 Expansion Modules Compatibility .....	<b>13</b>
	Adding a TM4 Expansion Module .....	<b>15</b>
	Connecting the Controller to a PC .....	<b>16</b>
<b>Chapter 2</b>	<b>TM4ES4 Ethernet Module</b> .....	<b>17</b>
2.1	Ethernet Services .....	<b>18</b>
	Presentation .....	<b>19</b>
	IP Address Configuration .....	<b>21</b>
	Modbus TCP Server/Client .....	<b>26</b>
	Web Server .....	<b>28</b>
	FTP Server .....	<b>45</b>
	SNMP .....	<b>46</b>
	M241 Logic Controller as a Target Device on EtherNet/IP .....	<b>47</b>
	M241 Logic Controller as a Slave Device on Modbus TCP .....	<b>64</b>
2.2	Firewall Configuration .....	<b>69</b>
	Introduction .....	<b>70</b>
	Dynamic Changes Procedure .....	<b>72</b>
	Firewall Behavior .....	<b>73</b>
	Firewall Script Commands .....	<b>75</b>
<b>Chapter 3</b>	<b>TM4PDPS1 PROFIBUS DP Slave Module</b> .....	<b>81</b>
3.1	PROFIBUS DP Slave Module Configuration .....	<b>82</b>
	Add a PROFIBUS DP Slave Module .....	<b>83</b>
	Configure the PROFIBUS DP Slave Module .....	<b>84</b>
	Input / Output Devices Objects .....	<b>85</b>
3.2	Data Exchange .....	<b>87</b>
	I/O Cyclic Exchange .....	<b>88</b>
	Acyclic Exchange with PROFIBUS DPV1 Functions .....	<b>91</b>
3.3	Diagnostic .....	<b>93</b>
	Diagnostic Information .....	<b>93</b>
<b>Glossary</b>	.....	<b>95</b>
<b>Index</b>	.....	<b>99</b>



---

# Safety Information

---



## Important Information

### NOTICE

Read these instructions carefully, and look at the equipment to become familiar with the device before trying to install, operate, service, or maintain it. The following special messages may appear throughout this documentation or on the equipment to warn of potential hazards or to call attention to information that clarifies or simplifies a procedure.



The addition of this symbol to a “Danger” or “Warning” safety label indicates that an electrical hazard exists which will result in personal injury if the instructions are not followed.



This is the safety alert symbol. It is used to alert you to potential personal injury hazards. Obey all safety messages that follow this symbol to avoid possible injury or death.

## **DANGER**

**DANGER** indicates a hazardous situation which, if not avoided, **will result in death** or serious injury.

## **WARNING**

**WARNING** indicates a hazardous situation which, if not avoided, **could result in death** or serious injury.

## **CAUTION**

**CAUTION** indicates a hazardous situation which, if not avoided, **could result** in minor or moderate injury.

## **NOTICE**

**NOTICE** is used to address practices not related to physical injury.

---

## PLEASE NOTE

Electrical equipment should be installed, operated, serviced, and maintained only by qualified personnel. No responsibility is assumed by Schneider Electric for any consequences arising out of the use of this material.

A qualified person is one who has skills and knowledge related to the construction and operation of electrical equipment and its installation, and has received safety training to recognize and avoid the hazards involved.

---

# About the Book

---



## At a Glance

### Document Scope

This document describes the configuration of the TM4 expansion modules for EcoStruxure Machine Expert. For further information, refer to the separate documents provided in the EcoStruxure Machine Expert online help.

### Validity Note

This document has been updated for the release of EcoStruxure™ Machine Expert V1.2.

### Related Documents

Title of Documentation	Reference Number
EcoStruxure Machine Expert Programming Guide	<a href="#">EIO0000002854 (ENG)</a> <a href="#">EIO0000002855 (FRE)</a> <a href="#">EIO0000002856 (GER)</a> <a href="#">EIO0000002857 (SPA)</a> <a href="#">EIO0000002858 (ITA)</a> <a href="#">EIO0000002859 (CHS)</a>
Modicon M241 Logic Controller - Programming Guide	<a href="#">EIO0000003059 (ENG)</a> <a href="#">EIO0000003060 (FRA)</a> <a href="#">EIO0000003061 (GER)</a> <a href="#">EIO0000003062 (SPA)</a> <a href="#">EIO0000003063 (ITA)</a> <a href="#">EIO0000003064 (CHS)</a>
Modicon M251 Logic Controller - Programming Guide	<a href="#">EIO0000003089 (ENG)</a> <a href="#">EIO0000003090 (FRA)</a> <a href="#">EIO0000003091 (GER)</a> <a href="#">EIO0000003092 (SPA)</a> <a href="#">EIO0000003093 (ITA)</a> <a href="#">EIO0000003094 (CHS)</a>

Title of Documentation	Reference Number
TM4 Expansion Modules - Hardware Guide	<a href="#">EIO0000003155 (ENG)</a> <a href="#">EIO0000003156 (FRA)</a> <a href="#">EIO0000003157 (GER)</a> <a href="#">EIO0000003158 (SPA)</a> <a href="#">EIO0000003159 (ITA)</a> <a href="#">EIO0000003160 (CHS)</a>
TM4 Expansion Modules - Instruction Sheet	<a href="#">EAV47886</a>

You can download these technical publications and other technical information from our website at <https://www.se.com/ww/en/download/> .

### Product Related Information

 <b>WARNING</b>
<p><b>LOSS OF CONTROL</b></p> <ul style="list-style-type: none"> <li>• The designer of any control scheme must consider the potential failure modes of control paths and, for certain critical control functions, provide a means to achieve a safe state during and after a path failure. Examples of critical control functions are emergency stop and overtravel stop, power outage and restart.</li> <li>• Separate or redundant control paths must be provided for critical control functions.</li> <li>• System control paths may include communication links. Consideration must be given to the implications of unanticipated transmission delays or failures of the link.</li> <li>• Observe all accident prevention regulations and local safety guidelines.<sup>1</sup></li> <li>• Each implementation of this equipment must be individually and thoroughly tested for proper operation before being placed into service.</li> </ul> <p><b>Failure to follow these instructions can result in death, serious injury, or equipment damage.</b></p>

<sup>1</sup> For additional information, refer to NEMA ICS 1.1 (latest edition), "Safety Guidelines for the Application, Installation, and Maintenance of Solid State Control" and to NEMA ICS 7.1 (latest edition), "Safety Standards for Construction and Guide for Selection, Installation and Operation of Adjustable-Speed Drive Systems" or their equivalent governing your particular location.

 <b>WARNING</b>
<p><b>UNINTENDED EQUIPMENT OPERATION</b></p> <ul style="list-style-type: none"> <li>• Only use software approved by Schneider Electric for use with this equipment.</li> <li>• Update your application program every time you change the physical hardware configuration.</li> </ul> <p><b>Failure to follow these instructions can result in death, serious injury, or equipment damage.</b></p>



---

## Terminology Derived from Standards

The technical terms, terminology, symbols and the corresponding descriptions in this manual, or that appear in or on the products themselves, are generally derived from the terms or definitions of international standards.

In the area of functional safety systems, drives and general automation, this may include, but is not limited to, terms such as *safety*, *safety function*, *safe state*, *fault*, *fault reset*, *malfunction*, *failure*, *error*, *error message*, *dangerous*, etc.

Among others, these standards include:

Standard	Description
IEC 61131-2:2007	Programmable controllers, part 2: Equipment requirements and tests.
ISO 13849-1:2015	Safety of machinery: Safety related parts of control systems. General principles for design.
EN 61496-1:2013	Safety of machinery: Electro-sensitive protective equipment. Part 1: General requirements and tests.
ISO 12100:2010	Safety of machinery - General principles for design - Risk assessment and risk reduction
EN 60204-1:2006	Safety of machinery - Electrical equipment of machines - Part 1: General requirements
ISO 14119:2013	Safety of machinery - Interlocking devices associated with guards - Principles for design and selection
ISO 13850:2015	Safety of machinery - Emergency stop - Principles for design
IEC 62061:2015	Safety of machinery - Functional safety of safety-related electrical, electronic, and electronic programmable control systems
IEC 61508-1:2010	Functional safety of electrical/electronic/programmable electronic safety-related systems: General requirements.
IEC 61508-2:2010	Functional safety of electrical/electronic/programmable electronic safety-related systems: Requirements for electrical/electronic/programmable electronic safety-related systems.
IEC 61508-3:2010	Functional safety of electrical/electronic/programmable electronic safety-related systems: Software requirements.
IEC 61784-3:2016	Industrial communication networks - Profiles - Part 3: Functional safety fieldbuses - General rules and profile definitions.
2006/42/EC	Machinery Directive
2014/30/EU	Electromagnetic Compatibility Directive
2014/35/EU	Low Voltage Directive

---

In addition, terms used in the present document may tangentially be used as they are derived from other standards such as:

Standard	Description
IEC 60034 series	Rotating electrical machines
IEC 61800 series	Adjustable speed electrical power drive systems
IEC 61158 series	Digital data communications for measurement and control – Fieldbus for use in industrial control systems

Finally, the term *zone of operation* may be used in conjunction with the description of specific hazards, and is defined as it is for a *hazard zone* or *danger zone* in the *Machinery Directive (2006/42/EC)* and *ISO 12100:2010*.

**NOTE:** The aforementioned standards may or may not apply to the specific products cited in the present documentation. For more information concerning the individual standards applicable to the products described herein, see the characteristics tables for those product references.

---

# Chapter 1

## General Description

---

### Introduction

This chapter provides a general description of TM4 expansion modules.

### What Is in This Chapter?

This chapter contains the following topics:

Topic	Page
General Description	12
TM4 Expansion Modules Compatibility	13
Adding a TM4 Expansion Module	15
Connecting the Controller to a PC	16

## General Description

### Introduction

The range of TM4 expansion modules includes communication modules.

### TM4 Expansion Module Features

The table shows the TM4 expansion module features:

Module Reference	Type	Terminal Type
TM4ES4	Ethernet communication	4 RJ45 connectors
TM4PDPS1	PROFIBUS DP slave communication	1 SUB-D 9 pins female connector

## TM4 Expansion Modules Compatibility

### Introduction

This section describes the compatibility of TM4 expansion modules with controllers.

The TM4 bus supports up to 3 expansion modules. You can mix both Profibus DP (TM4PDPS1) and Ethernet (TM4ES4) expansion modules to the limit of 3 expansions.

### TM4ES4 Ethernet Module Compatibility

The TM4ES4 module has 2 applications:

- **Expansion:** addition of an Ethernet interface to extend the number of Ethernet ports for a controller,  
**NOTE:** If more than 1 TM4ES4 module is installed on the controller, the one closest to the controller is used as **expansion**.
- **Standalone:** Ethernet switch (only getting its power supply from the controller).

The table shows the TM4ES4 Ethernet module compatibility with controllers:

Controller Reference	Expansion Usage Supported	Standalone Usage Supported	Maximum Number of TM4ES4 Modules
TM241CE40T	Yes	Yes	1 expansion + 2 standalone or 3 standalone
TM241CE40U	Yes	Yes	1 expansion + 2 standalone or 3 standalone
TM241CE24T	Yes	Yes	1 expansion + 2 standalone or 3 standalone
TM241CE24U	Yes	Yes	1 expansion + 2 standalone or 3 standalone
TM241C40T	Yes	Yes	1 expansion + 2 standalone or 3 standalone
TM241C40U	Yes	Yes	1 expansion + 2 standalone or 3 standalone
TM241C24T	Yes	Yes	1 expansion + 2 standalone or 3 standalone
TM241C24U	Yes	Yes	1 expansion + 2 standalone or 3 standalone
TM241CE40R	Yes	Yes	1 expansion + 2 standalone or 3 standalone
TM241CE24R	Yes	Yes	1 expansion + 2 standalone or 3 standalone
<b>NOTE: Standalone</b> use does not require configuration in EcoStruxure Machine Expert.			

Controller Reference	Expansion Usage Supported	Standalone Usage Supported	Maximum Number of TM4ES4 Modules
TM241C40R	Yes	Yes	1 expansion + 2 standalone or 3 standalone
TM241C24R	Yes	Yes	1 expansion + 2 standalone or 3 standalone
TM241CEC24T	Yes	Yes	3 standalone
TM241CEC24U	Yes	Yes	3 standalone
TM241CEC24R	Yes	Yes	3 standalone
TM251MESE	No	Yes	3 standalone
TM251MESC	No	Yes	3 standalone
<b>NOTE: Standalone</b> use does not require configuration in EcoStruxure Machine Expert.			

### TM4PDPS1 PROFIBUS DP Expansion Module Compatibility

The TM4PDPS1 module is compatible with M241 and M251 controllers.

One TM4PDPS1 module can be added per controller.

## Adding a TM4 Expansion Module

### Adding a TM4 Expansion Module

To add an expansion module to your controller, select the expansion module in the **Hardware Catalog**, drag it to the **Devices tree**, and drop it on the **COM\_Bus** node.

For more information on adding a device to your project, refer to:

- Using the Drag-and-drop Method (*see EcoStruxure Machine Expert, Programming Guide*)
- Using the Contextual Menu or Plus Button (*see EcoStruxure Machine Expert, Programming Guide*)

### Expansion Module Configuration

To configure your TM4 Expansion Module, double click the expansion module node in the **Devices tree** to display the configuration tabs. The following chapters detail the configuration parameters.

**NOTE:** You do not configure the TM4ES4 when using it as a standalone switch in EcoStruxure Machine Expert. As such, the TM4ES4 module does not appear in the **Devices tree**.

## Connecting the Controller to a PC

### Overview

To transfer, run, and monitor the applications, connect the controller to a computer that has EcoStruxure Machine Expert installed. Use either a USB cable or an Ethernet connection (for those references that support an Ethernet port).

### ***NOTICE***

#### **INOPERABLE EQUIPMENT**

Always connect the communication cable to the PC before connecting it to the controller.

**Failure to follow these instructions can result in equipment damage.**

### Ethernet Port Connection

You can connect the controller to a PC using an Ethernet cable.

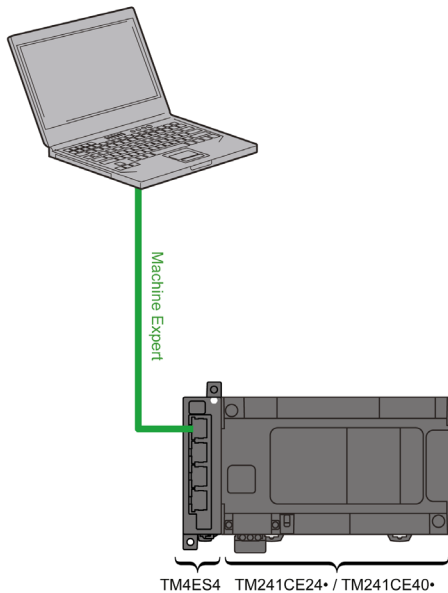

To connect the controller to the PC, do the following:

Step	Action
1	Connect your Ethernet cable to the PC.
2	Connect your Ethernet cable to a free Ethernet port on the TM4ES4 expansion module.



---

# Chapter 2

## TM4ES4 Ethernet Module

---

### Introduction

This chapter describes the configuration of the TM4ES4 Ethernet module when it is used as **Expansion**.

In **Standalone** use, the module does not require configuration in EcoStruxure Machine Expert, and therefore the information in this chapter is not applicable.

Refer to TM4ES4 Ethernet Module Compatibility (*see page 13*) to know the application type according to the controller reference compatibility.

### What Is in This Chapter?

This chapter contains the following sections:

Section	Topic	Page
2.1	Ethernet Services	18
2.2	Firewall Configuration	69

## Section 2.1

### Ethernet Services

---

#### What Is in This Section?

This section contains the following topics:

Topic	Page
Presentation	19
IP Address Configuration	21
Modbus TCP Server/Client	26
Web Server	28
FTP Server	45
SNMP	46
M241 Logic Controller as a Target Device on EtherNet/IP	47
M241 Logic Controller as a Slave Device on Modbus TCP	64

## Presentation

### Ethernet Services

The module supports the following services:

- Modbus TCP Server (*see page 26*)
- Modbus TCP Client (*see page 26*)
- Web Server (*see page 28*)
- FTP Server (*see page 45*)
- SNMP (*see page 46*)
- M241 Logic Controller as Target Device on EtherNet/IP (*see page 47*)
- M241 Logic Controller as Slave Device on Modbus TCP (*see page 64*)
- IEC VAR access (*see page 20*)

### Ethernet Protocol

Through the module, the following protocols are supported:

- IP (Internet Protocol)
- UDP (User Datagram Protocol)
- TCP (Transmission Control Protocol)
- ARP (Address Resolution Protocol)
- ICMP (Internet Control Messaging Protocol)
- IGMP (Internet Group Management Protocol)

## TCP Server Connections

This table shows the maximum number of TCP server connections:

Connection Type	Maximum Number of Server Connections
Modbus Server	8
EtherNet/IP Device	16
FTP Server	4
Web Server	10

Each server based on TCP manages its own set of connections.

When a client tries to open a connection that exceeds the poll size, the controller closes the oldest connection.

If all connections are busy (exchange in progress) when a client tries to open a new one, the new connection is denied.

All server connections stay open as long as the controller stays in operational states (RUN, STOP, HALT).

All server connections are closed when leaving or entering operational states (RUN, STOP, HALT), except in case of power outage (because the controller does not have time to close the connections).

For more information about the operational states, refer to the controller state diagram (see *Modicon M241 Logic Controller, Programming Guide*).

## Services Available

With an Ethernet communication, the **IEC VAR ACCESS** service is supported by the controller. With the **IEC VAR ACCESS** service, variables can be exchanged between the controller and an HMI.

The **NetWork variables** service is also supported by the controller. With the **NetWork variables** service, data can be exchanged between controllers.

**NOTE:** For more information, refer to the EcoStruxure Machine Expert Programming Guide.

## IP Address Configuration

### Introduction

There are different ways to assign the IP address of the module:

- address assignment by DHCP server
- address assignment by BOOTP server
- fixed IP address
- post configuration file (*see Modicon M241 Logic Controller, Programming Guide*). If a post configuration file exists, this assignment method has priority over the others.

IP address can be changed dynamically:

- via the Controller Selection (*see EcoStruxure Machine Expert, Programming Guide*) tab in EcoStruxure Machine Expert.

**NOTE:** If the attempted addressing method is unsuccessful, the module will start using a default IP address (*see page 24*) derived from the MAC address.

Carefully manage the IP addresses because each device on the network requires a unique address. Having multiple devices with the same IP address can cause unintended operation of your network and associated equipment.

### WARNING

#### UNINTENDED EQUIPMENT OPERATION

- Verify that there is only one master controller configured on the network or remote link.
- Verify that all devices have unique addresses.
- Obtain your IP address from your system administrator.
- Confirm that the IP address of the device is unique before placing the system into service.
- Do not assign the same IP address to any other equipment on the network.
- Update the IP address after cloning any application that includes Ethernet communications to a unique address.

**Failure to follow these instructions can result in death, serious injury, or equipment damage.**

**NOTE:** Verify that your system administrator maintains a record of all assigned IP addresses on the network and subnetwork, and inform the system administrator of all configuration changes performed.

### Address Management

The different types of address systems for the controller are shown in the following diagram:

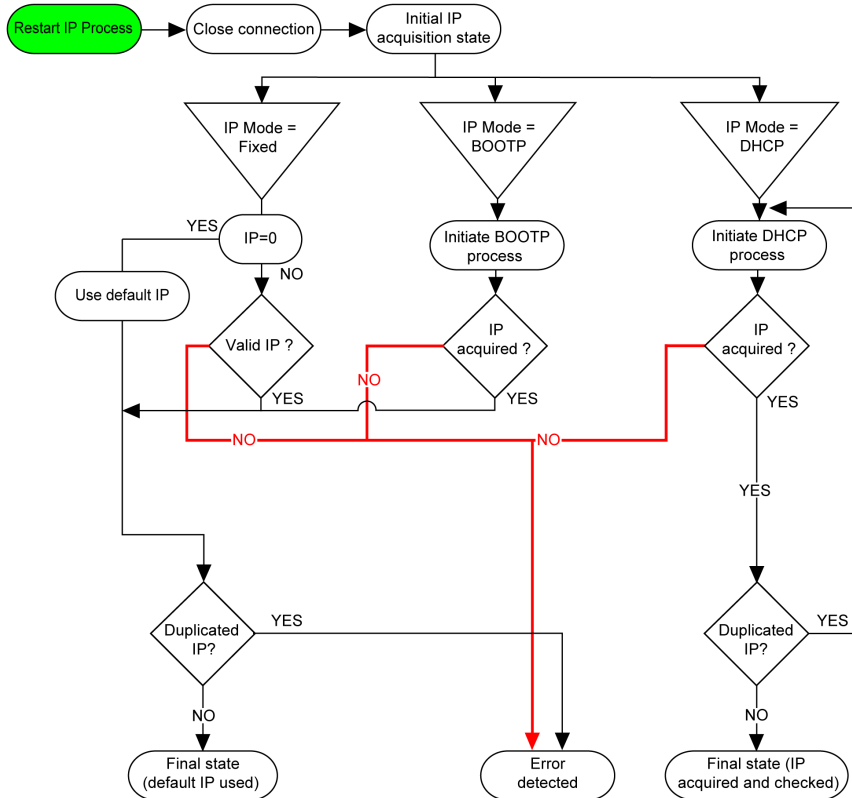

**NOTE:** If a device programmed to use the DHCP or BOOTP addressing methods is unable to contact its respective server, the module uses the default IP address. It will, however, constantly repeat its request.

The IP process automatically restarts in the following cases:

- Controller reboot
- Ethernet cable reconnection
- Application download (if IP parameters change)
- DHCP or BOOTP server detected after a prior addressing attempt was unsuccessful.

## Ethernet Configuration

In the **Devices tree**, double-click **COM\_Bus** → **TM4ES4**:

The screenshot displays the Ethernet Configuration interface, which is divided into several sections:

- Configured Parameters:**
  - Network Name: my\_Device
  - IP Address selection:  IP Address by DHCP,  IP Address by BOOTP,  fixed IP Address
  - IP Address: 95 . 16 . 221 . 17
  - Subnet Mask: 255 . 0 . 0 . 0
  - Gateway Address: 0 . 0 . 0 . 0
  - Ethernet Protocol: Ethernet 2
  - Transfer Rate: Auto
- Current Settings:**
  - Network Name: my\_Device
  - IP Address selection:  IP Address by DHCP,  IP Address by BOOTP,  fixed IP Address
  - IP Address: 95 . 16 . 221 . 17
  - Subnet Mask: 255 . 0 . 0 . 0
  - Gateway Address: 0 . 0 . 0 . 0
  - Ethernet Protocol: Ethernet 2
  - Transfer Rate: 100 MBit full
- Security Parameters (Left):**
  - Protocol inactive: FTP Server, IP Forwarding, Modbus Server, SNMP protocol, Web Visualisation protocol
  - Protocol active: Discovery protocol, Machine Expert protocol, Web Server (HTTP)
- Security Parameters (Right):**
  - Protocol inactive: FTP Server, IP Forwarding, Modbus Server, SNMP protocol, Web Visualisation protocol
  - Protocol active: Discovery protocol, Machine Expert protocol, Web Server (HTTP)
- Slave device identification:**
  - DHCP Server active
  - When active, each device that will be added to the fieldbus, can be configured in order to be identified by its name or MAC Address, instead of its IP Address.
- Adapter Status:**
  - MAC Address: 00:80:F4:0B:2E:45
  - Network Status: Data Exchanges

**Note:** If you are in online mode, you see the two windows. You cannot edit them. If you are in offline mode, you see the **Configured Parameters** window. You can edit it.

The configured parameters are explained as below:

Configured Parameters	Description
<b>Network Name</b>	Used as device name to retrieve IP address through DHCP, maximum 16 characters
<b>IP Address by DHCP</b>	IP address is obtained via DHCP.
<b>IP Address by BOOTP</b>	IP address is obtained via BOOTP.
<b>Fixed IP Address</b>	IP address, subnet mask and gateway address are defined by the user.
<b>Ethernet Protocol</b>	Protocol type used (Ethernet 2)
<b>Transfer Rate</b>	Transfer rate and direction on the bus are automatically configured.
<b>Security Parameters</b>	Security Parameters ( <i>see page 25</i> )

### Default IP Address

The IP address by default is 11.11.x.x.

The last 2 fields in the default IP address are composed of the decimal equivalent of the last 2 hexadecimal bytes of the MAC address of the module.

The MAC address of the module can be retrieved at the bottom of the front face of the module.

The default subnet mask is 255.0.0.0.

**NOTE:** A MAC address is always written in hexadecimal format, and an IP address in decimal format. You must convert the MAC address to decimal format.

Example: If the MAC address is 00.80.F4.01.80.F2, the default IP address is 11.11.128.242.

**NOTE:** To take into account the new IP address after the download of a project, reboot the controller by doing a power cycle.

### Subnet Mask

The subnet mask is used to address several physical networks with a single network address. The mask is used to separate the subnetwork and the device address in the host ID.

The subnet address is obtained by retaining the bits of the IP address that correspond to the positions of the mask containing 1, and replacing the others with 0.

Conversely, the subnet address of the host device is obtained by retaining the bits of the IP address that correspond to the positions of the mask containing 0, and replacing the others with 1.

Example of a subnet address:

IP address	192 (11000000)	1 (00000001)	17 (00010001)	11 (00001011)
Subnet mask	255 (11111111)	255 (11111111)	240 (11110000)	0 (00000000)
Subnet address	192 (11000000)	1 (00000001)	16 (00010000)	0 (00000000)

**NOTE:** The device does not communicate on its subnetwork when there is no gateway.

### Gateway

The gateway allows a message to be routed to a device which is not on the current network.

If there is no gateway, the gateway address is 0.0.0.0.



## Security Parameters

Security Parameters	Description	Default settings
<b>Machine Expert protocol</b>	Allows you to deactivate the Machine Expert protocol on Ethernet interfaces. When deactivated, every Machine Expert request from every device will be rejected, including those from the UDP or TCP connection. This means that no connection is possible on Ethernet from a PC with Machine Expert, from a HMI target that wants to exchange variables with this controller, from an OPC server, or from Controller Assistant.	Active
<b>Modbus Server</b>	Allows you to deactivate the Modbus Server of the logic controller. When deactivated, every Modbus request to the Logic Controller is ignored.	Inactive
<b>Web Server (HTTP)</b>	Allows you to deactivate the Web Server of the logic controller. When deactivated, every HTTP request to the logic controller Web server is ignored.	Active
<b>FTP Server</b>	Allows you to deactivate the FTP Server of the logic controller. When deactivated, every FTP request is ignored.	Inactive
<b>Discovery protocol</b>	Allows you to deactivate Discovery protocol. When deactivated, every Discovery request is ignored.	Active
<b>SNMP protocol</b>	Allows you to deactivate SNMP server of the logic controller. When deactivated, every SNMP request is ignored.	Inactive
<b>WebVisualization protocol</b>	Allows you to deactivate the Web visualization pages of the logic controller. When deactivated, every HTTP requests to the logic controller Webvisualisation protocol is ignored.	Inactive
<b>IP Forwarding</b>	Allows you to deactivate the IP forwarding service of the logic controller. When deactivated, devices on the device network are no longer accessible from the control network (Web pages, DTM, and so on).  <b>NOTE:</b> This parameter is only available on the Ethernet_1 network.	Inactive

## Modbus TCP Server/Client

### Introduction

Unlike Modbus serial link, Modbus TCP/IP is not based on a hierarchical structure, but on a client/server model.

The TM4ES4 module implements both client and server services so that it can initiate communications to other controllers and I/O devices, and to respond to requests from other controllers, SCADA, HMIs and other devices. By default, Modbus Server functionality is not active.

Without any configuration, the TM4ES4 module supports Modbus server.

The Modbus Server/Client is included in the firmware, and does not require any programming action from the user. Due to this feature, it is accessible in RUNNING, STOPPED and EMPTY states.

### Modbus TCP Client

The Modbus TCP client supports the following function blocks from the PLCCommunication library without any configuration:

- ADDM
- READ\_VAR
- SEND\_RECV\_MSG
- SINGLE\_WRITE
- WRITE\_READ\_VAR
- WRITE\_VAR

For further information, refer to the Function Block Descriptions (*see EcoStruxure Machine Expert, Modbus and ASCII Read/Write Functions, PLCCommunication Library Guide*).

### Modbus TCP Server

The Modbus server supports the following Modbus requests:

Function Code Dec (Hex)	Sub-function Dec (Hex)	Function
1 (1h)		Read digital outputs (%Q)
2 (2h)		Read digital inputs (%I)
3 (3h)		Read holding register (%MW)
6 (6h)		Write single register (%MW)
8 (8h)		Diagnostic
15 (Fh)		Write multiple digital outputs (%Q)
16 (10h)		Write multiple registers (%MW)
23 (17h)		Read/write multiple registers (%MW)
43 (2Bh)	14 (Eh)	Read device identification

## Diagnostic Request

The table contains the Data Selection Code list:

Data Selection Code	Description
0x00	Reserved
0x01	Basic Network Diagnostics
0x02	Ethernet Port Diagnostic
0x03	Modbus TCP/Port 502 Diagnostics
0x04	Modbus TCP/Port 502 Connection Table
0x05 - 0x7E	Reserved for other public codes
0x7F	Data Structure Offsets

## Web Server

### Introduction

As standard equipment, the controller provides an embedded Web server with a predefined, built-in website. You can use the pages of the website for module setup and control as well as application diagnostics and monitoring. These pages are ready to use with a Web browser. No configuration or programming is required.

The Web server can be accessed by the web browsers listed below:

- Google Chrome (version 30.0 or greater)
- Mozilla Firefox (version 1.5 or greater)

The Web server can maintain 10 simultaneous open sessions (*see Modicon M241 Logic Controller, Programming Guide*).

**NOTE:** The Web server can be disabled by unchecking the **Web Server active** parameter in the Ethernet Configuration tab.

The Web server is a tool for reading and writing data, and controlling the state of the controller, with full access to all data in your application. However, if there are security concerns over these functions, you must at a minimum assign a secure password to the Web Server or disable the Web server to prevent unauthorized access to the application. By enabling the Web server, you enable these functions.

The Web server allows you to monitor a controller and its application remotely, to perform various maintenance activities including modifications to data and configuration parameters, and change the state of the controller. Care must be taken to ensure that the immediate physical environment of the machine and process is in a state that will not present safety risks to people or property before exercising control remotely.

## WARNING

### UNINTENDED EQUIPMENT OPERATION

- Configure and install the RUN/STOP input for the application, if available for your particular controller, so that local control over the starting or stopping of the controller can be maintained regardless of the remote commands sent to the controller.
- Define a secure password for the Web Server and do not allow unauthorized or otherwise unqualified personnel to use this feature.
- Ensure that there is a local, competent, and qualified observer present when operating on the controller from a remote location.
- You must have a complete understanding of the application and the machine/process it is controlling before attempting to adjust data, stopping an application that is operating, or starting the controller remotely.
- Take the precautions necessary to assure that you are operating on the intended controller by having clear, identifying documentation within the controller application and its remote connection.

**Failure to follow these instructions can result in death, serious injury, or equipment damage.**

**NOTE:** The Web server must only be used by authorized and qualified personnel. A qualified person is one who has the skills and knowledge related to the construction and operation of the machine and the process controlled by the application and its installation, and has received safety training to recognize and avoid the hazards involved. No responsibility is assumed by Schneider Electric for any consequences arising out of the use of this feature.

## Web Server Access

Access to the Web server is controlled by User Rights when they are enabled in the controller. For more information, refer to **Users and Groups** Tab Description (*see Modicon M241 Logic Controller, Programming Guide*).

To access the Web server you must first connect to the controller with EcoStruxure Machine Expert or Controller Assistant and modify the default user password.

### **WARNING**

#### **UNAUTHORIZED DATA ACCESS**

- Secure access to the FTP/Web server using User Rights.
- If you disable User Rights, disable the FTP/Web server to prevent any unwanted or unauthorized access to data in your application.

**Failure to follow these instructions can result in death, serious injury, or equipment damage.**

In order to change the password, go to **Users and Groups** tab of the device editor. For more information, refer to the EcoStruxure Machine Expert Programming Guide.

**NOTE:** The only way to gain access to a controller that has user access-rights enabled and for which you do not have the password(s) is by performing an Update Firmware operation. This clearing of User Rights can only be accomplished by using a SD card or USB key (depending on the support of your particular controller) to update the controller firmware. In addition, you may clear the User Rights in the controller by running a script (for more information, refer to EcoStruxure Machine Expert Programming Guide) . This effectively removes the existing application from the controller memory, but restores the ability to access the Controller.

### Home Page Access

To access the website home page, type in your navigator the IP address of the controller.

This figure shows the Web Server site login page:

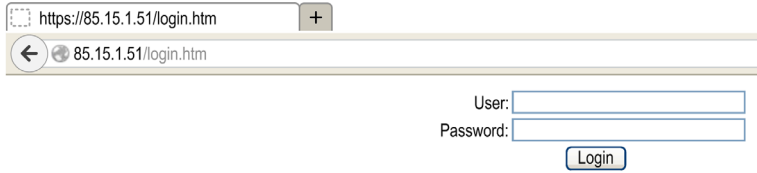

This figure shows the home page of the Web Server site once you have logged in:



**NOTE:** Schneider Electric adheres to industry best practices in the development and implementation of control systems. This includes a "Defense-in-Depth" approach to secure an Industrial Control System. This approach places the controllers behind one or more firewalls to restrict access to authorized personnel and protocols only.

 **WARNING**

**UNAUTHENTICATED ACCESS AND SUBSEQUENT UNAUTHORIZED MACHINE OPERATION**

- Evaluate whether your environment or your machines are connected to your critical infrastructure and, if so, take appropriate steps in terms of prevention, based on Defense-in-Depth, before connecting the automation system to any network.
- Limit the number of devices connected to a network to the minimum necessary.
- Isolate your industrial network from other networks inside your company.
- Protect any network against unintended access by using firewalls, VPN, or other, proven security measures.
- Monitor activities within your systems.
- Prevent subject devices from direct access or direct link by unauthorized parties or unauthenticated actions.
- Prepare a recovery plan including backup of your system and process information.

**Failure to follow these instructions can result in death, serious injury, or equipment damage.**



## Monitoring: Data Parameters

### Monitoring Web Server Variables

To monitor Web server variables, you must add a **Web Data Configuration** object to your project. Within this object, you can select all variables you want to monitor.

This table describes how to add a **Web Data Configuration** object:

Step	Action
1	Right click the <b>Application</b> node in the <b>Applications tree</b> tab.
2	Click <b>Add Object → Web Data Configuration...</b> <b>Result:</b> The <b>Add Web Data Configuration</b> window is displayed.
3	Click <b>Add</b> . <b>Result:</b> The <b>Web Data Configuration</b> object is created and the <b>Web Data Configuration</b> editor is open. <b>NOTE:</b> As a <b>Web Data Configuration</b> object is unique for a controller, its name cannot be changed.

### Web Data Configuration Editor

Click the **Refresh** button to be able to select variables, this action will display all the variables defined in the application.

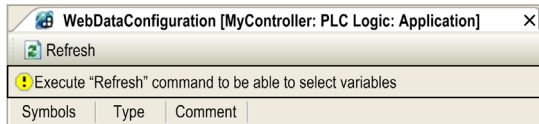

Select the variables you want to monitor in the web server:

Symbols	Type	Comment
<input checked="" type="checkbox"/> IoConfig_Globals_Mapping		
<input checked="" type="checkbox"/> ixDI_0_0 (%IX0.0)	Bool	DI : Fast input, Sink/Source
<input type="checkbox"/> ixDI_1_1 (%IX0.1)	Bool	DI : Fast input, Sink/Source
<input type="checkbox"/> ixDI_2_2 (%IX0.2)	Bool	DI : Fast input, Sink/Source
<input type="checkbox"/> ixDI_3_3 (%IX0.3)	Bool	DI : Fast input, Sink/Source
<input type="checkbox"/> ixDI_4_4 (%IX0.4)	Bool	DI : Fast input, Sink/Source
<input type="checkbox"/> ixDI_5_5 (%IX0.5)	Bool	DI : Fast input, Sink/Source
<input checked="" type="checkbox"/> ixDI_6_6 (%IX0.6)	Bool	DI : Fast input, Sink/Source
<input type="checkbox"/> ixDI_7_7 (%IX0.7)	Bool	DI : Fast input, Sink/Source
<input type="checkbox"/> ixDI_8_8 (%IX1.0)	Bool	DI : Regular input, Sink/Source
<input type="checkbox"/> ixDI_9_9 (%IX1.1)	Bool	DI : Regular input, Sink/Source
<input type="checkbox"/> ixDI_10_10 (%IX1.2)	Bool	DI : Regular input, Sink/Source
<input type="checkbox"/> ixDI_11_11 (%IX1.3)	Bool	DI : Regular input, Sink/Source
<input type="checkbox"/> ixDI_12_12 (%IX1.4)	Bool	DI : Regular input, Sink/Source
<input type="checkbox"/> ixDI_13_13 (%IX1.5)	Bool	DI : Regular input, Sink/Source
<input type="checkbox"/> ixDI_10_1 (%IX2.0)	Bool	DI : Short Circuit detected (if True)
<input type="checkbox"/> qxDQ_Q0 (%QX0.0)	Bool	DQ : Fast output, Push/pull
<input type="checkbox"/> qxDQ_Q1 (%QX0.1)	Bool	DQ : Fast output, Push/pull
<input type="checkbox"/> qxDQ_Q2 (%QX0.2)	Bool	DQ : Fast output, Push/pull
<input checked="" type="checkbox"/> qxDQ_Q3 (%QX0.3)	Bool	DQ : Fast output, Push/pull
<input type="checkbox"/> qxDQ_Q4 (%QX0.4)	Bool	DQ : Regular output
<input type="checkbox"/> qxDQ_Q5 (%QX0.5)	Bool	DQ : Regular output
<input type="checkbox"/> qxDQ_Q6 (%QX0.6)	Bool	DQ : Regular output
<input type="checkbox"/> qxDQ_Q7 (%QX0.7)	Bool	DQ : Regular output
<input type="checkbox"/> qxDQ_Q8 (%QX1.0)	Bool	DQ : Regular output
<input checked="" type="checkbox"/> qxDQ_Q9 (%QX1.1)	Bool	DQ : Regular output
<input type="checkbox"/> qxDQ_Q0_1 (%QX2.0)	Bool	DQ : Rearming Command (on rising edge)
<input type="checkbox"/> qxModule_2_Q0 (%QX4.0)	Bool	Module_2 :
<input type="checkbox"/> qxModule_2_Q1 (%QX4.1)	Bool	Module_2 :
<input type="checkbox"/> qxModule_2_Q2 (%QX4.2)	Bool	Module_2 :
<input type="checkbox"/> qxModule_2_Q3 (%QX4.3)	Bool	Module_2 :
<input type="checkbox"/> qxModule_2_Q4 (%QX4.4)	Bool	Module_2 :
<input type="checkbox"/> qxModule_2_Q5 (%QX4.5)	Bool	Module_2 :
<input type="checkbox"/> qxModule_2_Q6 (%QX4.6)	Bool	Module_2 :
<input type="checkbox"/> qxModule_2_Q7 (%QX4.7)	Bool	Module_2 :
<input type="checkbox"/> qxModule_2_Q8 (%QX5.0)	Bool	Module_2 :
<input type="checkbox"/> qxModule_2_Q9 (%QX5.1)	Bool	Module_2 :
<input type="checkbox"/> qxModule_2_Q10 (%QX5.2)	Bool	Module_2 :
<input type="checkbox"/> qxModule_2_Q11 (%QX5.3)	Bool	Module_2 :
<input type="checkbox"/> qxModule_2_Q12 (%QX5.4)	Bool	Module_2 :
<input type="checkbox"/> qxModule_2_Q13 (%QX5.5)	Bool	Module_2 :
<input type="checkbox"/> qxModule_2_Q14 (%QX5.6)	Bool	Module_2 :
<input type="checkbox"/> qxModule_2_Q15 (%QX5.7)	Bool	Module_2 :
<input checked="" type="checkbox"/> GVL		
<input checked="" type="checkbox"/> count	Int	

**NOTE:** The variable selection is possible only in offline mode.

### Monitoring: Data Parameters Submenu

The **Data Parameters** submenu allows you to create and monitor some lists of variables. You can create several lists of variables (maximum 10 lists), each one containing several variables of the controller application (maximum 20 variables per list).

Each list has a name, and a refresh period. The lists are saved in the Flash memory of the controller, so that a created list can be accessed (loaded, modified, saved) from any Web client application accessing this controller.

The **Data Parameters** submenu allows you to display and modify variable values:

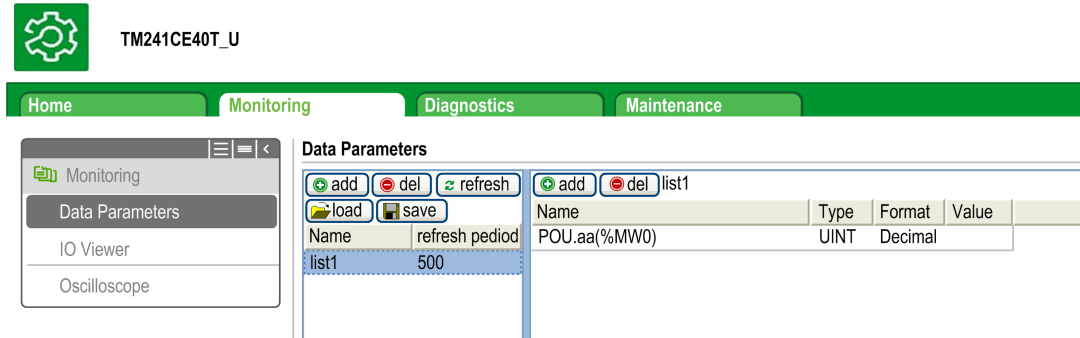

Element	Description
<b>Add</b>	Adds a list description or a variable
<b>Del</b>	Deletes a list description or a variable
<b>Refresh period</b>	Refreshing period of the variables contained in the list description (in ms)
<b>Refresh</b>	Enables I/O refreshing: <ul style="list-style-type: none"> <li>● Gray button: refreshing disabled</li> <li>● Orange button: refreshing enabled</li> </ul>
<b>Load</b>	Loads saved lists from the controller internal Flash to the Web server page
<b>Save</b>	Saves the selected list description in the controller ( <i>/usr/web</i> directory)

**NOTE:** The IEC objects (%IX, %QX) are not directly accessible. To access IEC objects you must first group their contents in located registers (refer to Relocation Table (*see Modicon M241 Logic Controller, Programming Guide*)).

**NOTE:** Bit memory variables (%MX) cannot be selected.

### Monitoring: IO Viewer Submenu

The **IO Viewer** submenu allows you to display and modify the current I/O values:

The screenshot shows the IO Viewer interface for device TM241CE40T\_U. The interface includes a navigation menu on the left with options: Monitoring, Data Parameters, IO Viewer (selected), and Oscilloscope. The main display area is titled 'IO Viewer' and features a refresh button (orange), a refresh rate of 1000 ms, and navigation arrows. Below this is a table with 5 columns: Mapping, Address, Type, Format, and Value. The table lists 20 I/O mappings (ixDI\_10 to ixDI\_19) with their respective addresses, types (BOOL), and current values (Boolean false).

Mapping	Address	Type	Format	Value
ixDI_10	%IX0.0	BOOL	Boolean	false
ixDI_11	%IX0.1	BOOL	Boolean	false
ixDI_12	%IX0.2	BOOL	Boolean	false
ixDI_13	%IX0.3	BOOL	Boolean	false
ixDI_14	%IX0.4	BOOL	Boolean	false
ixDI_15	%IX0.5	BOOL	Boolean	false
ixDI_16	%IX0.6	BOOL	Boolean	false
ixDI_17	%IX0.7	BOOL	Boolean	false
ixDI_18	%IX1.0	BOOL	Boolean	false
ixDI_19	%IX1.1	BOOL	Boolean	false
ixDI_110	%IX1.2	BOOL	Boolean	false
ixDI_111	%IX1.3	BOOL	Boolean	false
ixDI_112	%IX1.4	BOOL	Boolean	false
ixDI_113	%IX1.5	BOOL	Boolean	false
ixDI_114	%IX1.6	BOOL	Boolean	false
ixDI_115	%IX1.7	BOOL	Boolean	false
ixDI_116	%IX2.0	BOOL	Boolean	false
ixDI_117	%IX2.1	BOOL	Boolean	false
ixDI_118	%IX2.2	BOOL	Boolean	false
ixDI_119	%IX2.3	BOOL	Boolean	false

Element	Description
<b>Refresh</b>	Enables I/O refreshing: <ul style="list-style-type: none"> <li>● Gray button: refreshing disabled</li> <li>● Orange button: refreshing enabled</li> </ul>
<b>1000 ms</b>	I/O refreshing period in ms
<<	Goes to previous I/O list page
>>	Goes to next I/O list page

**Monitoring: Oscilloscope Submenu**

The **Oscilloscope** submenu can display up to 2 variables in the form of a recorder time chart:



TM241CE40T\_U

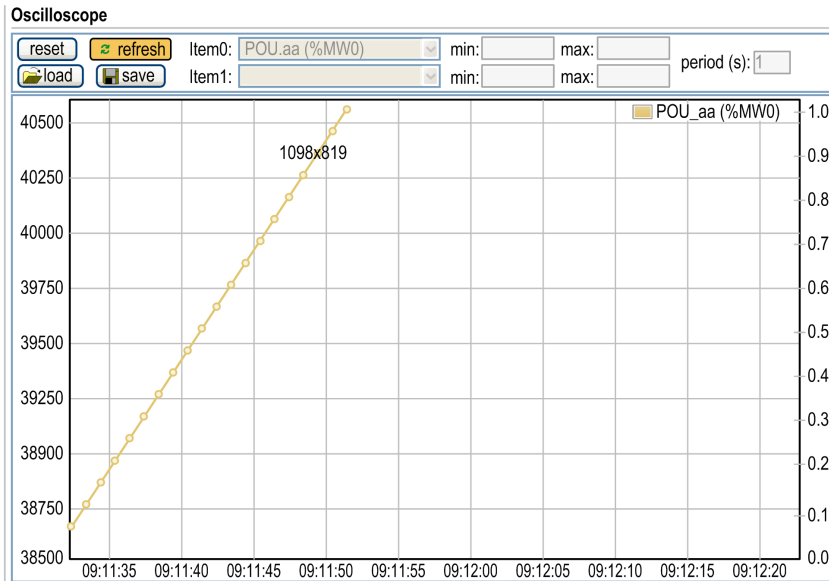
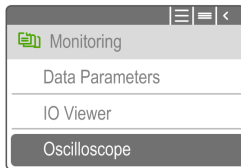

Element	Description
<b>Reset</b>	Erases the memorization
<b>Refresh</b>	Starts/stops refreshing
<b>Load</b>	Loads parameter configuration of Item0 and Item1
<b>Save</b>	Saves parameter configuration of Item0 and Item1 in the controller
<b>Item0</b>	Variable to be displayed
<b>Item1</b>	Variable to be displayed
<b>Min</b>	Minimum value of the variable axis
<b>Max</b>	Maximum value of the variable axis
<b>Period(ms)</b>	Page refresh period in milliseconds

**Diagnostics: Ethernet Submenu**

This figure shows the remote ping service:

The screenshot shows the web interface for the TM4ES4 Ethernet Module. At the top, there is a navigation bar with tabs for Home, Monitoring, Diagnostics (selected), and Maintenance. A 'Log Out' button is located on the right side of the navigation bar. Below the navigation bar, the page title is 'Ethernet'. On the left side, there is a sidebar menu with options: Diagnostics (selected), Controller, TM3 Expansion, Ethernet, Serial, Scanner Status, and EtherNet/IP Status. The main content area is divided into two sections: 'Remote Ping Service' and 'Statistics'. The 'Remote Ping Service' section contains a text input field for the IP address and a 'Ping' button. The 'Statistics' section contains a 'Reset Statistics' button and two columns of data. The first column is for 'Ethernet\_1' and the second is for 'TM4ES4'. Each column lists various network statistics such as MAC address, IP address, Subnet mask, Gateway address, and Link status. Below these columns are two more sections: 'Ethernet statistics' and 'Modbus statistics', each listing specific performance metrics.

**TM241CEC24T\_U**

Home Monitoring **Diagnostics** Maintenance Log Out

**Ethernet**

**Remote Ping Service**

Enter IP address to ping from Controller:

**Statistics**

Ethernet_1	TM4ES4
MAC address 00.80.F4.0B.2E.45	MAC address 00.80.F4.0A.62.F2
IP address 192.168.12.6	IP address 85.72.59.6
Subnet mask 255.255.255.0	Subnet mask 255.0.0.0
Gateway address 0.0.0.0	Gateway address 0.0.0.0
Status Link up (1)	Status Link down (1)

Ethernet statistics	Modbus statistics
Opened Top connections 7	Messages transmitted OK 16
Frames transmitted OK 2134905	Messages received OK 16
Frames received OK 5699343	Error messages 0
Buffers transmitted NOK 0	IpMaster connection status Not connected (1)
Buffers received NOK 0	IpMaster timeout event counter 0

Ethernet IP statistics
IO Messages transmitted 0
IO Messages received 0

**Diagnostics: Scanner Status Submenu**

The **Scanner Status** submenu displays status of the Modbus TCP I/O Scanner (IDLE, STOPPED, OPERATIONAL) and the health bit of up to 64 Modbus slave devices:

**Modbus TCP I/O Scanner**

Scanner Status

 Idle

Connection Statistics

Total transmissions sent: **0**

Number of Configured Connections: **0**

Scanned Device Statuses

No Scanned Devices Reported

- Not Configured  
  Scanned  
  Fault

For more information, refer to EcoStruxure Machine Expert Modbus TCP User guide.

### Diagnostics: EtherNet/IP Status Submenu

The **EtherNet/IP Status** submenu displays the status of the EtherNet/IP Scanner (IDLE, STOPPED, OPERATIONAL) and the health bit of up to 16 EtherNet/IP target devices:

#### EIP I/O Scanner

---

**Scanner Status**

 Idle

**Connection Statistics**

Total transmissions sent: **0**

Number of Configured Connections: **0**

**Scanned Device Statuses**

No Scanned Devices Reported

Not Configured     Scanned     Fault

For more information, refer to EcoStruxure Machine Expert EtherNet/IP User guide.

### Maintenance Page

The Maintenance page provides access to the controller data for maintenance capabilities.



### Maintenance: Post Conf Submenu

The **Post Conf** submenu allows you to update the post configuration file (see *Modicon M241 Logic Controller, Programming Guide*) saved on the controller:

The screenshot shows the web interface for the TM241CEC24T\_U controller. At the top, there is a navigation bar with tabs for Home, Monitoring, Diagnostics, and Maintenance. A 'Log Out' button is located on the right. On the left, a sidebar menu is open to the 'Maintenance' section, with 'Post Conf' selected. The main content area is titled 'Post Conf' and contains a 'Load' button, a 'Save' button, and the text 'Post Conf loaded'. Below this is a text area containing the following configuration parameters:

```
# Ethernet / IPAddress
# Ethernet IP address
id[111].param[0] = [0, 0, 0, 0]

# Ethernet / SubnetMask
# Ethernet IP mask
id[111].param[1] = [0, 0, 0, 0]

# Ethernet / GatewayAddress
# Ethernet IP gateway address
id[111].param[2] = [0, 0, 0, 0]

# Ethernet / IPConfigMode
# IP configuration mode: 0:FIXED 1:BOOTP 2:DHCP
id[111].param[4] = 2

# Ethernet / Device Name
# Name of the device on the Ethernet network
id[111].param[5] = 'my_Device'
```

Step	Action
1	Click <b>Load</b> .
2	Modify the parameters.
3	Click <b>Save</b> . <b>NOTE:</b> The new parameters will be considered at next Post Configuration file reading (see <i>Modicon M241 Logic Controller, Programming Guide</i> ).

### Log Files

This page provided access to the `/usr/Syslog/` folder of the controller flash memory.

### Maintenance: EIP Config Files Submenu

The file tree only appears when the Ethernet IP service is configured on the controller.

Index of /usr:

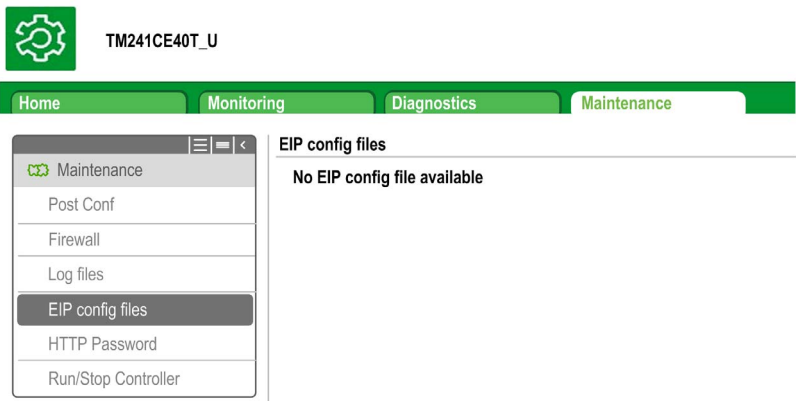

File	Description
My Machine Controller.gz	GZIP file
My Machine Controller.ico	Icon file
My Machine Controller.eds	Electronic Data Sheet file

### Maintenance: User Management Submenu

The **User Management** submenu displays a screen that allows you to access four different actions, all restricted by using secure protocol (HTTPS):

- **Change password (of current user):**

allows you to change your password.

**Change password (of current user)**

Current password

New password

Confirm new password

Caution: only allowed when connected using a secure protocol.

- **User accounts management:**

Allows you to manage user accounts management, removing all password and returning all user accounts on the controller to default settings.

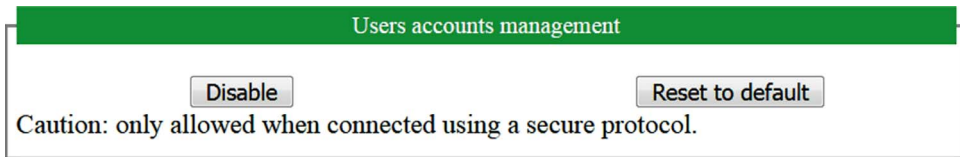

Click **Disable** to remove all passwords on the controller.

Click **OK** on the window that appears to confirm. As a result:

- Users no longer have to set and enter a password to connect to the controller.
- FTP, HTTP, and OPC UA Server connections accept anonymous user connections.
- Cloning the controller no longer requires authorization by using the FB\_ControlClone function block (see *Modicon M241 Logic Controller, System Functions and Variables, PLCSystem Library Guide*).

**NOTE:** The **Disable** button is only active if the current user has administrative privileges.

Click **Reset to default** to return all user accounts on the controller to their default setting state.

Click **OK** on the window that appears to confirm.

**NOTE:** Connections to FTP, HTTP, and the OPC UA Server are blocked until a new password is set.

- **Clone management:**

allows you to control whether user rights are copied and applied to the target controller when cloning a controller

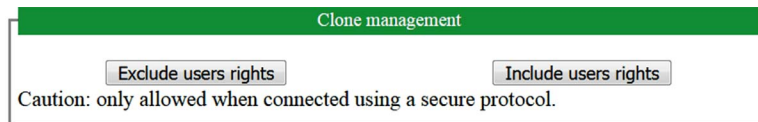

Click **Exclude users rights** to exclude copying user rights to the target controller when cloning a controller.

**NOTE:** By default, the users rights are excluded.

Click **Include users rights** to copy user rights to the target controller when cloning a controller. A popup prompts you to confirm copying the user rights. Click **OK** to continue.

**NOTE:** The **Exclude users rights** and **Include users rights** buttons are only active if the current user is connected to the controller using a secure protocol.

- **System use notification:**

allows you to customize a message which will be displayed at login.

The screenshot shows a web-based configuration interface for the 'System use notification'. At the top, there is a green header bar with the text 'System use notification'. Below the header, the interface is divided into two main sections: 'Current:' and 'New:'. The 'Current:' section contains a large, empty gray rectangular area, likely representing the current notification message. The 'New:' section contains a large, empty white rectangular area, likely representing the new notification message. At the bottom of the interface, there are three buttons: 'Save', 'Disable', and 'Default', arranged horizontally from left to right.

## FTP Server

### Introduction

Any FTP client installed on a computer that is connected to the controller (Ethernet port), without EcoStruxure Machine Expert installed, can be used to transfer files to and from the data storage area of the controller.

**NOTE:** Schneider Electric adheres to industry best practices in the development and implementation of control systems. This includes a "Defense-in-Depth" approach to secure an Industrial Control System. This approach places the controllers behind one or more firewalls to restrict access to authorized personnel and protocols only.

### WARNING

#### **UNAUTHENTICATED ACCESS AND SUBSEQUENT UNAUTHORIZED MACHINE OPERATION**

- Evaluate whether your environment or your machines are connected to your critical infrastructure and, if so, take appropriate steps in terms of prevention, based on Defense-in-Depth, before connecting the automation system to any network.
- Limit the number of devices connected to a network to the minimum necessary.
- Isolate your industrial network from other networks inside your company.
- Protect any network against unintended access by using firewalls, VPN, or other, proven security measures.
- Monitor activities within your systems.
- Prevent subject devices from direct access or direct link by unauthorized parties or unauthenticated actions.
- Prepare a recovery plan including backup of your system and process information.

**Failure to follow these instructions can result in death, serious injury, or equipment damage.**

**NOTE:** Make use of the security-related commands which provide a way to add, edit, and remove a user in the online user management of the target device where you are currently logged in.

The FTP server is deactivated by default.

### FTP Access

Access to the FTP server is controlled by User Rights when they are enabled in the controller. For more information, refer to **Users and Groups** Tab Description.

To access the FTP server you must first connect to the controller with EcoStruxure Machine Expert or Controller Assistant and modify the default user password.

### Files Access

See File Organization.

## SNMP

### Introduction

The Simple Network Management Protocol (SNMP) is used to provide the data and services required for managing a network.

The data is stored in a Management Information Base (MIB). The SNMP protocol is used to read or write MIB data. Implementation of the Ethernet SNMP services is minimal, as only the compulsory objects are handled.

M241 controllers support the standard MIB-2 objects.

### SNMP Server

This table presents the supported standard MIB-2 server objects:

Object	Description	Access	Default Value
sysDescr	Text description of the device	Read	SCHNEIDER M241-51 Fast Ethernet TCP/IP
sysName	Node administrative name	Read/Write	Controller reference

The values written are saved to the controller via SNMP client tool software. The Schneider Electric software for this is ConneXview. ConneXview is not supplied with the controller. For more details, refer to [www.schneider-electric.com](http://www.schneider-electric.com).

The size of these character strings is limited to 50 characters.

### SNMP Client

The M251 Logic Controller includes an SNMP client library to allow you to query SNMP servers. For details, refer to the SNMP Library Guide.

## M241 Logic Controller as a Target Device on EtherNet/IP

### Introduction

This section describes the configuration of the M241 Logic Controller as an EtherNet/IP target device.

For further information about EtherNet/IP, refer to the [www.odva.org](http://www.odva.org) website.

### EtherNet/IP Target Configuration

To configure your M241 Logic Controller as an EtherNet/IP target device, you must add an EtherNet/IP manager to your controller. Select **EthernetIP** in the hardware catalog, drag it to the Devices tree, and drop it on one of the highlighted nodes.

### EtherNet/IP Parameter Configuration

To configure the EtherNet/IP parameters, double-click **COM\_Bus** → **TM4ES4** → **EthernetIP** in the Devices tree.

This dialog box is displayed:

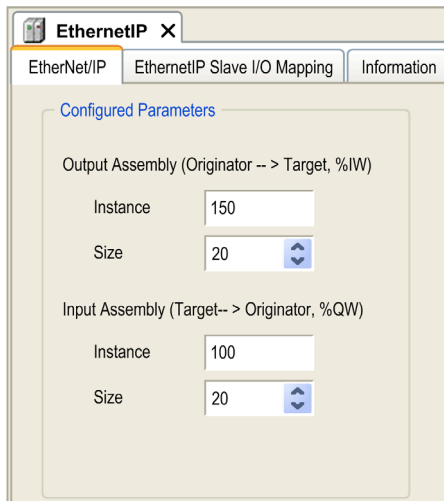

The EtherNet/IP configuration parameters are defined as:

- **Instance:**  
Number referencing the input or output Assembly.
- **Size:**  
Number of channels of an input or output Assembly.  
The memory size of each channel is 2 bytes that stores the value of an %IWx or %QWx object, where x is the channel number.  
For example, if the **Size of the Output Assembly** is 20, it represents that there are 20 input channels (IW0...IW19) addressing %IWy...%IW(y+20-1), where y is the first available channel for the Assembly.

Element		Admissible Controller Range	EcoStruxure Machine Expert Default Value
Output Assembly	Instance	150...189	150
	Size	2...40	20
Input Assembly	Instance	100...149	100
	Size	2...40	20

### EDS File Generation

You can generate an EDS file to facilitate configuring EtherNet/IP cyclic data exchanges.

To generate the EDS file:

Step	Action
1	In the <b>Devices tree</b> , right-click the <b>EthernetIP</b> node and choose the <b>Export as EDS</b> command from the context menu.
2	Modify the default file name and location as required.
3	Click <b>Save</b> .

**NOTE:** The **Major Revision** and **Minor Revision** objects in the EDS file are used to ensure uniqueness of the EDS file. The values of these objects do not reflect the actual controller revision level.

Generic M241 Logic Controller and M251 Logic Controller EDS files are also available on the Schneider website. You must adapt the EDS file to your application. To do so, edit it and define the Assembly instances and sizes.



### EthernetIP Slave I/O Mapping Tab

Variables can be defined and named in the **EthernetIP Slave I/O Mapping** tab. Additional information such as topological addressing is also provided in this tab.

EthernetIP Slave I/O Mapping							
Channels							
Variable	Mapping	Channel	Address	Type	Default Value	Unit	Description
Input							Input
		IW0	%IW9	WORD			
		Bit0	%IX18.0	BOOL	FALSE		
		Bit1	%IX18.1	BOOL	FALSE		
		Bit2	%IX18.2	BOOL	FALSE		
		Bit3	%IX18.3	BOOL	FALSE		
		Bit4	%IX18.4	BOOL	FALSE		
		Bit5	%IX18.5	BOOL	FALSE		
		Bit6	%IX18.6	BOOL	FALSE		
		Bit7	%IX18.7	BOOL	FALSE		
		Bit8	%IX19.0	BOOL	FALSE		
		Bit9	%IX19.1	BOOL	FALSE		
		Bit10	%IX19.2	BOOL	FALSE		
		Bit11	%IX19.3	BOOL	FALSE		
		Bit12	%IX19.4	BOOL	FALSE		
		Bit13	%IX19.5	BOOL	FALSE		
		Bit14	%IX19.6	BOOL	FALSE		
		Bit15	%IX19.7	BOOL	FALSE		
		IW1	%IW10	WORD			
Output							Output
		QW0	%QW3	WORD			
		QW1	%QW4	WORD			
		QW2	%QW5	WORD			
		QW3	%QW6	WORD			
		QW4	%QW7	WORD			

The table below describes the **EthernetIP Slave I/O Mapping** configuration:

Channel		Type	Default Value	Description
Input	IW0	WORD	-	Command word of controller outputs (%QW)
	IWxxx			
Output	QW0	WORD	-	State of controller inputs (%IW)
	QWxxx			

The number of words depends on the size parameter configured in EtherNet/IP Configuration (*see page 47*).

Output means OUTPUT from Originator controller (= %IW for the controller).

Input means INPUT from Originator controller (= %QW for the controller).

### Connections on EtherNet/IP

To access a target device, an Originator opens a connection which can include several sessions that send requests.

One explicit connection uses one session (a session is a TCP or UDP connection).

One I/O connection uses 2 sessions.

The following table shows the EtherNet/IP connections limitations:

Characteristic	Maximum
Explicit connections	8 (Class 3)
I/O connections	1 (Class 1)
Connections	8
Sessions	16
Simultaneous requests	32

**NOTE:** The M241 Logic Controller supports cyclic connections only. If an Originator opens a connection using a change of state trigger type, the connection is not rejected by the controller but packets are sent at the RPI rate.

## Profile

The controller supports the following objects:

Object class	Class ID	Cat.	Number of Instances	Effect on Interface Behavior
Identity Object ( <i>see page 51</i> )	01 hex	1	1	Supports the reset service
Message Router Object ( <i>see page 54</i> )	02 hex	1	1	Explicit message connection
Assembly Object ( <i>see page 55</i> )	04 hex	2	2	Defines I/O data format
Connection Manager Object ( <i>see page 58</i> )	06 hex		1	–
TCP/IP Interface Object ( <i>see page 60</i> )	F5 hex	1	1	TCP/IP configuration
Ethernet Link Object ( <i>see page 62</i> )	F6 hex	1	1	Counter and status information
Interface Diagnostic Object ( <i>see page 63</i> )	350 hex	1	1	–
Scanner Diagnostic Object ( <i>see page 63</i> )	351 hex	1	1	–
Connection Diagnostic Object ( <i>see page 63</i> )	352 hex	1	1	–
Explicit Connection Diagnostic Object ( <i>see page 63</i> )	353 hex	1	1	–

## Identity Object (Class ID = 01 hex)

The following table describes the class attributes of the Identity Object:

Attribute ID	Access	Name	Data Type	Value	Details
1	Get	Revision	UINT	01h	Implementation revision of the Identity Object
2	Get	Max Instances	UINT	01h	The largest instance number
3	Get	Number of Instances	UINT	01h	The number of object instances
4	Get	Optional Instance Attribute List	UINT, UINT [ ]	00h	The first 2 bytes contain the number of optional instance attributes. Each following pair of bytes represents the number of other optional instance attributes.
6	Get	Max Class Attribute	UINT	07h	The largest class attributes value
7	Get	Max Instance Attribute	UINT	07h	The largest instance attributes value

The following table describes the Class Services:

Service Code (hex)	Name	Description
01	Get Attribute All	Returns the value of all class attributes
0E	Get Attribute Single	Returns the value of the specified attribute

The following table describes the Instance Services:

Service Code (hex)	Name	Description
01	Get Attribute All	Returns the value of all class attributes
05	Reset <sup>(1)</sup>	Initializes EtherNet/IP component (controller reboot)
0E	Get Attribute Single	Returns the value of the specified attribute

<sup>(1)</sup> Reset Service description:

When the Identity Object receives a Reset request, it:

- determines whether it can provide the type of reset requested
- responds to the request
- attempts to perform the type of reset requested

The Reset common service has one specific parameter, Type of Reset (USINT), with the following values:

Value	Type of Reset
0	Reboots the controller. <b>NOTE:</b> This value is the default value if this parameter is omitted.
1	Reset Warm.
2	Not supported.
3...99	Reserved
100...199	Vendor specific
200...255	Reserved

The following table describes the Instance attributes:

Attribute ID	Access	Name	Data Type	Value	Details
1	Get	Vendor ID	UINT	243h	Schneider Automation ID
2	Get	Device type	UINT	0Eh	Controller
3	Get	Product code	UINT	1002h	Controller product code
4	Get	Revision	Struct of USINT, USINT	–	Product revision of the controller <sup>(1)</sup> Equivalent to the 2 low bytes of controller version

Attribute ID	Access	Name	Data Type	Value	Details
5	Get	Status	WORD <sup>(2)</sup>	–	See definition in the table below
6	Get	Serial number	UDINT	–	Serial number of the controller XX + 3 LSB of MAC address
7	Get	Product name	Struct of USINT, STRING	–	–

<sup>(1)</sup> Mapped in a WORD:

- MSB: minor revision (second USINT)
- LSB: major revision (first USINT)

Example: 0205h means revision V5.2.

<sup>(2)</sup> Status Description (Attribute 5):

Bit	Name	Description
0	Owned	Unused
1	Reserved	–
2	Configured	TRUE indicates the device application has been reconfigured.
3	Reserved	–
4...7	Extended Device Status	<ul style="list-style-type: none"> <li>● 0: self-testing or undetermined</li> <li>● 1: firmware update in progress</li> <li>● 2: at least one invalid I/O connection detected</li> <li>● 3: no I/O connections established</li> <li>● 4: non-volatile configuration invalid</li> <li>● 5: non recoverable error detected</li> <li>● 6: at least one I/O connection in RUNNING state</li> <li>● 7: at least one I/O connection established, all in idle mode</li> <li>● 8: reserved</li> <li>● 9...15: unused</li> </ul>
8	Minor Recoverable Fault	TRUE indicates the device detected an error, which, under most circumstances, is recoverable. This type of event does not lead to a change in the device state.
9	Minor Unrecoverable Fault	TRUE indicates the device detected an error, which, under most circumstances, is unrecoverable. This type of event does not lead to a change in the device state.
10	Major Recoverable Fault	TRUE indicates the device detected an error, which requires the device to report an exception and enter into the HALT state. This type of event leads to a change in the device state, but, under most circumstances, is recoverable.

Bit	Name	Description
11	Major Unrecoverable Fault	TRUE indicates the device detected an error, which requires the device to report an exception and enter into the HALT state. This type of event leads to a change in the device state, but, under most circumstances, is not recoverable.
12...15	Reserved	–

### Message Router Object (Class ID = 02 hex)

The following table describes the class attributes of the Message Router Object:

Attribute ID	Access	Name	Data Type	Value	Details
1	Get	Revision	UINT	01h	Implementation revision of the Message Router Object
2	Get	Max Instances	UINT	01h	The largest instance number
3	Get	Number of Instance	UINT	01h	The number of object instances
4	Get	Optional Instance Attribute List	Struct of UINT, UINT [ ]	20	The first 2 bytes contain the number of optional instance attributes. Each following pair of bytes represents the number of other optional instance attributes (from 100 to 119).
5	Get	Optional Service List	UINT	00h	The number and list of any implemented optional services attribute (0: no optional services implemented)
6	Get	Max Class Attribute	UINT	07h	The largest class attributes value
7	Get	Max Instance Attribute	UINT	119	The largest instance attributes value

The following table describes the Class Services:

Service Code (hex)	Name	Description
01	Get Attribute All	Returns the value of all class attributes
0E	Get Attribute Single	Returns the value of the specified attribute

The following table describes the Instance Services:

Service Code (hex)	Name	Description
01	Get Attribute All	Returns the value of all class attributes
0E	Get Attribute Single	Returns the value of the specified attribute

The following table describes the Instance attributes:

Attribute ID	Access	Name	Data Type	Value	Description
1	Get	Implemented Object List	Struct of UINT, UINT [ ]	–	Implemented Object list. The first 2 bytes contain the number of implemented objects. Each two bytes that follow represent another implemented class number. This list contains the following objects: <ul style="list-style-type: none"> <li>● Identity</li> <li>● Message Router</li> <li>● Assembly</li> <li>● Connection Manager</li> <li>● Parameter</li> <li>● File Object</li> <li>● Modbus</li> <li>● Port</li> <li>● TCP/IP</li> <li>● Ethernet Link</li> </ul>
2	Get	Number available	UINT	512	Maximum number of concurrent CIP (Class1 or Class 3) connections supported

### Assembly Object (Class ID = 04 hex)

The following table describes the class attributes of the Assembly Object:

Attribute ID	Access	Name	Data Type	Value	Details
1	Get	Revision	UINT	2	Implementation revision of the Assembly Object
2	Get	Max Instances	UINT	189	The largest instance number
3	Get	Number of Instances	UINT	2	The number of object instances
4	Get	Optional Instance Attribute List	Struct of: UINT UINT [ ]	1 4	The first 2 bytes contain the number of optional instance attributes. Each following pair of bytes represents the number of other optional instance attributes.
5	Get	Optional Service List	UINT	00h	The number and list of any implemented optional services attribute (0: no optional services implemented)
6	Get	Max Class Attribute	UINT	07h	The largest class attributes value
7	Get	Max Instance Attribute	UINT	04h	The largest instance attributes value

The following table describes the Class Services:

Service Code (hex)	Name	Description
0E	Get Attribute Single	Returns the value of the specified attribute

The following table describes the Instance Services:

Service Code (hex)	Name	Description
0E	Get Attribute Single	Returns the value of the specified attribute
10	Set Attribute Single	Modifies the value of the specified attribute

### Instances Supported

Output means OUTPUT from Originator controller (= %IW for the controller).

Input means INPUT from Originator controller (= %QW for the controller).

The controller supports 2 Assemblies:

Name	Instance	Data Size
Controller Output (%IW)	Configurable: must be between 100 and 149	2...40 words
Controller Input (%QW)	Configurable: must be between 150 and 189	2...40 words

**NOTE:** The Assembly object binds together the attributes of multiple objects so that information to or from each object can be communicated over a single connection. Assembly objects are static. The Assemblies in use can be modified through the parameter access of the network configuration tool (RSNetWorx). The controller needs to recycle power to register a new Assembly assignment.

The following table describes the Instance attributes:

Attribute ID	Access	Name	Data Type	Value	Description
3	Get/Set	Instance Data	ARRAY of Byte	–	Data Set service only available for Controller output
4	Get	Instance Data Size	UINT	4...80	Size of data in byte



**Access from a EtherNet/IP Scanner**

When an EtherNet/IP Scanner needs to exchange assemblies with an M241 Logic Controller, it uses the following access parameters (`Connection Path`):

- Class 4
- Instance xx where xx is the instance value (example: 2464 hex = instance 100).
- Attribute 3

In addition, a configuration assembly must be defined in the Originator.

For example: Class 4, Instance 3, Attribute 3, the resulting `Connection Path` will be::

- 2004 hex
- 2403 hex
- 2c<xx> hex

**Connection Manager Object (Class ID = 06 hex)**

The following table describes the class attributes of the Assembly Object:

Attribute ID	Access	Name	Data Type	Value	Details
1	Get	Revision	UINT	2	Implementation revision of the Connection Manager Object
2	Get	Max Instances	UINT	189	The largest instance number
3	Get	Number of Instances	UINT	2	The number of object instances
4	Get	Optional Instance Attribute List	Struct of: UINT UINT [ ]	–	<p>The number and list of the optional attributes. The first word contains the number of attributes to follow and each following word contains another attribute code.</p> <p>Following optional attributes include:</p> <ul style="list-style-type: none"> <li>● total number of incoming connection open requests</li> <li>● the number of requests rejected because of the non-conforming format of the Forward Open</li> <li>● the number of requests rejected because of insufficient resources</li> <li>● the number of requests rejected because of the parameter value sent with the Forward Open</li> <li>● the number of Forward Close requests received</li> <li>● the number of Forward Close requests that had an invalid format</li> <li>● the number of Forward Close requests that could not be matched to an active connection</li> <li>● the number of connections that have timed out because the other side stopped producing, or a network disconnection occurred</li> </ul>
6	Get	Max Class Attribute	UINT	07h	The largest class attributes value
7	Get	Max Instance Attribute	UINT	08h	The largest instance attributes value

The following table describes the Class Services:

Service Code (hex)	Name	Description
01	Get Attribute All	Returns the value of all class attributes
0E	Get Attribute Single	Returns the value of the specified attribute

The following table describes the Instance Services:

Service Code (hex)	Name	Description
01	Get Attribute All	Returns the value of all instance attributes
0E	Get Attribute Single	Returns the value of the specified attribute
4E	Forward Close	Closes an existing connection
52	Unconnected Send	Sends a multi-hop unconnected request
54	Forward Open	Opens a new connection

The following table describes the Instance attributes:

Attribute ID	Access	Name	Data Type	Value	Description
1	Get	Open Requests	UINT	–	Number of Forward Open service requests received
2	Get	Open Format Rejects	UINT	–	Number of Forward Open service requests which were rejected due to invalid format
3	Get	Open Resource Rejects	ARRAY of Byte	–	Number of Forward Open service requests which were rejected due to lack of resources
4	Get	Open Other Rejects	UINT	–	Number of Forward Open service requests which were rejected for reasons other than invalid format or lack of resources
5	Get	Close Requests	UINT	–	Number of Forward Close service requests received
6	Get	Close Format Requests	UINT	–	Number of Forward Close service requests which were rejected due to invalid format
7	Get	Close Other Requests	UINT	–	Number of Forward Close service requests which were rejected for reasons other than invalid format
8	Get	Connection Timeouts	UINT	–	Total number of connection timeouts that have occurred in connections controlled by this Connection Manager

**TCP/IP Interface Object (Class ID = F5 hex)**

This object maintains link specific counters and status information for an Ethernet 802.3 communications interface.

The following table describes the class attributes of the TCP/IP Interface Object:

Attribute ID	Access	Name	Data Type	Value	Details
1	Get	Revision	UINT	4	Implementation revision of the TCP/IP Interface Object
2	Get	Max Instances	UINT	2	The largest instance number
3	Get	Number of Instance	UINT	2	The number of object instances

The following table describes the Class Services:

Service Code (hex)	Name	Description
01	Get Attribute All	Returns the value of all class attributes
0E	Get Attribute Single	Returns the value of the specified attribute

**Instance Codes**

Only instance 1 is supported.

The following table describes the Instance Services:

Service Code (hex)	Name	Description
01	Get Attribute All	Returns the value of all instance attributes
0E	Get Attribute Single	Returns the value of the specified instance attribute

The following table describes the Instance Attributes:

Attribute ID	Access	Name	Data Type	Value	Description
1	Get	Status	DWORD	Bit level	<ul style="list-style-type: none"> <li>● 0: The interface configuration attribute has not been configured.</li> <li>● 1: The interface configuration contains a valid configuration.</li> <li>● 2...15: Reserved.</li> </ul>
2	Get	Configuration Capability	DWORD	Bit level	<ul style="list-style-type: none"> <li>● 0: BOOTP Client</li> <li>● 1: DNS Client</li> <li>● 2: DHCP Client</li> <li>● 5: Configured in EcoStruxure Machine Expert</li> </ul> <p>All other bits are reserved and set to 0.</p>
3	Get	Configuration	DWORD	Bit level	<ul style="list-style-type: none"> <li>● 0: The interface configuration is valid.</li> <li>● 1: The interface configuration is obtained with BOOTP.</li> <li>● 2: The interface configuration is obtained with DHCP.</li> <li>● 3: reserved</li> <li>● 4: DNS Enable</li> </ul> <p>All other bits are reserved and set to 0.</p>
4	Get	Physical Link	UINT	Path size	Number of 16 bits word in the element Path
			Padded EPATH	Path	Logical segments identifying the physical link object. The path is restricted to one logical class segment and one logical instance segment. The maximum size is 12 bytes.
5	Get	Interface configuration	UDINT	IP Address	–
			UDINT	Network Mask	–
			UDINT	Gateway Address	–
			UDINT	Primary Name	–
			UDINT	Secondary Name	0: no secondary name server address has been configured.
			STRING	Default Domain Name	0: no Domain Name is configured
6	Get	Host Name	STRING	–	ASCII characters. 0: no Host Name is configured

### Ethernet Link Object (Class ID = F6 hex)

This object provides the mechanism to configure a TCP/IP network interface device.

The following table describes the class attributes of the Ethernet Link Object:

Attribute ID	Access	Name	Data Type	Value	Details
1	Get	Revision	UINT	4	Implementation revision of the Ethernet Link Object
2	Get	Max Instances	UINT	3	The largest instance number
3	Get	Number of Instances	UINT	3	The number of object instances

The following table describes the Class Services:

Service Code (hex)	Name	Description
01	Get Attribute All	Returns the value of all class attributes
0E	Get Attribute Single	Returns the value of the specified attribute

### Instance Codes

Only instance 1 is supported.

The following table describes the Instance Services:

Service Code (hex)	Name	Description
01	Get Attribute All	Returns the value of all instance attributes
0E	Get Attribute Single	Returns the value of the specified instance attribute

The following table describes the Instance Attributes:

Attribute ID	Access	Name	Data Type	Value	Description
1	Get	Interface Speed	UDINT	–	Speed in Mbps (10 or 100)
2	Get	Interface Flags	DWORD	Bit level	<ul style="list-style-type: none"> <li>● 0: link status</li> <li>● 1: half/full duplex</li> <li>● 2...4: negotiation status</li> <li>● 5: manual setting / requires reset</li> <li>● 6: local hardware error detected</li> </ul> All other bits are reserved and set to 0.
3	Get	Physical Address	ARRAY of 6 USINT	–	This array contains the MAC address of the product. Format: XX-XX-XX-XX-XX-XX

**Interface Diagnostic Object (Class ID = 350 hex)**

The following table describes the class attributes of the Interface Diagnostic Object:

Attribute ID	Access	Name	Data Type	Value	Details
1	Get	Revision	UINT	01h	Increased by 1 at each new update of the object.
2	Get	Max Instance	UINT	01h	Maximum instance number of the object.

**Scanner Diagnostic Object (Class ID = 351 hex)**

The following table describes the class attributes of the Scanner Diagnostic Object:

Attribute ID	Access	Name	Data Type	Value	Details
1	Get	Revision	UINT	01h	Increased by 1 at each new update of the object.
2	Get	Max Instance	UINT	01h	Maximum instance number of the object.

**Connection Diagnostic Object (Class ID = 352 hex)**

The following table describes the class attributes of the Connection Diagnostic Object:

Attribute ID	Access	Name	Data Type	Value	Details
1	Get	Revision	UINT	01h	Increased by 1 at each new update of the object.
2	Get	Max Instance	UINT	0...n (maximum number of CIP IO connections)	Maximum instance number of the object.

**NOTE:** There is one IO Connection Diagnostic object instance for both O->T and T->O paths.

**Explicit Connection Diagnostic Object (Class ID = 353 hex)**

The following table describes the class attributes of the Explicit Connection Diagnostic Object:

Attribute ID	Access	Name	Data Type	Value	Details
1	Get	Revision	UINT	01h	Increased by 1 at each new update of the object.
2	Get	Max Instance	UINT	0...n (maximum number of CIP IO connections)	Maximum instance number of the object.

## M241 Logic Controller as a Slave Device on Modbus TCP

### Overview

This section describes the configuration of the M241 Logic Controller as a **Modbus TCP Slave Device**.

To configure your M241 Logic Controller as a **Modbus TCP Slave Device**, you must add **Modbus TCP Slave Device** functionality to your controller (see Adding a Modbus TCP Slave Device (*see page 64*)). This functionality creates a specific I/O area in the controller that is accessible with the Modbus TCP protocol. This I/O area is used whenever an external master needs to access the %IW and %QW objects of the controller. This **Modbus TCP Slave Device** functionality allows you to furnish to this area the controller I/O objects which can then be accessed with a single Modbus read/write registers request.

The **Modbus TCP Slave Device** adds another Modbus server function to the controller. This server is addressed by the Modbus client application by specifying a configured Unit ID (Modbus address) in the range 1...247. The embedded Modbus server of the slave controller needs no configuration, and is addressed by specifying a Unit ID equal to 255. Refer to Modbus TCP Configuration (*see page 65*).

Inputs/outputs are seen from the slave controller: inputs are written by the master, and outputs are read by the master.

The **Modbus TCP Slave Device** can define a privileged Modbus client application, whose connection is not forcefully closed (embedded Modbus connections may be closed when more than 8 connections are needed).

The timeout duration associated to the privileged connection allows you to verify whether the controller is being polled by the privileged master. If no Modbus request is received within the timeout duration, the diagnostic information `i_byMasterIpLost` is set to 1 (TRUE). For more information, refer to the Ethernet Port Read-Only System Variables (*see Modicon M241 Logic Controller, System Functions and Variables, PLCSystem Library Guide*).

For further information about Modbus TCP, refer to the [www.modbus.org](http://www.modbus.org) website.

### Adding a Modbus TCP Slave Device

To configure your M241 Logic Controller to use the Modbus TCP slave device, you must:

Step	Action
1	Add a TM4ES4 expansion module to your configuration. To do this, you must have added the <b>Industrial_Ethernet_manager</b> to your logic controller.
2	Select <b>Modbus TCP Slave Device</b> in the <b>Hardware Catalog</b> .
3	Drag and drop it to the <b>Devices tree</b> on one of the highlighted nodes. For more information on adding a device to your project, refer to: <ul style="list-style-type: none"> <li>• Using the Drag-and-drop Method (<i>see EcoStruxure Machine Expert, Programming Guide</i>)</li> <li>• Using the Contextual Menu or Plus Button (<i>see EcoStruxure Machine Expert, Programming Guide</i>)</li> </ul>



### Modbus TCP Configuration

To configure the Modbus TCP slave device, double-click **Ethernet\_1** → **ModbusTCP\_Slave\_Device** in the **Devices tree**.

This dialog box appears:

Element	Description
<b>IP Master Address</b>	IP address of the Modbus master The connections are not closed on this address.
<b>TimeOut</b>	Timeout in 500 ms increments <b>NOTE:</b> The timeout applies to the <b>IP Master Address</b> unless the address is 0.0.0.0.
<b>Slave Port</b>	Modbus communication port (502)
<b>Unit ID</b>	Sends the requests to the Modbus TCP slave device (1...247), instead of the embedded Modbus server (255).
<b>Holding Registers (%IW)</b>	Number of %IW registers to be used in the exchange (2...40) (each register is 2 bytes)
<b>Input Registers (%QW)</b>	Number of %QW registers to be used in the exchange (2...40) (each register is 2 bytes)

## Modbus TCP Slave Device I/O Mapping Tab

The I/Os are mapped to Modbus registers from the master perspective as follows:

- %IWs are mapped from register 0 to n-1 and are R/W (n = Holding register quantity, each %IW register is 2 bytes).
- %QWs are mapped from register n to n+m -1 and are read only (m = Input registers quantity, each %QW register is 2 bytes).

Once a **Modbus TCP Slave Device** has been configured, Modbus commands sent to its Unit ID (Modbus address) are handled differently than the same command would be when addressed to any other Modbus device on the network. For example, when the Modbus command 3 (3 hex) is sent to a standard Modbus device, it reads and returns the value of one or more registers. When this same command is sent to the Modbus TCP Slave, it facilitates a read operation by the external I/O scanner.

Once a **Modbus TCP Slave Device** has been configured, Modbus commands sent to its Unit ID (Modbus address) access the %IW and %QW objects of the controller instead of the regular Modbus words (accessed when the Unit ID is 255). This facilitates read/write operations by a Modbus TCP I/Scanner application.

The **Modbus TCP Slave Device** responds to a subset of the Modbus commands with the purpose of exchanging data with the external I/O scanner. The following Modbus commands are supported by the **Modbus TCP Slave Device**:

Function Code Dec (Hex)	Function	Comment
3 (3)	Read holding register	Allows the master to read %IW and %QW objects of the device
6 (6)	Write single register	Allows the master to write %IW objects of the device
16 (10)	Write multiple registers	Allows the master to write %IW objects of the device
23 (17)	Read/write multiple registers	Allows the master to read %IW and %QW objects of the device and write %IW objects of the device
Other	Not supported	–

**NOTE:** Modbus requests that attempt to access registers above n+m-1 are answered by the 02 - ILLEGAL DATA ADDRESS exception code.

To link I/O objects to variables, select the **Modbus TCP Slave Device I/O Mapping** tab:

Modbus TCP

Modbus TCP Slave Device I/O Mapping

Information

**Channels**

Variable	Mapping	Channel	Address	Type	Default Value	Unit	Description
<b>Inputs</b>							
Application.POU.tata		Inputs[0]	%IW0	WORD			Modbus Holding...
iwModbusTCT_Sla...		Inputs[1]	%IW1	WORD			
iwModbusTCT_Sla...		Inputs[2]	%IW2	WORD			
iwModbusTCT_Sla...		Inputs[3]	%IW3	WORD			
iwModbusTCT_Sla...		Inputs[4]	%IW4	WORD			
iwModbusTCT_Sla...		Inputs[5]	%IW5	WORD			
iwModbusTCT_Sla...		Inputs[6]	%IW6	WORD			
iwModbusTCT_Sla...		Inputs[7]	%IW7	WORD			
iwModbusTCT_Sla...		Inputs[8]	%IW8	WORD			
iwModbusTCT_Sla...		Inputs[9]	%IW9	WORD			
<b>Outputs</b>							
qwModbusTCP_Sl...		Outputs[0]	%QW0	WORD			Modbus Input Re...
qwModbusTCP_Sl...		Outputs[1]	%QW1	WORD			
qwModbusTCP_Sl...		Outputs[2]	%QW2	WORD			
qwModbusTCP_Sl...		Outputs[3]	%QW3	WORD			
qwModbusTCP_Sl...		Outputs[4]	%QW4	WORD			
qwModbusTCP_Sl...		Outputs[5]	%QW5	WORD			
qwModbusTCP_Sl...		Outputs[6]	%QW6	WORD			
qwModbusTCP_Sl...		Outputs[7]	%QW7	WORD			
qwModbusTCP_Sl...		Outputs[8]	%QW8	WORD			
qwModbusTCP_Sl...		Outputs[9]	%QW9	WORD			

Always update variables

**IEC Objects**

Variable	Mapping	Type
Modbus TCP_Slave_De		IoDrvModbusTCPSlave

= Create new variable     = Map to existing variable

**Bus cycle options**

Bus cycle task: Use parent bus cycle setting

Channel	Type	Description
<b>Input</b>	IW0	WORD
	...	...
	IWx	WORD
<b>Output</b>	QW0	WORD
	...	...
	QWy	WORD

The number of words depends on the **Holding Registers (%IW)** and **Input Registers (%QW)** parameters of the **Modbus TCP** tab.

**NOTE:** Output means OUTPUT from Originator controller (%IW for the controller). Input means INPUT from Originator controller (%QW for the controller).

**NOTE:** The Modbus TCP slave device refreshes the %IW and %QW registers as a single time-consistent unit, synchronized with the IEC tasks (MAST task by default). By contrast, the embedded Modbus TCP server only ensures time-consistency for one word (2 bytes). If your application requires time-consistency for more than one word (2 bytes), use the **Modbus TCP Slave Device**.

### Bus Cycle Options

Select the **Bus cycle task** to use:

- **Use parent bus cycle setting** (the default),
- **MAST**

There is a corresponding **Bus cycle task** parameter in the I/O mapping editor of the device that contains the Modbus TCP slave device. This parameter defines the task responsible for refreshing the %IW and %QW registers.

---

## Section 2.2

### Firewall Configuration

---

#### Introduction

This section describes how to configure the firewall of the Modicon M241 Logic Controller.

#### What Is in This Section?

This section contains the following topics:

Topic	Page
Introduction	70
Dynamic Changes Procedure	72
Firewall Behavior	73
Firewall Script Commands	75

## Introduction

### Firewall Presentation

In general, firewalls help protect network security zone perimeters by blocking unauthorized access and permitting authorized access. A firewall is a device or set of devices configured to permit, deny, encrypt, decrypt, or proxy traffic between different security zones based upon a set of rules and other criteria.

Process control devices and high-speed manufacturing machines require fast data throughput and often cannot tolerate the latency introduced by an aggressive security strategy inside the control network. Firewalls, therefore, play a significant role in a security strategy by providing levels of protection at the perimeters of the network. Firewalls are an important part of an overall, system level strategy. By default, firewall rules do not allow the transfer of incoming IP telegrams from a controller network to a fieldbus network.

**NOTE:** Schneider Electric adheres to industry best practices in the development and implementation of control systems. This includes a "Defense-in-Depth" approach to secure an Industrial Control System. This approach places the controllers behind one or more firewalls to restrict access to authorized personnel and protocols only.

### WARNING

#### **UNAUTHENTICATED ACCESS AND SUBSEQUENT UNAUTHORIZED MACHINE OPERATION**

- Evaluate whether your environment or your machines are connected to your critical infrastructure and, if so, take appropriate steps in terms of prevention, based on Defense-in-Depth, before connecting the automation system to any network.
- Limit the number of devices connected to a network to the minimum necessary.
- Isolate your industrial network from other networks inside your company.
- Protect any network against unintended access by using firewalls, VPN, or other, proven security measures.
- Monitor activities within your systems.
- Prevent subject devices from direct access or direct link by unauthorized parties or unauthenticated actions.
- Prepare a recovery plan including backup of your system and process information.

**Failure to follow these instructions can result in death, serious injury, or equipment damage.**

### Firewall Configuration

There are three ways to manage the controller firewall configuration:

- Static configuration
- Dynamic changes
- Application settings

Script files are used in the static configuration and for dynamic changes.

### Static Configuration

The static configuration is loaded at the controller boot.

The controller firewall can be statically configured by managing a default script file located in the controller. The path to this file is `/usr/Cfg/FirewallDefault.cmd`.

### Dynamic Changes

After the controller boot, the controller firewall configuration can be changed by the use of script files.

There are two ways to load these dynamic changes using:

- A physical SD card (*see page 72*).
- A function block (*see page 72*) in the application.

### Application Settings

See Ethernet Configuration (*see Modicon M241 Logic Controller, Programming Guide*).

## Dynamic Changes Procedure

### Using an SD Card

This table describes the procedure to execute a script file from an SD card:

Step	Action
1	Create a valid script file ( <i>see page 75</i> ). For example, name the script file <i>FirewallMaintenance.cmd</i> .
2	Load the script file on the SD card. For example, load the script file in the <i>usr/Cfg</i> folder.
3	In the file <i>Sys/Cmd/Script.cmd</i> , add a code line with the command <code>Firewall_install "/pathname/FileName"</code> For example, the code line is <code>Firewall_install "/sd0/usr/Cfg/FirewallMaintenance.cmd"</code>
4	Insert the SD card on the controller.

### Using a Function Block in the Application

This table describes the procedure to execute a script file from an application:

Step	Action
1	Create a valid script file ( <i>see page 75</i> ). For example, name the script file <i>FirewallMaintenance.cmd</i> .
2	Load the script file in the controller memory. For example, load the script file in the <i>usr/Syslog</i> folder with FTP.
3	Use an ExecuteScript ( <i>see Modicon M241 Logic Controller, System Functions and Variables, PLCSystem Library Guide</i> ) function block. For example, the <b>[SCmd]</b> input is <code>'Firewall_install "/usr/Syslog/FirewallMaintenance.cmd"'</code>



## Firewall Behavior

### Introduction

The firewall configuration depends on the action done on the controller and the initial configuration state. There are five possible initial states:

- There is no default script file in the controller.
- A correct script file is present.
- An incorrect script file is present.
- There is no default script file and the application has configured the firewall.
- A dynamic script file configuration has already been executed.

### No Default Script File

If...	Then ...
Boot of the controller	Firewall is not configured. No protection is activated.
Execute dynamic script file	Firewall is configured according to the dynamic script file.
Execute dynamic incorrect script file	Firewall is not configured. No protection is activated.
Download application	Firewall is configured according to the application settings.

### Default Script File Present

If...	Then ...
Boot of the controller	Firewall is configured according to the default script file.
Execute dynamic script file	The whole configuration of the default script file is deleted. Firewall is configured according to the dynamic script file.
Execute dynamic incorrect script file	Firewall is configured according to the default script file. The dynamic script file is not taken into account.
Download application	The whole configuration of the application is ignored. Firewall is configured according to the default script file.

### Incorrect Default Script File Present

If...	Then ...
Boot of the controller	Firewall is not configured. No protection is activated
Execute dynamic script file	Firewall is configured according to the dynamic script file.
Execute dynamic incorrect script file	Firewall is not configured. No protection is activated.
Download application	Firewall is configured according to the application settings.

### Application Settings with No Default Script File

If...	Then ...
Boot of the controller	Firewall is configured according to the application settings.
Execute dynamic script file	The whole configuration of the application settings is deleted. Firewall is configured according to the dynamic script file.
Execute dynamic incorrect script file	Firewall is configured according to the application settings. The dynamic script file is not taken into account.
Download application	The whole configuration of the previous application is deleted. Firewall is configured according to the new application settings.

### Execute Dynamic Script File Already Executed

If...	Then ...
Boot of the controller	Firewall is configured according to the dynamic script file configuration (see note).
Execute dynamic script file	The whole configuration of the previous dynamic script file is deleted. Firewall is configured according to the new dynamic script file.
Execute dynamic incorrect script file	Firewall is configured according to the previous dynamic script file configuration. The dynamic incorrect script file is not taken into account.
Download application	The whole configuration of the application is ignored Firewall is configured according to the dynamic script file.
<b>NOTE:</b> If an SD card containing a cybersecurity script is plugged into the controller, booting is blocked. First remove the SD card to correctly boot the controller.	

## Firewall Script Commands

### Overview

This section describes how script files (default script files or dynamic script files) are written so that they can be executed during the booting of the controller or during a specific command triggered.

**NOTE:** The MAC layer rules are managed separately and have more priority over other packet filter rules.

### Script File Syntax

The syntax of script files is described in Script Syntax Guidelines.

### General Firewall Commands

The following commands are available to manage the Ethernet firewall of the M241 Logic Controller:

Command	Description
Firewall Enable	Blocks the frames from the Ethernet interfaces. If no specific IP address is authorized, it is not possible to communicate on the Ethernet interfaces. <b>NOTE:</b> By default, when the firewall is enabled, the frames are rejected.
Firewall Disable	Firewall rules are not applied. Frames are not blocked
Firewall Ethx Default Allow <sup>(1)</sup>	Frames are accepted by the controller.
Firewall Ethx Default Reject <sup>(1)</sup>	Frames are rejected by the controller. <b>NOTE:</b> By default, if this line is not present, it corresponds to the command <code>Firewall Eth1 Default Reject</code> .
<b>(1)</b> Where Ethx = <ul style="list-style-type: none"> <li>● Eth1: Ethernet_1</li> <li>● Eth2: TM4ES4</li> </ul>	

### Specific Firewall Commands

The following commands are available to configure firewall rules for specific ports and addresses:

Command	Range	Description
Firewall Eth1 Allow IP .....*	• = 0...255	Frames from the specified IP address are allowed on all port numbers and port types.
Firewall Eth1 Reject IP .....*	• = 0...255	Frames from the specified IP address are rejected on all port numbers and port types.
Firewall Eth1 Allow IPs .....* to .....*	• = 0...255	Frames from the IP addresses in the specified range are allowed for all port numbers and port types.
Firewall Eth1 Reject IPs .....* to .....*	• = 0...255	Frames from the IP addresses in the specified range are rejected for all port numbers and port types.
Firewall Eth1 Allow port_type port Y	Y = (destination port numbers <i>(see page 79)</i> )	Frames with the specified destination port number are allowed.
Firewall Eth1 Reject port_type port Y	Y = (destination port numbers <i>(see page 79)</i> )	Frames with the specified destination port number are rejected. <b>NOTE:</b> When IP forwarding is activated, rules with reject port only filter frames with current controller as destination. They are not applied for the frames routed by the current controller.
Firewall Eth1 Allow port_type ports Y1 to Y2	Y = (destination port numbers <i>(see page 79)</i> )	Frames with a destination port number in the specified range are allowed.
Firewall Eth1 Reject port_type ports Y1 to Y2	Y = (destination port numbers <i>(see page 79)</i> )	Frames with a destination port number in the specified range are rejected.
Firewall Eth1 Allow IP .....* on port_type port Y	• = 0...255 Y = (destination port numbers <i>(see page 79)</i> )	Frames from the specified IP address and with the specified destination port number are allowed.
Firewall Eth1 Reject IP .....* on port_type port Y	• = 0...255 Y = (destination port numbers <i>(see page 79)</i> )	Frames from the specified IP address and with the specified destination port number are rejected.
Firewall Eth1 Allow IP .....* on port_type ports Y1 to Y2	• = 0...255 Y = (destination port numbers <i>(see page 79)</i> )	Frames from the specified IP address and with a destination port number in the specified range are allowed.
Firewall Eth1 Reject IP .....* on port_type ports Y1 to Y2	• = 0...255 Y = (destination port numbers <i>(see page 79)</i> )	Frames from the specified IP address and with a destination port number in the specified range are rejected.
Firewall Eth1 Allow IPs .1.1.1.1 to .2.2.2.2 on port_type port Y	• = 0...255 Y = (destination port numbers <i>(see page 79)</i> )	Frames from an IP address in the specified range and with the specified destination port number are allowed.

Command	Range	Description
Firewall Eth1 Reject IPs •1.1.1.1 to •2.2.2.2 on port_type port Y	• = 0...255 Y = (destination port numbers ( <i>see page 79</i> ))	Frames from an IP address in the specified range and with the specified destination port number are rejected.
Firewall Eth1 Allow IPs •1.1.1.1 to •2.2.2.2 on port_type ports Y1 to Y2	• = 0...255 Y = (destination port numbers ( <i>see page 79</i> ))	Frames from an IP address in the specified range and with a destination port number in the specified range are allowed.
Firewall Eth1 Reject IPs •1.1.1.1 to •2.2.2.2 on port_type ports Y1 to Y2	• = 0...255 Y = (destination port numbers ( <i>see page 79</i> ))	Frames from an IP address in the specified range and with a destination port number in the specified range are rejected.
Firewall Eth1 Allow MAC ••:••:••:••:••:••	• = 0...F	Frames from the specified MAC address ••:••:••:••:•• are allowed.  <b>NOTE:</b> When the rules to allow the MAC address are applied, only the listed MAC addresses can communicate with the controller, even if other rules are allowed.
Firewall Eth1 Reject MAC ••:~••:~••:~••:~••:~••	• = 0...F	Frames with the specified MAC address ••:~••:~••:~•~ are rejected.

**NOTE:** The port\_type can be TCP or UDP.

**Script Example**

```
; Enable FireWall. All frames are rejected;
FireWall Enable;
; Allow frames on Eth1
FireWall Eth1 Default Allow;
; Block all Modbus Requests on all IP address
Firewall Eth1 Reject tcp port 502;
; Reject frames on Eth2
FireWall Eth2 Default Reject;
; Allow FTP active connection for IP address 85.16.0.17
FireWall Eth2 Allow IP 85.16.0.17 on tcp ports 20 to 21;
```

**NOTE:** IP addresses are converted to CIDR format.

For example:

"FireWall Eth2 Allow IPs 192.168.100.66 to 192.168.100.99 on tcp port 44818;", is separated into 7:

- 192.168.100.66/31
- 192.168.100.68/30
- 192.168.100.72/29
- 192.168.100.80/28
- 192.168.100.96/27
- 192.168.100.128/26
- 192.168.100.192/29

To prevent a firewall error, use the entire subnet configuration.

**NOTE:** Characters are limited to 200 per line, including comments.

## Ports Used

Protocol	Destination Port Numbers
Machine Expert	UDP 1740, 1741, 1742, 1743 TCP 1105
FTP	TCP 21, 20
HTTP	TCP 80
Modbus	TCP 502 <sup>(1)</sup>
Machine Expert Discovery	UDP 27126, 27127
SNMP	UDP 161, 162
NVL	UDP Default value: 1202
EtherNet/IP	UDP 2222 TCP 44818
TFTP	UDP 69 (used for FDR server only)
<b>(1)</b> The default value can be changed using the change ModbusPort command.	





---

# Chapter 3

## TM4PDPS1 PROFIBUS DP Slave Module

---

### Introduction

This chapter describes the configuration of the TM4PDPS1 PROFIBUS DP slave module.

### What Is in This Chapter?

This chapter contains the following sections:

Section	Topic	Page
3.1	PROFIBUS DP Slave Module Configuration	82
3.2	Data Exchange	87
3.3	Diagnostic	93

## Section 3.1

### PROFIBUS DP Slave Module Configuration

---

#### Introduction

This section describes the configuration of the TM4PDPS1 PROFIBUS DP module.

#### What Is in This Section?

This section contains the following topics:

Topic	Page
Add a PROFIBUS DP Slave Module	83
Configure the PROFIBUS DP Slave Module	84
Input / Output Devices Objects	85

## Add a PROFIBUS DP Slave Module

### Overview

With the PROFIBUS protocol the data is exchanged according to the master-slave principle. Only the master can initialize communication. The slaves respond to requests from masters. Several masters can coexist on the same bus. In this case, the slave I/O can be read by all the masters. However, a single master has write access to the outputs. The number of data items exchanged is defined during the configuration.

For the PROFIBUS master, the GSD file of the TM4PDPS1 module is located on *Drive:\Program Files\Schneider Electric\EcoStruxure Machine Expert Software\1.1\LogicBuilder\GSD\SE100E83.GSD*.

The GSD file is also available on [www.schneider-electric.com](http://www.schneider-electric.com).

There are 2 types of exchange services supported by this module:

- I/O cyclic frames exchanges ([see page 88](#))
- acyclic data exchanges with Profibus DPV1 function ([see page 91](#))

### Add a PROFIBUS DP Slave Module

Select the **TM4PDPS1** module in the **Hardware Catalog**, drag it to the **Devices tree**, and drop it on the **COM\_Bus** node.

For more information on adding a device to your project, refer to:

- Using the Drag-and-drop Method ([see EcoStruxure Machine Expert, Programming Guide](#))
- Using the Contextual Menu or Plus Button ([see EcoStruxure Machine Expert, Programming Guide](#))

**NOTE:** Adding PROFIBUS increases the associated task cycle time by several milliseconds and the starting time by several seconds.

## Configure the PROFIBUS DP Slave Module

### PROFIBUS DP Slave Module Configuration

In the **Devices tree**, double-click **My Controller** → **COM\_Bus** → **TM4PDPS1**:

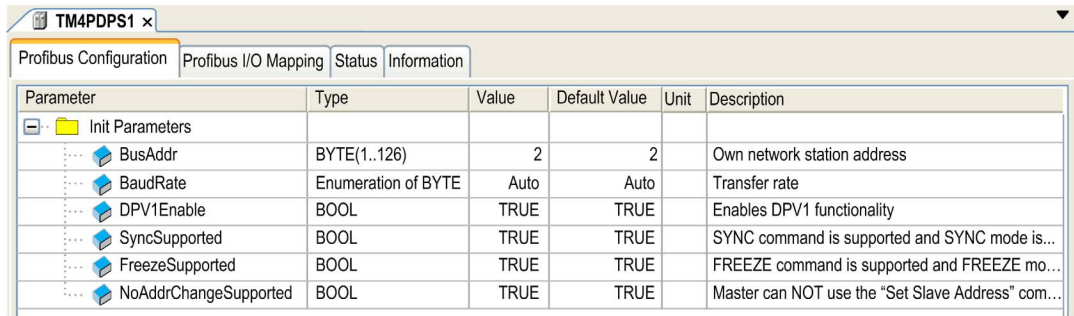

The following parameters are provided in the **Profibus Configuration** tab:

Parameter	Value	Default Value	Description
<b>BusAddr</b>	1...126	2	PROFIBUS DP slave address. The address 126 is reserved.
<b>BaudRate (Kbaud)</b>	9.6 19.2 45.45 93.75 187.5 500 1500 3000 6000 12000 Auto	Auto	PROFIBUS transmission rate
<b>DPV1Enable</b>	TRUE FALSE	TRUE	TRUE = Profibus DPV1 functions for acyclic communication ( <i>see page 91</i> ) enable
<b>SyncSupported</b>	TRUE FALSE	TRUE	TRUE = sync mode, that supports the sync command, enable
<b>FreezeSupported</b>	TRUE FALSE	TRUE	TRUE = freeze mode, that supports the freeze command, enable
<b>NoAddrChangeSupported</b>	TRUE FALSE	TRUE	TRUE = blocks a PROFIBUS master from changing the address

## Input / Output Devices Objects

### Introduction

To exchange data between the controller and a PROFIBUS master, it is important to understand the role of the TM4PDPS1 module.

The TM4PDPS1 module is an intermediate between the PROFIBUS master and the controller, and data is exchanged by using virtual I/O devices that you define when configuring the TM4PDPS1 module. The virtual devices are not physical I/O modules, but are logical input and output objects within the TM4PDPS1 module that you can then map to memory within the controller. These input and output objects are read from and written to by the PROFIBUS master. In turn, the module reads and writes this data to I/O memory locations in the controller so that you can use the data within your application program.

## Virtual I/O Devices

The virtual I/O devices you define within the TM4PDPS1 module can be either input or output, and can vary in size as defined by the table:

Name	Number of I/O	Format
12 word input (0x5B)	12	word
12 word output (0x6B)	12	word
16 byte input (0x1F)	16	byte
16 byte output (0x2F)	16	byte
2 byte input (0x11)	2	byte
2 byte output (0x21)	2	byte
2 word input (0x51)	2	word
2 word output (0x61)	2	word
20 word input (0x40, 0x53)	20	word
20 word output (0x80, 0x53)	20	word
32 word input (0x40, 0x5F)	32	word
32 word output (0x80, 0x5F)	32	word
4 word input (0x53)	4	word
4 word output (0x63)	4	word
8 byte input (0x17)	8	byte
8 byte output (0x27)	8	byte
8 word input (0x57)	8	word
8 word output (0x67)	8	word

Once you have defined these virtual input and/or output devices within the TM4PDPS1 expansion module, you can then map these devices to memory locations within the controller. The type of memory objects you map these virtual I/O devices to depends on the type of exchange you define between the master and the slave.

---

## Section 3.2

### Data Exchange

---

#### Introduction

This section provides further information on the exchange of data between the TM4PDPS1 module and the PROFIBUS master.

#### What Is in This Section?

This section contains the following topics:

Topic	Page
I/O Cyclic Exchange	88
Acyclic Exchange with PROFIBUS DPV1 Functions	91

## I/O Cyclic Exchange

### Introduction

In order to exchange input / output data between the PROFIBUS DP slave module and the PROFIBUS master in a cyclic way, define the variables in the **Profibus-Modules I/O Mapping** tab.

The %IW addresses of the controller are the output values supplied by the PROFIBUS DP master.

The %QW addresses of the controller are applied to the input of the PROFIBUS DP master.

#### NOTE:

When you use the PROFIBUS module TM4PDPS1, it is mandatory to:

- configure a dedicated PROFIBUS task without watchdog (do not use the MAST task)
- assign the dedicated PROFIBUS task a lower priority than the MAST task (for example, if the MAST task has a priority value 1, the TaskProfibus must have a priority value 10.)
- not set the PROFIBUS task cycle time faster than 10 ms. The typical cycle time of the bus cycle task is 10 ms.

For more information about PROFIBUS task configuration, refer to the EcoStruxure Machine Expert online help, chapter *Programming with EcoStruxure Machine Expert / Device Editors / ProfibusDP Configuration Editor / ProfibusDP bus cycle task*.

### Create Your I/O Mapping Table for the TM4PDPS1 PROFIBUS DP Slave Module

To create your I/O mapping table for the TM4PDPS1, proceed as follows:

Step	Action
1	Select the <b>Devices &amp; Modules</b> tab in the <b>Hardware Catalog</b> and click <b>Communication</b> .
2	Select <b>Profibus → Master</b> , choose the I/O device to add and drag-and-drop it onto TM4PDPS1. <b>Result:</b> The module is added to <b>My Controller → COM_Bus → TM4PDPS1</b> area of the <b>Devices tree</b> .



The variables for the exchange are automatically created in the %IWx and %QWx of the **Profibus I/O Mapping** tab. Double-click the I/O device you added to access this screen.

Profibus							
Status							
Information							
Channels							
Variable	Mapping	Channel	Address	Type	D...	U...	D...
		Output0	%QW3	WORD			
		Word0	%QW3	WORD			
		Word1	%QW4	WORD			
		Word2	%QW5	WORD			
		Word3	%QW6	WORD			
		Word4	%QW7	WORD			
		Word5	%QW8	WORD			
		Word6	%QW9	WORD			
		Word7	%QW10	WORD			
		Word8	%QW11	WORD			
		Word9	%QW12	WORD			
		Word10	%QW13	WORD			
		Word11	%QW14	WORD			

### Configure a Virtual I/O Device Added to the TM4PDPS1 Module

The tabs of the configuration window are described in the table below:

The configuration window contains the following tabs:

Tab Name	Description
<b>Profibus I/O Mapping</b>	This tab contains the variables for data exchange.
<b>Status</b>	This tab provides diagnostic information ( <i>see page 93</i> ).
<b>Information</b>	This tab provides further information on the selected input or output module.

### PROFIBUS Virtual I/O Behavior

The table describes the status of the PROFIBUS I/O depending on:

- the controller status
- the PROFIBUS communication state (value of **PROFIBUS\_R.i\_CommState** of **PLCSystem** library)

Controller State	Controller PROFIBUS I/O State
STOPPED	The %QW addresses are managed as it is configured in the <b>PLC Settings</b> tab of the controller configuration screen. The %IW addresses are managed as it is configured in the <b>PLC Settings</b> tab of the controller configuration screen.
RUNNING	The %IW addresses are updated by the master. The %QW addresses are sent to the master.
HALT	The %QW addresses are managed as it is configured in the <b>PLC Settings</b> tab of the controller configuration screen. The %IW addresses keep the last correct value sent by the master.

Communication Status	Value of PROFIBUS_R.i_CommState	Controller PROFIBUS I/O State
PROFIBUS Master is stopped	4 (Operate mode)	The %IW addresses are set to 0 by the master. The %QW addresses are sent to the master.
Watchdog is detected	2 (Stop)	The %QW addresses are not sent to the master. The %IW addresses keep the last correct value sent by the master.

## Acyclic Exchange with PROFIBUS DPV1 Functions

### Introduction

The PROFIBUS DPV1 enhancement additionally supports acyclic data exchange between a PROFIBUS DPV1 master and DPV1 slaves. It allows access to %MW variables.

To use these functions between a PROFIBUS DPV1 master and the TM4PDPS1 module, the parameter **DPV1Enable** must be set to TRUE (default value) (*see page 84*).

### Data Addressing

Data addressing in the logic controller is %MW.

The **Profibus status** of the controller must be in **Operate** state; therefore it can be updated even if the logic controller is not running.

The %MW variables are automatically updated by the I/O driver whenever a DPV1 message is received.

It is based on PROFIBUS DPV1 read and write functions.

The logic address is the number of the %MW addressed.

### Addressing

2 different types of addressing are available for acyclic exchange:

Addressing Type	Number of Requests for Read/Write %MW Variables	Description
Direct addressing	1	The address of the %MW variable is coded directly by <b>Slot</b> and <b>Index</b> fields. See restrictions in the note below.
Indirect addressing	2	<ul style="list-style-type: none"> <li>• The first request sends the address of the first %MW that the master will read or write.</li> <li>• The second request reads or writes one or several values of the %MW variable.</li> </ul>

#### NOTE:

The following restrictions apply to direct addressing:

- **Slot** field (**DU1**): value 0xFF is not allowed
- **Index** field (**DU2**): values 0xFF, 0xE9, and 0xEA are not allowed

The table shows how to create requests for accessing the %MW from the PROFIBUS DPV1 master:

Addressing		DU0: DPV1 Function Number	DU1: Slot	DU2: Index	DU3: Length (in Bytes)	DPV1 Data Frame
		1 Byte	1 Byte	1 Byte	1 Byte	N Byte
Direct addressing	Write	5F hex (write)	MSB of the %MW address	LSB of the %MW address	Length to read	Values to write
	Read	5E hex (read)	MSB of the %MW address	LSB of the %MW address	Length to write	–
Indirect addressing	Send address (Step 1)	5F hex (write)	1	E9 hex	2	%MW address
	Read (Step 2)	5E hex (read)	1	EA hex	Length to read	–
	Write (Step 2)	5F hex (write)	1	EA hex	Length to write	Values to write

**NOTE:** The Length field has to have an even value (the length in byte of one %MW is 2).

## Section 3.3

### Diagnostic

#### Diagnostic Information

##### Displaying General Diagnostics Data

To display general diagnostic data, open the **Status** tab of the TM4PDPS1 configuration window.

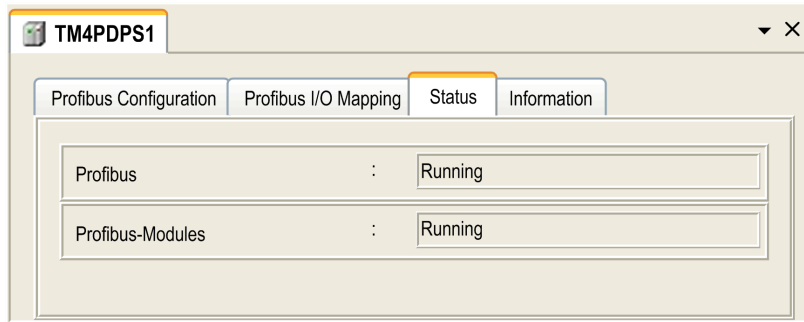

##### Monitoring the Status of the TM4PDPS1 Module

You can monitor the status of the TM4PDPS1 module with the `PROFIBUS_R` system data type described in the M241 Controller PLCSystem Library Guide or M251 Controller PLCSystem Library Guide depending on your controller.

##### Fallback Management

When there is a PROFIBUS communication interruption (`i_CommState=0`), the outputs of the TM4PDPS1 are maintained to the last state transmitted by the PROFIBUS master.

The Fail Safe Mode as defined by the PROFIBUS DP standard is not supported by the TM4PDPS1 module.

### Messages on Detected Errors

Use `i_CommError` of the PROFIBUS\_R system data type to visualize the detected error displayed.

No error has been detected:

Name	Value	Meaning
SUCCESS	0 hex	No error detected.

Runtime error has been detected:

Name	Value	Meaning
WATCHDOG_TIMEOUT	C000000C hex	The watchdog time has been exceeded.

Initialization errors have been detected:

Name	Value	Meaning
INIT_FAULT	C0000100 hex	The initialization was not successful.
DATABASE_ACCESS_FAILED	C0000101 hex	Access to data memory was not successful.

Configuration errors have been detected:

Name	Value	Meaning
NOT_CONFIGURED	C0000119 hex	The TM4PDPS1 PCI module is not configured.
CONFIGURATION_FAULT	C0000120 hex	A configuration error has been detected.
INCONSISTENT_DATA_SET	C0000121 hex	Inconsistent set data have been detected.
DATA_SET_MISMATCH	C0000122 hex	A mismatch of set data has been detected.
INSUFFICIENT_LICENSE	C0000123 hex	An insufficient license has been detected.
PARAMETER_ERROR	C0000124 hex	A parameter error has been detected.
INVALID_NETWORK_ADDRESS	C0000125 hex	The network address is not correct.
SECURITY_MEMORY	C0000126 hex	The security memory is not available.

Network errors have been detected:

Name	Value	Meaning
COMM_NETWORK_FAULT	C0000140 hex	A network communication error has been detected.
COMM_CONNECTION_CLOSED	C0000141 hex	The communication connection has been closed.
COMM_CONNECTION_TIMEOUT	C0000142 hex	A communication connection timeout has been detected.
COMM_DUPLICATE_NODE	C0000144 hex	A duplicate node has been detected.
COMM_CABLE_DISCONNECT	C0000145 hex	A disconnected cable has been detected.
PROFIBUS_CONNECTION_TIMEOUT	C009002E hex	A PROFIBUS connection timeout has been detected.



## A

### ARP

*(address resolution protocol)* An IP network layer protocol for Ethernet that maps an IP address to a MAC (hardware) address.

## B

### BOOTP

*(bootstrap protocol)* A UDP network protocol that can be used by a network client to automatically obtain an IP address (and possibly other data) from a server. The client identifies itself to the server using the client MAC address. The server, which maintains a pre-configured table of client device MAC addresses and associated IP addresses, sends the client its pre-configured IP address. BOOTP was originally used as a method that enabled diskless hosts to be remotely booted over a network. The BOOTP process assigns an infinite lease of an IP address. The BOOTP service utilizes UDP ports 67 and 68.

## C

### configuration

The arrangement and interconnection of hardware components within a system and the hardware and software parameters that determine the operating characteristics of the system.

### control network

A network containing logic controllers, SCADA systems, PCs, HMI, switches, ...

Two kinds of topologies are supported:

- flat: all modules and devices in this network belong to same subnet.
- 2 levels: the network is split into an operation network and an inter-controller network.

These two networks can be physically independent, but are generally linked by a routing device.

## D

### device network

A network that contains devices connected to a specific communication port of a logic controller. This controller is seen as a master from the devices point of view.

### DHCP

*(dynamic host configuration protocol)* An advanced extension of BOOTP. DHCP is more advanced, but both DHCP and BOOTP are common. (DHCP can handle BOOTP client requests.)

**DNS**

(*domain name system*) The naming system for computers and devices connected to a LAN or the Internet.

**E**

**EDS**

(*electronic data sheet*) A file for fieldbus device description that contains, for example, the properties of a device such as parameters and settings.

**EtherNet/IP**

(*Ethernet industrial protocol*) An open communications protocol for manufacturing automation solutions in industrial systems. EtherNet/IP is in a family of networks that implement the common industrial protocol at its upper layers. The supporting organization (ODVA) specifies EtherNet/IP to accomplish global adaptability and media independence.

**F**

**FTP**

(*file transfer protocol*) A standard network protocol built on a client-server architecture to exchange and manipulate files over TCP/IP based networks regardless of their size.

**I**

**ICMP**

(*Internet control message protocol*) Reports errors detected and provides information related to datagram processing.

**IP**

(*Internet protocol*) Part of the TCP/IP protocol family that tracks the Internet addresses of devices, routes outgoing messages, and recognizes incoming messages.

**L**

**LSB**

(*least significant bit/byte*) The part of a number, address, or field that is written as the right-most single value in conventional hexadecimal or binary notation.



## M

### MAC address

*(media access control address)* A unique 48-bit number associated with a specific piece of hardware. The MAC address is programmed into each network card or device when it is manufactured.

### MIB

*(management information base)* An object database that is monitored by a network management system like SNMP. SNMP monitors devices are defined by their MIBs. Schneider Electric has obtained a private MIB, groupeschneider (3833).

### MSB

*(most significant bit/byte)* The part of a number, address, or field that is written as the left-most single value in conventional hexadecimal or binary notation.

## N

### node

An addressable device on a communication network.

## P

### Profibus DP

*(Profibus decentralized peripheral)* An open bus system uses an electrical network based on a shielded 2-wire line or an optical network based on a fiber-optic cable. DP transmission allows for high-speed, cyclic exchange of data between the controller CPU and the distributed I/O devices.

### protocol

A convention or standard definition that controls or enables the connection, communication, and data transfer between 2 computing system and devices.

## R

### RPI

*(requested packet interval)* The time period between cyclic data exchanges requested by the scanner. EtherNet/IP devices publish data at the rate specified by the RPI assigned to them by the scanner, and they receive message requests from the scanner with a period equal to RPI.

## S

### SNMP

*(simple network management protocol)* A protocol that can control a network remotely by polling the devices for their status and viewing information related to data transmission. You can also use it to manage software and databases remotely. The protocol also permits active management tasks, such as modifying and applying a new configuration.

## T

### TCP

*(transmission control protocol)* A connection-based transport layer protocol that provides a simultaneous bi-directional transmission of data. TCP is part of the TCP/IP protocol suite.

## U

### UDP

*(user datagram protocol)* A connectionless mode protocol (defined by IETF RFC 768) in which messages are delivered in a datagram (data telegram) to a destination computer on an IP network. The UDP protocol is typically bundled with the Internet protocol. UDP/IP messages do not expect a response, and are therefore ideal for applications in which dropped packets do not require retransmission (such as streaming video and networks that demand real-time performance).



## A

acyclic exchange, *91*

## C

cyclic data exchanges, generating EDS file for, *48*

cyclic exchange, *88*

## D

diagnostic information, *93*

DPV1

PROFIBUS functions, *91*

## E

EDS file, generating, *48*

EtherNet

EtherNet/IP device, *47*

Ethernet

FTP Server, *45*

Modbus TCP Server/Client, *26*

Modbus TCP slave device, *64*

Services, *19*

SNMP, *46*

Web server, *28*

expansion modules

adding, *15*

configuration, *15*

## F

firewall

configuration, *73*

default script file, *73*

script commands, *75*

FTP Server

Ethernet, *45*

## M

Modbus

Protocols, *26*

Modbus TCP Server/Client

Ethernet, *26*

## P

Protocols, *19*

IP, *21*

Modbus, *26*

protocols

SNMP, *46*

## S

script commands

firewall, *75*

SNMP

Ethernet, *46*

protocols, *46*

## W

Web server

Ethernet, *28*

