

PacDrive Logic Motion Controller

LMC Pro/Pro2

Hardware Guide

Original instructions

EIO0000001503.08
07/2023

Legal Information

The Schneider Electric brand and any trademarks of Schneider Electric SE and its subsidiaries referred to in this guide are the property of Schneider Electric SE or its subsidiaries. All other brands may be trademarks of their respective owners.

This guide and its content are protected under applicable copyright laws and furnished for informational use only. No part of this guide may be reproduced or transmitted in any form or by any means (electronic, mechanical, photocopying, recording, or otherwise), for any purpose, without the prior written permission of Schneider Electric.

Schneider Electric does not grant any right or license for commercial use of the guide or its content, except for a non-exclusive and personal license to consult it on an "as is" basis. Schneider Electric products and equipment should be installed, operated, serviced, and maintained only by qualified personnel.

As standards, specifications, and designs change from time to time, information contained in this guide may be subject to change without notice.

To the extent permitted by applicable law, no responsibility or liability is assumed by Schneider Electric and its subsidiaries for any errors or omissions in the informational content of this material or consequences arising out of or resulting from the use of the information contained herein.

As part of a group of responsible, inclusive companies, we are updating our communications that contain non-inclusive terminology. Until we complete this process, however, our content may still contain standardized industry terms that may be deemed inappropriate by our customers.

©2023 Schneider Electric. All rights reserved.

Table of Contents

Safety Information	5
QUALIFICATION OF PERSONNEL	5
INTENDED USE	6
Before You Begin	6
Start-up and Test	7
Operation and Adjustments	7
About the Book	9
Specific Safety Information	12
Product Related Information	12
Intended Use	17
System Overview	19
System Overview	19
Logic Motion Controller	20
Lexium 62 Drive System	20
Lexium 52	23
Lexium 62 Servo Drive	23
SH3 Servo Motor	24
Type Code	25
Nameplate Descriptions	26
Engineering	27
Electromagnetic Compatibility, EMC	27
Electromagnetic Compatibility, EMC	27
Control Cabinet Planning	29
Degree of Protection (IP)	29
Mechanical and Climatic Environmental Conditions in the Control Cabinet	30
Using Cooling Units	30
Information about Wiring	31
General Information about Wiring	31
Cable Characteristics	32
Configuring and Coding the Cables	32
ESD Protection Measures	33
Installation and Maintenance	34
Commissioning	34
Prerequisites for Commissioning	34
Preparing Commissioning	34
Preparing the Control Cabinet	36
Mechanical Mounting	37
Wiring	37
Completion of Commissioning	39
Maintenance, Repair, Cleaning, Replacement Equipment Inventory	40
Prerequisites for Maintenance, Repair, and Cleaning	40
Battery Compartment	40
Maintenance - Uninterruptible Power Supply	42
Machine Repair	42
Cleaning	43
Replacement Equipment Inventory	43

Replacing Components and Cables	44
Prerequisites for Replacing Components and Cables.....	44
Device Replacement	45
Fast Device Replacement (FDR) - Introduction	46
Fast Device Replacement - Usage.....	46
Fast Device Replacement - Controller Display	48
Fast Device Replacement - Application.....	49
Cable Replacement.....	53
Indicators and Control Elements	55
Indicators of the Controller.....	55
Menu Navigation.....	60
CompactFlash Card Slot	63
Buttons	64
Integrated Communication Ports.....	65
Electrical Connections Overview	65
Connection Details Controller	66
Technical Data	79
Ambient Conditions.....	79
Standards and Regulations.....	81
Mechanical and Electrical Data	81
Dimensions	86
Uninterruptible Power Supply UPS.....	87
Retrofitting Installation of UPS	87
Optional Modules	90
Fieldbus Combinations.....	90
Communication Module OM-NE.....	90
Overview	90
Initial Installation of the Optional Module	91
Removal of the Optional Module (No Replacement).....	92
Replacement of the Optional Module	93
Electrical Connections	94
Communication Module OM-P	96
Overview	96
Initial Installation of the Optional Module	97
Removal of the Optional Module (No Replacement).....	98
Replacement of the Optional Module	98
Electrical Connections	99
Communication Module OM-C.....	100
Overview	100
Initial Installation of the Optional Module	101
Removal of the Optional Module (No Replacement).....	102
Replacement of the Optional Module	102
Electrical Connections	103
Appendices	105
Disposal	106
Disposal.....	106
Index.....	107

Safety Information

Important Information

Read these instructions carefully, and look at the equipment to become familiar with the device before trying to install, operate, service, or maintain it. The following special messages may appear throughout this documentation or on the equipment to warn of potential hazards or to call attention to information that clarifies or simplifies a procedure.



The addition of this symbol to a “Danger” or “Warning” safety label indicates that an electrical hazard exists which will result in personal injury if the instructions are not followed.



This is the safety alert symbol. It is used to alert you to potential personal injury hazards. Obey all safety messages that follow this symbol to avoid possible injury or death.

⚠ DANGER
DANGER indicates a hazardous situation which, if not avoided, will result in death or serious injury.
⚠ WARNING
WARNING indicates a hazardous situation which, if not avoided, could result in death or serious injury.
⚠ CAUTION
CAUTION indicates a hazardous situation which, if not avoided, could result in minor or moderate injury.
NOTICE
NOTICE is used to address practices not related to physical injury.

Please Note

Electrical equipment should be installed, operated, serviced, and maintained only by qualified personnel. No responsibility is assumed by Schneider Electric for any consequences arising out of the use of this material.

A qualified person is one who has skills and knowledge related to the construction and operation of electrical equipment and its installation, and has received safety training to recognize and avoid the hazards involved.

QUALIFICATION OF PERSONNEL

Only appropriately trained persons who are familiar with and understand the contents of this manual and all other pertinent product documentation are authorized to work on and with this product.

The qualified person must be able to detect possible hazards that may arise from parameterization, modifying parameter values and generally from mechanical, electrical, or electronic equipment. The qualified person must be familiar with the standards, provisions, and regulations for the prevention of industrial accidents, which they must observe when designing and implementing the system.

INTENDED USE

The products described or affected by this document, together with software, accessories, and options, are programmable logic controllers (referred to herein as "logic controllers"), intended for industrial use according to the instructions, directions, examples, and safety information contained in the present document and other supporting documentation.

The product may only be used in compliance with all applicable safety regulations and directives, the specified requirements, and the technical data.

Prior to using the product, you must perform a risk assessment in view of the planned application. Based on the results, the appropriate safety-related measures must be implemented.

Since the product is used as a component in an overall machine or process, you must ensure the safety of persons by means of the design of this overall system.

Operate the product only with the specified cables and accessories. Use only genuine accessories and spare parts.

Any use other than the use explicitly permitted is prohibited and can result in unanticipated hazards.

Before You Begin

Do not use this product on machinery lacking effective point-of-operation guarding. Lack of effective point-of-operation guarding on a machine can result in serious injury to the operator of that machine.

▲ WARNING

UNGUARDED EQUIPMENT

- Do not use this software and related automation equipment on equipment which does not have point-of-operation protection.
- Do not reach into machinery during operation.

Failure to follow these instructions can result in death, serious injury, or equipment damage.

This automation equipment and related software is used to control a variety of industrial processes. The type or model of automation equipment suitable for each application will vary depending on factors such as the control function required, degree of protection required, production methods, unusual conditions, government regulations, etc. In some applications, more than one processor may be required, as when backup redundancy is needed.

Only you, the user, machine builder or system integrator can be aware of all the conditions and factors present during setup, operation, and maintenance of the machine and, therefore, can determine the automation equipment and the related safeties and interlocks which can be properly used. When selecting automation and control equipment and related software for a particular application, you should refer to the applicable local and national standards and regulations. The National Safety Council's Accident Prevention Manual (nationally recognized in the United States of America) also provides much useful information.

In some applications, such as packaging machinery, additional operator protection such as point-of-operation guarding must be provided. This is necessary if the operator's hands and other parts of the body are free to enter the pinch points or other hazardous areas and serious injury can occur. Software products alone cannot protect an operator from injury. For this reason the software cannot be substituted for or take the place of point-of-operation protection.

Ensure that appropriate safeties and mechanical/electrical interlocks related to point-of-operation protection have been installed and are operational before

placing the equipment into service. All interlocks and safeties related to point-of-operation protection must be coordinated with the related automation equipment and software programming.

NOTE: Coordination of safeties and mechanical/electrical interlocks for point-of-operation protection is outside the scope of the Function Block Library, System User Guide, or other implementation referenced in this documentation.

Start-up and Test

Before using electrical control and automation equipment for regular operation after installation, the system should be given a start-up test by qualified personnel to verify correct operation of the equipment. It is important that arrangements for such a check are made and that enough time is allowed to perform complete and satisfactory testing.

▲ WARNING

EQUIPMENT OPERATION HAZARD

- Verify that all installation and set up procedures have been completed.
- Before operational tests are performed, remove all blocks or other temporary holding means used for shipment from all component devices.
- Remove tools, meters, and debris from equipment.

Failure to follow these instructions can result in death, serious injury, or equipment damage.

Follow all start-up tests recommended in the equipment documentation. Store all equipment documentation for future references.

Software testing must be done in both simulated and real environments.

Verify that the completed system is free from all short circuits and temporary grounds that are not installed according to local regulations (according to the National Electrical Code in the U.S.A, for instance). If high-potential voltage testing is necessary, follow recommendations in equipment documentation to prevent accidental equipment damage.

Before energizing equipment:

- Remove tools, meters, and debris from equipment.
- Close the equipment enclosure door.
- Remove all temporary grounds from incoming power lines.
- Perform all start-up tests recommended by the manufacturer.

Operation and Adjustments

The following precautions are from the NEMA Standards Publication ICS 7.1-1995:

(In case of divergence or contradiction between any translation and the English original, the original text in the English language will prevail.)

- Regardless of the care exercised in the design and manufacture of equipment or in the selection and ratings of components, there are hazards that can be encountered if such equipment is improperly operated.

- It is sometimes possible to misadjust the equipment and thus produce unsatisfactory or unsafe operation. Always use the manufacturer's instructions as a guide for functional adjustments. Personnel who have access to these adjustments should be familiar with the equipment manufacturer's instructions and the machinery used with the electrical equipment.
- Only those operational adjustments required by the operator should be accessible to the operator. Access to other controls should be restricted to prevent unauthorized changes in operating characteristics.

About the Book

Document Scope

Read and understand the material contained in this manual before you work on the controller for the first time. Take particular note of the chapter *Specific Safety Information*, page 12. Only those persons who meet the criteria described in *Qualification of Personnel* are allowed to work with the controller.

A copy of this manual must be available for personnel who work with the controller.

This manual is to help you use the capabilities of the controller safely and properly.

Follow the instructions within this manual to help:

- Reduce risks
- Reduce repair costs and downtime of the controller
- Increase the service life of the controller
- Increase reliability of the controller

Validity Note

This document has been updated for the release of EcoStruxure™ Machine Expert V2.1.1.

The characteristics that are described in the present document, as well as those described in the documents included in the Related Documents section below, can be found online. To access the information online, go to the Schneider Electric home page www.se.com/ww/en/download/.

The characteristics that are described in the present document should be the same as those characteristics that appear online. In line with our policy of constant improvement, we may revise content over time to improve clarity and accuracy. If you see a difference between the document and online information, use the online information as your reference.

For product compliance and environmental information (RoHS, REACH, PEP, EOL, etc.), go to www.se.com/ww/en/work/support/green-premium/.

Related Documents

Document title	Reference
Lexium 62 Hardware Guide	EIO0000001349 (ENG); EIO0000001350 (GER);
Lexium 52 Hardware Guide	EIO0000001347 (ENG); EIO0000001348 (GER);
Lexium 62 ILM Hardware Guide	EIO0000001351 (ENG); EIO0000001352 (GER);
SH3 Servo Motor - User Guide	0198441113987 (ENG); 0198441113988 (FRE); 0198441113986 (GER); 0198441113990 (SPA); 0198441113989 (ITA); 0198441113991 (CHS);
How can I... Reduce Vulnerability to Cyber Attacks	Cybersecurity_STN_v2 (ENG)

Document title	Reference
Cybersecurity Assessment – The Most Critical Step to Secure an Industrial Control System	998-20298472 (ENG)
Effective Implementation of Cybersecurity Countermeasures in Industrial Control Systems	998-20304108_GMA-US (ENG)

Terminology Derived from Standards

The technical terms, terminology, symbols and the corresponding descriptions in this manual, or that appear in or on the products themselves, are generally derived from the terms or definitions of international standards.

In the area of functional safety systems, drives and general automation, this may include, but is not limited to, terms such as *safety*, *safety function*, *safe state*, *fault*, *fault reset*, *malfunction*, *failure*, *error*, *error message*, *dangerous*, etc.

Among others, these standards include:

Standard	Description
IEC 61131-2:2007	Programmable controllers, part 2: Equipment requirements and tests.
ISO 13849-1:2015	Safety of machinery: Safety related parts of control systems. General principles for design.
EN 61496-1:2013	Safety of machinery: Electro-sensitive protective equipment. Part 1: General requirements and tests.
ISO 12100:2010	Safety of machinery - General principles for design - Risk assessment and risk reduction
EN 60204-1:2006	Safety of machinery - Electrical equipment of machines - Part 1: General requirements
ISO 14119:2013	Safety of machinery - Interlocking devices associated with guards - Principles for design and selection
ISO 13850:2015	Safety of machinery - Emergency stop - Principles for design
IEC 62061:2015	Safety of machinery - Functional safety of safety-related electrical, electronic, and electronic programmable control systems
IEC 61508-1:2010	Functional safety of electrical/electronic/programmable electronic safety-related systems: General requirements.
IEC 61508-2:2010	Functional safety of electrical/electronic/programmable electronic safety-related systems: Requirements for electrical/electronic/programmable electronic safety-related systems.
IEC 61508-3:2010	Functional safety of electrical/electronic/programmable electronic safety-related systems: Software requirements.
IEC 61784-3:2016	Industrial communication networks - Profiles - Part 3: Functional safety fieldbuses - General rules and profile definitions.
2006/42/EC	Machinery Directive
2014/30/EU	Electromagnetic Compatibility Directive
2014/35/EU	Low Voltage Directive

In addition, terms used in the present document may tangentially be used as they are derived from other standards such as:

Standard	Description
IEC 60034 series	Rotating electrical machines
IEC 61800 series	Adjustable speed electrical power drive systems
IEC 61158 series	Digital data communications for measurement and control – Fieldbus for use in industrial control systems

Finally, the term *zone of operation* may be used in conjunction with the description of specific hazards, and is defined as it is for a *hazard zone* or *danger zone* in the *Machinery Directive (2006/42/EC)* and *ISO 12100:2010*.

NOTE: The aforementioned standards may or may not apply to the specific products cited in the present documentation. For more information concerning the individual standards applicable to the products described herein, see the characteristics tables for those product references.

Specific Safety Information

Overview

This chapter contains important safety information regarding working with the controller. The controller conforms to recognized technical safety regulations.

Product Related Information

Overview

Health and safety risks arising from the controller have been reduced. However a residual risk remains, since the controller works with electrical voltage and electrical currents.

If activities involve residual risks, a safety message is made at the appropriate points. This includes potential hazard(s) that may arise, their possible consequences, and describes preventive measures to avoid the hazard(s).

Electrical Parts

DANGER

HAZARD OF ELECTRIC SHOCK, EXPLOSION OR ARC FLASH

- Disconnect all power from all equipment including connected devices prior to removing any covers or doors, or installing or removing any accessories, hardware, cables, or wires except under the specific conditions specified in the appropriate hardware guide for this equipment.
- Always use a properly rated voltage sensing device to confirm the power is off where and when indicated.
- Replace and secure all covers, accessories, hardware, cables, and wires and confirm that a proper ground connection exists before applying power to the unit.
- Use only the specified voltage when operating this equipment and any associated products.

Failure to follow these instructions will result in death or serious injury.

DANGER

ELECTRIC SHOCK, EXPLOSION, OR ARC FLASH

- Operate electrical components only with a connected protective ground (earth) cable.
- After the installation, verify the secure connection of the protective ground (earth) cable to all electrical devices to ensure that connection complies with the connection diagram.
- Before enabling the device, safely cover the live components to prevent contact.
- Do not touch the electrical connection points of the components when the module is energized.
- Provide protection against indirect contact.
- Connect and disconnect cables and terminals only after you have verified that the power has been removed from the system.

Failure to follow these instructions will result in death or serious injury.

Assembly and Handling

This product has a leakage (touch) current greater than 3.5 mA. If the protective ground connection is interrupted, a hazardous leakage (touch) current may flow if the housing is touched.

⚠ DANGER

INSUFFICIENT GROUNDING

- Use a protective ground copper conductor with at least 10 mm² (AWG 6) or two protective ground copper conductors with the same or larger cross section of the conductors supplying the power terminals.
- Verify compliance with all local and national electrical code requirements as well as all other applicable regulations with respect to grounding of all equipment.

Failure to follow these instructions will result in death or serious injury.

⚠ WARNING

CRUSHING, SHEARING, CUTTING AND HITTING DURING HANDLING

- Observe the general construction and safety regulations for handling and assembly.
- Use appropriate mounting and transport equipment and use appropriate tools.
- Prevent clamping and crushing by taking appropriate precautions.
- Cover edges and angles to protect against cutting damage.
- Wear appropriate protective clothing (for example, protective goggles, protective boots, protective gloves).

Failure to follow these instructions can result in death, serious injury, or equipment damage.

⚠ WARNING

UNINTENDED EQUIPMENT OPERATION

- Use appropriate safety interlocks where personnel and/or equipment hazards exist.
- Install and operate this equipment in an enclosure appropriately rated for its intended environment and secured by a keyed or tooling locking mechanism.
- Use the sensor and actuator power supplies only for supplying power to the sensors or actuators connected to the module.
- Power line and output circuits must be wired and fused in compliance with local and national regulatory requirements for the rated current and voltage of the particular equipment.
- Do not use this equipment in safety-critical machine functions unless the equipment is otherwise designated as functional safety equipment and conforming to applicable regulations and standards.
- Do not disassemble, repair, or modify this equipment.
- Do not connect any wiring to reserved, unused connections, or to connections designated as No Connection (N.C.).

Failure to follow these instructions can result in death, serious injury, or equipment damage.

Hazardous Movements

There can be different sources of hazardous movements:

- No, or incorrect, homing of the drive
- Wiring or cabling errors
- Errors in the application program
- Component errors
- Error in the measured value and signal transmitter

NOTE: Provide for personal safety by primary equipment monitoring or measures. Do not rely only on the internal monitoring of the drive components. Adapt the monitoring or other arrangements and measures to the specific conditions of the installation in accordance with a risk and error analysis.

⚠ DANGER

UNAVAILABLE OR INADEQUATE PROTECTION DEVICE(S)

- Prevent entry to a zone of operation with, for example, protective fencing, mesh guards, protective coverings, or light barriers.
- Dimension the protective devices properly and do not remove them.
- Do not make any modifications that can degrade, incapacitate, or in any way invalidate protection devices.
- Before accessing the drives or entering the zone of operation, bring the drives and the motors they control to a stop.
- Protect existing workstations and operating terminals against unauthorized operation.
- Position EMERGENCY STOP switches so that they are easily accessible and can be reached quickly.
- Validate the functionality of EMERGENCY STOP equipment before start-up and during maintenance periods.
- Prevent unintentional start-up by disconnecting the power connection of the drive using the EMERGENCY STOP circuit or using an appropriate lock-out tag-out sequence.
- Validate the system and installation before the initial start-up.
- Avoid operating high-frequency, remote control, and radio devices close to the system electronics and their feed lines, and perform, if necessary, an EMC validation of the system.

Failure to follow these instructions will result in death or serious injury.

Drive systems may perform unanticipated movements because of incorrect wiring, incorrect settings, incorrect data or other errors.

⚠ WARNING

UNINTENDED MOVEMENT OR MACHINE OPERATION

- Carefully install the wiring in accordance with the EMC requirements.
- Do not operate the product with undetermined settings and data.
- Perform comprehensive commissioning tests that include verification of configuration settings and data that determine position and movement.

Failure to follow these instructions can result in death, serious injury, or equipment damage.

PELV Circuits

The signal voltage and the control voltage of the devices are less than 30 Vdc and have to be designed as PELV (Protective Extra Low Voltage) circuits. In this range, the specification as PELV system, according to IEC 61800-5-1 requires a protective measure against direct and indirect contact with hazardous voltage through an implemented separation in the system/machine of the primary and the

secondary side. Separate high and low voltage wiring and respect the standard IEC 61800-5-1, Adjustable speed electrical power drive systems - safety requirements.

⚠ WARNING

POTENTIAL OF OVERHEATING AND FIRE

- Do not connect the equipment directly to line voltage.
- Use only isolating PELV power supplies and circuits to supply power to the equipment¹.

Failure to follow these instructions can result in death, serious injury, or equipment damage.

¹ For compliance to UL (Underwriters Laboratories) requirements, the power supply must also conform to the various criteria of NEC Class 2, and be inherently current limited to a maximum power output availability of less than 100 VA (approximately 4 A at nominal voltage), or not inherently limited but with an additional protection device such as a circuit breaker or fuse meeting the requirements of clause 9.4 Limited-energy circuit of UL 61010-1. In all cases, the current limit should never exceed that of the electric characteristics and wiring diagrams for the equipment described in the present documentation. In all cases, the power supply must be grounded, and you must separate Class 2 circuits from other circuits. If the indicated rating of the electrical characteristics or wiring diagrams are greater than the specified current limit, multiple Class 2 power supplies may be used.

Cybersecurity

Cybersecurity is a branch of network administration that addresses attacks on or by computer systems and through computer networks that can result in accidental or intentional disruptions.

The objective of cybersecurity is to help provide increased levels of protection for information and physical assets from theft, corruption, misuse or accidents while maintaining access for their intended users.

Schneider Electric adheres to industry best practices in the development and implementation of control systems. This includes a "Defense-in-Depth" approach to secure an Industrial Control System. This approach places the controllers behind one or more firewalls to restrict access to authorized personnel and protocols only.

⚠ WARNING

UNAUTHENTICATED ACCESS AND SUBSEQUENT UNAUTHORIZED MACHINE OPERATION

- Evaluate whether your environment or your machines are connected to your critical infrastructure and, if so, take appropriate steps in terms of prevention, based on Defense-in-Depth, before connecting the automation system to any network.
- Limit the number of devices connected to a network to the minimum necessary.
- Isolate your industrial network from other networks inside your company.
- Protect any network against unintended access by using firewalls, VPN, or other, proven security measures.
- Monitor activities within your systems.
- Prevent subject devices from direct access or direct link by unauthorized parties or unauthenticated actions.
- Prepare a recovery plan including backup of your system and process information.

Failure to follow these instructions can result in death, serious injury, or equipment damage.

For more information on organizational measures and rules covering access to infrastructures, refer to ISO/IEC 27000 series, Common Criteria for Information Technology Security Evaluation, ISO/IEC 15408, IEC 62351, ISA/IEC 62443, NIST Cybersecurity Framework, Information Security Forum - Standard of Good Practice for Information Security, and refer to Cybersecurity Guidelines for EcoStruxure Machine Expert, Modicon and PacDrive Controllers and Associated Equipment.

For detailed information on the defense-in-depth approach, refer to: How Can I... Reduce Vulnerability to Cyber Attacks.

To submit a cybersecurity question, report security issues, or get the latest news from Schneider Electric, visit the Schneider Electric website.

Password Management

- Change the passwords every 90 days
- Use a unique password (not related to your personal password)

Backing-up and Restoring the Software Configuration

To protect your data, back-up the system and configuration and keep your backup file in a secure place.

Intended Use

Installation

Install and operate this equipment in a control cabinet (enclosure) appropriately rated for its intended environment and secured by a keyed or tooled locking mechanism.

Provide for Protective Measures

Before installing the device, provide for appropriate protective devices in compliance with local and national standards. Do not commission components without appropriate protective devices. After installation, commissioning, or repair, test the protective devices used.

Perform a risk evaluation concerning the specific use before operating the product and take appropriate safety measures.

▲ WARNING

UNINTENDED EQUIPMENT OPERATION

Ensure that a risk assessment is conducted and respected according to EN/ISO 12100 during the design of your machine.

Failure to follow these instructions can result in death, serious injury, or equipment damage.

If circumstances occur that affect the safety or cause changes to the operating behavior of the controllers, then immediately shut down the controllers and contact your Schneider Electric service representative.

Use Original Equipment Only

Use only the accessories and mounting parts specified in the documentation and no third-party devices or components that have not been expressly approved by Schneider Electric.

There are no user-serviceable parts within the PacDrive LMC Pro/Pro2 components besides the battery, page 40 and the battery pack (UPS), page 87. Either replace the component or contact the Schneider Electric Customer Service.

▲ WARNING

UNINTENDED EQUIPMENT OPERATION

- Only use software and hardware components approved by Schneider Electric for use with this equipment.
- Do not attempt to service this equipment outside of authorized Schneider Electric service centers.
- Update your application program every time you change the physical hardware configuration.

Failure to follow these instructions can result in death, serious injury, or equipment damage.

Environment Restrictions

The components must not be used in the following environments:

- In hazardous (explosive) atmospheres
- In mobile, movable, or floating systems
- In life support systems
- In domestic appliances
- Underground

This equipment has been designed to operate outside of any hazardous location. Only install this equipment in zones known to be free of a hazardous atmosphere.

⚠ DANGER

POTENTIAL FOR EXPLOSION

Install and use this equipment in non-hazardous locations only.

Failure to follow these instructions will result in death or serious injury.

System Overview

System Overview

System Overview

The control system consists of several components, depending on its application.

PacDrive 3 system overview

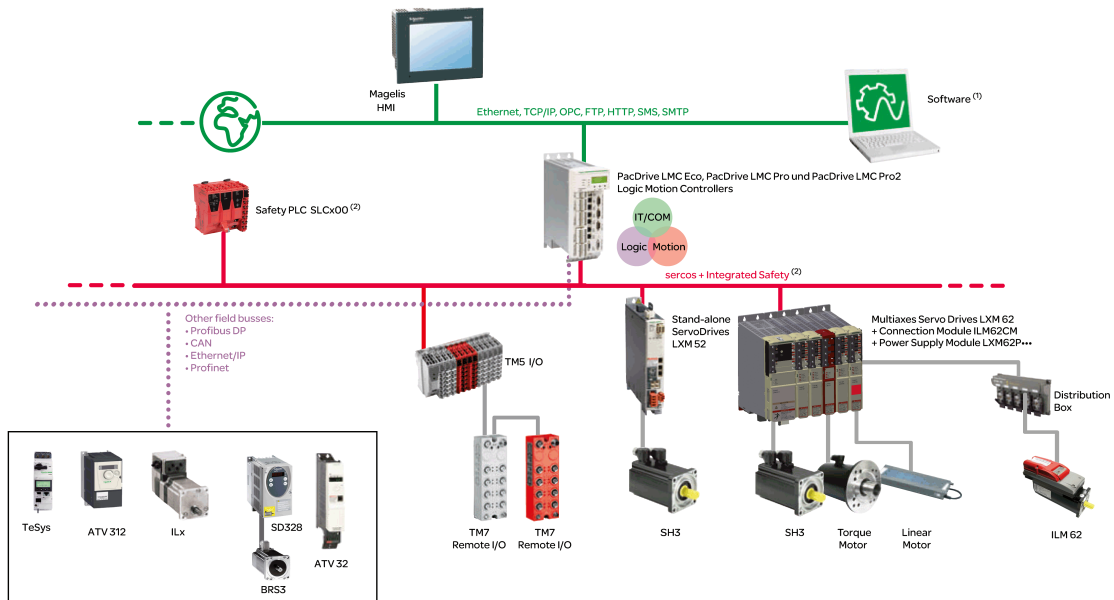

1 EcoStruxure Machine Expert Software

2 Safety Logic Controller according to IEC 61508 and ISO 13849

Logic Motion Controller

Overview

Product	Description
	<p>The PacDrive LMC (Logic Motion Controller), with a VxWorks real-time operating system, centrally implements the Logic Controller and motion functions. A PacDrive LMC synchronizes, coordinates, and creates the motion functions of a machine for a maximum of:</p> <ul style="list-style-type: none"> • 0 Sercos servo drives for the controller PacDrive LMC100 • 4 Sercos servo drives for the controller PacDrive LMC101 • 6 Sercos servo drives for the controller PacDrive LMC106 • 8 Sercos servo drives for the controller PacDrive LMC201 • 12 Sercos servo drives for the controller PacDrive LMC212 • 16 Sercos servo drives for the controller PacDrive LMC216 • 8 Sercos servo drives for the controller PacDrive LMC300 • 16 Sercos servo drives for the controller PacDrive LMC400 • 16 Sercos servo drives for the controller PacDrive LMC402 • 99 Sercos servo drives for the controller PacDrive LMC600 • 130 Sercos servo drives for the controller PacDrive LMC802 • 130 Sercos servo drives for the controller PacDrive LMC902

Lexium 62 Drive System

Overview

The modular servo drive system Lexium 62 Drive System is designed for the operation of servo drives in a multi-axes system.

The power electronic components of the Lexium 62 Drive System are fitted inside the control cabinet.

Lexium 62 Power Supply

	<p>Using a common DC bus, the central power supply unit Lexium 62 Power Supply supplies the connected servo converters with the power required.</p> <p>The central Lexium 62 Power Supply, using a common DC bus, supplies the connected Lexium 62 Servo Drives with the power required.</p>
---	--

Lexium 62 Connection Module

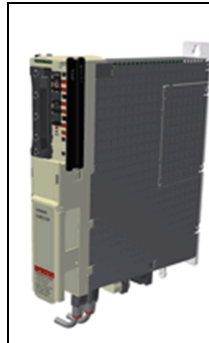

The Lexium 62 Connection Module supplies the Lexium 62 ILMs with DC voltage from the DC bus via a hybrid cable or via a power cable (daisy chain wiring). Additionally, the Lexium 62 Connection Module provides the Inverter Enable and Sercos interface.

The Lexium 62 Drive System helps simplify the wiring of the devices in relation to the initial start-up and in service cases. This also applies to the cable connection of the enclosed devices to the field. All the connectors that can be connected from the outside (power input, DC bus, 24 Vdc supply, Sercos, Ready, and Inverter Enable) are designed such, that a fast and simple configuration without tools can be realized on the device.

Lexium 62 Distribution Box

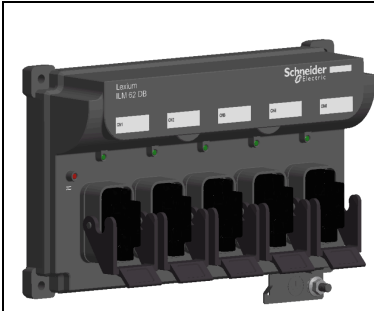

The Lexium 62 Distribution Box is the link between Lexium 62 Connection Module and Lexium 62 ILM. Depending on the number of drives, 1 to 4 Lexium 62 ILMs or daisy chain lines can be connected. When operating more than four drives, simply expand the system using one or more Lexium 62 Distribution Box.

The highlights:

- 1...4 connections for Lexium 62 ILMs or daisy chain lines or further Lexium 62 Distribution Box
- Easy wiring using pre-assembled hybrid cables or power cables (daisy chain wiring)
- Easy to expand

Lexium 62 ILM



The innovative Lexium 62 ILM combines motor, power stage, and digital servo controller for an axis in a space-saving housing. Due to its compact construction with the integrated controller, it is perfectly suitable for peripheral setup. It is available with individual or multi-turn encoders and configures itself with the aid of the electronic nameplate in the Lexium 62 ILM.



The Lexium 62 ILMs are available in three different flange sizes:

- ILM070
- ILM100
- ILM140

The highlights:

- Compact type of construction
- 3.5 times peak torque
- Integrated Sercos interface
- High-resolution single or multi-turn encoder
- Degree of protection IP65
- Simple wiring

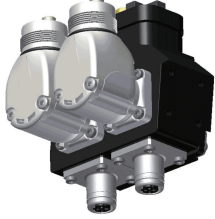
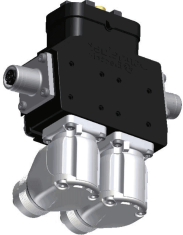
ILM Daisy Chain Connector Box

 <p>ILM62DCA000</p>	<p>The ILM Daisy Chain Connector Box is mounted on a standard Lexium 62 ILM in order to enable a daisy chain wiring. The Lexium 62 ILMs can be either directly connected to the Lexium 62 Distribution Box or via a Lexium 62 Connection Module. When connecting via a Lexium 62 Distribution Box, a larger number of drives can be connected. At this first Lexium 62 Distribution Box another Lexium 62 Distribution Box can be connected.</p>
 <p>ILM62DCB000</p>	<p>Power (DC bus voltage/24V/Inverter Enable signals) and Sercos signals are distributed via separate cables. Each Lexium 62 ILM must be extended by a Daisy Chain Connector Box. If only one Lexium 62 Distribution Box is used, then up to four daisy chain lines can be connected to it. If several Lexium 62 Distribution Box are used, then on the first, up to the second to last Lexium 62 Distribution Box respectively up to three daisy chain lines can be connected and on the last Lexium 62 Distribution Box up to four daisy chain lines. A daisy chain line can consist of up to 9 Lexium 62 ILMs.</p>
 <p>ILM62DCC000</p>	

The connection between the Lexium 62 ILMs is established as follows:

- Power cable for power distribution (DC bus voltage/24 V/Inverter Enable signals) with an M23 connector
- Sercos cable for distribution of the Sercos signals via M12 connector

The following Lexium 62 ILMs can be equipped with the Daisy Chain Connector Box in order to implement a daisy chain wiring:

- ILM070••
- ILM100••
- ILM140••

The Daisy Chain Connector Box is available in the following variants:

- ILM62DCA000 (suitable for ILM070••, ILM100•• and ILM140••)
- ILM62DCB000 (suitable for ILM070•• only)
- ILM62DCC000 (suitable for ILM100•• only)

Lexium 52

Overview

Product	Description
	<p>The stand-alone Lexium 52 Sercos servo amplifier is designed for servo drive solutions with independent single axes, or other applications involving asynchronous motors.</p> <p>The power electronic components of the Lexium 52 are fitted inside the control cabinet. The drive provides the phase currents required for the position control of the connected motors. According to the different requirements in relation to the individual servo axes of the application, the Lexium 52 is available in different current classes. The Lexium 52 helps simplify the wiring in relation to the initial start-up and service cases. This also applies to the cable connection of the enclosed devices to the field. All the connectors that can be connected from the outside (power input, DC bus, 24 Vdc supply, Sercos, motor, encoder, I/Os, I/O supply, Ready and Inverter Enable (STO)) are designed so that a fast, simple configuration on the device can be realized.</p>

References

Product	Reference
Drive	LXM52DU60C LXM52DD12C LXM52DD18C LXM52DD30C LXM52DD72C

Lexium 62 Servo Drive

Overview

The servo drive system Lexium 62 is used for the operation of servo drives in a multi-axis group.

The power electronic components of the Lexium 62 are fitted inside the control cabinet.

Product	Description
	<p>The Lexium 62 Servo Drives provide the necessary phase currents for the position control of the connected servo motors. The Lexium 62 Servo Drives includes Lexium 62 Single Drives and/or Lexium 62 Double Drives.</p> <p>In addition, Lexium 62 Servo Drives are suitable for applications involving asynchronous motors.</p> <p>According to the different requirements in relation to the individual servo axes of the application, the Lexium 62 Servo Drives are available in different current classes.</p> <p>The Lexium 62 helps to simplify the wiring of the drives. This also applies to the cable connection of the enclosed drives to the field. The connectors that can be connected from the outside (power input, DC bus, 24 Vdc supply, Sercos, motor, encoder, I/O modules, I/O supply, Ready, and Inverter Enable) are designed so that a fast, simple configuration on the drive can be realized.</p>

SH3 Servo Motor

Overview

Product	Description
	<p>The SH3 motors are low-inertia AC synchronous servo motors designed for highly dynamic positioning tasks.</p> <p>A drive system consists of the servo motor and the drive. Maximum performance requires the motor and drive to be adapted to each other.</p>

High Dynamic AC Servo Motors

Because of the low inertia and a high overload capability, the motor SH3 fulfills many requirements concerning the accuracy, dynamics, and efficiency.

The SH3 motors are available in six different flange sizes:

- SH3-040 (40 mm / 1.57 in.)
- SH3-055 (55 mm / 2.17 in.)
- SH3-070 (70 mm / 2.76 in.)
- SH3-100 (100 mm / 3.94 in.)
- SH3-140 (140 mm / 5.51 in.)
- SH3-205 (205 mm / 8.07 in.)

Characteristics

The motors have the following features:

- Overload protection by integrated temperature sensor (external evaluation required)
- Low moment of inertia
- High power density
- Excellent dynamics

- High overload capability
- Broad torque range
- Special winding for low phase currents
- Motor connection via circular connectors
- Easy commissioning via electronic nameplate in SinCos encoder
- Low maintenance

Options and Accessories

The motors are available with various options such as:

- Various encoder systems
- Holding brake
- Various shaft versions
- Various degrees of protection
- Various lengths
- Various sizes
- Various connection versions

For further information, refer to the *SH3 Servo Motor - User Guide* (see SH3 Servo Motor, User Guide).

Type Code

Overview

The graphic shows the type code PacDrive LMC Pro/Pro2:



Family	Size			Type	Modules		HW	Internal		Internal	
root	1	2	3	4	5	6	7	8	9	10	11
L M C	3	0	0	C	A	A	1	0	0	0	0

Family
LMC = Lexium Controller

Size
300 = max. 8 servo axes
400 = max. 16 servo axes
402 = max. 16 servo axes
600 = max. 99 servo axes
802 = max. 130 servo axes
902 = max. 130 servo axes

Type
C = Controller based

Modules (not for LMC 101/201)
AA = None
BB = CAN OM-C
BC = Profibus DP OM-P
BD = RT-Ethernet OM-NE
BG = 2x OM-NE
BI = 1x OM-C + 1x OM-NE
BL = 1x OM-P + 1x OM-NE
CA = USV (Accu)
CB = USV (Accu) + CAN OM-C
CC = USV (Accu) + Profibus DP OM-P
CD = USV (Accu) + RT-Ethernet OM-NE
CG = USV (Accu) + 2xOM-NE
CI = USV (Accu) + 1x OM-C + 1x OM-NE
CL = USV (Accu) + 1x OM-P + 1x OM-NE

Hardware - Release

Nameplate Descriptions

Overview

The Logic Motion Controller (LMC) nameplate is located on the side of the housing:



Explanation of the technical nameplate entries:

Label	Description
LMC400Cxxxxxx	Device type and Unicode
Input d.c	Digital inputs / input voltage and input current (per input)
Output d.c.	Digital outputs / output voltage and rated current (per input)
IP20	Degree of protection
CE (symbol)	CE mark

The logistical nameplate of the LMC is located on top of the housing.

Label	Description
LMC400CCABA00	Device type and Unicode
907156.0010	Serial number
RS:02	Hardware revision ⁽¹⁾
DOM	Date of manufacture
(1)	When replacing the controller, page 45, the hardware revision for the previous and the new device should be identical to help avoid potential compatibility issues with the equipment. The hardware revision can also be read from the hardware code in the device, page 61. For more information on the compatibility of different hardware revisions, contact your local Schneider Electric representative.

Engineering

Electromagnetic Compatibility, EMC

Electromagnetic Compatibility, EMC

Electromagnetic Disturbances of Signals and Devices

This product meets the EMC requirements in accordance with the standard IEC 61131-2, provided that the EMC measures described in this manual are complied with during installation.

▲ WARNING

SIGNAL AND EQUIPMENT INTERFERENCE

- Install the wiring in accordance with the EMC requirements described in the present document.
- Verify compliance with the EMC requirements described in the present document.
- Verify compliance with all EMC regulations and requirements applicable in the country in which the product is to be operated and with all EMC regulations and requirements applicable at the installation site.

Failure to follow these instructions can result in death, serious injury, or equipment damage.

▲ WARNING

ELECTROMAGNETIC DISTURBANCES OF SIGNALS AND DEVICES

Use proper EMC shielding techniques to help prevent unintended device operation in accordance with the standard IEC 61131-2.

Failure to follow these instructions can result in death, serious injury, or equipment damage.

These types of devices are not intended to be used on a low-voltage public network which supplies domestic premises. Radio frequency interference is expected if used in such a network.

▲ WARNING

RADIO INTERFERENCE

Do not use these products in domestic electrical networks.

Failure to follow these instructions can result in death, serious injury, or equipment damage.

Layout Control Cabinet (Enclosure)

The prerequisite for compliance with the specified limit values is an EMC compatible layout. Depending on the application, the following measures can improve the EMC-dependent values:

EMC measures	Objective
Use galvanized or chromium-plated sub plates, bond metallic parts across large surface areas, remove paint layer from contact surfaces.	Good conductivity by surface area contact.
Ground control cabinet (enclosure), door, and sub plates by using grounding strips or grounding cables with a cross-section of 10 mm ² (AWG 6).	Reduce emission.
Supplement switch devices such as contactors, relays, or magnetic valves with interference suppression combinations or spark suppressor elements (for example, diodes, varistors, RC elements).	Reduces mutual interference.
Fit power and control components separately.	Reduces mutual interference.

Shielded Cables

EMC measures	Objective
Connect large surface areas of cable shields, use cable clamps and ground straps.	Reduce emission.
Ground shields of digital signal wires at both ends by connecting them to a large surface area or via conductive connector housings.	Reduce interference action on signal cables, reduce emissions.
Ground shield of analog signal cables directly on the device (signal input), insulate the shield at the other cable end or ground the same through a capacitor, such as 10 nF.	Reduce grounding loops by low frequency interferences.

Cable Installation

EMC measures	Objective
Do not route fieldbus cables and signal wires in a single cable duct together with lines with DC and AC voltages of more than 60 V. (Fieldbus cables, signal lines, and analog lines may be in the same cable duct). Electromagnetic immunity will improve by routing cables in separated cable ducts with a distance of at least 20 cm (7.84 in).	Reduces mutual interference.
Keep cables as short as possible. Do not install unnecessary cable loops, use short cables from the central grounding point in the control cabinet to the external ground connection.	Reduces capacitive and inductive interference.
Use equipotential bonding conductors (stranded wire of equal potential at all grounding locations connected to an equipotential grounding plane) in the following cases: wide-area installations, different voltage supplies, and installation across several buildings.	Reduces current in the cable shield, reduces emissions.
Use stranded wire potential equalization conductor.	Discharging of high frequency interference currents.
If motor and machine are not conductively connected, for example by an insulated flange or a connection without surface contact, you must ground the motor with a ground strap or a ground wire. The conductor cross section must be at least 10 mm ² (AWG 6).	Reduces emissions, increases immunity.
Use twisted pair for 24 Vdc signals.	Reduce interference action on signal cables, reduce emissions.

Power Supply

EMC measures	Objective
Operate product on mains with grounded neutral point.	Enables effectiveness of mains filter.
Use surge arrester if there is a risk of overvoltage.	Reduces the risk of damage caused by overvoltage.

Motor and Encoder Cables

From an EMC perspective, motor supply cables and encoder cables are particularly important. Only use pre-configured cables, or cables with the prescribed properties, and comply with the following EMC measures.

EMC measures	Objective
Do not install switching elements in motor cables or encoder cables.	Reduces interference.
Route motor cable with a distance of at least 20 cm (7.84 in) to the signal cables or insert shield plates between the motor supply cable and the signal cable.	Reduces mutual interference.
For wiring that approaches the maximum cable distance specification (75 m/ 246.06 ft.), use equipotential bonding connection cables.	Reduce current on cable shield.
Route motor supply cables and encoder cables without any separation point ⁽¹⁾ .	Reduces emission.
(1)	If a cable must be cut through for installation purposes, the cables must be connected at the point of separation by using screen connections and metal housing.

Additional Measures for Improving the EMC

Depending on the respective application, the following measures may lead to an EMC compatible layout:

EMC measures	Objective
Upstream connection of mains line reactor (choke)	Reduction of the harmonic network oscillations, extension of the service life of the product.
Upstream connection of external mains filters	Improvement of the EMC limit values.
Special EMC-appropriate layout, for example, within an enclosed control cabinet complete with 15 dB attenuation of the interferences emitted	Improvement of the EMC limit values.

Control Cabinet Planning

Degree of Protection (IP)

Overview

Install components such that a degree of protection corresponding to the actual operational environment is set up.

For more information on the degree of protection of the equipment, refer to *Ambient Conditions*, page 79.

The following conditions may damage the components:

- Oil
- Moisture
- Electromagnetic interference
- Ambient temperature
- Metal dust deposits

⚠ WARNING
<p>UNINTENDED EQUIPMENT OPERATION</p> <ul style="list-style-type: none"> • Observe and conform to ambient temperatures, storage temperatures and transport temperatures of the individual components as specified in the operating manuals of the components. • Prevent the formation of moisture during the operation, storage and transport of individual components. • Conform to the vibration and shock requirements specified for the equipment when operating, storing and transporting system equipment. <p>Failure to follow these instructions can result in death, serious injury, or equipment damage.</p>

Mechanical and Climatic Environmental Conditions in the Control Cabinet

Overview

Step	Action
1	Observe the climatic and mechanical ambient conditions. For more information on the general climatic and mechanical environmental conditions according to IEC 60721, refer to <i>Ambient Conditions</i> , page 79.
2	Verify the technical data of the device whether the permitted deviations (for example, higher shock load or higher temperature) are specified.

Using Cooling Units

Installing a Cooling Unit

How to proceed when installing a cooling unit:

Step	Action
1	Position the cooling units so that no condensate drips out of the cooling unit onto electronic components or is sprayed by the cooling air flow.
2	Provide specially designed control cabinets for cooling units on the top of the control cabinet.
3	Design the control cabinet so that the cooling unit fan cannot spray any accumulated condensate onto the electronic components when it restarts after a pause.
4	When using cooling units, use only well-sealed control cabinets so that warm, humid outside air, which causes condensation, does not enter the cabinet.
5	When operating control cabinets with open doors during commissioning or maintenance, ensure that the electronic components are at no time cooler than the air in the control cabinet after the doors are shut, in order to avoid any condensation.

Step	Action
6	Continue to operate the cooling unit even when the system is switched off, so that the temperature of the air in the control cabinet and the air in the electronic components remains the same.
7	Set cooling unit to a fixed temperature of 40 °C or lower (104 °F).
8	For cooling units with temperature monitoring, set the temperature limit to 40 °C (104 °F) so that the internal temperature of the control cabinet does not fall below the external air temperature.

⚠ WARNING

UNINTENDED EQUIPMENT OPERATION

Design the cooling unit such that the condensation from the cooling unit cannot enter electrical equipment.

Failure to follow these instructions can result in death, serious injury, or equipment damage.

Installing a cooling unit

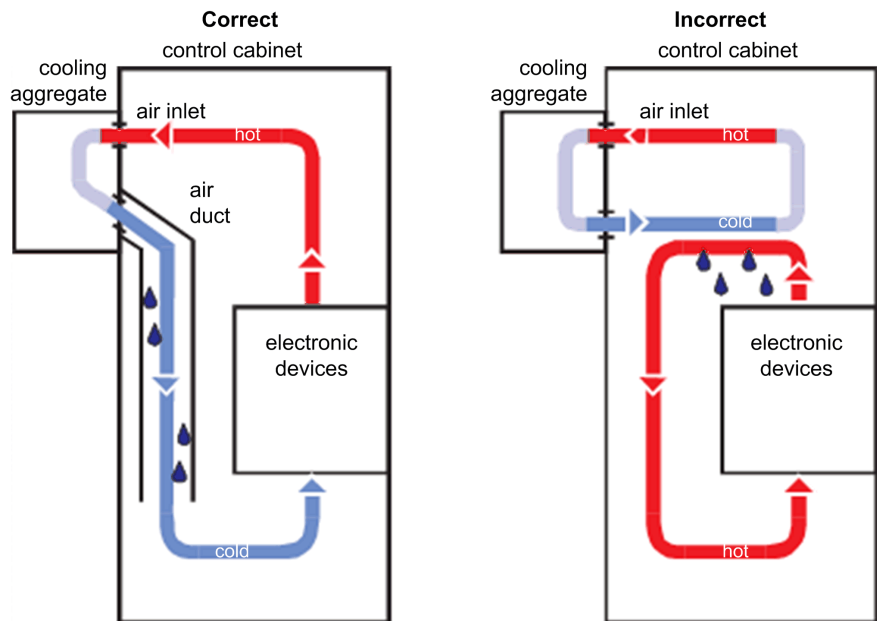

Information about Wiring

General Information about Wiring

Overview

Use only Schneider Electric approved devices in your application, and especially Schneider Electric pre-fabricated cables, wherever and whenever possible.

Use an appropriate torque indication or screwdriver for tightening connections.

Observe and implement the following points when wiring:

1. Observe the minimum cross-sections of the cables necessary for the load carrying capacity of the equipment being connected.
2. Verify the integrity of cable shields to ensure continuity to ground.
3. Ensure that there is a proper, equipotential connection to ground for all interconnected equipment.

4. Eliminate any ground loops.
5. Do not disconnect cable connection terminals when under power.
6. Ensure that all ground connections have sufficient surface area continuity.
7. Do not interchange encoder connections.
8. Do not interchange the emergency stop circuits.

If, for example, two parallel conductors are shown as coming from one point, you may not run just one conductor and then branch it off at a later point. If it is wired this way, induction loops (interference emitters and antennas) as well as interfering potential shifts may occur.

⚠ DANGER

INCORRECT OR UNAVAILABLE GROUNDING

Remove paint across a large surface at the installation points before installing the devices (bare metal connection).

Failure to follow these instructions will result in death or serious injury.

Cable Characteristics

Overview

Cable characteristics of the Sercos cable (see the Schneider Electric catalog for the various cables available):

Property	Value
Voltage isolation (jacket)	300 Vdc
Temperature range	-20...+60 °C / -4...+140 °F
Cable diameter	5.8 ± 0.2 mm (0.23 ± 0.008 in.)
Bending radius	8 x diameter (fixed routing)
Sheath	PVC, flame-retardant
Cable type and shielding	CAT6 with S/FTP (Sercos III)

Configuring and Coding the Cables

Overview

For configuring and coding the cables, use the appropriate connector kit supplied with the device.

Accessory part	Number	Connection designation
Connector control voltage / watchdog	2	CN1
Connector digital outputs	2	CN2
Connector digital inputs	2	CN3
Connector TP / fast digital inputs	2	CN4
Connector analog inputs / outputs	2	CN5
Sercos cable 130 mm (5.11 in)	1	CN12, CN13
PacNet terminating plug	1	CN9

ESD Protection Measures

General

Observe the following instructions to help avoid damages due to electrostatic discharge:

NOTICE

ELECTROSTATIC DISCHARGE

- Do not touch any of the electrical connections or components.
- Prevent electrostatic charges, for example, by wearing appropriate clothing.
- If you must touch circuit boards, do so only on the edges.
- Remove existing static charge by touching a grounded, metallic surface.

Failure to follow these instructions can result in equipment damage.

Installation and Maintenance

Commissioning

Prerequisites for Commissioning

Prerequisites

DANGER

HAZARD OF ELECTRIC SHOCK, EXPLOSION OR ARC FLASH

- Disconnect all power from all equipment including connected devices prior to removing any covers or doors, or installing or removing any accessories, hardware, cables, or wires except under the specific conditions specified in the appropriate hardware guide for this equipment.
- Always use a properly rated voltage sensing device to confirm the power is off where and when indicated.
- Replace and secure all covers, accessories, hardware, cables, and wires and confirm that a proper ground connection exists before applying power to the unit.
- Use only the specified voltage when operating this equipment and any associated products.

Failure to follow these instructions will result in death or serious injury.

DANGER

ELECTRIC SHOCK, EXPLOSION, OR ARC FLASH

- Operate electrical components only with a connected protective ground (earth) cable.
- After the installation, verify the secure connection of the protective ground (earth) cable to all electrical devices to ensure that connection complies with the connection diagram.
- Before enabling the device, safely cover the live components to prevent contact.
- Do not touch the electrical connection points of the components when the module is energized.
- Provide protection against indirect contact.
- Connect and disconnect cables and terminals only after you have verified that the power has been removed from the system.

Failure to follow these instructions will result in death or serious injury.

Preparing Commissioning

Prerequisite

Verify safety-related circuits for proper function, if applicable.

ESD Protection

Observe the following instructions to help avoid damages due to electrostatic discharge:

NOTICE

ELECTROSTATIC DISCHARGE

- Do not touch any of the electrical connections or components.
- Prevent electrostatic charges, for example, by wearing appropriate clothing.
- If you must touch circuit boards, do so only on the edges.
- Remove existing static charge by touching a grounded, metallic surface.

Failure to follow these instructions can result in equipment damage.

Unpacking

How to unpack the device:

Step	Action
1	Remove packaging
2	Dispose of the packaging material in accordance with the relevant local regulations.

Verifying

How to verify the device:

Step	Action
1	Verify that the delivery is complete on the basis of the delivery slip.
2	Closely inspect the device for any signs of damage.
3	Verify the data with the help of the nameplates.
4	Observe requirements for the installation location.
5	In addition to the following instructions, also note the information in the chapter <i>Engineering</i> , page 27.
6	If you intend to install optional modules, refer also to the information in the chapter <i>Optional Modules</i> , page 90.
7	If you intend to install the battery pack (UPS), refer also to the information in the chapter <i>Uninterruptible Power Supply UPS</i> , page 87.

⚠ WARNING

UNINTENDED EQUIPMENT OPERATION

- Do not mount or commission damaged equipment.
- Do not modify the equipment.
- Send back inoperative equipment.

Failure to follow these instructions can result in death, serious injury, or equipment damage.

Preparing the Control Cabinet

Overview

⚠ DANGER

INCORRECT OR UNAVAILABLE GROUNDING

Remove paint across a large surface at the installation points before installing the devices (bare metal connection).

Failure to follow these instructions will result in death or serious injury.

Step	Action
1	If necessary to maintain and respect the maximum ambient operating temperature, install additional fan in the control cabinet.
2	Do not block the fan air inlet of the product.
3	Drill mounting holes in the control cabinet according to the mounting-grid pattern.
4	Keep a distance of at least 100 mm (3.94 in) above and below the products.

Assembly Distances, Ventilation

Assembly distances and air circulation:

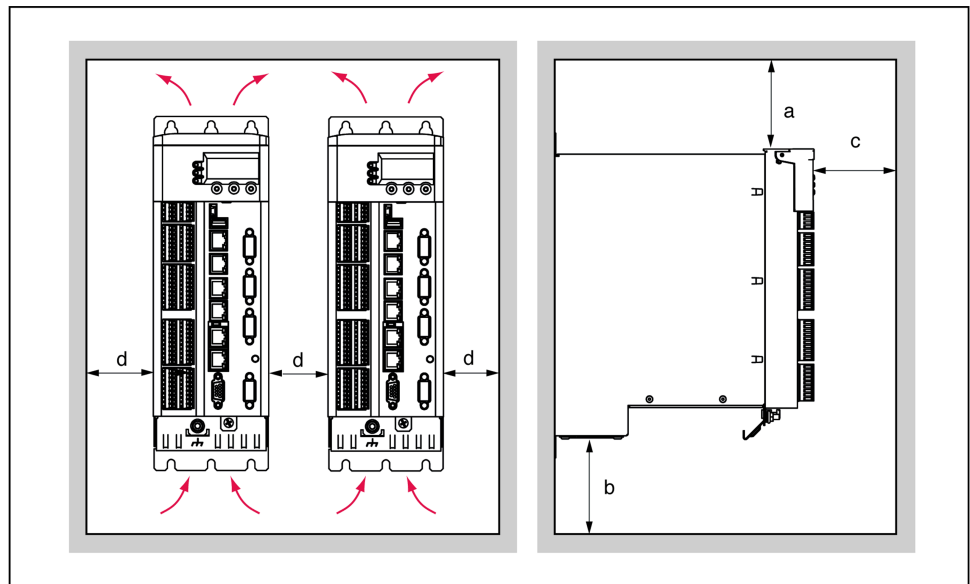

Distance	Air circulation
a ≥ 100 mm (3.94 in)	Clearance above the device.
b ≥ 100 mm (3.94 in)	Clearance below the device.
c ≥ 60 mm (2.36 in)	Clearance in front of the device.
d ≥ 0 mm (0 in)	Clearance between the devices, or between the device and the side of the enclosure, for ambient temperature during operation: +5...+55 °C (41...131 °F) without UPS +5...+40 °C (41...104 °F) with UPS

Required Distances

Required distances in the control cabinet for the PacDrive LMC Pro/Pro2, Lexium 62 Power Supply, Lexium 62 Servo Drive:

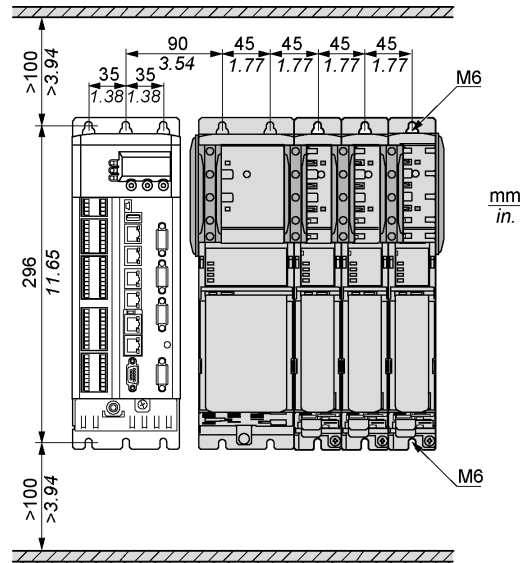

NOTE: For the shield plates (external shield connections), additional holes are required.

Mechanical Mounting

Procedure

Step	Action
1	Screw the pan-head screws M6 (socket head cap screws) into the prepared mounting holes.
2	Keep a distance of 10 mm (0.39 in) between the screw head and the mounting plate.
3	Hook in device and verify the vertical mounting arrangement.
4	Tighten the mounting screws (torque: 4.6 Nm (41 lbf in)).

Wiring

How to Assemble the Modules

To assemble the modules, proceed as follows:

Step	Action
1	Connect the protective conductor with the ring cable lug and the M5 screw to the shield connection of the controller (tightening torque: 1 Nm (8.85 lbf in))
2	Follow the assembly based on the shield connection: <ul style="list-style-type: none"> • Lock washer • Ring cable lug • Lock washer • Washer • Screw
3	Connect the plug-in connector CN1 "24 V supply" to the controller. For important safety information, follow the instructions in the second safety message after this table.
4	Connect the Sercos cable CN12 (CN13) to the power supply

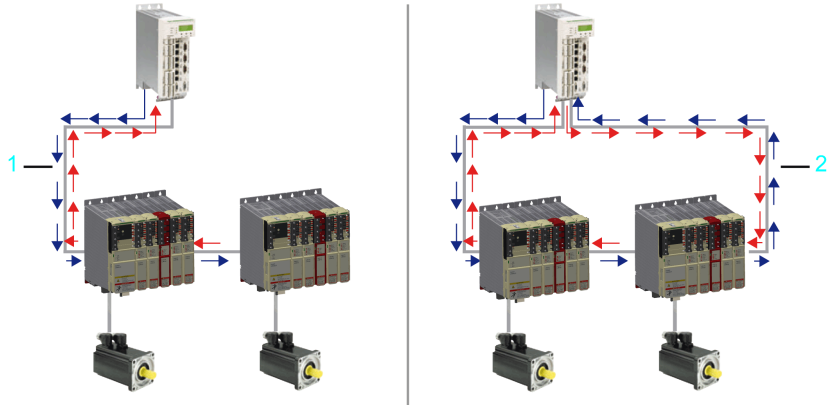
Step	Action
5	<p>Insert the other end of the Sercos cable to CN2 (CN3) into the Lexium 62 Power Supply or Lexium 62 Servo Drive.</p> <p>NOTE: Depending on the device combination, choose the appropriate Sercos cable length.</p> <p>NOTE: If possible, establish a Sercos connection via the ring topology (2).</p> <p>NOTE: If Sercos devices are assigned via the topological addresses (IdentificationMode = TopologyAddress) to the PacDrive LMC Pro/Pro2, then respect the following:</p> <ul style="list-style-type: none"> • Connect your Sercos device to the PacDrive LMC Pro/Pro2 either completely via Sercos port 1 (CN12) in line topology or in ring topology using Sercos port 1 and 2 (CN12/CN13). • Do not connect the Sercos devices to the PacDrive LMC Pro/Pro2 via double line topology (CN12/CN13). • Do not connect the Sercos devices to the PacDrive LMC Pro/Pro2 only via Sercos port 2 (CN13). <p>Line topology and ring topology</p>  <p>1 Line topology</p> <p>2 Ring topology</p>
6	Optionally, connect the plug-in connector CN2 / CN3 "Digital I/Os" to the controller.
7	Optionally, connect the plug-in connector CN4 "TP / fast digital inputs" to the controller
8	Optionally, connect the plug-in connector CN5 "Analog I/Os" to the controller.
9	Optionally, connect an Ethernet cable to CN8 "Ethernet connection" of the controller.
10	Optionally, connect a PacNet cable to CN9 "PacNet" of the PacDrive LMC Pro/Pro2. Provide an unused connection CN9 with a PacNet terminating plug.
11	Optionally, connect a Realtime Ethernet cable to CN10 (CN11) "Realtime Ethernet port1 (port2)" of the controller.
12	Optionally, connect serial interface cable to CN15 "COM1 (RS-232)" of the controller.
13	Optionally, connect serial interface cable to CN16 "COM2 (RS-485)" of the controller.
14	Optionally, connect CAN bus cable to CN17 "CAN" of the controller.
15	Optionally, connect PROFIBUS DP bus cable to CN18 "PROFIBUS" of the controller.
16	Optionally, if optional modules are available then insert the respective cables with the corresponding connections of the optional modules.

⚠ DANGER

ELECTRIC SHOCK CAUSED BY HIGH LEAKAGE (TOUCH) VOLTAGE

- Apply power to the device only if the terminal covers have been attached to the extremities of the Bus Bar Module combination.

Failure to follow these instructions will result in death or serious injury.

⚠ DANGER

INSUFFICIENT GROUNDING

- Use a protective ground copper conductor with at least 10 mm² (AWG 6) or two protective ground copper conductors with the same or larger cross section of the conductors supplying the power terminals.
- Verify compliance with all local and national electrical code requirements as well as all other applicable regulations with respect to grounding of all equipment.

Failure to follow these instructions will result in death or serious injury.

Completion of Commissioning

Transferring the Configuration and the Program

For information on how to transfer the project to the PacDrive controller, refer to the EcoStruxure Machine Expert Online Help.

Adjust Real-Time Clock

The real-time clock is not adjusted at the time of delivery of the device. Summer and winter time is considered by the device. As of LMC firmware V1.64.x.x, the time zone information is supported. `SysTimeRtcSetTimeZone` allows the configuration (preconfigured for CET). LMC parameter `RealTimeClock` can be set with `SetRealTimeClock` or `SysTimeRtcSet`. If the real-time clock is not adjusted, the time and date specifications in the message logger will not be correct. Make certain that the real-time clock is adjusted correctly.

Minimal Boot of the Controller

If a boot error occurs as a result of an application error, the user can perform a minimal boot. During the minimal boot, the application is not loaded

Performing a minimal boot of the controller manually:

Step	Action	Result
1	Restart the controller by pressing the reset button or on- / off- button.	The controller starts and the Error indicator lights up.
2	Press the reset button again while the preset IP address is displayed.	After the boot, the controller will flash quickly (10 Hz), signaling a minimal boot.

Conditions triggering an automatic minimal boot

The controller automatically performs a minimal boot if the following conditions apply:

- A voltage interruption of the control voltage occurs when starting the controller while the **Error** indicator is illuminated.
- A reset of the controller is triggered.
- An error is detected (memory recall cannot be performed).

Maintenance, Repair, Cleaning, Replacement Equipment Inventory

Prerequisites for Maintenance, Repair, and Cleaning

Introduction

Observe the following instructions before carrying out maintenance on the controller.

De-Energize the System

⚡ ⚠ DANGER

HAZARD OF ELECTRIC SHOCK, EXPLOSION OR ARC FLASH

- Disconnect all power from all equipment including connected devices prior to removing any covers or doors, or installing or removing any accessories, hardware, cables, or wires except under the specific conditions specified in the appropriate hardware guide for this equipment.
- Always use a properly rated voltage sensing device to confirm the power is off where and when indicated.
- Replace and secure all covers, accessories, hardware, cables, and wires and confirm that a proper ground connection exists before applying power to the unit.
- Use only the specified voltage when operating this equipment and any associated products.

Failure to follow these instructions will result in death or serious injury.

How to de-energize the system:

Step	Action
1	Set main switch to OFF position, or otherwise disconnect all power to the system.
2	Prevent main switch from being switched back on.
3	In the case of any drives, servos or other equipment with high capacity capacitors, wait at least 15 minutes after removing power (switching off) to allow the DC bus capacitors to discharge. For other important hazard information, see the user guide of your drive (s).

Battery Compartment

Overview

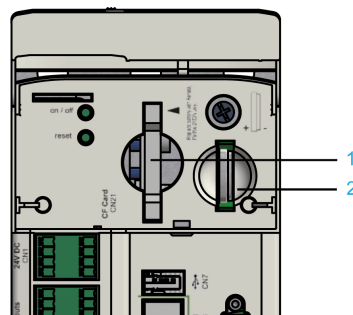

1 CompactFlash card slot

2 Battery compartment

The battery compartment is located under the operating cover of the controller. The controller battery helps maintain controller data (BIOS cmos, NVRAM, RTC).

Maintenance Interval

The estimated maintenance interval for replacing the battery is 5 years. If the device (with battery installed) is not used for an extended period of time, you should verify/replace the battery.

Measuring the Battery

To measure the battery, proceed as follows:

Step	Action
1	Remove battery and then make the manual measurement.
2	Or observe the diagnostic message 037 Battery low in the IEC program and display it on an HMI (panel), if necessary.
3	Replace battery three days after the first diagnostic message at the latest.

Replacing the Battery

While lithium batteries are preferred due to their slow discharge and long life, they can present hazards to personnel, equipment and the environment and must be handled properly.

⚠ DANGER

EXPLOSION, FIRE, OR CHEMICAL BURNS

- Replace with identical battery type.
- Follow all the instructions of the battery manufacturer.
- Remove all replaceable batteries before discarding unit.
- Recycle or properly dispose of used batteries.
- Protect battery from any potential short-circuit.
- Do not recharge, disassemble, heat above 100 °C (212 °F), or incinerate.
- Use your hands or insulated tools to remove or replace the battery.
- Maintain proper polarity when inserting and connecting a new battery.

Failure to follow these instructions will result in death or serious injury.

Step	Action
1	You can change the battery while the controller is on or off. There is no loss of data when it is performed with the controller on. When the controller is switched off, the hold up time for the data without a battery is approximately 30 seconds.
2	Use pliers with insulated tips to lightly pull the battery out of its slot.
3	Carefully place the new battery on the guide and lightly push it into the device.

NOTE: Replacement of the battery in the controllers other than with the type specified in this documentation may present a risk of fire or explosion.

⚠ WARNING**IMPROPER BATTERY CAN PROVOKE FIRE OR EXPLOSION**

Replace battery only with identical type: 3 V Lithium Renata Type CR2450N.

Failure to follow these instructions can result in death, serious injury, or equipment damage.

Maintenance - Uninterruptible Power Supply

Overview

The estimated maintenance interval for replacing the battery pack (UPS) is 3 years. For more information, refer to *Uninterruptible Power Supply - UPS*, page 87.

Machine Repair

Presentation

When replacing controllers, be sure to observe the important safety information in the sections of the present document concerning mounting and dismounting components.

With exception of batteries, there are no other user-serviceable parts within the controllers. Either replace the controller or contact your Schneider Electric service representative.

⚠ WARNING**UNINTENDED EQUIPMENT OPERATION**

- Only use software and hardware components approved by Schneider Electric for use with this equipment.
- Do not attempt to service this equipment outside of authorized Schneider Electric service centers.
- Update your application program every time you change the physical hardware configuration.

Failure to follow these instructions can result in death, serious injury, or equipment damage.

Use only the accessories and mounting parts specified in the documentation and no third-party devices or components that have not been expressly approved by Schneider Electric. Do not modify the equipment.

In case machine repair includes the replacement of the drive components, observe the following instructions for ESD protection in order to avoid any damage due to electrostatic discharge:

NOTICE**ELECTROSTATIC DISCHARGE**

- Do not touch any of the electrical connections or components.
- Prevent electrostatic charges, for example, by wearing appropriate clothing.
- If you must touch circuit boards, do so only on the edges.
- Remove existing static charge by touching a grounded, metallic surface.

Failure to follow these instructions can result in equipment damage.

Cleaning

Cleaning the Controller

Care must be taken with cleaning products as some active agents may have deleterious effects on plastics and stainless steel welds.

NOTICE

CORROSION CAUSED BY CLEANING AGENTS

- Before using a cleaning agent, carry out a compatibility test in relation to the cleaning agent and the component affected.
- Do not use alkaline detergent.
- Do not use any chlorid-containing cleaning agents.

Failure to follow these instructions can result in equipment damage.

For more information on the material properties of your component, refer to *Mechanical and Electrical Data*, page 81.

Replacement Equipment Inventory

Presentation

Keep a stock of the most important components to make certain your machine is functioning and ready for operation.

Replace devices with the same hardware configuration to help ensure compatibility.

Indicate the following information on the replacement equipment order:

- Unicode: for example, **LMC400CAABA00**
- Hardware revision: for example, **RS 01**

This information can be found on the nameplates.

For more information concerning the replacement of components, refer to *Replacing Components and Cables*, page 44.

NOTE: For software and hardware compatibility information, refer to *Compatibility of Lexium 62 Drives and Programming Software Versions*.

Replacing Components and Cables

Prerequisites for Replacing Components and Cables

De-Energize the System

 **DANGER**

HAZARD OF ELECTRIC SHOCK, EXPLOSION OR ARC FLASH

- Disconnect all power from all equipment including connected devices prior to removing any covers or doors, or installing or removing any accessories, hardware, cables, or wires except under the specific conditions specified in the appropriate hardware guide for this equipment.
- Always use a properly rated voltage sensing device to confirm the power is off where and when indicated.
- Replace and secure all covers, accessories, hardware, cables, and wires and confirm that a proper ground connection exists before applying power to the unit.
- Use only the specified voltage when operating this equipment and any associated products.

Failure to follow these instructions will result in death or serious injury.

How to de-energize the system:

Step	Action
1	Set main switch to OFF position, or otherwise disconnect all power to the system.
2	Prevent main switch from being switched back on.
3	In the case of any drives, servos or other equipment with high capacity capacitors, wait at least 15 minutes after removing power (switching off) to allow the DC bus capacitors to discharge. For other important hazard information, see the user guide of your drive (s).

Other Prerequisites

 **DANGER**

ELECTRIC SHOCK, EXPLOSION, OR ARC FLASH

- Operate electrical components only with a connected protective ground (earth) cable.
- After the installation, verify the secure connection of the protective ground (earth) cable to all electrical devices to ensure that connection complies with the connection diagram.
- Before enabling the device, safely cover the live components to prevent contact.
- Do not touch the electrical connection points of the components when the module is energized.
- Provide protection against indirect contact.
- Connect and disconnect cables and terminals only after you have verified that the power has been removed from the system.

Failure to follow these instructions will result in death or serious injury.

With exception of batteries, there are no other user-serviceable parts within the controllers. Either replace the component or contact your Schneider Electric service representative.

⚠ WARNING
<p>UNINTENDED EQUIPMENT OPERATION</p> <ul style="list-style-type: none"> • Only use software and hardware components approved by Schneider Electric for use with this equipment. • Do not attempt to service this equipment outside of authorized Schneider Electric service centers. • Update your application program every time you change the physical hardware configuration. <p>Failure to follow these instructions can result in death, serious injury, or equipment damage.</p>

Device Replacement

How to Replace the Controller

Before beginning the replacement of specific components, read thoroughly the Prerequisites for Replacing Components and Cables, page 44.

⚠ DANGER
<p>INOPERABLE SAFETY FUNCTION</p> <p>Test the proper functioning of the safety functions after every device replacement and every change of the wiring.</p> <p>Failure to follow these instructions will result in death or serious injury.</p>

Observe the following instructions to replace the controller.

Step	Action
1	In order to maintain compatibility with your application and machine, replace the existing controller with that of the same hardware revision (for example, RS:02 on the logistical nameplate, page 26 or 02 in the hardware code, page 56).
2	Contact your Schneider Electric service representative if the replacement controller is of a different hardware revision.
3	When replacing the controller, in addition to the following instructions, the specifications of the original machine manufacturer must also be observed.
4	Disconnect cables from the controller.
5	Loosen the mounting screws from the top and bottom of the housing brackets.
6	Remove the controller and replace the complete unit.
7	Install the new controller and tighten the mounting screws.
8	Connect the controller according to the circuit diagram of the machine.
9	Following replacement of the controller, proceed as for the initial start-up.

⚠ DANGER
<p>INCORRECT ASSIGNMENT OF CABLES</p> <p>Verify that the assignment of the cables conforms to their previous connector assignments.</p> <p>Failure to follow these instructions will result in death or serious injury.</p>

▲ CAUTION**FALLING HEAVY OBJECT**

Do not fully remove the screw connections of the device mounting suspension and prevent the device from falling out and down.

Failure to follow these instructions can result in injury or equipment damage.

NOTICE**IMPROPER REPLACEMENT / COMMISSIONING**

Do not open the controller for commissioning or replacement.

Failure to follow these instructions can result in equipment damage.

How to Start-Up

Proceed as follows to start up:

Step	Action
1	Import the user project again using a PC on which EcoStruxure Machine Expert Logic Builder is installed. Or Retrieve the CompactFlash card from the controller to be replaced and insert it into the new controller.
2	Ensure that the CompactFlash card is functional.
3	Put the system back in operation.

Fast Device Replacement (FDR) - Introduction

Introduction

With the help of the Fast Device Replacement, the Lexium 62, Lexium 52 and ILM devices that are in the configuration of an EcoStruxure Machine Expert project in the controller can be replaced.

There are certain parameters that have to be set in EcoStruxure Machine Expert first. Information on this can be found in the online help of EcoStruxure Machine Expert.

Subsequently, certain settings on the display of the controller have to be made which are described below.

The controller interface for FDR allows you to manually access the assignment between logical devices in the controller configuration (EcoStruxure Machine Expert Logic Builder) and the physical connected devices.

Fast Device Replacement - Usage

Error Detected During the Manual Device Assignment

If two or more devices of the same type (or a double drive) are replaced, it is possible that an incorrect manual assignment of the logical devices to the physical connected devices is made.

▲ WARNING

UNINTENDED OPERATING STATE OF THE DEVICE

- Ensure that the assignment of the logical devices to the physical connected devices is exactly the same as the device assignment before the device replacement.
- Verify that the application addresses the physical drives correctly before putting the machine back into service.

Failure to follow these instructions can result in death, serious injury, or equipment damage.

Different Device Types

The controller interface for FDR does not consider the device type of physical devices.

NOTE: If the logical device type is not the same as the assigned physical device type, then a device assignment with the controller interface for FDR is possible. However, it leads to an error being detected during the Sercos phase start-up (8501 Sercos slave not found). If `FDRStartMode` is set to the value `Phase start-up/2`, then the controller interface for FDR is restarted.

Further information on the parameters can be found under *Fast Device Replacement* in the online help of EcoStruxure Machine Expert.

Device Replacement

If the requirements are fulfilled (see chapter *Fast Device Replacement* in the EcoStruxure Machine Expert online help) and you are replacing a device, then the controller display automatically shows the start picture of the controller interface for FDR.

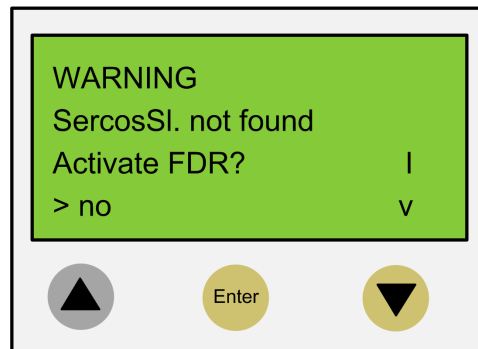

Confirmation or Cancel

Action	Result
You can exit the controller interface for FDR with the Enter key (if the arrow pointing right is on No).	The controller interface for FDR is canceled.
You can also switch to Yes with the arrow pointing down key (arrow pointing right on Yes), and then confirm the Yes with Enter .	Now you can navigate through the menu like described in the chapter <i>Controller Display</i> , page 48. For more information, refer to the chapter <i>Application</i> , page 49.

Timeout (5 Minutes)

If no button is pressed at the display for 5 minutes, the controller interface for FDR is terminated. The system then behaves as if you have terminated the FDR

mechanism. If you press a display button within the 5 minutes, the time for the timeout is reset.

Behavior After Repeated Download

If after the controller interface for FDR a download of a project is made, then the saved changes of the parameter `ConfiguredSerialNumber` are reset and set to the values that are saved in the project that was downloaded.

For devices that are identified via **Identification mode > Device number** (`SerialNumberController / 0`) and were allocated via FDR, the system acts as if the controller interface for FDR had not been performed.

Further information on the parameters can be found under *Fast Device Replacement* in the online help of EcoStruxure Machine Expert.







Fast Device Replacement - Controller Display

Overview

When the controller interface for FDR is active, the controller display shows the corresponding menu.

The following describes the menu in general. For more information, refer to the section *Application*, page 49.

General Menu Description

Arrow / Key		Description
		If up/down arrows are displayed at the right menu edge, you can scroll up and down using these arrow keys. Scrolling starts only after the right arrow is displayed at the lower or upper menu edge. If the right arrow is displayed in a line in between, you can move it using the up/down arrow keys
		
	-	The command that is in the line that is marked with the arrow pointing right can be confirmed/executed with the Enter key.
	-	

In the following example, FDR SNRC stands for addressing a device via the device serial number. Instead of FDR SNRC, the FDR ATYP (for application type) or FDR SADR (for Sercos address) can also be used.

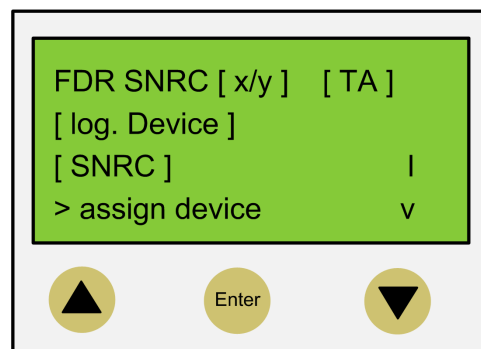

Placeholders	Description
[x/y]	<p>Number of the logic device (x) which currently has to be processed and the total number of the assigned devices (y). If, for example, 20 devices cannot be assigned by default addressing and you have already assigned 11 devices via the controller interface for FDR, then 12/20 is displayed.</p> <p>If this line (for example, FDR SNRC [x/y] [TA]) contains more than 18 characters, then the first 16 characters are displayed, followed by</p> <p>Via the menu item Details, you can switch to a display mode that displays the complete line (see below).</p>
[TA]	Topological address of the physical device that is currently displayed.
[log.device]	<p>Name of the logical device in the controller configuration (EcoStruxure Machine Expert Logic Builder) that shall be assigned to the physical device at the topological address [TA].</p> <p>If the device name consists of more than 18 characters, the first 16 characters of the device name are displayed, followed by</p> <p>Via the menu item Details, you can switch to a display mode that displays the complete logical device name (see below).</p>
[SNRC]	<p>Serial number of the currently displayed physical device on the topological address [TA]</p> <p>If the serial number has more than 18 characters, then the first 16 characters of the serial number are displayed, followed by</p> <p>Via the menu item Details, you can switch to a display mode that displays the complete serial number (see below).</p>

NOTE: Devices that were assigned via the menu item/command **Assign device** (see below) cannot be removed again via a menu item/command.

Menu item/Command	Description
Assign device	<p>With this command, you confirm the assignment between the logical device [log.device] and the physical device at the topological address [TA].</p> <ul style="list-style-type: none"> In the case of Identification mode > Device serial number, the serial number of the physical device is copied to the parameter <code>ConfiguredSerialNumber</code> of the logical device. In the case of Identification mode > Application type, the application type is written to the respective device via the Sercos bus By Identification mode > sercos address, the Sercos address is written to the respective device via the Sercos bus. <p>After assigning a device, the x (see placeholder [x/y]) is increased. If no other devices without an assignment are existent, then the mechanism is completed and the Sercos phase start-up continues.</p>
next phys.	With this command, the next physical device to the logical device (x) that currently has to be processed is displayed.
Details	<p>With this command, it is possible to switch to a display mode that displays the complete lines (multi-line).</p> <p>This is helpful if in the standard view lines cannot be displayed completely (see above).</p> <p>For a logical device, a maximum of 40 characters can be displayed</p>
back	With this command, it is possible to switch back to the standard view (maximum 16 characters followed by . . . are displayed).
Exit FDR	<p>With this command, the controller interface for FDR is canceled.</p> <p>The cancelation has to be confirmed once again (Really exit? > Exit FDR).</p>

Further information on the parameters can be found under *Fast Device Replacement* in the online help of EcoStruxure Machine Expert.

Fast Device Replacement - Application

Starting Conditions

The following example shows a typical application for the controller interface for FDR. For the displayed example, the following applies:

- All the devices are operational.
- The Sercos bus is started up.

- For all the devices, the **Device addressing** via the **Identification mode > Device serial number** was made (parameter `SerialNumberController / 0`).
- The parameter `FDRConfirmationMode` of the controller was set to the value `by Display / 0`.

Further information on the parameters can be found under *Fast Device Replacement* in the online help of EcoStruxure Machine Expert.

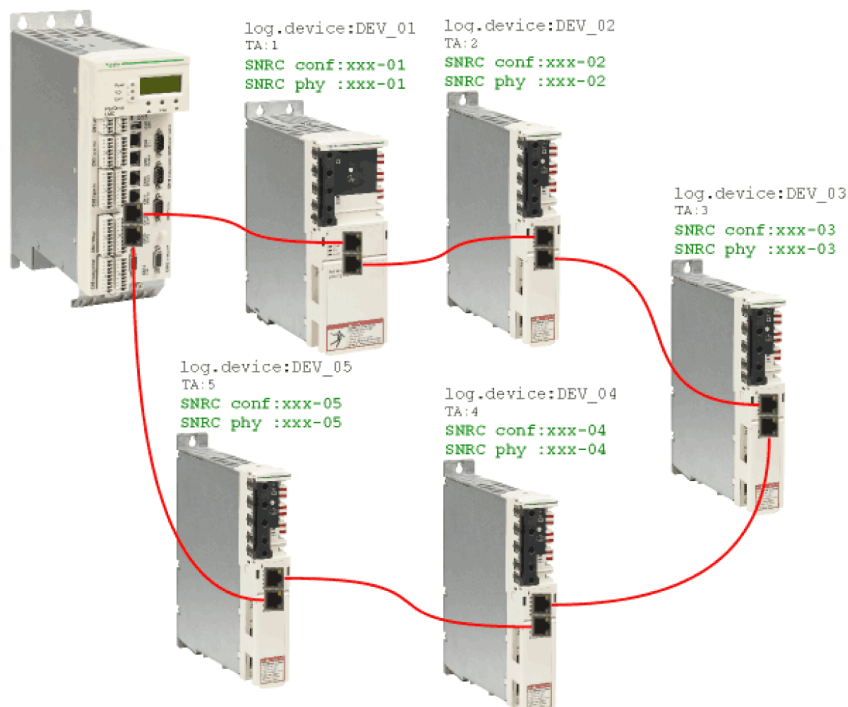

Device Replacement

The following devices have to be replaced because of maintenance:

- The device at the topology address 2 (TA: 2) with the logical device name DEV_02 and the serial number SNRC phy: xxx-02 has to be replaced by the new device that has the serial number SNRC phy: xxx-15.
- The device at the topology address 5 (TA: 5) with the logical device name DEV_05 and the serial number SNRC phy xxx-05 has to be replaced by the new device that has the serial number SNRC phy xxx-16.

After the Device Replacement

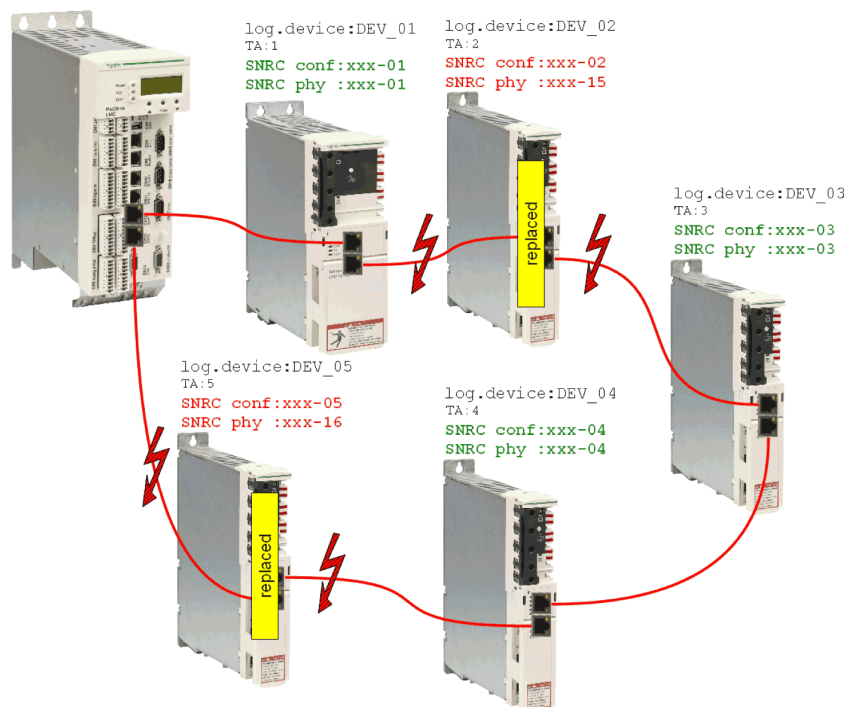

After the physical replacement of the devices the machine has to be restarted again. In order for the controller interface for FDR to be started, the parameter `FDRStartMode` has to be set to `Start/1` or `Phase start-up/2` and the parameter `FDRConfirmationMode` to `display / 0`.

Now the controller interface for FDR has to find the correct assignment of the two logical devices `DEV_02` and `DEV_05` to the new physically connected devices at topology address 2 and 5.

Further information on the parameters can be found under *Fast Device Replacement* in the online help of EcoStruxure Machine Expert.

Process

The controller interface for FDR verifies all the logical devices one after another which would trigger the diagnostic message 8501 `Sercos slave not found` during the Sercos phase start-up. Afterwards, to the respective logical device all the physical devices are checked until one device is acknowledged.

Due to space constraints, the sequence for device 1 and device 2 is displayed one beneath the other.

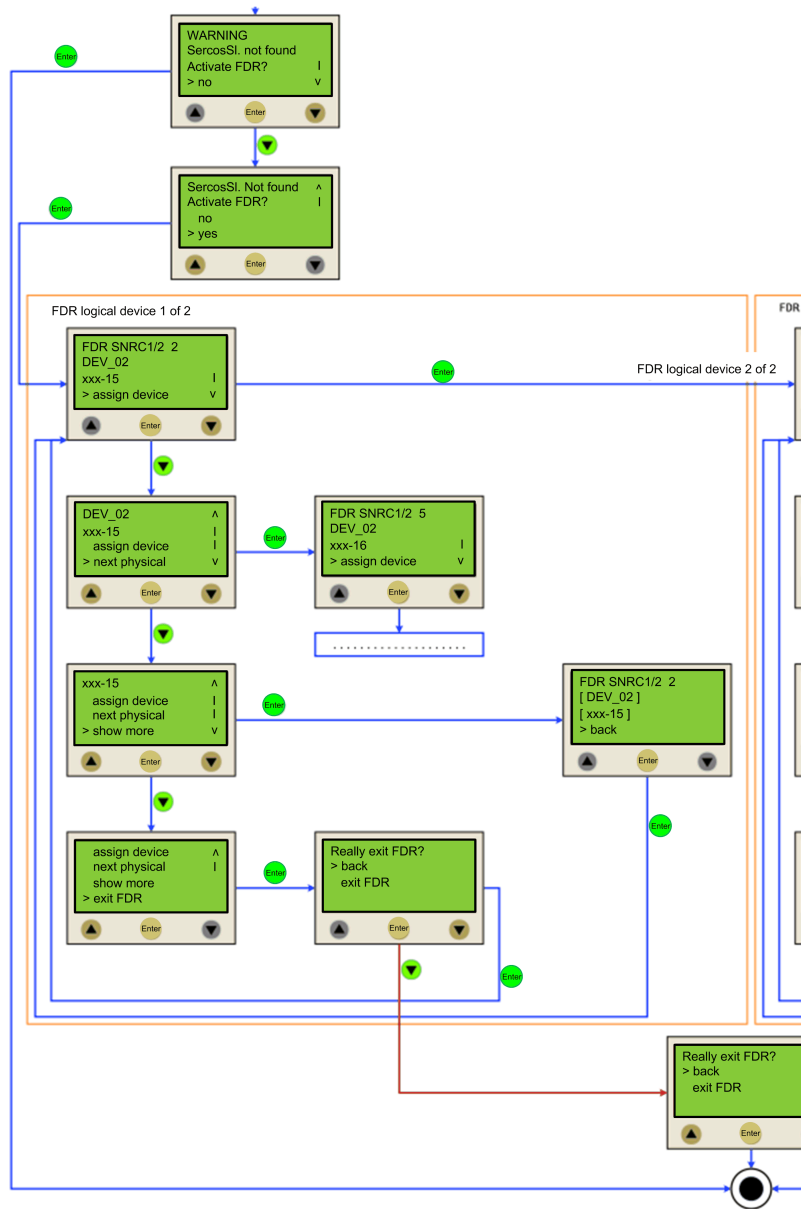

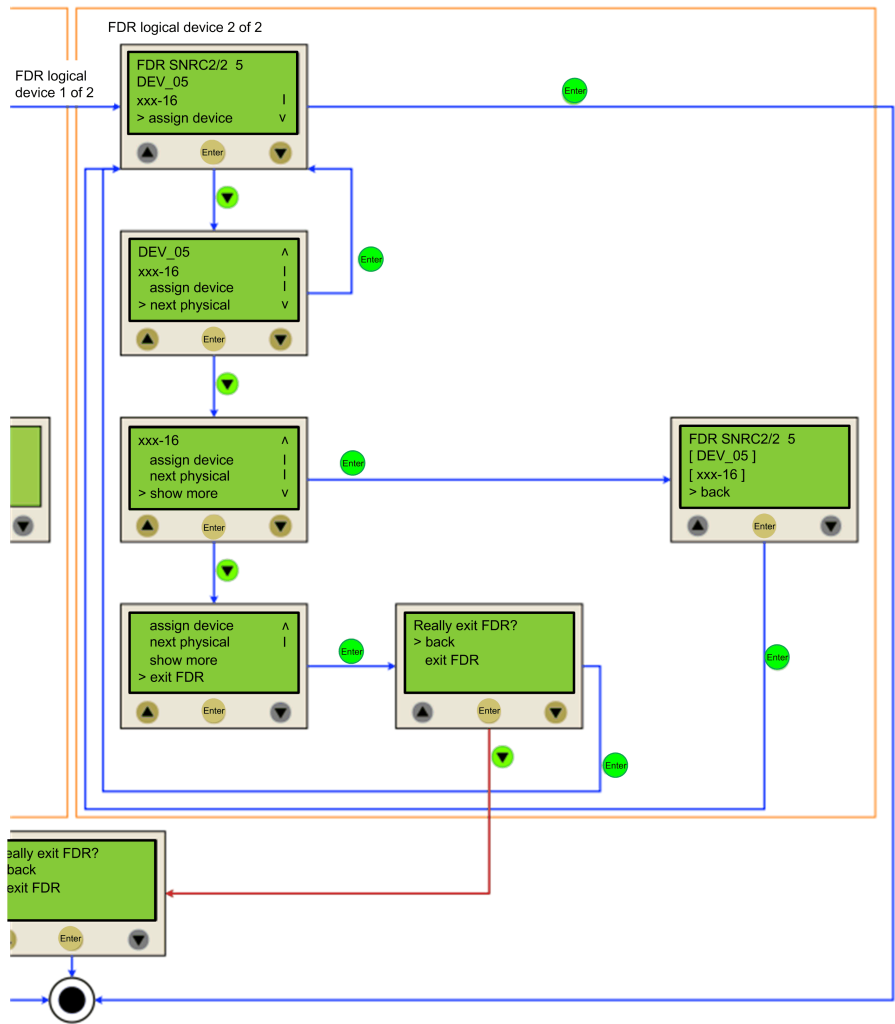

Cable Replacement

Introduction

NOTE: In addition to the following instructions, you must observe the specifications of the machine manufacturer when replacing the cables.

De-Energize the System

⚠️ ⚠️ DANGER

HAZARD OF ELECTRIC SHOCK, EXPLOSION OR ARC FLASH

- Disconnect all power from all equipment including connected devices prior to removing any covers or doors, or installing or removing any accessories, hardware, cables, or wires except under the specific conditions specified in the appropriate hardware guide for this equipment.
- Always use a properly rated voltage sensing device to confirm the power is off where and when indicated.
- Replace and secure all covers, accessories, hardware, cables, and wires and confirm that a proper ground connection exists before applying power to the unit.
- Use only the specified voltage when operating this equipment and any associated products.

Failure to follow these instructions will result in death or serious injury.

How to de-energize the system:

Step	Action
1	Set main switch to OFF position, or otherwise disconnect all power to the system.
2	Prevent main switch from being switched back on.
3	In the case of any drives, servos or other equipment with high capacity capacitors, wait at least 15 minutes after removing power (switching off) to allow the DC bus capacitors to discharge. For other important hazard information, see the user guide of your drive (s).

Procedure

Proceed as follows for cable replacement:

- Be sure that the cables clearly indicate their connections before disconnecting.
- Replace cables with an identical type and length.
- Refer to any documentation from the original machine manufacturer before replacing cables.
- Disconnect/Attach the cable from the equipment components involved.

⚠ DANGER

INCORRECT ASSIGNMENT OF CABLES

Verify that the assignment of the cables conforms to their previous connector assignments.

Failure to follow these instructions will result in death or serious injury.

Indicators and Control Elements

Indicators of the Controller

Overview

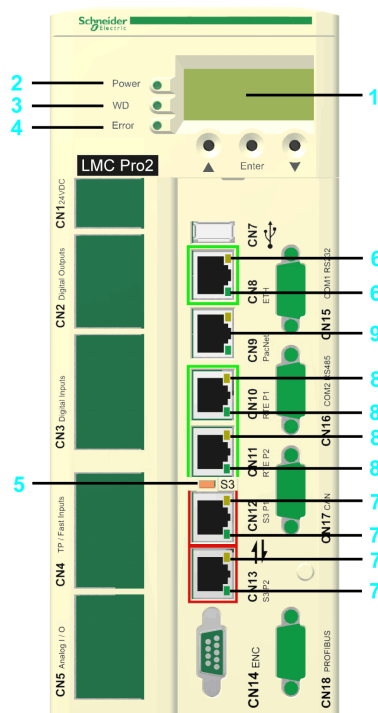

1	4-line Liquid Crystal Display (LCD), page 56
2	Power LED indicator, page 56
3	WD LED indicator, page 56
4	Error LED indicator, page 56
5	S3 (Sercos III) LED indicator, page 57
6	Ethernet status LED indicators , page 57
7	Sercos status LED indicators , page 58
8	Protocol-specific status LED indicators, page 58
9	PacNet LED indicators (not used)

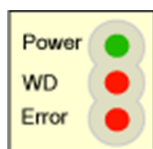

If the cover of the controller is closed, you see 3 vertically arranged LED indicators, which signify various operating states or detected errors:

- **Power**
- **WD** (watchdog indicator)
- **Error** (error display)

Liquid Crystal Display (LCD)

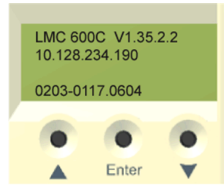

In addition to the LED indicators, further information about the operating status of the controller is given on the 4-line Liquid Crystal Display (LCD).

Line 1	Controller type and firmware version
Line 2	Current IP address of the controller
Line 3	–
Line 4	PFPGA version/PIC version

Power LED Indicator

The **Power** LED indicator indicates the state of the control voltage in the UPS status.

LED indicator status	Meaning
Off	The control voltage (24 Vdc) is absent or under-voltage.
On	Normal operation; control voltage in the normal range.
Flashes	UPS active.

Watchdog LED Indicator

The **WD** (watchdog) LED indicator of the watchdog hardware module is used to monitor the controller.

LED indicator status	Meaning
Off	Normal operation.
On	An unrecoverable error was detected or the controller is in initialization phase. Press the reset button to reset and reboot the controller.

An unrecoverable error is a hardware or software issue that requires intervention.

When this error is detected, the following actions are performed:

- The controller is stopped.
- The optional modules are reset.
- The digital and analog outputs are reset.
- The wd (watchdog) relay output is opened.

Error LED Indicator

The **Error** LED indicator indicates detected errors. The table lists the possible display conditions and their accompanying error descriptions.

LED indicator status	Meaning
Off	Normal operation.
Flashes slowly (1.7 Hz)	Error of class 3 and 4 active. Refer to the <i>EcoStruxure Machine ExpertOnline Help\Diagnostics User Guide\System Diagnostic\Diagnostic Classes</i> .
Flashes quickly (10 Hz)	Controller boot completed, last boot was not successful. See diagnostic message 209 last boot failed . Controller performed a minimal boot.
Flashes fast and slowly alternately	Firmware download via Sercos is active or controller is in initialization phase
On	An error was detected during the boot.

The **Error** LED indicator is flashing after BIOS is started. Once the operating system, user configuration, user parameters, and the IEC program have been loaded and the IEC program has been started successfully, the **Error** LED indicator is switched off again. The boot procedure is now complete.

S3 (Sercos III) LED Indicator

The **S3** LED indicator indicates the state and the phases of the Sercos communication.

LED indicator color / status	Meaning	Instructions/information for the user	Notes
Off	No Sercos communication	–	–
Orange	The device is in a communication phase CP0 up to and including CP3.	–	SERC3.State = 0..3
Green	Sercos communication in communication phase CP4 without error detected.	–	SERC3.State = 4
Red	Detected communication error.	Reset condition: DiagQuit	SERC3.State = 11

Ethernet Status LED Indicators

The Ethernet connector of PacDrive LMC Pro has two LED indicators. One LED indicator is green, the other is yellow.

LED indicator	State	Meaning
Green	On	Connection established
Green	Flashing	Data traffic
Green	Off	No connection, for example, no cable connected, or connected device has no power
Yellow	On	100 MBit/s connection
Yellow	Off	10 MBit/s connection

The Ethernet connector of PacDrive LMC Pro2 has two LED indicators. One LED indicator is green (above), the other is yellow/green (below).

LED indicator	State	Meaning
Green (above)	On	Connection established
Green (above)	Off	No connection, for example, no cable connected, or connected device has no power
Green (below)	Flashing	1000 MBit/s (1 GBit/s) connection with data traffic

LED indicator	State	Meaning
Yellow (below)	Flashing	10/100 MBit/s connection with data traffic
Yellow/Green (below)	Off	No data traffic

Sercos Status LED indicators

Each Sercos connector has two LED indicators. One LED indicator is green, the other is yellow.

LED indicator	State	Meaning
Yellow	On	Connection established
	Off	No cable connected or connected device has no power.
Green	On	Active network traffic
	Off	No active network traffic

Protocol-specific Status LED Indicators

LED indicators EtherCAT master

LED indicator	Color	State	Meaning
LINK/RJ45 Ch0 & Ch1	green LED indicator		
	Green	On	A connection to Ethernet exists.
	Off	Off	The device has no connection to Ethernet.
RJ45 Ch0 & Ch1	yellow LED indicator		
	Yellow	Flashing cyclic with 2.5 Hz	The device sends/receives Ethernet frames.

LED indicators EtherCAT slave

LED indicator	Color	State	Meaning
LINK/RJ45 Ch0 & Ch1	green LED indicator		
	Green	On	A connection to Ethernet exists.
	Green	Flashing cyclic with 2.5 Hz	The device sends/receives Ethernet frames.
	Off	Off	The device has no connection to Ethernet.
RJ45 Ch0 & Ch1	yellow LED indicator		
	–	–	The LED indicator is not used.

LED indicators EtherNet/IP scanner (master)

LED indicator	Color	State	Meaning
LINK/RJ45 Ch0 & Ch1	green LED indicator		
	Green	On	A connection to Ethernet exists.
	Off	Off	The device has no connection to Ethernet.
ACT/RJ45 Ch0 & Ch1	yellow LED indicator		
	Yellow	Flashes	The device sends/receives Ethernet frames.

LED indicators EtherNet/IP adapter (slave)

LED indicator	Color	State	Meaning
LINK/RJ45 Ch0 & Ch1	green LED indicator		
	Green	On	A connection to Ethernet exists.
	Off	Off	The device has no connection to Ethernet.
ACT/RJ45 Ch0 & Ch1	yellow LED indicator		
	Yellow	Flashes	The device sends/receives Ethernet frames.

LED indicators PROFINET controller

LED indicator	Color	State	Meaning
LINK/RJ45 Ch0 & Ch1	green LED indicator		
	Green	On	A connection to Ethernet exists.
	Off	Off	The device has no connection to Ethernet.
RX/TX/RJ45 Ch0 & Ch1	yellow LED indicator		
	Yellow	Flashes	The device sends/receives Ethernet frames.

LED indicators PROFINET device

LED indicator	Color	State	Meaning
LINK/RJ45 Ch0 & Ch1	green LED indicator		
	Green	On	A connection to Ethernet exists.
	Off	Off	The device has no connection to Ethernet.
RX/TX/RJ45 Ch0 & Ch1	yellow LED indicator		
	Yellow	Flashes	The device sends/receives Ethernet frames.

C2C Slave LED Indicators

LED indicator	Color	State	Meaning
LINK/RJ45 Ch0 & Ch1	green LED indicator		
	Green	On	A connection to Ethernet exists.
	Green	Flashing cyclic	The device sends / receives Ethernet frames.
	Off	Off	The device has no connection to Ethernet.
RJ45 Ch0 & Ch1	yellow LED indicator		
	–	–	The LED is not used.

LED Description Additional Ethernet

LED indicator	Color	State	Meaning
LINK/RJ45 Ch0 & Ch1	green LED indicator		
	Green	On	A connection to Ethernet exists.
	Off	Off	The device has no connection to Ethernet.
RX/TX/RJ45 Ch0 & Ch1	yellow LED indicator		
	Yellow	Flashes	The device send/receives Ethernet frames.

Menu Navigation

Menu Buttons

Three menu buttons are located on the front side of the controller. With these menu buttons, the user can open and navigate through the menu.

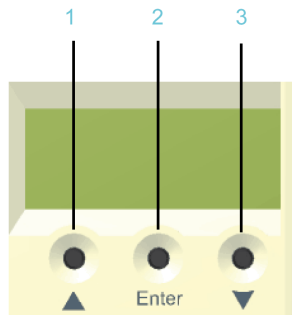







1 Up arrow button

2 **Enter** button

3 Down arrow button

Functions of the Menu Buttons

Under the Liquid Crystal Display (LCD), three menu buttons are located through which the user can open and navigate in the menu. The menu buttons feature the following functions:

Buttons	Function
First  and then simultaneously 	Access of the menu
	Cursor up
	Cursor down
	Open menu item
First  and then simultaneously 	One level up in the menu

If an up or down arrow is displayed on the right display edge, this indicates that the current menu has more lines than can be shown on the display. In this case, you

can use the arrow buttons  and  to scroll up or down.

Menu Navigation

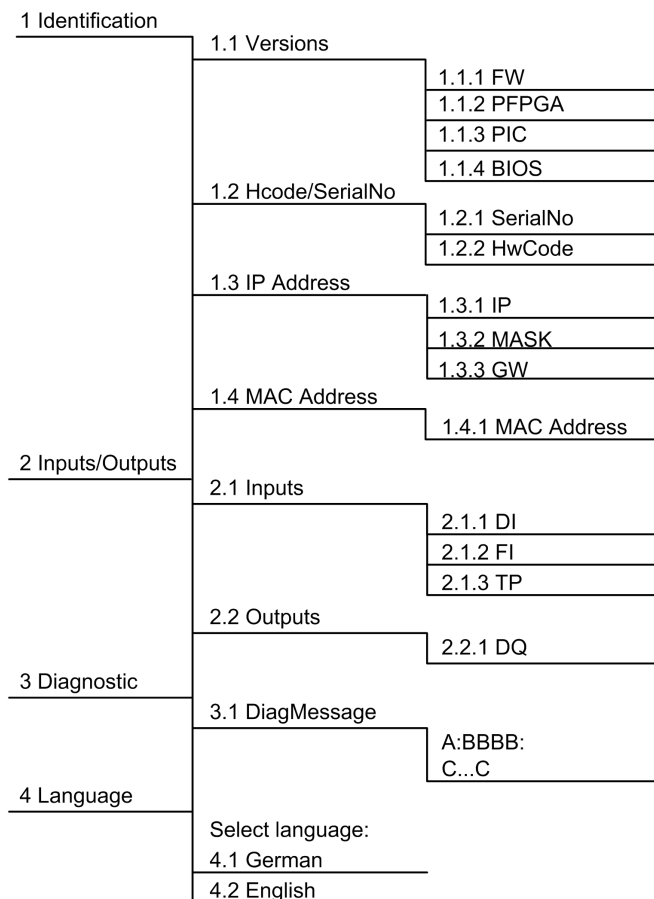

Description of the Menu Navigation

The submenu **Versions** provides an overview of all the software and hardware versions installed on the controller.

Item	Description
FW	Firmware version
PFPGA	Version of the PacDrive FPGA software
PIC	Version of PIC firmware
BIOS	BIOS version

In the submenu **HCode/SerialNo.** a serial number and the hardware code are displayed. The serial number is a unique number which is used to identify the controller. The hardware code indicates the hardware revision.

Item	Description
Serial number	Controller serial number
Hardware code	Hardware code of the controller ⁽¹⁾
(1)	The first two digits of the hardware code indicate the hardware revision (for example, 02). The hardware revision is also indicated on the logistical nameplate, page 26 (for example, RS:02). In order to maintain compatibility with your application and machine, replace the existing controller with that of the same hardware code.

In the submenu **IP address**, the IP address, the subnet mask, and the gateway are displayed.

Item	Description
IP	IP address of the controller
MASK	Subnet mask
GW	Gateway

The MAC address is specified in the submenu **MAC address**. The MAC address is a clear address of the device to identify the device in the network.

Item	Description
MAC address	MAC address

In the submenu **Inputs**, the user can prompt the logic state of each input. The digital inputs correspond to the standard IEC61131-2 type 1. Touchprobes and fast inputs have a resolution of 10 µs. Fast inputs can be used to trigger an interrupt.

Item	Description
DI	Digital input
FI	Fast input
TP	Touchprobe

In the submenu **Outputs**, the user can prompt the logic state of each output.

Item	Description
DQ	Outputs

In the submenu **DiagMessage**, the diagnostic class, the diagnostic code, and the diagnostic text are displayed. The system assigns each diagnostic message a specific diagnostic class when enabled. The diagnostic code is a code that encrypts a certain diagnostic. In the diagnostic text, a diagnostic is described in detail.

Item	Description
A:	A: Diagnostic class
BBB:	BBB: Diagnostic code
C...C	C...C: Diagnostic text

In the submenu **Select language**, the user can choose the display language.

Item	Description
Select language:	
German	Display language is German.
English	Display language is English.



Display during the boot with empty battery pack (UPS).

Press the right button below the display to continue the boot and to start charging the battery pack (UPS).

For more information, refer to the chapter *Device Replacement*, page 45.

CompactFlash Card Slot

Overview

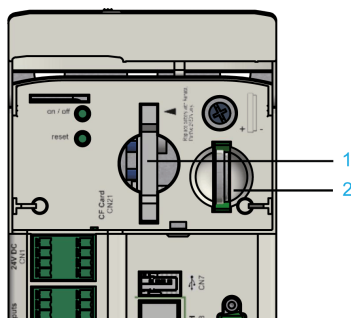

1 CompactFlash card slot

2 Battery compartment

The CompactFlash card slot is located on the operating cover of the controller.

The CompactFlash card slot is the receptacle for the nonvolatile data storage (**CF card**) of the controller.

NOTE: Use only memory cards supplied by Schneider Electric dated 2012 or later.

How to Replace the CompactFlash Card in Case of Servicing

Step	Action
1	Set main switch to OFF position, or otherwise disconnect all power to the system.
2	Prevent main switch from being switched back on.
3	Hold the CompactFlash card with your thumb and forefinger and pull it out of the slot.
4	To insert, carefully place the CompactFlash card on the guide rail and push it into the device.
5	Push lightly until the CompactFlash card clicks in.

Buttons

on / off Button



The **on / off** buttons are located under the operating cover of the controller.

Precondition: Put your machine in a secure state before switching the controller off.

Step	Action
1	Press this button to energize the controller when the controller is completely wired and connected to the power supply system.
2	Press this button to de-energize the controller after putting the machine in a secure state.

reset Button



The **reset** button is located under the operating cover of the controller.

Precondition: Put your machine in a secure state before resetting.

Step	Action
1	Press the button to reset and reboot the controller.

Integrated Communication Ports

Electrical Connections Overview

Front Panel

Connection overview of the PacDrive LMC Pro/Pro2:

Front view of the PacDrive LMC Pro/Pro2:

Bottom view of the PacDrive LMC Pro/Pro2:

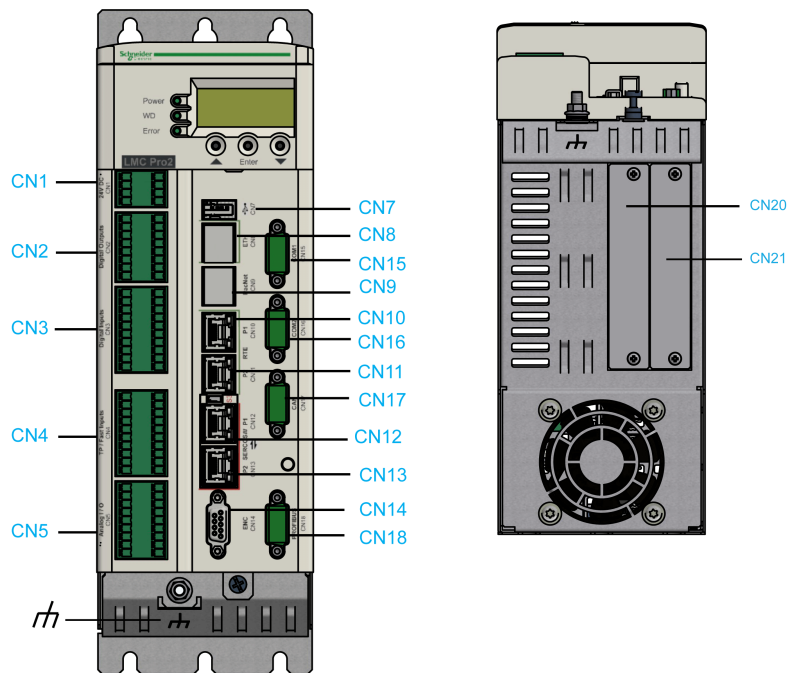

Connection	Meaning	Connection cross-section		Tightening torque [Nm] / [lbf in]
		[mm ²] / [AWG]		
CN1	Control voltage / watchdog	1...1.5	17...16	–
CN2	Digital outputs	1...1.5	17...16	–
CN3	Digital inputs	0.5...1.5	20...16	–
CN4	TP / fast digital inputs	0.5...1.5	20...16	–
CN5	Analog inputs / outputs	0.5...1.5	20...16	–
CN7	USB host (USB-A)	–	–	–
CN8	Ethernet connection	–	–	–
CN9	PacNet	–	–	–
CN10	RT Ethernet, port 1	–	–	–
CN11	RT Ethernet, port 2	–	–	–
CN12	Sercos, port 1	–	–	–
CN13	Sercos, port 2	–	–	–
CN14	Master encoder (Hiperface)	–	–	0.4 / 3.54
CN14	Master encoder (incremental)	–	–	0.4 / 3.54
CN15	COM 1 (RS-232)	–	–	0.4 / 3.54
CN16	COM 2 (RS-485)	–	–	0.4 / 3.54
CN17	CAN	–	–	0.4 / 3.54

Connection	Meaning	Connection cross-section [mm²] / [AWG]		Tightening torque [Nm] / [lbf in]
CN18	PROFIBUS DP	–	–	0.4 / 3.54
CN20	Option slot 1	–	–	0.5 / 4.42
CN21	Option slot 2	–	–	0.5 / 4.42
	Shield connection	4	11	1 / 8.85

Ferrule dimensions for **CN1, CN2, CN3, CN4, CN5:**

Ferrules without insulating collar (according to DIN 46228-1)	
Cross-section [mm²] / [AWG]	Length [mm] / [in.]
0.25 / 24	7 / 0.28
0.34 / 22	7 / 0.28
0.5 / 20	8...10 / 0.31...0.40
0.75 / 20	8...10 / 0.31...0.40
1.00 / 18	8...10 / 0.31...0.40
1.50 / 16	10 / 0.40

Ferrules with insulating collar (according to DIN 46228-4)	
Cross-section [mm²] / [AWG]	Length [mm] / [in.]
0.14 / 26	8 / 0.31
0.25 / 24	8 / 0.31
0.34 / 22	8 / 0.31
0.5 / 20	8...10 / 0.31...0.40
0.75 / 20	10 / 0.40

Connection Details Controller

CN1 - Control Voltage And Watchdog



Connection **CN1**

Pin	Designation	Meaning	Range
1	DC +24 V	Supply voltage	-15 % / +25 %
2	DC 0 V	Supply voltage	–
3	+UL	For digital outputs	DC +24 V -15 % / +25 %
4	L0	For digital inputs / outputs	–
5	DC +24 V	Supply voltage (bridged with pin 1, maximum ampacity 4 A)	–

Pin	Designation	Meaning	Range
6	DC 0 V	Supply voltage (bridged with pin 2, maximum ampacity 4 A)	–
7	WD	Watchdog relay	–
8	WD	Watchdog relay	–

Input connection

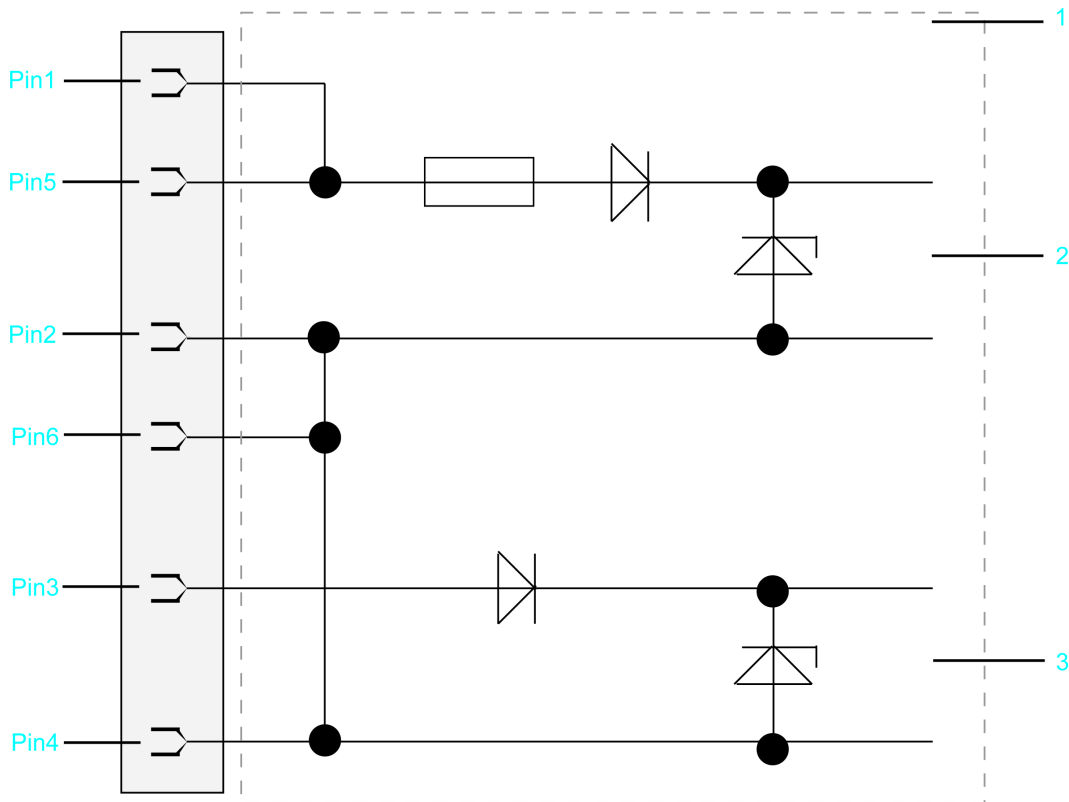

1 Internal wiring diagram - input connection of power supply (simplified)

2 Internal supply voltage

3 Supply voltage for digital outputs/inputs

CN2 - Digital Outputs

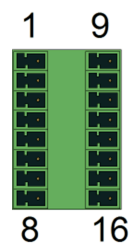

Connection CN2

Pin	Designation	Meaning
1	DQ_0	Digital output 0
2	DQ_1	Digital output 1
3	DQ_2	Digital output 2
4	DQ_3	Digital output 3

Pin	Designation	Meaning
5	DQ_4	Digital output 4
6	DQ_5	Digital output 5
7	DQ_6	Digital output 6
8	DQ_7	Digital output 7
9	DQ_8	Digital output 8
10	DQ_9	Digital output 9
11	DQ_10	Digital output 10
12	DQ_11	Digital output 11
13	DQ_12	Digital output 12
14	DQ_13	Digital output 13
15	DQ_14	Digital output 14
16	DQ_15	Digital output 15

NOTE: When nothing is connected (or the connected device has a high impedance) to an LMC digital output, it measures ~9V for FALSE. If this causes an issue for the connected device, use an external pull-down resistor.

CN3 - Digital Inputs

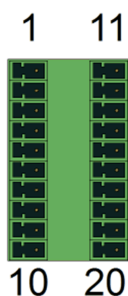

Connection **CN3**

Pin	Designation	Meaning
1	DI_0	Digital input 0
2	DI_1	Digital input 1
3	DI_2	Digital input 2
4	DI_3	Digital input 3
5	DI_4	Digital input 4
6	DI_5	Digital input 5
7	DI_6	Digital input 6
8	DI_7	Digital input 7
9	DI_8	Digital input 8
10	DI_9	Digital input 9
11	DI_10	Digital input 10
12	DI_11	Digital input 11
13	DI_12	Digital input 12
14	DI_13	Digital input 13
15	DI_14	Digital input 14

Pin	Designation	Meaning
16	DI_15	Digital input 15
17	DI_16	Digital input 16
18	DI_17	Digital input 17
19	DI_18	Digital input 18
20	DI_19	Digital input 19

CN4 - Touchprobe And Fast Digital Inputs



Connection **CN4**

Pin	Designation	Meaning
1	T.0	Touchprobe input 0
2	T.1	Touchprobe input 1
3	T.2	Touchprobe input 2
4	T.3	Touchprobe input 3
5	T.4	Touchprobe input 4
6	T.5	Touchprobe input 5
7	T.6	Touchprobe input 6
8	T.7	Touchprobe input 7
9	T.8	Touchprobe input 8
10	T.9	Touchprobe input 9
11	T.10	Touchprobe input 10
12	T.11	Touchprobe input 11
13	T.12	Touchprobe input 12
14	T.13	Touchprobe input 13
15	T.14	Touchprobe input 14
16	T.15	Touchprobe input 15
17	F.0	Fast input 1
18	F.1	Fast input 2
19	F.2	Fast input 3
20	F.3	Fast input 4

CN5 - Analog Inputs / Outputs



Connection **CN5**

Pin	Designation	Meaning	Range
1	AI_0 +	Analog input 0+	-10...+10 V (*) 0...20 mA (**)
2	J_0 +	Br. current input 0 +	–
3	AI_0 -	Analog input 0-	–
4	A_GND 0	Analog ground 0	–
5	12 V Out 0	Output voltage 0	12 V
6	FE (functional earth)	Shield	–
7	AO_0	Analog output 0	-10...+10 V
8	A_GND AO_0	Analog ground 0	–
9	FE (functional earth)	Shield	–
10	AI_1 +	Analog input 1+	-10...+10 V (*) 0...20 mA (**)
11	J_1 +	Br. current input 1 +	–
12	AI_1 -	Analog input 1-	–
13	A_GND 1	Analog ground	–
14	12 V Out 1	Output voltage 1	12 V
15	FE (functional earth)	Shield	–
16	AO_1	Analog output 1	-10...+10 V
17	A_GND AO_1	Analog ground	–
18	FE (functional earth)	Shield	–

(*)	Voltage measurement and (**) current measurement on AI_0+ / AI_0- (pin 1 / pin 3) and AI_1+ / AI_1- (pin 10 / pin 12)
(**)	Current measurement needs in addition bridge at J_0+ (bridge between pin 2 and pin 1) or J_1+ (bridge between pin 11 and pin 10.)

Input / Output connection

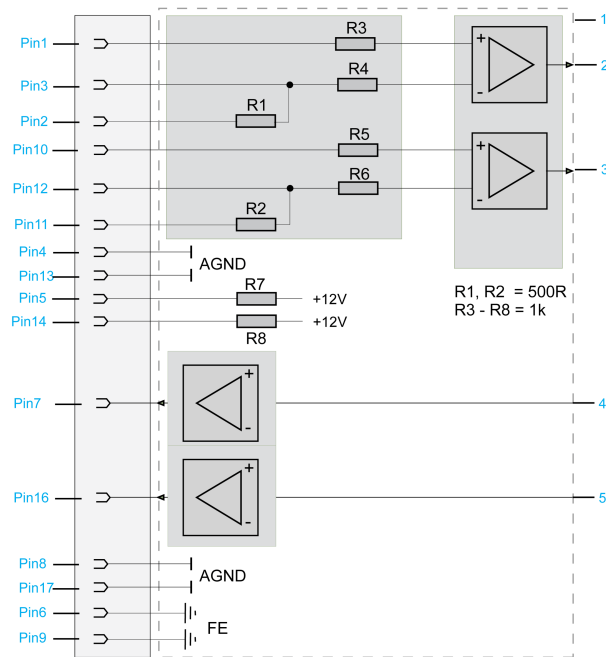

1 Internal wiring diagram (simplified)

2 Analog input 1

3 Analog input 2

2 Analog output 1

3 Analog output 2

CN7 - USB Host

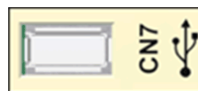

Connection **CN7**

Pin	Designation	Meaning	Range
1	VBUS / +5V	-	-
2	D- / Data-	-	-
3	D+ / Data+	-	-
4	GND / Ground	-	-

CN8 - Ethernet

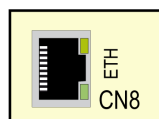

Connection **CN8** of PacDrive LMC Pro

Pin	Designation	Meaning	Function
1	Tx+	Output transmit data +	-
2	Tx-	Output transmit data -	-

Pin	Designation	Meaning	Function
3	Rx+	Input receive data +	–
4	–	Reserved	–
5	–	Reserved	–
6	Rx-	Input receive data -	–
7	–	Reserved	–
8	–	Reserved	–

Connection **CN8** of PacDrive LMC Pro2

Pin	Designation	Meaning	Function
1	MDI 0+	Transmit line 0	–
2	MDI 0-	Transmit line 0	–
3	MDI 1+	Transmit line 1	–
4	MDI 2+	Transmit line 2	–
5	MDI 2-	Transmit line 2	–
6	MDI 1-	Transmit line 1	–
7	MDI 3+	Transmit line 3	–
8	MDI 3-	Transmit line 3	–

There are two LED indicators affixed to the Ethernet connection.

For further information on the functions of the LED indicators, refer to the description of the Ethernet status LED indicator .

CN9 - PacNet



Connection **CN9**

Pin	Designation	Meaning	Function
1	TxD+	Output transmit data +	–
2	TxD-	Output transmit data -	–
3	RxD+	Input receive data +	–
4	TxC-	Output transmit clock -	–
5	TxC+	Output transmit clock +	–
6	RxD-	Input receive data -	–
7	RxC+	Input receive clock +	–
8	RxC-	Input receive clock -	–

CN10/CN11 - RT Ethernet

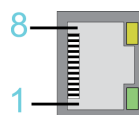

Connection **CN10/11**

Pin	Designation	Meaning	Function
1	Tx+	Output transmit data +	–
2	Tx-	Output transmit data -	–
3	Rx+	Input receive data +	–
4	–	Reserved	–
5	–	Reserved	–
6	Rx-	Input receive data -	–
7	–	Reserved	–
8	–	Reserved	–

NOTE:

- When using the PacDrive LMC Pro/Pro2 as EtherCAT slave, the connection **CN10** represents the input port and the connection **CN11** the output port. The input port and output port are predetermined by the firmware and cannot be configured.
- When using the PacDrive LMC Pro/Pro2 as EtherCAT Master, only the connection **CN10** can be used.

LED Description for CN10/CN11 - RT Ethernet

For further information on the functions of the LED indicators, refer to the description of the Indicators and Control elements, page 55.

LED states valid for SoMachine Motion V4.1 (firmware version V1.51.10.6) and earlier (EtherCAT master stack version V3):

LEDs EtherCAT master

LED indicator	Color	State	Meaning
LINK/RJ45 Ch0 & Ch1	green LED indicator		
	Green	On	A connection to Ethernet exists.
	Off	Off	The device has no connection to Ethernet.
RJ45 Ch0 & Ch1	yellow LED indicator		
	Yellow	Flashing cyclic with 2.5 Hz	The device sends/receives Ethernet frames.

LEDs EtherCAT slave

LED indicator	Color	State	Meaning
LINK/RJ45 Ch0 & Ch1	green LED indicator		
	Green	On	A connection to Ethernet exists.
	Green	Flashing cyclic with 2.5 Hz	The device sends/receives Ethernet frames.
	Off	Off	The device has no connection to Ethernet.
RJ45 Ch0 & Ch1	yellow LED indicator		
	–	–	The LED indicator is not used.

LED states valid for EcoStruxure Machine Expert V1.0 and later (EtherCAT master stack version V4) and SoMachine Motion V4.2 (firmware version V1.53.9.0) and later (EtherCAT master stack version V4):

LED indicators EtherCAT master

LED indicator	Color	State	Meaning
LINK/RJ45 Ch0	green LED indicator		
	Green	On	A connection to Ethernet exists.
	Green	Flashes	The device sends / receives Ethernet frames.
	Off	Off	The device has no connection to Ethernet.
ACT RJ45 Ch0	yellow LED indicator		
	off	–	–

LED indicators EtherCAT slave

LED indicator	Color	State	Meaning
LINK/RJ45 Ch0 & CH1	green LED indicator		
	Green	On	A connection to Ethernet exists.
	Green	Flashes	The device sends / receives Ethernet frames.
	Off	Off	The device has no connection to Ethernet.
RJ45 Ch0 & CH1	yellow LED indicator		
	–	–	–

CN12/CN13 - Sercos

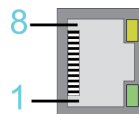

Connection **CN12/CN13**

Pin	Designation	Meaning	Range
1	Tx+	Output transmit data +	–
2	Tx-	Output transmit data -	–
3	Rx+	Input receive data +	–
4	–	Reserved	–
5	–	Reserved	–
6	Rx-	Input receive data -	–
7	–	Reserved	–
8	–	Reserved	–

NOTE: If Sercos devices are assigned via the topological addresses (**IdentificationMode = TopologyAddress**) to the PacDrive LMC Pro/Pro2, then respect the following:

- Connect your Sercos device to the PacDrive LMC Pro/Pro2 either completely via Sercos port 1 (**CN12**) in line topology or in ring topology using Sercos port 1 and 2 (**CN12/CN13**).
- Do not connect the Sercos devices to the PacDrive LMC Pro/Pro2 via double line topology (**CN12/CN13**).
- Do not connect the Sercos devices to the PacDrive LMC Pro/Pro2 only via Sercos port 2 (**CN13**).

CN14 - Master Encoder (Hiperface)

The Hiperface connection consists of a standard, differential, digital connection (RS-485 = 2 wires), a differential, analog connection (sine- and cosine signal = 4 wires), and a mains connection to supply the encoder (+9 V, GND = 2 wires).

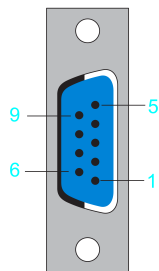

Connection **CN14** - Master encoder (Hiperface)

Pin	Designation	Meaning	Range
1	REFSIN	Reference signal sine	–
2	SIN	Sinusoidal trace	–
3	REFCOS	Reference signal cosinus	–
4	COS	Cosinus trace	–
5	+9 V	Supply voltage	–
6	RS485-	Parameter channel -	–
7	RS485+	Parameter channel +	–
8	SC_SEL	Master encoder plugged in (bridge to GND)	–
9	GND	Supply voltage	–

CN14 - Master Encoder (Incremental)

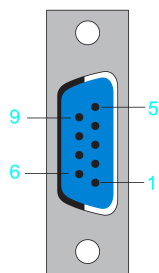

Connection **CN14** - Master encoder (incremental)

Pin	Designation	Meaning	Range
1	_UA	Track A	–
2	UA	Track A	–
3	_UB	Track B	–
4	UB	Track B	–
5	+5 V	Supply voltage	–
6	_UO	Track O	–
7	UO	Track O	–
8	–	Reserved	–
9	GND	Ground	–

CN15 - COM 1 (RS-232)

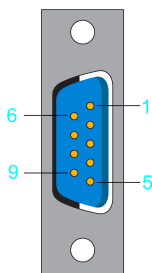

Connection **CN15**

Pin	Designation	Meaning	Range
1	DCD	Data carrier detect	–
2	RxD	Receive data	–
3	TxD	Transmit data	–
4	DTR	Data terminal ready	–
5	GND	Signal ground	–
6	DSR	Data set ready clear to send	–
7	RTS	Request to send	–
8	CTS	Clear to send	–
9	RI	Ring indicator	–

CN16 - COM 2 (RS-485)

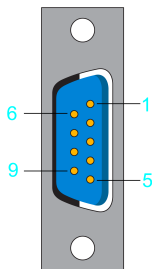

Connection **CN16**

Pin	Designation	Meaning	Range
1	+5 VM	Supply voltage	–
2	TxD-	RS-485 transmit-	–
3	TxD+	RS-485 transmit+	–
4	RxD+	RS-485 receive+	–
5	RxD-	RS-485 receive-	–
6	GNDR	GND via resistor (100 Ohm)	–
7	–	Reserved	–
8	GNDM	Supply voltage	–
9	GNDR	GND via resistor (100 Ohm)	–

CN17 - CAN

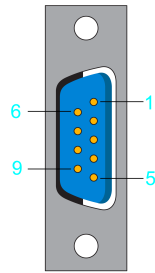

Connection **CN17**

Pin	Designation	Meaning	Range
1	–	Reserved	–
2	CAN_L	Bus line (low)	–
3	GND	Ground	–
4	–	Reserved	–
5	–	Reserved	–
6	–	Reserved	–
7	CAN_H	Bus line (high)	–
8	–	Reserved	–
9	–	Reserved	–

NOTE: A connection of TM5 System via CAN bus and a CANopen interface module is not supported.

CN18 - PROFIBUS

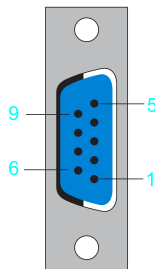

Connection **CN18**

Pin	Designation	Meaning	Range
1	FE (functional earth)	Shield	–
2	–	Reserved	–
3	RxD / TxD -P	Data -P	–
4	CNTR-P	Control signal P	–
5	DGND	Signal ground	–
6	VP	Supply voltage	–
7	–	Reserved	–
8	RxD / TxD -N	Data -N	–
9	–	Reserved	–

Connectors

NOTE: For the connection plugs, use a PROFIBUS connector to connect to the 9 pole PROFIBUS outlet because the bus terminal resistors are in this connector.

Note for the bus terminal resistors:

Step	Action
1	Verify for the first and last bus nodes if the terminal resistors are switched on. Otherwise data transmission will not function properly.
2	Verify if the shielding is applied extensively and on both sides.

Technical Data

Ambient Conditions

Ambient Conditions for Control Cabinet Devices (Without UPS)

Procedure	Parameter	Value	Basis
Operation	Class 3K3		IEC/EN 60721-3-3
	Degree of protection	IP 20	
	Pollution degree	2	
	Ambient temperature	+5...+55 °C (+41...+131 °F)	
	Relative humidity	5...95%	
	• Condensation	No	
	• Formation of ice	No	
	Installation height 0...2000 m (0...6561 ft) ⁽¹⁾	No derating	
	Installation height 2000...3000 m (6561...9842 ft) ⁽¹⁾	45 °C / 113 °F maximum ambient temperature	
	Maximum altitude of transport	13000 m / 42650 ft	
	Class 3M4		
	Shock	147 m/s ² (15 g _n) for a duration of 6 ms	
	Vibration	3.5 mm (0.138 in.) fixed amplitude from 5...8.4 Hz	
9.8 m/s ² (1 g _n) fixed acceleration from 8.4...150 Hz			
Transport	Class 2K3		IEC/EN 60721-3-2
	Ambient temperature	-40...+70 °C (-40...+158 °F)	
	Relative humidity	5...95%	
	• Condensation	No	
	• Formation of ice	No	
	Class 2M2		
	Shock	147 m/s ² (15 g _n) for a duration of 6 ms	
	Vibration	3.5 mm (0.138 in.) fixed amplitude from 5...8.4 Hz	
		9.8 m/s ² (1 g _n) fixed acceleration from 8.4...150 Hz	

Procedure	Parameter	Value	Basis
Long-term storage in transport packaging	Class 1K4		IEC/EN 60721-3-1
	Ambient temperature	-25...+55 °C (-13...+131 ° F)	
	Relative humidity	5...95%	
	• Condensation	No	
	• Formation of ice	No	
(1)		The installation height is defined as height above sea level.	

Ambient Conditions for Control Cabinet Devices (With UPS)

Procedure	Parameter	Value	Basis
Operation	Class 3K3		IEC/EN 60721-3-3
	Degree of protection housing	IP 20	
	Pollution degree	2	
	Ambient temperature	+5...+40°C (+41...+104 ° F)	
	Relative humidity	5...95%	
	• Condensation	No	
	• Formation of ice	No	
	Class 3M4		
	Shock	147 m/s ² (15 g _n) for a duration of 6 ms	
	Vibration	3.5 mm (0.138 in.) fixed amplitude from 5...8.4 Hz	
9.8 m/s ² (1 g _n) fixed acceleration from 8.4...150 Hz			
Transport	Class 2K3		IEC/EN 60721-3-2
	Ambient temperature	-25...+50 °C (-13...+122 ° F)	
	Relative humidity	5...95%	
	• Condensation	No	
	• Formation of ice	No	
	Class 2M2		
	Shock	147 m/s ² (15 g _n) for a duration of 6 ms	
	Vibration	3.5 mm (0.138 in.) fixed amplitude from 5...8.4 Hz	
		9.8 m/s ² (1 g _n) fixed acceleration from 8.4...150 Hz	
	Long-term storage in transport packaging	Class 1K3	
Ambient temperature		-5...+45 °C (-23...+113 °F)	
Relative humidity		5...95%	

Procedure	Parameter	Value	Basis
	• Condensation	No	
	• Formation of ice	No	

Standards and Regulations

Overview

Standards and regulations

CE	EMC Directive 2014/30/EU • EN 61131-2:2007
cULus	UL 508C Power Conversion Equipment
	Adjustable Speed Drives • CSA-C22.2 No. 274
CSA	Industrial Control Equipment • CSA-C22.2 No. 14
China RoHS	Marking for the Restricted Use of Hazardous Substances in Electronic and Electrical Products • SJ/T 11364

Mechanical and Electrical Data

Technical Data PacDrive LMC Pro/Pro2

Category	Parameter	Value				
Product configuration	Type code	PacDrive LMC300	PacDrive LMC400	PacDrive LMC600	PacDrive LMC402 PacDrive LMC802	PacDrive LMC902
Configuration	Processor	up to Rev. 01: CPU Intel Celeron M 600 MHz 512 KB L2 cache	CPU Intel Celeron M 1.5 GHz 1 MB L2 cache	CPU Intel Pentium M 2.0 GHz 2 MB L2 cache	CPU Intel Celeron 2000E 2.2 GHz 2 MB Smart Cache	CPU Intel Core i5 4410E 2.9 GHz 3MB Smart Cache
		as of Rev. 02: CPU Intel Celeron M 1.5 GHz 1 MB L2 cache				
	Memory	512 MB DDR2			1 GB DDR3L	1 GB DDR3L
	NV RAM	128 KB	128 KB	256 KB		
	Battery on the front for BIOS cmos, NVRAM and RTC	Yes (battery maintenance interval: typically 5 years)				
CompactFlash card	At least 128 MB (accessible from the outside)					

Category	Parameter	Value				
Product configuration	Type code	PacDrive LMC300	PacDrive LMC400	PacDrive LMC600	PacDrive LMC402 PacDrive LMC802	PacDrive LMC902
	On/Off button	Yes				
	Reset button	Yes				
	Cooling	Fan (temperature-controlled)				
	Real Time Clock (RTC)	Yes				
Diagnostics	Watchdog	Yes, for resistive loads maximum 24 V (+25 %) / 2 A (inductive loads needs additional suppressor elements)				
	Alphanumeric diagnostic display	4 x 20 letters				
	Status LED indicators	3				
	Integrated data logger for diagnostic messages	Yes				
	Integrated trace recorder (software oscilloscope)	Yes				
	Remote maintenance	Yes				
Bus connections	Integrated motion and field buses	Sercos				
	Integrated additional fieldbus connection (configuration 1)	PROFIBUS DP (master/slave) and				
		CAN (2.0B)				
	Integrated additional fieldbus connection (configuration 2)	RT-Ethernet 10/100 Base-T (2 ports) and				
PROFIBUS DP (master/slave) or 1 x CAN (2.0B)						
	PacNet interface	1				
Communication / interfaces	Serial interfaces	COM1: RS-232				
		COM2: RS-422 / RS-485				
	Network connection	1 x Ethernet 10/100 Base-T (auto negotiation, auto-MDI)			1 x Ethernet 10/100/1000 Base-T (auto negotiation, auto-MDI)	
	USB connection	1 x USB-2.0 (host for storage medium)				
	Hiperface Master Encoder Interface	Voltage output: 10 V / 200 mA Analog channel 0.9 V...1.1 V _{pp} / 2.2...2.8 V _{offset} (maximum 250 KHz) Parameter channel Hiperface RS-485: Cable length ≤50 m (164 ft)				
	Incremental Master Encoder Interface	Voltage output: 5 V / 300 mA Level according to RS-422 (maximum 1 MHz) Cable length ≤50 m (164 ft)				
	Programming interface	Ethernet				
	Additional Hiperface Master Encoder input via PacNet interface with added BT-4/ENC module	Voltage output: 10 V / 200 mA Analog channel 0.9 V...1.1 V _{pp} / 2.2...2.8 V _{offset} (maximum 250 KHz) Parameter channel Hiperface RS-485: Cable length ≤50 m (164 ft)				
	Additional Incremental Master Encoder input via PacNet interface with added BT-4/ENC module	Voltage output: 5 V / 300 mA Level according to RS-422 (maximum 1 MHz) Cable length ≤50 m (164 ft)				
	Master encoder output via PacNet interface	Incremental				
		Integrated OPC interface	Yes			

Category	Parameter	Value				
		PacDrive LMC300	PacDrive LMC400	PacDrive LMC600	PacDrive LMC402 PacDrive LMC802	PacDrive LMC902
Product configuration	Type code					
	Diagnostic interface for remote maintenance	Ethernet or modem				
	Communication protocols	Http				
		Ftp				
ICMP (Ping)						
	Optional slots for OM-C/OM-P/OM-NE	2				
Programming-languages IEC 61131-3	-	Continuous function chart (CFC)				
		Function block diagram (FBD)				
		Instruction list (IL)				
		Structured text (ST)				
		Ladder diagram (LD)				
		Sequential function chart (SFC)				
Touchprobe inputs	Number	16				
	Input characteristic	According to IEC61131-2 type 1				
	U _{IN} low voltage	-3...5 Vdc (< 7 V / 2.8 mA)				
	U _{IN} high voltage	15...30 Vdc (> 10 V / 4.7 mA)				
	Input voltage	24 Vdc (+25%)				
	Input current	7 mA @ 24 V				
	Hardware input filter	100 µs				
	Touchprobe resolution TP0 to TP15	10 µs at a Sercos cycle time of 1, 2, 4 ms				
Additional inputs or Touchprobe inputs via PacNet	Number	maximum 64				
Fast PacNet inputs	Number	64				
Digital inputs	Number	20				
	Input characteristic	According to IEC61131-2 type 1				
	U _{IN} low voltage	-3...5 Vdc (< 7 V / 2.8 mA)				
	U _{IN} high voltage	15...30 Vdc (> 10 V / 4.7 mA)				
	Input voltage	24 Vdc (+25%)				
	Input current	7 mA @ 24 V				
	Hardware input filter	100 µs				
	Input filter	1 ms or 5 ms can be parameterized				
Fast inputs (interrupt)	Number	4				
	Input characteristic	According to IEC61131-2 type 1				
	U _{IN} low voltage	-3...5 Vdc (< 7 V / 2.8 mA)				
	U _{IN} high voltage	15...30 Vdc (> 10 V / 4.7 mA)				
	Input voltage	24 Vdc (+25%)				
	Input current	7 mA @ 24 V				
	Hardware input filter	100 µs				
	Input filter	0.1 ms or 1 ms can be parameterized				

Category	Parameter	Value				
Product configuration	Type code	PacDrive LMC300	PacDrive LMC400	PacDrive LMC600	PacDrive LMC402 PacDrive LMC802	PacDrive LMC902
Analog inputs	Number	2				
	Range U _{IN}	-10...10 V				
		Resolution 12 bit (5 mV)				
		Resistor 100 kOhm				
	Range I _{IN}	-20...20 mA				
		Resolution 12 bit (5 μA)				
Resistor 500 Ohm						
Fast PacNet outputs	Number	64				
Digital outputs	Number	16				
	Output characteristic	According to IEC 61131-2				
	Output voltage	(+UL-3 V) < U _{OUT} < +UL				
	Output supply (+UL)	Maximum 24 V (+25 %)				
	Rated current	I _e = 250 mA per output				
	Inrush current	I _{emax} < 2 A for 1 s				
	Leakage current with 0 signal	< 0.4 mA				
	Transmission time	100 μs				
	Short circuit protection	Yes				
	Open circuit detection	Yes				
	Openload error detection	R _{load} ≥ 150 kΩ				
Analog outputs	Number	2				
	Range U _{OUT}	-10...10 V				
	Resolution	12 bit (5 mV)				
	Load	> 5 kOhm (maximum offset < +/- 130 mV)				
Power	Maximum number of drives	8 servo axes	16 servo axes	99 servo axes	16 servo axes (PacDrive LMC402) 130 servo axes (PacDrive LMC802) 130 servo axes (PacDrive LMC902)	
Power supply	Power supply unit	without UPS (with UPS)				
		<ul style="list-style-type: none"> • up to Rev. 01: 1.5 A (2.5 A) • as of Rev. 02: 2.0 A (3 A) 	2.0 A (3 A)	2.0 A (3 A)	2.0 A (3 A)	
	Supply voltage	DC +24 V -15 %/+25 %				
	Inrush current	maximum 20 A / 1 ms				
	Voltage drop immunity	Up to 25 ms @24 V supply voltage				
	UPS	Yes (optional)				

Category	Parameter	Value				
Product configuration	Type code	PacDrive LMC300	PacDrive LMC400	PacDrive LMC600	PacDrive LMC402 PacDrive LMC802	PacDrive LMC902
	Power consumption of power supply	<ul style="list-style-type: none"> • up to Rev. 01: 24 W (66 W) • as of Rev. 02: 48 W (72 W) 	48 W (72 W)	48 W (72 W)	48 W (72 W)	
Dimensions	Dimensions of housing	DxWxH: 243 x 100 x 310 mm / 9.57 x 3.94 x 12.20 in				
Weight	Weight (with packaging)	3.5 kg (4.1 kg) / 7.71 lb (9.03 lb)				
Pollution degree	2 (according to CN 60664-1)					

Uninterruptible Power Supply UPS

Retrofitting Installation of UPS

Overview

The controllers PacDrive LMC Pro and PacDrive LMC Pro2 can be equipped with an internal battery pack (UPS) for an uninterruptible power supply. The internal battery pack (UPS) is continually being charged via the power supply of the controller while in operation.

The function of the battery pack (UPS) is to maintain the power supply to the controller in the event of a power outage long enough to shut down the controller properly without losing any data. The preset time of shutdown can be up to 5 minutes.

If necessary, the battery pack (UPS) can also be installed or replaced afterwards, as described below.

How to Open the Controller

Step	Action
1	Set main switch to OFF position, or otherwise disconnect all power to the system.
2	Prevent the main switch from being switched back on.
3	Open the operating cover of the PacDrive controller.
4	Loosen the two fastening screws on the front of the controller (1).
5	Remove the electronic module from the housing.



NOTICE
<p>ELECTROSTATIC DISCHARGE</p> <ul style="list-style-type: none"> • Do not touch any of the electrical connections or components. • Prevent electrostatic charges, for example, by wearing appropriate clothing. • If you must touch circuit boards, do so only on the edges. • Remove existing static charge by touching a grounded, metallic surface. <p>Failure to follow these instructions can result in equipment damage.</p>

How to Connect the Battery Pack (UPS)

Step	Action
1	Adjust the battery pack (UPS) and attach with two cable ties (1).
2	Connect the battery cable (2).

Improperly secured equipment and accessories can cause mechanical damage of PacDrive controller.

⚠ CAUTION
<p>BATTERY PACK (UPS) NOT PROPERLY SECURED</p> <ul style="list-style-type: none"> • Use only the supplied cable ties to secure the battery pack (item number VW3E6006). • Verify that the battery pack (UPS) is properly secured. <p>Failure to follow these instructions can result in injury or equipment damage.</p>

The estimated maintenance interval for replacing the battery pack (UPS) is 3 years.

⚠ CAUTION
<p>POSSIBLE DATA LOSS BY POWER OUTAGE</p> <p>Replace the battery pack (UPS) at regular maintenance intervals not to exceed 3 years.</p> <p>Failure to follow these instructions can result in injury or equipment damage.</p>

⚠ CAUTION
<p>DAMAGE TO DISPLAY SUPPLY CABLE POSSIBLE</p> <ul style="list-style-type: none"> • Do not force the electronic module into the housing. • Ensure that during installation of the electronic module the display supply cable does not get caught or torn. <p>Failure to follow these instructions can result in injury or equipment damage.</p>

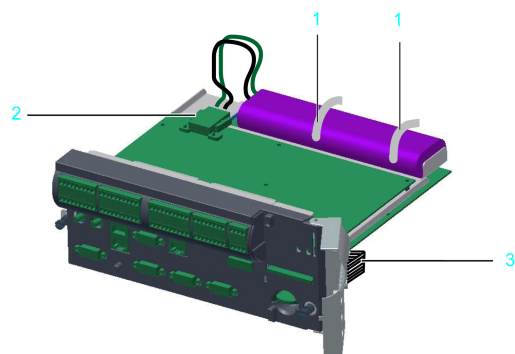

- 1 Cable ties
- 2 Battery cable
- 3 Display supply cable

How to Connect the Controller

Step	Action
1	Carefully push the electronic module of the controller back into the housing.
2	Tighten the two fastening screws on the front of the controller.
3	Close the operating cover.

Optional Modules

Fieldbus Combinations

General

The PacDrive LMC Pro is equipped with a NetXchip communication processor onboard which can be operated with two independent field bus protocols. Only one Ethernet field bus can be used. Through the two optional module slots of the PacDrive LMC Pro, further field buses can be used. They can be equipped with the optional modules OM-P, OM-C and OM-NE.

NOTE: Only two fieldbuses can be loaded on the internal communication processor at the same time.

The OM-P and OM-C option modules do not have their own communication processors. When using OM-P or OM-C, the communication channels on the internal communication processor are used for this purpose. On the other hand, the OM-NE does not use the internal communication processor as it has its own communication processor.

The restriction of only two loaded fieldbuses on the internal communication processor is consequently not resolved by using the OM-P or OM-C modules.

NOTE: C2C Slave is only supported on the onboard communication processor.

The following field bus combinations are possible:

Combination	Onboard			Option 1			Option 2
	LMC x00C			OM-P	OM-C	OM-NE	OM-NE
1	Profibus	—	—	Profibus	—	—	Ethernet
2	—	CAN	—	—	CAN	—	Ethernet
3	—	—	Ethernet	—	—	Ethernet	Ethernet
4	Profibus	CAN	—	—	—	Ethernet	Ethernet
5	Profibus	—	Ethernet	—	—	Ethernet	Ethernet
6	—	CAN	Ethernet	—	—	Ethernet	Ethernet

In this way, the PacDrive LMC Pro can, for example, be used with the following field bus combinations:

- Combination 1: one PROFIBUS onboard with a second PROFIBUS (option 1) and an Ethernet field bus (option 2)
- Combination 5: one PROFIBUS and one Ethernet field bus onboard with two other Ethernet field buses (option 1 and option 2).

Option 1 and option 2 can be implemented either by the optional controller module on the right or on the left.

Communication Module OM-NE

Overview

Initial Installation

Initial installation of the optional module should only be done by Schneider Electric personnel.

General Information

The OM-NE module is a general communication module which features two Ethernet connectors to realize Ethernet based field bus protocols.

OM-NE module with slot assignment

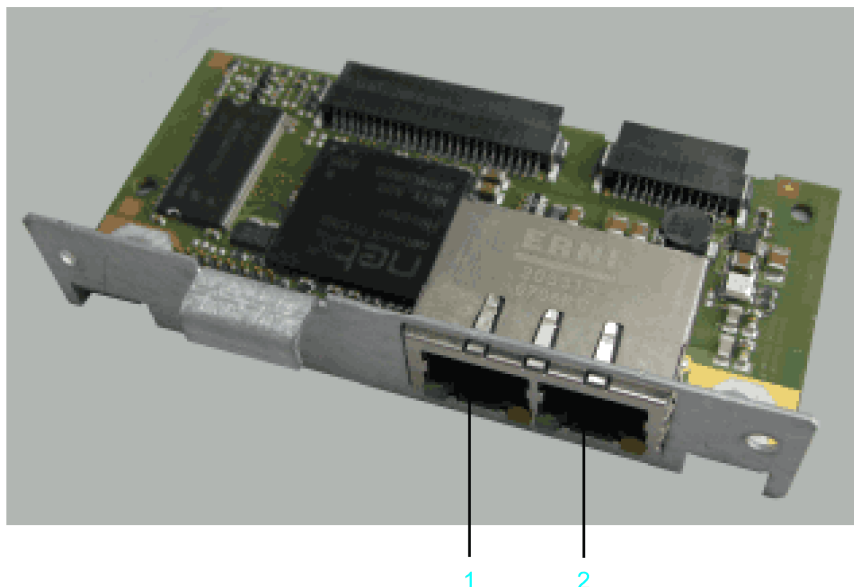

1 Ethernet connection **CN30 (RT Eth P1)**

2 Ethernet connection **CN31 (RT Eth P2)**

After installing the optional module, the controller will automatically detect the module. Then configure it by using the controller configuration in EcoStruxure Machine Expert Logic Builder.

NOTE: Only use OM-NE modules from hardware code 0008 for PacDrive LMC Pro/Pro2 controllers.

Initial Installation of the Optional Module

Required Tools for Initial Installation of the Optional Module

Module part	Tool
Controller front side	Cross slot maximum PH2 alternative PH1; slot maximum 1.2 x 7.0
Backplane and blanking plates on the module sockets	Cross slot maximum PH1

How to Open the Controller

Step	Action
1	Set main switch to OFF position, or otherwise disconnect all power to the system.
2	Prevent main switch from being switched back on.
3	Open the operating cover of the PacDrive controller upwards.
4	Undo the two fastening screws on the front of the controller.
5	Then remove the electronic module from housing.

NOTICE
INCORRECT INSERTION OF OPTIONAL MODULE
Do not insert the optional module when the controller is under power.
Failure to follow these instructions can result in equipment damage.

How to Install the Backplane

The backplane connects the optional module to the controller.

How to install the backplane:

Step	Action
1	Insert the backplane on the rear of the module shaft into the controller circuit board.
2	Screw the backplane to the three holes provided.

How to Install the Optional Module

The module is ready-to-use when delivered.

You can insert the module into module slot 1 or module slot 2.

How to install the optional module:

Step	Action
1	Select one of the two module slots on the controller.
2	Remove module slot blanking plate.
3	Insert module into open slot.
4	Screw module to module shaft with two M3x6 screws (tightening torque: 0.5 Nm (4.42 lbf in)). Result: The module is now installed.

How to Close the Controller

Step	Action
1	Carefully push the electronic module of the controller back into the housing.
2	Tighten the two fastening screws on the front of the controller.
3	Close operating cover.

Removal of the Optional Module (No Replacement)

Required Tool for Removal of the Optional Module (no Replacement)

Module part	Tool
Module shaft	Cross slot maximum PH1

How to Disassemble the Optional Module

Step	Action
1	Set main switch to OFF position, or otherwise disconnect all power to the system.
2	Prevent main switch from being switched back on.
3	Undo the two M3x6 screws on the module shaft.
4	Withdraw the module from the cartridge. Result: The module is deinstalled now and the module shaft is empty.
5	Screw the blanking plate onto the empty module shaft. Result: The empty module shaft is closed by the blanking plate.

NOTICE
INOPERABLE EQUIPMENT Do not remove the optional module when the controller is under power. Failure to follow these instructions can result in equipment damage.

Replacement of the Optional Module

Required Tool for Replacing the Optional Module

Module part	Tool
Module shaft	Cross slot maximum PH1

How to Disassemble the Optional Module

Step	Action
1	Set main switch to OFF position, or otherwise disconnect all power to the system.
2	Prevent main switch from being switched back on.
3	Undo the two M3x6 screws on the module shaft.
4	Withdraw the module from the cartridge. Result: The module is deinstalled now and the module shaft is empty.

NOTICE
INOPERABLE EQUIPMENT Do not remove the optional module when the controller is under power. Failure to follow these instructions can result in equipment damage.

How to Install the Optional Module

The module is ready-to-use when delivered.

Step	Action
1	Set main switch to OFF position, or otherwise disconnect all power to the system.
2	Prevent main switch from being switched back on.

Step	Action
3	Insert module into open slot.
4	Screw module to module shaft with two M3x6 screws (tightening torque: 0.5 Nm (4.42 lbf in)). Result: The module is now installed.

NOTICE
INCORRECT INSERTION OF OPTIONAL MODULE
Do not insert the optional module when the controller is under power.
Failure to follow these instructions can result in equipment damage.

Electrical Connections

Connection Details Optional Module OM-NE



CN30/31 - Ethernet outlet

Pin	Designation	Meaning
1	Tx+	Transmit data +
2	Tx-	Transmit data -
3	Rx+	Receive data +
4	-	Reserved
5	-	
6	Rx-	Receive data -
7	-	Reserved
8	-	

NOTE: Operate the EtherNet/IP scanner only by using the connection **CN30 (RT Eth P1)**. The connection **CN31 (RT Eth P2)** is reserved.

NOTE: When using them as EtherCAT slave, the connection **CN30 (RT Eth P1)** represents the input port and the connection **CN31 (RT Eth P2)** the output port. The input port and output port are predetermined by the firmware and cannot be configured.

LED Indicator Description EtherCAT

LEDs EtherCAT master

LED indicator	Color	State	Meaning
LINK/RJ45 Ch0 & Ch1	green LED indicator		
	Green	On	A connection to Ethernet exists.
	Off	Off	The device has no connection to Ethernet.
RJ45 Ch0 & Ch1	yellow LED indicator		

LED indicator	Color	State	Meaning
	Yellow	Flashing cyclic with 2.5 Hz	The device sends/receives Ethernet frames.

LEDs EtherCAT slave

LED indicator	Color	State	Meaning
LINK/RJ45 Ch0 & Ch1	green LED indicator		
	Green	On	A connection to Ethernet exists.
	Green	Flashing cyclic with 2.5 Hz	The device sends/receives Ethernet frames.
	Off	Off	The device has no connection to Ethernet.
RJ45 Ch0 & Ch1	yellow LED indicator		
	–	–	The LED indicator is not used.

LED Indicator Description EtherNet/IP

LEDs EtherNet/IP scanner (master)

LED indicator	Color	State	Meaning
LINK/RJ45 Ch0 & Ch1	green LED indicator		
	Green	On	A connection to Ethernet exists.
	Off	Off	The device has no connection to Ethernet.
ACT/RJ45 Ch0 & Ch1	yellow LED indicator		
	Yellow	Flashes	The device sends/receives Ethernet frames.

LEDs EtherNet/IP adapter (slave)

LED indicator	Color	State	Meaning
LINK/RJ45 Ch0 & Ch1	green LED indicator		
	Green	On	A connection to Ethernet exists.
	Off	Off	The device has no connection to Ethernet.
ACT/RJ45 Ch0 & Ch1	yellow LED indicator		
	Yellow	Flashes	The device sends/receives Ethernet frames.

LED Indicator Description PROFINET

LEDs PROFINET controller

LED indicator	Color	State	Meaning
LINK/RJ45 Ch0 & Ch1	green LED indicator		
	Green	On	A connection to Ethernet exists.
	Off	Off	The device has no connection to Ethernet.
RX/TX/RJ45 Ch0 & Ch1	yellow LED indicator		
	Yellow	Flashes	The device sends/receives Ethernet frames.

LEDs PROFINET device

LED indicator	Color	State	Meaning
LINK/RJ45 Ch0 & Ch1	green LED indicator		
	Green	On	A connection to Ethernet exists.
	Off	Off	The device has no connection to Ethernet.
RX/TX/RJ45 Ch0 & Ch1	yellow LED indicator		
	Yellow	Flashes	The device sends/receives Ethernet frames.

Communication Module OM-P

Overview

Initial Installation

Initial installation of the optional module should only be done by Schneider Electric personnel.

General Information

Another PROFIBUS interface is made available via the OM-P module.

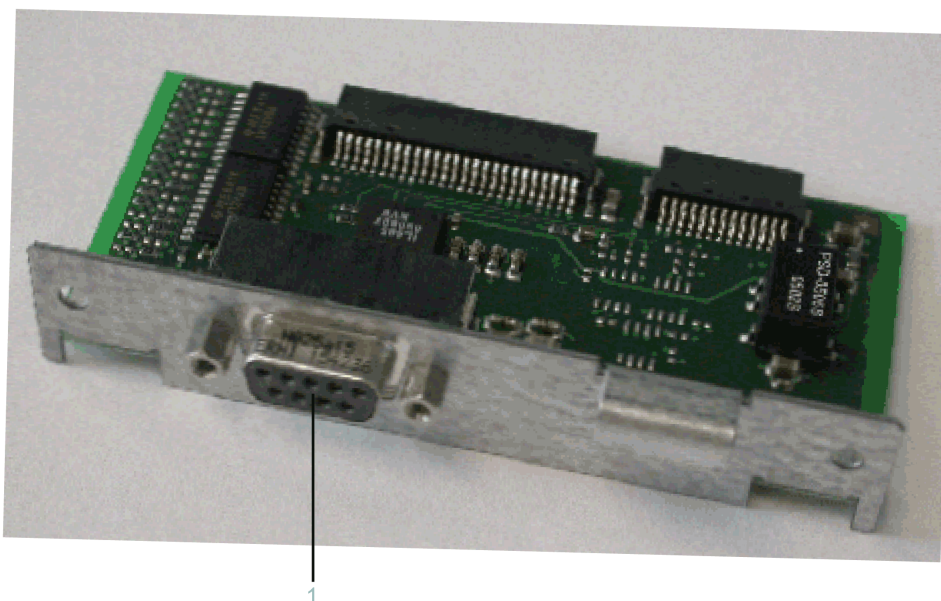

After installing the optional module, the controller will automatically detect the module. Then configure it by using the controller configuration in EcoStruxure Machine Expert Logic Builder.

Initial Installation of the Optional Module

Required Tools for Initial Installation of the Optional Module

Module part	Tool
Controller front side	Cross slot maximum PH2 alternative PH1; slot maximum 1.2 x 7.0
Backplane and blanking plates on the module sockets	Cross slot maximum PH1

How to Open the Controller

Step	Action
1	Set main switch to OFF position, or otherwise disconnect all power to the system.
2	Prevent main switch from being switched back on.
3	Open the operating cover of the PacDrive controller upwards.
4	Undo the two fastening screws on the front of the controller.
5	Then remove the electronic module from housing.

NOTICE

INCORRECT INSERTION OF OPTIONAL MODULE

Do not insert the optional module when the controller is under power.

Failure to follow these instructions can result in equipment damage.

How to Install the Backplane

The backplane connects the optional module to the controller.

How to install the backplane:

Step	Action
1	Insert the backplane on the rear of the module shaft into the controller circuit board.
2	Screw the backplane to the three holes provided.

How to Install the Optional Module

The module is ready-to-use when delivered.

You can insert the module into module slot 1 or module slot 2.

How to install the optional module:

Step	Action
1	Select one of the two module slots on the controller.
2	Remove module slot blanking plate.
3	Insert module into open slot.
4	Screw module to module shaft with two M3x6 screws (tightening torque: 0.5 Nm (4.42 lbf in)). Result: The module is now installed.

How to Close the Controller

Step	Action
1	Carefully push the electronic module of the controller back into the housing.
2	Tighten the two fastening screws on the front of the controller.
3	Close operating cover.

Removal of the Optional Module (No Replacement)

Required Tool for Removal of the Optional Module

Module part	Tool
Module shaft	Cross slot maximum PH1

How to Disassemble the Optional Module

Step	Action
1	Set main switch to OFF position, or otherwise disconnect all power to the system.
2	Prevent main switch from being switched back on.
3	Undo the two M3x6 screws on the module shaft.
4	Withdraw the module from the cartridge. Result: The module is deinstalled now and the module shaft is empty.
5	Screw the blanking plate onto the empty module shaft. Result: The empty module shaft is closed by the blanking plate.

NOTICE

INOPERABLE EQUIPMENT

Do not remove the optional module when the controller is under power.

Failure to follow these instructions can result in equipment damage.

Replacement of the Optional Module

Required Tool for Replacing the Optional Module

Module part	Tool
Module shaft	Cross slot maximum PH1

How to Disassemble the Optional Module

Step	Action
1	Set main switch to OFF position, or otherwise disconnect all power to the system.
2	Prevent main switch from being switched back on.

Step	Action
3	Undo the two M3x6 screws on the module shaft.
4	Withdraw the module from the cartridge. Result: The module is deinstalled now and the module shaft is empty.

NOTICE

INOPERABLE EQUIPMENT
Do not remove the optional module when the controller is under power.
Failure to follow these instructions can result in equipment damage.

How to Install the Optional Module

The module is ready-to-use when delivered.

Step	Action
1	Set main switch to OFF position, or otherwise disconnect all power to the system.
2	Prevent main switch from being switched back on.
3	Insert module into open slot.
4	Screw module to module shaft with two M3x6 screws (tightening torque: 0.5 Nm (4.42 lbf in)). Result: The module is now installed.

NOTICE

INCORRECT INSERTION OF OPTIONAL MODULE
Do not insert the optional module when the controller is under power.
Failure to follow these instructions can result in equipment damage.

Electrical Connections

Connection Details Optional Module OM-P

CN33 - PROFIBUS interface

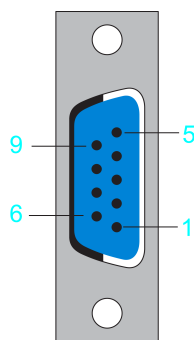

Pin	Designation	Meaning	Range	Maximum cross section
1	PE	Shield	–	0.25 mm ²
2	–	Reserved	–	
3	RxD / TxD -P	Data -P	–	

Pin	Designation	Meaning	Range	Maximum cross section
4	CNTR-P	Control signal P	–	
5	DGND	Signal ground	–	
6	VP	Supply voltage	–	
7	–	Reserved	–	
8	RxD / TxD -N	Data N	–	
9	–	Reserved	–	

Communication Module OM-C

Overview

Initial Installation

Initial installation of the optional module should only be done by Schneider Electric personnel.

General Information

Another CANBUS interface is made available via the OM-C module.

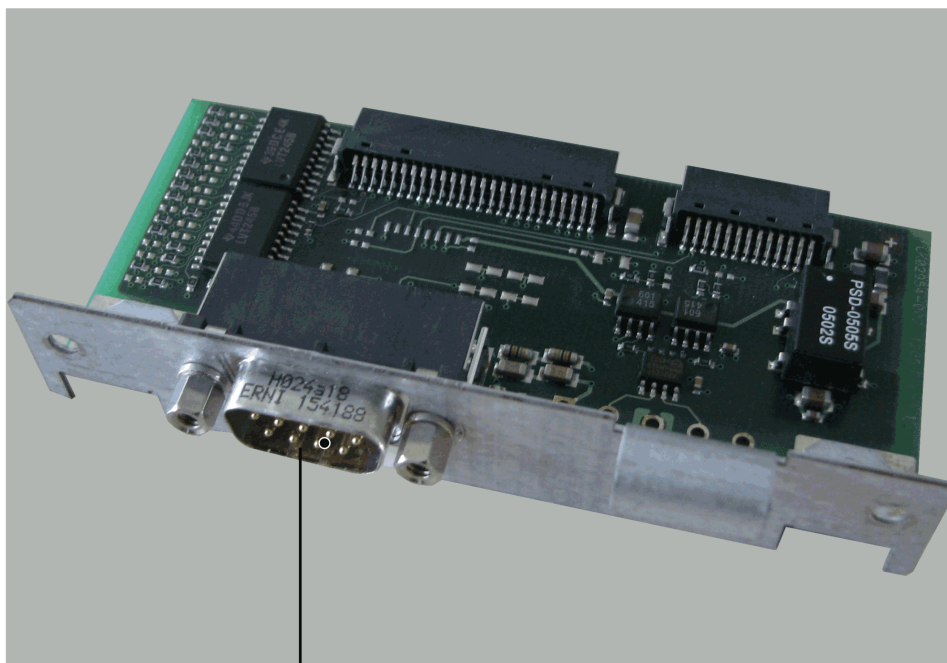

1

After installing the optional module, the controller will automatically detect the module. Then configure it by using the controller configuration in EcoStruxure Machine Expert Logic Builder.

Initial Installation of the Optional Module

Required Tool for Initial Installation of the Optional Module

Module part	Tool
Controller front side	Cross slot maximum PH2 alternative PH1; slot maximum 1.2 x 7.0
Backplane and blanking plates on the module sockets	Cross slot maximum PH1

How to Open the Controller

Step	Action
1	Set main switch to OFF position, or otherwise disconnect all power to the system.
2	Prevent main switch from being switched back on.
3	Open the operating cover of the PacDrive controller upwards.
4	Undo the two fastening screws on the front of the controller.
5	Then remove the electronic module from housing.

NOTICE

INCORRECT INSERTION OF OPTIONAL MODULE

Do not insert the optional module when the controller is under power.

Failure to follow these instructions can result in equipment damage.

How to Install the Backplane

The backplane connects the optional module to the controller.

How to install the backplane:

Step	Action
1	Insert the backplane on the rear of the module shaft into the controller circuit board.
2	Screw the backplane to the three holes provided.

How to Install the Optional Module

The module is ready-to-use when delivered.

You can insert the module into module slot 1 or module slot 2.

How to install the optional module:

Step	Action
1	Select one of the two module slots on the controller.
2	Remove module slot blanking plate.
3	Insert module into open slot.
4	Screw module to module shaft with two M3x6 screws (tightening torque: 0.5 Nm (4.42 lbf in)). Result: The module is now installed.

How to Close the Controller

Step	Action
1	Carefully push the electronic module of the controller back into the housing.
2	Tighten the two fastening screws on the front of the controller.
3	Close operating cover.

Removal of the Optional Module (No Replacement)

Required Tool for Removal of the Optional Module (No Replacement)

Module part	Tool
Module shaft	Cross slot maximum PH1

How to Disassemble the Optional Module

Step	Action
1	Set main switch to OFF position, or otherwise disconnect all power to the system.
2	Prevent main switch from being switched back on.
3	Undo the two M3x6 screws on the module shaft.
4	Withdraw the module from the cartridge. Result: The module is deinstalled now and the module shaft is empty.
5	Screw the blanking plate onto the empty module shaft. Result: The empty module shaft is closed by the blanking plate.

NOTICE

INOPERABLE EQUIPMENT

Do not remove the optional module when the controller is under power.

Failure to follow these instructions can result in equipment damage.

Replacement of the Optional Module

Required Tool for Replacing the Optional Module

Module part	Tool
Module shaft	Cross slot maximum PH1

How to Disassemble the Optional Module

Step	Action
1	Set main switch to OFF position, or otherwise disconnect all power to the system.
2	Prevent main switch from being switched back on.

Step	Action
3	Undo the two M3x6 screws on the module shaft.
4	Withdraw the module from the cartridge. Result: The module is deinstalled now and the module shaft is empty.

NOTICE

INOPERABLE EQUIPMENT

Do not remove the optional module when the controller is under power.

Failure to follow these instructions can result in equipment damage.

How to Install the Optional Module

The module is ready-to-use when delivered.

Step	Action
1	Set main switch to OFF position, or otherwise disconnect all power to the system.
2	Prevent main switch from being switched back on.
3	Insert module into open slot.
4	Screw module to module shaft with two M3x6 screws (tightening torque: 0.5 Nm (4.42 lbf in)). Result: The module is now installed.

NOTICE

INCORRECT INSERTION OF OPTIONAL MODULE

Do not insert the optional module when the controller is under power.

Failure to follow these instructions can result in equipment damage.

Electrical Connections

Connection Details Optional Module OM-C

CN34 - CANBUS interface

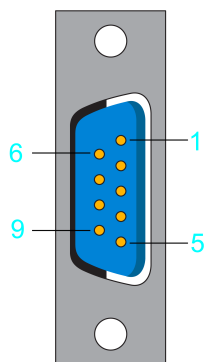

Pin	Designation	Meaning	Range	Maximum cross section
1	–	Reserved	–	0.25 mm ²
2	CAN_L	Bus line (low)	–	
3	GND	Ground	–	

Pin	Designation	Meaning	Range	Maximum cross section
4	–	Reserved	–	
5	–	Reserved	–	
6	–	Reserved	–	
7	CAN_H	Bus line (high)	–	
8	–	Reserved	–	
9	EXVCC	Ext. supply trans.	–	

NOTE: The connection of the TM5 System to the PacDrive controller can only occur via a Sercos bus interface TM5NS31. A connection of TM5 System via CAN bus and a CANopen interface module is not supported.

Appendices

What's in This Part

Disposal 106

Disposal

What's in This Chapter

Disposal	106
----------------	-----

Disposal

Information on the Disposal of Schneider Electric Products

NOTE: The components consist of different materials which can be recycled and must be disposed of separately.

Step	Action
1	Dispose of the packaging in accordance with the relevant national regulations.
2	Dispose of the packaging at the disposal sites provided for this purpose.
3	Dispose of controller in accordance with the applicable national regulations.

Index

B

bending cycles 32

C

certifications 81
 climatic 30
 condensate 30
 cooling units 30

D

daisy chain connector box 22
 daisy chain wiring 22
 degree of protection 29
 domestic appliances 17

F

floating systems 17

H

hazardous, explosive atmospheres 17

I

intended use 6
 IP 29

L

life support system 17

M

machine grounding 31
 mechanical 30
 minimum bending radius 32
 minimum cross sections 31
 mobile systems 17

P

portable systems 17
 product related information 12

Q

qualification of personnel 5

T

temperature limit 30

U

underground 17

W

wiring 31

Schneider Electric
35 rue Joseph Monier
92500 Rueil Malmaison
France

+ 33 (0) 1 41 29 70 00

www.se.com

As standards, specifications, and design change from time to time,
please ask for confirmation of the information given in this publication.

© 2023 Schneider Electric. All rights reserved.

EIO0000001503.08