

XPSMCMMX080x

Instruction Sheet (Original Language)

04/2018

The information provided in this documentation contains general descriptions and/or technical characteristics of the performance of the products contained herein. This documentation is not intended as a substitute for and is not to be used for determining suitability or reliability of these products for specific user applications. It is the duty of any such user or integrator to perform the appropriate and complete risk analysis, evaluation and testing of the products with respect to the relevant specific application or use thereof. Neither Schneider Electric nor any of its affiliates or subsidiaries shall be responsible or liable for misuse of the information contained herein. If you have any suggestions for improvements or amendments or have found errors in this publication, please notify us.

You agree not to reproduce, other than for your own personal, noncommercial use, all or part of this document on any medium whatsoever without permission of Schneider Electric, given in writing. You also agree not to establish any hypertext links to this document or its content. Schneider Electric does not grant any right or license for the personal and noncommercial use of the document or its content, except for a non-exclusive license to consult it on an "as is" basis, at your own risk. All other rights are reserved.

All pertinent state, regional, and local safety regulations must be observed when installing and using this product. For reasons of safety and to help ensure compliance with documented system data, only the manufacturer should perform repairs to components.

When devices are used for applications with technical safety requirements, the relevant instructions must be followed.

Failure to use Schneider Electric software or approved software with our hardware products may result in injury, harm, or improper operating results.

Failure to observe this information can result in injury or equipment damage.

© 2018 Schneider Electric. All Rights Reserved.

Table of Contents



About the Book	5
XPSMCMX0802x Expansion Module	7



At a Glance

Document Scope

This information is about the usage and configuration of the XPSMCMX0802• expansion module for the XPSMCMCP0802• Modular Safety Controller.

Validity Note

The characteristics that are presented in the present manual should be the same as those characteristics that appear online. In line with our policy of constant improvement, we may revise content over time to improve clarity and accuracy. If you see a difference between the manual and online information, use the online information as your reference.

Product Related Information

The XPSMCM• is built to the following safety integrity levels: SIL 3 according to EN/IEC 61508, SILcl 3 according to EN/IEC 62061, PL e category 4 according to EN ISO 13849-1 in accordance with the applicable standards. However, the definitive SIL and PL of the application depends on the number of safety-related components, their parameters, and the connections that are made, as per the risk analysis.

The module must be configured in accordance with the application-specific risk analysis and all the applicable standards.

Pay particular attention in conforming to any safety information, different electrical requirements, and normative standards that would apply to your adaptation.

WARNING

UNINTENDED EQUIPMENT OPERATION

Perform an in-depth risk analysis to determine the appropriate safety integrity level for your specific application, based on all the applicable standards.

Failure to follow these instructions can result in death, serious injury, or equipment damage.

NOTE: Configuration of the module is the sole responsibility of the installer or user.

For all matters concerning functional safety, if necessary, contact the competent safety authorities or the competent trade associations of your country.

Consult the specific product documentation and the relative product and/or application standards to ensure correct use of modules connected to the XPSMCMX0802• module within your specific application.

The ambient temperature of the installed system must be compatible with the operating temperature parameters stated on the product label and in the product specifications.

XPSMCMX0802x Expansion Module

Safety-related Information

NOTE: The safety-related function can be compromised if this module is not used for the intended purpose and in accordance with the instructions in the present document. This module must only be used as safety-related equipment on machines intended to protect persons, material, and installations.

DANGER

HAZARD OF ELECTRIC SHOCK, EXPLOSION OR ARC FLASH

- Do not install, operate, or maintain this equipment unless you are a trained professional electrician and qualified to perform these activities.
- Install and use this equipment only in locations known to be non-hazardous.
- Do not use the equipment described herein to supply external drives or contactors.
- Use the same ground supply (0 Vdc) to supply all modules of the Modular Safety Controller family.
- Disconnect all power from all equipment including connected input devices, contactors, and drives prior to removing any covers or doors, or installing or removing any accessories, hardware, cables, or wires.
- If connected drives or contactors contain stored energy, allow sufficient time after the removal of power for the stored energy to discharge in accordance with the instructions for those drives and contactors.
- Always use a properly rated voltage sensing equipment to confirm that the power is removed.
- Avoid contacting terminals with hand or tools until the power has been confirmed removed.
- Follow all electrical safety regulations and standards (for example, lockout/tag-out, phase grounding, barriers) to reduce the possibility of contact with hazardous voltages in the work area.
- Remove locks, tags, barriers, temporary ground straps, and replace and secure all covers, doors, accessories, hardware, cables, and wires and confirm that a proper ground connection exists before reapplying power to the unit.
- Complete thorough hardware tests and system commissioning to verify that line voltages are not present on the control circuits before using your hardware operationally.
- Use only the specified voltage when operating this equipment and any associated products.

Failure to follow these instructions will result in death or serious injury.

DANGER

LOSS OF DESIGNATED SAFETY FUNCTION

- Install the XPSMCM• Modular Safety Controller system in an enclosure with a degree of protection of at least IP 54.
- Always use an isolated power supply (PELV) to help prevent the application of line voltages to control circuitry in the case of short-circuits.

Failure to follow these instructions will result in death or serious injury.

DANGER

POTENTIAL FOR EXPLOSION OR UNINTENDED EQUIPMENT OPERATION

- Install and use the Modular Safety Controller in non-hazardous locations only.
- Do not use the Modular Safety Controller system for life support systems.

Failure to follow these instructions will result in death or serious injury.

NOTE: The observation of operating limits and duty cycles is of particular importance for equipment designed to perform a safety-related function. If this module has been subjected to electrical, mechanical, or environmental stresses in excess of its stated limits, do not use it.

WARNING

UNINTENDED EQUIPMENT OPERATION

- Do not exceed any of the rated operating limits for the equipment specified in the present document.
- Immediately cease using and replace any equipment that has or might have been subjected to conditions in excess of its rated operating limits.

Failure to follow these instructions can result in death, serious injury, or equipment damage.

User Responsibilities

The information provided in this documentation contains general descriptions and/or technical characteristics of the performance of the products contained herein. This documentation is not intended as a substitute for and is not to be used for determining suitability or reliability of these products for specific user applications. It is the duty of any such user, machine builder, or system integrator to perform the appropriate and complete risk analysis, evaluation, and testing of the products with respect to the relevant specific application or use thereof.

Neither Schneider Electric nor any of its affiliates or subsidiaries shall be responsible or liable for misuse of the information contained herein. If you have any suggestions for improvements or amendments or have found discrepancies in this publication, notify Schneider Electric. All pertinent safety regulations must be observed when installing and using this product. For reasons of safety and to help ensure compliance with documented system data, only the manufacturer should perform repairs to components.

Qualified Personnel

Electrical equipment should be installed, operated, serviced, and maintained only by qualified personnel. A qualified person is one who has skills and knowledge related to the construction and operation of this electrical equipment and its installation, and has received safety training to recognize and avoid the hazards involved.

Modular Safety Controller

Key safety values	Value	Standard
Probability of a dangerous failure per hour (PFHd)	Refer to module-specific characteristics.	IEC 61508
Safety Integrity Level (SIL)	3	
Hardware Fault Tolerance (HFT)	1 (type B)	
Defined "Safe state" ¹	All outputs off	
Safety Integrity Level claim limit (SILcl)	3	IEC 62061
Type	4	EN 61496-1
Performance Level (PL) ²	e	EN ISO 13849-1
Diagnostic Coverage _{avg}	High	
Mean Time to Dangerous Failure (MTTFd)	2500 years with Category 4 architecture, otherwise 100 years ³	
Category ²	4	
Maximum service life	20 years	
<p>¹ The Modular Safety Controller and expansion modules are in the defined safe state when their outputs are off. To exit the defined safe state condition, a combination of hardware inputs is required.</p> <p>² The EN ISO 13849-1 performance level (PL) and safety category (Cat) of the overall system depends on multiple factors, including the selected modules, wiring practices, the physical environment, and the application.</p> <p>³ If expansion modules are added to the configuration, the MTTFd of the overall system is affected, refer to the SoSafe Configurable Project Report.</p>		

WARNING

UNINTENDED EQUIPMENT OPERATION

- You must carry out a risk assessment in accordance with EN ISO 14121-1.
- Validate the entire system/machine in accordance with the required performance level and risk assessment.

Failure to follow these instructions can result in death, serious injury, or equipment damage.

Module and Function Description

The XPSMCMX0802• is an input/output expansion module for the XPSMCM• Modular Safety Controller offer. The XPSMCMX0802• module can only be configured in conjunction with the XPSMCMCP0802• Modular Safety Controller. The XPSMCMX0802• module contains eight safety-related inputs and two safety-related outputs (four physical channels) which can be configured using SoSafe Configurable software.

Node Address: The XPSMCMX0802• module contains two node address inputs: NODE_ADDR0 and NODE_ADDR1.

The NODE_ADDR0 and NODE_ADDR1 inputs (on the expansion modules) are used to attribute a physical address to the modules with the connections presented in the table:

NODE	NODE_ADDR1 (Terminal 3)	NODE_ADDR0 (Terminal 2)
NODE 0	0 (or not connected)	0 (or not connected)
NODE 1	0 (or not connected)	24 Vdc
NODE 2	24 Vdc	0 (or not connected)
NODE 3	24 Vdc	24 Vdc

NOTE: It is not allowed to use the same physical address for two units of the same module reference.

Restart (RST): The RESTART (RST) signal input allows the XPSMCMCP0802• Modular Safety Controller to verify an EDM (External Device Monitoring) feedback signal (series of contacts) from external contactors, and to monitor manual/automatic operation.

WARNING

UNINTENDED EQUIPMENT OPERATION

- The RESTART command must be installed outside the zone of operation in a position where the zone of operation and the entire work area concerned are clearly visible.
- It must not be possible to operate the RESTART command from inside the zone of operation.

Failure to follow these instructions can result in death, serious injury, or equipment damage.

Inputs

The XPSMCMX0802• module contains eight digital inputs in order to physically connect inputs such as safety sensors (e.g. magnetic switches) and safety push-buttons to the controller. The specific monitoring of these inputs is configured within the SoSafe Configurable software environment.

Inputs must be supplied by the line control outputs (test outputs) to reach performance level **e** in accordance with EN/ISO 13849-1 Category 4 architecture and SILcl 3 (Safety Integrity Level claim limit) in accordance with EN/IEC 62061.

Outputs

The *STATUS* outputs are configurable digital outputs that indicate the diagnostic status of safety function inputs and/or outputs. The status outputs are non-safety related outputs (not implicated in the prescribed safety function) and are intended to be connected only for diagnostics purposes.



 WARNING
UNINTENDED EQUIPMENT OPERATION
Do not use <i>STATUS</i> outputs for safety-related functions.
Failure to follow these instructions can result in death, serious injury, or equipment damage.

The test outputs are used for line control monitoring and are connected to the various eight inputs on the XPSMCMX0802• module. The test outputs are defined using the SoSafe Configurable software. The test outputs must be used to monitor the presence of short-circuits or overloads on the inputs and reach performance level **e** in accordance with EN/ISO 13849-1 Category 4 architecture and SILcl 3 (Safety Integrity Level claim limit) in accordance with EN/IEC 62061.

The two *OSSD* (Output Signal Switching Device) outputs (static semiconductor safety outputs) on the XPSMCMX0802• module are short circuit protected. Physically two channels per output are required to reach a Category 4 architecture with the connected outputs. Two status outputs are available on this module.

Terminals

Examples with maximum number of terminals. Regarding terminal designation, refer to table below.

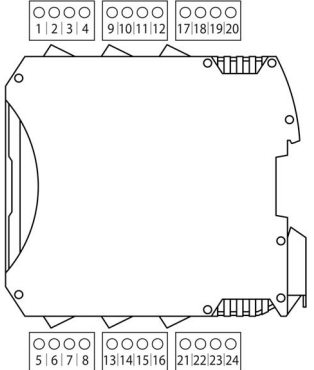
<p>Screw terminals example</p> 	<p>Spring terminals example</p> 	<p>Terminal numbers</p> 
--	---	---

Terminal	Signal	LED	Type	Description	Operation
1	24 VDC	PWR	-	24 Vdc power supply	-
2	NODE_ADDR0	ADDR0	Input	Node selection	Input type 3. Maximum applicable resistance 1.2 kΩ.
3	NODE_ADDR1	ADDR1			
4	0 VDC	PWR	-	0 Vdc power supply	-
5	OSSD1_A	OUT 1	Output	Static output 1	PNP (sourcing) active high
6	OSSD1_B	OUT 1			
7	RESTART1	RST 1	Input	Feedback/Restart 1	Input type 3. Maximum applicable resistance 1.2 kΩ.
8	OUT_STATUS 1	STATUS 1	Output	Configurable diagnostic output	PNP (sourcing) active high
9	OSSD2_A	OUT 2		Static output 2	
10	OSSD2_B	OUT 2			
11	RESTART2	RST 2	Input	Feedback/Restart 2	Input type 3. Maximum applicable resistance 1.2 kΩ.
12	OUT_STATUS 2	STATUS 2	Output	Configurable diagnostic output	PNP (sourcing) active high
13	OUT_TEST1	-		Short circuit detected output	
14	OUT_TEST2	-			
15	OUT_TEST3	-			
16	OUT_TEST4	-			

Terminal	Signal	LED	Type	Description	Operation
17	INPUT1	IN 1	Input	Digital input 1	Input type 3. Maximum applicable resistance 1.2 kΩ.
18	INPUT2	IN 2		Digital input 2	
19	INPUT3	IN 3		Digital input 3	
20	INPUT4	IN 4		Digital input 4	
21	INPUT5	IN 5		Digital input 5	
22	INPUT6	IN 6		Digital input 6	
23	INPUT7	IN 7		Digital input 7	
24	INPUT8	IN 8		Digital input 8	

Wiring Example

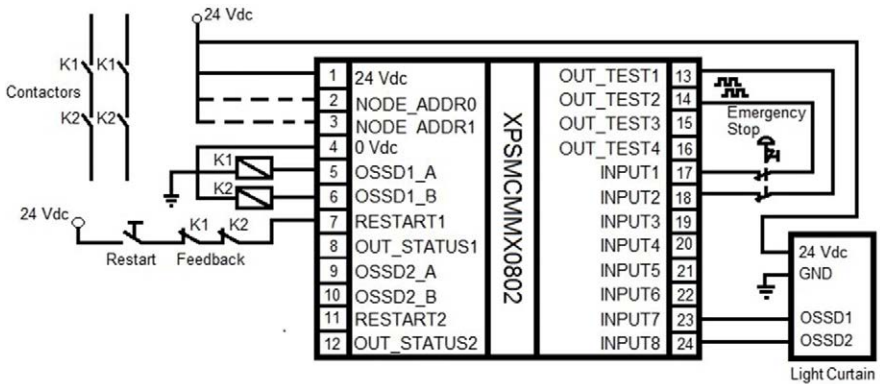

Dimensions

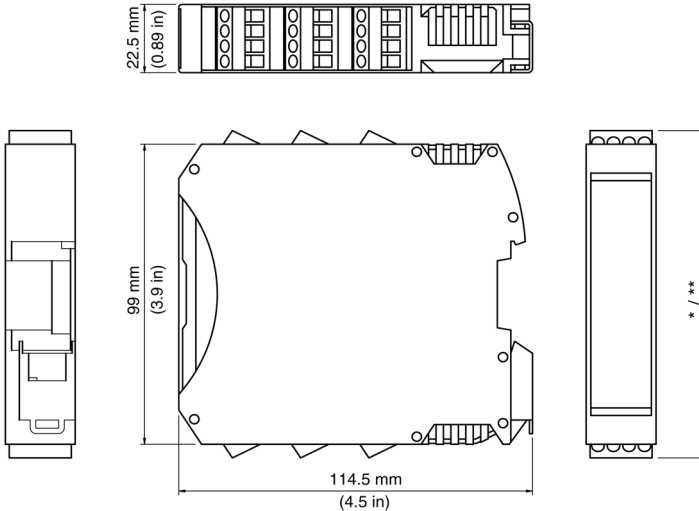









- * Screw terminals 108 mm (4.25 in)
- ** Spring terminals 118 mm (4.67 in)



Mount the modules (Modular Safety Controller and any I/O expansion modules) in an electric cabinet with an IP54 degree of protection. The minimum clearance below and above the controller is 40 mm. Allow at least 100 mm distance between the cabinet door and the front face of the module(s). There are no clearances required on the left or right side of the module(s); however, other equipment in proximity may require larger distances and those clearances must also be taken into account.

Technical Data





Cable types and wire sizes

for a 5.08 pitch removable **screw** terminal block

mm in.								
7	0.28							
mm ²	0.2...2.5	0.2...2.5	0.25...2.5	0.25...1.5	2 x 0.2...1	2 x 0.2...1.5	2 x 0.25...1	2 x 0.5...1.5
AWG	24...14	24...14	23...14	23...16	2 x 24...18	2 x 24...16	2 x 23...18	2 x 20...16

 Ø 3.5 mm (0.14 in.)		N·m	0.5
		lb·in	4.42

for a 5.08 pitch removable **spring** terminal block (used by XPSMCM***G).

mm in.					
10	0.39				
mm ²	0.2...2.5	0.2...2.5	0.25...2.5	0.25...2.5	2 x 0.5...1
AWG	24...14	24...14	23...14	23...14	2 x 20...18

Cable types and wire sizes

The following instructions concerning connection cables must be observed:

- Use 60/75 °C copper (Cu) conductor only. Maximum cable length 100 m (328 ft).
- Cables used for connections of longer than 50 m (164 ft) must have a cross-section of at least 1 mm² (AWG 16).

Housing characteristics

Housing material	Polyamide
Housing degree of protection	IP20
Terminal blocks degree of protection	IP2x
Mounting	35 mm DIN rail according to EN/IEC 60715
Mounting position	Any plane
Dimensions (h x l x d)	<ul style="list-style-type: none">● with screw terminals: 108 x 22.5 x 114.5 mm (4.25 x 0.89 x 4.5 in)● with spring terminals: 118.5 x 22.5 x 114.5 mm (4.67 x 0.89 x 4.5 in)

General characteristics

Rated voltage	24 Vdc ± 20 % (PELV supply)
Dissipated power	3 W maximum
Overvoltage category	II
Ambient operating temperature	-10...+55 °C (14...131 °F)
Storage temperature	-20...+85 °C (-4...185 °F)
Relative humidity	10...95%
Maximum operation altitude	2000 m (6562 ft)
Pollution degree	2
Vibration resistance (IEC/EN 61496-1)	+/- 3.5 mm (0.138 in) 5...8.4 Hz 1 g (8.4...150 Hz)
Shock resistance (IEC/EN 61496-1)	15 g (11 ms half-sine)
EMC Category	Zone B

General characteristics			
<p>Response time (ms) The response time depends on the following parameters:</p> <ul style="list-style-type: none"> ● Number of expansion modules installed ● Number of operators ● Number of OSSD outputs ● Status outputs <p>For the response time, refer to the one calculated by the SoSafe Configurable software (see project report). $T_{\text{Input_filter}}$ = filtering time set in the project for the inputs. For details, refer to the Input functions (see <i>Modular Safety Controller, User Guide</i>).</p>	Controller	10.6...12.6	+ $T_{\text{Input_filter}}$
	Controller + 1 expansion module	11.8...26.5	+ $T_{\text{Input_filter}}$
	Controller + 2 expansion modules	12.8...28.7	+ $T_{\text{Input_filter}}$
	Controller + 3 expansion modules	13.9...30.8	+ $T_{\text{Input_filter}}$
	Controller + 4 expansion modules	15...33	+ $T_{\text{Input_filter}}$
	Controller + 5 expansion modules	16...35	+ $T_{\text{Input_filter}}$
	Controller + 6 expansion modules	17...37.3	+ $T_{\text{Input_filter}}$
	Controller + 7 expansion modules	18.2...39.5	+ $T_{\text{Input_filter}}$
	Controller + 8 expansion modules	19.3...41.7	+ $T_{\text{Input_filter}}$
	Controller + 9 expansion modules	20.4...43.8	+ $T_{\text{Input_filter}}$
	Controller + 10 expansion modules	21.5...46	+ $T_{\text{Input_filter}}$
	Controller + 11 expansion modules	22.5...48.1	+ $T_{\text{Input_filter}}$
	Controller + 12 expansion modules	23.6...50.3	+ $T_{\text{Input_filter}}$
	Controller + 13 expansion modules	24.7...52.5	+ $T_{\text{Input_filter}}$
Controller + 14 expansion modules	25.8...54.6	+ $T_{\text{Input_filter}}$	

Module-specific characteristics	
Reference description	Electronic housing maximum 24-pole, with locking latch mounting
Unit enable (No./description)	2 / Type 3. Maximum applicable resistance 1.2 k Ω .
Digital inputs (No./description)	8 / Type 3. Maximum applicable resistance 1.2 k Ω .
Input Restart (No./description)	2 / EDM (External Device Monitoring) type 3. Maximum applicable resistance 1.2 k Ω . / Possible automatic or manual operation with restart pushbutton
Test output (No./description)	4 / to test for short circuits - overloads, maximum current 100 mA / 24 Vdc
Solid-state safety-related output (OSSD) (No./description)	<p>2 pairs / solid-state safety-related outputs PNP active high</p> <ul style="list-style-type: none"> ● The outputs are able to supply: <ul style="list-style-type: none"> ○ In the ON condition: $U_v - 0.75 \text{ V}$ to U_v (where U_v is $24 \text{ V} \pm 20 \%$) ○ In the OFF condition: 0 to 2 V rms (root mean square) ● The maximum load of 400 mA@24 V (each OSSD pair) corresponds to a minimum resistive load of 60 Ω. <ul style="list-style-type: none"> ○ The maximum capacitive load is 0.82 μF. ○ The maximum inductive load is 30 mH. ● To detect short circuit and line break on the outputs, a line monitoring is made by using an output pulse on each channel. The output pulse is generated every 5.5 ms with a pulse of 100 microseconds.
Status outputs	Maximum output current per channel: 100 mA / 24 Vdc

Module-specific characteristics	
Probability of a dangerous failure per hour (PFHd)	5.72E-9
Mean Time to Dangerous Failure (MTTFd) in years	459
Connection to expansion modules	5-way backplane expansion
Weight	0.12 kg (4.2 Oz)

Checklist After Installation

The following must be verified:

Step	Action
1	Conduct a full functional test of the system (see <i>Validation</i> in the <i>Modular Safety Controller User Guide</i> .)
2	Verify that all the cables are correctly inserted and the terminal blocks are within correct torque for screw terminals.
3	Verify that all the LED indicators are correctly illuminating for the inputs and outputs used.
4	Verify the positioning and function of all input and output sensors and actuators used with the XPSMCM*.
5	Verify the correct mounting of XPSMCM* to the DIN rail.
6	Verify that all the external indicators (lamps/beacons/sirens) are correctly functioning.

EC Declaration of Conformity



EC DECLARATION OF CONFORMITY

Copy of Document-no.: EAV9139101.00
Original Language

WE: **Schneider Electric Automation GmbH** / Schneiderplatz 1 / Marktheidenfeld 97828, Germany
hereby declare that the safety component

TRADEMARK: **SCHNEIDER ELECTRIC**

PRODUCT, TYPE: Modular Safety Controller

MODELS: XPSMCMCO0000S1*, XPSMCMCO0000S2*, XPSMCMCP0802*, XPSMCMDOI0800*,
XPSMCMDOI1200MT*, XPSMCMDOI1600*, XPSMCMDO0002*, XPSMCMDO0004*,
XPSMCMEN0100HT*, XPSMCMEN0100SC*, XPSMCMEN0100TT*, XPSMCMEN0200HT*,
XPSMCMEN0200SC*, XPSMCMEN0200TT*, XPSMCMER0002*, XPSMCMER0004*,
XPSMCMX0802*, XPSMCMRO0004DA*, XPSMCMRO0004*, XPSMCMEN0200*,
XPSMCMME0000

SERIAL NUMBER: YYXXZZZZ (YY: 10...99, XX: 01...53, ZZZZ: 0001...9999)

DATE OF MANUFACTURING: refer to device nameplate

all the essential protection requirements that are described in the following directives are defined, corresponding. Furthermore, the conformity with the following harmonized European standards explained:

DIRECTIVE:	HARMONIZED STANDARD:
DIRECTIVE 2006/42/EC OF THE EUROPEAN PARLIAMENT AND OF THE COUNCIL of 17 May 2006 on machinery, and amending Directive 95/16/EC (recast)	EN 62061:2005 EN ISO 13849-1:2008 EN 61496-1:2013
DIRECTIVE 2004/108/EC OF THE EUROPEAN PARLIAMENT AND OF THE COUNCIL (EMC) of 15 December 2004 on the approximation of the laws of the Member States relating to electromagnetic compatibility and repealing Directive 89/336/EEC	EN 61131-2:2007
DIRECTIVE 2011/65/EC OF THE EUROPEAN PARLIAMENT AND OF THE COUNCIL (RoHS) of 8 June 2011 on the restriction of the use of certain hazardous substances in electrical and electronic equipment	EN 50581:2012

It is important that the safety component is subject to correct installation, maintenance and use conforming to its intended purpose, to the applicable regulations and standards, to the supplier's instructions and to accepted rules of the art.

Name and address of the person authorised to compile the technical file:
Michael Schweizer / Schneider Electric Automation GmbH / Schneiderplatz 1 / Marktheidenfeld 97828, Germany
First year of affixing CE marking: 2014

Marktheidenfeld, Germany
December 1st, 2014

i.A. Michael Schweizer
Machine Solutions Certification Manager

The original EC Declaration of Conformity is available on our website: www.schneider-electric.com