

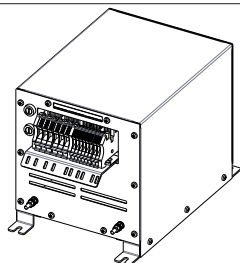

EAV3832102

Altivar**Passive Filters****VW3A46101 ... A46176****⚠ ⚠ DANGER****HAZARD OF ELECTRIC SHOCK, EXPLOSION, OR ARC FLASH**

- Only appropriately trained persons who are familiar with and fully understand the contents of the present manual and all other pertinent product documentation and who have received all necessary training to recognize and avoid hazards involved are authorized to work on and with this equipment.
- Installation, adjustment, repair, and maintenance must be performed by qualified personnel.
- Verify compliance with all local and national electrical code requirements as well as all other applicable regulations with respect to grounding of all equipment.
- Before performing work and/or applying voltage on the equipment, follow the instructions given in the appropriate installation manual.

Failure to follow these instructions will result in death or serious injury.**⚠ CAUTION****SHARP EDGES**

Use all necessary personal protective equipment (PPE) such as gloves when performing any type of work whatsoever on or with this product.

Failure to follow these instructions can result in injury or equipment damage.

Electrical equipment should be installed, operated, serviced, and maintained only by qualified personnel. No responsibility is assumed by Schneider Electric for any consequences arising out of the use of this product.

© 2024 Schneider Electric. All Rights Reserved.

**UK
CA**

MANUFACTURER
Schneider Electric Industries SAS
35 rue Joseph Monier
Rueil Malmaison 92500 France

UK REPRESENTATIVE
Schneider Electric Limited
Stafford Park 5
Telford, TF3 3BL United Kingdom

EAC

Опция для продуктов Altivar и Altistart.
Пожалуйста, обратитесь к сообщению о преобразователе частоты EAC / программном сартере в приложении к началу работы, размещенном на веб-сайте производителя. Авторизованный поставщик в Республике Казахстан:
ТОО «Шнейдер Электрик»
Адрес: 050010, РК, г. Алматы, пр. Достык, 38, бизнес-центр «Кен Дала», 5 этаж, левое крыло.
Тел.: +7 (727) 339 23 57
Номер службы поддержки клиентов:
Тел.: +7 (727) 339 24 52

Altivar және Altistart өніміне арналған опция. Өндірушінің веб-сайтында орналастырылған «Жұмысқа кірісу» қосымшасындағы EAC жиілік инвертер / бірқалыпты іске қосу құрылғысы хабарламасына сілтеме жасауыңызды сұраймыз.
Қазақстан Республикасындағы уәкілетті жеткізуші:
ЖШС «Шнейдер Электрик»
Мекен-жайы: 050010, ҚР, Алматы қаласы, Достық даңғылы, 38, «Кең дала» бизнес орталығы, 5-қабат, сол қанат.
тел.: +7 (727) 339 23 57
Клиенттерге қызмет көрсету нөмірі:
тел.: +7 (727) 339 24 52

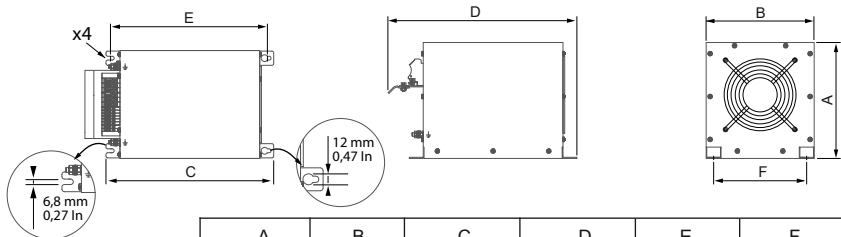

	A		B		C		D		E		F	
VW3A461●●	mm	in	mm	in	mm	in	mm	in	mm	in	mm	in
01 ... 03, 20 ... 22, 39 ... 41, 58 ... 60	205.5	8.09	190	7.48	295	11.61	332.11	13.07	276	10.87	163	6.42
04, 05, 23, 24, 42, 43, 61, 62	247.5	9.74	232	9.13	399.55	15.73	436.11	17.17	380	14.96	205	8.07

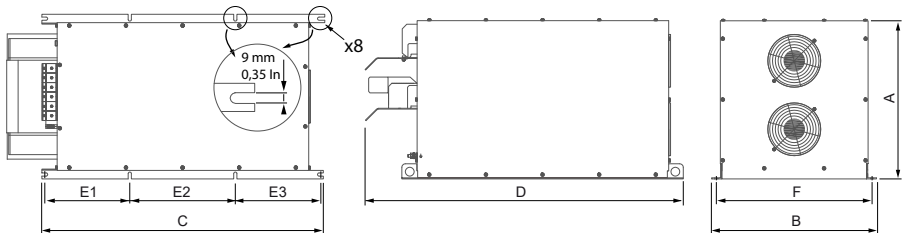

	A		B		C		D		E1		E2		E3		F	
VW3A461●●	mm	in	mm	in	mm	in	mm	in	mm	in	mm	in	mm	in	mm	in
06, 07, 25, 26, 44 ... 46, 63 ... 65	242	9.53	378	14.88	547	21.54	594.08	23.39	145	5.71	233	9.17	145	5.71	353	13.90
08, 09, 27, 28, 47, 48, 66, 67	333	13.11	378	14.88	577	22.72	623.6	24.55	156.5	6.16	240	9.45	156.5	6.16	353	13.90
10, 11, 29, 30, 49, 50, 68, 69	333	13.11	418	16.46	685	26.97	736.8	29	212	8.35	240	9.45	212	8.35	393	15.47
12, 13, 31, 32 51, 52, 70, 71	400	15.75	418	16.46	685	26.97	767.6	30.22	212	8.35	240	9.45	212	8.35	393	15.47
14 ... 18, 33, 34 53 ... 56, 72,	448.5	17.66	468	18.42	800	31.50	900.06	35.43	240	9.45	300	11.81	240	9.45	443	17.44
19, 35 ... 38, 57, 73 ... 76	510	20	468	18.42	800	31.50	900.06	35.43	240	9.45	300	11.81	240	9.45	443	17.44

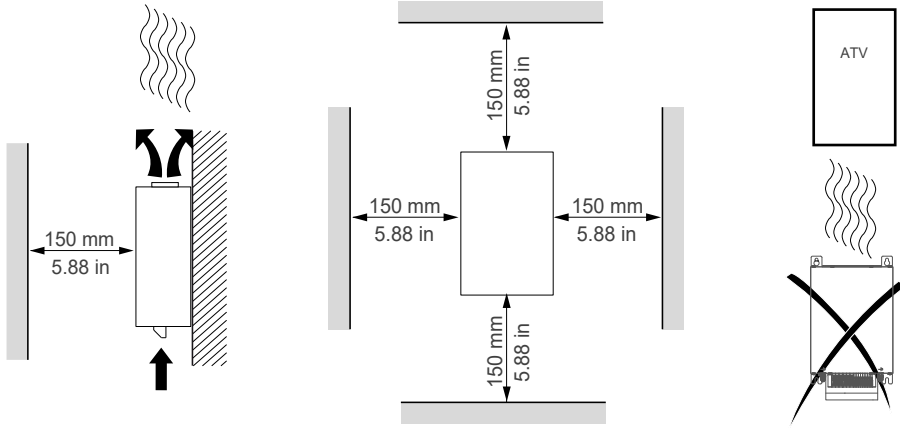

VW3A461●●	 $\frac{N.m}{lb.in}$								Wiring diagrams
	X1-1 ... X2-3	2 PE ⊕	A, B		X3-1 ... X4-3				
01...03, 20...22, 39...41, 58...60	0.5 ... 10 mm ² 26 ... 8 AWG	1.4 Nm 12.4 lb.in	M6x30	4 Nm 35.4 lb.in	2.5 mm ² 14 AWG	0.8 Nm 7.1 lb.in	0.5 ... 4 mm ² 20 ... 12 AWG	0.8 Nm 7.1 lb.in	1 or 2
04, 05, 23, 24, 42, 43, 61, 62	0.5 ... 10 mm ² 26 ... 8 AWG	1.4 Nm 12.4 lb.in	M6x30	4 Nm 35.4 lb.in	2.5 mm ² 14 AWG	0.8 Nm 7.1 lb.in	0.5 ... 4 mm ² 20 ... 12 AWG	0.8 Nm 7.1 lb.in	
06, 07, 25, 26, 44, 45, 63, 64	1.5 ... 25 mm ² 14 ... 6 AWG	3.5 Nm 31 lb.in	M8x40	9 Nm 79.6 lb.in	2.5 mm ² 14 AWG	0.8 Nm 7.1 lb.in	1.5 ... 16 mm ² 16 ... 6 AWG	2.4 Nm 21.2 lb.in	
46, 65	1.5 ... 25 mm ² 14 ... 6 AWG	3.5 Nm 31 lb.in	M8x40	9 Nm 79.6 lb.in	2.5 mm ² 14 AWG	0.8 Nm 7.1 lb.in	1.5 ... 6 mm ² 16 ... 6 AWG	2.4 Nm 21.2 lb.in	2
08, 09, 27, 28, 47, 48, 66, 67	2.5 ... 50 mm ² 12 ... 1 AWG	4.5 Nm 39.8 lb.in	M8x40	9 Nm 79.6 lb.in	2.5 mm ² 14 AWG	0.8 Nm 7.1 lb.in	1.5 ... 25 mm ² 16 ... 4 AWG	3.5 Nm 31 lb.in	
10, 11, 29, 30, 49, 50, 68, 69	10 ... 70 mm ² 8 ... 0 AWG	5.4 Nm 47.8 lb.in	M8x40	9 Nm 79.6 lb.in	2.5 mm ² 14 AWG	0.8 Nm 7.1 lb.in	1.5 ... 25 mm ² 16 ... 4 AWG	3.5 Nm 31 lb.in	
12, 13, 31, 32, 51, 52, 70, 71	2.5 ... 90 mm ² 14 ... 00 AWG	10 Nm 88.5 lb.in	M8x40	9 Nm 79.6 lb.in	2.5 mm ² 14 AWG	0.8 Nm 7.1 lb.in	1.5 ... 50 mm ² 16 ... 1 AWG	4 Nm 35.4 lb.in	
14...18, 33, 34, 53...56, 72,	25 ... 300 mm ² 6 ... 600 AWG	50 Nm 442.5 lb.in	M12x45	30 Nm 265.5 lb.in	2.5 mm ² 14 AWG	0.8 Nm 7.1 lb.in	16 ... 150 mm ² 6 ... 300 AWG	18 Nm 159.3 lb.in	
19, 35...38, 57, 73...76	25 ... 300 mm ² 6 ... 600 AWG	50 Nm 442.5 lb.in	M12x45	30 Nm 265.5 lb.in	2.5 mm ² 14 AWG	0.8 Nm 7.1 lb.in	16 ... 150 mm ² 6 ... 300 AWG	18 Nm 159.3 lb.in	

Wiring diagram 1 – With shunt
(which connect internal capacitors of the filter)

NOTICE

OVERVOLTAGE AT THE POWER ON

This wiring diagram with shunt must not be used for VW3A461●●:
08...19, 27...38, 46...57, 65...76

Failure to follow these instructions can result in equipment damage.

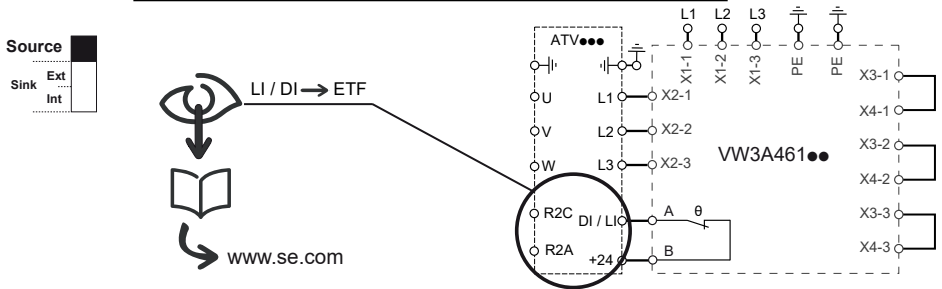

Wiring diagram 2 – With capacitor contactor
(which disconnect internal capacitors of the filter at standstill)

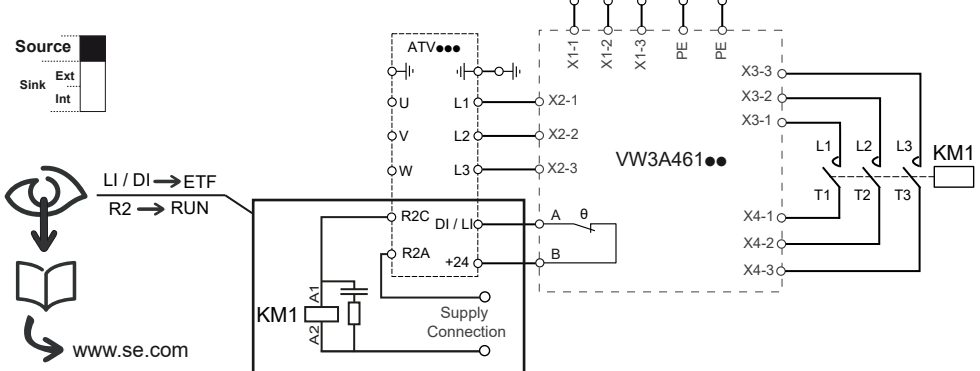

Capacitor Contactor

It is used to reduce the reactive current and prevent an overcompensation of the mains at standby operation.

NOTICE

CAPACITOR CONTACTOR DAMAGE

- It is advisable to use a special capacitor contactor to manage the C-disconnection.
- Without using a special capacitor contactor, you must adapt your wiring diagram to wait 25 secondes after having opened the contactor, to allow the complete discharge of the internal capacitors of the filter, before restarting.

Failure to follow these instructions can result in equipment damage.

Follow this table to select the contactor :

Nominal Current (A)		Contactor Nominal Power (kVAr)
at 380-415V (50-60Hz)	at 440-480V (60Hz)	
6	6	1
10	10	1
14	14	2
22	19	4
29	25	6
35	31	7
43	36	7
58	48	9
72	60	11
86	73	15
101	95	17
144	118	22
180	154	29
217	183	36
252	231	44
304	291	51
325	355	58
380	380	66
433	436	88

Set parameter [Input Filter] IFI to [Yes]

NOTICE

RIPPLE ON THE DC BUS

Before power-on, follow the steps below:

- 1) Refer to the product programming manual and enter the correct motor parameters.
- 2) Run [Autotuning] tun.
- 3) Find [Input Filter] DCR- menu, set parameter [Input Filter] IFI to [Yes].

Contact Schneider Electric Customer Care Hotline on www.se.com/CCC if you have other questions.

Failure to follow these instructions can result in equipment damage.