

InTools

USER MANUAL



CONTENTS

1. Compatible version	3
2. Introduction	3
3. Connection between charging station and PC	5
3.1. Connection to InTools	5
3.2. Set your PC for the right network	5
3.3. First connection : connect locally	7
3.3.1. Connect to the charging station	8
3.3.2. First configuration	10
3.3.3. End of the process	10
3.4. Connection through external ethernet network	11
3.4.1. Connection through ethernet	11
3.4.2. Connection through modem	11
4. InTools Installer High level navigation map	12
5. Menus	13
5.1. Dashboard	13
5.2. Actions Menu	15
6. How to perform charging station configuration	16
6.1. How to perform global setup	16
6.2. How to perform connectivity setup	20
7. How to perform actions	27
7.1. How to Reboot Hardware	27
7.2. How to perform Software Reboot	27
7.3. How to perform IfConfig Command	28
7.4. Ping Command	28
7.5. How to Generate Diagnostic	29
7.6. How to perform Screen Calibration	29
7.7. How to Update Firmware	30
7.8. How to Update Date Time	31
8. How to manager RFID badges	32
8.1. Add – Edit – Delete a RFID badge	33
8.2. Import an RFID list	34
8.3. Export an RFID list	35
9. How to manage backup	36
9.1. Backup recovery	37
9.2. Backup comparison	37
9.3. Export Backup	38
9.4. Export Settings	38
9.5. Delete backup	38
10. How to change password	39
11. About	40
12. Factory Default configuration	41

1. Compatible version

InTools is available with the following general software versions and above : 22PRO017362_V018.210 . If software version of the charging station is below this version, please contact Schneider Electric support to help to perform software update.

Software version can be found on the charging station screen.



2. Introduction

Charging stations are pre-configured, and can be used to charge electric vehicle, once installed (refer to installation guide). Default configuration is described in section 12.

To upset charging station parameter, you shall use InTools.

InTools is a Tool used to configure your charging station on site or in remote access via an internet gateway or modem.

InTools is a web interface, no application is required to install on PC to use it and to connect with the charging station.

	WARNING
Use only google Chrome to access to InTools.	

InTools can be used for advanced configuration of the charging station.

This software provides many tools to diagnostic issues or manage local charging station access

InTools permits to :

- Define charging station language,
- Define charging station time and time zone,
- Define network and internal modem settings,
- Define connection with supervision,
- Define authentication strategy,
- Define maximum input current,
- Add, remove, suspend RFID badges,
- Export – import RFID badges list,
- Perform software reboot the charging station,
- Perform hardware reboot the charging station,
- Export – import configuration,
- Perform charging station screen calibration,
- Perform software update of the charging station.

InTools users are divided in 3 groups/profiles:

- Provider (restricted to Schneider Electric)
- Installer
 - Login : INSTALLER
 - Default Password : iaminstaller
- Operator
 - Login : OPERATOR
 - Default Password : iamoperator

Depending on your profile, you may have access to less or more sections of InTools.

Cybersecurity : After the first connection, we recommend changing the password on your profile. See section 10.

To identify who have access to different sections, please follow the following legend:

Color code	Description
	Installer can access
	All profile can access

For example:

4.6 Settings 

In This example, only Installer have access to this section.

For fast path for the configuration of the charging station you can read section 3 – 6, 7, 8 and 9. If you want more comprehension on how the interface is organize please read section 4 and 5 in addition.

3. Connection between charging station and PC ● ●

3.1. Connection to InTools ● ●

In operating mode operator or installers can access to InTools thanks to External Ethernet connection.

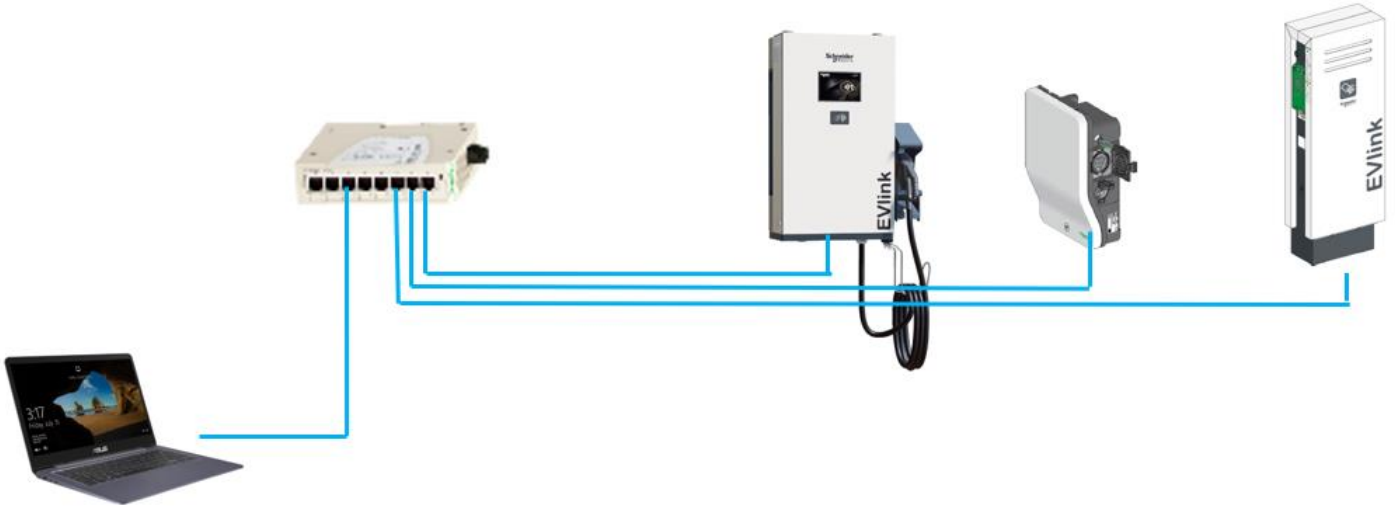

Figure 1: one example of network possible configuration

From factory configuration, the external Ethernet connection is configured DHCP client.

If the charging station is not connected to a LAN with DHCP, it's mandatory to perform first connection to InTools locally (section 3.3). Then, it's possible to connect either via ethernet (LAN and WAN) connection (section 3.4.1). Section 3.4.1 is also valid if the charging station is connected to an ethernet network with DHCP.

It's also possible to connect with internal or external modem (section 3.4.2).

Refer to the installation manual of the charging station for possible network architecture.

3.2. Set your PC for the right network ● ●

You need to configure your PC Ethernet connection to reach the charging station on the network.

for example :

If the static IP address of the charger is 192.168.2.50 subnet mask 255.255.255.0 ;

The network is 192.168.2.0

Then, the static IP address of the PC will be 192.168.2.xxx subnet mask 255.255.255.0

where XXX is a value different from 0; 50; 254 and 255.

- On your PC open “Control Panel”

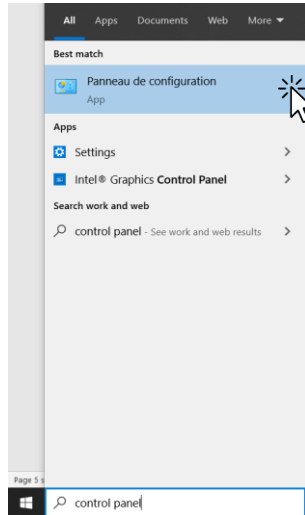

- Open “Network and Internet” section

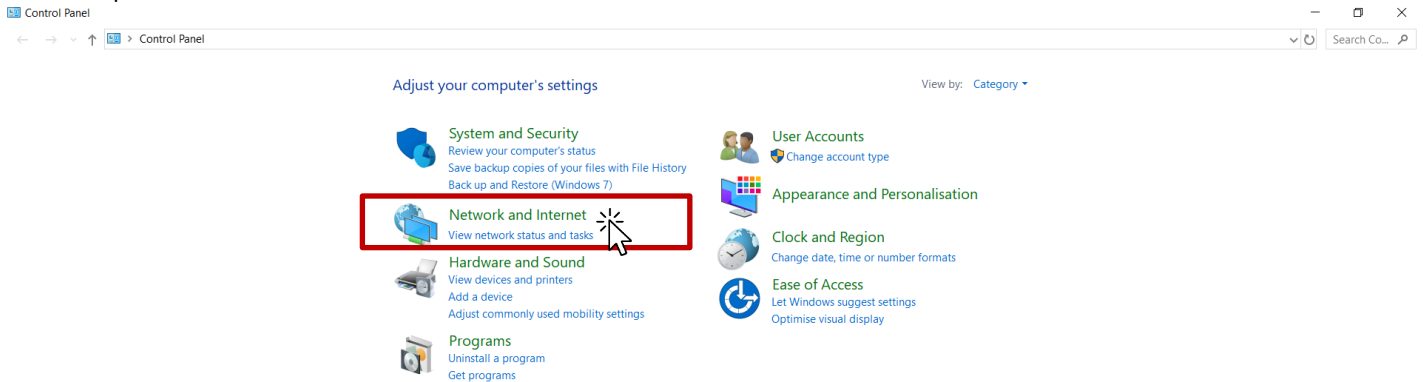

- Open “Network and Sharing Centre”

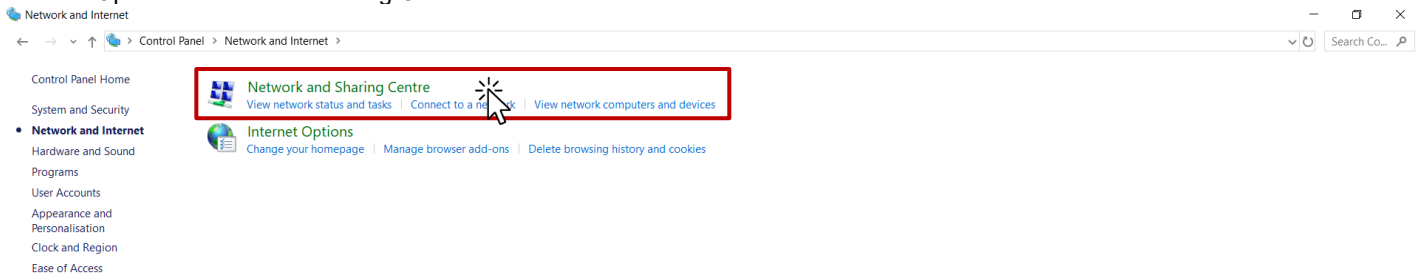

- Click on your Ethernet connection linked to the charging station (in this case, Ethernet 6)

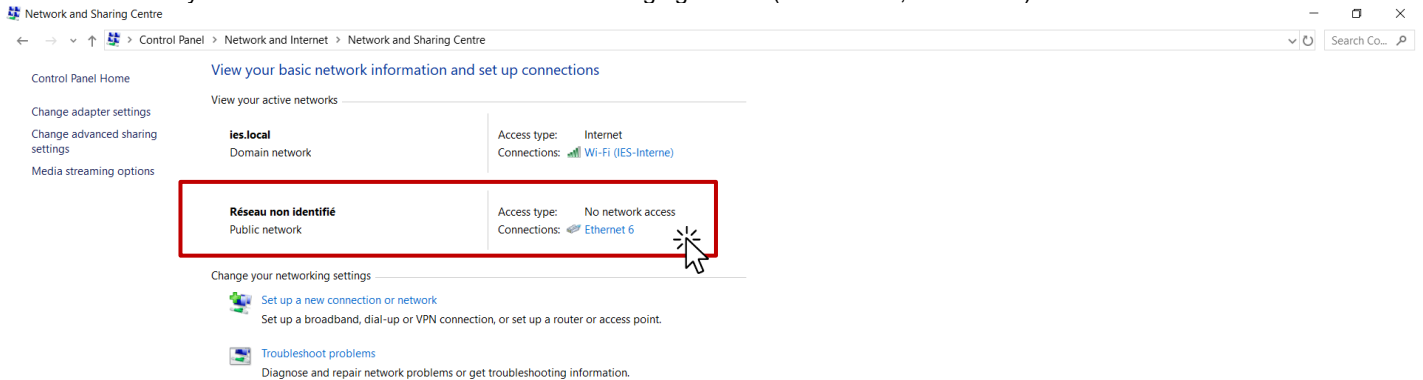

- Configure your connection

Set the IP address in the same network as the charging station and use corresponding subnet mask.

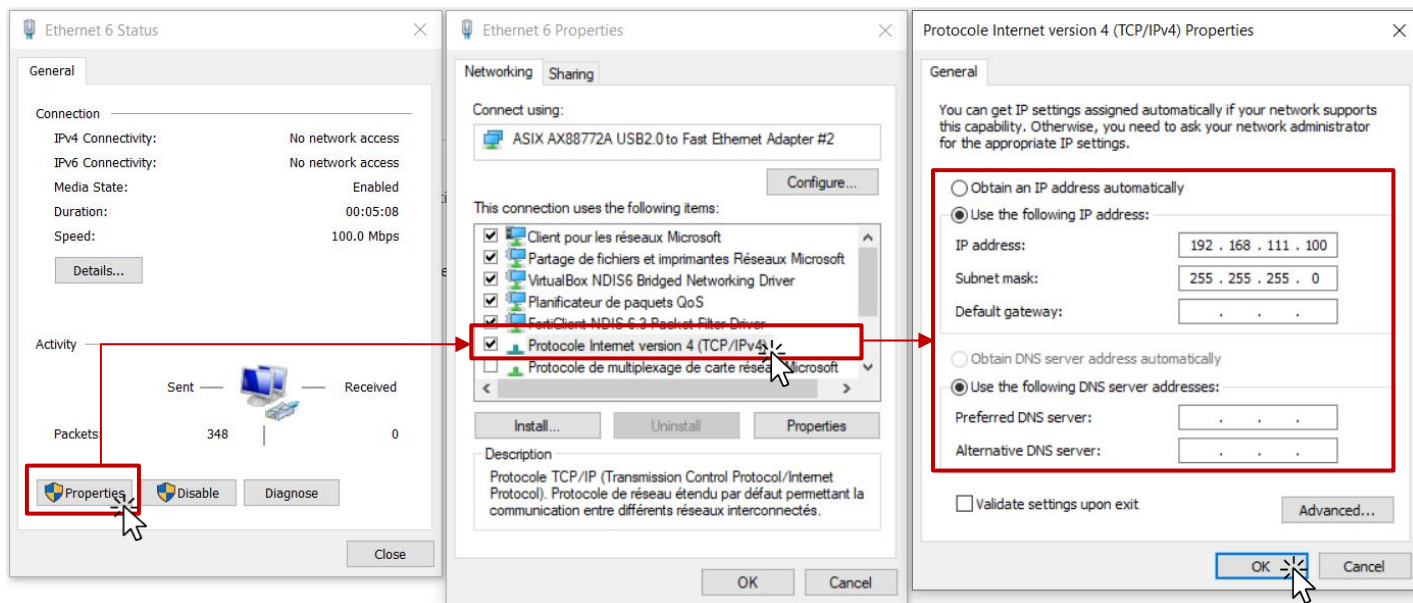

3.3. First connection : connect locally

This procedure describes how to connect to InTools through the internal network of the charging station. It should be used only once on first local connection, to configure the charging station and set a static IP address on the External Ethernet port.

You'll have to disconnect Ethernet cables when the charging station is powered.

⚠ DANGER

Electrical equipment should be installed, operated, serviced, and maintained only by qualified personnel. No responsibility is assumed by Schneider Electric for any consequences arising out of the use of this equipment.

A qualified person is one who has skills and knowledge related to the construction, installation and operation of electrical equipment and who has received safety training to recognize and avoid the hazards involved.

To perform initial connection, 3x Ethernet cables 1,5 m and 2x RJ45 extenders are needed. (see picture below or equivalent).

These devices will be used to output the Internal Ethernet network from the charging station to improve physical accessibility.

All Ethernet cables will be installed or removed when the charging station is out of power.



3.3.1. Connect to the charging station ●

To connect to InTools on first local connection you must respect the following rules:

- Configure you PC to place it on the same network as the charging station (see section 3.2)

	<h2>WARNING</h2>
<p>Before our ocpp version 22PRO17369_V019, the default address to reach the charger was 192.168.0.50:8088.</p> <p>Since this version 22PRO17369_V019, the default address to reach the charger is 192.168.111.50:8088.</p> <p>This is the address that will need to be used in the web browser of the PC. You need to configure an IP address in the same network.</p>	

- Power off the charging station
- Open the front door to access at the OCPP electronic board. (see installation guide)
- Unplug the ethernet cable on OCPP card like this

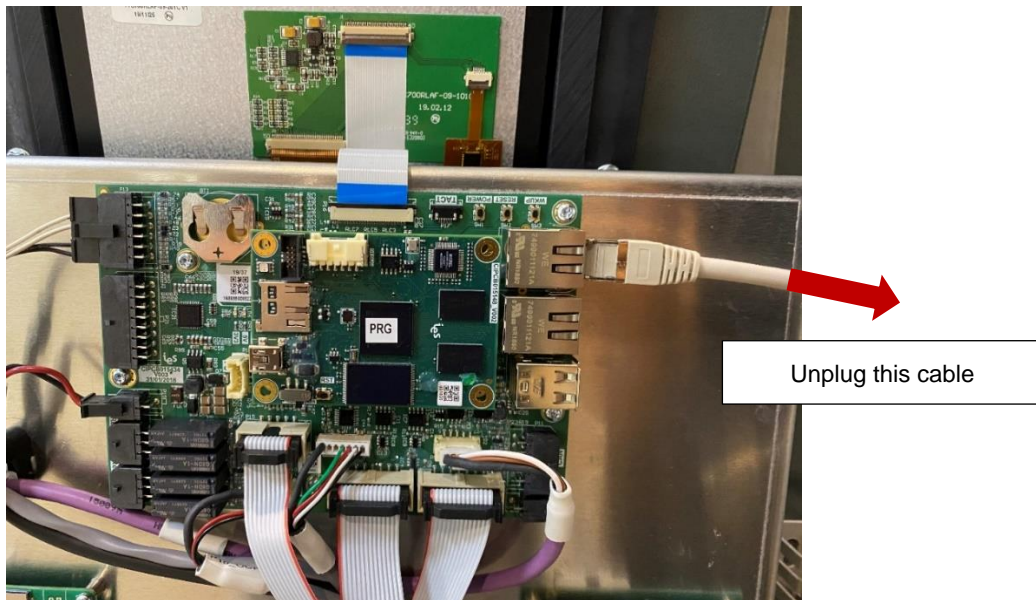

- Plug Ethernet cables as on the picture below. X1 device should be placed outside the charging station.

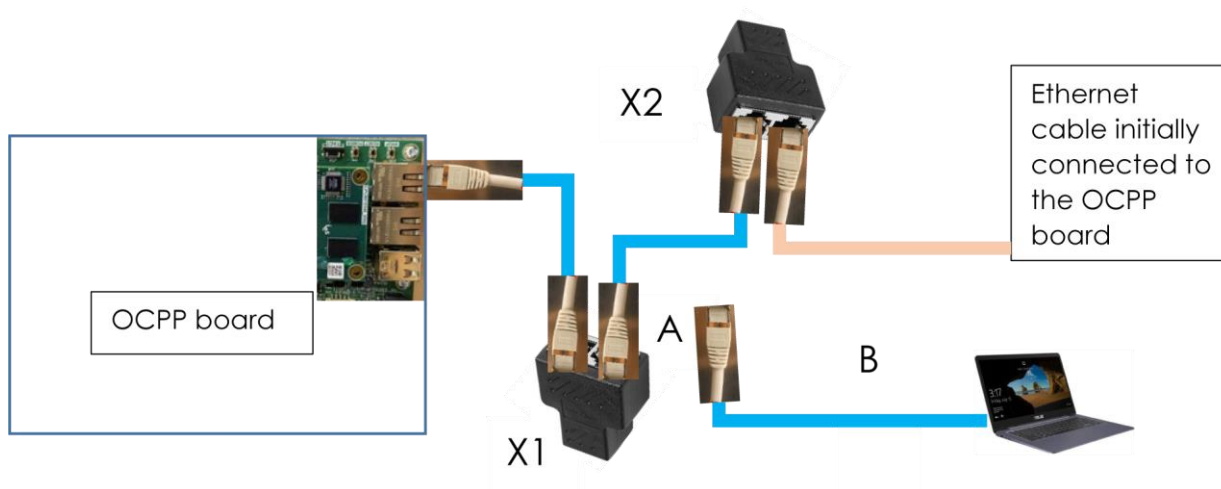

Power on the charging station

- Wait to show connectors on charging station’s screen
- Unplug on X1 the ethernet cable A not going to the OCPP card from RJ45 extender

	WARNING
You must wait the end of booting to unplug the ethernet cable because it may cause a network problem.	

- Connect an ethernet cable B between your pc and the RJ45 extender X1.

3.3.2. First configuration ●

When this configuration is done you can access to InTools in your web browser entering the IP address. Before our ocpp version 22PRO17369_V019, the default address to reach the charger was <http://192.168.0.50:8088/>. Since this version 22PRO17369_V019, the default address to reach the charger is <http://192.168.111.50:8088/>. You can see this page if all is done:

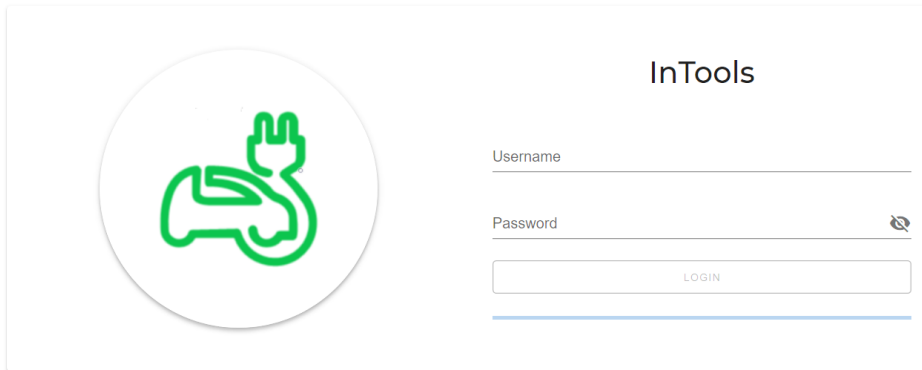
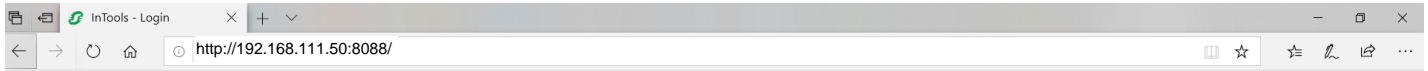

Connect with the profile INSTALLER. Then, please now perform initial configuration (see section 6), especially the connectivity setup (section 6.2) which define network configuration for External Ethernet port and modem of the charging station.

3.3.3. End of the process ●

Once the configuration has been performed locally, after the complete reboot of the charging station :

- Power off the charging station,
- plug back the ethernet cable on OCPP card like in the picture below,
- Power on the charging station.

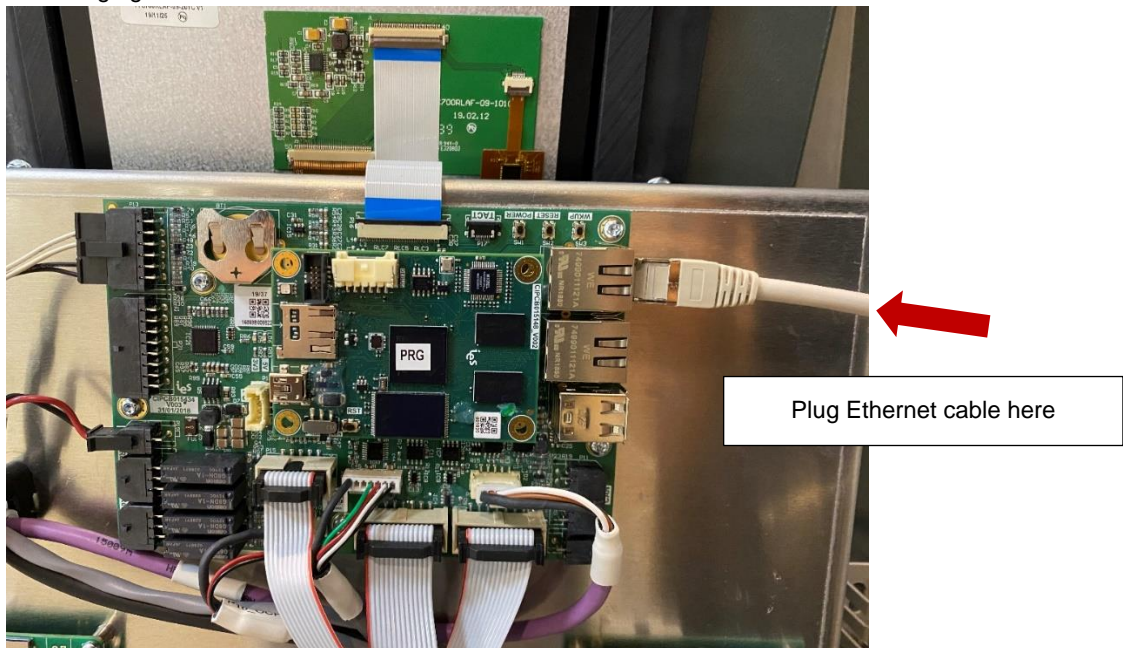

Now you can reach InTools webpage by connecting your PC on the External Ethernet port (LAN). If it works, we recommend going on actions menu and to export the backup configuration through network on your PC. You need to configure your PC to be on the same network of the charging station refer to section 3.2.

3.4. Connection through external ethernet network ● ●

If you need to configure your PC to be on the same network of the charging station refer to section 3.2.

3.4.1. Connection through ethernet ● ●

Refer to the installation manual for the connection of the charging station to the ethernet.

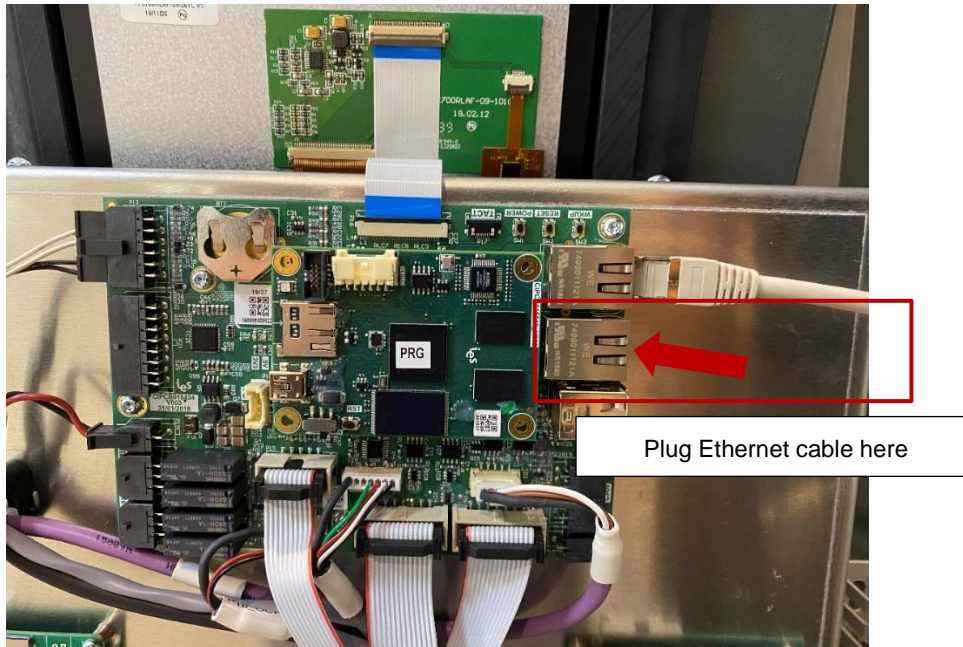

If the charging station is connected to a LAN with DHCP server InTools webpages can be Reach at the IP address given by the DHCP server port 8088.

If the charging station is not connected to a Lan with DHCP server the installer configures Ethernet port and set a Static IP address to reach the InTools webpages (see section 6.2). Then the charging station and InTools can be reached at this IP address on port 8088. Refer to section 3.3 for complete procedure on own to configure Static IP address of the charging station.

Example: <http://10.0.10.15:8088>

3.4.2. Connection through modem ● ●

InTools application is also available by using internal modem connection. After initial configuration of the internal modem of the charging station within InTools (see section 6.2), you must use your sim card IP follow by the default port 8088 in your web browser.

If you are using external modem, ethernet configuration within InTools of the charging station will need to be performed as well as the configuration of the external modem.

Example: <http://10.0.10.15:8088>

WARNING
<p>Your modem needs a good signal to allow you to connect on InTools in remote mode. So, check your signal before to try it. You can check the strength of the signal in the top right part of InTools interface see section 5</p>

4. InTools Installer High level navigation map

Dashboard

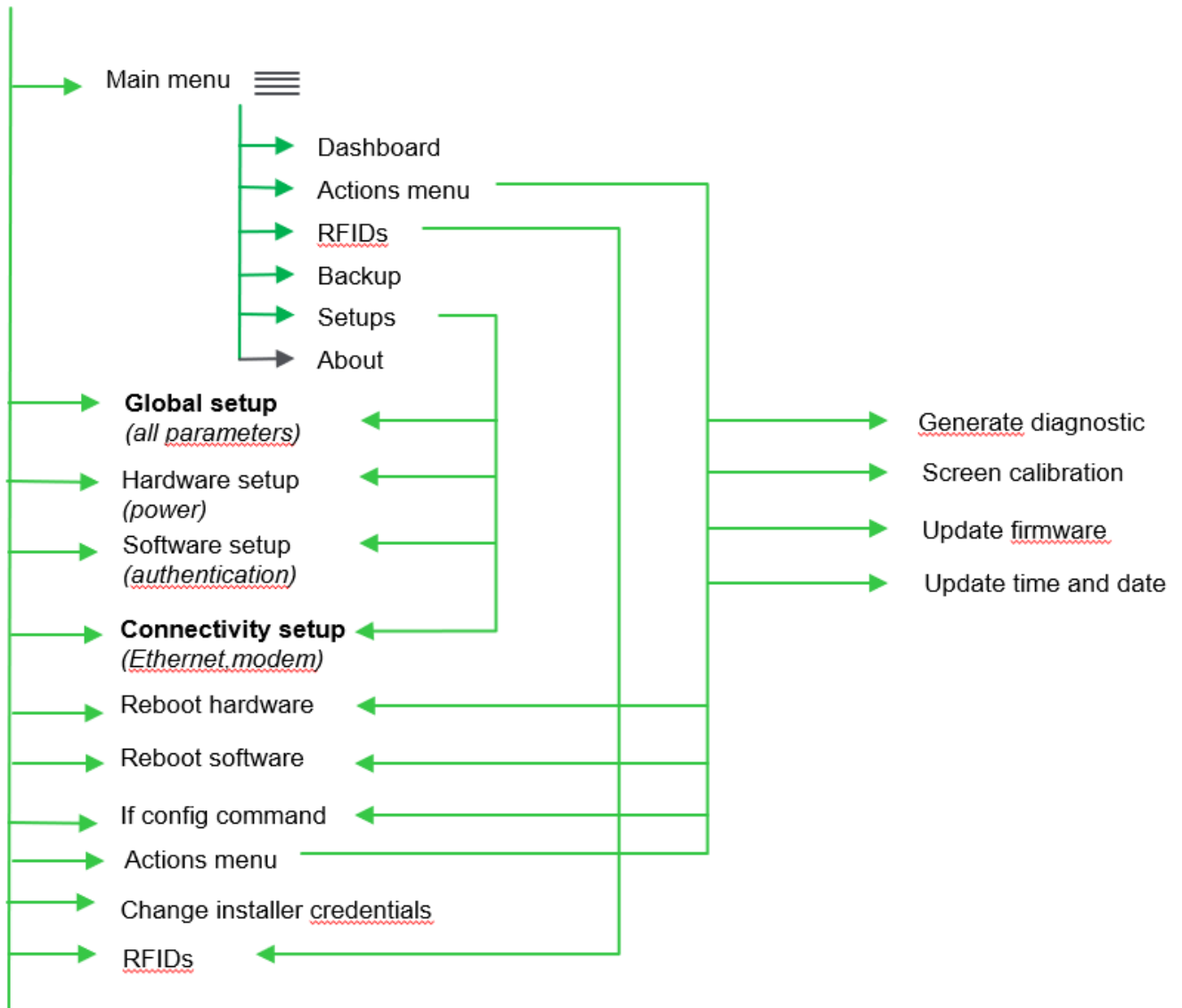

5. Menus

5.1. Dashboard

Menu is filtered with user profile on login. All the following menu can be unavailable according to user profile. The example below is Installer profile menu.

The Dashboard displays several sections like the Settings, RFIDs, Charging station Data, the Events...

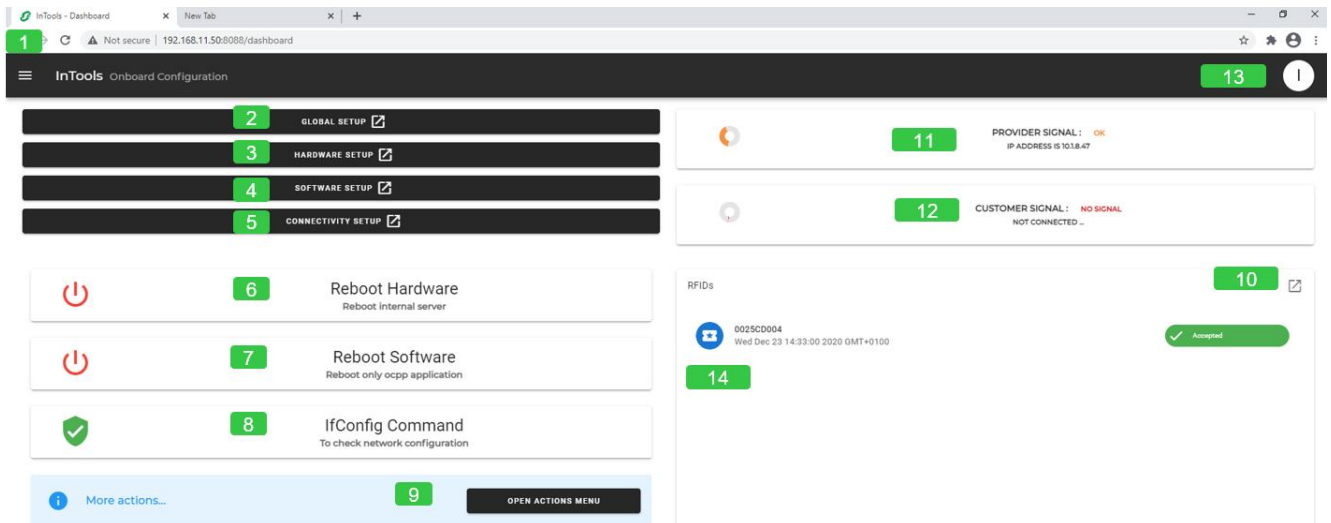

1 Go to the main menu.

2 Go to full global configuration of the charging station, except connectivity. (See section 5. How to perform charging station configuration)

3 Go to power configuration (this configuration is a subset of the Global Setup).

4 Go to authentication strategy configuration (this configuration is a subset of the Global Setup).

5 Go to connectivity configuration. (See section 5.2 How to perform connectivity setup)

6 Perform hardware reboot of the charging station. This reboot restart completely the charging station. (See section 6.1)

7 Perform software reboot, this reboot restart only the OCCP part of the charging station. (See Section 6.2)

8 Display Network configuration of the charging station (see section 6.3).

9 Go to action menu. The "Actions" tab is used to launch several actions on the charging station like Reboot, Update, Screen Calibration... (see section 4.2).

10 Go to badges management section. The "RFIDs" tab is used to define the list of the RFID cards allowed to launch a charge. (see section 7)

11 Indicate the signal level of reception of the provider modem. This is working when a SIM card is present. This modem permits connection to Provider back-end for remote support.

12 Indicate the signal level of reception of the customer modem. This is working when a SIM card is present. This internal modem permits connection to supervision application of the charging station, for example third-party Charge Point Operator.

13 Go to menu permitting to change password. (see section 9)

14 List of recorded badges and status.

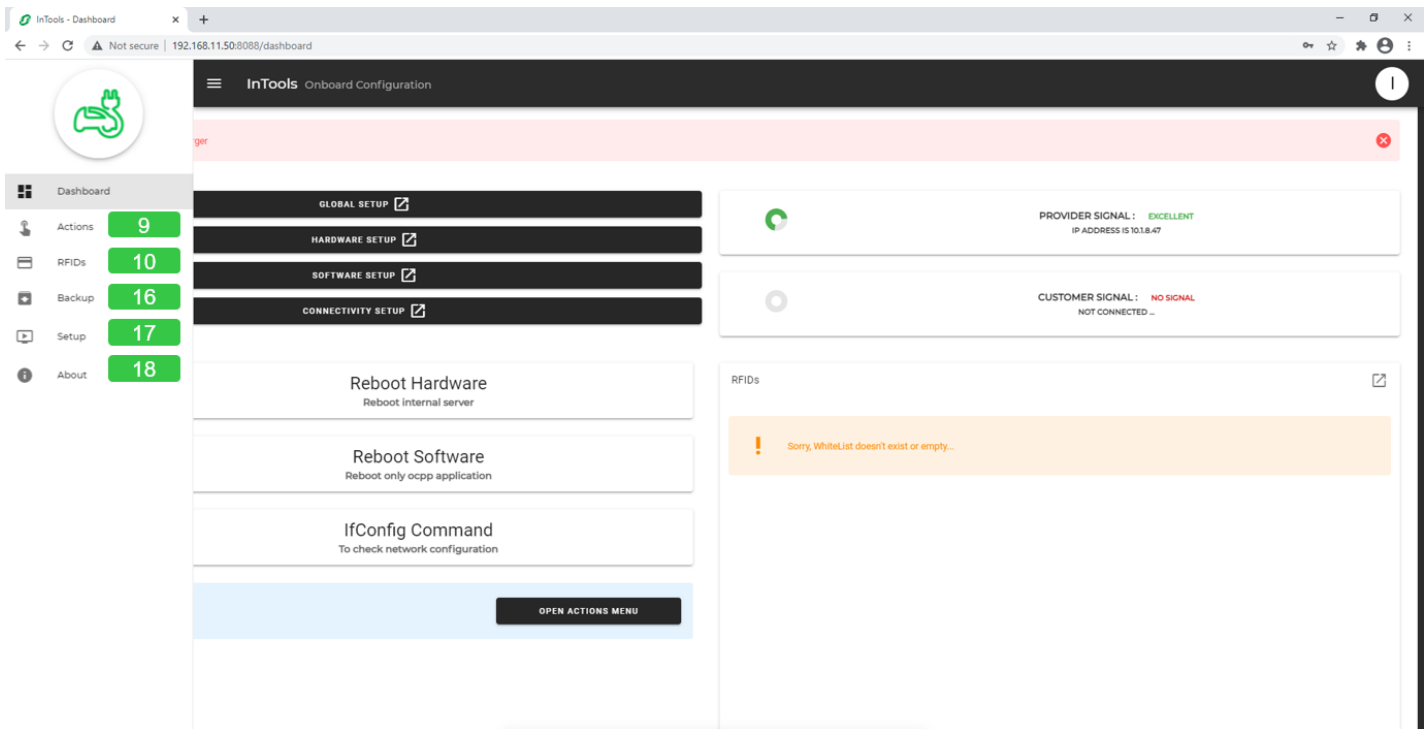

9

Permits to go to the action menu (See section 4.2). The “Actions” tab is used to launch several actions on the charging station like Reboot, Update, Screen Calibration... (See Section 6)

10

The “RFIDs” tab permits to go to badges management section and is used to define the list of the RFID cards allowed to launch a charge. (See Section 7)

16

Go to backup menu allowing to save, restore, export, import charging station configuration. (See Section 8)

17

Open a submenu listing the 4 setup menus found also in the main menu (Global Setup, Hardware Setup, Software Setup, Connectivity Setup). (See section 5. How to perform charging station configuration).

18

Go to menu providing information about the software version of InTools and how to contact support. (see section 10)

5.2. Actions Menu

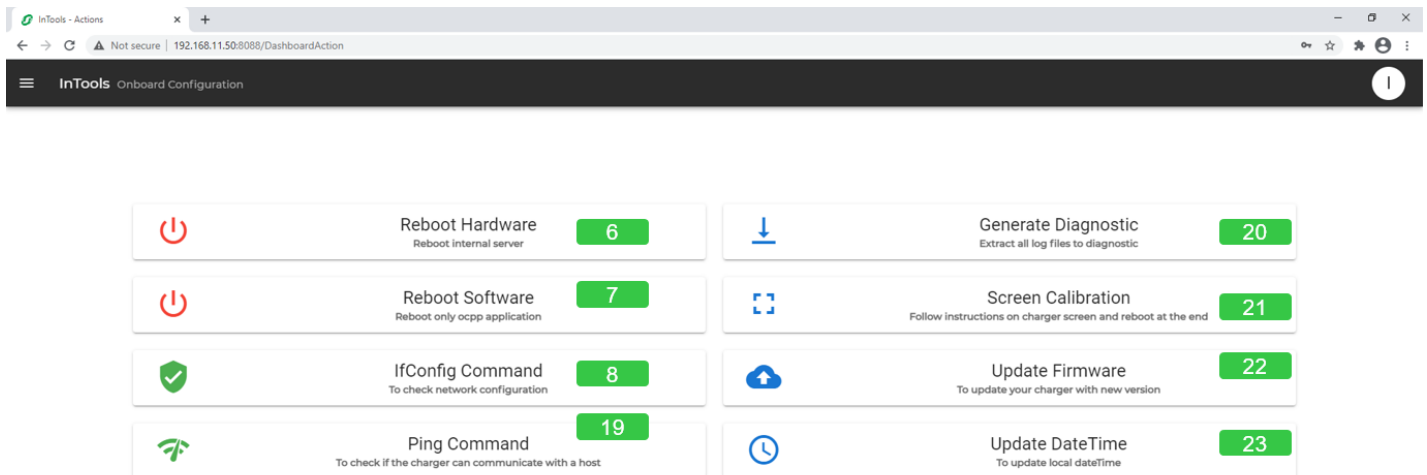

Go to section 6 to get more details on each action available in this menu.

6

Perform hardware reboot of the charging station. This reboot restart completely the charging station. (See section 6.1)

7

Perform software reboot, this reboot restart only the OCCP part of the charging station. (see section 6.2)

8

Display Network configuration of the charging station (See section 6.3).

19

Activate a “Ping” command line. Ping command permit to check communication with remote equipment (See section 6.4).

20

Generate a diagnostic file. This is to use in case of problem with the charging station. The diagnostic file can be provided to Schneider Electric to help to investigate the issue and solve it. (See section 6.5)

21

Start Charging station screen calibration. (See section 6.6)

22

Permit to perform firmware update of the charging station (See section 6.7)

23

Permit set date and time of the charging station (See section 6.8)

6. How to perform charging station configuration ●

To perform full configuration of the charging station it's necessary to perform at least one global setup and one connectivity setup.

Hardware and software setup are just subsidiaries of the global setup. Performing both hardware and software setup is equivalent as performing global setup. These two sub-menus can be useful to update rapidly existing configuration without redo all configuration.

Note: On Setup opening, a new backup is created automatically. To recover data after update, go to “Backup” Menu to restore the “Setup Backup”. We recommend exporting initial configuration, before modifying it, in order to be able to perform a restore to factory if needed. Go to “Backup” Menu to export the configuration. (see Section 9)

6.1. How to perform global setup ●

From the main menu select Global Setup.

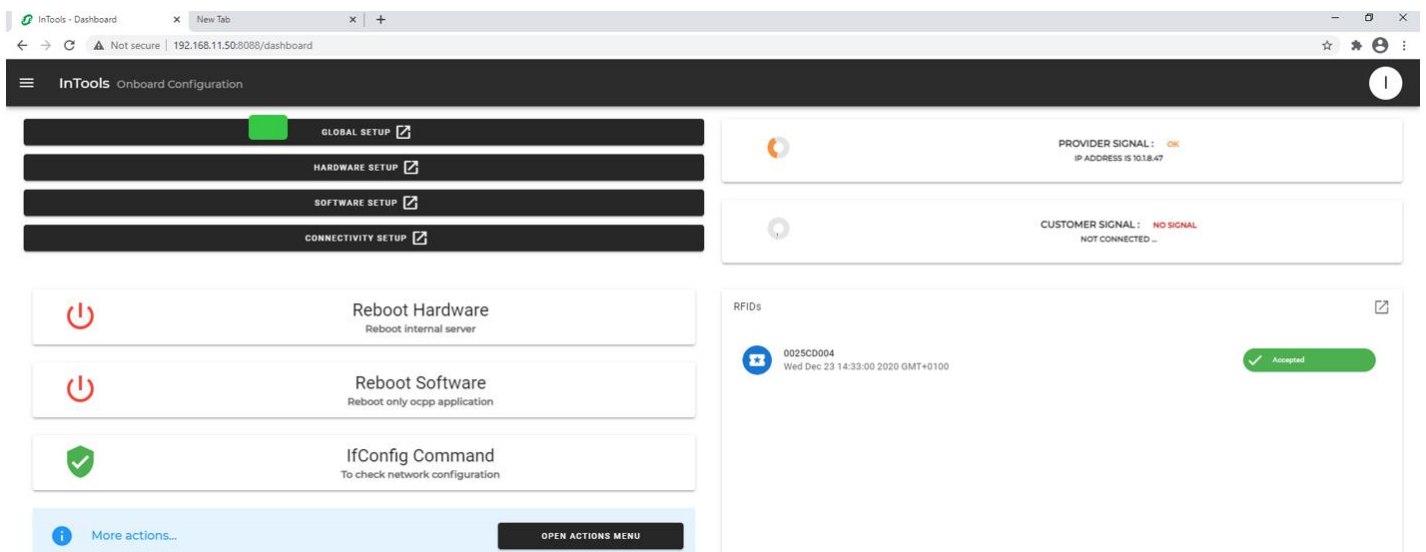

Global setup stating page

1

Click on the start process.

2

The configuration will progress following the several steps of the wizard. In each step specific parameters will be setup.

Note : “I” in the top right of the page provides helps if needed.

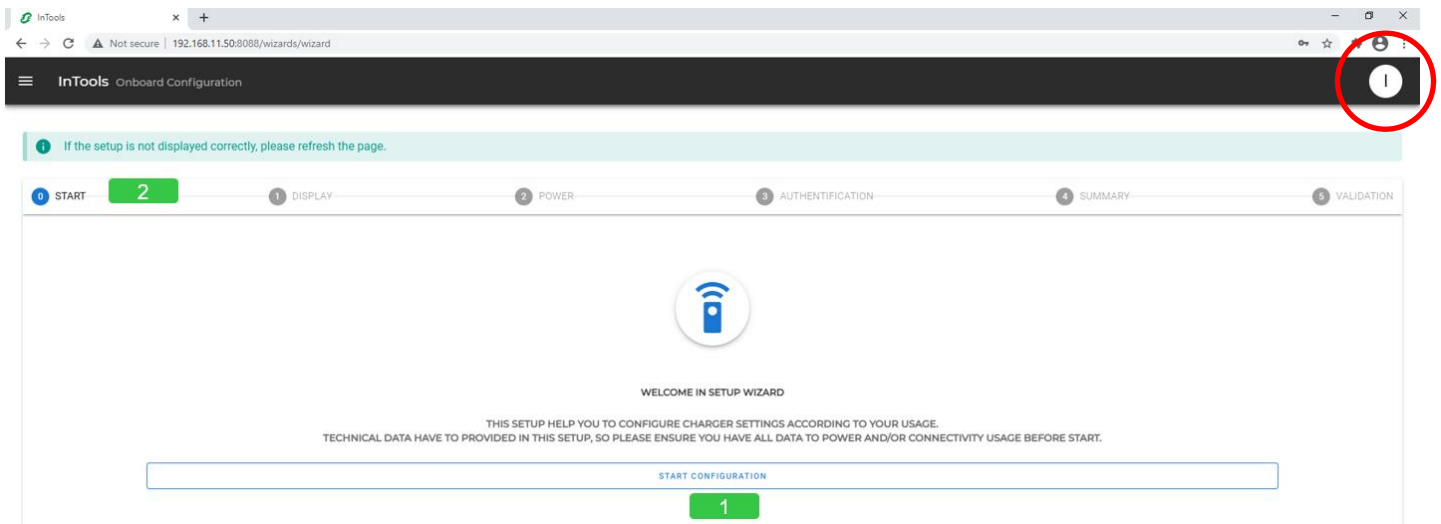

Charging station Display

3

Select from the drop list, the default language to display on the charging station.

4

Select from the drop list, the time in which the charging station is installed.

5

Define the format of the date to use.

6

Arrows “>” and “<” permit to navigate from one step to another of the configuration wizard.

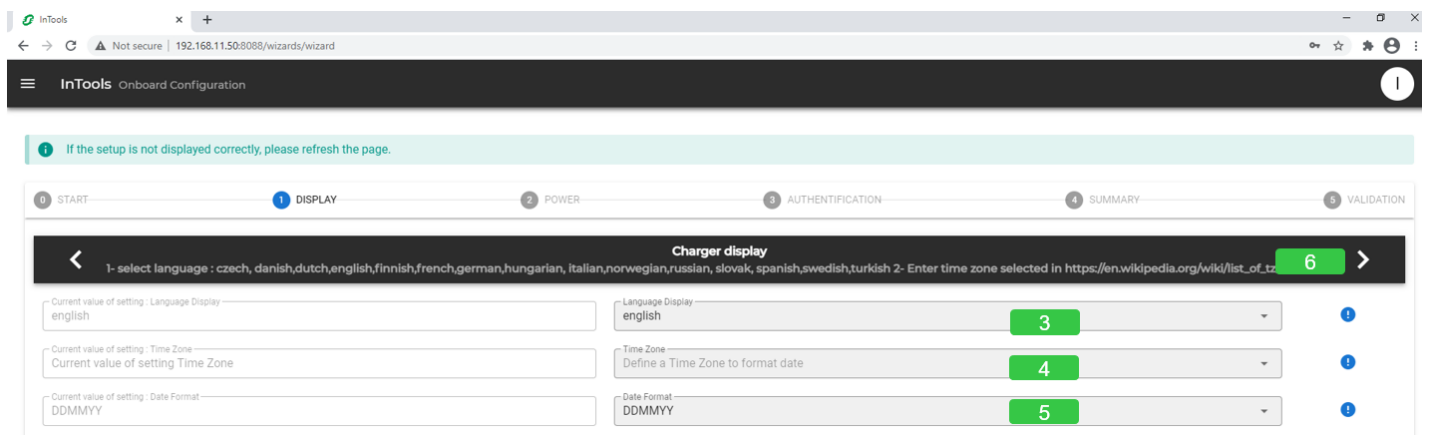

Power

7 Define the maximum input current the charging station can consume. This will limit the maximum power consumed and delivered by the charging station. This parameter is useful to avoid tripping installation with limited available power.

For maximum possible input current refer to installation manual.
By default, It's the nominal current according factory charger power.

8 Arrows ">" and "<" permit to navigate from one step to another of the configuration wizard.

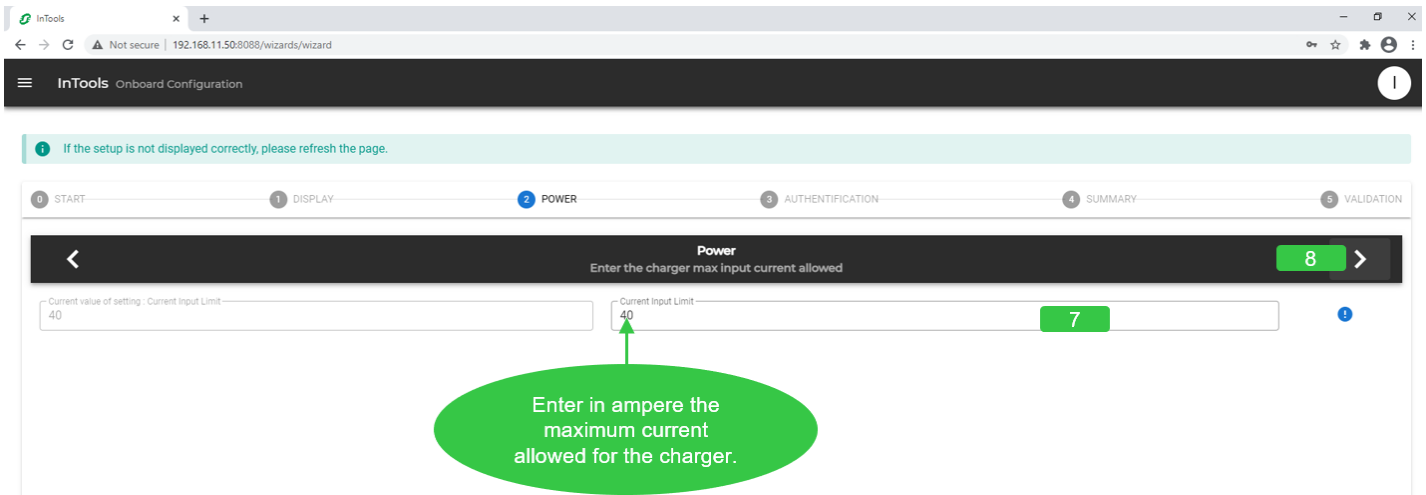

Authentication

9 Define the authentication strategy. Refer to the chart below to select which parameters to use.

10 Arrows ">" and "<" permit to navigate from one step to another of the configuration wizard.

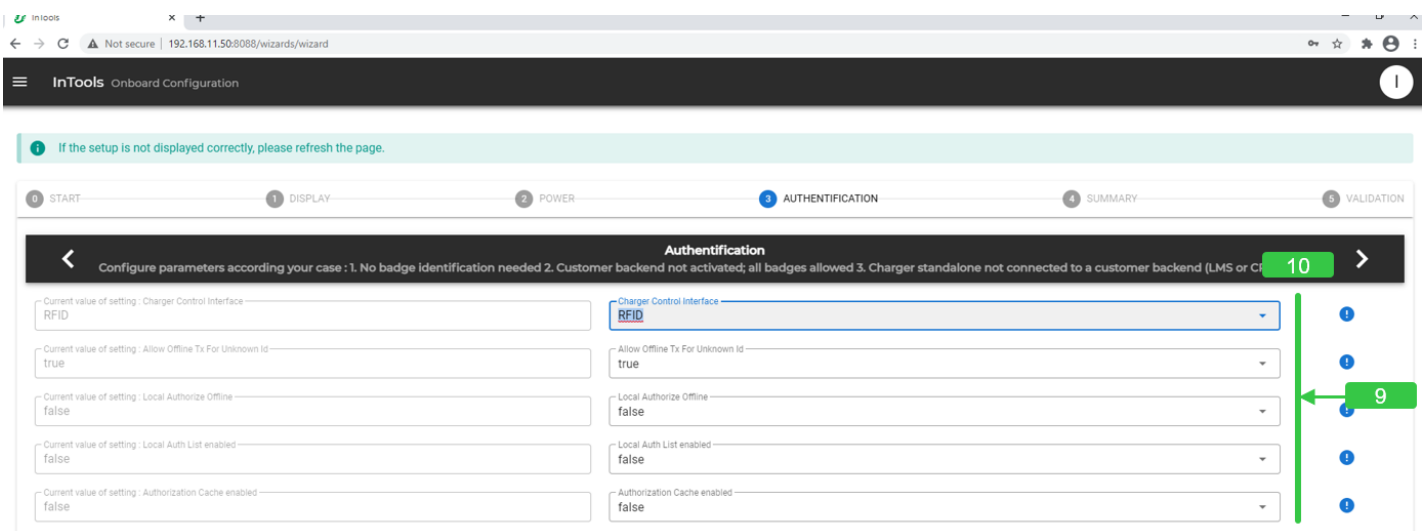

Chart to define the authentication strategy

InTools parameters for authentication strategy in Global setup or Software setup	No badge indentification needed	All badges allowed	Only badges recorded in the charging station	Only badges recorded in Schneider Electric LMS or CPO	Badges allowed by Schneider Electric LMS or CPO, Plus local badges
Customer Backend	/	/	ON but no physical Ethernet or modem connection	ON Ethernet connection working	ON Ethernet or modem connection working
ChargerControlinterface	SCREEN	RFID	RFID	RFID	RFID
AllowOfflineTxForUnknowID	TRUE	TRUE	FALSE	FALSE	FALSE
LocalAuthorizationOffline	/	/	TRUE	TRUE	TRUE
LocalAuthListEnabled	/	/	TRUE	FALSE	TRUE
AuthorizationCachedEnable	/	/	FALSE	TRUE	TRUE

Chart describing charging station behavior when communication is lost with backend.

	No badge indentification needed	All badges allowed	Only badges recorded in the charging station	Only badges recorded in Schneider Electric LMS or CPO	Badges allowed by Schneider Electric LMS or CPO, Plus local badges
Strategy when communication lost	Still no need of authentication	Still All badge allowed	Still only badges recorded in the charging station	Set by the LMS or by the CPO	Set by the LMS or by the CPO

Summary page

The summary page indicates the all the changes that have been made in the configuration and compare them from the original version.

11

Arrows “>” and “<” permit to navigate from one step to another of the configuration wizard.

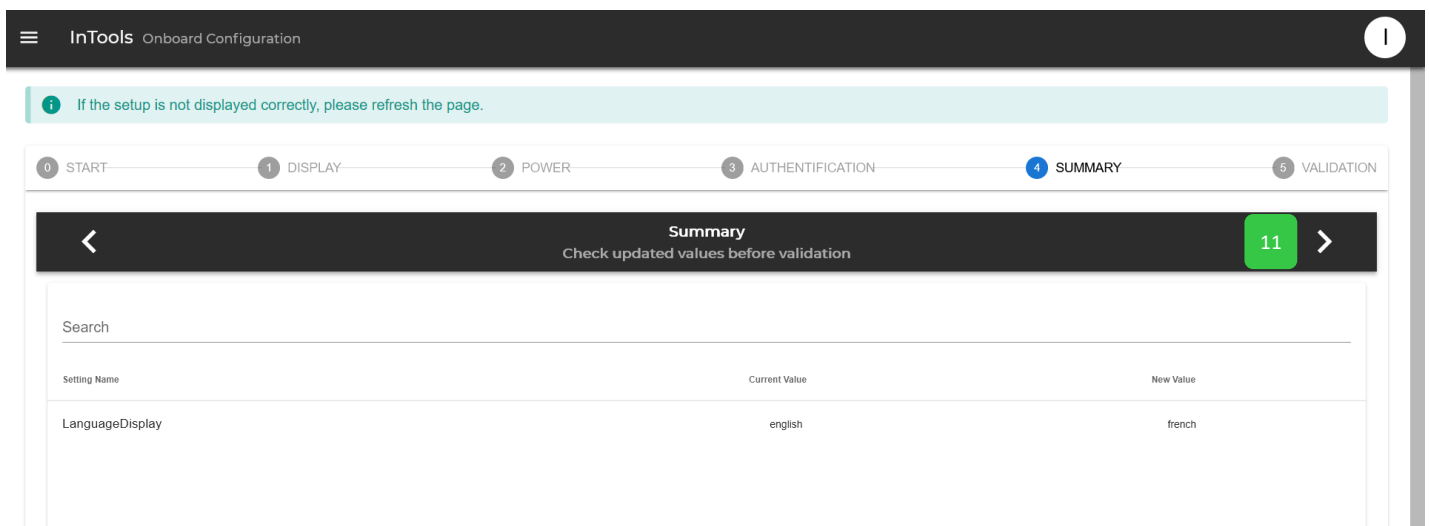

Validation page

- 12 Arrow “<” permits to navigate to previous step of the configuration wizard.
- 13 Check the box to confirm the configuration.
- 14 Click save the configuration the charging station will reboot. The reboot process needs 4 minutes to end. Wait until the display of the connectors on the screen display.

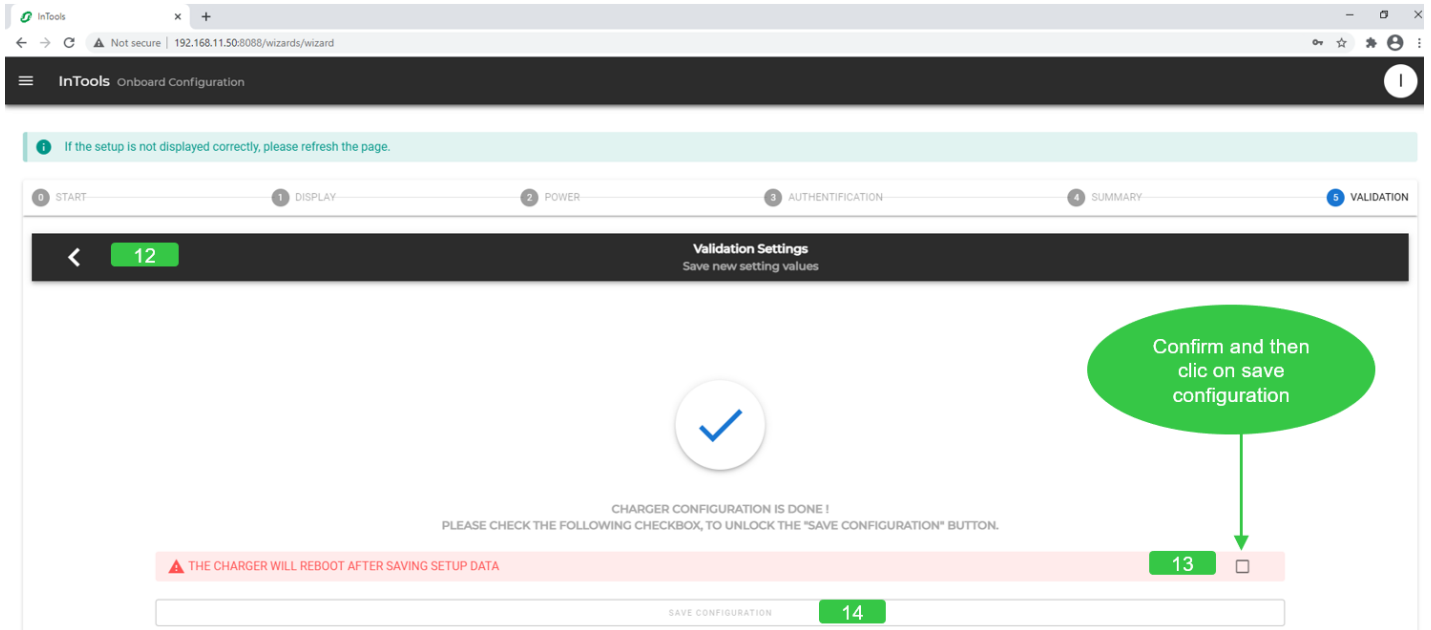

6.2. How to perform connectivity setup

From the main menu select Connectivity Setup.

Please note that you can configure both Ethernet and modem connection or only one of them. Modem connection and ethernet connection are not exclusive one to the other.

For example : In case you want to both connect locally on the charging station using static IP address (for example to access to InTools) and remotely through network, you need to configure both.

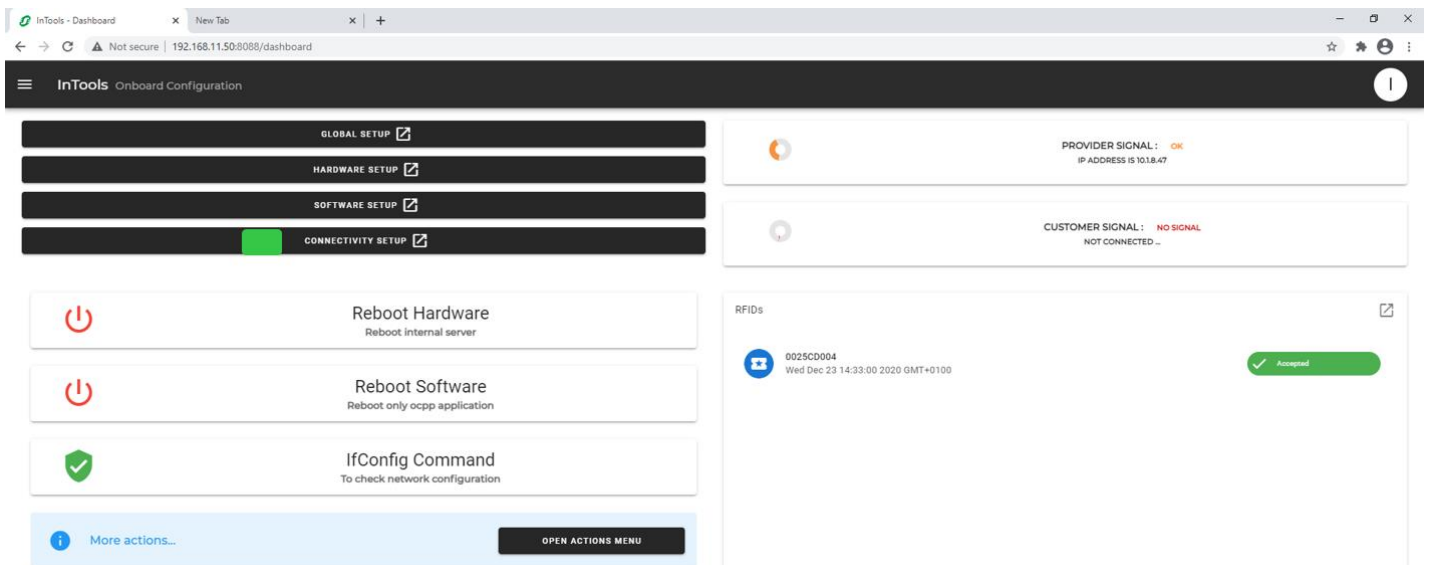

Connectivity configuration starting page

1

Click on the start process.

2

The configuration will progress following the several steps of the wizard. In each step specific parameters will be setup.

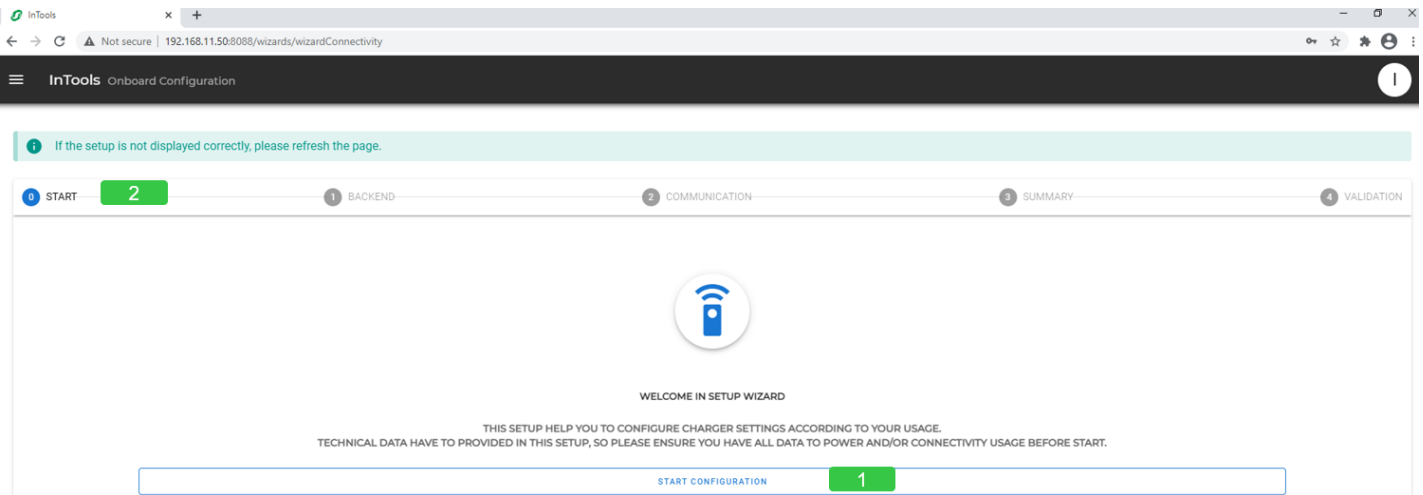

Define back end

3

If the charging station needs to be connected to Schneider Electric Load Management System, Charge Point Operator backend or any other OCPP backend, activate the customer backend.

Backend have also to be activated :

- To be able to access to settings to set the static IP address of the charger (and deactivate DHCP accordingly).
- In case the charging station is configured to authorize locally badges. But in this case, there is no need to configure Ethernet or modem connection.

4

Arrows “>” and “<” permit to navigate from one step to another of the configuration wizard.

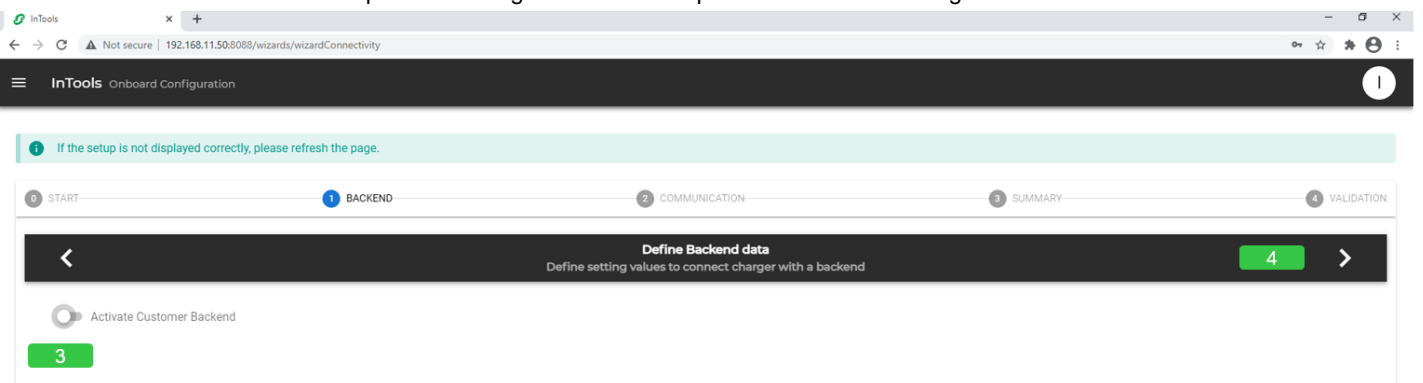

Define back end data

- 5 Select version of the OCCP protocol JSON 1.6 or SOAP.
- 6 Enter the URL of backend. If it's the Schneider Electric Load Management System (LMS) set the LMS IP address adding at the end ":9979". In both cases only WS is allowed.
- 7 Indicate the OCPP ID of the charging station. No blank or special character, such as « - » character, is allowed. **Only alphanumerical value is allowed.**
- 8 Arrows ">" and "<" permit to navigate from one step to another of the configuration wizard.

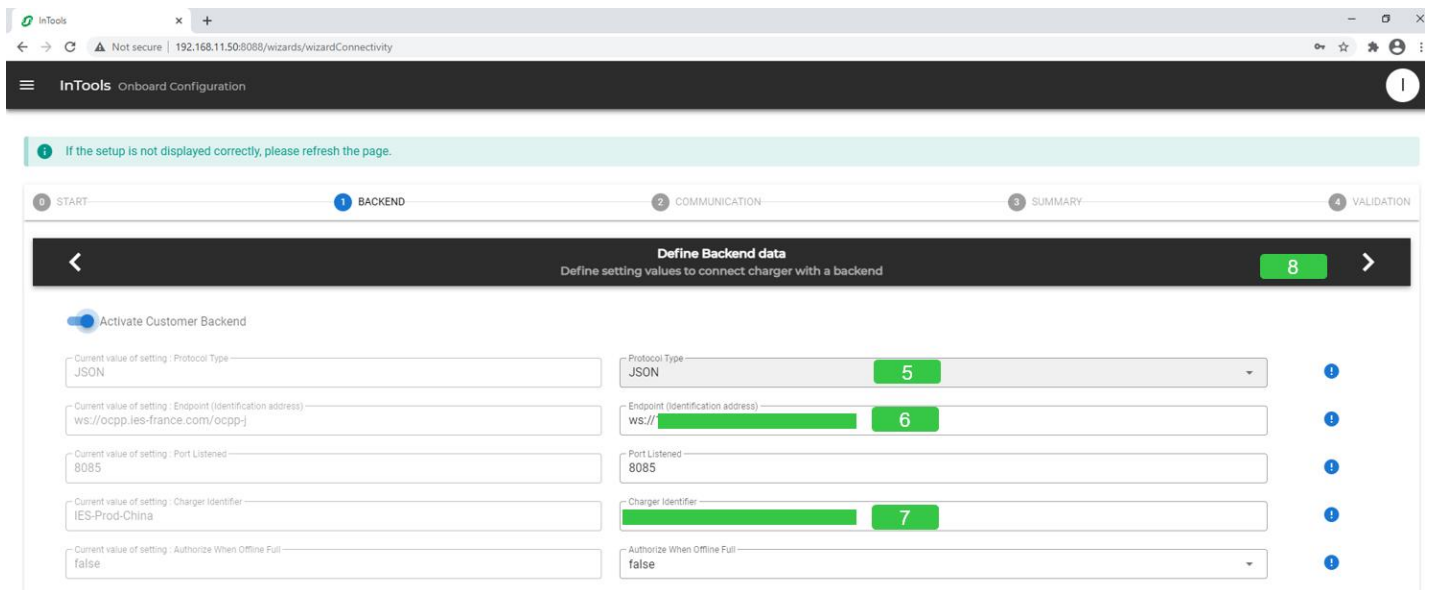

Type of communication used by the charging station – Ethernet with DHCP

- 9 This selection permits to switch between ethernet configuration page and internal modem configuration page. If external modem is used ethernet connection need to be defined.
- 10 If ethernet configuration has been selected this indicates if you want the charging station to use DHCP or static IP address. In case of DHCP the charging station IP address will be set automatically by DHCP server you must have present in the network.
- 11 Independently of connection through Ethernet, using DHCP or static IP address, or modem, define the network gateway IP address. A network gateway joins networks so the devices on one network can communicate with the devices on another network. If you are using an external modem as a gateway, you enter the IP LAN address of the modem. If you are using Schneider Electric modem EVP3MM, as gateway, the address is 192.168.0.254.
- 12 Independently of connection through Ethernet, using DHCP or static IP address, or modem, enter the address of the DNS server. This parameter is not mandatory. A DNS server permits to translate the name of the of a domain (like for example www.google.com) into an IP address.
- 13 Arrows “>” and “<” permit to navigate from one step to another of the configuration wizard.

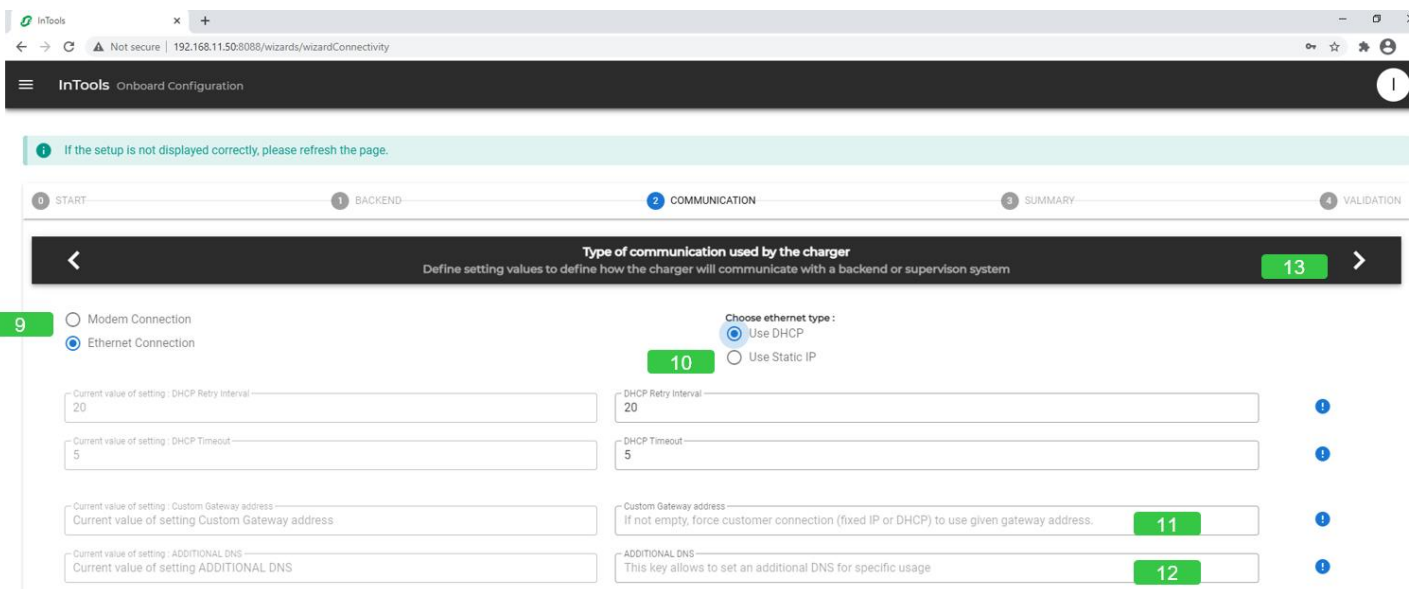

Type of communication used by the charging station – Ethernet with static IP address

- 9 This selection permits to switch between ethernet configuration page and internal modem configuration page. If external modem is used ethernet connection need to be defined.
- 11 Independently of connection through Ethernet, using DHCP or static IP address, or modem, define the network gateway IP address. A network gateway joins networks so the devices on one network can communicate with the devices on another network. If you are using an external modem as a gateway, you enter the IP LAN address of the modem. If you are using Schneider Electric modem EVP3MM, as gateway, the address is 192.168.0.254.
- 12 Independently of connection through Ethernet, using DHCP or static IP address, or modem, enter the address of the DNS server. This parameter is not mandatory. A DNS server permits to translate the name of the of a domain (like for example www.google.com) into an IP address.
- 14 If ethernet configuration has been selected this indicates if you want the charging station to use DHCP or static IP address. If Static IP address is selected, set Ethernet parameters of the charging station to let it communicate with external network devices.
- 15 Define Static IP address, netmask, network and broadcast address. The broadcast address is necessary in case messages need to be transmitted to all devices present in the network. Default factory static IP address is : 192.168.2.50
- 16 Arrows ">" and "<" permit to navigate from one step to another of the configuration wizard.

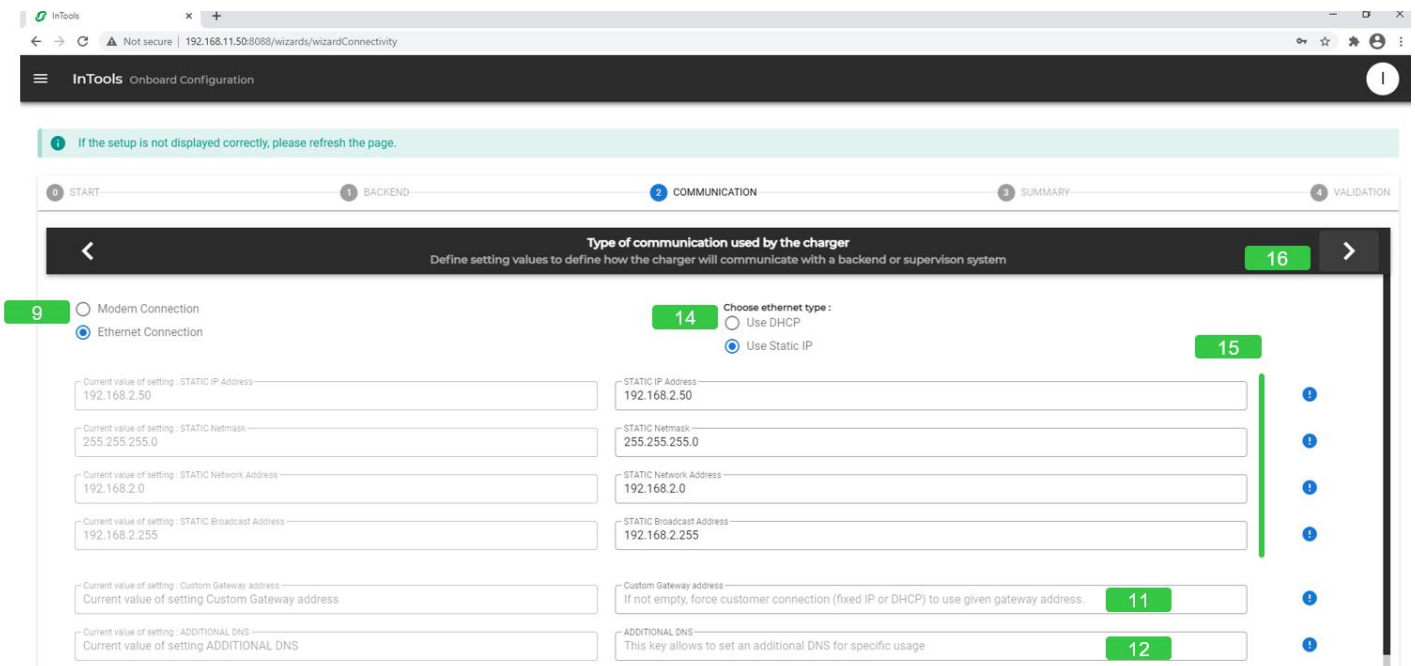

Type of communication used by the charging station – Modem

11 Independently of connection through Ethernet, using DHCP or static IP address, or modem, define the network gateway IP address. A network gateway joins networks so the devices on one network can communicate with the devices on another network.

12 Independently of connection through Ethernet, using DHCP or static IP address, or modem, enter the address of the DNS server. This parameter is not mandatory. A DNS server permits to translate the name of the of a domain (like for example www.google.com) into an IP address.

16 Arrows “>” and “<” permit to navigate from one step to another of the configuration wizard.

17 This selection permits to switch between ethernet configuration page and internal modem configuration page. If external modem is used ethernet connection need to be defined.

18 Enter SIM parameter to provider by mobile operator APN, APN username, APN password.

Note refer to the installation guide for the installation of the SIM card in the charging station.

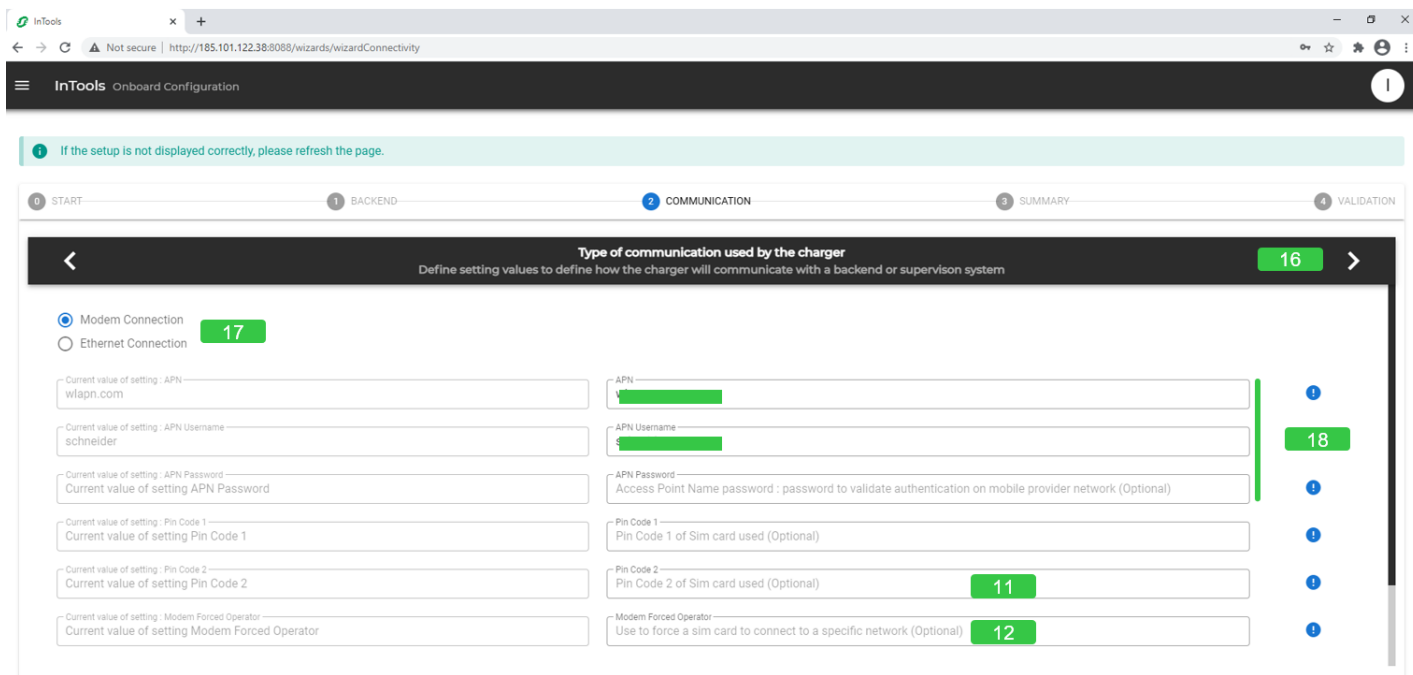

Summary

Once the configuration is completed the summary step shows what has been changed in the configuration. The screen copy below, shows example with no changes.

19

Arrows ">" and "<" permit to navigate from one step to another of the configuration wizard.

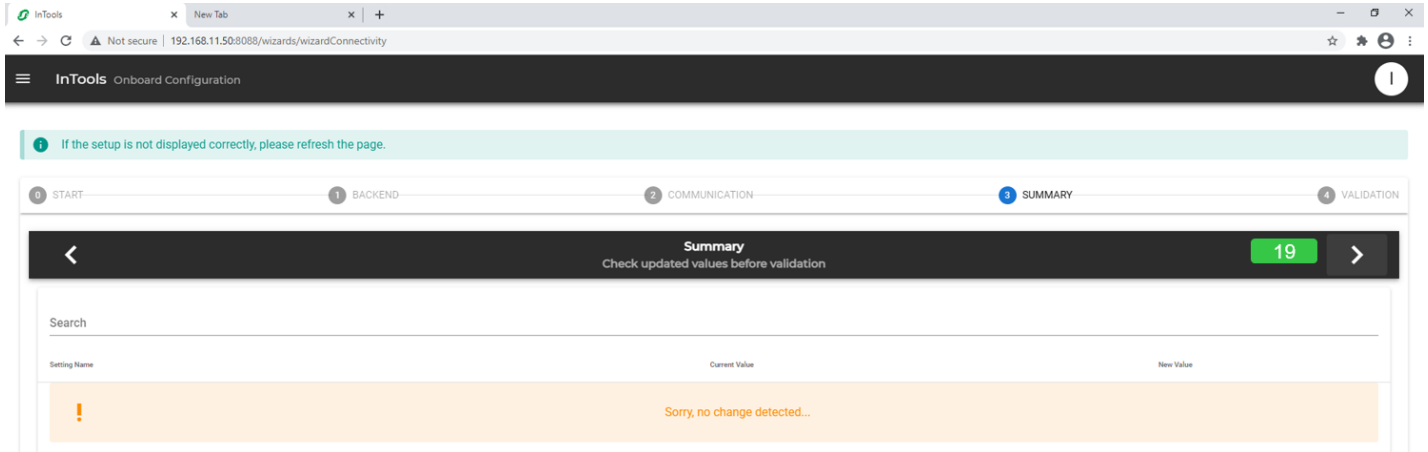

20

Arrow "<" permits to navigate to previous step of the configuration wizard.

Validation settings

21

Check the box to confirm the configuration.

22

Click save the configuration the charging station will reboot.

The reboot process needs 4 minutes to end. Wait until the display of the connectors on the screen display.



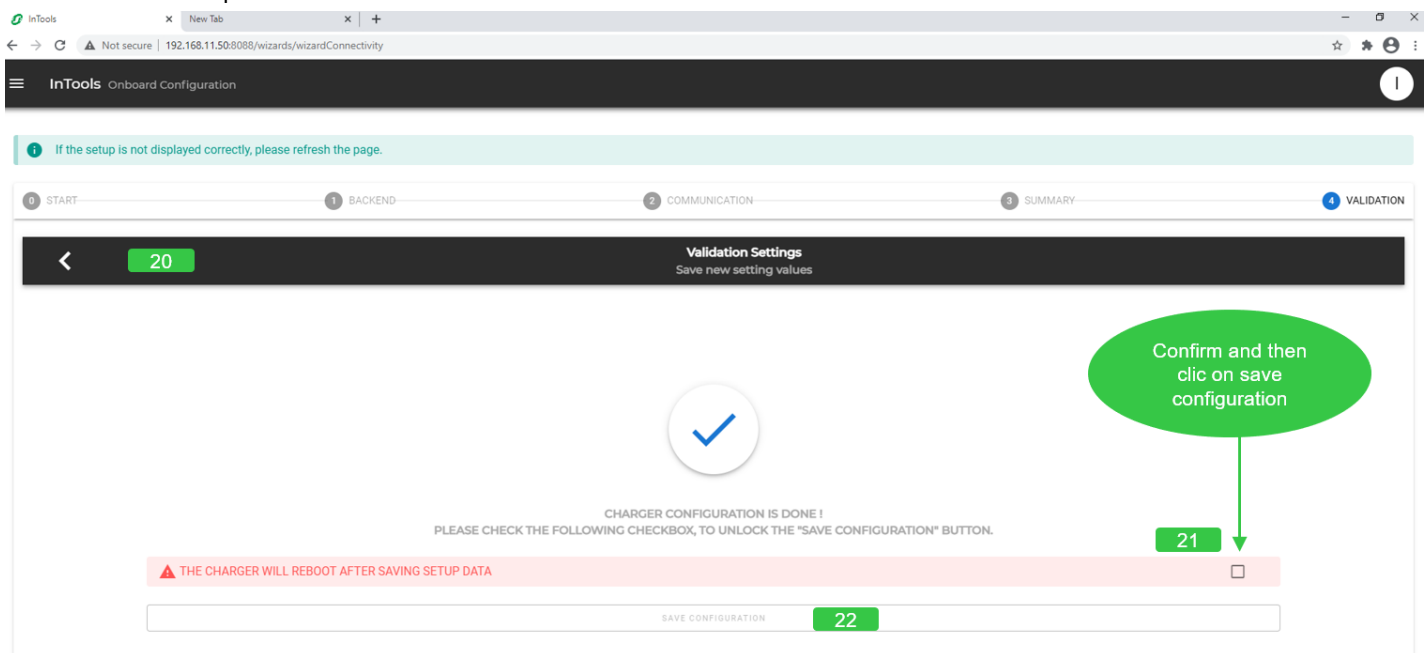



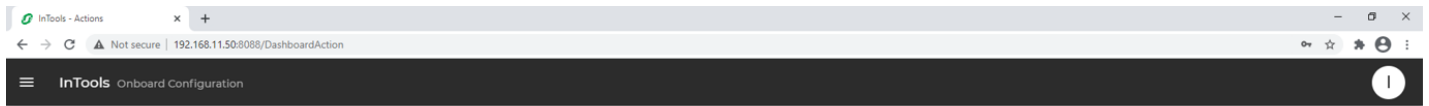

If it's the first configuration made locally on the charging station go back to section 3.3.3 for the description of the end of the process.



7. How to perform actions ● ●

Actions menu is used to launch the following charging station commands.



 Reboot Hardware Reboot internal server	 Generate Diagnostic Extract all log files to diagnostic
 Reboot Software Reboot only ocpp application	 Screen Calibration Follow instructions on charger screen and reboot at the end
 IfConfig Command To check network configuration	 Update Firmware To update your charger with new version
 Ping Command To check if the charger can communicate with a host	 Update DateTime To update local dateTime

7.1. How to Reboot Hardware ● ●

To reboot the high-level card of the charging station (it will impact modems, screen, ongoing charges and this tool).

 **WARNING**

If "Reboot Hardware" is launched while the charging station is charging, the charge will be stopped. Upon restart of the application, a stop transaction frame will be sent to the backend with the parameter "Reason" set to "PowerLoss".

CONFIRM ACTION

 **DO YOU REALLY WANT TO CONFIRM THIS ACTION ?**
Check this box to confirm your choice

7.2. How to perform Software Reboot ● ●

To reboot only the OCPP application.

 **WARNING**

If "Reboot Software" is launched while the charging station is charging, the charge will be stopped. Upon restart of the application, a stop transaction frame will be sent to the backend with the parameter "Reason" set to "PowerLoss".

CONFIRM ACTION

 **DO YOU REALLY WANT TO CONFIRM THIS ACTION ?**
Check this box to confirm your choice

7.3. How to perform IfConfig Command

This action is used to check the network configuration. You'll get screen like the one below.

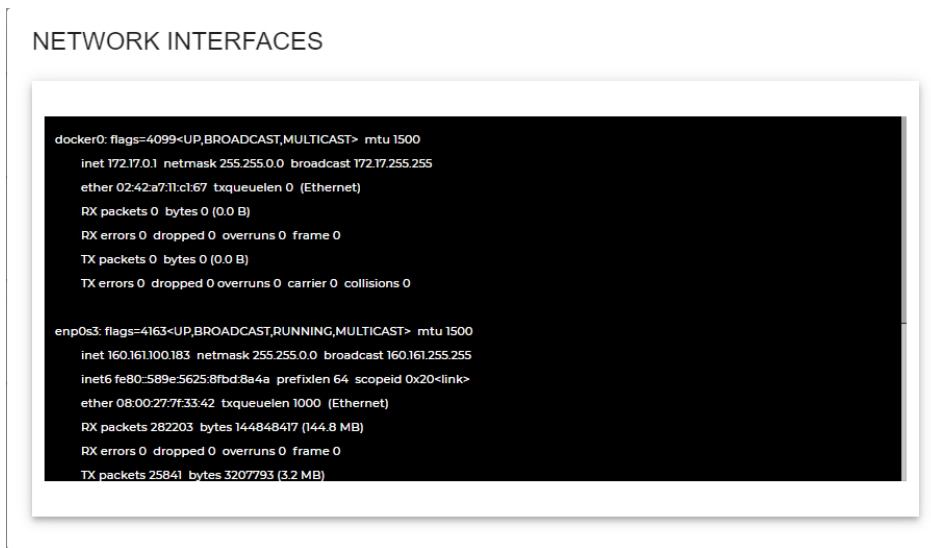

7.4. Ping Command

Use it to check if the charging station can communicate with the host or an external device.

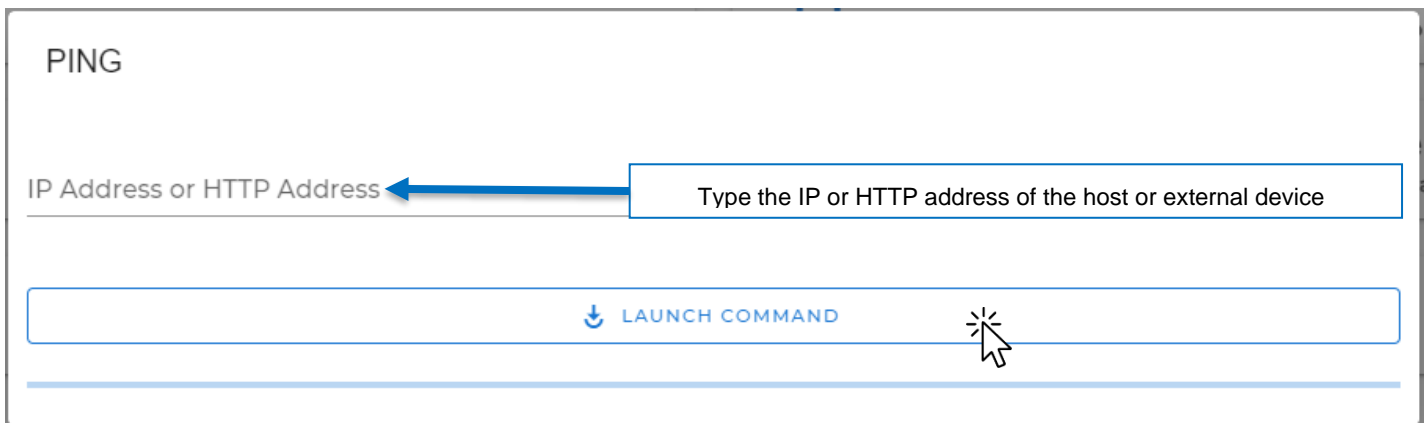

If the Ping is valid, a green section should appear like below:

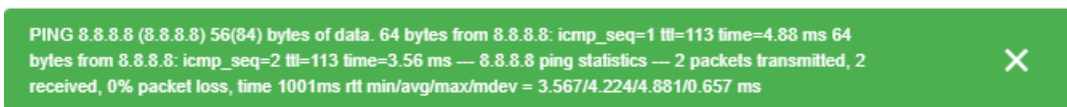

If the nothing happens, it means the Ping is not valid.

7.5. How to Generate Diagnostic ● ●

To extract a diagnostic package with all log files. This package can be provided to your Schneider Electric to diagnose a charging station issue.

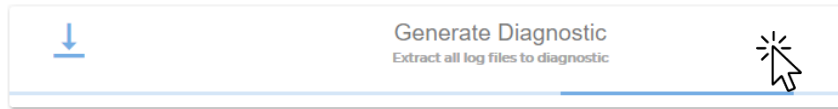

After clicking on “Generate Diagnostic” you must wait until the pop-up window below appears. You can then open the file or save it to provide it to Schneider Electric.

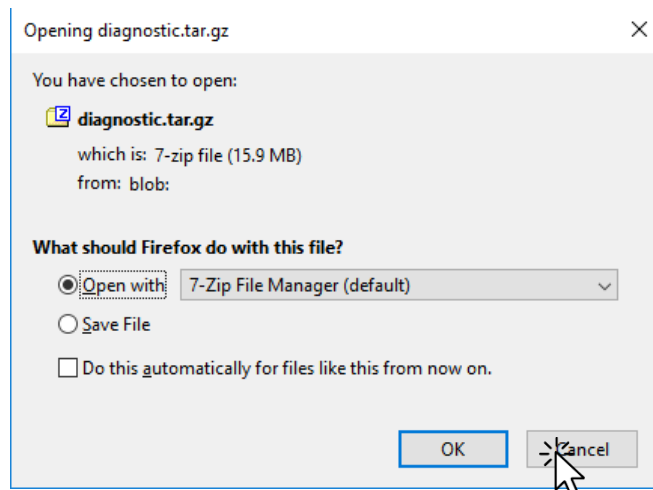

7.6. How to perform Screen Calibration ●

	WARNING
If "Screen Calibration" is launched while the charging station is charging, the charge will be stopped. Upon restart of the application, a stop transaction frame will be sent to the backend with the parameter "Reason" set to "PowerLoss".	

To calibrate the screen. All the instructions are displayed on the screen.

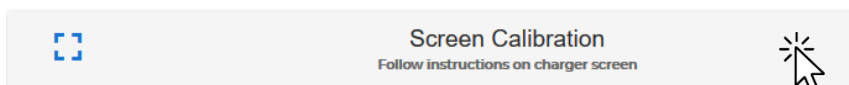

Once the screen calibration is done, the message below appears.

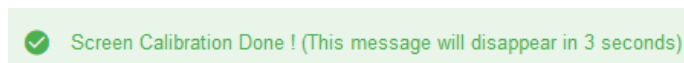



7.7. How to Update Firmware ●

Use it to update the OCPP Firmware. Only .zip file is allowed here.

	WARNING
If "Update Firmware" is launched while the charging station is charging, the charge will be stopped. Upon restart of the application, a stop transaction frame will be sent to the backend with the parameter "Reason" set to "PowerLoss".	

FIRMWARE

Select Firmware File



 OCPP_1_6_INSTALLER_22PRO017362_V018.zip 

Click and select the firmware of the charging station

 Type of file is correct, you can import this file

FILE SELECTED

 OCPP_1_6_INSTALLER_22PRO017362_V018.zip

 UPDATE FIRMWARE 

If the file type is not correct, the form is locked like this :

FIRMWARE

Select Firmware File

 production_order_20191007510211.pdf

 File type is not correct, only file .zip is allowed !

 UPDATE FIRMWARE

7.8. How to Update Date Time ● ●

Use it to update the local date and time. This action only works if you use your charging station offline, when the charging station is connected to a backend, date and time are updated with backend date and time.

UPDATE CHARGER DATETIME



UPDATE CHARGER DATETIME



UPDATE CHARGER DATETIME

8. How to manager RFID badges ● ●

In this section, you can define which RFIDs will be approved if you want to use your charging station offline.

NOTICE
When charging station is offline, you can also accept or deny all charge request. To configure RFIDs usage, please check section 6.1 about the authentication strategy..

WARNING
In order to allow badges locally stored in the charging station to authorize charge, authentication specific configuration need to be done. For details refer to the chart in section 6.1. By default, all badges are allowed.

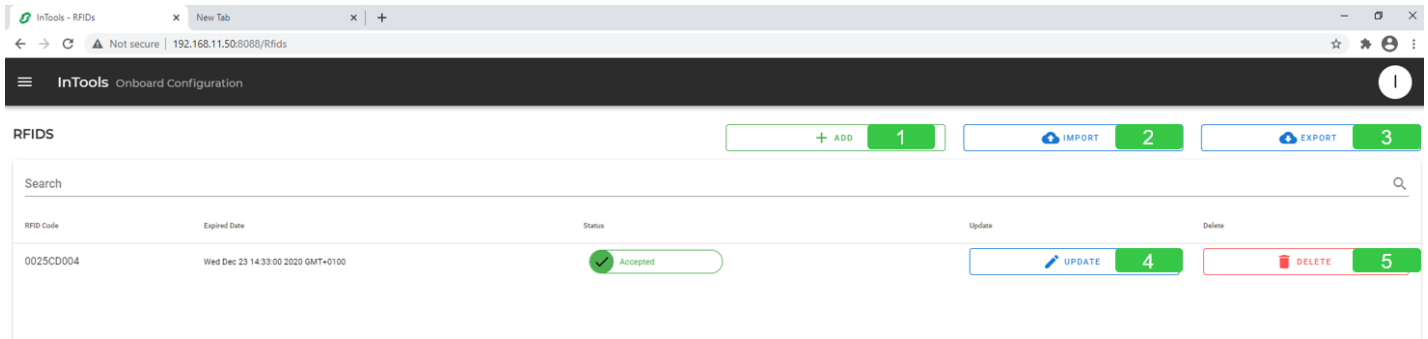

- 1 Click on “ADD” to define a specific RFID card authorized to launch a charging station.
- 2 Click on “IMPORT” to import a list of authorized RFID cards.
- 3 Click on “EXPORT” to export the list of authorized RFID cards.
- 4 Click on “UPDATE” to update RFID content data.
- 5 Click on “DELETE” to delete RFID in local whitelist.

8.1. Add – Edit – Delete a RFID badge ● ●

NEW RFID

The 'NEW RFID' form includes the following fields and callouts:

- RFID code**: A text input field with a callout: "Type your RFID code".
- No Expiration (This RFID has no expiration date)**: A checkbox with a callout: "Tick this box if you don't want any expiration date of the RFID".
- Expired Date Selection**: A section containing:
 - A calendar for July 2020 with the 21st selected. Callout: "Set a date and time of expiration of the RFID card".
 - A digital clock showing 4:25 PM. Callout: "Set a date and time of expiration of the RFID card".
- Expired Datetime**: A text input field.
- Status**: A dropdown menu with a callout: "Set the status of the RFID card (Accepted / Invalid / Expired / Blocked)".
- Buttons**: A red "CANCEL" button and a green "UPDATE" button with a checkmark icon.

Once you have validated the RFID badge, it will appear like below.
You'll be then able to update or delete if you want the RFID badge using the "update" and "delete" button, as per the image below.

RFIDS

[+ ADD](#) [IMPORT](#) [EXPORT](#)

RFID Code	Expired Date	Status	Update	Delete
0123456789	No Expiration	Accepted	UPDATE	DELETE

Rows per page: 10 1-1 of 1

8.2.Import an RFID list ● ●

Use this action to import an existing whitelist. The content file have to respect the format describes below. The imported file is checked before to import on charging station.

All following elements are checked :

- File type is only .csv
- File content contains :
 - First line is column headers
 - Other lines respect the following column formats :
 - Id : number
 - expiredDate: date with format 'YYYY-mm-dd HH:mm' (ex: 2020-10-21 16:00)
 - status: string include in this list (Accepted / Invalid / Expired / Blocked)

Two import types are available :

- 'Add to WhiteList'
This option will add the imported elements in the local WhiteList

WARNING
Only element with id not included in existing whitelist can be added.

- 'Replace existing WhiteList'
This option will delete the current local WhiteList and replace it by the imported elements.

Import List

i To import list of datas, you have to respect the followings constraints :

- **CSV File :**
 Format Line = id;expiredDate;status
 Date Format = YYYY-mm-dd HH:mm
 Example = "0BA042D;01-01-2020 18:40;Accepted"
Warning : Header Line have to be on first line (id;expiredDate;status)

Select File

whiteList (27).csv

Click and select the file containing the RFID list

✓ Type of file is correct, you can import this file

Add to WhiteList

Replace existing WhiteList

Choose to Add or Replace the

! Do you really want to add this list in the Whitelist ?
Check this box to confirm your choice

IMPORT LIST

If one of checking rules is not correct, an error will occur like this :

Import List

i To import list of datas, you have to respect the followings constraints :

- **CSV File :**
- Format Line = id;expiredDate;status
- Date Format = YYYY-mm-dd HH:mm
- Example = "0BA042D;01-01-2020 18:40;Accepted"
- Warning : Header Line have to be on first line (id;expiredDate;status)**

Select File

production_order_20191007510211.pdf

! Type of file is not allowed !

Add to WhiteList

Replace existing WhiteList

IMPORT LIST

8.3. Export an RFID list ● ●

Use it to export local white in .csv format. This file can be imported on other charging stations to copy the whitelist. Click on 'Export' Button and then the file will be saved in the Download folder.

WARNING

If you need to modify the exported file and keep its format use Notepad++. Don't or modify and save the file using Excel otherwise you'll have an error when importing it back. Use Excel only for reading saved file.

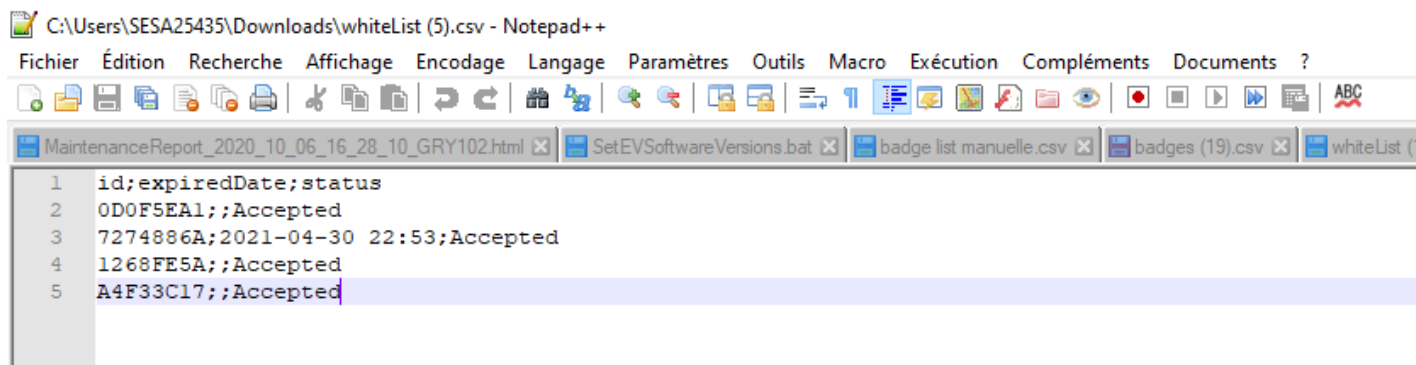

9. How to manage backup

The “Backup” section is used to manage backup of the charging station settings.

Before each setup, a backup is done automatically by the charging station to save settings before update. It also possible to create a manual backup on this section.

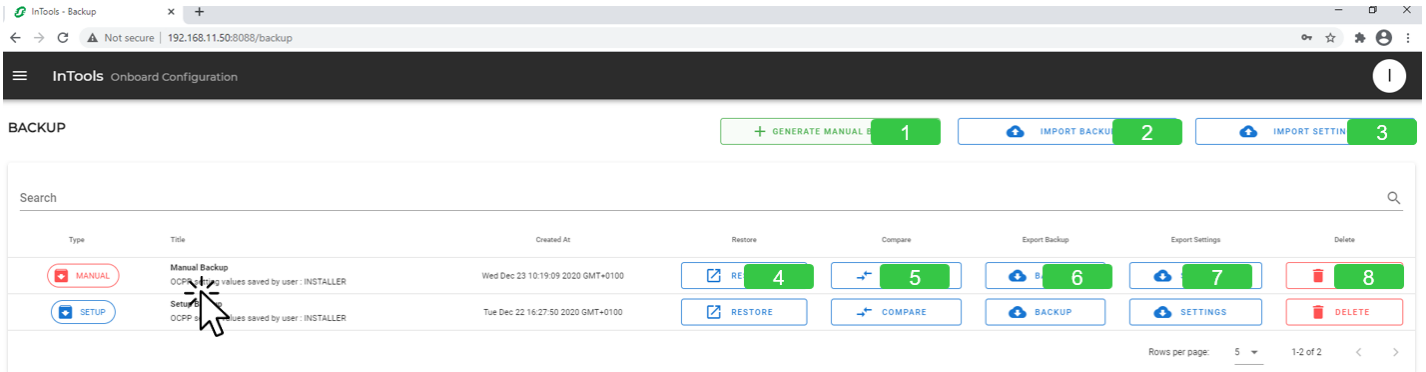

BACKUP COMPARE

1. Click on “GENERATE MANUAL BACKUP” to manually generate a backup
2. Click on “IMPORT BACKUP” to import an existing backup
3. Click on “IMPORT SETTINGS” to import existing settings
4. Click on “RESTORE” to reset values with backup content
5. Click on “COMPARE” to compare backup setting values and current setting values. The result is display in bottom table of this web page.
6. Click on “BACKUP” to export backup charging station data and backup setting values
7. Click on “SETTINGS” to export only backup setting values
8. Click on “DELETE” to delete the backup

9.1. Backup recovery

Click on Restore to restore your backup on the charging station. This recovery will replace the current charging station data and current setting values with backup data.

BACKUP

+ GENERATE MANUAL BACKUP IMPORT BACKUP IMPORT SETTINGS

Type	Title	Created At	Restore	Compare	Export Backup	Export Settings	Delete
MANUAL	Manual Backup OCPP setting values saved by user : IES	Wed Jul 22 09:50:13 2020 GMT+0200	RESTORE	COMPARE	BACKUP	SETTINGS	DELETE

Rows per page: 5 1-1 of 1



BACKUP RECOVERY

DO YOU REALLY WANT TO RESTORE THIS BACKUP, ALL SETTING VALUES WILL BE REPLACED BY BACKUP VALUES ?
Check this box to confirm your choice

THE CHARGER HAVE TO REBOOT AFTER RECOVERY !
Check this box to confirm

CANCEL CONFIRM

9.2. Backup comparison

Click on "COMPARE" to compare the current settings to the backup settings.

BACKUP

+ GENERATE MANUAL BACKUP IMPORT BACKUP IMPORT SETTINGS

Type	Title	Created At	Restore	Compare	Export Backup	Export Settings	Delete
MANUAL	Manual Backup OCPP setting values saved by user : IES	Wed Jul 22 09:50:13 2020 GMT+0200	RESTORE	COMPARE	BACKUP	SETTINGS	DELETE

Rows per page: 5 1-1 of 1

BACKUP COMPARE

Comparison between backup / current values

Filename	Settings	Backup Values	Current Values
display_info	LanguageDisplay	english	english
display_info	DisplayType	lcd	lcd
display_info	autocheckDisplayInterval	5	2
display_info	RefreshDisplayChargeInterval	1	1
display_info	RefreshErrorAuthInterval	20	20

9.3. Export Backup

Click on “BACKUP” to export current charging station data and current setting values in .json file.

BACKUP

[+ GENERATE MANUAL BACKUP](#) [IMPORT BACKUP](#) [IMPORT SETTINGS](#)

Type	Title	Created At	Restore	Compare	Export Backup	Export Settings	Delete
MANUAL	Manual Backup OCPP setting values saved by user : IES	Wed Jul 22 09:50:13 2020 GMT+0200	RESTORE	COMPARE	BACKUP	SETTINGS	DELETE

Rows per page: 5 1-1 of 1

9.4. Export Settings

Click on “SETTINGS” to export only current setting values in .json file.

BACKUP

[+ GENERATE MANUAL BACKUP](#) [IMPORT BACKUP](#) [IMPORT SETTINGS](#)

Type	Title	Created At	Restore	Compare	Export Backup	Export Settings	Delete
MANUAL	Manual Backup OCPP setting values saved by user : IES	Wed Jul 22 09:50:13 2020 GMT+0200	RESTORE	COMPARE	BACKUP	SETTINGS	DELETE

Rows per page: 5 1-1 of 1

9.5. Delete backup

Click on “DELETE” to delete the backup.

BACKUP

[+ GENERATE MANUAL BACKUP](#) [IMPORT BACKUP](#) [IMPORT SETTINGS](#)

Type	Title	Created At	Restore	Compare	Export Backup	Export Settings	Delete
MANUAL	Manual Backup OCPP setting values saved by user : IES	Wed Jul 22 09:50:13 2020 GMT+0200	RESTORE	COMPARE	BACKUP	SETTINGS	DELETE

Rows per page: 5 1-1 of 1

10. How to change password ● ●

- 1 Click on the icon on the top right corner.
- 2 Click on « CHANGE PASSWORD » to change your password.

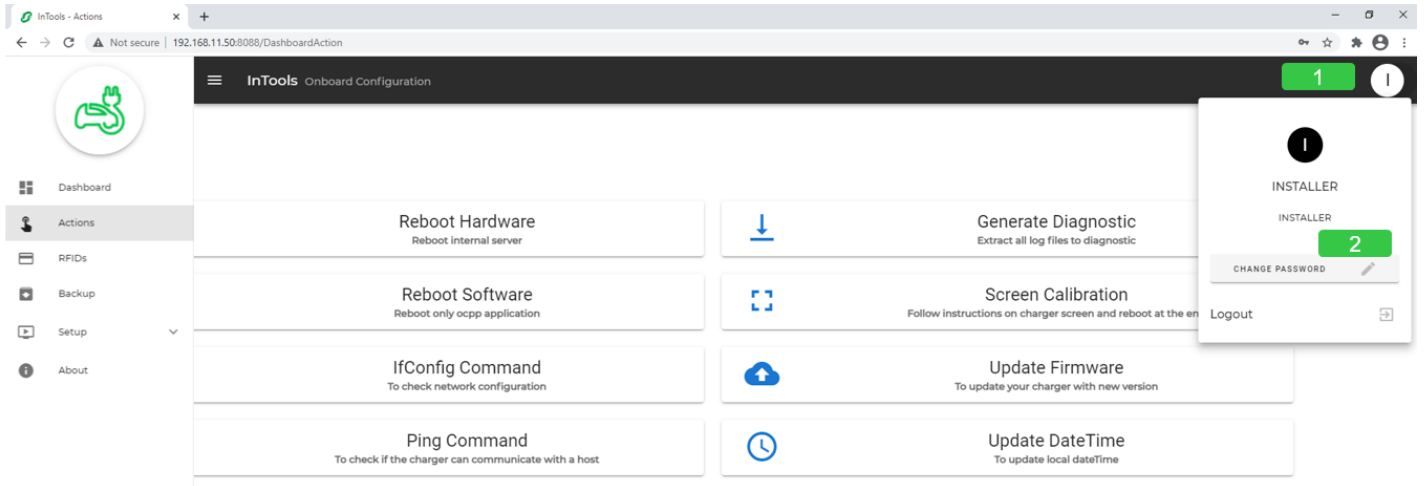

11. About

About section indicates the version of InTools software.

It indicates also the webpage where all local support contacts can be found.

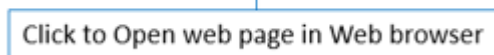
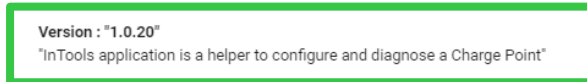
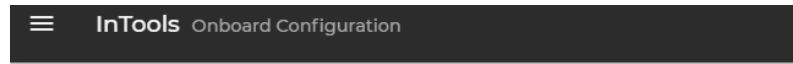

12. Factory Default configuration

This is the list of the default factory settings.

- Ethernet port : is configured DHCP client,
- Authentication is : all badges accepted, local badge management is not active,
- Backend is not active,
- Screen language is English,
- Power is at the nominal value 24 kw,
- No RFID badge is registered,
- No modem configuration is performed.

Life Is On

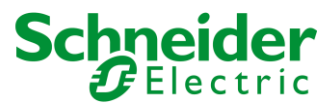

Schneider Electric Industries SAS

35, rue Joseph Monier
CS 30323
92506 Rueil Malmaison Cedex (France)

www.se.com

© 2021 - Schneider Electric - All rights reserved.
All trademarks are owned by Schneider Electric Industries SAS or its affiliated companies.