

Pact Series

MasterPact MTZ – Modbus Communication

User Guide

Pact Series offers world-class circuit breakers and switches.

DOCA0105EN-10
05/2023



Legal Information

The Schneider Electric brand and any trademarks of Schneider Electric SE and its subsidiaries referred to in this guide are the property of Schneider Electric SE or its subsidiaries. All other brands may be trademarks of their respective owners.

This guide and its content are protected under applicable copyright laws and furnished for informational use only. No part of this guide may be reproduced or transmitted in any form or by any means (electronic, mechanical, photocopying, recording, or otherwise), for any purpose, without the prior written permission of Schneider Electric.

Schneider Electric does not grant any right or license for commercial use of the guide or its content, except for a non-exclusive and personal license to consult it on an "as is" basis. Schneider Electric products and equipment should be installed, operated, serviced, and maintained only by qualified personnel.

As standards, specifications, and designs change from time to time, information contained in this guide may be subject to change without notice.

To the extent permitted by applicable law, no responsibility or liability is assumed by Schneider Electric and its subsidiaries for any errors or omissions in the informational content of this material or consequences arising out of or resulting from the use of the information contained herein.

As part of a group of responsible, inclusive companies, we are updating our communications that contain non-inclusive terminology. Until we complete this process, however, our content may still contain standardized industry terms that may be deemed inappropriate by our customers.

Table of Contents

Safety Information	7
About the Book.....	9
Modbus Communication with MasterPact MTZ Circuit	
Breakers	11
Introduction	12
Description	13
Intelligent Modular Unit.....	14
EcoStruxure Power Commission Software	18
IFM Interface Presentation	20
Introduction	20
Hardware Description.....	21
Schematics with MasterPact MTZ Circuit Breakers	25
Configuration.....	27
Communication Test	28
IFE Interface	29
Introduction	30
Hardware Description.....	31
Schematics with MasterPact MTZ Circuit Breakers	35
EIFE Ethernet Interface for Drawout Circuit Breaker	36
Introduction	36
Hardware Description.....	37
Modbus Protocol with MasterPact MTZ Circuit Breakers	41
Modbus Master/Slave Principle.....	42
Modbus Programming Recommendations	45
Modbus Functions	47
Modbus Exception Codes	51
Write Protection.....	53
Password Management	54
Command Interface	56
Command Examples	61
Date Management.....	63
Modbus Registers Tables	64
Dataset	69
Standard Dataset	70
Standard Dataset.....	71
Modbus Registers.....	72
Readout Examples.....	75
Standard Dataset Common Registers	77
Legacy Dataset	91
Legacy Dataset.....	92
Modbus Registers.....	93
Readout Examples.....	95
Legacy Dataset Common Registers	97
MicroLogic Control Unit Data for MasterPact MTZ Circuit	
Breakers	108
MicroLogic Control Unit Registers	109
Tripping Data.....	110

Circuit Breaker Data	117
Circuit Breaker Characteristics	120
Real-Time Measurements	124
Harmonic Values.....	131
Minimum and Maximum Values of Real-Time Measurements	144
Maintenance and Diagnostic Data	154
Energy Measurements	159
Protection Settings.....	162
Demand Values of Real-Time Measurements.....	164
Peak Values of Demand Values of Real-Time Measurements	165
MicroLogic Control Unit Commands	167
List of MicroLogic Control Unit Commands and Error Codes.....	167
Protection Get Commands without Session	168
Protection Set Commands without Session.....	173
Measurement Set and Reset Commands.....	176
Diagnostic Get Commands	177
Measurement Settings Set Commands.....	183
Circuit Breaker Operation Set Commands	185
MicroLogic X Get and Reset Commands	187
MicroLogic Control Unit Protection Commands with Session.....	196
Description of Commands with Session	197
List of MicroLogic Control Unit Protection Commands with Session and Error Codes	199
Session Management Commands.....	200
Protection Submit Commands	202
Protection Get Commands with Session	207
IO Module Data for MasterPact MTZ Circuit Breakers.....	215
IO Module Registers	216
Introduction	217
Analog Inputs	218
Digital Inputs	220
Digital Outputs.....	223
Hardware Setting.....	225
Digital Input and Output Status.....	227
IO Module Identification.....	228
Alarm Status.....	230
Applications.....	233
IO Module Events	236
Event History	237
IO Module Events and Alarms.....	239
IO Module Commands	244
List of IO Module Commands.....	244
Generic Commands	245
Application Commands	250
IFM Interface Data for MasterPact MTZ Circuit Breakers.....	254
IFM Interface Registers	255
IFM Interface Identification	256
Modbus Network Parameters.....	259
IFM Interface Commands	261
List of IFM Interface Commands.....	261
IFM Interface Commands	262

IFE/EIFE Interface Data for MasterPact MTZ Circuit

Breakers	265
IFE/EIFE Interface Registers	266
IFE/EIFE Interface Identification and Status Registers	267
EIFE Interface Specific Registers	272
IP Network Parameters	274
IFE/EIFE Interface Commands	275
List of IFE/EIFE Interface Commands	275
IFE/EIFE Interface Generic Commands	276
EIFE Interface Specific Commands	278
Appendices	283
MicroLogic X Events	284
Event History	285
Event List	287

Safety Information

Important Information

Read these instructions carefully, and look at the equipment to become familiar with the device before trying to install, operate, service, or maintain it. The following special messages may appear throughout this documentation or on the equipment to warn of potential hazards or to call attention to information that clarifies or simplifies a procedure.



The addition of this symbol to a “Danger” or “Warning” safety label indicates that an electrical hazard exists which will result in personal injury if the instructions are not followed.



This is the safety alert symbol. It is used to alert you to potential personal injury hazards. Obey all safety messages that follow this symbol to avoid possible injury or death.

DANGER

DANGER indicates a hazardous situation which, if not avoided, **will result in** death or serious injury.

WARNING

WARNING indicates a hazardous situation which, if not avoided, **could result in** death or serious injury.

CAUTION

CAUTION indicates a hazardous situation which, if not avoided, **could result in** minor or moderate injury.

NOTICE

NOTICE is used to address practices not related to physical injury.

Please Note

Electrical equipment should be installed, operated, serviced, and maintained only by qualified personnel. No responsibility is assumed by Schneider Electric for any consequences arising out of the use of this material.

A qualified person is one who has skills and knowledge related to the construction and operation of electrical equipment and its installation, and has received safety training to recognize and avoid the hazards involved.

Cybersecurity Safety Notice

⚠ WARNING

POTENTIAL COMPROMISE OF SYSTEM AVAILABILITY, INTEGRITY, AND CONFIDENTIALITY

- Change default passwords at first use to help prevent unauthorized access to device settings, controls, and information.
- Disable unused ports/services and default accounts to help minimize pathways for malicious attackers.
- Place networked devices behind multiple layers of cyber defenses (such as firewalls, network segmentation, and network intrusion detection and protection).
- Use cybersecurity best practices (for example, least privilege, separation of duties) to help prevent unauthorized exposure, loss, modification of data and logs, or interruption of services.

Failure to follow these instructions can result in death, serious injury, or equipment damage.

About the Book

Document Scope

The aim of this document is to provide users, installers, and maintenance personnel with the technical information needed to operate the Modbus protocol on the following ranges of circuit breakers:

- MasterPact™ MTZ1 circuit breakers from 630 to 1600 A
- MasterPact™ MTZ2 circuit breakers from 800 to 4000 A
- MasterPact™ MTZ3 circuit breakers from 4000 to 6300 A

Validity Note

This document is valid for MasterPact MTZ1/MTZ2/MTZ3 circuit breakers with a MicroLogic X control unit and connected:

- either to an RS-485 serial line Modbus network using an IFM Modbus-SL interface for one circuit breaker.
- or to an Ethernet network using:
 - an IFE Ethernet interface for one circuit breaker,
 - an IFE Ethernet switchboard server or,
 - an EIFE embedded Ethernet interface for one MasterPact MTZ drawout circuit breaker.

This document describes the registers and commands available for the IMU modules with the following firmware version:

IMU module	Part number	Firmware version
MicroLogic X control unit	-	≥ V004.101.000
IO module	LV434063	≥ V003.004.005
IFM interface	LV434000	≥ V003.001.012
IFE Ethernet interface	LV434001	≥ V004.007.000
	LV434010	
IFE Server	LV434002	≥ V003.016.000
	LV434011	
EIFE Ethernet interface	LV851001	≥ V004.007.000

You can update the firmware of the IMU modules by using the latest version of EcoStruxure Power Commission software.

NOTE: This guide also applies to MicroLogic™ Xi control units. A MicroLogic Xi control unit is a MicroLogic X control unit without Bluetooth Low Energy (BLE) communication.

The specific features of the MicroLogic Xi control units are described in the appendix in [DOCA0102EN](#) MasterPact MTZ – MicroLogic X Control Unit – User Guide.

Online Information

The information contained in this guide is likely to be updated at any time. Schneider Electric strongly recommends that you have the most recent and up-to-date version available on www.se.com/ww/en/download.

The technical characteristics of the devices described in this guide also appear online. To access the information online, go to the Schneider Electric home page at www.se.com.

Related Documents for IEC Devices

Title of documentation	Reference number
<i>MasterPact MTZ1 – IEC Circuit Breakers and Switch-Disconnectors from 630 to 1600 A – User Guide</i>	DOCA0100EN
<i>MasterPact MTZ2/MTZ3 – IEC Circuit Breakers and Switch-Disconnectors from 800 to 6300 A – User Guide</i>	DOCA0101EN
<i>MasterPact MTZ – MicroLogic X Control Unit – User Guide</i>	DOCA0102EN
<i>ULP System (IEC Standard) – ULP (Universal Logic Plug) System – User Guide</i>	DOCA0093EN
<i>Enerlin X IFE – Ethernet Switchboard Server – User Guide</i>	DOCA0084EN
<i>Enerlin X IFE - Ethernet Interface for One IEC Circuit Breaker – User Guide</i>	DOCA0142EN
<i>Enerlin X EIFE – Embedded Ethernet Interface for One MasterPact MTZ Drawout Circuit Breaker – User Guide</i>	DOCA0106EN
<i>Enerlin X IO – Input/Output Application Module for One IEC Circuit Breaker – User Guide</i>	DOCA0055EN
<i>Enerlin X IFE – Ethernet Interface for One Circuit Breaker – Instruction Sheet</i>	QGH13473
<i>Enerlin X EIFE – Embedded Ethernet Interface for One MasterPact MTZ Drawout Circuit Breaker – Instruction Sheet</i>	NVE23550
<i>Enerlin X IFM – Modbus-SL Interface for One Circuit Breaker – Instruction Sheet</i>	NVE85393
<i>Enerlin X IO – Input/Output Application Module for One Circuit Breaker – Instruction Sheet</i>	HRB49217

You can download these technical publications and other technical information from our website at www.se.com/ww/en/download.

Related Documents for UL Devices

Title of documentation	Reference number
<i>MasterPact MTZ – MicroLogic X Control Unit – User Guide</i>	DOCA0102EN
<i>MasterPact MTZ1 – UL Rated/ANSI Certified 800 to 1600 A Circuit Breakers and Switches – User Guide</i>	0614IB1702EN
<i>MasterPact MTZ2/MTZ3 – UL Rated/ANSI Certified 800 to 6000 A Circuit Breakers and Switches – User Guide</i>	0614IB1701EN
<i>ULP System (UL Standard) – ULP (Universal Logic Plug) System – User Guide</i>	0602IB1503 (EN)
<i>Enerlin X IFE – Ethernet Switchboard Server – User Guide</i>	1040IB1401 (EN)
<i>Enerlin X IFE – Ethernet Interface for One UL Circuit Breaker – User Guide</i>	0602IB1801EN
<i>Enerlin X IO - Input/Output Application Module for One UL Circuit Breaker - User Guide</i>	0613IB1317 (EN)
<i>Enerlin X IFE – Ethernet Interface for One Circuit Breaker – Instruction Sheet</i>	QGH13473
<i>Enerlin X EIFE – Embedded Ethernet Interface for One MasterPact MTZ Drawout Circuit Breaker – Instruction Sheet</i>	NVE23550
<i>Enerlin X IFM – Modbus-SL Interface for One Circuit Breaker – Instruction Sheet</i>	NVE85393
<i>Enerlin X IO – Input/Output Application Module for One Circuit Breaker – Instruction Sheet</i>	HRB49217

You can download these technical publications and other technical information from our website at www.se.com/ww/en/download.

Modbus Communication with MasterPact MTZ Circuit Breakers

What's in This Part

Introduction.....	12
IFM Interface Presentation.....	20
IFE Interface.....	29
EIFE Ethernet Interface for Drawout Circuit Breaker.....	36

Introduction

What's in This Chapter

Description	13
Intelligent Modular Unit	14
EcoStruxure Power Commission Software	18

Pact Series Master Range

Future-proof your installation with Schneider Electric's low-voltage and medium-voltage Pact Series. Built on legendary Schneider Electric innovation, the Pact Series comprises world-class circuit breakers, switches, residual current devices and fuses, for all standard and specific applications. Experience robust performance with Pact Series within the EcoStruxure-ready switchgear, from 16 to 6300 A in low-voltage and up to 40.5 kV in medium-voltage.

Description

Modbus Communication

The Modbus communication option enables Schneider Electric low voltage circuit breakers to be connected to a supervisor or to any other device with a master Modbus communication channel.

The Modbus communication option is available for the MasterPact MTZ circuit breakers with the MicroLogic X control unit and the ULP port module.

The MasterPact MTZ circuit breakers can be connected:

- to an RS-485 serial line network with Modbus protocol using the IFM Modbus-SL interface for one circuit breaker with part number LV434000.
- to an Ethernet network with Modbus TCP/IP protocol using dedicated interfaces like:
 - the IFE Ethernet interface for one circuit breaker.
 - the IFE Ethernet switchboard server.
 - the EIFE embedded Ethernet interface for MasterPact MTZ drawout circuit breaker.

Access to Functions

The Modbus communication option provides access to many functions, including:

- read metering and diagnostic data
- read status conditions and remote operations
- transfer of time-stamped events
- display protection settings
- read the circuit breakers identification and configuration data
- remote control of the circuit breaker
- time-setting and synchronization

This list depends on the composition of the intelligent modular unit (type of circuit breaker, type of MicroLogic control unit, IO application module, and so on) and the enabled functions.

Convention

The electrical phases described as phase 1, phase 2, phase 3 cover both IEC standard and UL standard, with the following equivalence:

IEC Standard	UL Standard
Phase 1	Phase a
Phase 2	Phase b
Phase 3	Phase c

Intelligent Modular Unit

Definition

A modular unit is a mechanical and electrical assembly containing one or more products to perform a function in a switchboard (incoming protection, motor command, and control).

The circuit breaker with its internal communicating components (MicroLogic control unit or MicroLogic trip unit) and external ULP modules (IO module) connected to one communication interface is called an intelligent modular unit (IMU).

An IMU is composed around a circuit breaker from the following ranges:

- MasterPact MTZ circuit breakers
- MasterPact NT/NW circuit breakers
- ComPacT NS 630b–1600 circuit breakers
- ComPacT NS 1600b–3200 circuit breakers
- PowerPacT P- and R- frame circuit breakers
- ComPacT NSX circuit breakers
- PowerPacT H-, J-, and L- frame circuit breakers

ULP Modules Per Circuit Breaker Range

The following table lists the compatible ULP modules for each range of circuit breakers.

ULP Module	Part Number	MasterPact MTZ with ULP Port Module and MicroLogic Control Unit	MasterPact NT/NW or ComPacT NS or PowerPacT P- and R-Frame with BCM ULP Module and MicroLogic Trip Unit	ComPacT NSX or PowerPacT H-, J-, and L-Frame with BSCM Module and/or MicroLogic Trip Unit
IFE Ethernet interface for one circuit breaker	LV434001 LV434010	✓	✓	✓
IFE Ethernet switchboard server	LV434002 LV434011	✓	✓	✓
EIFE Embedded Ethernet interface for one MasterPact MTZ drawout circuit breaker	LV851001	✓	–	–
Spare part kit EIFE for one MasterPact MTZ1 drawout circuit breaker	LV851100SP	✓	–	–
Spare part kit EIFE for one MasterPact MTZ2/MTZ3 drawout circuit breaker	LV851200SP	✓	–	–
IFM Modbus-SL interface for one circuit breaker	TRV00210 STRV00210	–	✓	✓
IFM Modbus-SL interface for one circuit breaker	LV434000	✓	✓	✓
FDM121 front display module for one circuit breaker	TRV00121 STRV00121	✓	✓	✓

ULP Module	Part Number	MasterPact MTZ with ULP Port Module and MicroLogic Control Unit	MasterPact NT/NW or ComPact NS or PowePact P- and R-Frame with BCM ULP Module and MicroLogic Trip Unit	ComPact NSX or PowerPact H-, J-, and L-Frame with BSCM Module and/or MicroLogic Trip Unit
IO input/output application module for one circuit breaker	LV434063	✓	✓	✓
USB maintenance interface	TRV00911 STRV00911	–	✓	✓

For more information on the ULP System and its components, refer to [DOCA0093EN](#) ULP (Universal Logic Plug) System for ComPact and MasterPact Circuit Breakers – User Guide.

Communication Architecture

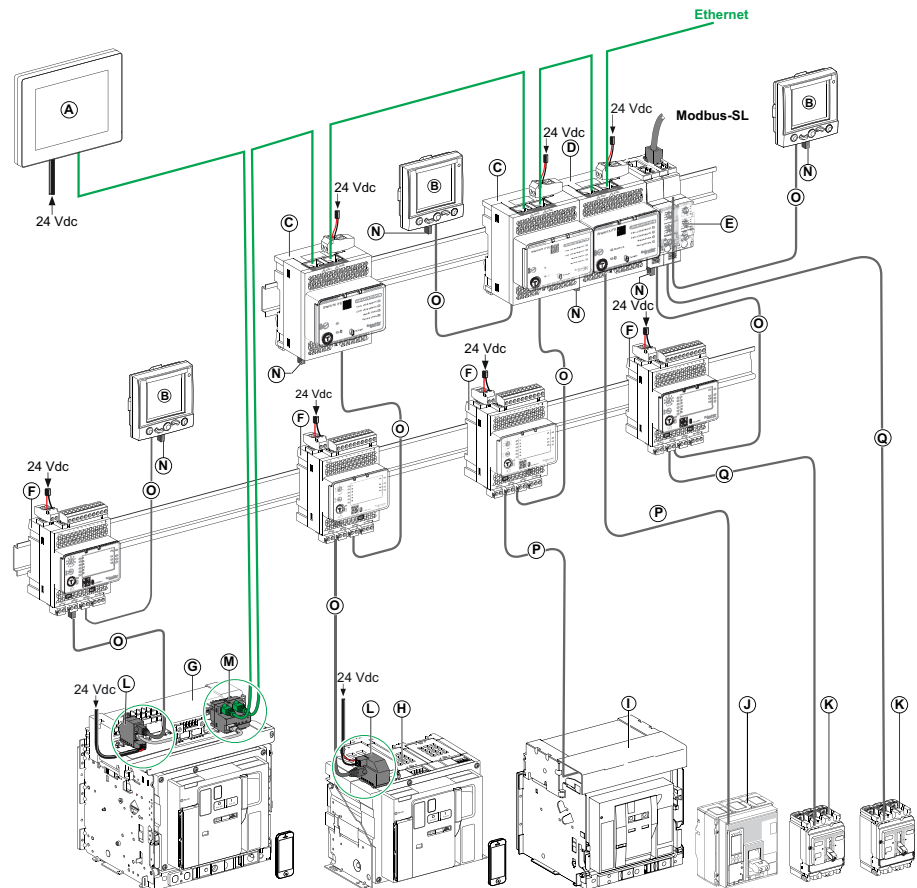

- A** FDM128 Ethernet display for eight devices
- B** FDM121 front display module for one circuit breaker
- C** IFE Ethernet interface for one circuit breaker
- D** IFE Ethernet switchboard server
- E** IFM Modbus-SL interface for one circuit breaker
- F** IO input/output application module for one circuit breaker
- G** MasterPact MTZ1 or MTZ2/MTZ3 drawout circuit breaker
- H** MasterPact MTZ1 or MTZ2/MTZ3 fixed circuit breaker
- I** MasterPact NT/NW circuit breaker
- J** ComPacT NS/PowerPacT M-, P-, and R-frame circuit breaker
- K** ComPacT NSX/PowerPacT H-, J-, and L-Frame circuit breaker
- L** ULP port module
- M** EIFE Embedded Ethernet Interface for one MasterPact MTZ drawout circuit breaker
- N** ULP line termination
- O** RJ45 ULP cord
- P** Circuit breaker BCM ULP cord
- Q** NSX cord

Remote Controller

A remote controller is a device that is able to communicate with an IMU using a communication interface, such as the IFE Ethernet interface. For example, FDM128 Ethernet display for eight devices, supervisor, PLC, BMS, SCADA system, and so on, are remote controllers.

For the description of Modbus registers and commands, refer to the *Modbus Communication Guides*.

EcoStruxure Power Commission Software

Overview

EcoStruxure™ Power Commission is the new name of EcoReach software.

EcoStruxure Power Commission software helps you to manage a project as part of testing, commissioning, and maintenance phases of the project life cycle. The innovative features in it provide simple ways to configure, test, and commission the smart electrical devices.

EcoStruxure Power Commission software automatically discovers the smart devices and allows you to add the devices for an easy configuration. You can generate comprehensive reports as part of Factory Acceptance Test and Site Acceptance Test to replace your heavy manual work. Additionally, when the panels are under operation, any change of settings made can be easily identified by a yellow highlighter. This indicates the difference between the project and device values, and hence provides a system consistency during the operation and maintenance phase.

EcoStruxure Power Commission software enables the configuration of the following circuit breakers, modules, and accessories:

Circuit breaker ranges	Modules	Accessories
MasterPact MTZ circuit breakers	<ul style="list-style-type: none"> MicroLogic X control unit Communication interface modules: IFM interface, IFE interface, IFE server, and EIFE interface ULP modules: IO module, FDM121 display⁽¹⁾ 	M2C output module
<ul style="list-style-type: none"> MasterPact NT/NW circuit breakers ComPacT NS circuit breakers PowerPacT P- and R-frame circuit breakers 	<ul style="list-style-type: none"> MicroLogic trip units Communication interface modules: BCM module, CCM module, BCM ULP module, IFM interface, IFE interface, IFE server ULP modules: IO module, FDM121 display⁽¹⁾ 	M2C and M6C output modules
<ul style="list-style-type: none"> ComPacT NSX circuit breakers PowerPacT H-, J- and L-frame circuit breakers 	<ul style="list-style-type: none"> MicroLogic trip units Communication interface modules: BSCM module, IFM interface, IFE interface, IFE server ULP modules: IO module, FDM121 display⁽¹⁾ 	SDTAM and SDx output modules
⁽¹⁾ For FDM121 display, only the firmware and language download are supported.		

For more information, refer to the *EcoStruxure Power Commission Online Help*.

EcoStruxure Power Commission software is available at www.se.com

Key Features

EcoStruxure Power Commission software performs the following actions for the supported devices and modules:

- Create projects by device discovery
- Save the project in the EcoStruxure Power Commission cloud for reference
- Upload settings to the device and download settings from the device
- Compare the settings between the project and the device
- Perform control actions in a secured way
- Generate and print the device settings report
- Perform a communication wiring test on the entire project and generate and print test report
- View the communication architecture between the devices in a graphical representation
- View the measurements, logs, and maintenance information
- Export Waveform Capture on Trip Event (WFC)
- View the status of device and IO module
- View the alarm details
- Buy, install, remove, or retrieve the Digital Modules
- Check the system firmware compatibility status
- Update to the latest device firmware
- Perform force trip and automatic trip curve tests

IFM Interface Presentation

What's in This Chapter

Introduction.....	20
Hardware Description	21
Schematics with MasterPact MTZ Circuit Breakers	25
Configuration	27
Communication Test.....	28

Introduction

Overview

The IFM Modbus-SL interface for one circuit breaker enables an intelligent modular unit (IMU) with a ComPacT, PowerPacT or MasterPact circuit breaker, to be connected to a two-wire Modbus-SL RS-485 serial line Modbus network. Each circuit breaker has its own IFM interface and a corresponding Modbus address.

Types of IFM Interface

The part number of the IFM interface is LV434000. The IFM interface part number LV434000 completely replaces the IFM interface with part number TRV00210 or STRV00210.

NOTE:

- The IFM interface data for the IFM interface with part number LV434000 is the same as for the IFM interface with part number TRV00210 or STRV00210.
- The IFM interfaces with part number TRV00210 or STRV00210 are not compatible with MasterPact MTZ circuit breakers.

IFM Interface Features

The main features of IFM interface are:

- Single Modbus serial line interface provided in
 - RJ45 connector interface
 - Stacking connection interface
- HMI rotary dials for address settings and padlock option
- Pushbutton for test functionality

Hardware Description

General Description

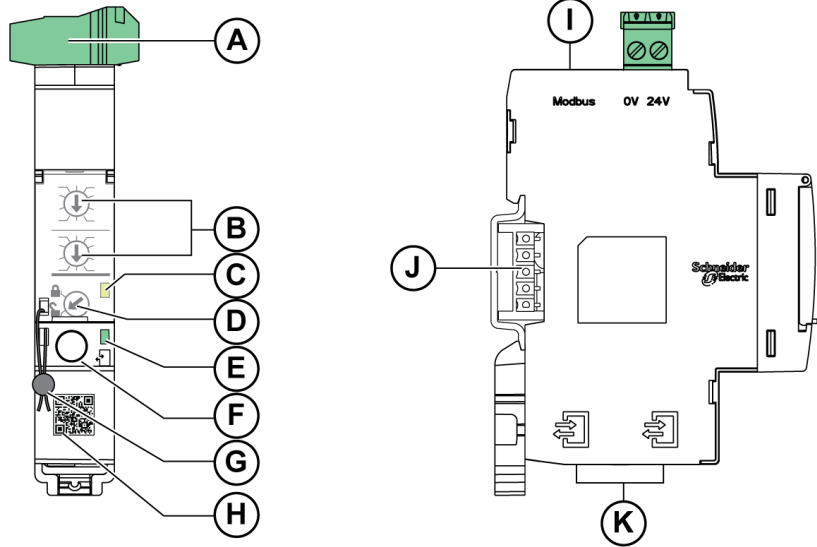

- A 24 Vdc power supply terminal block
- B Modbus address rotary switches
- C Modbus traffic status LED
- D Modbus locking pad
- E ULP status LED
- F Test button
- G Mechanical lock
- H QR code to product information
- I RJ45 Modbus-SL port
- J Stacking accessory connection (TRV00217, optional)
- K 2 RJ45 ULP ports

For more information on installation, refer to [NVE85393 IFM – Modbus-SL Interface for One Circuit Breaker – Instruction Sheet](#).

Mounting

The IFM interface is a DIN rail mounting device. The stacking accessory enables the interconnection of several IFM interfaces without additional wiring.

24 Vdc Power Supply

The IFM interface must always be supplied with 24 Vdc:

- IFM interfaces stacked to an IFE server are supplied by the IFE server and it is not necessary to supply them separately.
- If IFM interfaces are stacked without IFE server, only one of the IFM interfaces must be supplied with 24 Vdc.
- A single IFM interface must be supplied with 24 Vdc.

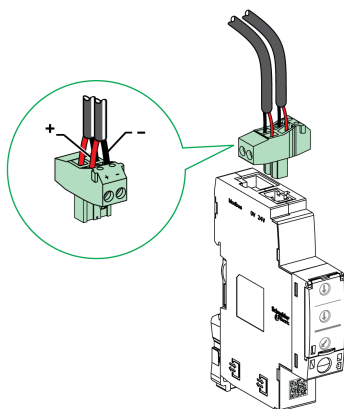

It is recommended to use an UL listed/UL recognized limited voltage/limited current or a class 2 power supply with a 24 Vdc, 3 A maximum.

NOTE: For 24 Vdc power supply connection, use copper conductors only.

Modbus Address Rotary Switches

The IFM interface bears the Modbus address of the IMU to which it is connected. See the *ULP System User Guide* for more information regarding the IMU.

Define the Modbus address using the two address rotary switches on the front panel of the IFM interface.

The address range is 1 to 99. Do not to use the address 0, because it is reserved for broadcasting commands.

The IFM interface is initially configured with address 99.

Example of the configuration of the address rotary switches for address 21:

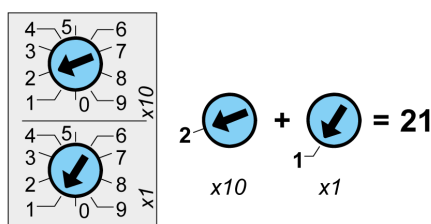

Modbus Traffic Status LED

The Modbus traffic status LED provides information about the traffic transmitted or received by the IMU over the Modbus network.

- When the Modbus address rotary switches are on value 0, the yellow LED is steady ON.
- When the Modbus address rotary switches are on value anywhere from 1 to 99, the yellow LED is ON during the transmission and reception of messages, OFF otherwise.

Modbus Locking Pad

The Modbus locking pad on the front panel of the IFM interface enables or disables remote control commands to be sent over the Modbus network to the IFM interface itself, and to the other modules of the IMU.

- If the arrow points to the open padlock (factory setting), remote control commands are enabled.

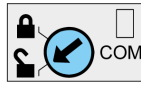

- If the arrow points to the closed padlock, remote control commands are disabled.



The only remote control commands that are enabled even if the arrow points to the closed padlock are the Set Absolute Time (refer to Set Absolute Time, page 262) and Get Current Time (refer to Get Current Time, page 262) commands.

NOTE: For, IFM interface slaves connected to an IFE Ethernet switchboard server, the locking pad of the IFE interface does not disable the remote control commands in IFM interface.

Test Button

The test button tests the connection between all the ULP modules connected to the IFM interface.





Pressing the test button launches the connection test for 15 seconds.

During the test, all the ULP modules keep working normally.

ULP Status LED

The yellow ULP status LED describes the mode of the ULP module.

ULP status LED	Mode	Action
	Nominal	None
	Conflict	Remove extra ULP module
	Degraded	Replace IFM at the next maintenance operation
	Test	None
	Non-critical firmware discrepancy	Use EcoStruxure Power Commission software to check the firmware and hardware compatibility and follow the recommended actions.
	Non-critical hardware discrepancy	
	Configuration discrepancy	Install missing features

ULP status LED	Mode	Action
	Critical firmware discrepancy	Use EcoStruxure Power Commission software to check the firmware and hardware compatibility and follow the recommended actions.
	Critical hardware discrepancy	
	Stop	Replace IFM.
	Power off	Check power supply

Schematics with MasterPact MTZ Circuit Breakers

Description

The IFM interface is connected to the MasterPact MTZ circuit breaker through its ULP port module.

For more information, refer to [DOCA0093EN](#) ULP (Universal Logic Plug) System for ComPact and MasterPact Circuit Breakers – User Guide.

ULP Connection

NOTICE

HAZARD OF EQUIPMENT DAMAGE

- Never connect a Modbus-SL device to an RJ45 ULP port.
- The RJ45 ULP ports of IFM interface are for ULP modules only.
- Any other use can damage the IFM interface or the device connected to the IFM interface.
- To check if an ULP module is compatible with the RJ45 ULP ports of IFM interface, refer to [DOCA0093EN](#) ULP (Universal Logic Plug) System for ComPact and MasterPact Circuit Breakers – User Guide.

Failure to follow these instructions can result in equipment damage.

All the connection configurations require the RJ45 ULP cord.

When the second RJ45 ULP port is not used, it must be closed with an ULP line termination.

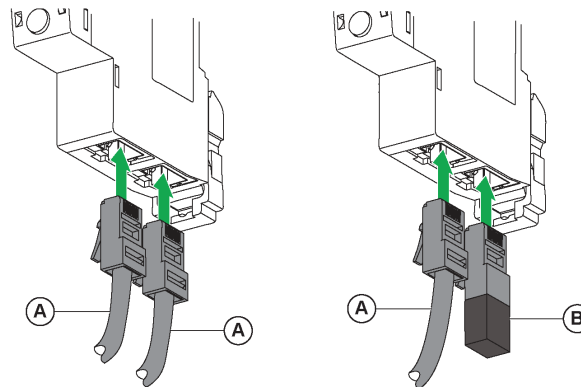

A RJ45 ULP cord

B ULP line termination

Connection of the IFM Interface to a MasterPact MTZ Circuit Breaker

Connect the IFM interface to the ULP port module on a MasterPact MTZ circuit breaker by using the ULP cord.

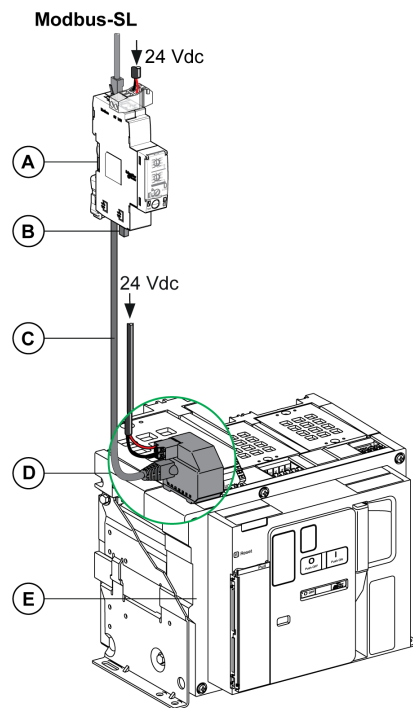

- A IFM Modbus-SL interface for one circuit breaker
- B ULP line termination
- C RJ45 ULP cord
- D ULP port module
- E MasterPact MTZ fixed circuit breaker

Configuration

General Description

Two configurations of the IFM interface are available:

- Automatic configuration (Auto-Speed sensing ON, factory setting): when connected to the Modbus network, the IFM interface automatically detects the network parameters.
- Personalized configuration (Auto-Speed sensing OFF): the user can personalize the network parameters using the EcoStruxure Power Commission software, page 18.

Automatic Configuration

The Modbus slave address is defined by the two address rotary switches on the front panel of the IFM interface. When connected to the Modbus serial line network, the IFM interface automatically detects the network speed and parity. The Auto-Speed sensing algorithm tests the available Baud rates and parities and automatically detects the Modbus communication network parameters. The Modbus master must send at least 25 frames on the Modbus network in order to allow the Auto-Speed sensing algorithm to work.

The transmission format is binary with one start bit, eight data bits, one stop bit in case of even or odd parity, and two stop bits in case of no parity.

If the Auto-Speed sensing algorithm does not detect the network parameters, it is recommended to follow this procedure:

Step	Action
1	Set up the IFM interface to Modbus address 1, page 22.
2	Send a Read Multiple Register request (function code 0x03) to slave 1, at any address and for any number of registers.
3	Send this request at least 25 times.

NOTE: If the network speed or parity is changed after the IFM interface has automatically detected these settings, the IFM interface must be restarted (power off/power on) in order to detect the new network parameters.

Personalized Configuration

The Modbus slave address is defined by the two address rotary switches on the front panel of the IFM interface.

Disable the Auto-Speed sensing option and set the following Modbus communication network parameters with the EcoStruxure Power Commission software, page 18:

- Baud rate: 4800, 9600, 19200, and 38400 Baud.
- parity: even, odd, and none (it is possible to select one stop bit or two stop bits in case of no parity).

NOTE: It is not possible to change the Modbus address or the status of the locking pad with the EcoStruxure Power Commission software.

Communication Test

Introduction

The use of the *EcoStruxure Power Commission* software, page 18 is recommended to test the serial line communication on the various circuit breakers.

If the laptop or PC installed with the *EcoStruxure Power Commission* software and connected on the Modbus network is able to read data from the IMU, the communication is established. Refer to the *EcoStruxure Power Commission Online Help*.

IFE Interface

What's in This Chapter

Introduction.....	30
Hardware Description	31
Schematics with MasterPact MTZ Circuit Breakers	35

Introduction

Overview

The IFE interface enables an intelligent modular unit (IMU) with a ComPacT, PowerPacT or MasterPact circuit breaker to be connected to an Ethernet network. Each circuit breaker has its own IFE interface and a corresponding IP address.

Types of IFE Interface

There are two types of the IFE interface:

- IFE Ethernet interface for one circuit breaker, with part number LV434001

This type of IFE interface is an Ethernet interface for ComPacT, PowerPacT and MasterPact circuit breakers.

NOTE: The IFE interface with part number LV434001 completely replaces the IFE interface with part number LV434010. The LV434001 comes with the real time clock (RTC) feature and allows ULP connections up to 20 m (65.6 ft) with the MasterPact MTZ circuit breakers (LV434010 had a theoretical limitation of 5 m (16.4 ft) over the life of the IFE interface).

- IFE Ethernet switchboard server, with part number LV434002

This type of IFE interface is an Ethernet interface for ComPacT, PowerPacT, and MasterPact circuit breakers and a server for Modbus-SL (serial line) connected devices.

NOTE: The IFE server with part number LV434002 completely replaces the IFE server with part number LV434011. The LV434002 comes with the real time clock (RTC) feature and allows ULP connections up to 20 m (65.6 ft) with the MasterPact MTZ circuit breakers (LV434011 had a theoretical limitation of 5 m (16.4 ft) over the life of the IFE interface).

IFE Interface Features

The main features of IFE interface are:

- Dual Ethernet port for simple daisy chain connection
- Device profile web service for discovery of the IFE interface on the local area network (LAN)
- ULP compliant for location of the IFE interface in the switchboard
- Ethernet interface for ComPacT, PowerPacT and MasterPact circuit breakers
- Server for Modbus-SL connected devices (only for the IFE server with the part number LV434002)
- Embedded setup webpages
- Embedded monitoring webpages
- Embedded control webpages
- Built-in email alarm notification for circuit breaker connected to IFE interface.

NOTE: The built-in switch of IFE interface does not support the ring topology as it does not have the feature of the loop back protection.

Hardware Description

Description

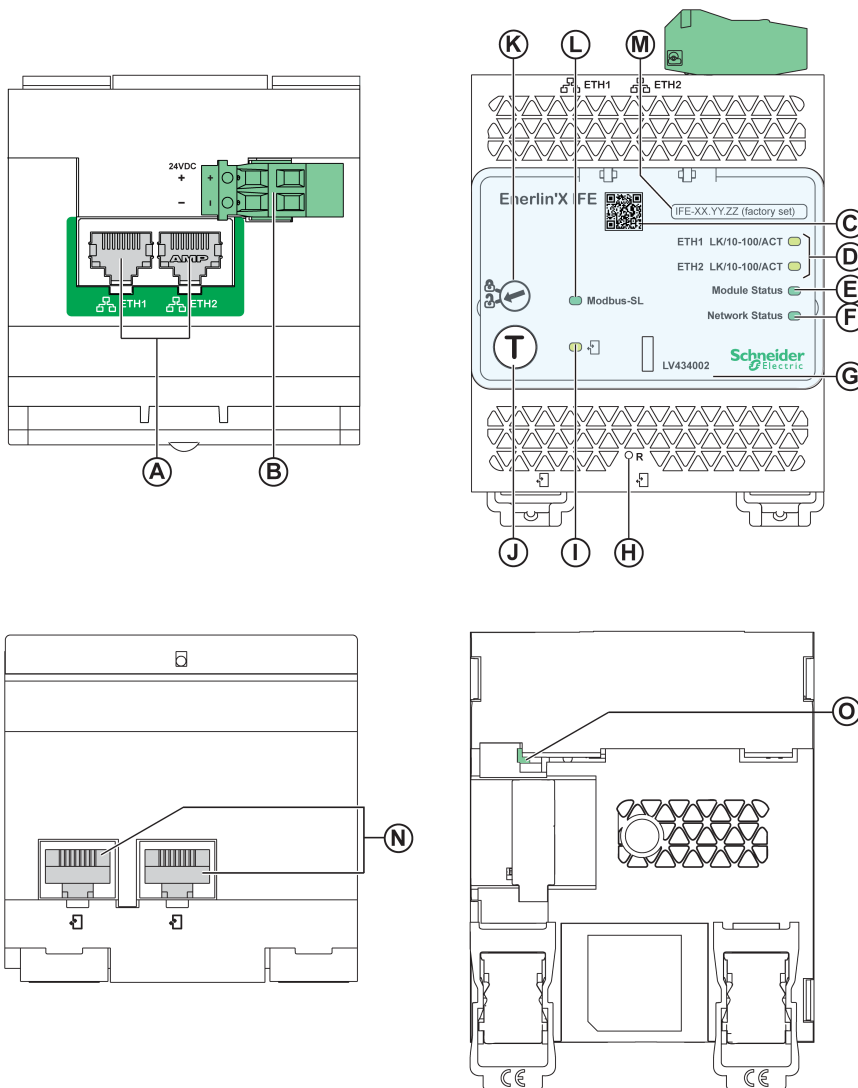

- A** Ethernet 1 and Ethernet 2 RJ45 communication ports
- B** 24 Vdc power supply terminal block
- C** QR code to product information
- D** Ethernet communication LEDs
- E** Module status LED
- F** Network status LED
- G** Sealable transparent cover
- H** Reset button
- I** ULP status LED
- J** Test button (accessible even with closed cover)
- K** Locking pad
- L** Modbus traffic status LED (IFE server only)
- M** Device name label
- N** Two RJ45 ULP ports
- O** Grounding connection

For more information on installation, refer to [QGH13473 IFE – Ethernet Interface / Ethernet Server – Instruction Sheet](#).

Mounting

The IFE interface mounts on a DIN rail. The stacking accessory enables the connection of several IFM interfaces to an IFE server without additional wiring.

NOTE: The stacking feature is available only for the IFE server with the part number LV434002.

24 Vdc Power Supply

The IFE interface must always be supplied with 24 Vdc. The power to the IFM interfaces stacked to an IFE server are supplied by the IFE server and it is not necessary to supply power to them separately.

It is recommended to use an UL listed and recognized limited voltage/limited current or a class 2 power supply with a 24 Vdc, 3 A maximum.

NOTE: For 24 Vdc power supply connection, use copper conductors only.

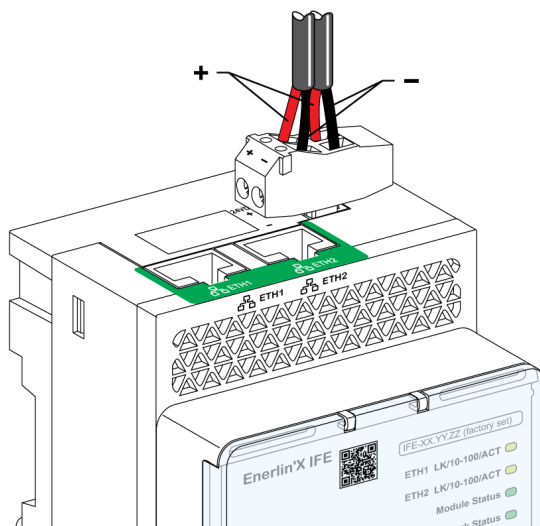

Ethernet Communication LEDs

The Ethernet communication dual color LEDs, indicate the status of the Ethernet ports **ETH1** and **ETH2**.

LED Indication	Status Description
OFF	No power or no link
Steady yellow	10 Mbps, link established, and no activity
Blinking yellow	10 Mbps, ongoing activity
Steady green	100 Mbps, link established, and no activity
Blinking green	100 Mbps, ongoing activity

Module Status LED

The module status dual color LED, indicates the IFE interface status.

LED Indication	Status Description	Action
OFF	No power	None
Steady green	IFE interface operational	None
Blinking green (250 ms ON, 250 ms OFF)	Hidden control webpage available	None
Blinking green (500 ms ON, 500 ms OFF)	IFE interface firmware corrupted	Contact your local Schneider Electric service team for support.
Blinking red (500 ms ON, 500 ms OFF)	IFE interface in degraded mode	Replace ULP module at the next maintenance operation.
Steady red	IFE interface out of service	None
Blinking green/red (1 s green, 1 s red)	Firmware update in progress	None
Blinking green/red (250 ms green, 250 ms red)	Self-test in progress	None

Network Status LED

The network status dual color LED, indicates the Ethernet network status.

LED Indication	Status Description
OFF	No power or no IP address
Steady green	Valid IP address
Steady red	Duplicated IP address
Blinking green/red (250 ms green, 250 ms red)	Self-test in progress
Steady amber	Error in IP configuration

Modbus Serial Line Traffic LED

The Modbus serial line traffic yellow LED, indicates that the traffic is being transmitted or received over the Modbus serial line network through the IFE server.

The LED is ON during the transmission and reception of the messages. The LED is OFF otherwise.

NOTE: The LED is OFF on the IFE interface (part number LV434001).

Modbus Address

The IFE interface accepts the Modbus address of the IMU to which it is connected.

The Modbus address is 255 and cannot be changed.

Locking Pad

The locking pad on the front panel of the IFE interface enables or disables the ability to send the remote control commands over the Ethernet network to the IFE interface, and to the other modules of the IMU.

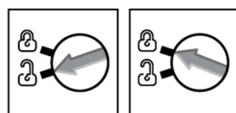

- If the arrow points to the open padlock (factory setting), remote control commands are enabled.
- If the arrow points to the closed padlock, remote control commands are disabled.

The only remote control command that is enabled even if the arrow points to the closed padlock, is the set absolute time command.

Test Button

The test button has two functions, according to the duration of the button pressed.







Time Range	Function
1–5 s	Tests the connection between all the ULP modules for 15 s.
10–15 s	Activates the hidden configuration mode. NOTE: The hidden configuration is not activated if the button is pressed for more than 15 s.

Reset Button

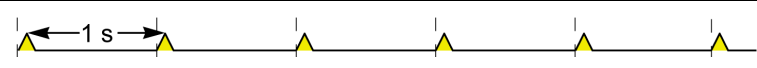
When the reset button is pressed for 1–5 s, it forces the IP acquisition mode to the factory default setting (DHCP).

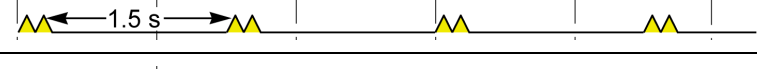
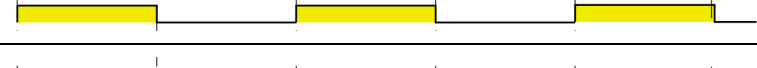
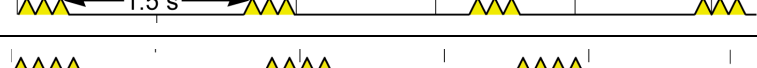
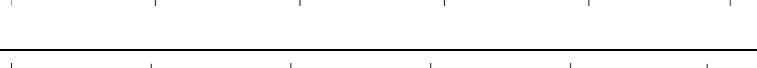
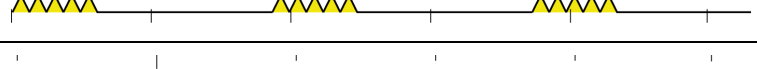
ULP Status LED

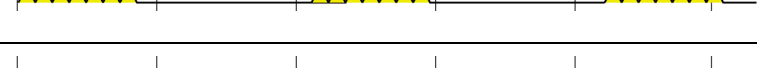
The yellow ULP status LED describes the mode of the ULP module.

ULP LED	Mode	Action
	Nominal	None
	Conflict	Remove extra ULP module
	Degraded	Replace ULP module at the next maintenance operation
	Test	None
	Non-critical firmware discrepancy	Use EcoStruxure Power Commission software to check the firmware and hardware compatibility and follow the recommended actions
	Non-critical hardware discrepancy	
	Configuration discrepancy	Install missing features
	Critical firmware discrepancy	Use EcoStruxure Power Commission software to check the firmware and hardware compatibility and follow the recommended actions
	Critical hardware discrepancy	
	Stop	Replace ULP module
	Power OFF	Check power supply

Schematics with MasterPact MTZ Circuit Breakers

Description

For more information, refer to [DOCA0093EN](#) ULP (Universal Logic Plug) System for ComPact and MasterPact Circuit Breakers – User Guide.

ULP Connection

All the connection configurations require the RJ45 ULP cord.

When the second RJ45 ULP port is not used, it must be closed with an ULP line termination.

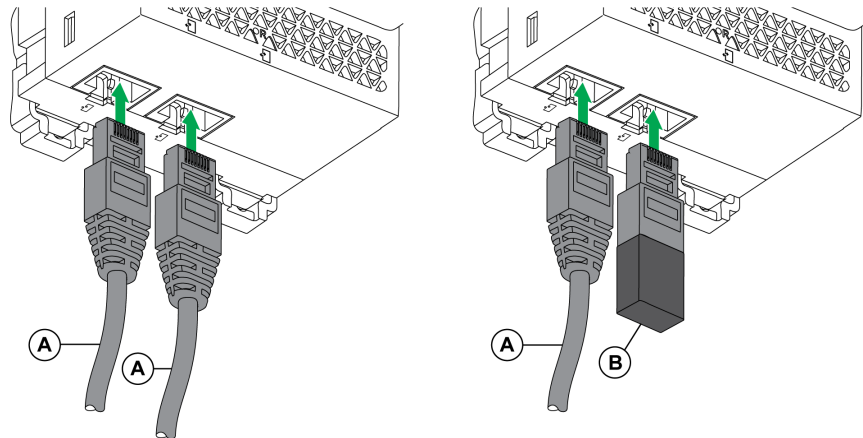

A RJ45 ULP cord

B ULP line termination

EIFE Ethernet Interface for Drawout Circuit Breaker

What's in This Chapter

Introduction.....	36
Hardware Description	37

Introduction

Overview

The EIFE embedded Ethernet interface for one MasterPact™ MTZ drawout circuit breaker (or EIFE interface) enables one MasterPact MTZ drawout circuit breaker to be connected to an Ethernet network.

It provides digital access to all the data delivered by the MicroLogic™ X control unit of the MasterPact MTZ circuit breaker. It provides information about the intelligent modular unit (IMU) system. In addition, it monitors the three positions of the circuit breaker when inserted in its cradle:

- Cradle connected
- Cradle disconnected
- Cradle test position

EIFE Interface Features

The main features of EIFE interface are:

- Dual 10/100 Mbps Ethernet port for simple daisy chain connection
- Device profile web service for discovery of the EIFE interface on the local area network (LAN)
- Ethernet interface for MasterPact MTZ drawout circuit breakers
- Embedded setup webpages
- Embedded monitoring webpages
- Embedded control webpages
- Cradle status management (CE, CD, and CT)
- Built-in email alarm notification
- Network time management (SNTP)

Hardware Description

Description

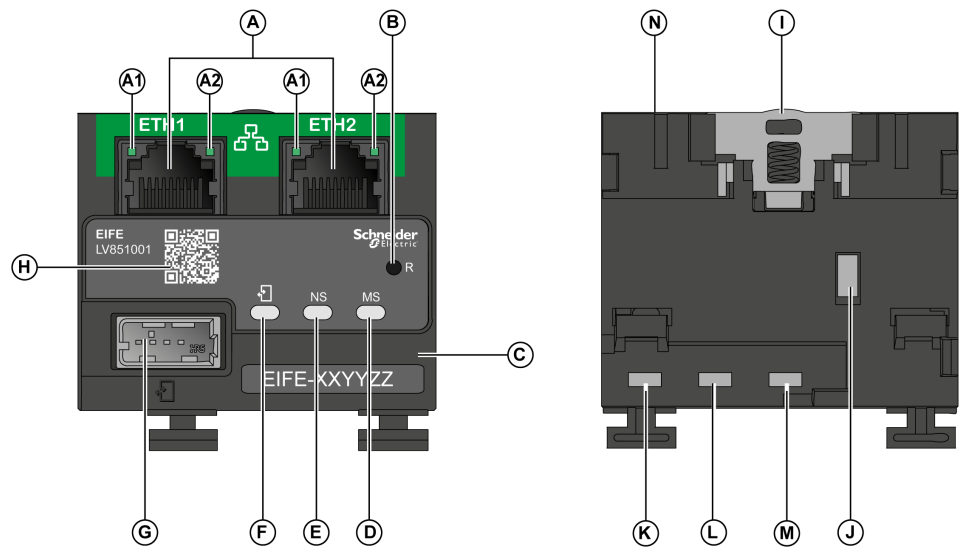

A Two RJ45 Ethernet ports

A1 OFF: 10 Mbps

Steady green: 100 Mbps

A2 Steady green: link

Blinking green: activity

B IP reset button

C Device identification label

D Module status LED

E Network status LED

F ULP status LED

G USB mode ULP port

H QR code to product information

I DIN clip

J Grounding connection

K CT limit switch

L CE limit switch

M CD limit switch

N MAC ID

For more information on installation, refer to [NVE23550 EIFE – Embedded Ethernet Interface for One MasterPact MTZ Drawout Circuit Breaker – Instruction Sheet](#).

Mounting

The EIFE interface is embedded in the cradle of the MasterPact MTZ circuit breaker.

24 Vdc Power Supply

The EIFE interface is powered by the ULP port module.

For more information, refer to [DOCA0093EN ULP \(Universal Logic Plug\) System for ComPact and MasterPact Circuit Breakers – User Guide](#).

It is recommended to use an UL listed and recognized limited voltage/limited current or a class 2 power supply with a 24 Vdc, 3 A maximum.

NOTE: For 24 Vdc power supply connection, use copper conductors only.

Ethernet Connection

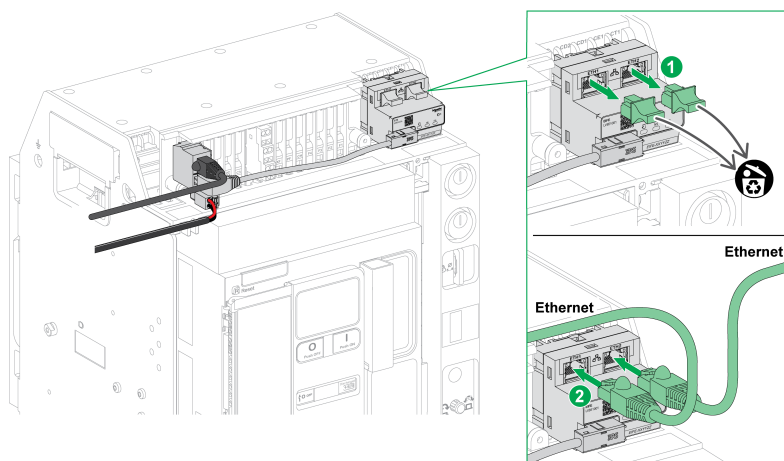

Module Status LED

The module status dual color LED, indicates the EIFE interface status.

LED Indication	Status Description	Action
OFF	No power	None
Steady green	EIFE interface operational	None
Blinking green (250 ms ON, 250 ms OFF)	Hidden control webpage available	None
Blinking green (500 ms ON, 500 ms OFF)	EIFE interface firmware corrupted	Contact your local Schneider Electric service team for support.
Blinking red (500 ms ON, 500 ms OFF)	EIFE interface in degraded mode	Replace ULP module at the next maintenance operation.
Steady red	EIFE interface out of service	None
Blinking green/red (1 s green, 1 s red)	Firmware update in progress	None
Blinking green/red (250 ms green, 250 ms red)	Self-test in progress	None









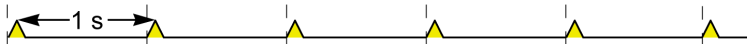

Network Status LED

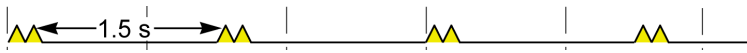
The network status dual color LED, indicates the Ethernet network status.

LED Indication	Status Description
OFF	No power or no IP address
Steady green	Valid IP address
Steady red	Duplicated IP address
Blinking green/red (250 ms green, 250 ms red)	Self-test in progress
Steady amber	Error detected in IP configuration

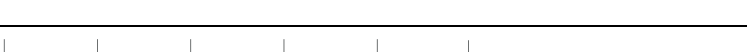
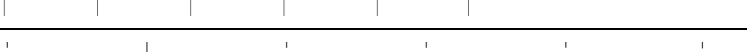
ULP Status LED

The yellow ULP status LED describes the mode of the ULP module.

ULP LED	Mode	Action
	Nominal	None
	Conflict	Remove extra ULP module
	Degraded	Replace EIFE interface at the next maintenance operation
	Test	None
	Non-critical firmware discrepancy	Use the EcoStruxure Power Commission software to check the firmware and hardware compatibility and follow the recommended actions.
	Non-critical hardware discrepancy	
	Configuration discrepancy	Install missing features
	Critical firmware discrepancy	Use the EcoStruxure Power Commission software to check the firmware and hardware compatibility and follow the recommended actions
	Critical hardware discrepancy	
	Stop	Replace EIFE interface
	Power OFF	Check power supply

Modbus Address

The EIFE interface accepts the Modbus address of the IMU to which it is connected.

The Modbus address is 255 and cannot be changed.

Intrusive Command Mode

The EIFE intrusive command mode can be configured with EcoStruxure Power Commission software. This software can enable or disable the ability to send the remote control commands over the Ethernet network to the EIFE interface, and to the other modules of the connected IMU.

- If the intrusive command mode is Locked, the remote control commands are disabled.

- If the intrusive command mode is Unlocked (factory setting), the remote control commands are enabled.

NOTE: Whatever is the intrusive command mode, the only remote control command that is always enabled is the **Set Absolute Time** command.

Reset Button

When the reset button is pressed for 1–5 seconds, it forces the IP acquisition mode to the factory default setting (DHCP).

Cradle Position Contacts

To identify the cradle position of the circuit breaker, the EIFE interface has three limit switches.

Limit Switch	Description
CE	Cradle connected position contact
CD	Cradle disconnected position contact
CT	Cradle test position contact

Modbus Protocol with MasterPact MTZ Circuit Breakers

What's in This Part

Modbus Master/Slave Principle	42
Modbus Programming Recommendations	45
Modbus Functions	47
Modbus Exception Codes	51
Write Protection	53
Password Management	54
Command Interface	56
Command Examples	61
Date Management.....	63
Modbus Registers Tables.....	64

Modbus Master/Slave Principle

Overview

The Modbus protocol exchanges information using a request-reply mechanism between a master (client) and a slave (server). The master/slave principle is a model for a communication protocol in which one device (the master) controls one or more other devices (the slaves). In a standard Modbus network, there is 1 master and up to 31 slaves.

A detailed description of the Modbus protocol is available at www.modbus.org.

Characteristics of the Master/Slave Principle

The master/slave principle is characterized as follows:

- Only 1 master is connected to the network at the same time.
- Only the master can initiate communication and send requests to the slaves.
- The master can address each slave individually using its specific address or all slaves simultaneously using address 0.
- The slaves can only send replies to the master.
- The slaves cannot initiate communication, neither to the master nor to other slaves.

Master/Slave Communication Modes

The Modbus protocol can exchange information using 2 communication modes:

- unicast mode
- broadcast mode

Unicast Mode

In unicast mode, the master addresses a slave using the specific address of the slave. The slave processes the request then replies to the master.

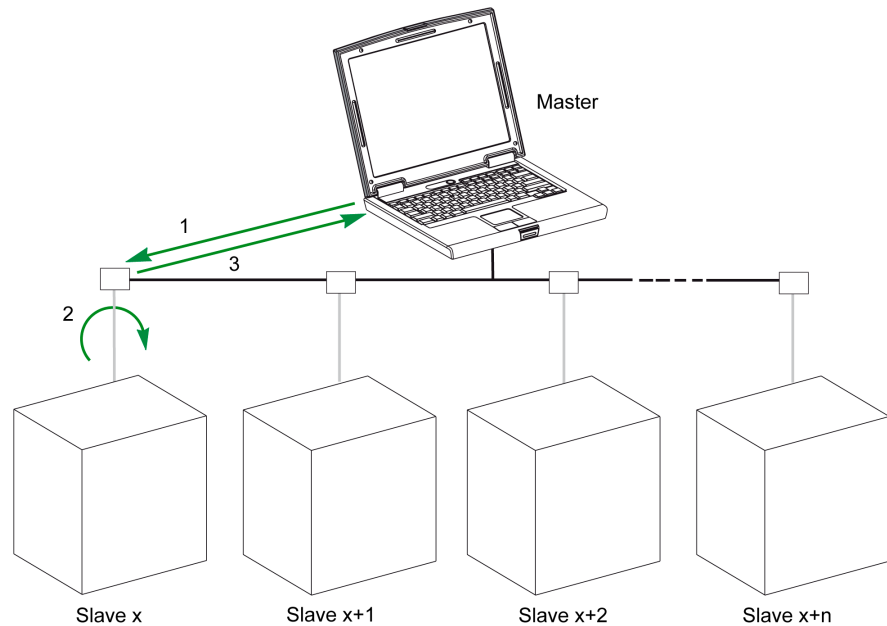

1 Request

2 Process

3 Reply

Broadcast Mode

The master can also address all slaves using address 0. This type of exchange is called broadcasting. The slaves do not reply to broadcasting messages.

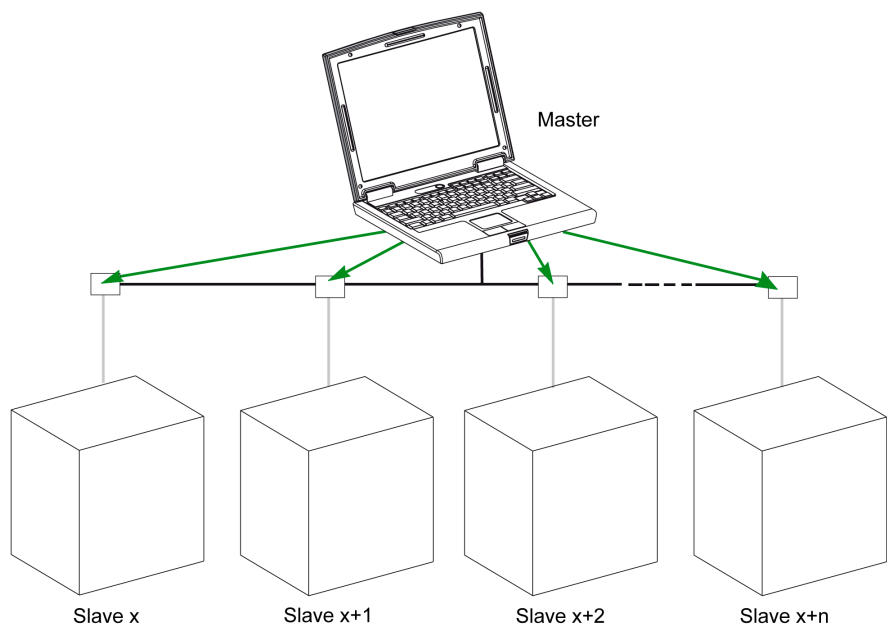

Response Time

The response time T_r is the time needed by a slave to respond to a request sent by the master:

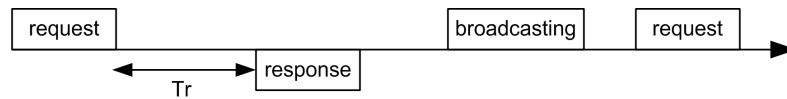

Values with the Modbus protocol:

- Typical value < 10 ms for 90% of the exchanges
- Maximum value is around 700 ms, so it is recommended to implement a 1 second time out after sending a Modbus request.

Data Exchange

The Modbus protocol uses 2 types of data:

- Single bit
- Register (16 bits)

MasterPact MTZ circuit breakers support registers only.

Each register has a register number. Each type of data (bit or register) has a 16-bit address.

The messages exchanged with the Modbus protocol contain the address of the data to be processed.

Registers and Addresses

The address of register number n is $n-1$. The tables detailed in the following parts of this document provide both register numbers (in decimal format) and corresponding addresses (in hexadecimal format). For example, the address of register number 12000 is 0x2EDF (11999).

Frames

All the frames exchanged with the Modbus protocol have a maximum size of 256 bytes and are composed of 4 fields:

Field	Definition	Size	Description
1	Slave number	1 byte	Destination of the request <ul style="list-style-type: none"> • 0: Broadcasting (all slaves concerned) • 1–247: Unique destination • 248–255: Reserved
2	Function codes	1 byte	Refer to function codes description, page 47
3	Data	n registers	Request or reply data
4	CRC error checking	2 bytes	CRC16 (to check the content of the entire transmission message)

Modbus Programming Recommendations

Read Register Recommendations

The registers of the IMU modules are available through Modbus communication in:

- dataset registers (standard and/or legacy datasets)
- device registers:
 - MicroLogic control unit of trip unit registers
 - IO module registers
 - IFM interface registers
 - IFE/EIFE interface registers

To read the registers:

- First read the registers that are available in datasets.
 - Standard dataset is recommended because it contains more data in a data format that allows a better accuracy.
 - Legacy dataset is used only for legacy equipments.
- Then read the data that is not available in datasets in the device registers.

The benefit of datasets is that the most useful information of each IMU module is collected in one table that can be read with two or three read requests. Each module updates the values in the dataset registers on a regular basis.

The response time of requests to dataset registers is shorter than the response time of requests to device registers. Therefore, it is recommended to read the dataset registers instead of device registers, to improve the overall performance of the communication system.

Register Update

The values in the registers are updated in two different ways:

- The measurement values are updated periodically, with a fixed refreshment rate.
- The other values are updated when the value is changed.

Type of Registers	Register Update
Identification	Triggered by device replacement
Settings	Triggered by setting change
Measurement	Periodically, with fixed refreshment rate
• Real-time measurements	Every 1 s
• Demand values of real-time measurements	Every 1 s
• Harmonic values	Every 3 s
• Energy measurements	Every 5 s
• Peak values of demand values of real-time measurements	Every 5 s
• Minimum and maximum values of real-time measurements	Every 5 s
Maintenance and diagnostic	Triggered by data change
Events	Triggered by event detection
IO status	Triggered by status change

The refreshment rate of values is the same for the dataset registers and the device registers.

Use the refreshment rate to optimize the performance of the communication between the remote controller and the IMU modules.

Modbus Functions

General Description

The Modbus protocol offers a number of functions that are used to read or write data over the Modbus network. The Modbus protocol also offers diagnostic and network-management functions.

Only the Modbus functions handled by the circuit breaker are described here.

Read Functions

The following read functions are available:

Function Code	Subfunction Code	Name	Description
3 (0x03)	–	Read holding registers	Read n output or internal registers
4 (0x04)	–	Read input registers	Read n input registers
43 (0x2B)	14 (0x0E)	Read device identification	Read the identification data of the slave
43 (0x2B)	15 (0x0F)	Get date and time	Read the date and time of the slave

Read Register Example

The following table shows how to read the RMS current on phase 1 (I1) in registers 21037 and 21038. The address of register 21037 is $21037 - 1 = 21036 = 0x522C$. The Modbus address of the Modbus slave is $47 = 0x2F$.

Master Request		Slave Reply	
Field Name	Example	Field Name	Example
Modbus slave address	0x2F	Modbus slave address	0x2F
Function code	0x03	Function code	0x03
Address of the register to read (MSB)	0x52	Data length in bytes	0x04
Address of the register to read (LSB)	0x2C	Register 1 value (MSB)	0x44
Number of registers (MSB)	0x00	Register 1 value (LSB)	0x0A
Number of registers (LSB)	0x02	Register 2 value (MSB)	0xC0
CRC (MSB)	0xXX	Register 2 value (LSB)	0x00
CRC (LSB)	0xXX	CRC (MSB)	0xXX
–		CRC (LSB)	0xXX

The content of registers 21037 and 21038 in FLOAT32 is 0x440AC000. Therefore, the RMS current on phase 1 (I1) is 555.00 A.

Get Date and Time Example

The following table shows how to get the date and time of a Modbus slave. The Modbus address of the Modbus slave is $47 = 0x2F$.

Master Request		Slave Reply	
Field Name	Example	Field Name	Example
Modbus slave address	0x2F	Modbus slave address	0x2F
Function code	0x2B	Function code	0x2B
Subfunction code	0x0F	Subfunction code	0x0F

Master Request		Slave Reply	
Field Name	Example	Field Name	Example
Reserved	0x00	Reserved	0x00
–	–	Date and time	Refer to Data Type: DATETIME, page 66

Set Date and Time Example

The following table shows how to set date and time of a Modbus slave. The Modbus address of the Modbus slave is 47 = 0x2F, the new date is October 2, 2014, and the new time is 2:32:03:500 p.m.

NOTE: Use the broadcast mode (with Modbus slave address = 0) to set the date and time of all Modbus slaves.

Master Request		Slave Reply	
Field Name	Example	Field Name	Example
Modbus slave address	0x2F	Modbus slave address	0x2F
Function code	0x2B	Function code	0x2B
Subfunction code	0x10	Subfunction code	0x10
Reserved1	0x00	Reserved1	0x00
Not used	0x00	Not used	0x00
Year = 2014	0x0E	Year = 2014	0x0E
Month = October	0x0A	Month = October	0x0A
Day Of Month = 2	0x02	Day Of Month = 2	0x02
Hour = 14	0x0E	Hour = 14	0x0E
Minutes = 32	0x20	Minutes = 32	0x20
3 sec. 500 ms	0x0DAC	3 sec. 502 ms	0x0DAE

The normal response is an echo of the request, returned after the date-time has been updated in the remote device. If the date-time structure content is not consistent with a true date-time (that is, an invalid date-time), the value returned in the Date-Time field is set to 0 by the device.

In case of 24 Vdc power loss, the date and time of the Modbus slaves without battery is not refreshed anymore. It is therefore mandatory to set date and time for all Modbus slaves after recovering the 24 Vdc power supply.

Furthermore, due to the clock drift of each Modbus slave, it is mandatory to set date and time for all Modbus slaves periodically. Recommended period is at least every 15 minutes.

Scattered Holding Register Read Function

The scattered holding register read function is available:

Function Code	Subfunction Code	Name	Description
100 (0x64)	4 (0x04)	Read scattered holding register	Read n non-contiguous registers

The maximum value for n is 100.

The scattered holding register read function enables the user to:

- avoid reading a large block of contiguous registers when only few registers are needed
- avoid multiple use of functions 3 and 4 in order to read non-contiguous registers

Scattered Holding Register Read Example

The following table shows how to read the addresses of the register 664 (address 0x0297) and register 666 (address 0x0299) of a Modbus slave. The Modbus address of the Modbus slave is 47 = 0x2F.

Master Request		Slave Reply	
Field Name	Example	Field Name	Example
Modbus slave address	0x2F	Modbus slave address	0x2F
Function code	0x64	Function code	0x64
Data length in bytes	0x06	Data length in bytes	0x06
Subfunction code	0x04	Subfunction code	0x04
Transmission number ⁽¹⁾	0xXX	Transmission number ⁽¹⁾	0xXX
Address of first register to read (MSB)	0x02	Value of the first register read (MSB)	0x12
Address of first register to read (LSB)	0x97	Value of the first register read (LSB)	0x0A
Address of second register to read (MSB)	0x02	Value of the second register read (MSB)	0x74
Address of second register to read (LSB)	0x99	Value of the second register read (LSB)	0x0C
CRC (MSB)	0xXX	CRC (MSB)	0xXX
CRC (LSB)	0xXX	CRC (LSB)	0xXX

(1) The master gives the transmission number in the request. The slave returns the same number in the reply.

Write Functions

The following write functions are available:

Function Code	Subfunction Code	Name	Description
6 (0x06)	–	Preset single register	Write 1 register
16 (0x10)	–	Preset multiple registers	Write n registers
43 (0x2B)	16 (0x10)	Set date and time	Write the date and time of the slave

Diagnostic Functions

The following diagnostic functions are available:

Function Code	Subfunction Code (2 bytes)	Name	Description
8 (0x08)	10 (0x000A)	Clear counters and diagnostic register	Reset all diagnostic counters
8 (0x08)	11 (0x000B)	Return bus message counter	Read the counter of correct bus messages managed by the slave
8 (0x08)	12 (0x000C)	Return bus communication error counter	Read the counter of incorrect bus messages managed by the slave
8 (0x08)	13 (0x000D)	Return bus exception error counter	Read the counter of exception responses managed by the slave
8 (0x08)	14 (0x000E)	Return slave message counter	Read the counter of messages sent to the slave
8 (0x08)	15 (0x000F)	Return slave no response counter	Read the counter of broadcast messages
8 (0x08)	16 (0x0010)	Return slave negative acknowledge counter	Read the counter of messages sent to the slave but not answered because of the Negative Acknowledge exception code 07
8 (0x08)	17 (0x0011)	Return slave busy counter	Read the counter of messages sent to the slave but not answered because of the Slave Device Busy exception code 06

Function Code	Subfunction Code (2 bytes)	Name	Description
8 (0x08)	18 (0x0012)	Return bus overrun counter	Read the counter of incorrect bus messages due to overrun errors
11 (0x0B)	–	Get communication event counter	Read Modbus event counter

Diagnostic Counters

Modbus uses diagnostic counters to enable performance and error management. The counters are accessible using the Modbus diagnostic functions (function codes 8 and 11). The Modbus diagnostic counters and the Modbus event counter are described in the following table:

Counter Number	Counter Name	Description
1	Bus message counter	Counter of correct bus messages managed by the slave
2	Bus communication error counter	Counter of incorrect bus messages managed by the slave
3	Slave exception error counter	Counter of exception responses managed by the slave and incorrect broadcast messages
4	Slave message counter	Counter of messages sent to the slave
5	Slave no response counter	Counter of broadcast messages
6	Slave negative acknowledge counter	Counter of messages sent to the slave but not answered because of the Negative Acknowledge exception code 07
7	Slave busy count	Counter of messages sent to the slave but not answered because of the Slave Device Busy exception code 06
8	Bus character overrun counter	Counter of incorrect bus messages due to overrun errors
9	Comm. event counter	Modbus event counter (this counter is read with function code 11)

Counters Reset

The diagnostic counters are reset to 0 when:

- the maximum value 65535 is reached
- they are reset by a Modbus command (function code 8, sub-function code 10)
- the power supply is lost
- the communication parameters are modified.

Modbus Exception Codes

Exception Responses

Exception responses from either the master (client) or a slave (server) can result from data processing errors. One of the following events can occur after a request from the master (client):

- If the slave (server) receives the request without a communication error and can handle the request correctly, it will return a normal response.
- If the slave (server) does not receive the request due to a communication error, it will not return any response. The master program will eventually process a timeout condition for the request.
- If the slave (server) receives the request but detects a communication error, it will not return a response. The master program will eventually processes a timeout condition for the request.
- If the slave (server) receives the request without a communication error, but cannot handle it correctly (for example, the request is to read a register that does not exist), the slave will return an exception response to inform the master of the nature of the error.

Exception Frame

The slave (server) sends an exception frame to the master (client) to report an exception response. An exception frame is composed of 4 fields:

Field	Definition	Size	Description
1	Slave number	1 byte	Destination of the request <ul style="list-style-type: none"> • 1–247: Unique destination
2	Exception function code	1 byte	Request function code + 128 (0x80)
3	Exception code	n bytes	See next paragraph
4	CRC error checking	2 bytes	CRC16 (to check the content of the entire transmission messages)

Exception Codes

The exception response frame has two fields that differentiate it from a normal response frame:

- The exception function code of the exception response is equal to the function code of the original request plus 128 (0x80).
- The exception code depends on the communication error that the slave (server) encounters.

The following table describes the exception codes handled by the circuit breaker:

Exception Code	Name	Description
01 (0x01)	Illegal function	The function code received in the request is not an authorized action for the slave. The slave may be in the wrong state to process a specific request.
02 (0x02)	Illegal data address	The data address received by the slave is not an authorized address for the slave.
03 (0x03)	Illegal data value	The value in the request data field is not an authorized value for the slave.
04 (0x04)	Slave device failure	The slave fails to perform a requested action because of an unrecoverable error.
05 (0x05)	Acknowledge	The slave accepts the request but needs a long time to process it.
06 (0x06)	Slave device busy	The slave is busy processing another command. The master must send the request once the slave is available.
07 (0x07)	Negative acknowledgment	The slave cannot perform the programming request sent by the master.

Exception Code	Name	Description
08 (0x08)	Memory parity error	The slave detects a parity error in the memory when attempting to read extended memory.
10 (0x0A)	Gateway path unavailable	The gateway is overloaded or not correctly configured.
11 (0x0B)	Gateway target device failed to respond	The slave is not present on the network.

Illegal Data Address

The guide describes the registers available for each IMU module with the latest firmware version. When a register described in the guide is not implemented in an IMU module that has an old firmware version, an exception response is returned with the exception code 02 (0x02), illegal data address.

You can update the firmware of the IMU modules by using the EcoStruxure Power Commission software.

Write Protection

General Description

▲ WARNING

HAZARD OF NUISANCE TRIPPING OR FAILURE TO TRIP

Protection setting adjustments must be done by qualified electrical personnel.

Failure to follow these instructions can result in death, serious injury, or equipment damage.

Remote modifications of Modbus registers can either be dangerous to personnel near the circuit breaker or can cause equipment damage if the protection settings are altered. Therefore, remote control commands are protected by password or by configuration, page 56.

Software Protection

To prevent an inadvertent change to the MicroLogic configuration, remote modifications of the Modbus registers are protected by both of the following:

- a robust data structure and a set of dedicated Modbus registers
- a user profile password scheme

This combination is called the command interface. Failure to conform to these results in an error code and the operation is not performed. The hardware protection has always precedence over the software protection.

Password Management

General Description

Remote access to data on MicroLogic control units and the ULP modules of the IMU is protected by password. Remote access includes:

- EcoStruxure Power Commission software
- The communication network
- EcoStruxure Power Device App
- FDM128 display
- IFE/EIFE webpages

The following four profiles are defined for remote access. Each IMU has a different password for each user profile.

- Administrator
- Services
- Engineer
- Operator

The Administrator password is required to write the settings to the MicroLogic control unit and the ULP modules of the IMU using the EcoStruxure Power Commission Software, page 18.

Each intrusive command via the command interface is assigned to one or several user profiles, and protected by the corresponding user profile password. The password for each intrusive command is indicated in the description of the command.

No password is required for non-intrusive commands through the command interface.

Default Passwords

WARNING

POTENTIAL COMPROMISE OF SYSTEM AVAILABILITY, INTEGRITY, AND CONFIDENTIALITY

Change default passwords at first use to help prevent unauthorized access to device settings, controls, and information.

Failure to follow these instructions can result in death, serious injury, or equipment damage.

The default password for each user profile is as follows:

User profile	Default password
Administrator	'0000' = 0x30303030
Services	'1111' = 0x31313131
Engineer	'2222' = 0x32323232
Operator	'3333' = 0x33333333

Changing a Password

A password can be changed with the EcoStruxure Power Commission software, page 18.

Entering the current password for a given user profile is required to change the password of this user profile. Entering the Administrator password enables you to change the password of any user profile.

A password is composed of exactly 4 ASCII characters. It is case-sensitive and the allowed characters are:

- Digits from 0 to 9
- Letters from a to z
- Letters from A to Z

Passwords of the IMU

The MicroLogic control unit and the ULP modules of the IMU must be protected by the same passwords for each user profile.

When using EcoStruxure Power Commission software to modify a password, the password gets modified in the MicroLogic control unit and the ULP modules of the IMU.

It is compulsory to assign the current IMU passwords to the new module in the IMU, in case of:

- addition of a new ULP module in the IMU.
- replacement of the MicroLogic control unit or one of the ULP module of the IMU.

Use EcoStruxure Power Commission software to modify the passwords of the new module to the current IMU passwords.

Example: Addition of an IO module in an IMU with a MicroLogic control unit and an IFE interface.

- The IMU has user-defined passwords for each user profile.
- The IO module has the default passwords for each user profile.

Use EcoStruxure Power Commission software to replace the default passwords of the IO module by the user-defined passwords of the IMU for each user profile.

Password Reset

In case that the Administrator password of the (IMU) is lost or forgotten, the password can be reset to the default password with EcoStruxure Power Commission software, page 18 and the support of the Schneider Electric Customer Care Center.

Command Interface

General Description

The command interface is used to:

- send remote commands
- send remote control commands

Remote commands are non-intrusive commands. They are not password-protected and always enabled.

Remote control commands are intrusive commands and can either be dangerous to personnel near the circuit breaker or can cause equipment damage if the protection settings are altered. Therefore, remote control commands are:

- protected by password where a password is required in the command
- protected by configuration:
 - with the IFM interface, the remote control commands are enabled when the locking pad on the IFM interface is in the open position.
 - with the IFE interface, the remote control commands are enabled when the locking pad on the IFE interface is in the open position.
 - with the EIFE interface, the remote control commands are enabled when the intrusive command mode is unlocked by EIFE configuration using the EcoStruxure Power Commission software, page 18.

Each command has a specific code. For example, command code 904 defines the command to open the circuit breaker.

Executing a Command

Follow these steps to execute a command:

Step	Action
1	Load a buffer.
2	Write this buffer with a write request (Modbus function 16) starting at register 8000.
3	Read the command status register 8021, and wait while its content shows that the command is still in progress (0x0003).
4	Read the command code register 8020: <ul style="list-style-type: none"> • If content of register 8020 is the command code entered in register 8000 at step 2, go to next step. • If content of register 8020 is different from the command code entered in register 8000 at step 2, restart at step 1.
5	Read the error code in the LSB of register 8021: <ul style="list-style-type: none"> • If LSB ≠ 0, then the command failed. Check the error code to understand the cause (see next paragraph). For example, if register 8021 returns 4609 (0x1201), then the error code is 1, which means that the password is not correct (insufficient user rights). • If LSB = 0, then the command is executed with no errors.

NOTE: The Modbus application will wait for the complete execution of one command before sending its next command. In case of no response, the Modbus application can resend the command. In this case, the first command will be aborted automatically.

Command Diagram

The following diagram shows the steps to follow in order to execute a command:

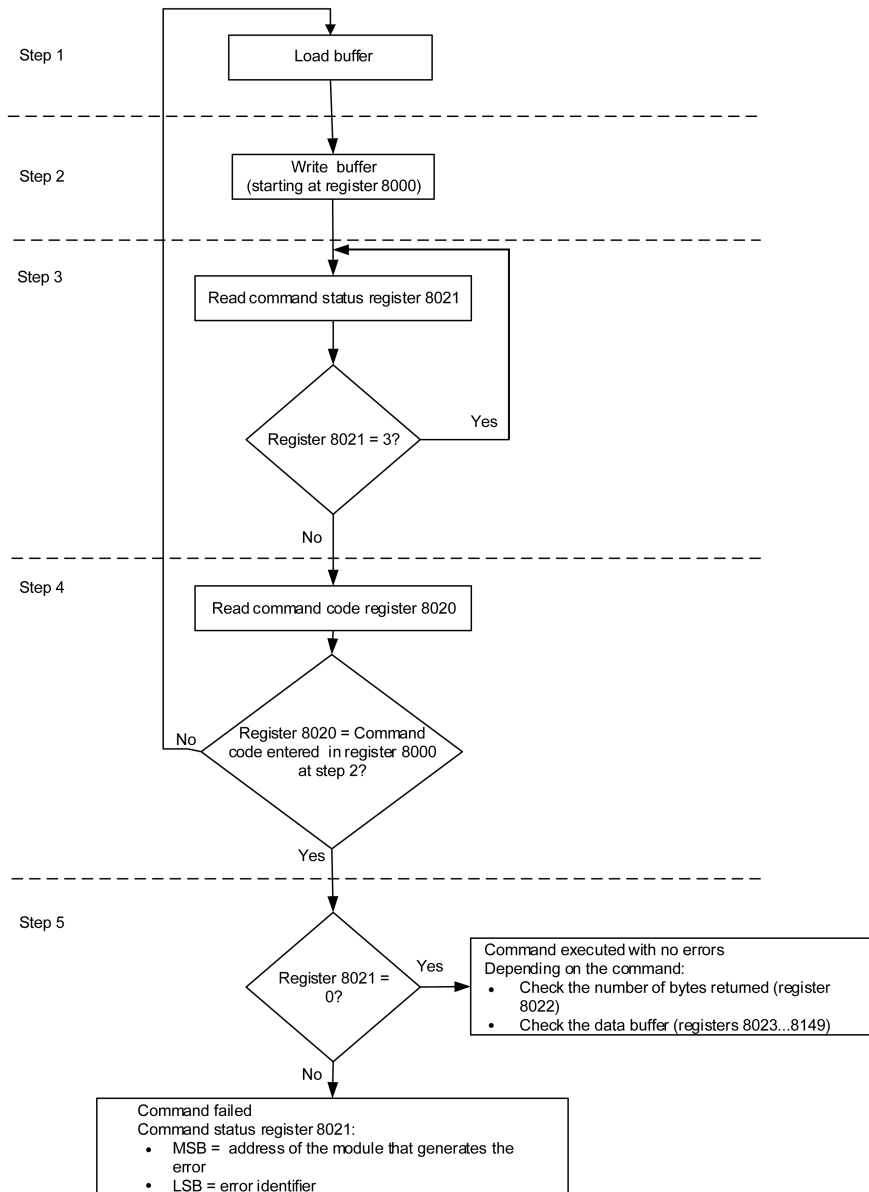

Command Data Structure

The command interface uses registers 8000 to 8149:

- The input parameters of a command are written in registers 8000 to 8015. The registers 8016 to 8019 are reserved.
- The data returned after command execution are written in registers 8020 to 8149.

The input parameters of a command are detailed in the following table:

Address	Register	Description	Comments
0x1F3F	8000	Command code	Writing at this register triggers the command using the parameters in the following registers.
0x1F40	8001	Parameter length	Number of bytes used for the parameters including this one (from 10 to 30). This value is provided for each command.
0x1F41	8002	Destination	A constant value provided for each command. Factory setting: 0x0000

Address	Register	Description	Comments
0x1F42	8003	Security type	A constant value provided for each command: <ul style="list-style-type: none"> • 0 for non-intrusive commands not protected by password • 1 for intrusive commands protected by a password
0x1F43	8004	Password	The password is composed of 4 ASCII bytes.
0x1F44	8005		The password to use depends on the command. This information is provided for each command.
0x1F45–0x1F4E	8006–8015	Additional parameters	Additional parameters define how the command is performed. Some commands have no additional parameters.
0x1F4F	8016	Reserved	Must be set to 0 (factory setting).
0x1F50	8017	Reserved	Must be set to 8019 (factory setting).
0x1F51	8018	Reserved	Must be set to 8020 (factory setting).
0x1F52	8019	Reserved	Must be set to 8021 (factory setting).

The data returned after command execution are detailed in the following table:

Address	Register	Description	Comments
0x1F53	8020	Last command code	When the command has been executed, it holds the last command code.
0x1F54	8021	Command status	When the command exits the busy state, it holds the completion code.
0x1F55	8022	Data buffer size	Number of bytes returned.
0x1F56–0x1FD4	8023–8149	Data buffer	Returned values. It is empty if the previous register is 0.

Command Status

When the command is successful, the command status is 0.

When the command is in progress, the command status is 3.

When the command generates an error, the command status register contains:

- LSB: the error code
- MSB: the address of the module that generates the error

Module Returning the Command Result

The following table lists the addresses of the modules:

Module Address	Module
1 (0x01)	UTA maintenance module
2 (0x02)	FDM121 ULP display for one circuit breaker
3 (0x03)	IFM Modbus-SL interface for one circuit breaker
17 (0x11)	BSCM circuit breaker status control module for ComPacT NS
18 (0x12)	BCM ULP circuit breaker communication module for MasterPact NT/NW and ComPacT NS
20 (0x14)	MicroLogic trip unit of ComPacT NS
21 (0x15)	MicroLogic control unit of MasterPact MTZ
32 (0x20)	IO input/output application module 1 for one circuit breaker
33 (0x21)	IO input/output application module 2 for one circuit breaker
34 (0x22)	<ul style="list-style-type: none"> • IFE Ethernet interface for one circuit breaker • IFE Ethernet switchboard server • EIFE embedded Ethernet interface for one MasterPact MTZ circuit breaker

NOTE: The MicroLogic trip units of MasterPact NT/NW and ComPacT NS circuit breakers do not have an IMU module address.

Result of the Command

The following table lists the codes corresponding to the result of the command.

Code	Description
0 (0x00)	Successful command
1 (0x01)	Insufficient user rights (incorrect password)
2 (0x02)	Access violation (IFM locking pad is locked, page 23 or, IFE locking pad is locked, page 33 or intrusive command mode is locked).
3 (0x03)	Unable to perform a read access
4 (0x04)	Unable to perform a write access
5 (0x05)	Unable to execute service (IFM locking pad locked)
6 (0x06)	Not enough memory
7 (0x07)	Allocated memory is too small
8 (0x08)	Resource is not available
9 (0x09)	Resource does not exist
10 (0x0A)	Resource already exists
11 (0x0B)	Resource is out of order
12 (0x0C)	Access out of available memory
13 (0x0D)	String is too long
14 (0x0E)	Buffer is too small
15 (0x0F)	Buffer is too big
16 (0x10)	Input argument is out of range
17 (0x11)	Requested security level is not supported
18 (0x12)	Requested component is not supported
19 (0x13)	Command is not supported
20 (0x14)	Input argument has an unsupported value
21 (0x15)	Internal error during command
22 (0x16)	Timeout during command
23 (0x17)	Checksum error during command
24 (0x18)	Unsupported destination
151 (0x97)	Circuit breaker tripped, reset before commands
152 (0x98)	Circuit breaker already closed
153 (0x99)	Circuit breaker already open
154 (0x9A)	Circuit breaker already reset
155 (0x9B)	Actuator in manual mode
156 (0x9C)	Actuator not present
157 (0x9D)	Bad ASIC configuration
158 (0x9E)	Previous command in progress
159 (0x9F)	Reset command forbidden
160 (0xA0)	Inhibit mode on
169 (0xA9)	Already in asked state

Code	Description
170 (0xAA)	Unable to preset counters
171 (0xAB)	Output command rejected, already assigned
172 (0xAC)	Emitter not allowed to perform the command
173 (0xAD)	Mode not relevant with requested command
174 (0xAE)	Session key is invalid
175 (0xAF)	Out of session scope
176 (0xB0)	Session is already opened
177 (0xB1)	No session is open
178 (0xB2)	No valid setting was submitted
180 (0xB4)	Wireless component not started
190 (0xBE)	Read and get an invalid value
191 (0xBF)	License is not installed

Command Not Supported

The guide describes the commands available for each IMU module with the latest firmware version. When a command described in the guide is not implemented in an IMU module that has an old firmware version, the command status is returned with the error code 19 (0x13), command is not supported.

You can update the firmware of the IMU modules by using the EcoStruxure Power Commission software.

Command Examples

Open Circuit Breaker

The following table details the steps to perform in the master remote device to send a remote control command to open the circuit breaker. The command itself has no parameters.

Step	Action
1	Load a buffer of 20 registers, word0 to word19. <ul style="list-style-type: none"> Load into word0 the value 904, the code corresponding to the open circuit breaker command. Load into word1 the value 10, the length of the input parameters. The command itself has no parameters, 10 is the length of the fixed part. Load into word2 the value 5377 (0x1501), the destination. This value is a constant for the command. It is provided in the command description. Load into word3 the value 1. Load into word4 and word5 the 4 ASCII bytes for the Administrator or Operator password. Assuming this password is 'ABcd', load 16706 (0x4142) into word #4 and 25444 (0x6364) into word #5. Load into word6 to word16 the value 0. Load into word17 the value 8019, a command setup constant. Load into word18 the value 8020, a command setup constant. Load into word19 the value 8021, a command setup constant.
2	Write this buffer with a write request (Modbus function 16) of 20 registers, starting at register 8000.
3	Read the command status register 8021, and wait while its content shows that the command is still in progress (0x0003).
4	Read the command code register 8020: <ul style="list-style-type: none"> If content of register 8020 is the command code entered in register 8000 at step 2, go to next step. If content of register 8020 is different from the command code entered in register 8000 at step 2, restart at step 1.
5	Read the error code in the LSB of register 8021: <ul style="list-style-type: none"> If LSB ≠ 0, then the command failed. Check the error code to understand the cause (see next paragraph). For example, if register 8021 returns 4609 (0x1201), then the error code is 1, which means that the password is not correct (insufficient user rights). If LSB = 0, then the command was executed with no errors.

Reset Energy Measurements

The following table details the steps to perform to send a command to reset the energy measurements, page 176. The command itself has one parameter.

Step	Action
1	Load a buffer of 20 registers, word0 to word19. <ul style="list-style-type: none"> Load into word0 the value 46728, the code corresponding to the reset minimum/maximum command. Load into word1 the value 12, the length of the input parameters. The command itself has one parameter, add 2 bytes to 10 which is the length of the fixed part. Load into word2 the value 5377 (0x1501), the destination. This value is a constant for the command. It is provided in the command description. Load into word3 the value 1. Load into word4 and word5 the 4 ASCII bytes for the Administrator or Operator password. Assuming this password is 'Pw57', load 20599 (0x5077) into word #4 and 13623 (0x3537) into word #5. Load into word6 the value 512 (bit 9 set to one). This value requires all the energy measurements to be reset. Load into word7 to word16 the value 0. Load into word17 the value 8019, a command setup constant. Load into word18 the value 8020, a command setup constant. Load into word19 the value 8021, a command setup constant.
2	Write this buffer with a write request (Modbus function 16) of 20 registers, starting at register 8000.
3	Read the command status register 8021, and wait while its content shows that the command is still in progress (0x0003).

Step	Action
4	Read the command code register 8020: <ul style="list-style-type: none"> If content of register 8020 is the command code entered in register 8000 at step 2, go to next step. If content of register 8020 is different from the command code entered in register 8000 at step 2, restart at step 1.
5	Read the error code in the LSB of register 8021: <ul style="list-style-type: none"> If LSB ≠ 0, then the command failed. Check the error code to understand the cause (see next paragraph). For example, if register 8021 returns 4609 (0x1201), then the error code is 1, which means that the password is not correct (insufficient user rights). If LSB = 0, then the command was executed with no errors.

Read Date and Time

The following table details the steps to perform to send a command to read the date and time, page 187. The command itself has no parameters. The date and time are returned in a buffer.

Step	Action
1	Load a buffer of 20 registers, word0 to word19. <ul style="list-style-type: none"> Load into word0 the value 768, the code corresponding to the read date/time command. Load into word1 the value 10, the length of the input parameters. The command itself has no parameters, the length is the length of the fixed part which is 10. Load into word2 the value 5377 (0x1501), the destination. This value is a constant for the command. It is provided in the command description. Load into word3 the value 0. Load into word4 and word5 the value 0x0000 (no password required). Load into word6 to word16 the value 0. Load into word17 the value 8019, a command setup constant. Load into word18 the value 8020, a command setup constant. Load into word19 the value 8021, a command setup constant.
2	Write this buffer with a write request (Modbus function 16) of 20 registers, starting at register 8000.
3	Read the command status register 8021, and wait while its content shows that the command is still in progress (0x0003).
4	Read the command code register 8020: <ul style="list-style-type: none"> If content of register 8020 is the command code entered in register 8000 at step 2, go to next step. If content of register 8020 is different from the command code entered in register 8000 at step 2, restart at step 1.
5	Read the error code in the LSB of register 8021: <ul style="list-style-type: none"> If LSB ≠ 0, then the command failed. Check the error code to understand the cause (see next paragraph). For example, if register 8021 returns 783 (0x030F), then the error code is 15 (0x0F), which means that the input argument is out of range (too many parameters). If LSB = 0, then the command was executed with no errors.
6	If there were no errors, read the data buffer length in register 8022. Its value must be 8 for this command.
7	In the data buffer: <ul style="list-style-type: none"> register 8023 holds the month in the MSB, the day in the LSB. register 8024 holds the year offset in the MSB (add 2000 to get the year) and the hour in the LSB. register 8025 holds the minutes in the MSB, the seconds in the LSB. register 8026 holds the milliseconds.

Date Management

Introduction

Each module of the IMU uses its date to time-stamp events and history registers.

The date of the IMU modules is updated in two steps:

1. External synchronization: The Modbus master synchronizes the IFM , IFE, or EIFE communication interface.
2. Internal synchronization: The communication interface broadcasts the date and time to the MicroLogic X control unit and the other ULP modules connected in the IMU.

External Synchronization

There are several ways to externally synchronize the IFM , IFE, or EIFE communication interface:

- Manually:
 - With the EcoStruxure Power Commission software, page 18
 - With IFE or EIFE webpage
- By programming of the Modbus master using:
 - either the Modbus function set date and time: function code 43-16 , page 49.
 - or, the interface command set absolute time through the IFM, IFE or EIFE interface.
- Automatically:
 - With IFE or EIFE configured as SNTP mode.

The communication interface is considered as externally synchronized if the last synchronization has occurred within the last 2 hours.

Internal Synchronization

When the IFM, IFE or EIFE communication interface receives the date and time, it will broadcast the date and time to all the ULP modules connected in the IMU.

Modbus Registers Tables

General Description

The following chapters describe the Modbus registers of the MicroLogic control unit and the Modbus registers of the modules connected to it. These registers provide information that can be read, such as electrical measures, and monitoring information. The command interface enables modification of these registers in a controlled way.

The presentation rules of the Modbus registers are as follows:

- For each module, the registers are grouped in tables of logically related information, according to the module they relate to:
 - MicroLogic control unit, page 109
 - IO module, page 216
 - IFM Modbus-SL interface, page 255
 - IFE or EIFE Ethernet interface, page 266
- For some modules, the files are described separately.
- For each module, the commands are described separately:
 - MicroLogic control unit, page 167
 - IO module, page 244
 - IFM Modbus-SL interface, page 261
 - IFE or EIFE Ethernet interface, page 275

To find a register, use the ordered list of the registers with a cross reference to the page where these registers are described.

Table Format

Register tables have the following columns:

Address	Register	RW	Unit	Type	Range	Bit	Description

- **Address:** a 16-bit register address in hexadecimal. The address is the data used in the Modbus frame.
- **Register:** a 16-bit register number in decimal (register = address + 1).
- **RW:** register read-write status
 - R: the register can be read by using Modbus functions
 - W: the register can be written by using Modbus functions
 - RW: the register can be read and written by using Modbus functions
 - RC: the register can be read by using the command interface
 - WC: the register can be written by using the command interface
- **Unit:** the unit the information is expressed in.
- **Type:** the encoding data type (see data type description below).
- **Range:** the permitted values for this variable, usually a subset of what the format allows.
- **Description:** provides information about the register and restrictions that apply.

Data Types

Data Types	Description	Range
INT16U	16-bit unsigned integer	0 to 65535
INT16	16-bit signed integer	-32768 to +32767
INT32U	32-bit unsigned integer	0 to 4 294 967 295
INT32	32-bit signed integer	-2 147 483 648 to +2 147 483 647
INT64U	64-bit unsigned integer	0 to 18 446 744 073 709 600 000
INT64	64-bit signed integer	-9 223 372 036 854 775 808 to +9 223 372 036 854 775 807
FLOAT32	32-bit signed integer with a floating point	$2^{-126} (1.0)$ to $2^{127} (2 - 2^{-23})$
OCTET STRING	Text string	1 byte per character
XDATE	Date and time of ULP modules	–
DATETIME	Date and time in the IEC 60870-5 format	–

Big-Endian Format

INT32, INT32U, INT64, and INT64U variables are stored in big-endian format: the most significant register is transmitted first, the least significant register is transmitted at last place.

INT32, INT32U, INT64, and INT64U variables are made of INT16U variables.

The formulas to calculate the decimal value of these variables are:

- INT32: $(0\text{-bit}31) \times 2^{31} + \text{bit}30 \times 2^{30} + \text{bit}29 \times 2^{29} + \dots + \text{bit}1 \times 2^1 + \text{bit}0 \times 2^0$
- INT32U: $\text{bit}31 \times 2^{31} + \text{bit}30 \times 2^{30} + \text{bit}29 \times 2^{29} + \dots + \text{bit}1 \times 2^1 + \text{bit}0 \times 2^0$
- INT64: $(0\text{-bit}63) \times 2^{63} + \text{bit}62 \times 2^{62} + \text{bit}61 \times 2^{61} + \dots + \text{bit}1 \times 2^1 + \text{bit}0 \times 2^0$
- INT64U: $\text{bit}63 \times 2^{63} + \text{bit}62 \times 2^{62} + \text{bit}61 \times 2^{61} + \dots + \text{bit}1 \times 2^1 + \text{bit}0 \times 2^0$

Example 1:

The total active energy in the standard dataset is an INT64 variable coded in registers 32096 to 32099.

If the values in the registers are:

- register 32096 = 0
- register 32097 = 0
- register 32098 = 0x0017 or 23
- register 32099 = 0x9692 or 38546 as INT16U variable and -26990 as INT16 variable (use the INT16U value to calculate the value of the total active energy).

Then the total active energy is equal to $0 \times 2^{48} + 0 \times 2^{32} + 23 \times 2^{16} + 38546 \times 2^0 = 1545874$ Wh.

Example 2:

The reactive energy in the legacy dataset is an INT32 variable coded in registers 12052 to 12053.

If the values in the registers are:

- register 12052 = 0xFFF2 = $0 \times 8000 + 0 \times 7FF2$ or 32754
- register 12053 = 0xA96E or 43374 as INT16U variable and -10606 as INT16 variable (use the INT16U value to calculate the value of the reactive energy).

Then the reactive energy is equal to $(0-1) \times 2^{31} + 32754 \times 2^{16} + 43374 \times 2^0 = -874130$ kVARh.

Data Type: FLOAT32

Data type FLOAT32 is represented in the single precision IEEE 754 (IEEE standard for floating-point arithmetic). A value N is calculated as indicated below:

$$N = (-1)^S \times 2^{E-127} \times (1+M)$$

Coefficient	Stands for	Description	Number of Bits
S	Sign	Defines the sign of the value: 0 = positive 1 = negative	1 bit
E	Exponent	Excess 127 binary integer added. When 0 < E < 255, the actual exponent is: e = E - 127.	8 bits
M	Mantissa	Magnitude, normalized binary significant	23 bits

Example:

0 = 0 **00000000** 000000000000000000000000

-1.5 = 1 **01111111** 100000000000000000000000

with:

- S = 1
- E = **01111111** = 127
- M = 100000000000000000000000 = $1 \times 2^{-1} + 0 \times 2^{-2} + \dots + 0 \times 2^{-23} = 0.5$
- N = (-1) x 2⁰ x (1+0.5) = -1.5

Data Type: XDATE

XDATE is a data type used to code date and time defined by the ULP modules.

Register	Type	Bit	Range	Description
1	INT16U	0–7	0x01–0x1F	Day
		8–15	0x01–0x0C	Month
2	INT16U	0–7	0x00–0x17	Hours
		8–15	0x50–0xC7	Year <ul style="list-style-type: none"> • 0x50 (80) to 0x63 (99) correspond to years 1980 to 1999 • 0x64 (100) to 0xC7 (199) correspond to years 2000 to 2099 For example, 0x70 (112) corresponds to year 2012.
3	INT16U	0–7	0x00–0x3B	Seconds
		8–15	0x00–0x3B	Minutes
4	INT16U	0–15	0x0000–0x03E7	Complement in milliseconds

Data Type: DATETIME

DATETIME is a data type used to code date and time defined by the IEC 60870-5 standard.

Register	Type	Bit	Range	Description
1	INT16U	0–6	0x00–0x7F	Year: 0x00 (00) to 0x7F (127) correspond to years 2000 to 2127 For example, 0x0D (13) corresponds to year 2013.
		7–15	–	Reserved

Register	Type	Bit	Range	Description
2	INT16U	0–4	0x01–0x1F	Day
		5–7	–	Reserved
		8–11	0x00–0x0C	Month
		12–15	–	Reserved
3	INT16U	0–5	0x00–0x3B	Minutes
		6–7	–	Reserved
		8–12	0x00–0x17	Hours
		13–15	–	Reserved
4	INT16U	0–15	0x0000–0xEA5F	Milliseconds

Quality of DATETIME Timestamps

The quality of timestamps coded with the DATETIME data type can be indicated in the register following the 4 registers of the timestamp. In this case, the timestamp quality is coded as follows:

Bit	Description
0–11	Reserved
12	Externally synchronized: <ul style="list-style-type: none"> 0 = Invalid 1 = Valid
13	Synchronized: <ul style="list-style-type: none"> 0 = Invalid 1 = Valid
14	Date and time is set: <ul style="list-style-type: none"> 0 = Invalid 1 = Valid
15	Reserved

Quality of Bits in Registers

The quality of each bit of a register coded as INT16U data type as an enumeration of bits can be indicated in the register preceding the register.

Example:

The quality of each bit of the register 32001, circuit breaker status, is given in the preceding register, 32000.

The quality of the data corresponding to the bit 0 of register 32001, OF status indication contact, is given in the bit 0 of register 32000:

- bit 0 of register 32000 = quality of OF status indication
- bit 0 of register 32001 = OF status indication contact

If	Then
If bit 0 of register 32000 = 1 AND bit 0 of register 32001 = 0	The OF contact indicates that the device is open
If bit 0 of register 32000 = 1 AND bit 0 of register 32001 = 1	The OF contact indicates that the device is closed
If bit 0 of register 32000 = 0	The OF contact indication is invalid

Notes

- The type column tells how many registers to read to get the variable. For instance INT16U requires reading one register, whereas INT32 requires reading 2 registers.
- Some variables must be read as a block of multiple registers, like the energy measurements. Reading the block partially results in an error.
- Reading from an undocumented register results in a Modbus exception, page 51.
- Numerical values are given in decimal. When it is useful to have the corresponding value in hexadecimal, it is shown as a C language type constant: 0xdddd. For example, the decimal value 123 is represented in hexadecimal as 0x007B.
- For measures that depend on the presence of a neutral as identified by register 3314, reading the value returns 32768 (0x8000) if not applicable. For each table where it occurs, it is explained in a footnote.
- Out of order and not applicable values depend on the data type.

Data Type	Out of Order and Not Applicable Values
INT16U	65535 (0xFFFF)
INT16	-32768 (0x8000)
INT32U	4294967295 (0xFFFFFFFF)
INT32	0x80000000
INT64U	0xFFFFFFFFFFFFFFFF
INT64	0x8000000000000000
FLOAT32	0xFFC00000

Dataset

What's in This Part

Standard Dataset	70
Legacy Dataset	91

Standard Dataset

What's in This Chapter

Standard Dataset	71
Modbus Registers	72
Readout Examples	75
Standard Dataset Common Registers	77

Standard Dataset

Description

The standard dataset contains the most useful information of each IMU module in one convenient table. The standard dataset is available in the registers 32000 to 32341. It can be read with three read requests.

Each IMU module updates the values in the dataset registers on a regular basis.

The response time of requests to standard dataset registers is shorter than the response time of requests to device registers. Therefore, it is recommended to read the standard dataset registers instead of device registers, to improve the overall performance of the system *Modbus Programming Recommendations*, page 45.

The standard dataset can be used with:

- the IFE Ethernet interface for one circuit breaker
- the IFE Ethernet switchboard server
- the EIFE embedded Ethernet interface for MasterPact MTZ drawout circuit breaker
- the IFM Modbus-SL interface for one circuit breaker with part number LV434000

Modbus Registers

Table of Standard Dataset Common Registers

The main information needed for remote supervision of a ComPacT NSX, Compact NS, MasterPact NT/NW or MasterPact MTZ circuit breaker is contained in the table of common registers starting at register 32000.

One Modbus read request is limited to 125 registers maximum. Three Modbus read requests are necessary to read the entire table.

It contains the following information:

- Circuit breaker status
- Tripping causes
- Real-time values of main measurements: current, voltage, power, and energy

The content of this table of registers is detailed in *Standard Dataset Common Registers*, page 77.

Use of these common registers is highly recommended to optimize response times and simplify the use of data.

Table Format

Register tables have the following columns:

Address	Register	RW	Unit	Type	Range	A/E	A/E/P/H	X	Description

- **Address:** a 16-bit register address in hexadecimal. The address is the data used in the Modbus frame.
- **Register:** a 16-bit register number in decimal (register = address + 1).
- **RW:** register read-write status
 - R: the register can be read by using Modbus functions
 - W: the register can be written by using Modbus functions
 - RW: the register can be read and written by using Modbus functions
 - RC: the register can be read by using the command interface
 - WC: the register can be written by using the command interface
- **Unit:** the unit the information is expressed in.
- **Type:** the encoding data type (see data type description below).
- **Range:** the permitted values for this variable, usually a subset of what the format allows.
- **A/E:** types of ComPacT NSXMicroLogic trip unit for which the register is available.
 - Type A (Ammeter): current measurements
 - Type E (Energy): current, voltage, power, and energy measurements
- **A/E/P/H:** types of MasterPact NT/NW and ComPacT NSMicroLogic trip unit for which the register is available.
 - Type A (Ammeter): current measurements
 - Type E (Energy): current, voltage, power, and energy measurements
 - Type P (Power): current, voltage, power, energy measurements, and advanced protection
 - Type H (Harmonics): current, voltage, power, energy, energy quality measurements, and advanced protection

- **X**: register available in the MicroLogic X control unit for MasterPact MTZ circuit breakers.
- **Description**: provides information about the register and restrictions that apply.

Data Types

Data Types	Description	Range
INT16U	16-bit unsigned integer	0 to 65535
INT64	64-bit signed integer	- 9 223 372 036 854 775 808 to + 9 223 372 036 854 775 807
INT64U	64-bit unsigned integer	0 to 18 446 744 073 709 600 000
FLOAT32	32-bit signed integer with a floating point	2^{-126} (1.0) to 2^{127} ($2 - 2^{-23}$)

Big-Endian Format

INT64 and INT64U variables are stored in big-endian format: the most significant register is transmitted first and the least significant register is transmitted at last place.

INT64 and INT64U variables are made of INT16U variables.

The formulas to calculate the decimal value of these variables are:

- INT64: $(\text{bit63}) \times 2^{63} + \text{bit62} \times 2^{62} + \text{bit61} \times 2^{61} + \dots + \text{bit1} \times 2^1 + \text{bit0} \times 2^0$
- INT64U: $\text{bit63} \times 2^{63} + \text{bit62} \times 2^{62} + \text{bit61} \times 2^{61} + \dots + \text{bit1} \times 2^1 + \text{bit0} \times 2^0$

Example:

The total active energy in the standard dataset is an INT64 variable coded in registers 32096 to 32099.

If the values in the registers are:

- register 32096 = 0
- register 32097 = 0
- register 32098 = 70 (0x0046) 0x0017 or 23
- register 32099 = 2105 (0x0839) 0x9692 or 38546 as INT16U variable and -26990 as INT16 variable (use the INT16U value to calculate the value of the total active energy).

Then the total active energy is equal to $0 \times 2^{48} + 0 \times 2^{32} + 23 \times 2^{16} + 38546 \times 2^0 = 1545874$ Wh.

Data Type: FLOAT32

Data type FLOAT32 is represented in the single precision IEEE 754 (IEEE standard for floating-point arithmetic). A value N is calculated as indicated below:

$$N = (-1)^S \times 2^{E-127} \times (1+M)$$

Coefficient	Stands for	Description	Number of Bits
S	Sign	Defines the sign of the value: 0 = positive 1 = negative	1 bit
E	Exponent	Excess 127 binary integer added. When $0 < E < 255$, the actual exponent is: $e = E - 127$.	8 bits
M	Mantissa	Magnitude, normalized binary significant	23 bits

Example:

$0 = 0$ **00000000** 000000000000000000000000

$-1.5 = 1$ **01111111** 100000000000000000000000

with:

- $S = 1$
- $E = 01111111 = 127$
- $M = 100000000000000000000000 = 1 \times 2^{-1} + 0 \times 2^{-2} + \dots + 0 \times 2^{-23} = 0.5$
- $N = (-1) \times 2^0 \times (1+0.5) = -1.5$

Quality of Bits in Registers

The quality of each bit of a register coded as INT16U data type as an enumeration of bits can be indicated in the register preceding the register.

Example:

The quality of each bit of the register 32001, circuit breaker status, is given in the preceding register, 32000.

The quality of the data corresponding to the bit 0 of register 32001, OF status indication contact, is given in the bit 0 of register 32000:

- bit 0 of register 32000 = quality of OF status indication
- bit 0 of register 32001 = OF status indication contact

If	Then
If bit 0 of register 32000 = 1 AND bit 0 of register 32001 = 0	The OF contact indicates that the device is open
If bit 0 of register 32000 = 1 AND bit 0 of register 32001 = 1	The OF contact indicates that the device is closed
If bit 0 of register 32000 = 0	The OF contact indication is invalid

Readout Examples

Readout Example of a Modbus Register

The table below shows how to read the RMS current on phase 1 (I1) in registers 32028 and 32029 (coded in FLOAT32).

- The address of register 32028 equals $32028 - 1 = 32027 = 0x7D1B$.
- The Modbus address of the Modbus slave is $255 = 0xFF$.

Request from the Master		Response from the Slave	
Field Name	Example	Field Name	Example
Modbus slave address	0xFF	Modbus slave address	0xFF
Function code	0x03	Function code	0x03
Address of first register to be read (MSB)	0x7D	Data length in bytes	0x04
Address of first register to be read (LSB)	0x1B	Value read at address 0x7D1B (register 32028) (MSB)	0x44
Number of registers (MSB)	0x00	Value read at address 0x7D1B (register 32028) (LSB)	0x0A
Number of registers (LSB)	0x02	Value read at address 0x7D1C (register 32029) (MSB)	0xC0
CRC (MSB)	0XX	Value read at address 0x7D1C (register 32029) (LSB)	0x00
CRC (LSB)	0XX	CRC (MSB)	0XX
-	-	CRC (LSB)	0XX

The converted value of the FLOAT32 registers 32028 and 32029 is 555.

The RMS current on phase 1 (I1) is thus 555 A.

Readout Example of the Table of Standard Dataset Common Registers

Since there are more than 125 registers in the standard dataset, at least three Modbus read requests are needed to read the entire table.

Request to read registers 32000 to 32123:

- The address of register 32000 is 0x7CFF.
- The length is 124 registers = 0x7C.
- The number of bytes is $124 \times 2 = 248$ bytes = 0xF8.
- The Modbus address of the slave is 255 = 0xFF.

Request to read registers 32124 to 32241:

- The address of register 32124 is 0x7D7B.
- The length is 118 registers = 0x76.
- The number of bytes is $118 \times 2 = 236$ bytes = 0xEC.
- The Modbus address of the slave is 255 = 0xFF.

Request to read registers 32340 to 32435:

- The address of register 32340 is 0x7E53.
- The length is 96 registers = 0x60.
- The number of bytes is $2 \times 96 = 192$ bytes = 0xC0.
- The Modbus address of the slave is 255 = 0xFF.

Request from the Master		Response from the Slave	
Field Name	Example	Field Name	Example
Modbus slave address	0xFF	Modbus slave address	0xFF
Function code	0x03	Function code	0x03
Address of the first register to be read (MSB)	0x7C	Data length in bytes	0x8F
Address of the first register to be read (LSB)	0xFF	Value of register 32000 (MSB)	0xFF
Number of registers (MSB)	0x00	Value of register 32000 (LSB)	0xFF
Number of registers (LSB)	0x7C	Value of register 32001 (MSB)	0xFF
CRC (MSB)	0xFF	Value of register 32001 (LSB)	0xFF
CRC (LSB)	0xFF	–	0xFF
–	–	–	0xFF
–	–	Value of register 32123 (MSB)	0xFF
–	–	Value of register 32123 (LSB)	0xFF
–	–	CRC (MSB)	0xFF
–	–	CRC (LSB)	0xFF

Standard Dataset Common Registers

Circuit Breaker Status Register

Address	Register	RW	Unit	Type	Range	A/E	A/E/P/H	X	Bit	Description
0x7CFF	32000	R	–	INT16U	–	A/E	A/E/P/H	X	–	Quality of each bit of register 32001, page 74: <ul style="list-style-type: none"> • 0 = Invalid • 1 = Valid
0x7D00	32001	R	–	INT16U	–	A/E	A/E/P/H	X	–	Circuit breaker status register
						A/E	A/E/P/H	X	0	OF status indication contact <ul style="list-style-type: none"> • 0 = The circuit breaker is open. • 1 = The circuit breaker is closed.
						A/E	A/E/P/H	X	1	SD trip indication contact <ul style="list-style-type: none"> • 0 = Circuit breaker is not tripped. • 1 = Circuit breaker is tripped due to electrical fault, shunt trip, or push-to-trip. Bit always equal to 0 for MasterPact and ComPacT NS circuit breakers with motor mechanism.
						A/E	A/E/P/H	X	2	SDE fault trip indication contact <ul style="list-style-type: none"> • 0 = Circuit breaker is not tripped on electrical fault. • 1 = Circuit breaker is tripped due to electrical fault (including ground-fault test and earth-leakage test).
						–	A/E/P/H	X	3	CH spring charged contact (only with MasterPact) <ul style="list-style-type: none"> • 0 = Spring discharged • 1 = Spring charged Bit always equal to 0 for MasterPact and ComPacT NS circuit breakers with motor mechanism.
						–	–	–	4	Reserved
						–	A/E/P/H	X	5	PF ready to close contact (only with MasterPact) <ul style="list-style-type: none"> • 0 = Not ready to close • 1 = Ready to close Bit always equal to 0 for MasterPact and ComPacT NS circuit breakers with motor mechanism.
						–	–	–	6–14	Reserved
						A/E	A/E/P/H	–	15	Data availability <p>If this bit is set at 1, all other bits of the register are not significant.</p>

IO Status Registers

Address	Register	RW	Unit	Type	Range	A/E	A/E/P/H	X	Bit	Description
0x7D01	32002	R	–	INT16U	–	A/E	A/E/P/H	X	–	Quality of each bit of register 32003: <ul style="list-style-type: none"> • 0 = Invalid • 1 = Valid
0x7D02	32003	R	–	INT16U	–	A/E	A/E/P/H	X	–	IO1 module and M2C status
						A/E	A/E/P/H	X	0	Digital input 1 status: <ul style="list-style-type: none"> • 0 = Off • 1 = On
						A/E	A/E/P/H	X	1	Digital input 2 status: <ul style="list-style-type: none"> • 0 = Off • 1 = On
						A/E	A/E/P/H	X	2	Digital input 3 status: <ul style="list-style-type: none"> • 0 = Off • 1 = On
						A/E	A/E/P/H	X	3	Digital input 4 status: <ul style="list-style-type: none"> • 0 = Off • 1 = On
						A/E	A/E/P/H	X	4	Digital input 5 status: <ul style="list-style-type: none"> • 0 = Off • 1 = On
						A/E	A/E/P/H	X	5	Digital input 6 status: <ul style="list-style-type: none"> • 0 = Off • 1 = On
						A/E	A/E/P/H	X	6	Digital output 1 status: <ul style="list-style-type: none"> • 0 = Off • 1 = On
						A/E	A/E/P/H	X	7	Digital output 2 status: <ul style="list-style-type: none"> • 0 = Off • 1 = On
						A/E	A/E/P/H	X	8	Digital output 3 status: <ul style="list-style-type: none"> • 0 = Off • 1 = On
						–	–	X	9	Digital M2C output 1 status: <ul style="list-style-type: none"> • 0 = Off • 1 = On
						–	–	X	10	Digital M2C output 2 status: <ul style="list-style-type: none"> • 0 = Off • 1 = On
						–	–	–	11–14	Reserved
A/E	A/E/P/H	–	15	Data availability If this bit is set at 1, all other bits of the register are not significant.						
0x7D03	32004	R	–	INT16U	–	A/E	A/E/P/H	X	–	Quality of each bit of register 32005: <ul style="list-style-type: none"> • 0 = Invalid • 1 = Valid
0x7D04	32005	R	–	INT16U	–	A/E	A/E/P/H	X	–	IO2 module status
									0	Digital input 1 status:

Address	Register	RW	Unit	Type	Range	A/E	A/E/P/H	X	Bit	Description
										<ul style="list-style-type: none"> 0 = Off 1 = On
									1	Digital input 2 status: <ul style="list-style-type: none"> 0 = Off 1 = On
									2	Digital input 3 status: <ul style="list-style-type: none"> 0 = Off 1 = On
									3	Digital input 4 status: <ul style="list-style-type: none"> 0 = Off 1 = On
									4	Digital input 5 status: <ul style="list-style-type: none"> 0 = Off 1 = On
									5	Digital input 6 status: <ul style="list-style-type: none"> 0 = Off 1 = On
									6	Digital output 1 status: <ul style="list-style-type: none"> 0 = Off 1 = On
									7	Digital output 2 status: <ul style="list-style-type: none"> 0 = Off 1 = On
									8	Digital output 3 status: <ul style="list-style-type: none"> 0 = Off 1 = On
						-	-	-	9–14	Reserved
						A/E	A/E/P/H	-	15	Data availability If this bit is set at 1, all other bits of the register are not significant.

Tripping Cause

The tripping cause register provides information about the cause of the trip for the standard protection functions. When a tripping cause bit is at 1 in the tripping cause register, it indicates that a trip has occurred and has not been reset.

- For MicroLogic A/E trip units for ComPacT NSX circuit breakers, the tripping cause bit is reset by pressing the key OK (keypad of the MicroLogic A/E trip unit) twice (validation and confirmation).
- For MicroLogic A/E/P/H trip units for MasterPact NT/NW and ComPacT NS circuit breakers, the tripping cause bit is reset as soon as the circuit breaker is closed again.
- For MicroLogic X control units for MasterPact MTZ circuit breakers, the tripping cause bit is reset by pressing the test/reset button (located beside the trip cause LEDs on the MicroLogic X control unit). Press and hold the button for 3 to 15 seconds to reset all the trip causes.

Address	Register	RW	Unit	Type	Range	A/E	A/E/P/H	X	Bit	Description
0x7D05	32006	R	–	INT16U	–	A/E	A/E/P/H	–	–	Quality of each bit of register 32007: <ul style="list-style-type: none"> • 0 = Invalid • 1 = Valid
0x7D06	32007	R	–	INT16U	–	A/E	A/E/P/H	X		Tripping cause for the standard protection functions
						A/E	A/E/P/H	X	0	Long-time protection Ir
						A/E	A/E/P/H	X	1	Short-time protection Isd
						A/E	A/E/P/H	X	2	Instantaneous protection Ii
						A/E	A/E/P/H	X	3	Ground-fault protection Ig
						E	A/P/H	X	4	Earth-leakage protection IΔn
						A/E	A/E/P/H	X	5	Integrated instantaneous protection (SELLIM and DIN/DINF)
						A/E	–	X	6	Internal failure (STOP)
						–	A/E	–		Other protections
						–	P/H	–		Internal failure (temperature)
						–	A/E/P/H	–	7	Internal failure (overvoltage)
						–	P/H	X	8	Other protection (see register 32009)
						–	–	–	9	Reserved
						E	–	–	10	Unbalance motor protection
						E	–	–	11	Jam motor protection
						E	–	–	12	Underload motor protection
E	–	–	13	Long-start motor protection						
A/E	–	–	14	Reflex tripping protection						
A/E	A/E/P/H	–	15	If this bit is at 1, bits 0 to 14 are not valid.						
0x7D07	32008	R	–	INT16U	–	–	P/H	–	–	Quality of each bit of register 32009: <ul style="list-style-type: none"> • 0 = Invalid • 1 = Valid
0x7D08	32009	R	–	INT16U	–	–	P/H	–	–	Tripping causes for the advanced protection functions
						–	P/H	–	0	Current unbalance
						–	P/H	–	1	Overcurrent on phase 1
						–	P/H	–	2	Overcurrent on phase 2
						–	P/H	–	3	Overcurrent on phase 3
						–	P/H	–	4	Overcurrent on Neutral
						–	P/H	X	5	Undervoltage
						–	P/H	X	6	Overvoltage
						–	P/H	–	7	Voltage unbalance
						–	P/H	–	8	Overpower
						–	P/H	X	9	Reverse power
						–	P/H	X	10	Underfrequency
						–	P/H	X	11	Overfrequency
–	P/H	–	12	Phase rotation						

Address	Register	RW	Unit	Type	Range	A/E	A/E/P/H	X	Bit	Description
						–	P/H	–	13	Load shedding based on current
						–	P/H	–	14	Load shedding based on power
						–	P/H	–	15	If this bit is at 1, bits 0 to 14 are not valid.
0x7D09– 0x7D0C	32010– 32013	–	–	–	–	–	–	–	–	Reserved

Overrun of the Protection Setpoints

The alarm setpoint registers provide information about overrun of the standard and advanced protection setpoints. A bit is at 1 once a setpoint overrun has occurred, even if the time delay has not expired.

Address	Register	RW	Unit	Type	Range	A/E	A/E/P/H	X	Bit	Description
0x7D0D	32014	R	–	INT16U	–	A/E	P/H	–	–	Quality of each bit of register 32015: <ul style="list-style-type: none"> • 0 = Invalid • 1 = Valid
0x7D0E	32015	R	–	INT16U	–	A/E	P/H	–	–	Overrun of the standard protection setpoints
						A/E	P/H	–	0	Long-time protection pick-up
						–	–	–	1–14	Reserved
						A/E	P/H	–	15	If this bit is at 1, bits 0 to 14 are not valid.
0x7D0F	32016	R	–	INT16U	–	A/E	P/H	–	–	Quality of each bit of register 32017: <ul style="list-style-type: none"> • 0 = Invalid • 1 = Valid
0x7D10	32017	R	–	INT16U	–	A/E	P/H	–	–	Overrun of the advanced protection setpoints
						–	P/H	–	0	Current unbalance
						–	P/H	–	1	Maximum current on phase 1
						–	P/H	–	2	Maximum current on phase 2
						–	P/H	–	3	Maximum current on phase 3
						–	P/H	–	4	Maximum current on the neutral
						–	P/H	–	5	Minimum voltage
						–	P/H	–	6	Maximum voltage
						–	P/H	–	7	Voltage unbalance
						–	P/H	–	8	Maximum power
						–	P/H	–	9	Reverse power
						–	P/H	–	10	Minimum frequency
						–	P/H	–	11	Maximum frequency
						–	P/H	–	12	Phase rotation
–	P/H	–	13	Load shedding based on the current						
–	P/H	–	14	Load shedding based on the power						

Address	Register	RW	Unit	Type	Range	A/E	A/E/P/H	X	Bit	Description
						–	P/H	–	15	If this bit is at 1, bits 0 to 14 are not valid.
0x7D11	32018	R	–	INT16U	–	–	P/H	–	–	Quality of each bit of register 32019: <ul style="list-style-type: none"> • 0 = Invalid • 1 = Valid
0x7D12	32019	R	–	INT16U	–	–	P/H	–	–	Advanced protection settings extended
						–	P/H	–	0	Ground-fault alarm
						E	P/H	–	1	Earth-leakage alarm
						–	–	–	2–14	Reserved
						–	P/H	–	15	If this bit is at 1, bits 0 to 14 are not valid.

Alarms

The alarm register provides information about the pre-alarms and the user-defined alarms. A bit is set to 1 once an alarm is active.

Address	Register	RW	Unit	Type	Range	A/E	A/E/P/H	X	Bit	Description
0x7D13	32020	R	–	INT16U	–	A/E	–	–	–	Quality of each bit of register 32021: <ul style="list-style-type: none"> • 0 = Invalid • 1 = Valid
0x7D14	32021	R	–	INT16U	–	A/E	–	–	–	Pre-alarm extended register
						A/E	–	X	0	Long-time protection time pre-alarm (PAL Ir)
						E	–	–	1	Earth-leakage protection pre-alarm (PAL IΔn)
						–	–	X		Earth-leakage alarm ⁽¹⁾
						A/E	–	–	2	Ground-fault protection pre-alarm (PAL Ig)
						–	–	X		Ground-fault alarm ⁽²⁾
						–	–	–	3–14	Reserved
						A/E	–	–	15	If this bit is at 1, bits 0 to 14 are not valid.

0x7D15	32022	R	–	INT16U	–	A/E	–	–	–	Quality of each bit of register 32023: <ul style="list-style-type: none"> • 0 = Invalid • 1 = Valid
0x7D16	32023	R	–	INT16U	–	A/E	–	–	–	Register of user-defined alarms
						A/E	–	–	0	User-defined alarm 201
						A/E	–	–	1	User-defined alarm 202
						A/E	–	–	2	User-defined alarm 203
						A/E	–	–	3	User-defined alarm 204
						A/E	–	–	4	User-defined alarm 205
						A/E	–	–	5	User-defined alarm 206
						A/E	–	–	6	User-defined alarm 207
						A/E	–	–	7	User-defined alarm 208
A/E	–	–	8	User-defined alarm 209						

Address	Register	RW	Unit	Type	Range	A/E	A/E/P/H	X	Bit	Description
						A/E	–	–	9	User-defined alarm 210
						–	–	–	10–14	Reserved
						A/E	–	–	15	If this bit is at 1, bits 0 to 14 are not valid.
0x7D17– 0x7D1A	32024– 32027	–	–	–	–	–	–	–	–	Reserved

(1) Value available on MicroLogic 7.0 X control unit only when the Digital Module ANSI 51N/51G Ground-fault alarm is installed.

(2) Value available on MicroLogic 2.0 X, 3.0 X, 5.0 X, and 6.0 X control units only when the Digital Module ANSI 51N/51G Ground-fault alarm is installed.

Current

Address	Register	RW	Unit	Type	Range	A/E	A/E/P/H	X	Description
0x7D1B– 0x7D1C	32028– 32029	R	A	FLOAT32	–	A/E	A/E/P/H	X	RMS current on phase 1
0x7D1D– 0x7D1E	32030– 32031	R	A	FLOAT32	–	A/E	A/E/P/H	X	RMS current on phase 2
0x7D1F– 0x7D20	32032– 32033	R	A	FLOAT32	–	A/E	A/E/P/H	X	RMS current on phase 3
0x7D21– 0x7D22	32034– 32035	R	A	FLOAT32	–	A/E	A/E/P/H	X	RMS current on the neutral ⁽¹⁾
0x7D23– 0x7D24	32036– 32037	R	A	FLOAT32	–	A/E	A/E/P/H	X	Maximum of RMS current of phases 1, 2, 3 and N (most loaded phase) ⁽³⁾
0x7D25– 0x7D26	32038– 32039	R	–	FLOAT32	–	A/E	A/E/P/H	X	Current ratio on ground (I _g setting ratio)
0x7D27– 0x7D28	32040– 32041	R	–	FLOAT32	–	E	A/P/H	X	Current ratio on earth-leakage (I _{Δn} setting ratio) ⁽²⁾

(1) Value available when system type register returns 30 or 41.

(2) Value available with MicroLogic 7.0 X.

(3) Value reset with the reset minimum/maximum command.

Maximum Current Values

Maximum current values can be reset with the reset minimum/maximum command.

Address	Register	RW	Unit	Type	Range	A/E	A/E/P/H	X	Description
0x7D29– 0x7D2A	32042– 32043	R	A	FLOAT32	–	A/E	A/E/P/H	X	Maximum RMS current on phase 1
0x7D2B– 0x7D2C	32044– 32045	R	A	FLOAT32	–	A/E	A/E/P/H	X	Maximum RMS current on phase 2
0x7D2D– 0x7D2E	32046– 32047	R	A	FLOAT32	–	A/E	A/E/P/H	X	Maximum RMS current on phase 3
0x7D2F– 0x7D30	32048– 32049	R	A	FLOAT32	–	A/E	A/E/P/H	X	Maximum RMS current on the neutral ⁽¹⁾
0x7D31– 0x7D32	32050– 32051	R	A	FLOAT32	–	A/E	A/E/P/H	X	This is the highest (i.e. maximum) maximum current value since this measurement was last reset. The measurement looks at all 3 currents, MaxI1, MaxI2, MaxI3 and MaxIN and keeps track of the highest value of any of them over time.

Address	Register	RW	Unit	Type	Range	A/E	A/E/P/H	X	Description
0x7D33– 0x7D36	32052– 32055	–	–	–	–	–	–	–	Reserved

(1) Value available when system type register returns 30 or 41.

Voltage

Address	Register	RW	Unit	Type	Range	A/E	A/E/P/H	X	Description
0x7D37– 0x7D38	32056– 32057	R	V	FLOAT32	41.6– 2250	E	E/P/H	X	RMS phase-to-phase voltage V12
0x7D39– 0x7D3A	32058– 32059	R	V	FLOAT32	41.6– 2250	E	E/P/H	X	RMS phase-to-phase voltage V23
0x7D3B– 0x7D3C	32060– 32061	R	V	FLOAT32	41.6– 2250	E	E/P/H	X	RMS phase-to-phase voltage V31
0x7D3D– 0x7D3E	32062– 32063	R	V	FLOAT32	24-1500	E	E/P/H	X	RMS phase-to-neutral voltage V1N ⁽¹⁾
0x7D3F– 0x7D40	32064– 32065	R	V	FLOAT32	24-1500	E	E/P/H	X	RMS phase-to-neutral voltage V2N ⁽¹⁾
0x7D41– 0x7D42	32066– 32067	R	V	FLOAT32	24-1500	E	E/P/H	X	RMS phase-to-neutral voltage V3N ⁽¹⁾

(1) Value available when system type register returns 40 or 41.

Frequency

When the MicroLogic trip unit cannot calculate the frequency, it returns Not applicable = 0xFFC00000.

Address	Register	RW	Unit	Type	Range	A/E	A/E/P/H	X	Description
0x7D43– 0x7D44	32068– 32069	R	Hz	FLOAT32	40.0–70.0	E	P/H	X	Frequency
0x7D45– 0x7D46	32070– 32071	R	Hz	FLOAT32	40.0–70.0	E	P/H	X	Maximum frequency ⁽¹⁾

(1) This value can be reset with the reset minimum/maximum command.

Power

Address	Register	RW	Unit	Type	Range	A/E	A/E/P/H	X	Description
0x7D47– 0x7D48	32072– 32073	R	W	FLOAT32	-16000000– 16000000	E	E/P/H	X	Active power on phase 1 ⁽¹⁾ ⁽²⁾
0x7D49– 0x7D4A	32074– 32075	R	W	FLOAT32	-16000000– 16000000	E	E/P/H	X	Active power on phase 2 ⁽¹⁾ ⁽²⁾
0x7D4B– 0x7D4C	32076– 32077	R	W	FLOAT32	-16000000– 16000000	E	E/P/H	X	Active power on phase 3 ⁽¹⁾ ⁽²⁾
0x7D4D– 0x7D4E	32078– 32079	R	W	FLOAT32	-16000000– 16000000	E	E/P/H	X	Total active power ⁽²⁾
0x7D4F– 0x7D50	32080– 32081	R	VAr	FLOAT32	-16000000– 16000000	E	E/P/H	X	Reactive power on phase 1 ⁽¹⁾ ⁽²⁾
0x7D51– 0x7D52	32082– 32083	R	VAr	FLOAT32	-16000000– 16000000	E	E/P/H	X	Reactive power on phase 2 ⁽¹⁾ ⁽²⁾
0x7D53– 0x7D54	32084– 32085	R	VAr	FLOAT32	-16000000– 16000000	E	E/P/H	X	Reactive power on phase 3 ⁽¹⁾ ⁽²⁾
0x7D55– 0x7D56	32086– 32087	R	VAr	FLOAT32	-16000000– 16000000	E	E/P/H	X	Total reactive power ⁽²⁾

Address	Register	RW	Unit	Type	Range	A/E	A/E/P/H	X	Description
0x7D57– 0x7D58	32088– 32089	R	VA	FLOAT32	0–16000000	E	E/P/H	X	Apparent power on phase 1 ⁽¹⁾
0x7D59– 0x7D5A	32090– 32091	R	VA	FLOAT32	0–16000000	E	E/P/H	X	Apparent power on phase 2 ⁽¹⁾
0x7D5B– 0x7D5C	32092– 32093	R	VA	FLOAT32	0–16000000	E	E/P/H	X	Apparent power on phase 3 ⁽¹⁾
0x7D5D– 0x7D5E	32094– 32095	R	VA	FLOAT32	0–16000000	E	E/P/H	X	Total apparent power

(1) Value available when system type register returns 40 or 41.

(2) The sign for the active and reactive power depends on the configuration of:

- register 3316 for ComPacT NSX, ComPacT NS, and MasterPact NT/NW circuit breakers.
- register 8405 for MasterPact MTZ circuit breakers.

Energy

Energy is stored in big-endian format: the most significant register is transmitted first.

Address	Register	RW	Unit	Type	Range	A/E	A/E/P/H	X	Description
0x7D5F– 0x7D62	32096– 32099	R	Wh	INT64	–	E	E/P/H	X	Total active energy ⁽²⁾
0x7D63– 0x7D66	32100– 32103	R	VARh	INT64	–	E	E/P/H ⁽¹⁾	X	Total reactive energy ⁽²⁾
0x7D67– 0x7D6A	32104– 32107	R	Wh	INT64U	–	E	P/H	X	Total active energy delivered (into the load, counted positively) ⁽²⁾
0x7D6B– 0x7D6E	32108– 32111	R	Wh	INT64U	–	E	P/H	X	Total active energy received (out of the load, counted negatively) ⁽²⁾
0x7D6F– 0x7D72	32112– 32115	R	VARh	INT64U	–	E	P/H	X	Total reactive energy delivered (into the load, counted positively) ⁽²⁾
0x7D73– 0x7D76	32116– 32119	R	VARh	INT64U	–	E	P/H	X	Total reactive energy received (out of the load, counted negatively) ⁽²⁾
0x7D77– 0x7D7A	32120– 32123	R	VAh	INT64U	–	E	–	X	Total apparent energy ⁽²⁾
0x7D7B– 0x7D7E	32124– 32127	R	Wh	INT64U	–	E	–	X	Total cumulative active energy delivered (into the load, counted positively, not resettable)
0x7D7F– 0x7D82	32128– 32131	R	Wh	INT64U	–	E	–	X	Total cumulative active energy received (out of the load, counted negatively, not resettable)

(1) This value is always positive with MasterPact MicroLogic E trip unit.

(2) Value reset with the reset energies command.

Average Values

Address	Register	RW	Unit	Type	Range	A/E	A/E/P/H	X	Description
0x7D83– 0x7D84	32132– 32133	R	A	FLOAT32	–	–	–	X	Average of 3-phase RMS currents
0x7D85– 0x7D86	32134– 32135	R	V	FLOAT32	–	–	–	X	Average of 3 RMS phase-to-phase voltages: $(V12+V23+V31)/3$
0x7D87– 0x7D88	32136– 32137	R	V	FLOAT32	–	–	–	X	Average of 3 RMS phase-to-neutral voltages: $(V1N+V2N+V3N)/3^{(1)}$

(1) Value available when system type register returns 40 or 41.

Maximum Power Values

Maximum power values can be reset with the reset minimum/maximum command.

Address	Register	RW	Unit	Type	Range	A/E	A/E/P/H	X	Description
0x7D89– 0x7D8A	32138– 32139	R	W	FLOAT32	–	–	–	X	Maximum total active power
0x7D8B– 0x7D8C	32140– 32141	R	VAr	FLOAT32	–	–	–	X	Maximum total reactive power
0x7D8D– 0x7D8E	32142– 32143	R	VA	FLOAT32	–	–	–	X	Maximum total apparent power

Maximum Average Values

Maximum average values can be reset with the reset minimum/maximum command.

Address	Register	RW	Unit	Type	Range	A/E	A/E/P/H	X	Description
0x7D8F– 0x7D90	32144– 32145	R	A	FLOAT32	–	–	–	X	Maximum of average of 3-phase RMS currents
0x7D91– 0x7D92	32146– 32147	R	V	FLOAT32	–	–	–	X	Maximum of average of 3 RMS phase-to-phase voltages
0x7D93– 0x7D94	32148– 32149	R	V	FLOAT32	–	–	–	X	Maximum of average of 3 RMS phase-to-neutral voltages

Ground and Earth-Leakage Current

Address	Register	RW	Unit	Type	Range	A/E	A/E/P/H	X	Description
0x7D95– 0x7D96	32150– 32151	R	A	FLOAT32	–	–	–	X	Ground-fault current
0x7D97– 0x7D98	32152– 32153	R	A	FLOAT32	–	–	–	X	Earth-leakage current ⁽¹⁾
0x7D99– 0x7D9A	32154– 32155	–	–	–	–	–	–	–	Reserved

(1) Value available with MicroLogic 7

Current Demand Values

Address	Register	RW	Unit	Type	Range	A/E	A/E/P/H	X	Description
0x7D9B– 0x7D9C	32156– 32157	R	A	FLOAT32	–	E	E/P/H	X	Current demand value on phase 1: I1 Dmd
0x7D9D– 0x7D9E	32158– 32159	R	A	FLOAT32	–	E	E/P/H	X	Current demand value on phase 2: I2 Dmd
0x7D9F– 0x7DA0	32160– 32161	R	A	FLOAT32	–	E	E/P/H	X	Current demand value on phase 3: I3 Dmd
0x7DA1– 0x7DA2	32162– 32163	R	A	FLOAT32	–	E	E/P/H	X	Current demand value on the neutral: IN Dmd ⁽¹⁾

(1) Value available when system type register returns 30 or 41.

Power Demand Values

When the window is a fixed type, this value is updated at the end of the window. For the sliding type, the value is updated every 15 seconds.

Address	Register	RW	Unit	Type	Range	A/E	A/E/P/H	X	Description
0x7DA3– 0x7DA4	32164– 32165	R	W	FLOAT32	–	E	E/P/H	X	Total active power demand: P Dmd
0x7DA5– 0x7DA6	32166– 32167	R	VAR	FLOAT32	–	E	P/H	X	Total reactive power demand: Q Dmd
0x7DA7– 0x7DA8	32168– 32169	R	VA	FLOAT32	–	E	P/H	X	Total apparent power demand: S Dmd

Current Peak Demand Values

Current peak demand values can be reset with the reset minimum/maximum command.

Address	Register	RW	Unit	Type	Range	A/E	A/E/P/H	X	Description
0x7DA9– 0x7DAA	32170– 32171	R	A	FLOAT32	–	–	–	X	Current peak demand value on phase 1: I1 dmd max
0x7DAB– 0x7DAC	32172– 32173	R	A	FLOAT32	–	–	–	X	Current peak demand value on phase 2: I2 dmd max
0x7DAD– 0x7DAE	32174– 32175	R	A	FLOAT32	–	–	–	X	Current peak demand value on phase 3: I3 dmd max
0x7DAF– 0x7DB0	32176– 32177	R	A	FLOAT32	–	–	–	X	Current peak demand value on the neutral: IN dmd max ⁽¹⁾

(1) Value available when system type register returns 30 or 41.

Power Peak Demand Values

Power peak demand values are updated every 15 seconds. Power peak demand values can be reset with the reset minimum/maximum command.

Address	Register	RW	Unit	Type	Range	A/E	A/E/P/H	X	Description
0x7DB1– 0x7DB2	32178– 32179	R	W	FLOAT32	–	–	–	X	Total active power peak demand: P dmd max
0x7DB3– 0x7DB4	32180– 32181	R	VAR	FLOAT32	–	–	–	X	Total reactive power peak demand: Q dmd max
0x7DB5– 0x7DB6	32182– 32183	R	VA	FLOAT32	–	–	–	X	Total apparent power peak demand: S dmd max

Maximum Ground and Earth-Leakage Current Values

Maximum ground and earth-leakage current values can be reset with the reset minimum/maximum command.

Address	Register	RW	Unit	Type	Range	A/E	A/E/P/H	X	Description
0x7DB7– 0x7DB8	32184– 32185	R	A	FLOAT32	–	–	–	X	Maximum ground-fault current
0x7DB9– 0x7DBA	32186– 32187	R	V	FLOAT32	–	E	–	X	Maximum earth-leakage current ⁽¹⁾
0x7DBB– 0x7DC0	32188– 32193	–	–	–	–	–	–	–	Reserved

(1) Value available with MicroLogic 7.

Maximum Voltage Values

Maximum voltage values can be reset with the reset minimum/maximum command.

Address	Register	RW	Unit	Type	Range	A/E	A/E/P/H	X	Description
0x7DC1– 0x7DC2	32194– 32195	R	V	FLOAT32	41.6– 2250	E	E/P/H	X	Maximum RMS phase-to-phase voltage V12
0x7DC3– 0x7DC4	32196– 32197	R	V	FLOAT32	41.6– 2250	E	E/P/H	X	Maximum RMS phase-to-phase voltage V23
0x7DC5– 0x7DC6	32198– 32199	R	V	FLOAT32	41.6– 2250	E	E/P/H	X	Maximum RMS phase-to-phase voltage V31
0x7DC7– 0x7DC8	32200– 32201	R	V	FLOAT32	24–1500	E	E/P/H	X	Maximum RMS phase-to-neutral voltage V1N ⁽¹⁾
0x7DC9– 0x7DCA	32202– 32203	R	V	FLOAT32	24–1500	E	E/P/H	X	Maximum RMS phase-to-neutral voltage V2N ⁽¹⁾
0x7DCB– 0x7DCC	32204– 32205	R	V	FLOAT32	24–1500	E	E/P/H	X	Maximum RMS phase-to-neutral voltage V3N ⁽¹⁾

(1) Value available when system type register returns 40 or 41.

Power Factor

Address	Register	RW	Unit	Type	Range	A/E	A/E/P/H	X	Description
0x7DCD– 0x7DCE	32206– 32207	R	–	FLOAT32	–	E	E/P/H	X	Power factor on phase 1 ⁽¹⁾
0x7DCF– 0x7DD0	32208– 32209	R	–	FLOAT32	–	E	E/P/H	X	Power factor on phase 2 ⁽¹⁾
0x7DD1– 0x7DD2	32210– 32211	R	–	FLOAT32	–	E	E/P/H	X	Power factor on phase 3 ⁽¹⁾
0x7DD3– 0x7DD4	32212– 32213	R	–	FLOAT32	–	E	E/P/H	X	Total power factor

Address	Register	RW	Unit	Type	Range	A/E	A/E/P/H	X	Description
0x7DD5– 0x7DD6	32214– 32215	R	–	FLOAT32	–	E	H	X	Fundamental power factor on phase 1 ($\cos\phi$) ⁽¹⁾⁽²⁾
0x7DD7– 0x7DD8	32216– 32217	R	–	FLOAT32	–	E	H	X	Fundamental power factor on phase 2 ($\cos\phi$) ⁽¹⁾⁽²⁾
0x7DD9– 0x7DDA	32218– 32219	R	–	FLOAT32	–	E	H	X	Fundamental power factor on phase 3 ($\cos\phi$) ⁽¹⁾⁽²⁾
0x7DDB– 0x7DDC	32220– 32221	R	–	FLOAT32	–	E	H	X	Total fundamental power factor ⁽²⁾

(1) Value available when system type register returns 40 or 41.

(2) The sign for the fundamental power factor ($\cos\phi$) depends on the configuration:

- register 3318 for ComPacT NSX, ComPacT NS, and MasterPact NT/NW circuit breakers.
- register 8404 for MasterPact MTZ circuit breakers.

Total Harmonic Distortion (THD)

Address	Register	RW	Unit	Type	Range	A/E	A/E/P/H	X	Description
0x7DDD– 0x7DDE	32222– 32223	R	–	FLOAT32	0–2	E	H	X	Total harmonic distortion (THD) of phase-to phase voltage V12 compared to the fundamental
0x7DDF– 0x7DE0	32224– 32225	R	–	FLOAT32	0–2	E	H	X	Total harmonic distortion (THD) of phase-to phase voltage V23 compared to the fundamental
0x7DE1– 0x7DE2	32226– 32227	R	–	FLOAT32	0–2	E	H	X	Total harmonic distortion (THD) of phase-to phase voltage V31 compared to the fundamental
0x7DE3– 0x7DE4	32228– 32229	R	–	FLOAT32	0–2	E	H	X	Total harmonic distortion (THD) of phase-to-neutral voltage V1N compared to the fundamental ⁽¹⁾
0x7DE5– 0x7DE6	32230– 32231	R	–	FLOAT32	0–2	E	H	X	Total harmonic distortion (THD) of phase-to-neutral voltage V2N compared to the fundamental ⁽¹⁾
0x7DE7– 0x7DE8	32232– 32233	R	–	FLOAT32	0–2	E	H	X	Total harmonic distortion (THD) of phase-to-neutral voltage V3N compared to the fundamental ⁽¹⁾
0x7DE9– 0x7DEA	32234– 32235	R	–	FLOAT32	0–2	E	H	X	Total harmonic distortion (THD) of current on phase 1 compared to the fundamental
0x7DEB– 0x7DEC	32236– 32237	R	–	FLOAT32	0–2	E	H	X	Total harmonic distortion (THD) of current on phase 2 compared to the fundamental
0x7DED– 0x7DEE	32238– 32239	R	–	FLOAT32	0–2	E	H	X	Total harmonic distortion (THD) of current on phase 3 compared to the fundamental
0x7DEF– 0x7DF0	32240– 32241	R	–	FLOAT32	0–2	E	H	X	Average of 3-phase current Total harmonic distortions (THD) compared to the fundamental

(1) Value available when system type register returns 40 or 41.

Maximum Power Factor

Maximum power factor can be reset with the reset minimum/maximum command.

Address	Register	RW	Unit	Type	Range	A/E	A/E/P/H	X	Description
0x7DF1– 0x7DF2	32242– 32243	R	–	FLOAT32	–	–	–	X	Maximum total power factor
0x7DF3– 0x7E52	32244– 32339	–	–	–	–	–	–	–	Reserved

Inhibit Close Order

Address	Register	RW	Unit	Type	Range	A/E	A/E/P/H	X	Bit	Description
0x7E53	32340	R	–	INT16U	–	A/E	A/E/P/H	X	–	Quality of each bit of register 32341: <ul style="list-style-type: none"> • 0 = Invalid • 1 = Valid
0x7E54	32341	R	–	INT16U	–	A/E	A/E/P/H	X	–	Inhibit close order status
									0	Close breaker inhibited by IO module <ul style="list-style-type: none"> • 0 = Disable • 1 = Enable
									1	Close breaker inhibited by communication <ul style="list-style-type: none"> • 0 = Disable • 1 = Enable
–	–	–	–	–	–	–	–	2–15	Reserved	

Legacy Dataset

What's in This Chapter

Legacy Dataset	92
Modbus Registers	93
Readout Examples	95
Legacy Dataset Common Registers	97

Legacy Dataset

Description

The legacy dataset contains the most useful information of each IMU module in one convenient table. The legacy dataset is available in the registers 12000 to 12165. It can be read with two read requests.

Each IMU module updates the values in the dataset registers on a regular basis.

The response time of requests to legacy dataset registers is shorter than the response time of requests to device registers. Therefore, it is recommended to read the legacy dataset registers instead of device registers, to improve the overall performance of the system, page 45.

NOTE:

- The legacy dataset is compatible with legacy versions of the MicroLogic trip unit for ComPacT NSX, PowerPacT H-, J-, and L-frame, ComPacT NS, PowerPacT P-, and R-frame or MasterPact NT/NW circuit breaker. For this reason, data read directly in the Modbus registers is organized in a different way than in the standard dataset.
- For new applications, it is recommended to use the standard dataset instead of the legacy dataset.

Data Availability

The legacy dataset is available when the Modbus legacy dataset Digital Module is purchased and installed on a MicroLogic X control unit.

The Modbus legacy dataset Digital Module is compatible with MicroLogic X control units with firmware version greater than or equal to version V002.000.xxx.

The Modbus legacy dataset is available on a remote controller using the communication network through the following communication interfaces:

- IFE Ethernet interface
- EIFE Ethernet interface
- IFE server
- IFM Modbus-SL interface

The following table shows the part numbers and firmware versions necessary to access the Modbus legacy dataset through communication interfaces:

Communication interface	Part number	Minimum firmware version required
IFE Ethernet interface	LV434010	V003.007.024
	LV434001	
IFE server	LV434011	V003.007.024
	LV434002	
EIFE Ethernet interface	LV851001	V003.007.024
IFM Modbus-SL interface	LV434000	V003.001.006

Modbus Registers

Table of Legacy Dataset Common Registers

The main information needed for remote supervision of a ComPacT NSX, ComPacT NS, MasterPact NT/NW, or MasterPact MTZ circuit breaker is contained in the table of common registers starting at register 12000.

This compact table of 114 registers can be read with a single Modbus request.

It contains the following information:

- Circuit breaker status
- Tripping causes
- Real-time values of main measurements: current, voltage, power, energy, total harmonic distortion

The content of this table of registers is detailed in *Legacy Dataset Common Registers*, page 97.

Use of these common registers is highly recommended to optimize response times and simplify the use of data.

Table Format

Register tables have the following columns:

Address	Register	RW	Unit	Type	Range	A/E	A/E/P/H	X	Description

- **Address:** a 16-bit register address in hexadecimal. The address is the data used in the Modbus frame.
- **Register:** a 16-bit register number in decimal (register = address + 1).
- **RW:** register read-write status
 - R: the register can be read by using Modbus functions
 - W: the register can be written by using Modbus functions
 - RW: the register can be read and written by using Modbus functions
 - RC: the register can be read by using the command interface
 - WC: the register can be written by using the command interface
- **Unit:** the unit the information is expressed in.
- **Type:** the encoding data type (see data type description below).
- **Range:** the permitted values for this variable, usually a subset of what the format allows.
- **A/E:** types of ComPacT NSX MicroLogic trip unit for which the register is available.
 - Type A (Ammeter): current measurements
 - Type E (Energy): current, voltage, power, and energy measurements
- **A/E/P/H:** types of MasterPact NT/NW and ComPacT NS MicroLogic trip unit for which the register is available.
 - Type A (Ammeter): current measurements
 - Type E (Energy): current, voltage, power, and energy measurements
 - Type P (Power): current, voltage, power, energy measurements, and advanced protection
 - Type H (Harmonics): current, voltage, power, energy, energy quality measurements, and advanced protection

- **X**: register available in the MicroLogic X control unit for MasterPact MTZ circuit breakers when the Modbus legacy dataset Digital Module is purchased and installed on the MicroLogic X control unit.
- **Description**: provides information about the register and restrictions that apply.

Data Types

Data Types	Description	Range
INT16U	16-bit unsigned integer	0 to 65535
INT16	16-bit signed integer	-32768 to +32767
INT32U	32-bit unsigned integer	0 to 4 294 967 295
INT32	32-bit signed integer	-2 147 483 648 to +2 147 483 647

Big-Endian Format

INT32 and INT32U variables are stored in big-endian format: the most significant register is transmitted first and the least significant register is transmitted at last place.

INT32 and INT32U variables are made of INT16U variables.

The formulas to calculate the decimal value of these variables are:

- INT32: $(0\text{-bit}31) \times 2^{31} + \text{bit}30 \times 2^{30} + \text{bit}29 \times 2^{29} + \dots \text{bit}1 \times 2^1 + \text{bit}0 \times 2^0$
- INT32U: $\text{bit}31 \times 2^{31} + \text{bit}30 \times 2^{30} + \text{bit}29 \times 2^{29} + \dots \text{bit}1 \times 2^1 + \text{bit}0 \times 2^0$

Example:

The reactive energy in the legacy dataset is an INT32 variable coded in registers 12052 to 12053.

If the values in the registers are:

- register 12052 = 0xFFF2 = 0x8000 + 0x7FF2 or 32754
- register 12053 = 0xA96E or 43374 as INT16U variable and -10606 as INT16 variable (use the INT16U value to calculate the value of the reactive energy).

Then the reactive energy is equal to $(0-1) \times 2^{31} + 32754 \times 2^{16} + 43374 \times 2^0 = -874130$ kVARh.

Readout Examples

Readout Example of a Modbus Register

The table below shows how to read the rms current on phase 1 (I1) in register 12016.

- The address of register 12016 equals $12016 - 1 = 12015 = 0x2EEF$.
- The Modbus address of the Modbus slave is $47 = 0x2F$.

Request from the Master		Response from the Slave	
Field Name	Example	Field Name	Example
Modbus slave address	0x2F	Modbus slave address	0x2F
Function code	0x03	Function code	0x03
Address of register to be read (MSB)	0x2E	Data length in bytes	0x02
Address of register to be read (LSB)	0xEF	Register value (MSB)	0x02
Number of registers (MSB)	0x00	Register value (LSB)	0x2B
Number of registers (LSB)	0x01	CRC (MSB)	0xXX
CRC (MSB)	0xXX	CRC (LSB)	0xXX
CRC (LSB)	0xXX	–	–

The content of register 12016 (address 0x2EEF) is $0x022B = 555$.

The rms current on phase 1 (I1) is thus 555 A.

Readout Example of the Table of Legacy Dataset Common Registers

The table below shows how to read the table of legacy dataset common registers. This table starts at register 12000 and consists of 113 registers.

- The address of register 12000 = 0x2EDF.
- The table length is 113 registers = 0x71.
- The number of bytes is 113x2 = 226 bytes = 0xE2.
- The Modbus address of the slave is 47 = 0x2F.

Request from the Master		Response from the Slave	
Field Name	Example	Field Name	Example
Modbus slave address	0x2F	Modbus slave address	0x2F
Function code	0x03	Function code	0x03
Address of the first register to be read (MSB)	0x2E	Data length in bytes	0xE2
Address of the first register to be read (LSB)	0xDF	Value of register 12000 (MSB)	0xXX
Number of registers (MSB)	0x00	Value of register 12000 (LSB)	0xXX
Number of registers (LSB)	0x71	Value of register 12001 (MSB)	0xXX
CRC (MSB)	0xXX	Value of register 12001 (LSB)	0xXX
CRC (LSB)	0xXX	–	0xXX
–	–	–	0xXX
–	–	Value of register 12112 (MSB)	0xXX
–	–	Value of register 12112 (LSB)	0xXX
–	–	CRC (MSB)	0xXX
–	–	CRC (LSB)	0xXX

Legacy Dataset Common Registers

Circuit Breaker Status Register

Address	Register	RW	Unit	Type	Range	A/E	A/E/P/H	X	Bit	Description
0x2EDF	12000	R	–	INT16U	–	A/E	A/E/P/H	X	–	Validity of each bit in the circuit breaker status register.
0x2EE0	12001	R	–	INT16U	–	A/E	A/E/P/H	X	–	Circuit breaker status register
						A/E	A/E/P/H	X	0	OF status indication contact 0 = The circuit breaker is open. 1 = The circuit breaker is closed.
						A/E	A/E/P/H	X	1	SD trip indication contact 0 = Circuit breaker is not tripped. 1 = Circuit breaker is tripped due to electrical default or shunt trip or push-to-trip. Bit always equal to 0 for MasterPact NT/NW and ComPacT NS circuit breakers with motor mechanism.
						A/E	A/E/P/H	X	2	SDE fault trip indication contact 0 = Circuit breaker is not tripped on electrical default. 1 = Circuit breaker is tripped due to electrical default (including ground-fault test and earth-leakage test).
						–	A/E/P/H	X	3	CH spring charged contact (only with MasterPact) 0 = Spring discharged 1 = Spring charged Bit always equal to 0 for ComPacT NS circuit breaker.
						–	–	–	4	Reserved
						–	A/E/P/H	X	5	PF ready to close contact (only with MasterPact) 0 = Not ready to close 1 = Ready to close Bit always equal to 0 for ComPacT NS circuit breaker.
						–	A/E/P/H	X	6	Distinction between ComPacT NS and MasterPact NT/NW 0 = ComPacT NS 1 = MasterPact NT/NW
						–	–	–	7–14	Reserved

Address	Register	RW	Unit	Type	Range	A/E	A/E/P/H	X	Bit	Description
						A/E	–	X	15	Data availability If this bit is set at 1, all other bits of the register are not significant.

IO Status Registers

Address	Register	RW	Unit	Type	Range	A/E	A/E/P/H	X	Bit	Description
0x2EE1	12002	R	–	INT16U	–	A/E	A/E/P/H	X	–	Status IO 1
									0	Input 1 status • 0 = Off • 1 = On
									1	Input 2 status • 0 = Off • 1 = On
									2	Input 3 status • 0 = Off • 1 = On
									3	Input 4 status • 0 = Off • 1 = On
									4	Input 5 status • 0 = Off • 1 = On
									5	Input 6 status • 0 = Off • 1 = On
									6	Output 1 status • 0 = Off • 1 = On
									7	Output 2 status • 0 = Off • 1 = On
									8	Output 3 status • 0 = Off • 1 = On
									9–14	Reserved
									15	Data availability If this bit is set at 1, all other bits of the register are not significant.
0x2EE2	12003	R	–	INT16U	–	A/E	A/E/P/H	X	–	Status IO 2
									0	Input 1 status • 0 = Off • 1 = On
									1	Input 2 status • 0 = Off • 1 = On
									2	Input 3 status • 0 = Off • 1 = On

Address	Register	RW	Unit	Type	Range	A/E	A/E/P/H	X	Bit	Description
									3	Input 4 status • 0 = Off • 1 = On
									4	Input 5 status • 0 = Off • 1 = On
									5	Input 6 status • 0 = Off • 1 = On
									6	Output 1 status • 0 = Off • 1 = On
									7	Output 2 status • 0 = Off • 1 = On
									8	Output 3 status • 0 = Off • 1 = On
									9–14	Reserved
									15	Data availability If this bit is set at 1, all other bits of the register are not significant.

Tripping Cause

The tripping cause register provides information about the cause of the trip for the standard protection functions. When a tripping cause bit is at 1 in the tripping cause register, it indicates that a trip has occurred and has not been reset.

- For MicroLogic A/E trip units for ComPacT NSX circuit breakers, the tripping cause bit is reset by pressing the OK key (keypad of the MicroLogic A/E trip unit) twice (validation and confirmation).
- For MicroLogic A/E/P/H trip units for MasterPact NT/NW and ComPacT NS circuit breakers, the tripping cause bit is reset as soon as the circuit breaker is closed again.
- For MicroLogic X control units for MasterPact MTZ circuit breakers, the tripping cause bit is reset by pressing the test/reset button (located beside the trip cause LEDs on the MicroLogic X control unit). Press and hold the button for 3 to 15 seconds to reset all the trip causes.

Address	Register	RW	Unit	Type	Range	A/E	A/E/P/H	X	Bit	Description
0x2EE3	12004	R	–	INT16U	–	A/E	A/E/P/H	X	–	Tripping cause for the standard protection functions
						A/E	A/E/P/H	X	0	Long-time protection I _r
						A/E	P/H	X	1	Short-time protection I _{sd}
						–	A/E	X	1	Short-time protection I _{sd} or Instantaneous protection I _i
						A/E	P/H	X	2	Instantaneous protection I _i
						A/E	A/E/P/H	X	3	Ground-fault protection I _g
						E	A/P/H	X	4	Earth-leakage protection I _{Δn}
						A/E	A/E/P/H	X	5	Integrated instantaneous protection (SELLIM and DIN/DINF)

Address	Register	RW	Unit	Type	Range	A/E	A/E/P/H	X	Bit	Description
						A/E	–	X	6	Internal failure (STOP)
						–	A/E	–		Other protections or integrated instantaneous protection
						–	P/H	–		Internal failure (temperature)
						–	A/E/P/H	–	7	Internal failure (overvoltage)
						–	P/H	X		8
						E	–	–	9	Instantaneous with earth-leakage protection on the trip unit.
						E	–	–	10	Unbalance motor protection
						E	–	–	11	Jam motor protection
						E	–	–	12	Underload motor protection
						E	–	–	13	Long-start motor protection
						A/E	–	–	14	Reflex tripping protection
						A/E	A/E/P/H	X	15	If this bit is at 1, bits 0 to 14 are not valid.
0x2EE4	12005	R	–	INT16U	–	–	P/H	X	–	Tripping causes for the advanced protection functions
						–	P/H	–	0	Current unbalance
						–	P/H	–	1	Overcurrent on phase 1
						–	P/H	–	2	Overcurrent on phase 2
						–	P/H	–	3	Overcurrent on phase 3
						–	P/H	–	4	Overcurrent on Neutral
						–	P/H	X	5	Undervoltage
						–	P/H	X	6	Overvoltage
						–	P/H	–	7	Voltage unbalance
						–	P/H	–	8	Overpower
						–	P/H	X	9	Reverse power
						–	P/H	X	10	Underfrequency
						–	P/H	X	11	Overfrequency
						–	P/H	–	12	Phase rotation
						–	P/H	–	13	Load shedding based on current
–	P/H	–	14	Load shedding based on power						
–	P/H	X	15	If this bit is at 1, bits 0 to 14 are not valid.						
0x2EE5– 0x2EE6	12006– 12007	–	–	–	–	–	–	–	–	Reserved

Overrun of the Protection Setpoints

The alarm setpoint registers provide information about overrun of the standard and advanced protection setpoints. A bit is at 1 once a setpoint overrun has occurred, even if the time delay has not expired.

Address	Register	RW	Unit	Type	Range	A/E	A/E/P/H	X	Bit	Description
0x2EE7	12008	R	–	INT16U	–	A/E	P/H	–	–	Overrun of the standard protection setpoints

Address	Register	RW	Unit	Type	Range	A/E	A/E/P/H	X	Bit	Description
						A/E	P/H	-	0	Long-time protection pick-up
						-	-	-	1-14	Reserved
						A/E	P/H	-	15	If this bit is at 1, bits 0 to 14 are not valid.
0x2EE8	12009	R	-	INT16U	-	-	P/H	-	-	Overrun of the advanced protection setpoints
						-	P/H	-	0	Current unbalance
						-	P/H	-	1	Maximum current on phase 1
						-	P/H	-	2	Maximum current on phase 2
						-	P/H	-	3	Maximum current on phase 3
						-	P/H	-	4	Maximum current on the neutral
						-	P/H	-	5	Minimum voltage
						-	P/H	-	6	Maximum voltage
						-	P/H	-	7	Voltage unbalance
						-	P/H	-	8	Maximum power
						-	P/H	-	9	Reverse power
						-	P/H	-	10	Minimum frequency
						-	P/H	-	11	Maximum frequency
						-	P/H	-	12	Phase rotation
						-	P/H	-	13	Load shedding based on the current
-	P/H	-	14	Load shedding based on the power						
-	P/H	-	15	If this bit is at 1, bits 0 to 14 are not valid.						
0x2EE9	12010	R	-	INT16U	-	-	P/H	-	-	Continuation of the previous register
						-	P/H	-	0	Ground-fault alarm
						E	P/H	-	1	Earth-leakage alarm
						-	-	-	2-14	Reserved
						-	P/H	-	15	If this bit is at 1, bits 0 to 14 are not valid.

Alarms

The alarm register provides information about the pre-alarms and the user-defined alarms. A bit is set to 1 once an alarm is active.

Address	Register	RW	Unit	Type	Range	A/E	A/E/P/H	X	Bit	Description
0x2EEA	12011	R	-	INT16U	-	A/E	-	X	-	Pre-alarm register
						A/E	-	X	0	Long-time protection time pre-alarm (PAL Ir)
						E	-	-	1	Earth-leakage protection pre-alarm (PAL IΔn)
						-	-	X	-	Earth-leakage alarm ⁽¹⁾

Address	Register	RW	Unit	Type	Range	A/E	A/E/P/H	X	Bit	Description
						A/E	–	–	2	Ground-fault protection pre-alarm (PAL Ig)
						–	–	X		Ground-fault alarm ⁽²⁾
						–	–	–	3–14	Reserved
						A/E	–	X	15	If this bit is at 1, bits 0 to 14 are not valid.
0x2EEB	12012	R	–	INT16U	–	A/E	–	–	–	Register of user-defined alarms
						A/E	–	–	0	User-defined alarm 201
						A/E	–	–	1	User-defined alarm 202
						A/E	–	–	2	User-defined alarm 203
						A/E	–	–	3	User-defined alarm 204
						A/E	–	–	4	User-defined alarm 205
						A/E	–	–	5	User-defined alarm 206
						A/E	–	–	6	User-defined alarm 207
						A/E	–	–	7	User-defined alarm 208
						A/E	–	–	8	User-defined alarm 209
						A/E	–	–	9	User-defined alarm 210
						–	–	–	10–14	Reserved
A/E	–	–	15	If this bit is at 1, bits 0 to 14 are not valid.						
0x2EEC– 0x2EEE	12013– 12015	–	–	–	–	–	–	–	–	Reserved

(1) Value available on MicroLogic 7.0 X control unit only when the Digital Module ANSI 51N/51G Ground-fault alarm is installed.

(2) Value available on MicroLogic 2.0 X, 3.0 X, 5.0 X, and 6.0 X control units only when the Digital Module ANSI 51N/51G Ground-fault alarm is installed.

Current

Address	Register	RW	Unit	Type	Range	A/E	A/E/P/H	X	Description
0x2EEF	12016	R	A	INT16U	0–32767	A/E	A/E/P/H	X	RMS current on phase 1: I1
0x2EF0	12017	R	A	INT16U	0–32767	A/E	A/E/P/H	X	RMS current on phase 2: I2
0x2EF1	12018	R	A	INT16U	0–32767	A/E	A/E/P/H	X	RMS current on phase 3: I3
0x2EF2	12019	R	A	INT16U	0–32767	A/E	A/E/P/H	X	RMS current on the neutral: IN ⁽¹⁾
0x2EF3	12020	R	A	INT16U	0–32767	A/E	A/E/P/H	X	Maximum of I1, I2, I3, and IN
0x2EF4	12021	R	%Ig	INT16U	0–32767	A/E	A/E/P/H	X	Ground-fault current Ig ⁽²⁾
0x2EF5	12022	R	%IΔn	INT16U	0–32767	E	A/P/H	X	Earth-leakage current IΔn ⁽³⁾

(1) This value cannot be accessed for motor applications and in cases of three-pole circuit breakers without external neutral current transformer (ENCT).

(2) This value is only available:

- For MasterPact MTZ MicroLogic 6.0 X control units, expressed as %Ig pick-up
- For MasterPact NT/NW and ComPacT NS MicroLogic 6.0 trip units, expressed as %Ig pick-up
- For ComPacT NSX MicroLogic 6.2 and 6.3 trip units, expressed as %Ig pick-up

(3) This value is only available:

- For MasterPact MTZ MicroLogic 7.0 X control units, expressed as %IΔn pick-up
- For MasterPact NT/NW and ComPacT NS MicroLogic 7.0 trip units, expressed as %IΔn pick-up
- For ComPacT NSX MicroLogic 7.2 and 7.3 trip units, expressed as %IΔn pick-up

Maximum Current Values

Maximum current values can be reset with the reset minimum/maximum command.

Address	Register	RW	Unit	Type	Range	A/E	A/E/P/H	X	Description
0x2EF6	12023	R	A	INT16U	0–32767	A/E	A/E/P/H	X	Maximum RMS current on phase 1: I1
0x2EF7	12024	R	A	INT16U	0–32767	A/E	A/E/P/H	X	Maximum RMS current on phase 2: I2
0x2EF8	12025	R	A	INT16U	0–32767	A/E	A/E/P/H	X	Maximum RMS current on phase 3: I3
0x2EF9	12026	R	A	INT16U	0–32767	A/E	A/E/P/H	X	Maximum RMS current on the neutral: IN ⁽¹⁾
0x2EFA	12027	R	A	INT16U	0–32767	A/E	A/E/P/H	X	Maximum RMS current out of the 4 previous registers
0x2EFB	12028	R	%Ig	INT16U	0–32767	A/E	A/E/P/H	X	Maximum ground-fault current Ig ⁽²⁾
0x2EFC	12029	R	%IΔn	INT16U	0–32767	E	A/P/H	X	Maximum earth-leakage current ⁽³⁾

(1) This value cannot be accessed for motor applications and in cases of three-pole circuit breakers without external neutral current transformer (ENCT).

(2) This value is only available:

- For MasterPact MTZ MicroLogic 6.0 X control units, expressed as %Ig pick-up
- For MasterPact NT/NW and ComPacT NS MicroLogic 6.0 trip units, expressed as %Ig pick-up
- For ComPacT NSX MicroLogic 6.2 and 6.3 trip units, expressed as %Ig pick-up

(3) This value is only available:

- For MasterPact MTZ MicroLogic 7.0 X control units, expressed as %IΔn pick-up
- For MasterPact NT/NW and ComPacT NS MicroLogic 7.0 trip units, expressed as %IΔn pick-up
- For ComPacT NSX MicroLogic 7.2 and 7.3 trip units, expressed as %IΔn pick-up

Voltage

Address	Register	RW	Unit	Type	Range	A/E	A/E/P/H	X	Description
0x2EFD	12030	R	V	INT16U	0–1200	E	E/P/H	X	RMS phase-to-phase voltage V12
0x2EFE	12031	R	V	INT16U	0–1200	E	E/P/H	X	RMS phase-to-phase voltage V23
0x2EFF	12032	R	V	INT16U	0–1200	E	E/P/H	X	RMS phase-to-phase voltage V31
0x2F00	12033	R	V	INT16U	0–1200	E	E/P/H	X	RMS phase-to-neutral voltage V1N ⁽¹⁾
0x2F01	12034	R	V	INT16U	0–1200	E	E/P/H	X	RMS phase-to-neutral voltage V2N ⁽¹⁾
0x2F02	12035	R	V	INT16U	0–1200	E	E/P/H	X	RMS phase-to-neutral voltage V3N ⁽¹⁾

(1) This value cannot be accessed for motor applications and in cases of three-pole circuit breakers without external neutral voltage transformer (ENVT).

Frequency

When the MicroLogic trip unit cannot calculate the frequency, it returns Not applicable = 32768 (0x8000).

Address	Register	RW	Unit	Type	Range	A/E	A/E/P/H	X	Description
0x2F03	12036	R	0.1 Hz	INT16U	400–600	E	P/H	X	Frequency
0x2F04	12037	R	0.1 Hz	INT16U	400–600	E	P/H	X	Maximum frequency ⁽¹⁾

(1) This value can be reset with the reset minimum/maximum command.

Power

Address	Register	RW	Unit	Type	Range	A/E	A/E/P/H	X	Description
0x2F05	12038	R	0.1 kW	INT16	-32767– +32767	E	E/P/H	X	Active power on phase 1: P1 ^{(1) (2)}
0x2F06	12039	R	0.1 kW	INT16	-32767– +32767	E	E/P/H	X	Active power on phase 2: P2 ^{(1) (2)}
0x2F07	12040	R	0.1 kW	INT16	-32767– +32767	E	E/P/H	X	Active power on phase 3: P3 ^{(1) (2)}
0x2F08	12041	R	0.1 kW	INT16	-32767– +32767	E	E/P/H	X	Total active power: P _{tot} ⁽²⁾
0x2F09	12042	R	0.1 kVAR	INT16	-32767– +32767	E	E/P/H	X	Reactive power on phase 1: Q1 ^{(1) (2)}
0x2F0A	12043	R	0.1 kVAR	INT16	-32767– +32767	E	E/P/H	X	Reactive power on phase 2: Q2 ^{(1) (2)}
0x2F0B	12044	R	0.1 kVAR	INT16	-32767– +32767	E	E/P/H	X	Reactive power on phase 3: Q3 ^{(1) (2)}
0x2F0C	12045	R	0.1 kVAR	INT16	-32767– +32767	E	E/P/H	X	Total reactive power: Q _{tot} ⁽²⁾
0x2F0D	12046	R	0.1 kVA	INT16U	0–32767	E	E/P/H	X	Apparent power on phase 1: S1 ⁽¹⁾
0x2F0E	12047	R	0.1 kVA	INT16U	0–32767	E	E/P/H	X	Apparent power on phase 2: S2 ⁽¹⁾
0x2F0F	12048	R	0.1 kVA	INT16U	0–32767	E	E/P/H	X	Apparent power on phase 3: S3 ⁽¹⁾
0x2F10	12049	R	0.1 kVA	INT16U	0–32767	E	E/P/H	X	Total apparent power: Stot

(1) This value cannot be accessed for motor applications and in cases of three-pole circuit breakers without external neutral current transformer (ENCT).

(2) The sign for the active and reactive power depends on the configuration of:

- register 3316 for ComPacT NSX, ComPacT NS and MasterPact NT/NW circuit breakers.
- register 8405 for MasterPact MTZ circuit breakers.

Energy

Energy is stored in big-endian format: the most significant register is transmitted first, the least significant second.

Address	Register	RW	Unit	Type	Range	A/E	A/E/P/H	X	Description
0x2F11– 0x2F12	12050– 12051	R	kWh	INT32	-1 999 999 999– +1 999 999 999	E	E/P/H	X	Active energy: E _p ⁽¹⁾
0x2F13– 0x2F14	12052– 12053	R	kVARh	INT32	-1 999 999 999– +1 999 999 999	E	E/P/H	X	Reactive energy: E _q ⁽¹⁾
0x2F15– 0x2F16	12054– 12055	R	kWh	INT32U	0–1 999 999 999	E	P/H	X	Active energy counted positively: E _{pIn}
0x2F17– 0x2F18	12056– 12057	R	kWh	INT32U	0–1 999 999 999	E	P/H	X	Active energy counted negatively: E _{pOut}

Address	Register	RW	Unit	Type	Range	A/E	A/E/P/H	X	Description
0x2F19– 0x2F1A	12058– 12059	R	kVARh	INT32U	0–1 999 999 999	E	P/H	X	Reactive energy counted positively: EqIn
0x2F1B– 0x2F1C	12060– 12061	R	kVARh	INT32U	0–1 999 999 999	E	P/H	X	Reactive energy counted negatively: EqOut
0x2F1D– 0x2F1E	12062– 12063	R	kVAh	INT32U	0–1 999 999 999	E	E/P/H	X	Total apparent energy: Es
0x2F1F– 0x2F20	12064– 12065	R	kWh	INT32U	0–1 999 999 999	E	–	X	Active energy counted positively (non-resettable): Epln
0x2F21– 0x2F22	12066– 12067	R	kWh	INT32U	0–1 999 999 999	E	–	X	Active energy counted negatively (non-resettable): EpOut
0x2F23– 0x2F2E	12068– 12079	–	–	–	–	–	–	–	Reserved

(1) This value is always positive with MicroLogic E trip units for MasterPact NT/NW and ComPacT NS circuit breakers.

Current Demand Values

Address	Register	RW	Unit	Type	Range	A/E	A/E/P/H	X	Description
0x2F2F	12080	R	A	INT16U	0–32767	E	E/P/H	X	Current demand value on phase 1: I1 Dmd
0x2F30	12081	R	A	INT16U	0–32767	E	E/P/H	X	Current demand value on phase 2: I2 Dmd
0x2F31	12082	R	A	INT16U	0–32767	E	E/P/H	X	Current demand value on phase 3: I3 Dmd
0x2F32	12083	R	A	INT16U	0–32767	E	E/P/H	X	Current demand value on the neutral: IN Dmd ⁽¹⁾

(1) This value cannot be accessed for motor applications and in cases of three-pole circuit breakers without external neutral current transformer (ENCT).

Power Demand Values

When the window is fixed type, this value is updated at the end of the window. For the sliding type, the value is updated every 15 seconds.

Address	Register	RW	Unit	Type	Range	A/E	A/E/P/H	X	Description
0x2F33	12084	R	0.1 kW	INT16U	0–32767	E	E/P/H	X	Total active power demand: P Dmd
0x2F34	12085	R	0.1 kVAR	INT16U	0–32767	E	P/H	X	Total reactive power demand: Q Dmd
0x2F35	12086	R	0.1 kVA	INT16U	0–32767	E	P/H	X	Total apparent power demand: S Dmd
0x2F36– 0x2F38	12087– 12089	–	–	–	–	–	–	–	Reserved

Maximum Voltage Values

Maximum voltage values can be reset with the reset minimum/maximum command.

Register = 0 if the voltage < 25 V.

Address	Register	RW	Unit	Type	Range	A/E	A/E/P/H	X	Description
0x2F39	12090	R	V	INT16U	0–1200	E	E/P/H	X	Maximum RMS phase-to-phase voltage V12
0x2F3A	12091	R	V	INT16U	0–1200	E	E/P/H	X	Maximum RMS phase-to-phase voltage V23
0x2F3B	12092	R	V	INT16U	0–1200	E	E/P/H	X	Maximum RMS phase-to-phase voltage V31
0x2F3C	12093	R	V	INT16U	0–1200	E	E/P/H	X	Maximum RMS phase-to-neutral voltage V1N ⁽¹⁾
0x2F3D	12094	R	V	INT16U	0–1200	E	E/P/H	X	Maximum RMS phase-to-neutral voltage V2N ⁽¹⁾
0x2F3E	12095	R	V	INT16U	0–1200	E	E/P/H	X	Maximum RMS phase-to-neutral voltage V3N ⁽¹⁾

(1) This value cannot be accessed for motor applications and in cases of three-pole circuit breakers without external neutral voltage transformer (ENVT).

Power Factor

The sign for the fundamental power factor ($\cos\phi$) depends on the MicroLogic configuration.

Address	Register	RW	Unit	Type	Range	A/E	A/E/P/H	X	Description
0x2F3F	12096	R	0.01	INT16	-100– +100	E	E/P/H	X	Power factor on phase 1: PF1 ⁽¹⁾
0x2F40	12097	R	0.01	INT16	-100– +100	E	E/P/H	X	Power factor on phase 2: PF2 ⁽¹⁾
0x2F41	12098	R	0.01	INT16	-100– +100	E	E/P/H	X	Power factor on phase 3: PF3 ⁽¹⁾
0x2F42	12099	R	0.01	INT16	-100– +100	E	E/P/H	X	Total power factor: PF
0x2F43	12100	R	0.01	INT16	-100– +100	E	H	X	Fundamental power factor on phase 1: $\cos\phi_1$ ⁽¹⁾
0x2F44	12101	R	0.01	INT16	-100– +100	E	H	X	Fundamental power factor on phase 2: $\cos\phi_2$ ⁽¹⁾
0x2F45	12102	R	0.01	INT16	-100– +100	E	H	X	Fundamental power factor on phase 3: $\cos\phi_3$ ⁽¹⁾
0x2F46	12103	R	0.01	INT16	-100– +100	E	H	X	Total fundamental power factor: $\cos\phi$

(1) This value cannot be accessed for motor applications and in cases of three-pole circuit breakers without external neutral voltage transformer (ENVT).

Total Harmonic Distortion (THD)

Address	Register	RW	Unit	Type	Range	A/E	A/E/P/H	X	Description
0x2F47	12104	R	0.1 %	INT16U	0–5000	E	H	X	Total harmonic distortion of V12 compared to the fundamental
0x2F48	12105	R	0.1 %	INT16U	0–5000	E	H	X	Total harmonic distortion of V23 compared to the fundamental
0x2F49	12106	R	0.1 %	INT16U	0–5000	E	H	X	Total harmonic distortion of V31 compared to the fundamental

Address	Register	RW	Unit	Type	Range	A/E	A/E/P/H	X	Description
0x2F4A	12107	R	0.1 %	INT16U	0–5000	E	H	X	Total harmonic distortion of V1N compared to the fundamental ⁽¹⁾
0x2F4B	12108	R	0.1 %	INT16U	0–5000	E	H	X	Total harmonic distortion of V2N compared to the fundamental ⁽¹⁾
0x2F4C	12109	R	0.1 %	INT16U	0–5000	E	H	X	Total harmonic distortion of V3N compared to the fundamental ⁽¹⁾
0x2F4D	12110	R	0.1 %	INT16U	0–5000	E	H	X	Total harmonic distortion of I1 compared to the fundamental
0x2F4E	12111	R	0.1 %	INT16U	0–5000	E	H	X	Total harmonic distortion of I2 compared to the fundamental
0x2F4F	12112	R	0.1 %	INT16U	0–5000	E	H	X	Total harmonic distortion of I3 compared to the fundamental
0x2F50	12113	R	0.1 %	INT16U	0–5000	E	H	X	Total harmonic distortion of total current compared to the fundamental

(1) This value cannot be accessed for motor applications and in cases of three-pole circuit breakers without external neutral voltage transformer (ENVT).

Counters

Address	Register	RW	Unit	Type	Range	A/E	A/E/P/H	X	Description
0x2F7F	12160	R	–	INT16U	0–32766	A/E	A/E/P/H	X	Trip counter
0x2F80	12161	R	–	INT16U	0–32766	A/E	A/E/P/H	X	Counter of alarms with priority level = 3 (high)
0x2F81	12162	R	–	INT16U	0–32766	A/E	A/E/P/H	X	Counter of alarms with priority level = 2 (medium)
0x2F82	12163	R	–	INT16U	0–32766	A/E	A/E/P/H	X	Counter of alarms with priority level = 1 (low)

Miscellaneous

Address	Register	RW	Unit	Type	Range	A/E	A/E/P/H	X	Bit	Description
0x2F83	12164	R	–	INT16U	–	A/E	A/E/P/H	X	–	Validity of the breaker close inhibit
									0	Validity of the breaker close inhibit by IO module
									1	Validity of the breaker close inhibit by remote controller
									2–15	Reserved
0x2F84	12165	R	–	INT16U	–	A/E	A/E/P/H	X	–	Status of the breaker close inhibit
									0	Status of the breaker close inhibit by IO module
									1	Status of the breaker close inhibit by remote controller
									2–15	Reserved

MicroLogic Control Unit Data for MasterPact MTZ Circuit Breakers

What's in This Part

MicroLogic Control Unit Registers.....	109
MicroLogic Control Unit Commands.....	167
MicroLogic Control Unit Protection Commands with Session	196

MicroLogic X User Guide

For more information about the MicroLogic X functions, refer to [DOCA0102EN](#)
MasterPact MTZ – MicroLogic X Control Unit – User Guide.

MicroLogic Control Unit Registers

What's in This Chapter

Tripping Data	110
Circuit Breaker Data	117
Circuit Breaker Characteristics	120
Real-Time Measurements	124
Harmonic Values	131
Minimum and Maximum Values of Real-Time Measurements	144
Maintenance and Diagnostic Data	154
Energy Measurements.....	159
Protection Settings	162
Demand Values of Real-Time Measurements	164
Peak Values of Demand Values of Real-Time Measurements	165

Tripping Data

Tripping Data Monitoring

To monitor the tripping data, it is recommended:

- to read the tripping cause registers regularly
- to read the data related to the last trip only after detection of a tripping cause:
 - Last trip event
 - ZSI status before the last trip
 - Setting group and settings of protection responsible for the last trip
 - Interrupted currents and measurement before the last trip

Tripping Cause

Address	Register	RW	Unit	Type	Range	Bit	Description
0x7E56– 0x7E57	32343– 32344	R	–	INT32U	–	–	Alarm change counter
0x7E58	32345	R	–	INT16U	–	–	Quality of each bit of register 32346: <ul style="list-style-type: none"> • 0 = Invalid • 1 = Valid
0x7E59	32346	R	–	INT16U	–	0	Reserved
						1	Alarm status synthesis: <ul style="list-style-type: none"> • 0 = No active alarms • 1 = At least one alarm is active
						2–15	Reserved
0x7E5A– 0x7E72	32347– 32371	R	–	INT16U	–	–	Quality of each bit of registers 32372-32396: <ul style="list-style-type: none"> • 0 = Invalid • 1 = Valid
0x7E73	32372	R	–	INT16U	–	0	Ir trip
						1	I _{sd} trip
						2	I _{li} trip
						3	I _{lg} trip
						4	I Δ n trip
						5	Ultimate self-protection trip (SELLIM)
						6	Self diagnostic trip
						7	Optional protection trip
						8	Ultimate self-protection trip (DIN/DINF)
						9	I Δ n/I _g test trip
						10–11	Reserved
						12	IDMTL long time trip
						13	Reserved
						14	Undervoltage on 1 phase trip
						15	Overvoltage on 1 phase trip
0x7E74	32373	R	–	INT16U	–	0	Reserved
						1	Reverse power trip
						2	Underfrequency trip

Address	Register	RW	Unit	Type	Range	Bit	Description
						3	Overfrequency trip
						4	Reserved
						5	Forward directional overcurrent trip
						6-7	Reserved
						8	Undervoltage on all 3 phases trip
						9	Overvoltage on all 3 phases trip
						10	Reverse directional overcurrent trip
						11-14	Reserved
						15	IDMT ground fault trip
0x7E75	32374	–	–	–	–	–	Reserved
0x7E76	32375	–	–	–	–	0	Circuit breaker self-diagnostic trip
						1-15	Reserved

Protection Data

Address	Register	RW	Unit	Type	Range	Bit	Description
0x7E77	32376	R	–	INT16U	–	0	I _r start ($I > 105\% I_r$)
						1	I _{sd} start
						2	I _g start
						3	I Δ n start
						4	Ultimate self-protection (SELLIM) operate
						5-7	Reserved
						8	Ultimate self-protection (DIN/DINF) operate
						9-11	Reserved
						12	IDMTL long time start
						13	Reserved
						14	Undervoltage on 1 phase start
						15	Overvoltage on 1 phase start
0x7E78	32377	R	–	INT16U	–	0	Reserved
						1	Reverse power start
						2	Underfrequency start
						3	Overfrequency start
						4	Reserved
						5	Forward directional overcurrent start
						6-7	Reserved
						8	Undervoltage on all 3 phases start
						9	Overvoltage on all 3 phases start
						10	Reverse directional overcurrent start
						11-14	Reserved
						15	IDMT ground fault start
0x7E79	32378	R	–	INT16U	–	0	I _r operate
						1	I _{sd} operate

Address	Register	RW	Unit	Type	Range	Bit	Description
						2	li operate
						3	lg operate
						4	IΔn operate
						5–11	Reserved
						12	IDMTL long time operate
						13	Reserved
						14	Undervoltage on 1 phase operate
						15	Overvoltage on 1 phase operate
0x7E7A	32379	R	–	INT16U	–	0	Reserved
						1	Reverse power operate
						2	Underfrequency operate
						3	Overfrequency operate
						4	Reserved
						5	Forward directional overcurrent operate
						6–7	Reserved
						8	Undervoltage on all 3 phases operate
						9	Overvoltage on all 3 phases operate
						10	Reverse directional overcurrent operate
						11–14	Reserved
						15	IDMT ground fault operate
0x7E7B	32380	R	–	INT16U	–	0–8	Reserved
						9	Forward directional overcurrent received
						10	Reverse directional overcurrent received
						11	Forward directional overcurrent sent
						12	Reverse directional overcurrent sent
						13	Request to unlock ERMS by smartphone
						14–15	Reserved
0x7E7C	32381	R	–	INT16U	–	0	Thermal memory reset order
						1	Ir prealarm ($I > 90\% I_r$)
						2	lg alarm
						3	IΔn alarm
						4–7	Reserved
						8	ERMS engaged
						9	ERMS engaged for more than 24 hours
						10	Reserved
						11	Active curve: <ul style="list-style-type: none"> • 0 = A curve active • 1 = B curve active
						12	Reserved
						13	Optional protections inhibited by IO
						14	ESM (ERMS switch module) self-diagnostic alarm

Address	Register	RW	Unit	Type	Range	Bit	Description
						15	Communication lost with ESM (ERMS switch module)

Last Trip Event

Address	Register	RW	Unit	Type	Range	Bit	Description
0x0227	552	R	–	INT16U	–	–	Last trip event code: <ul style="list-style-type: none"> • Standard protection: <ul style="list-style-type: none"> ◦ 25600 (0x6400) = Ir trip ◦ 25601 (0x6401) = Isd trip ◦ 25602 (0x6402) = li trip ◦ 25603 (0x6403) = lg trip ◦ 25604 (0x6404) = lviigi trip ◦ 25606 (0x6406) = Ultimate self-protection trip (SELLIM) ◦ 25607 (0x6407) = Internal failure • Optional protection: <ul style="list-style-type: none"> ◦ 25616 (0x6410) = Undervoltage on one phase trip ◦ 25617 (0x6411) = Overvoltage on one phase trip ◦ 25620 (0x6414) = Reverse power trip ◦ 25621 (0x6415) = Underfrequency trip ◦ 25622 (0x6416) = Overfrequency trip ◦ 25629 (0x641D) = Ultimate self-protection trip (DIN/DINF) ◦ 25630 (0x641E) = Ground fault and earth-leakage test trip ◦ 25633 (0x6421) = IDMTL long time trip ◦ 25635 (0x6423) = Forward directional overcurrent trip ◦ 25636 (0x6424) = Reverse directional overcurrent trip ◦ 25642 (0x642A) = Undervoltage on all 3 phases trip ◦ 25643 (0x642B) = Overvoltage on all 3 phases trip ◦ 25649 (0x6431) = Optional protection trip ◦ 25650 (0x6432) = IDMT ground fault trip
0x0228–0x022B	553-556	R	–	DATETIME	–	–	Timestamp of last trip event
0x022C	557	R	–	INT16U	–	–	Timestamp quality of last trip event
0x022D	558	–	–	–	–	–	Reserved
0x022E	559	R	–	INT16U	–	–	Quality of each bit of registers 560, page 67: <ul style="list-style-type: none"> • 0 = Invalid • 1 = Valid
0x022F	560	R	–	INT16U	–	–	Last trip event origin electrical fault: <ul style="list-style-type: none"> • 0 = Inactive • 1 = Active

Address	Register	RW	Unit	Type	Range	Bit	Description
						0	Fault on phase 1
						1	Fault on phase 2
						2	Fault on phase 3
						3	Fault on neutral
						4–15	Reserved

ZSI Status Before Last Trip

Address	Register	RW	Unit	Type	Range	Bit	Description
0x0231	562	R	–	INT16U	–	–	Quality of each bit of register 563: <ul style="list-style-type: none"> • 0 = Invalid • 1 = Valid
0x0232	563	R	–	INT16U	–	0	ZSI in status before last trip: <ul style="list-style-type: none"> • 0 = Not energized • 1 = Energized
						1	ZSI out status before last trip: <ul style="list-style-type: none"> • 0 = Not energized • 1 = Energized
						2–15	Reserved

Setting Group of the Last Trip

If a standard protection is responsible of the last trip, the settings of the standard protection responsible of the last trip are recorded in the following registers:

Address	Register	RW	Unit	Type	Range	Description
0x0233	564	R	–	INT16U	1–128	Setting group of the last trip: <ul style="list-style-type: none"> • 1 = Setting group A • 2 = Setting group B • 3 = Setting group ERMS • 128 = Fallback settings • 255 = N/A

Settings of Protection Responsible of the Last Trip

If a standard protection is responsible of the last trip, the settings of the standard protection responsible of the last trip are recorded in the following registers:

Address	Register	RW	Unit	Type	Range	Description
0x0234– 0x0235	565–566	R	–	FLOAT32	–	Generic standard protection last parameter 1
0x0236– 0x0237	567–568	R	–	FLOAT32	–	Generic standard protection last parameter 2
0x0238– 0x0239	569–570	R	–	FLOAT32	–	Generic standard protection last parameter 3
0x023A– 0x023B	571–572	R	–	FLOAT32	–	Generic standard protection last parameter 4
0x023C	573	R	–	INT16U	–	Generic standard protection last parameter 5
0x023D	574	R	–	INT16U	–	Generic standard protection last parameter 6

The following table defines the parameters corresponding to the 6 generic standard protection last parameters according to the protection responsible of the last trip, indicated by register 552.

Protection responsible of the last trip	Registers						
	552 Last trip event code	565-566 Generic protection last parameter 1	567-568 Generic protection last parameter 2	569-570 Generic protection last parameter 3	571-572 Generic protection last parameter 4	573 Generic protection last parameter 5	574 Generic protection last parameter 6
Overload protection (Long time)	25600 (0x6400)	Long time over current protection threshold	–	Long time over current protection time delay	–	Long time over current protection curve: • 1 = I ² t On	–
Short circuit protection (Short time)	25601 (0x6401)	Short time over current protection threshold	–	Short time over current protection time delay	–	Short time over current protection curve: • 0 = I ² t Off • 1 = I ² t On	–
Instantaneous protection	25602 (0x6402)	Instantaneous over current protection threshold	–	–	–	Instantaneous over current protection mode: • 0 = Off • 1 = On	Instantaneous over current protection time delay mode: • 0 = Standard • 1 = Fast
Ground fault protection	25603 (0x6403)	Ground fault protection threshold	–	Ground fault protection time delay	–	Ground fault protection curve: • 0 = I ² t Off • 1 = I ² t On	Ground fault protection mode: • 0 = Off • 1 = On
Earth leakage protection	25604 (0x6404)	Earth leakage threshold	–	Earth leakage protection delay	–	–	–
Ultimate self-protection SELLIM	25606 (0x6406)	SELLIM threshold	–	–	–	–	–
Internal failure	25607 (0x6407)	–	–	–	–	–	–
Ultimate self-protection DIN/ DINF	25629 (0x641D)	DIN threshold	DINF threshold	–	–	–	–
Ground fault test trip	25630 (0x641E)	Ground fault protection threshold	–	Ground fault protection time delay	–	Ground fault protection curve: • 0 = I ² t Off • 1 = I ² t On	–
Earth leakage test trip		–	Earth leakage protection threshold	–	Earth leakage protection time delay	–	–

NOTE: If an optional protection is responsible of the last trip, use the EcoStruxure Power Commission software or the EcoStruxure Power Device App to get the settings of the optional protection responsible of the last trip.

Interrupted Current

Address	Register	RW	Unit	Type	Range	Description
0x023E– 0x023F	575–576	R	A	FLOAT32	–	Last interrupted current on phase 1 (peak)
0x0240– 0x0241	577–578	R	A	FLOAT32	–	Last interrupted current on phase 2 (peak)
0x0242– 0x0243	579–580	R	A	FLOAT32	–	Last interrupted current on phase 3 (peak)
0x0244– 0x0245	581–582	R	A	FLOAT32	–	Last interrupted current on neutral (peak)
0x0246– 0x0247	583–584	R	A	FLOAT32	–	Last interrupted ground current (peak)
0x0248– 0x0249	585–586	R	A	FLOAT32	–	Last interrupted earth leakage current (peak)

Measurement Before Last Trip

Address	Register	RW	Unit	Type	Range	Description
0x024A– 0x024B	587–588	R	A	FLOAT32	–	RMS current of phase 1 before last trip
0x024C– 0x024D	589–590	R	A	FLOAT32	–	RMS current of phase 2 before last trip
0x024E– 0x024F	591–592	R	A	FLOAT32	–	RMS current of phase 3 before last trip
0x0250– 0x0251	593–594	R	A	FLOAT32	–	RMS current of neutral before last trip
0x0252– 0x253	595–596	R	A	FLOAT32	–	RMS current of ground fault before last trip
0x0254– 0x0255	597–598	R	A	FLOAT32	–	Current earth leakage before last trip
0x0256– 0x0257	599–600	R	V	FLOAT32	–	RMS phase-to-phase voltage V12 before last trip
0x0258– 0x0259	601–602	R	V	FLOAT32	–	RMS phase-to-phase voltage V23 before last trip
0x025A– 0x025B	603–604	R	V	FLOAT32	–	RMS phase-to-phase voltage V31 before last trip
0x025C– 0x025D	605–606	R	Hz	FLOAT32	–	Frequency before last trip
0x025E– 0x025F	607–608	R	–	FLOAT32	–	Voltage unbalance V12 before last trip
0x0260– 0x0261	609–610	R	–	FLOAT32	–	Voltage unbalance V23 before last trip
0x0262– 0x0263	611–612	R	–	FLOAT32	–	Voltage unbalance V31 before last trip
0x0264– 0x0265	613–614	R	–	FLOAT32	–	Current unbalance 1 before last trip
0x0266– 0x0267	615–616	R	–	FLOAT32	–	Current unbalance 2 before last trip
0x0268– 0x0269	617–618	R	–	FLOAT32	–	Current unbalance 3 before last trip

Circuit Breaker Data

Circuit Breaker Status Register

Address	Register	RW	Unit	Type	Range	Bit	Description
0x7CFF	32000	R	–	INT16U	–	–	Quality of each bit of register 32001, page 67: <ul style="list-style-type: none"> • 0 = Invalid • 1 = Valid
0x7D00	32001	R	–	INT16U	–	–	Circuit breaker status register
						0	OF status indication contact <ul style="list-style-type: none"> • 0 = The circuit breaker is open. • 1 = The circuit breaker is closed.
						1	SD trip indication contact <ul style="list-style-type: none"> • 0 = Circuit breaker is not tripped. • 1 = Circuit breaker is tripped due to electrical fault, shunt trip, or push-to-trip. Bit always equal to 0 for MasterPact and ComPacT NS circuit breakers with motor mechanism.
						2	SDE fault trip indication contact <ul style="list-style-type: none"> • 0 = Circuit breaker is not tripped on electrical fault. • 1 = Circuit breaker is tripped due to electrical fault (including ground-fault test and earth-leakage test).
						3	CH spring charged contact (only with MasterPact) <ul style="list-style-type: none"> • 0 = Spring discharged • 1 = Spring charged Bit always equal to 0 for MasterPact and ComPacT NS circuit breakers with motor mechanism.
						4	Reserved
						5	PF ready to close contact (only with MasterPact) <ul style="list-style-type: none"> • 0 = Not ready to close • 1 = Ready to close Bit always equal to 0 for MasterPact and ComPacT NS circuit breakers with motor mechanism.
						6–15	Reserved

Inhibit Close Order

Address	Register	RW	Unit	Type	Range	Bit	Description
0x7E53	32340	R	–	INT16U	–	–	Quality of each bit of register 32341: <ul style="list-style-type: none"> • 0 = Invalid • 1 = Valid
0x7E54	32341	R	–	INT16U	–	–	Inhibit close order status
						0	Close breaker inhibited by IO module <ul style="list-style-type: none"> • 0 = Disable • 1 = Enable
						1	Close breaker inhibited by communication <ul style="list-style-type: none"> • 0 = Disable • 1 = Enable
						2–15	Reserved

Opening/Closing Release Data

Address	Register	RW	Unit	Type	Range	Bit	Description
0x7E64– 0x7E65	32357- 32358	R	–	INT16U	–	–	Quality of each bit of registers 32382-32383: <ul style="list-style-type: none"> • 0 = Invalid • 1 = Valid
0x7E66– 0x7E65	32359- 32371	R	–	INT16U	–	–	Quality of each bit of registers 32384-32396, page 154.
0x7E73– 0x7E76	32372- 32375	R	–	INT16U	–	–	Tripping cause, page 110
0x7E77– 0x7E7C	32376- 32381	R	–	INT16U	–	–	Protection data, page 111
0x7E7D	32382	R	–	INT16U	–	0	Reserved
						1	Circuit breaker opened
						2	Circuit breaker closed
						3	Reserved
						4	Closing order sent to XF voltage release
						5	Reserved
						6	Opening order sent to MX voltage release
						7	Circuit breaker did not open or close
						8	Manual mode enabled
						9	Local mode enabled
						10	Closing inhibited by communication
						11	Closing inhibited through IO module
						12	Reserved
						13	Alarm reset
						14	M2C output 1 is forced
15	M2C output 2 is forced						
0x7E7E	32383	R	–	INT16U	–	0	Reserved
						1	Allow control by digital input is disabled
						2–7	Reserved
						8	XF voltage release operation counter is above alarm threshold
						9	XF voltage release reached the maximum number of operations
						10	MX2 voltage release operation counter is above alarm threshold
						11	MX2 voltage release reached the maximum number of operations
						12	MX1 voltage release operation counter is above alarm threshold
						13	MX1 voltage release reached the maximum number of operations
						14	MN undervoltage release operation counter is above alarm threshold
15	MN undervoltage release reached the maximum number of operations						

Last Event Data

Address	Register	RW	Unit	Type	Range	Description
0x028E– 0x028F	655–656	R	–	INT32U	–	<p>Last event sequence number.</p> <p>In case of a new event, the last event sequence number will change. Therefore, you can track the occurrence of a new event by monitoring the sequence number.</p> <p>The Get Events command provides the details of the event , page 191.</p>

Remote Control Settings

Address	Register	RW	Unit	Type	Range	Bit	Description
0x0298	665	R	–	INT16U	0–1	–	<p>Remote protection setting enable:</p> <ul style="list-style-type: none"> • 0 = Disable • 1 = Enable
0x0299	666	R	–	INT16U	0–1	–	<p>Protection lock enable:</p> <ul style="list-style-type: none"> • 0 = Disable • 1 = Enable
0x029A	667	R	–	INT16U	–	–	<p>Quality of each bit of register 668:</p> <ul style="list-style-type: none"> • 0 = Invalid • 1 = Valid
0x029B	668	R	–	INT16U	–	0–4	Reserved
						5	<p>Auto mode:</p> <ul style="list-style-type: none"> • 0 = Remote • 1 = Local
						6–15	Reserved
0x029C	669	R	–	INT16U	–	–	<p>Quality of each bit of register 670:</p> <ul style="list-style-type: none"> • 0 = Invalid • 1 = Valid
0x029D	670	R	–	INT16U	–	0	Reserved
						1	<p>Control mode:</p> <ul style="list-style-type: none"> • 0 = Manual • 1 = Auto
						2–15	Reserved
0x029E– 0x029F	671–672	–	–	–	–	–	Reserved

Alarm Status

Address	Register	RW	Unit	Type	Range	Description
0x02A0	673	R	–	INT16U	–	Counter of active low-level alarms
0x02A1	674	R	–	INT16U	–	Counter of active medium-level alarms
0x02A2	675	R	–	INT16U	–	Counter of active high-level alarms

Circuit Breaker Characteristics

System Settings

Address	Register	RW	Unit	Type	Range	Description
0x1FD8–0x1FD9	8153–8154	R	V	FLOAT32	208–1000	Rated voltage
0x1FDA–0x1FDB	8155–8156	R	A	FLOAT32	100–8000	Rated current
0x1FDC	8157	–	–	–	–	Reserved
0x1FDD	8158	R	–	INT16U	0–1	Rated frequency: <ul style="list-style-type: none"> • 0 = 50 Hz • 1 = 60 Hz
0x1FDE–0x1FE0	8159–8161	–	–	–	–	Reserved
0x1FE1	8162	R	–	INT16U	0–1	Number of poles: <ul style="list-style-type: none"> • 0 = 3 poles • 1 = 4 poles
0x1FE2	8163	R	–	INT16U	30–41	System type (see detailed description below): <ul style="list-style-type: none"> • 30 = 4CT 3VT • 31 = 3CT 3VT • 40 = 3CT 4VT • 41 = 4CT 4VT
0x1FE3–0x1FE4	8164–8165	R	V	FLOAT32	1000–1250	VT primary voltage
0x1FE5–0x1FE6	8166–8167	R	V	FLOAT32	100–690	VT secondary voltage
0x1FE7–0x1FEA	8168–8171	R	–	DATETIME	–	Current date/time of the source.

System type detailed description:

If...	Then...	Result
the system is 3-pole circuit breaker with external neutral current transformer and without external neutral voltage tap	system type = 30	<ul style="list-style-type: none"> • Measurements of the phase-to-phase voltages are available. • Measurements of the phase-to-neutral voltages are not available. • Measurement of the neutral current is available. • 3 wattmeters method is not possible.
the system is 3-pole circuit breaker without external neutral current transformer and without external neutral voltage tap	system type = 31	<ul style="list-style-type: none"> • Measurements of the phase-to-phase voltages are available. • Measurements of the phase-to-neutral voltages are not available. • Measurement of the neutral current is not available. • 3 wattmeters method is not possible.
the system is 3-pole circuit breaker without external neutral current transformer and with external neutral voltage tap	system type = 40	<ul style="list-style-type: none"> • Measurements of the phase-to-phase voltages are available. • Measurements of the phase-to-neutral voltages are available. • Measurement of the neutral current is not available. • 3 wattmeters method is possible.
the system is 3-pole circuit breaker with external neutral current transformer and external neutral voltage tap, or if the system type is 4-pole circuit breaker	system type = 41	<ul style="list-style-type: none"> • Measurements of the phase-to-phase voltages are available. • Measurements of the phase-to-neutral voltages are available. • Measurement of the neutral current is available. • 3 wattmeters method is possible.

Hardware Revision

The hardware revision is an ASCII string using the format XXX.YYY.ZZZ with:

- XXX = major version (000–127)
- YYY = minor version (000–255)
- ZZZ = revision number (000–255)

The NULL character ends the revision number.

Address	Register	RW	Unit	Type	Range	Description
0x2047– 0x204C	8264–8269	R	–	OCTET STRING	–	Hardware revision

Protection Type

Address	Register	RW	Unit	Type	Range	Description
0x204E	8271	R	–	INT16U	–	Protection type: <ul style="list-style-type: none"> • 12848 = LSo (Long time and Short time (without timeout) overcurrent protections) • 13104 = LI (Long time and Instantaneous overcurrent protections) • 13616 = LSI (Long time, Short time and Instantaneous overcurrent protections) • 13872 = LSIG (Long time, Short time, Instantaneous overcurrent and ground fault protections) • 14128 = LSIV (Long time, Short time, Instantaneous overcurrent and earth leakage protections)

Application Type

Address	Register	RW	Unit	Type	Range	Description
0x204F	8272	R	–	INT16U	1	Application type: <ul style="list-style-type: none"> • 1 = Distribution

Circuit Breaker Standard

Address	Register	RW	Unit	Type	Range	Description
0x2072	8307	R	–	INT16U	0–3	Standard or market targeted by the device: <ul style="list-style-type: none"> • 0 = UL • 1 = IEC • 2 = ANSI • 3 = IEC/GB

Firmware Revision

The firmware revision is an ASCII string using the format XXX.YYY.ZZZ with:

- XXX = major version (000–127)

- **YYY** = minor version (000–255)
- **ZZZ** = revision number (000–255)

The NULL character ends the revision number.

Address	Register	RW	Unit	Type	Range	Description
0x2094-0x2099	8341–8346	R	–	OCTET STRING	–	Firmware revision

Measurement Settings

Address	Register	RW	Unit	Type	Range	Description
0x20C9	8394	R	–	INT16U	–	Current demand calculation: <ul style="list-style-type: none"> • 0 = Thermal image sliding
0x20CA–0x20CB	8395–8396	R-WC	min	FLOAT32	–	Current demand calculation interval time
0x20CC	8397	–	–	–	–	Reserved
0x20CD	8398	R	–	INT16U	–	Power demand calculation: <ul style="list-style-type: none"> • 0 = Time interval sliding
0x20CE–0x20CF	8399–8400	R-WC	min	FLOAT32	–	Power demand calculation interval time
0x20D0	8401	–	–	–	–	Reserved
0x20D1	8402	R-WC	–	INT16U	0–1	External neutral voltage sensor: <ul style="list-style-type: none"> • 0 = Not available • 1 = Available
0x20D2	8403	R-WC	–	INT16U	0–1	External neutral current sensor: <ul style="list-style-type: none"> • 0 = Not available • 1 = Available
0x20D3	8404	R-WC	–	INT16U	0, 2	Power factor sign convention: <ul style="list-style-type: none"> • 0 = IEC • 2 = IEEE
0x20D4	8405	R-WC	–	INT16U	0–1	Power sign: <ul style="list-style-type: none"> • 0 = Direct • 1 = Inverted
0x20D5	8406	–	–	–	–	Reserved
0x20D6	8407	R-WC	–	INT16U	0–1	Energy accumulation mode: <ul style="list-style-type: none"> • 0 = Absolute • 1 = Signed
0x20D7	8408	R	–	INT16U	0–1	Power calculation method: <ul style="list-style-type: none"> • 0 = Vectorial • 1 = Arithmetic

Device Identification

Address	Register	RW	Unit	Type	Range	Description
0x20D9	8410	R	–	INT16U	–	Internal identifier of the product: <ul style="list-style-type: none"> • 17120 = MicroLogic X • 17124 = MicroLogic Xi
0x20DA–0x20E3	8411–8420	R	–	OCTET STRING	–	Vendor name: 'Schneider Electric'
0x20E4–0x2123	8421–8484	R	–	OCTET STRING	–	Vendor URL

Address	Register	RW	Unit	Type	Range	Description
0x2124–0x212D	8485–8492	R	–	OCTET STRING	–	Product range: 'MicroLogic'
0x212C–0x2132	8493–8500	R	–	OCTET STRING	–	Product model
0x2134–0x213B	8501–8508	R	–	OCTET STRING	–	Product code
0x213C–0x2148	8509–8521	R	–	OCTET STRING	–	Serial number of the MicroLogic control unit
0x2149–0x2168	8522–8553	R-WC	–	OCTET STRING	–	User application name
0x2169–0x2178	8554–8569	R	–	OCTET STRING	–	Main capability of device
0x2179	8570	–	–	–	–	Reserved
0x217A–0x2181	8571–8578	R	–	OCTET STRING	–	Product range: 'MasterPact MTZ'
0x2182–0x2189	8579–8586	–	–	–	–	Reserved
0x218A–0x218D	8587–8590	R	–	OCTET STRING	–	Performance level: <ul style="list-style-type: none"> 'N1': standard short-circuit level (42 kA) 'H1': high short-circuit level (66 kA) 'H2': very high short-circuit level (100 kA) with very high selectivity (85 kA) 'H2V': very high short-circuit level (100 kA) with very high selectivity (100 kA) 'H3': extremely high short-circuit level (150 kA) 'L1': extremely high short-circuit level (150 kA) with strong current limitation and significant selectivity (30 kA)
0x218E–0x219A	8591–8603	R	–	OCTET STRING	–	Serial number of the MasterPact MTZ circuit breaker
0x219B–0x21AA	8604–8619	R	–	OCTET STRING	–	Device family: 'Circuit breaker'

Wireless Inhibition Status

Address	Register	RW	Unit	Type	Range	Bit	Description
0x887C	34941	R	–	INT16U	–	–	Quality of each bit of register 34942: <ul style="list-style-type: none"> 0 = Invalid 1 = Valid
0x887D	34942	R	–	INT16U	–	0	Bluetooth wireless inhibition status <ul style="list-style-type: none"> 0 = Bluetooth is not inhibited 1 = Bluetooth is inhibited
						1–15	Reserved

Real-Time Measurements

General Description

The real-time measurements are refreshed every second. Real-time measurements include:

- RMS (Root Mean Square) voltage and voltage unbalance
- RMS (Root Mean Square) current and current unbalance
- Active, reactive, and apparent power
- Power factor and fundamental power factor
- Frequency
- Total harmonic distortion (THD) of voltage and current compared to the fundamental
- Total harmonic distortion (thd) of voltage and current compared to the RMS value

Voltage

Address	Register	RW	Unit	Type	Range	Description
0x7D37–0x7D38	32056–32057	R	V	FLOAT32	41.6–2250	RMS phase-to-phase voltage V12
0x7D39–0x7D3A	32058–32059	R	V	FLOAT32	41.6–2250	RMS phase-to-phase voltage V23
0x7D3B–0x7D3C	32060–32061	R	V	FLOAT32	41.6–2250	RMS phase-to-phase voltage V31
0x7D3D–0x7D3E	32062–32063	R	V	FLOAT32	24–1500	RMS phase-to-neutral voltage V1N ⁽¹⁾
0x7D3F–0x7D40	32064–32065	R	V	FLOAT32	24–1500	RMS phase-to-neutral voltage V2N ⁽¹⁾
0x7D41–0x7D42	32066–32067	R	V	FLOAT32	24–1500	RMS phase-to-neutral voltage V3N ⁽¹⁾

(1) Value available when system type register returns 40 or 41.

Average Voltage

Address	Register	RW	Unit	Type	Range	Description
0x5214–0x5215	21013–21014	R	V	FLOAT32	41.6–2250	Average of 3 RMS phase-to-phase voltages: $(V12 + V23 + V31) / 3$
0x5216–0x5217	21015–21016	R	V	FLOAT32	24–1500	Average of 3 RMS phase-to-neutral voltages: $(V1N + V2N + V3N) / 3^{(1)}$

(1) Value available when system type register returns 40 or 41.

Voltage Unbalance

Address	Register	RW	Unit	Type	Range	Description
0x5220–0x5221	21025–21026	R	–	FLOAT32	–	Phase-to-phase V12 voltage unbalance with respect to the average of 3 phase-to-phase RMS voltages
0x5222–0x5223	21027–21028	R	–	FLOAT32	–	Phase-to-phase V23 voltage unbalance with respect to the average of 3 phase-to-phase RMS voltages

Address	Register	RW	Unit	Type	Range	Description
0x5224–0x5225	21029–21030	R	–	FLOAT32	–	Phase-to-phase V31 voltage unbalance with respect to the average of 3 phase-to-phase RMS voltages
0x5226–0x5227	21031–21032	R	–	FLOAT32	–	Phase-to-neutral V1N voltage unbalance with respect to the average of 3 phase-to-neutral RMS voltages ⁽¹⁾
0x5228–0x5229	21033–21034	R	–	FLOAT32	–	Phase-to-neutral V2N voltage unbalance with respect to the average of 3 phase-to-neutral RMS voltages ⁽¹⁾
0x522A–0x522B	21035–21036	R	–	FLOAT32	–	Phase-to-neutral V3N voltage unbalance with respect to the average of 3 phase-to-neutral RMS voltages ⁽¹⁾

(1) Value available when system type register returns 40 or 41.

Current

Address	Register	RW	Unit	Type	Range	Description
0x7D1B–0x7D1C	32028–32029	R	A	FLOAT32	–	RMS current on phase 1
0x7D1D–0x7D1E	32030–32031	R	A	FLOAT32	–	RMS current on phase 2
0x7D1F–0x7D20	32032–32033	R	A	FLOAT32	–	RMS current on phase 3
0x7D21–0x7D22	32034–32035	R	A	FLOAT32	–	RMS current of neutral ⁽¹⁾
0x7D23–0x7D24	32036–32037	R	A	FLOAT32	–	Maximum of RMS current of phases 1, 2, 3, N (Most loaded phase)
0x7D25–0x7D26	32038–32039	R	-	FLOAT32	–	Current ratio on ground (I _g setting ratio)
0x7D27–0x7D28	32040–32041	R	-	FLOAT32	–	Current ratio on earth-leakage (I _{Δn} setting ratio) ⁽²⁾

(1) Value available when system type register returns 30 or 41.

(2) Value available with MicroLogic 7.0 X.

Address	Register	RW	Unit	Type	Range	Description
0x7D95–0x7D96	32150–32151	R	A	FLOAT32	–	Ground-fault current
0x7D97–0x7D98	32152–32153	R	A	FLOAT32	–	Earth-leakage current ⁽¹⁾

(1) Value available with MicroLogic 7.0 X.

Address	Register	RW	Unit	Type	Range	Description
0x5336-0x5337	21301-21302	R	-	FLOAT32	–	Current ratio on phase 1 (I _r setting ratio)
0x5338-0x5339	21303-21304	R	-	FLOAT32	–	Current ratio on phase 2 (I _r setting ratio)
0x533A-0x533B	21305-21306	R	-	FLOAT32	–	Current ratio on phase 3 (I _r setting ratio)
0x533C-0x533D	21307-21308	R	-	FLOAT32	–	Current ratio on neutral (I _r setting ratio x Type of neutral protection: 0.5, 1, 1.6, OFF) If type of neutral protection is OFF, then the value returned is 0.

Current Unbalance

Address	Register	RW	Unit	Type	Range	Description
0x523E–0x523F	21055–21056	R	–	FLOAT32	–	Phase 1 current unbalance with respect to the average of 3 phase RMS currents
0x5240–0x5241	21057–21058	R	–	FLOAT32	–	Phase 2 current unbalance with respect to the average of 3 phase RMS currents
0x5242–0x5243	21059–21060	R	–	FLOAT32	–	Phase 3 current unbalance with respect to the average of 3 phase RMS currents
0x5244–0x5245	21061–21062	R	–	FLOAT32	–	Neutral current unbalance with respect to the average of 3 phase RMS currents ⁽¹⁾

(1) Value available when system type register returns 30 or 41.

Average Values

Address	Register	RW	Unit	Type	Range	Description
0x7D83–0x7D84	32132–32133	R	A	FLOAT32	–	Average of 3 phase RMS currents
0x7D85–0x7D86	32134–32135	R	V	FLOAT32	–	Average of 3 RMS phase-to-phase voltages: $(V12+V23+V31)/3$
0x7D87–0x7D88	32136–32137	R	V	FLOAT32	–	Average of 3 RMS phase-to-neutral voltages: $(V1N+V2N+V3N)/3$ ⁽¹⁾

(1) Value available when system type register returns 40 or 41.

Frequency

Address	Register	RW	Unit	Type	Range	Description
0x7D43–0x7D44	32068–32069	R	Hz	FLOAT32	–	Frequency

Active Power

The flow sign of the active power depends on the configuration of register 8405, page 122:

Address	Register	RW	Unit	Type	Range	Description
0x7D47–0x7D48	32072–32073	R	W	FLOAT32	–	Active power on phase 1 ⁽¹⁾
0x7D49–0x7D4A	32074–32075	R	W	FLOAT32	–	Active power on phase 2 ⁽¹⁾
0x7D4B–0x7D4C	32076–32077	R	W	FLOAT32	–	Active power on phase 3 ⁽¹⁾
0x7D4D–0x7D4E	32078–32079	R	W	FLOAT32	–	Total active power

(1) Value available when system type register returns 40 or 41.

Reactive Power

The flow sign of the reactive power depends on the configuration of register 8405, page 122:

Address	Register	RW	Unit	Type	Range	Description
0x7D4F–0x7D50	32080–32081	R	VAr	FLOAT32	–	Reactive power on phase 1 ⁽¹⁾
0x7D51–0x7D52	32082–32083	R	VAr	FLOAT32	–	Reactive power on phase 2 ⁽¹⁾
0x7D53–0x7D54	32084–32085	R	VAr	FLOAT32	–	Reactive power on phase 3 ⁽¹⁾
0x7D55–0x7D56	32086–32087	R	VAr	FLOAT32	–	Total reactive power

(1) Value available when system type register returns 40 or 41.

Apparent Power

Address	Register	RW	Unit	Type	Range	Description
0x7D57–0x7D58	32088–32089	R	VA	FLOAT32	–	Apparent power on phase 1 ⁽¹⁾
0x7D59–0x7D5A	32090–32091	R	VA	FLOAT32	0–16000000	Apparent power on phase 2 ⁽¹⁾
0x7D5B–0x7D5C	32092–32093	R	VA	FLOAT32	0–16000000	Apparent power on phase 3 ⁽¹⁾
0x7D5D–0x7D5E	32094–32095	R	VA	FLOAT32	0–16000000	Total apparent power

(1) Value available when system type register returns 40 or 41.

Power Factor

The sign of the power factor depends on the configuration of register 8404, page 122:

Address	Register	RW	Unit	Type	Range	Description
0x7DCD–0x7DCE	32206–32207	R	–	FLOAT32	–	Power factor on phase 1 ⁽¹⁾
0x7DCF–0x7DD0	32208–32209	R	–	FLOAT32	–	Power factor on phase 2 ⁽¹⁾
0x7DD1–0x7DD2	32210–32211	R	–	FLOAT32	–	Power factor on phase 3 ⁽¹⁾
0x7DD3–0x7DD4	32212–32213	R	–	FLOAT32	–	Total power factor

(1) Value available when system type register returns 40 or 41.

Fundamental Power Factor (cos ϕ)

The sign of the fundamental power factor (cos ϕ) depends on the configuration of register 8404, page 122:

Address	Register	RW	Unit	Type	Range	Description
0x7DD5–0x7DD6	32214–32215	R	–	FLOAT32	–	Fundamental power factor on phase 1 (cos ϕ_1) ⁽¹⁾
0x7DD7–0x7DD8	32216–32217	R	–	FLOAT32	–	Fundamental power factor on phase 2 (cos ϕ_2) ⁽¹⁾
0x7DD9–0x7DDA	32218–32219	R	–	FLOAT32	–	Fundamental power factor on phase 3 (cos ϕ_3) ⁽¹⁾
0x7ddb–0x7ddc	32220–32221	R	–	FLOAT32	–	Total fundamental power factor

(1) Value available when system type register returns 40 or 41.

Total Harmonic Distortion (THD) of Voltage Compared to the Fundamental

Address	Register	RW	Unit	Type	Range	Description
0x7DDD–0x7DDE	32222–32223	R	–	FLOAT32	–	Total harmonic distortion (THD) of phase-to-phase voltage V12 compared to the fundamental
0x7DDF–0x7DE0	32224–32225	R	–	FLOAT32	–	Total harmonic distortion (THD) of phase-to-phase voltage V23 in compared to the fundamental
0x7DE1–0x7DE2	32226–32227	R	–	FLOAT32	–	Total harmonic distortion (THD) of phase-to-phase voltage V31 in compared to the fundamental
0x7DE3–0x7DE4	32228–32229	R	–	FLOAT32	–	Total harmonic distortion (THD) of phase-to-neutral voltage V1N in compared to the fundamental ⁽¹⁾
0x7DE5–0x7DE6	32230–32231	R	–	FLOAT32	–	Total harmonic distortion (THD) of phase-to-neutral voltage V2N in compared to the fundamental ⁽¹⁾
0x7DE7–0x7DE8	32232–32233	R	–	FLOAT32	–	Total harmonic distortion (THD) of phase-to-neutral voltage V3N in compared to the fundamental ⁽¹⁾
0x528C–0x528D	21133–21134	R	–	FLOAT32	–	Average of 3 phase-to-phase voltage Total Harmonic Distortions (THD) compared to the fundamental average
0x528E–0x528F	21135–21136	R	–	FLOAT32	–	Average of 3 phase-to-neutral voltage Total Harmonic Distortions (THD) compared to the fundamental

(1) Value available when system type register returns 40 or 41.

Total Harmonic Distortion (thd) of Voltage Compared to RMS Voltage

Address	Register	RW	Unit	Type	Range	Description
0x5290–0x5291	21137–21138	R	–	FLOAT32	–	Total harmonic distortion (thd) of phase-phase voltage V12 compared to the RMS voltage
0x5292–0x5293	21139–21140	R	–	FLOAT32	–	Total harmonic distortion (thd) of phase-phase voltage V23 compared to the RMS voltage
0x5294–0x5295	21141–21142	R	–	FLOAT32	–	Total harmonic distortion (thd) of phase-phase voltage V31 compared to the RMS voltage
0x5296–0x5297	21143–21144	R	–	FLOAT32	–	Total harmonic distortion (thd) of phase-neutral voltage V1N compared to the RMS voltage ⁽¹⁾
0x5298–0x5299	21145–21146	R	–	FLOAT32	–	Total harmonic distortion (thd) of phase-neutral voltage V2N compared to the RMS voltage ⁽¹⁾
0x529A–0x529B	21147–21148	R	–	FLOAT32	–	Total harmonic distortion (thd) of phase-neutral voltage V3N compared to the RMS voltage ⁽¹⁾
0x529C–0x529D	21149–21150	R	–	FLOAT32	–	Average of 3 phase-to-phase voltage total harmonic distortions (thd) compared to the RMS voltage

Address	Register	RW	Unit	Type	Range	Description
0x529E–0x529F	21151–21152	R	–	FLOAT32	–	Average of 3 phase-to-neutral voltage total harmonic distortions (thd) compared to the RMS voltage
(1) Value available when system type register returns 40 or 41.						

Total Harmonic Distortion (THD) of Current Compared to the Fundamental

Address	Register	RW	Unit	Type	Range	Description
0x7DE9–0x7DEA	32234–32235	R	–	FLOAT32	–	Total Harmonic Distortion (THD) of current on phase 1 compared to the fundamental
0x7DEB–0x7DEC	32236–32237	R	–	FLOAT32	–	Total Harmonic Distortion (THD) of current on phase 2 compared to the fundamental
0x7DED–0x7DEE	32238–32239	R	–	FLOAT32	–	Total Harmonic Distortion (THD) of current on phase 3 compared to the fundamental
0x7DEF–0x7DF0	32240–32241	R	–	FLOAT32	–	Average of 3 phase current Total Harmonic Distortions (THD) compared to the fundamental

Total Harmonic Distortion (thd) of Current Compared to RMS Current

Address	Register	RW	Unit	Type	Range	Description
0x52AA–0x52AB	21163–21164	R	–	FLOAT32	–	Total harmonic distortion (thd) of current on phase 1 compared to the RMS current
0x52AC–0x52AD	21165–21166	R	–	FLOAT32	–	Total harmonic distortion (thd) of current on phase 2 compared to the RMS current
0x52AE–0x52AF	21167–21168	R	–	FLOAT32	–	Total harmonic distortion (thd) of current on phase 3 compared to the RMS current
0x52B0–0x52B1	21169–21170	R	–	FLOAT32	–	Total harmonic distortion (thd) of current on neutral compared to the RMS current ⁽¹⁾
0x52B2–0x52B3	21171–21172	R	–	FLOAT32	–	Average of 3 phase current total harmonic distortions (thd) compared to the RMS current
(1) Value available when system type register returns 30 or 41.						

Miscellaneous

Address	Register	RW	Unit	Type	Range	Description
0x52C6	21191	R	–	INT16U	0–1	Phase rotation sequence: <ul style="list-style-type: none"> • 0 = 123 • 1 = 132
0x52C7	21192	R	–	INT16U	1–4	Total power factor quadrant: <ul style="list-style-type: none"> • 1 = Quadrant I • 2 = Quadrant II • 3 = Quadrant III • 4 = Quadrant IV
0x52C8	21193	R	–	INT16U	0–1	Lead or Lag: <ul style="list-style-type: none"> • 0 = Capacitive • 1 = Inductive
0x52C9–0x52CB	21194–21196	–	–	–	–	Reserved
0x52CC–0x52CD	21197–21198	R	–	FLOAT32	–	Deviation (%) of 3 RMS phase-to-phase voltages

Harmonic Values

General Description

The Individual Harmonics Analysis Digital Module provides real-time monitoring of individual harmonics of voltages and currents up to rank 40. If harmonic pollution reaches unacceptable levels, it helps you to select appropriate corrective action.

Total harmonic distortions THD(I), THD(V), THD-R(I), and THD-R(V) are calculated as standard by the MicroLogic X control unit , page 128.

Individual harmonics are calculated by the MicroLogic X control unit according to the measurement methods specified in IEC 61000-4-30 (Testing and measurement techniques - Power quality measurement methods). The calculation of individual harmonics is performed every 200 milliseconds. The MicroLogic X control unit provides the aggregated values of individual harmonics calculated on a time period of 3 seconds.

Data Availability

Individual harmonics analysis is available when the Individual Harmonics Analysis Digital Module is purchased and installed on a MicroLogic X control unit.

The Individual Harmonics Analysis Digital Module is compatible with MicroLogic X control units with firmware version greater than or equal to version V002.000.xxx.

The Individual harmonics analysis is not available with IFM interface.

Odd Voltage Harmonics

Address	Register	RW	Unit	Type	Range	Description
0x9470–0x9471	38001–38002	R	V	FLOAT32	–	Harmonic 1 of phase-to-phase voltage V12
0x9472–0x9473	38003–38004	R	V	FLOAT32	–	Harmonic 1 of phase-to-phase voltage V23
0x9474–0x9475	38005–38006	R	V	FLOAT32	–	Harmonic 1 of phase-to-phase voltage V31
0x9476–0x9477	38007–38008	R	V	FLOAT32	–	Harmonic 1 of phase-to-neutral voltage V1N
0x9478–0x9479	38009–38010	R	V	FLOAT32	–	Harmonic 1 of phase-to-neutral voltage V2N
0x947A–0x947B	38011–38012	R	V	FLOAT32	–	Harmonic 1 of phase-to-neutral voltage V3N
0x947C–0x947D	38013–38014	R	V	FLOAT32	–	Harmonic 3 of phase-to-phase voltage V12
0x947E–0x947F	38015–38016	R	V	FLOAT32	–	Harmonic 3 of phase-to-phase voltage V23
0x9480–0x9481	38017–38018	R	V	FLOAT32	–	Harmonic 3 of phase-to-phase voltage V31
0x9482–0x9483	38019–38020	R	V	FLOAT32	–	Harmonic 3 of phase-to-neutral voltage V1N
0x9484–0x9485	38021–38022	R	V	FLOAT32	–	Harmonic 3 of phase-to-neutral voltage V2N
0x9486–0x9487	38023–38024	R	V	FLOAT32	–	Harmonic 3 of phase-to-neutral voltage V3N
0x9488–0x9489	38025–38026	R	V	FLOAT32	–	Harmonic 5 of phase-to-phase voltage V12
0x948A–0x948B	38027–38028	R	V	FLOAT32	–	Harmonic 5 of phase-to-phase voltage V23

Address	Register	RW	Unit	Type	Range	Description
0x948C–0x948D	38029–38030	R	V	FLOAT32	–	Harmonic 5 of phase-to-phase voltage V31
0x948E–0x948F	38031–38032	R	V	FLOAT32	–	Harmonic 5 of phase-to-neutral voltage V1N
0x9490–0x9491	38033–38034	R	V	FLOAT32	–	Harmonic 5 of phase-to-neutral voltage V2N
0x9492–0x9493	38035–38036	R	V	FLOAT32	–	Harmonic 5 of phase-to-neutral voltage V3N
0x9494–0x9495	38037–38038	R	V	FLOAT32	–	Harmonic 7 of phase-to-phase voltage V12
0x9496–0x9497	38039–38040	R	V	FLOAT32	–	Harmonic 7 of phase-to-phase voltage V23
0x9498–0x9499	38041–38042	R	V	FLOAT32	–	Harmonic 7 of phase-to-phase voltage V31
0x949A–0x949B	38043–38044	R	V	FLOAT32	–	Harmonic 7 of phase-to-neutral voltage V1N
0x949C–0x949D	38045–38046	R	V	FLOAT32	–	Harmonic 7 of phase-to-neutral voltage V2N
0x949E–0x949F	38047–38048	R	V	FLOAT32	–	Harmonic 7 of phase-to-neutral voltage V3N
0x94A0–0x94A1	38049–38050	R	V	FLOAT32	–	Harmonic 9 of phase-to-phase voltage V12
0x94A2–0x94A3	38051–38052	R	V	FLOAT32	–	Harmonic 9 of phase-to-phase voltage V23
0x94A4–0x94A5	38053–38054	R	V	FLOAT32	–	Harmonic 9 of phase-to-phase voltage V31
0x94A6–0x94A7	38055–38056	R	V	FLOAT32	–	Harmonic 9 of phase-to-neutral voltage V1N
0x94A8–0x94A9	38057–38058	R	V	FLOAT32	–	Harmonic 9 of phase-to-neutral voltage V2N
0x94AA–0x94AB	38059–38060	R	V	FLOAT32	–	Harmonic 9 of phase-to-neutral voltage V3N
0x94AC–0x94AD	38061–38062	R	V	FLOAT32	–	Harmonic 11 of phase-to-phase voltage V12
0x94AE–0x94AF	38063–38064	R	V	FLOAT32	–	Harmonic 11 of phase-to-phase voltage V23
0x94B0–0x94B1	38065–38066	R	V	FLOAT32	–	Harmonic 11 of phase-to-phase voltage V31
0x94B2–0x94B3	38067–38068	R	V	FLOAT32	–	Harmonic 11 of phase-to-neutral voltage V1N
0x94B4–0x94B5	38069–38070	R	V	FLOAT32	–	Harmonic 11 of phase-to-neutral voltage V2N
0x94B6–0x94B7	38071–38072	R	V	FLOAT32	–	Harmonic 11 of phase-to-neutral voltage V3N
0x94B8–0x94B9	38073–38074	R	V	FLOAT32	–	Harmonic 13 of phase-to-phase voltage V12
0x94BA–0x94BB	38075–38076	R	V	FLOAT32	–	Harmonic 13 of phase-to-phase voltage V23
0x94BC–0x94BD	38077–38078	R	V	FLOAT32	–	Harmonic 13 of phase-to-phase voltage V31
0x94BE–0x94BF	38079–38080	R	V	FLOAT32	–	Harmonic 13 of phase-to-neutral voltage V1N
0x94C0–0x94C1	38081–38082	R	V	FLOAT32	–	Harmonic 13 of phase-to-neutral voltage V2N
0x94C2–0x94C3	38083–38084	R	V	FLOAT32	–	Harmonic 13 of phase-to-neutral voltage V3N
0x94C4–0x94C5	38085–38086	R	V	FLOAT32	–	Harmonic 15 of phase-to-phase voltage V12

Address	Register	RW	Unit	Type	Range	Description
0x94C6–0x94C7	38087–38088	R	V	FLOAT32	–	Harmonic 15 of phase-to-phase voltage V23
0x94C8–0x94C9	38089–38090	R	V	FLOAT32	–	Harmonic 15 of phase-to-phase voltage V31
0x94CA–0x94CB	38091–38092	R	V	FLOAT32	–	Harmonic 15 of phase-to-neutral voltage V1N
0x94CC–0x94CD	38093–38094	R	V	FLOAT32	–	Harmonic 15 of phase-to-neutral voltage V2N
0x94CE–0x94CF	38095–38096	R	V	FLOAT32	–	Harmonic 15 of phase-to-neutral voltage V3N
0x94D0–0x94D1	38097–38098	R	V	FLOAT32	–	Harmonic 17 of phase-to-phase voltage V12
0x94D2–0x94D3	38099–38100	R	V	FLOAT32	–	Harmonic 17 of phase-to-phase voltage V23
0x94D4–0x94D5	38101–38102	R	V	FLOAT32	–	Harmonic 17 of phase-to-phase voltage V31
0x94D6–0x94D7	38103–38104	R	V	FLOAT32	–	Harmonic 17 of phase-to-neutral voltage V1N
0x94D8–0x94D9	38105–38106	R	V	FLOAT32	–	Harmonic 17 of phase-to-neutral voltage V2N
0x94DA–0x94DB	38107–38108	R	V	FLOAT32	–	Harmonic 17 of phase-to-neutral voltage V3N
0x94DC–0x94DD	38109–38110	R	V	FLOAT32	–	Harmonic 19 of phase-to-phase voltage V12
0x94DE–0x94DF	38111–38112	R	V	FLOAT32	–	Harmonic 19 of phase-to-phase voltage V23
0x94E0–0x94E1	38113–38114	R	V	FLOAT32	–	Harmonic 19 of phase-to-phase voltage V31
0x94E2–0x94E3	38115–38116	R	V	FLOAT32	–	Harmonic 19 of phase-to-neutral voltage V1N
0x94E4–0x94E5	38117–38118	R	V	FLOAT32	–	Harmonic 19 of phase-to-neutral voltage V2N
0x94E6–0x94E7	38119–38120	R	V	FLOAT32	–	Harmonic 19 of phase-to-neutral voltage V3N
0x94E8–0x94E9	38121–38122	R	V	FLOAT32	–	Harmonic 21 of phase-to-phase voltage V12
0x94EA–0x94EB	38123–38124	R	V	FLOAT32	–	Harmonic 21 of phase-to-phase voltage V23
0x94EC–0x94ED	38125–38126	R	V	FLOAT32	–	Harmonic 21 of phase-to-phase voltage V31
0x94EE–0x94EF	38127–38128	R	V	FLOAT32	–	Harmonic 21 of phase-to-neutral voltage V1N
0x94F0–0x94F1	38129–38130	R	V	FLOAT32	–	Harmonic 21 of phase-to-neutral voltage V2N
0x94F2–0x94F3	38131–38132	R	V	FLOAT32	–	Harmonic 21 of phase-to-neutral voltage V3N
0x94F4–0x94F5	38133–38134	R	V	FLOAT32	–	Harmonic 23 of phase-to-phase voltage V12
0x94F6–0x94F7	38135–38136	R	V	FLOAT32	–	Harmonic 23 of phase-to-phase voltage V23
0x94F8–0x94F9	38137–38138	R	V	FLOAT32	–	Harmonic 23 of phase-to-phase voltage V31
0x94FA–0x94FB	38139–38140	R	V	FLOAT32	–	Harmonic 23 of phase-to-neutral voltage V1N
0x94FC–0x94FD	38141–38142	R	V	FLOAT32	–	Harmonic 23 of phase-to-neutral voltage V2N
0x94FE–0x94FF	38143–38144	R	V	FLOAT32	–	Harmonic 23 of phase-to-neutral voltage V3N

Address	Register	RW	Unit	Type	Range	Description
0x9500–0x9501	38145–38146	R	V	FLOAT32	–	Harmonic 25 of phase-to-phase voltage V12
0x9502–0x9503	38147–38148	R	V	FLOAT32	–	Harmonic 25 of phase-to-phase voltage V23
0x9504–0x9505	38149–38150	R	V	FLOAT32	–	Harmonic 25 of phase-to-phase voltage V31
0x9506–0x9507	38151–38152	R	V	FLOAT32	–	Harmonic 25 of phase-to-neutral voltage V1N
0x9508–0x9509	38153–38154	R	V	FLOAT32	–	Harmonic 25 of phase-to-neutral voltage V2N
0x950A–0x950B	38155–38156	R	V	FLOAT32	–	Harmonic 25 of phase-to-neutral voltage V3N
0x950C–0x950D	38157–38158	R	V	FLOAT32	–	Harmonic 27 of phase-to-phase voltage V12
0x950E–0x950F	38159–38160	R	V	FLOAT32	–	Harmonic 27 of phase-to-phase voltage V23
0x9510–0x9511	38161–38162	R	V	FLOAT32	–	Harmonic 27 of phase-to-phase voltage V31
0x9512–0x9513	38163–38164	R	V	FLOAT32	–	Harmonic 27 of phase-to-neutral voltage V1N
0x9514–0x9515	38165–38166	R	V	FLOAT32	–	Harmonic 27 of phase-to-neutral voltage V2N
0x9516–0x9517	38167–38168	R	V	FLOAT32	–	Harmonic 27 of phase-to-neutral voltage V3N
0x9518–0x9519	38169–38170	R	V	FLOAT32	–	Harmonic 29 of phase-to-phase voltage V12
0x951A–0x951B	38171–38172	R	V	FLOAT32	–	Harmonic 29 of phase-to-phase voltage V23
0x951C–0x951D	38173–38174	R	V	FLOAT32	–	Harmonic 29 of phase-to-phase voltage V31
0x951E–0x951F	38175–38176	R	V	FLOAT32	–	Harmonic 29 of phase-to-neutral voltage V1N
0x9520–0x9521	38177–38178	R	V	FLOAT32	–	Harmonic 29 of phase-to-neutral voltage V2N
0x9522–0x9523	38179–38180	R	V	FLOAT32	–	Harmonic 29 of phase-to-neutral voltage V3N
0x9524–0x9525	38181–38182	R	V	FLOAT32	–	Harmonic 31 of phase-to-phase voltage V12
0x9526–0x9527	38183–38184	R	V	FLOAT32	–	Harmonic 31 of phase-to-phase voltage V23
0x9528–0x9529	38185–38186	R	V	FLOAT32	–	Harmonic 31 of phase-to-phase voltage V31
0x952A–0x952B	38187–38188	R	V	FLOAT32	–	Harmonic 31 of phase-to-neutral voltage V1N
0x952C–0x952D	38189–38190	R	V	FLOAT32	–	Harmonic 31 of phase-to-neutral voltage V2N
0x952E–0x952F	38191–38192	R	V	FLOAT32	–	Harmonic 31 of phase-to-neutral voltage V3N
0x9530–0x9531	38193–38194	R	V	FLOAT32	–	Harmonic 33 of phase-to-phase voltage V12
0x9532–0x9533	38195–38196	R	V	FLOAT32	–	Harmonic 33 of phase-to-phase voltage V23
0x9534–0x9535	38197–38198	R	V	FLOAT32	–	Harmonic 33 of phase-to-phase voltage V31
0x9536–0x9537	38199–38200	R	V	FLOAT32	–	Harmonic 33 of phase-to-neutral voltage V1N
0x9538–0x9539	38201–38202	R	V	FLOAT32	–	Harmonic 33 of phase-to-neutral voltage V2N

Address	Register	RW	Unit	Type	Range	Description
0x953A–0x953B	38203–38204	R	V	FLOAT32	–	Harmonic 33 of phase-to-neutral voltage V3N
0x953C–0x953D	38205–38206	R	V	FLOAT32	–	Harmonic 35 of phase-to-phase voltage V12
0x953E–0x953F	38207–38208	R	V	FLOAT32	–	Harmonic 35 of phase-to-phase voltage V23
0x9540–0x9541	38209–38210	R	V	FLOAT32	–	Harmonic 35 of phase-to-phase voltage V31
0x9542–0x9543	38211–38212	R	V	FLOAT32	–	Harmonic 35 of phase-to-neutral voltage V1N
0x9544–0x9545	38213–38214	R	V	FLOAT32	–	Harmonic 35 of phase-to-neutral voltage V2N
0x9546–0x9547	38215–38216	R	V	FLOAT32	–	Harmonic 35 of phase-to-neutral voltage V3N
0x9548–0x9549	38217–38218	R	V	FLOAT32	–	Harmonic 37 of phase-to-phase voltage V12
0x954A–0x954B	38219–38220	R	V	FLOAT32	–	Harmonic 37 of phase-to-phase voltage V23
0x954C–0x954D	38221–38222	R	V	FLOAT32	–	Harmonic 37 of phase-to-phase voltage V31
0x954E–0x954F	38223–38224	R	V	FLOAT32	–	Harmonic 37 of phase-to-neutral voltage V1N
0x9550–0x9551	38225–38226	R	V	FLOAT32	–	Harmonic 37 of phase-to-neutral voltage V2N
0x9552–0x9553	38227–38228	R	V	FLOAT32	–	Harmonic 37 of phase-to-neutral voltage V3N
0x9554–0x9555	38229–38230	R	V	FLOAT32	–	Harmonic 39 of phase-to-phase voltage V12
0x9556–0x9557	38231–38232	R	V	FLOAT32	–	Harmonic 39 of phase-to-phase voltage V23
0x9558–0x9559	38233–38234	R	V	FLOAT32	–	Harmonic 39 of phase-to-phase voltage V31
0x955A–0x955B	38235–38236	R	V	FLOAT32	–	Harmonic 39 of phase-to-neutral voltage V1N
0x955C–0x955D	38237–38238	R	V	FLOAT32	–	Harmonic 39 of phase-to-neutral voltage V2N
0x955E–0x955F	38239–38240	R	V	FLOAT32	–	Harmonic 39 of phase-to-neutral voltage V3N

Odd Current Harmonics

Address	Register	RW	Unit	Type	Range	Description
0x9560–0x9561	38241–38242	R	A	FLOAT32	–	Harmonic 1 of current on phase 1
0x9562–0x9563	38243–38244	R	A	FLOAT32	–	Harmonic 1 of current on phase 2
0x9564–0x9565	38245–38246	R	A	FLOAT32	–	Harmonic 1 of current on phase 3
0x9566–0x9567	38247–38248	R	A	FLOAT32	–	Harmonic 1 of current on neutral
0x9568–0x9569	38249–38250	R	A	FLOAT32	–	Harmonic 3 of current on phase 1
0x956A–0x956B	38251–38252	R	A	FLOAT32	–	Harmonic 3 of current on phase 2
0x956C–0x956D	38253–38254	R	A	FLOAT32	–	Harmonic 3 of current on phase 3
0x956E–0x956F	38255–38256	R	A	FLOAT32	–	Harmonic 3 of current on neutral
0x9570–0x9571	38257–38258	R	A	FLOAT32	–	Harmonic 5 of current on phase 1
0x9572–0x9573	38259–38260	R	A	FLOAT32	–	Harmonic 5 of current on phase 2

Address	Register	RW	Unit	Type	Range	Description
0x9574–0x9575	38261–38262	R	A	FLOAT32	–	Harmonic 5 of current on phase 3
0x9576–0x9577	38263–38264	R	A	FLOAT32	–	Harmonic 5 of current on neutral
0x9578–0x9579	38265–38266	R	A	FLOAT32	–	Harmonic 7 of current on phase 1
0x957A–0x957B	38267–38268	R	A	FLOAT32	–	Harmonic 7 of current on phase 2
0x957C–0x957D	38269–38270	R	A	FLOAT32	–	Harmonic 7 of current on phase 3
0x957E–0x957F	38271–38272	R	A	FLOAT32	–	Harmonic 7 of current on neutral
0x9580–0x9581	38273–38274	R	A	FLOAT32	–	Harmonic 9 of current on phase 1
0x9582–0x9583	38275–38276	R	A	FLOAT32	–	Harmonic 9 of current on phase 2
0x9584–0x9585	38277–38278	R	A	FLOAT32	–	Harmonic 9 of current on phase 3
0x9586–0x9587	38279–38280	R	A	FLOAT32	–	Harmonic 9 of current on neutral
0x9588–0x9589	38281–38282	R	A	FLOAT32	–	Harmonic 11 of current on phase 1
0x958A–0x958B	38283–38284	R	A	FLOAT32	–	Harmonic 11 of current on phase 2
0x958C–0x958D	38285–38286	R	A	FLOAT32	–	Harmonic 11 of current on phase 3
0x958E–0x958F	38287–38288	R	A	FLOAT32	–	Harmonic 11 of current on neutral
0x9590–0x9591	38289–38290	R	A	FLOAT32	–	Harmonic 13 of current on phase 1
0x9592–0x9593	38291–38292	R	A	FLOAT32	–	Harmonic 13 of current on phase 2
0x9594–0x9595	38293–38294	R	A	FLOAT32	–	Harmonic 13 of current on phase 3
0x9596–0x9597	38295–38296	R	A	FLOAT32	–	Harmonic 13 of current on neutral
0x9598–0x9599	38297–38298	R	A	FLOAT32	–	Harmonic 15 of current on phase 1
0x959A–0x959B	38299–38300	R	A	FLOAT32	–	Harmonic 15 of current on phase 2
0x959C–0x959D	38301–38302	R	A	FLOAT32	–	Harmonic 15 of current on phase 3
0x959E–0x959F	38303–38304	R	A	FLOAT32	–	Harmonic 15 of current on neutral
0x95A0–0x95A1	38305–38306	R	A	FLOAT32	–	Harmonic 17 of current on phase 1
0x95A2–0x95A3	38307–38308	R	A	FLOAT32	–	Harmonic 17 of current on phase 2
0x95A4–0x95A5	38309–38310	R	A	FLOAT32	–	Harmonic 17 of current on phase 3
0x95A6–0x95A7	38311–38312	R	A	FLOAT32	–	Harmonic 17 of current on neutral
0x95A8–0x95A9	38313–38314	R	A	FLOAT32	–	Harmonic 19 of current on phase 1
0x95AA–0x95AB	38315–38316	R	A	FLOAT32	–	Harmonic 19 of current on phase 2
0x95AC–0x95AD	38317–38318	R	A	FLOAT32	–	Harmonic 19 of current on phase 3
0x95AE–0x95AF	38319–38320	R	A	FLOAT32	–	Harmonic 19 of current on neutral
0x95B0–0x95B1	38321–38322	R	A	FLOAT32	–	Harmonic 21 of current on phase 1
0x95B2–0x95B3	38323–38324	R	A	FLOAT32	–	Harmonic 21 of current on phase 2
0x95B4–0x95B5	38325–38326	R	A	FLOAT32	–	Harmonic 21 of current on phase 3
0x95B6–0x95B7	38327–38328	R	A	FLOAT32	–	Harmonic 21 of current on neutral
0x95B8–0x95B9	38329–38330	R	A	FLOAT32	–	Harmonic 23 of current on phase 1
0x95BA–0x95BB	38331–38332	R	A	FLOAT32	–	Harmonic 23 of current on phase 2
0x95BC–0x95BD	38333–38334	R	A	FLOAT32	–	Harmonic 23 of current on phase 3
0x95BE–0x95BF	38335–38336	R	A	FLOAT32	–	Harmonic 23 of current on neutral
0x95C0–0x95C1	38337–38338	R	A	FLOAT32	–	Harmonic 25 of current on phase 1
0x95C2–0x95C3	38339–38340	R	A	FLOAT32	–	Harmonic 25 of current on phase 2
0x95C4–0x95C5	38341–38342	R	A	FLOAT32	–	Harmonic 25 of current on phase 3
0x95C6–0x95C7	38343–38344	R	A	FLOAT32	–	Harmonic 25 of current on neutral
0x95C8–0x95C9	38345–38346	R	A	FLOAT32	–	Harmonic 27 of current on phase 1

Address	Register	RW	Unit	Type	Range	Description
0x95CA–0x95CB	38347–38348	R	A	FLOAT32	–	Harmonic 27 of current on phase 2
0x95CC–0x95CD	38349–38350	R	A	FLOAT32	–	Harmonic 27 of current on phase 3
0x95CE–0x95CF	38351–38352	R	A	FLOAT32	–	Harmonic 27 of current on neutral
0x95D0–0x95D1	38353–38354	R	A	FLOAT32	–	Harmonic 29 of current on phase 1
0x95D2–0x95D3	38355–38356	R	A	FLOAT32	–	Harmonic 29 of current on phase 2
0x95D4–0x95D5	38357–38358	R	A	FLOAT32	–	Harmonic 29 of current on phase 3
0x95D6–0x95D7	38359–38360	R	A	FLOAT32	–	Harmonic 29 of current on neutral
0x95D8–0x95D9	38361–38362	R	A	FLOAT32	–	Harmonic 31 of current on phase 1
0x95DA–0x95DB	38363–38364	R	A	FLOAT32	–	Harmonic 31 of current on phase 2
0x95DC–0x95DD	38365–38366	R	A	FLOAT32	–	Harmonic 31 of current on phase 3
0x95DE–0x95DF	38367–38368	R	A	FLOAT32	–	Harmonic 31 of current on neutral
0x95E0–0x95E1	38369–38370	R	A	FLOAT32	–	Harmonic 33 of current on phase 1
0x95E2–0x95E3	38371–38372	R	A	FLOAT32	–	Harmonic 33 of current on phase 2
0x95E4–0x95E5	38373–38374	R	A	FLOAT32	–	Harmonic 33 of current on phase 3
0x95E6–0x95E7	38375–38376	R	A	FLOAT32	–	Harmonic 33 of current on neutral
0x95E8–0x95E9	38377–38378	R	A	FLOAT32	–	Harmonic 35 of current on phase 1
0x95EA–0x95EB	38379–38380	R	A	FLOAT32	–	Harmonic 35 of current on phase 2
0x95EC–0x95ED	38381–38382	R	A	FLOAT32	–	Harmonic 35 of current on phase 3
0x95EE–0x95EF	38383–38384	R	A	FLOAT32	–	Harmonic 35 of current on neutral
0x95F0–0x95F1	38385–38386	R	A	FLOAT32	–	Harmonic 37 of current on phase 1
0x95F2–0x95F3	38387–38388	R	A	FLOAT32	–	Harmonic 37 of current on phase 2
0x95F4–0x95F5	38389–38390	R	A	FLOAT32	–	Harmonic 37 of current on phase 3
0x95F6–0x95F7	38391–38392	R	A	FLOAT32	–	Harmonic 37 of current on neutral
0x95F8–0x95F9	38393–38394	R	A	FLOAT32	–	Harmonic 39 of current on phase 1
0x95FA–0x95FB	38395–38396	R	A	FLOAT32	–	Harmonic 39 of current on phase 2
0x95FC–0x95FD	38397–38398	R	A	FLOAT32	–	Harmonic 39 of current on phase 3
0x95FE–0x95FF	38399–38400	R	A	FLOAT32	–	Harmonic 39 of current on neutral

Even Voltage Harmonics

Address	Register	RW	Unit	Type	Range	Description
0x9790–0x9791	38801–38802	R	V	FLOAT32	–	Harmonic 2 of phase-to-phase voltage V12
0x9792–0x9793	38803–38804	R	V	FLOAT32	–	Harmonic 2 of phase-to-phase voltage V23
0x9794–0x9795	38805–38806	R	V	FLOAT32	–	Harmonic 2 of phase-to-phase voltage V31
0x9796–0x9797	38807–38808	R	V	FLOAT32	–	Harmonic 2 of phase-to-neutral voltage V1N
0x9798–0x9799	38809–38810	R	V	FLOAT32	–	Harmonic 2 of phase-to-neutral voltage V2N
0x979A–0x979B	38811–38812	R	V	FLOAT32	–	Harmonic 2 of phase-to-neutral voltage V3N
0x979C–0x979D	38813–38814	R	V	FLOAT32	–	Harmonic 4 of phase-to-phase voltage V12
0x979E–0x979F	38815–38816	R	V	FLOAT32	–	Harmonic 4 of phase-to-phase voltage V23

Address	Register	RW	Unit	Type	Range	Description
0x97A0–0x97A1	38817–38818	R	V	FLOAT32	–	Harmonic 4 of phase-to-phase voltage V31
0x97A2–0x97A3	38819–38820	R	V	FLOAT32	–	Harmonic 4 of phase-to-neutral voltage V1N
0x97A4–0x97A5	38821–38822	R	V	FLOAT32	–	Harmonic 4 of phase-to-neutral voltage V2N
0x97A6–0x97A7	38823–38824	R	V	FLOAT32	–	Harmonic 4 of phase-to-neutral voltage V3N
0x97A8–0x97A9	38825–38826	R	V	FLOAT32	–	Harmonic 6 of phase-to-phase voltage V12
0x97AA–0x97AB	38827–38828	R	V	FLOAT32	–	Harmonic 6 of phase-to-phase voltage V23
0x97AC–0x97AD	38829–38830	R	V	FLOAT32	–	Harmonic 6 of phase-to-phase voltage V31
0x97AE–0x97AF	38831–38832	R	V	FLOAT32	–	Harmonic 6 of phase-to-neutral voltage V1N
0x97B0–0x97B1	38833–38834	R	V	FLOAT32	–	Harmonic 6 of phase-to-neutral voltage V2N
0x97B2–0x97B3	38835–38836	R	V	FLOAT32	–	Harmonic 6 of phase-to-neutral voltage V3N
0x97B4–0x97B5	38837–38838	R	V	FLOAT32	–	Harmonic 8 of phase-to-phase voltage V12
0x97B6–0x97B7	38839–38840	R	V	FLOAT32	–	Harmonic 8 of phase-to-phase voltage V23
0x97B8–0x97B9	38841–38842	R	V	FLOAT32	–	Harmonic 8 of phase-to-phase voltage V31
0x97BA–0x97BB	38843–38844	R	V	FLOAT32	–	Harmonic 8 of phase-to-neutral voltage V1N
0x97BC–0x97BD	38845–38846	R	V	FLOAT32	–	Harmonic 8 of phase-to-neutral voltage V2N
0x97BE–0x97BF	38847–38848	R	V	FLOAT32	–	Harmonic 8 of phase-to-neutral voltage V3N
0x97C0–0x97C1	38849–38850	R	V	FLOAT32	–	Harmonic 10 of phase-to-phase voltage V12
0x97C2–0x97C3	38851–38852	R	V	FLOAT32	–	Harmonic 10 of phase-to-phase voltage V23
0x97C4–0x97C5	38853–38854	R	V	FLOAT32	–	Harmonic 10 of phase-to-phase voltage V31
0x97C6–0x97C7	38855–38856	R	V	FLOAT32	–	Harmonic 10 of phase-to-neutral voltage V1N
0x97C8–0x97C9	38857–38858	R	V	FLOAT32	–	Harmonic 10 of phase-to-neutral voltage V2N
0x97CA–0x97CB	38859–38860	R	V	FLOAT32	–	Harmonic 10 of phase-to-neutral voltage V3N
0x97CC–0x97CD	38861–38862	R	V	FLOAT32	–	Harmonic 12 of phase-to-phase voltage V12
0x97CE–0x97CF	38863–38864	R	V	FLOAT32	–	Harmonic 12 of phase-to-phase voltage V23
0x97D0–0x97D1	38865–38866	R	V	FLOAT32	–	Harmonic 12 of phase-to-phase voltage V31
0x97D2–0x97D3	38867–38868	R	V	FLOAT32	–	Harmonic 12 of phase-to-neutral voltage V1N
0x97D4–0x97D5	38869–38870	R	V	FLOAT32	–	Harmonic 12 of phase-to-neutral voltage V2N
0x97D6–0x97D7	38871–38872	R	V	FLOAT32	–	Harmonic 12 of phase-to-neutral voltage V3N
0x97D8–0x97D9	38873–38874	R	V	FLOAT32	–	Harmonic 14 of phase-to-phase voltage V12
0x97DA–0x97DB	38875–38876	R	V	FLOAT32	–	Harmonic 14 of phase-to-phase voltage V23

Address	Register	RW	Unit	Type	Range	Description
0x97DC–0x97DD	38877–38878	R	V	FLOAT32	–	Harmonic 14 of phase-to-phase voltage V31
0x97DE–0x97DF	38879–38880	R	V	FLOAT32	–	Harmonic 14 of phase-to-neutral voltage V1N
0x97E0–0x97E1	38881–38882	R	V	FLOAT32	–	Harmonic 14 of phase-to-neutral voltage V2N
0x97E2–0x97E3	38883–38884	R	V	FLOAT32	–	Harmonic 14 of phase-to-neutral voltage V3N
0x97E4–0x97E5	38885–38886	R	V	FLOAT32	–	Harmonic 16 of phase-to-phase voltage V12
0x97E6–0x97E7	38887–38888	R	V	FLOAT32	–	Harmonic 16 of phase-to-phase voltage V23
0x97E8–0x97E9	38889–38890	R	V	FLOAT32	–	Harmonic 16 of phase-to-phase voltage V31
0x97EA–0x97EB	38891–38892	R	V	FLOAT32	–	Harmonic 16 of phase-to-neutral voltage V1N
0x97EC–0x97ED	38893–38894	R	V	FLOAT32	–	Harmonic 16 of phase-to-neutral voltage V2N
0x97EE–0x97EF	38895–38896	R	V	FLOAT32	–	Harmonic 16 of phase-to-neutral voltage V3N
0x97F0–0x97F1	38897–38898	R	V	FLOAT32	–	Harmonic 18 of phase-to-phase voltage V12
0x97F2–0x97F3	38899–38900	R	V	FLOAT32	–	Harmonic 18 of phase-to-phase voltage V23
0x97F4–0x97F5	38901–38902	R	V	FLOAT32	–	Harmonic 18 of phase-to-phase voltage V31
0x97F6–0x97F7	38903–38904	R	V	FLOAT32	–	Harmonic 18 of phase-to-neutral voltage V1N
0x97F8–0x97F9	38905–38906	R	V	FLOAT32	–	Harmonic 18 of phase-to-neutral voltage V2N
0x97FA–0x97FB	38907–38908	R	V	FLOAT32	–	Harmonic 18 of phase-to-neutral voltage V3N
0x97FC–0x97FD	38909–38910	R	V	FLOAT32	–	Harmonic 20 of phase-to-phase voltage V12
0x97FE–0x97FF	38911–38912	R	V	FLOAT32	–	Harmonic 20 of phase-to-phase voltage V23
0x9800–0x9801	38913–38914	R	V	FLOAT32	–	Harmonic 20 of phase-to-phase voltage V31
0x9802–0x9803	38915–38916	R	V	FLOAT32	–	Harmonic 20 of phase-to-neutral voltage V1N
0x9804–0x9805	38917–38918	R	V	FLOAT32	–	Harmonic 20 of phase-to-neutral voltage V2N
0x9806–0x9807	38919–38920	R	V	FLOAT32	–	Harmonic 20 of phase-to-neutral voltage V3N
0x9808–0x9809	38921–38922	R	V	FLOAT32	–	Harmonic 22 of phase-to-phase voltage V12
0x980A–0x980B	38923–38924	R	V	FLOAT32	–	Harmonic 22 of phase-to-phase voltage V23
0x980C–0x980D	38925–38926	R	V	FLOAT32	–	Harmonic 22 of phase-to-phase voltage V31
0x980E–0x980F	38927–38928	R	V	FLOAT32	–	Harmonic 22 of phase-to-neutral voltage V1N
0x9810–0x9811	38929–38930	R	V	FLOAT32	–	Harmonic 22 of phase-to-neutral voltage V2N
0x9812–0x9813	38931–38932	R	V	FLOAT32	–	Harmonic 22 of phase-to-neutral voltage V3N
0x9814–0x9815	38933–38934	R	V	FLOAT32	–	Harmonic 24 of phase-to-phase voltage V12
0x9816–0x9817	38935–38936	R	V	FLOAT32	–	Harmonic 24 of phase-to-phase voltage V23

Address	Register	RW	Unit	Type	Range	Description
0x9818–0x9819	38937–38938	R	V	FLOAT32	–	Harmonic 24 of phase-to-phase voltage V31
0x981A–0x981B	38939–38940	R	V	FLOAT32	–	Harmonic 24 of phase-to-neutral voltage V1N
0x981C–0x981D	38941–38942	R	V	FLOAT32	–	Harmonic 24 of phase-to-neutral voltage V2N
0x981E–0x981F	38943–38944	R	V	FLOAT32	–	Harmonic 24 of phase-to-neutral voltage V3N
0x9820–0x9821	38945–38946	R	V	FLOAT32	–	Harmonic 26 of phase-to-phase voltage V12
0x9822–0x9823	38947–38948	R	V	FLOAT32	–	Harmonic 26 of phase-to-phase voltage V23
0x9824–0x9825	38949–38950	R	V	FLOAT32	–	Harmonic 26 of phase-to-phase voltage V31
0x9826–0x9827	38951–38952	R	V	FLOAT32	–	Harmonic 26 of phase-to-neutral voltage V1N
0x9828–0x9829	38953–38954	R	V	FLOAT32	–	Harmonic 26 of phase-to-neutral voltage V2N
0x982A–0x982B	38955–38956	R	V	FLOAT32	–	Harmonic 26 of phase-to-neutral voltage V3N
0x982C–0x982D	38957–38958	R	V	FLOAT32	–	Harmonic 28 of phase-to-phase voltage V12
0x982E–0x982F	38959–38960	R	V	FLOAT32	–	Harmonic 28 of phase-to-phase voltage V23
0x9830–0x9831	38961–38962	R	V	FLOAT32	–	Harmonic 28 of phase-to-phase voltage V31
0x9832–0x9833	38963–38964	R	V	FLOAT32	–	Harmonic 28 of phase-to-neutral voltage V1N
0x9834–0x9835	38965–38966	R	V	FLOAT32	–	Harmonic 28 of phase-to-neutral voltage V2N
0x9836–0x9837	38967–38968	R	V	FLOAT32	–	Harmonic 28 of phase-to-neutral voltage V3N
0x9838–0x9839	38969–38970	R	V	FLOAT32	–	Harmonic 30 of phase-to-phase voltage V12
0x983A–0x983B	38971–38972	R	V	FLOAT32	–	Harmonic 30 of phase-to-phase voltage V23
0x983C–0x983D	38973–38974	R	V	FLOAT32	–	Harmonic 30 of phase-to-phase voltage V31
0x983E–0x983F	38975–38976	R	V	FLOAT32	–	Harmonic 30 of phase-to-neutral voltage V1N
0x9840–0x9841	38977–38978	R	V	FLOAT32	–	Harmonic 30 of phase-to-neutral voltage V2N
0x9842–0x9843	38979–38980	R	V	FLOAT32	–	Harmonic 30 of phase-to-neutral voltage V3N
0x9844–0x9845	38981–38982	R	V	FLOAT32	–	Harmonic 32 of phase-to-phase voltage V12
0x9846–0x9847	38983–38984	R	V	FLOAT32	–	Harmonic 32 of phase-to-phase voltage V23
0x9848–0x9849	38985–38986	R	V	FLOAT32	–	Harmonic 32 of phase-to-phase voltage V31
0x984A–0x984B	38987–38988	R	V	FLOAT32	–	Harmonic 32 of phase-to-neutral voltage V1N
0x984C–0x984D	38989–38990	R	V	FLOAT32	–	Harmonic 32 of phase-to-neutral voltage V2N
0x984E–0x984F	38991–38992	R	V	FLOAT32	–	Harmonic 32 of phase-to-neutral voltage V3N
0x9850–0x9851	38993–38994	R	V	FLOAT32	–	Harmonic 34 of phase-to-phase voltage V12
0x9852–0x9853	38995–38996	R	V	FLOAT32	–	Harmonic 34 of phase-to-phase voltage V23

Address	Register	RW	Unit	Type	Range	Description
0x9854–0x9855	38997–38998	R	V	FLOAT32	–	Harmonic 34 of phase-to-phase voltage V31
0x9856–0x9857	38999–39000	R	V	FLOAT32	–	Harmonic 34 of phase-to-neutral voltage V1N
0x9858–0x9859	39001–39002	R	V	FLOAT32	–	Harmonic 34 of phase-to-neutral voltage V2N
0x985A–0x985B	39003–39004	R	V	FLOAT32	–	Harmonic 34 of phase-to-neutral voltage V3N
0x985C–0x985D	39005–39006	R	V	FLOAT32	–	Harmonic 36 of phase-to-phase voltage V12
0x985E–0x985F	39007–39008	R	V	FLOAT32	–	Harmonic 36 of phase-to-phase voltage V23
0x9860–0x9861	39009–39010	R	V	FLOAT32	–	Harmonic 36 of phase-to-phase voltage V31
0x9862–0x9863	39011–39012	R	V	FLOAT32	–	Harmonic 36 of phase-to-neutral voltage V1N
0x9864–0x9865	39013–39014	R	V	FLOAT32	–	Harmonic 36 of phase-to-neutral voltage V2N
0x9866–0x9867	39015–39016	R	V	FLOAT32	–	Harmonic 36 of phase-to-neutral voltage V3N
0x9868–0x9869	39017–39018	R	V	FLOAT32	–	Harmonic 38 of phase-to-phase voltage V12
0x986A–0x986B	39019–39020	R	V	FLOAT32	–	Harmonic 38 of phase-to-phase voltage V23
0x986C–0x986D	39021–39022	R	V	FLOAT32	–	Harmonic 38 of phase-to-phase voltage V31
0x986E–0x986F	39023–39024	R	V	FLOAT32	–	Harmonic 38 of phase-to-neutral voltage V1N
0x9870–0x9871	39025–39026	R	V	FLOAT32	–	Harmonic 38 of phase-to-neutral voltage V2N
0x9872–0x9873	39027–39028	R	V	FLOAT32	–	Harmonic 38 of phase-to-neutral voltage V3N
0x9874–0x9875	39029–39030	R	V	FLOAT32	–	Harmonic 40 of phase-to-phase voltage V12
0x9876–0x9877	39031–39032	R	V	FLOAT32	–	Harmonic 40 of phase-to-phase voltage V23
0x9878–0x9879	39033–39034	R	V	FLOAT32	–	Harmonic 40 of phase-to-phase voltage V31
0x987A–0x987B	39035–39036	R	V	FLOAT32	–	Harmonic 40 of phase-to-neutral voltage V1N
0x987C–0x987D	39037–39038	R	V	FLOAT32	–	Harmonic 40 of phase-to-neutral voltage V2N
0x987E–0x987F	39039–39040	R	V	FLOAT32	–	Harmonic 40 of phase-to-neutral voltage V3N

Even Current Harmonics

Address	Register	RW	Unit	Type	Range	Description
0x9880–0x9881	39041–39042	R	A	FLOAT32	–	Harmonic 2 of current on phase 1
0x9882–0x9883	39043–39044	R	A	FLOAT32	–	Harmonic 2 of current on phase 2
0x9884–0x9885	39045–39046	R	A	FLOAT32	–	Harmonic 2 of current on phase 3
0x9886–0x9887	39047–39048	R	A	FLOAT32	–	Harmonic 2 of current on neutral
0x9888–0x9889	39049–39050	R	A	FLOAT32	–	Harmonic 4 of current on phase 1
0x988A–0x988B	39051–39052	R	A	FLOAT32	–	Harmonic 4 of current on phase 2
0x988C–0x988D	39053–39054	R	A	FLOAT32	–	Harmonic 4 of current on phase 3

Address	Register	RW	Unit	Type	Range	Description
0x988E–0x988F	39055–39056	R	A	FLOAT32	–	Harmonic 4 of current on neutral
0x9890–0x9891	39057–39058	R	A	FLOAT32	–	Harmonic 6 of current on phase 1
0x9892–0x9893	39059–39060	R	A	FLOAT32	–	Harmonic 6 of current on phase 2
0x9894–0x9895	39061–39062	R	A	FLOAT32	–	Harmonic 6 of current on phase 3
0x9896–0x9897	39063–39064	R	A	FLOAT32	–	Harmonic 6 of current on neutral
0x9898–0x9899	39065–39066	R	A	FLOAT32	–	Harmonic 8 of current on phase 1
0x989A–0x989B	39067–39068	R	A	FLOAT32	–	Harmonic 8 of current on phase 2
0x989C–0x989D	39069–39070	R	A	FLOAT32	–	Harmonic 8 of current on phase 3
0x989E–0x989F	39071–39072	R	A	FLOAT32	–	Harmonic 8 of current on neutral
0x98A0–0x98A1	39073–39074	R	A	FLOAT32	–	Harmonic 10 of current on phase 1
0x98A2–0x98A3	39075–39076	R	A	FLOAT32	–	Harmonic 10 of current on phase 2
0x98A4–0x98A5	39077–39078	R	A	FLOAT32	–	Harmonic 10 of current on phase 3
0x98A6–0x98A7	39079–39080	R	A	FLOAT32	–	Harmonic 10 of current on neutral
0x98A8–0x98A9	39081–39082	R	A	FLOAT32	–	Harmonic 12 of current on phase 1
0x98AA–0x98AB	39083–39084	R	A	FLOAT32	–	Harmonic 12 of current on phase 2
0x98AC–0x98AD	39085–39086	R	A	FLOAT32	–	Harmonic 12 of current on phase 3
0x98AE–0x98AF	39087–39088	R	A	FLOAT32	–	Harmonic 12 of current on neutral
0x98B0–0x98B1	39089–39090	R	A	FLOAT32	–	Harmonic 14 of current on phase 1
0x98B2–0x98B3	39091–39092	R	A	FLOAT32	–	Harmonic 14 of current on phase 2
0x98B4–0x98B5	39093–39094	R	A	FLOAT32	–	Harmonic 14 of current on phase 3
0x98B6–0x98B7	39095–39096	R	A	FLOAT32	–	Harmonic 14 of current on neutral
0x98B8–0x98B9	39097–39098	R	A	FLOAT32	–	Harmonic 16 of current on phase 1
0x98BA–0x98BB	39099–39100	R	A	FLOAT32	–	Harmonic 16 of current on phase 2
0x98BC–0x98BD	39101–39102	R	A	FLOAT32	–	Harmonic 16 of current on phase 3
0x98BE–0x98BF	39103–39104	R	A	FLOAT32	–	Harmonic 16 of current on neutral
0x98C0–0x98C1	39105–39106	R	A	FLOAT32	–	Harmonic 18 of current on phase 1
0x98C2–0x98C3	39107–39108	R	A	FLOAT32	–	Harmonic 18 of current on phase 2
0x98C4–0x98C5	39109–39110	R	A	FLOAT32	–	Harmonic 18 of current on phase 3
0x98C6–0x98C7	39111–39112	R	A	FLOAT32	–	Harmonic 18 of current on neutral
0x98C8–0x98C9	39113–39114	R	A	FLOAT32	–	Harmonic 20 of current on phase 1
0x98CA–0x98CB	39115–39116	R	A	FLOAT32	–	Harmonic 20 of current on phase 2
0x98CC–0x98CD	39117–39118	R	A	FLOAT32	–	Harmonic 20 of current on phase 3
0x98CE–0x98CF	39119–39120	R	A	FLOAT32	–	Harmonic 20 of current on neutral
0x98D0–0x98D1	39121–39122	R	A	FLOAT32	–	Harmonic 22 of current on phase 1
0x98D2–0x98D3	39123–39124	R	A	FLOAT32	–	Harmonic 22 of current on phase 2
0x98D4–0x98D5	39125–39126	R	A	FLOAT32	–	Harmonic 22 of current on phase 3
0x98D6–0x98D7	39127–39128	R	A	FLOAT32	–	Harmonic 22 of current on neutral
0x98D8–0x98D9	39129–39130	R	A	FLOAT32	–	Harmonic 24 of current on phase 1
0x98DA–0x98DB	39131–39132	R	A	FLOAT32	–	Harmonic 24 of current on phase 2
0x98DC–0x98DD	39133–39134	R	A	FLOAT32	–	Harmonic 24 of current on phase 3
0x98DE–0x98DF	39135–39136	R	A	FLOAT32	–	Harmonic 24 of current on neutral
0x98E0–0x98E1	39137–39138	R	A	FLOAT32	–	Harmonic 26 of current on phase 1
0x98E2–0x98E3	39139–39140	R	A	FLOAT32	–	Harmonic 26 of current on phase 2

Address	Register	RW	Unit	Type	Range	Description
0x98E4–0x98E5	39141–39142	R	A	FLOAT32	–	Harmonic 26 of current on phase 3
0x98E6–0x98E7	39143–39144	R	A	FLOAT32	–	Harmonic 26 of current on neutral
0x98E8–0x98E9	39145–39146	R	A	FLOAT32	–	Harmonic 28 of current on phase 1
0x98EA–0x98EB	39147–39148	R	A	FLOAT32	–	Harmonic 28 of current on phase 2
0x98EC–0x98ED	39149–39150	R	A	FLOAT32	–	Harmonic 28 of current on phase 3
0x98EE–0x98EF	39151–39152	R	A	FLOAT32	–	Harmonic 28 of current on neutral
0x98F0–0x98F1	39153–39154	R	A	FLOAT32	–	Harmonic 30 of current on phase 1
0x98F2–0x98F3	39155–39156	R	A	FLOAT32	–	Harmonic 30 of current on phase 2
0x98F4–0x98F5	39157–39158	R	A	FLOAT32	–	Harmonic 30 of current on phase 3
0x98F6–0x98F7	39159–39160	R	A	FLOAT32	–	Harmonic 30 of current on neutral
0x98F8–0x98F9	39161–39162	R	A	FLOAT32	–	Harmonic 32 of current on phase 1
0x98FA–0x98FB	39163–39164	R	A	FLOAT32	–	Harmonic 32 of current on phase 2
0x98FC–0x98FD	39165–39166	R	A	FLOAT32	–	Harmonic 32 of current on phase 3
0x98FE–0x98FF	39167–39168	R	A	FLOAT32	–	Harmonic 32 of current on neutral
0x9900–0x9901	39169–39170	R	A	FLOAT32	–	Harmonic 34 of current on phase 1
0x9902–0x9903	39171–39172	R	A	FLOAT32	–	Harmonic 34 of current on phase 2
0x9904–0x9905	39173–39174	R	A	FLOAT32	–	Harmonic 34 of current on phase 3
0x9906–0x9907	39175–39176	R	A	FLOAT32	–	Harmonic 34 of current on neutral
0x9908–0x9909	39177–39178	R	A	FLOAT32	–	Harmonic 36 of current on phase 1
0x990A–0x990B	39179–39180	R	A	FLOAT32	–	Harmonic 36 of current on phase 2
0x990C–0x990D	39181–39182	R	A	FLOAT32	–	Harmonic 36 of current on phase 3
0x990E–0x990F	39183–39184	R	A	FLOAT32	–	Harmonic 36 of current on neutral
0x9910–0x9911	39185–39186	R	A	FLOAT32	–	Harmonic 38 of current on phase 1
0x9912–0x9913	39187–39188	R	A	FLOAT32	–	Harmonic 38 of current on phase 2
0x9914–0x9915	39189–39190	R	A	FLOAT32	–	Harmonic 38 of current on phase 3
0x9916–0x9917	39191–39192	R	A	FLOAT32	–	Harmonic 38 of current on neutral
0x9918–0x9919	39193–39194	R	A	FLOAT32	–	Harmonic 40 of current on phase 1
0x991A–0x991B	39195–39196	R	A	FLOAT32	–	Harmonic 40 of current on phase 2
0x991C–0x991D	39197–39198	R	A	FLOAT32	–	Harmonic 40 of current on phase 3
0x991E–0x991F	39199–39200	R	A	FLOAT32	–	Harmonic 40 of current on neutral

Minimum and Maximum Values of Real-Time Measurements

General Description

Read the maximum and minimum values of real-time measurements with associated date and time in the following registers.

Maximum and minimum values of real-time measurements can be reset with the reset minimum/maximum command , page 176.

Timestamp of Reset Actions

Address	Register	RW	Unit	Type	Range	Description
0x891C– 0x891F	35101– 35104	R	–	DATETIME	–	Timestamp of reset of minimum and maximum THD and thd
0x896C– 0x896F	35181– 35184	R	–	DATETIME	–	Timestamp of reset of minimum and maximum RMS current
0x8970– 0x8973	35185– 35188	R	–	DATETIME	–	Timestamp of reset of minimum and maximum RMS voltage
0x8974– 0x8977	35189– 35192	R	–	DATETIME	–	Timestamp of reset of minimum and maximum power
0x8978– 0x897B	35193– 35196	R	–	DATETIME	–	Timestamp of reset of minimum and maximum power factor and cos Φ
0x897C– 0x897F	35197– 35200	R	–	DATETIME	–	Timestamp of reset of minimum and maximum frequency

Maximum Current

Address	Register	RW	Unit	Type	Range	Description
0x89E4– 0x89E5	35301– 35302	R	A	FLOAT32	–	Maximum RMS current on phase 1
0x89E6– 0x89E9	35303– 35306	R	–	DATETIME	–	Timestamp of maximum RMS current on phase 1
0x89EA– 0x89EB	35307– 35308	R	A	FLOAT32	–	Maximum RMS current on phase 2
0x89EC– 0x89EF	35309– 35312	R	–	DATETIME	–	Timestamp of maximum RMS current on phase 2
0x89F0– 0x89F1	35313– 35314	R	A	FLOAT32	–	Maximum RMS current on phase 3
0x89F2– 0x89F5	35315– 35318	R	–	DATETIME	–	Timestamp of maximum RMS current on phase 3
0x89F6– 0x89F7	35319– 35320	R	A	FLOAT32	–	Maximum RMS current on neutral
0x89F8– 0x89FB	35321– 35324	R	–	DATETIME	–	Timestamp of maximum RMS current on neutral
0x89FC– 0x89FD	35325– 35326	R	A	FLOAT32	–	This is the highest (i.e. maximum) current value since this measurement was last reset. The measurement looks at all 4 currents, Max I1, Max I2, Max I3, Max I4 and keeps track of the highest value of any of them over time
0x89FE– 0x8A01	35327– 35330	R	–	DATETIME	–	This is the date/time of the highest (i.e. maximum) current value since this measurement was last reset. The measurement looks at all 4 currents, Max I1, Max I2, Max I3, and Max I4.
0x8A02– 0x8A03	35331– 35332	R	A	FLOAT32	–	Maximum RMS current on ground

Address	Register	RW	Unit	Type	Range	Description
0x8A04– 0x8A07	35333– 35336	R	–	DATETIME	–	Timestamp of maximum RMS current on ground
0x8A08– 0x8A09	35337– 35338	R	A	FLOAT32	–	Maximum RMS current on earth leakage
0x8A0A– 0x8A0D	35339– 35342	R	–	DATETIME	–	Timestamp of maximum RMS current on earth leakage
0x8A0E– 0x8A0F	35343– 35344	R	A	FLOAT32	–	Maximum of average of 3 phase RMS currents
0x8A10– 0x8A13	35345– 35348	R	–	DATETIME	–	Timestamp of maximum of average of 3 phase RMS currents
0x8A14– 0x8A15	35349– 35350	R	–	FLOAT32	–	Maximum phase 1 current unbalance with respect to the average of 3 phase RMS currents
0x8A16– 0x8A19	35351– 35354	R	–	DATETIME	–	Timestamp of maximum phase 1 current unbalance with respect to the average of 3 phase RMS currents
0x8A1A– 0x8A1B	35355– 35356	R	–	FLOAT32	–	Maximum phase 2 current unbalance with respect to the average of 3 phase RMS currents
0x8A1C– 0x8A1F	35357– 35360	R	–	DATETIME	–	Timestamp of maximum phase 2 current unbalance with respect to the average of 3 phase RMS currents
0x8A20– 0x8A21	35361– 35362	R	–	FLOAT32	–	Maximum phase 3 current unbalance with respect to the average of 3 phase RMS currents
0x8A22– 0x8A25	35363– 35366	R	–	DATETIME	–	Timestamp of maximum phase 3 current unbalance with respect to the average of 3 phase RMS currents
0x8A26– 0x8A27	35367– 35368	R	–	FLOAT32	–	Maximum of maximum of 3 phase current unbalances
0x8A28– 0x8A2B	35369– 35372	R	–	DATETIME	–	Timestamp of maximum of maximum of 3 phase current unbalances

Minimum Current

Address	Register	RW	Unit	Type	Range	Description
0x8A32– 0x8A33	35379– 35380	R	A	FLOAT32	–	Minimum RMS current on phase 1
0x8A34– 0x8A37	35381– 35384	R	–	DATETIME	–	Timestamp of minimum RMS current on phase 1
0x8A38– 0x8A39	35385– 35386	R	A	FLOAT32	–	Minimum RMS current on phase 2
0x8A3A– 0x8A3D	35387– 35390	R	–	DATETIME	–	Timestamp of minimum RMS current on phase 2
0x8A3E– 0x8A3F	35391– 35392	R	A	FLOAT32	–	Minimum RMS current on phase 3
0x8A40– 0x8A43	35393– 35396	R	–	DATETIME	–	Timestamp of minimum RMS current on phase 3
0x8A44– 0x8A45	35397– 35398	R	A	FLOAT32	–	Minimum RMS current on neutral
0x8A46– 0x8A49	35399– 35402	R	–	DATETIME	–	Timestamp of minimum RMS current on neutral
0x8A4A– 0x8A4B	35403– 35404	R	A	FLOAT32	–	This is the lowest (i.e. minimum) current value since this measurement was last reset. The measurement looks at all 3 currents, Min I 1, Min I 2, and Min I 3 and keeps track of the lowest value of any of them over time
0x8A4C– 0x8A4F	35405– 35408	R	–	DATETIME	–	Timestamp of minimum of RMS current of phases 1, 2, 3 (Least loaded phase)
0x8A50– 0x8A51	35409– 35410	R	A	FLOAT32	–	Minimum RMS current on ground
0x8A52– 0x8A55	35411– 35414	R	–	DATETIME	–	Timestamp of minimum RMS current on ground

Address	Register	RW	Unit	Type	Range	Description
0x8A56– 0x8A57	35415– 35416	R	A	FLOAT32	–	Minimum RMS current of earth leakage
0x8A58– 0x8A5B	35417– 35420	R	–	DATETIME	–	Timestamp minimum RMS current of earth leakage
0x8A5C– 0x8A5D	35421– 35422	R	A	FLOAT32	–	Minimum of average of 3 phase RMS currents
0x8A5E– 0x8A61	35423– 35426	R	–	DATETIME	–	Timestamp of minimum of average of 3 phase RMS currents

Maximum Voltage

Address	Register	RW	Unit	Type	Range	Description
0x8A68– 0x8A69	35433– 35434	R	V	FLOAT32	–	Maximum RMS phase-to-phase voltage V12
0x8A6A– 0x8A6D	35435– 35438	R	–	DATETIME	–	Timestamp of maximum RMS phase-to-phase voltage V12
0x8A6E– 0x8A6F	35439– 35440	R	V	FLOAT32	–	Maximum RMS phase-to-phase voltage V23
0x8A70– 0x8A73	35441– 35444	R	–	DATETIME	–	Timestamp of maximum RMS phase-to-phase voltage V23
0x8A74– 0x8A75	35445– 35446	R	V	FLOAT32	–	Maximum RMS phase-to-phase voltage V31
0x8A76– 0x8A79	35447– 35450	R	–	DATETIME	–	Timestamp of maximum RMS phase-to-phase voltage V31
0x8A7A– 0x8A7B	35451– 35452	R	V	FLOAT32	–	Maximum RMS phase-to-neutral voltage V1N
0x8A7C– 0x8A7F	35453– 35456	R	–	DATETIME	–	Timestamp of maximum RMS phase-to-neutral voltage V1N
0x8A80– 0x8A81	35457– 35458	R	V	FLOAT32	–	Maximum RMS phase-to-neutral voltage V2N
0x8A82– 0x8A85	35459– 35462	R	–	DATETIME	–	Timestamp of maximum RMS phase-to-neutral voltage V2N
0x8A86– 0x8A87	35463– 35464	R	V	FLOAT32	–	Maximum RMS phase-to-neutral voltage V3N
0x8A88– 0x8A8B	35465– 35468	R	–	DATETIME	–	Timestamp of maximum RMS phase-to-neutral voltage V3N
0x8A8C– 0x8A8D	35469– 35470	R	V	FLOAT32	–	Maximum of average of 3 RMS phase-to-phase voltages
0x8A8E– 0x8A91	35471– 35474	R	–	DATETIME	–	Timestamp of maximum of average of 3 RMS phase-to-phase voltages
0x8A92– 0x8A93	35475– 35476	R	V	FLOAT32	–	Maximum of average of 3 RMS phase-to-neutral voltages
0x8A94– 0x8A97	35477– 35480	R	–	DATETIME	–	Timestamp of maximum of average of 3 RMS phase-to-neutral voltages
0x8A98– 0x8A99	35481– 35482	R	V	FLOAT32	–	Maximum of RMS phase-to-phase voltages V12, V23, and V31
0x8A9A– 0x8A9D	35483– 35486	R	–	DATETIME	–	Timestamp of maximum of RMS phase-to-phase voltages V12, V23, and V31
0x8A9E– 0x8A9F	35487– 35488	R	V	FLOAT32	–	Maximum of RMS phase-to-neutral voltages V1N, V2N, and V3N
0x8AA0– 0x8AA3	35489– 35492	R	–	DATETIME	–	Timestamp of maximum of RMS phase-to-neutral voltages V1N, V2N, and V3N
0x8AA4– 0x8AA5	35493– 35494	R	–	FLOAT32	–	Maximum phase-to-phase V12 voltage unbalance with respect to the average of 3 phase-to-phase RMS voltages

Address	Register	RW	Unit	Type	Range	Description
0x8AA6– 0x8AA9	35495– 35498	R	–	DATETIME	–	Timestamp of maximum phase-to-phase V12 voltage unbalance with respect to the average of 3 phase-to-phase RMS voltages
0x8AAA– 0x8AAB	35499– 35500	R	–	FLOAT32	–	Maximum phase-to-phase V23 voltage unbalance with respect to the average of 3 phase-to-phase RMS voltages
0x8AAC– 0x8AAF	35501– 35504	R	–	DATETIME	–	Timestamp of maximum phase-to-phase V23 voltage unbalance with respect to the average of 3 phase-to-phase RMS voltages
0x8AB0– 0x8AB1	35505– 35506	R	–	FLOAT32	–	Maximum phase-to-phase V31 voltage unbalance with respect to the average of 3 phase-to-phase RMS voltages
0x8AB2– 0x8AB5	35507– 35510	R	–	DATETIME	–	Timestamp of maximum phase-to-phase V31 voltage unbalance with respect to the average of 3 phase-to-phase RMS voltages
0x8AB6– 0x8AB7	35511– 35512	R	–	FLOAT32	–	Maximum of 3 phase-to-phase voltage unbalances
0x8AB8– 0x8ABB	35513– 35516	R	–	DATETIME	–	Timestamp of maximum of 3 phase-to-phase voltage unbalances
0x8ABC– 0x8ABD	35517– 35518	R	–	FLOAT32	–	Maximum phase-to-neutral V1N voltage unbalance with respect to the average of 3 phase-to-neutral RMS voltages
0x8ABE– 0x8AC1	35519– 35522	R	–	DATETIME	–	Timestamp of maximum phase-to-neutral V1N voltage unbalance with respect to the average of 3 phase-to-neutral RMS voltages
0x8AC2– 0x8AC3	35523– 35524	R	–	FLOAT32	–	Maximum phase-to-neutral V2N voltage unbalance with respect to the average of 3 phase-to-neutral RMS voltages
0x8AC4– 0x8AC7	35525– 35528	R	–	DATETIME	–	Timestamp of maximum phase-to-neutral V2N voltage unbalance with respect to the average of 3 phase-to-neutral RMS voltages
0x8AC8– 0x8AC9	35529– 35530	R	–	FLOAT32	–	Maximum phase-to-neutral V3N voltage unbalance with respect to the average of 3 phase-to-neutral RMS voltages
0x8ACA– 0x8ACD	35531– 35534	R	–	DATETIME	–	Timestamp of maximum phase-to-neutral V3N voltage unbalance with respect to the average of 3 phase-to-neutral RMS voltages
0x8ACE– 0x8ACF	35535– 35536	R	–	FLOAT32	–	Maximum of maximum of 3 phase-to-neutral voltage unbalances
0x8AD0– 0x8AD3	35537– 35540	R	–	DATETIME	–	Timestamp of maximum of maximum of 3 phase-to-neutral voltage unbalances

Minimum Voltage

Address	Register	RW	Unit	Type	Range	Description
0x8ADA– 0x8ADB	35547– 35548	R	V	FLOAT32	–	Minimum RMS phase-to-phase voltage V12
0x8ADC– 0x8ADF	35549– 35552	R	–	DATETIME	–	Timestamp of minimum RMS phase-to-phase voltage V12
0x8AE0– 0x8AE1	35553– 35554	R	V	FLOAT32	–	Minimum RMS phase-to-phase voltage V23
0x8AE2– 0x8AE5	35555– 35558	R	–	DATETIME	–	Timestamp of minimum RMS phase-to-phase voltage V23
0x8AE6– 0x8AE7	35559– 35560	R	V	FLOAT32	–	Minimum RMS phase-to-phase voltage V31
0x8AE8– 0x8AEB	35561– 35564	R	–	DATETIME	–	Timestamp of minimum RMS phase-to-phase voltage V31
0x8AEC– 0x8AED	35565– 35566	R	V	FLOAT32	–	Minimum RMS phase-to-neutral voltage V1N

Address	Register	RW	Unit	Type	Range	Description
0x8AEE– 0x8AF1	35567– 35570	R	–	DATETIME	–	Timestamp of minimum RMS phase-to-neutral voltage V1N
0x8AF2– 0x8AF3	35571– 35572	R	V	FLOAT32	–	Minimum RMS phase-to-neutral voltage V2N
0x8AF4– 0x8AF7	35573– 35576	R	–	DATETIME	–	Timestamp of minimum RMS phase-to-neutral voltage V2N
0x8AF8– 0x8AF9	35577– 35578	R	V	FLOAT32	–	Minimum RMS phase-to-neutral voltage V3N
0x8AFA– 0x8AFD	35579– 35582	R	–	DATETIME	–	Timestamp of minimum RMS phase-to-neutral voltage V3N
0x8AFE– 0x8AFF	35583– 35584	R	V	FLOAT32	–	Minimum of average of 3 RMS phase-to-phase voltages
0x8B00– 0x8B03	35585– 35588	R	–	DATETIME	–	Timestamp of minimum of average of 3 RMS phase-to-phase voltages
0x8B04– 0x8B05	35589– 35590	R	V	FLOAT32	–	Minimum of average of 3 RMS phase-to-neutral voltages
0x8B06– 0x8B09	35591– 35594	R	–	DATETIME	–	Timestamp of minimum of average of 3 RMS phase-to-neutral voltages
0x8B0A– 0x8B0B	35595– 35596	R	V	FLOAT32	–	Minimum of RMS phase-to-phase voltages V12, V23, and V31
0x8B0C– 0x8B0F	35597– 35600	R	–	DATETIME	–	Timestamp of minimum of RMS phase-to-phase voltages V12, V23, and V31
0x8B10– 0x8B11	35601– 35602	R	V	FLOAT32	–	Minimum of RMS phase-to-neutral voltages V1N, V2N, and V3N
0x8B12– 0x8B15	35603– 35606	R	–	DATETIME	–	Timestamp of minimum of RMS phase-to-neutral voltages V1N, V2N, and V3N

Maximum Power

Address	Register	RW	Unit	Type	Range	Description
0x8B1C– 0x8B1D	35613– 35614	R	W	FLOAT32	–	Maximum active power of phase 1
0x8B1E– 0x8B21	35615– 35618	R	–	DATETIME	–	Timestamp of maximum active power on phase 1
0x8B22– 0x8B23	35619– 35620	R	W	FLOAT32	–	Maximum active power of phase 2
0x8B24– 0x8B27	35621– 35624	R	–	DATETIME	–	Timestamp of maximum active power on phase 2
0x8B28– 0x8B29	35625– 35626	R	W	FLOAT32	–	Maximum active power of phase 3
0x8B2A– 0x8B2D	35627– 35630	R	–	DATETIME	–	Timestamp of maximum active power on phase 3
0x8B2E– 0x8B2F	35631– 35632	R	W	FLOAT32	–	Maximum total active power
0x8B30– 0x8B33	35633– 35636	R	–	DATETIME	–	Timestamp of maximum total active power
0x8B34– 0x8B35	35637– 35638	R	VAr	FLOAT32	–	Maximum reactive power on phase 1
0x8B36– 0x8B39	35639– 35642	R	–	DATETIME	–	Timestamp of maximum reactive power on phase 1
0x8B3A– 0x8B3B	35643– 35644	R	VAr	FLOAT32	–	Maximum reactive power on phase 2
0x8B3C– 0x8B3F	35645– 35648	R	–	DATETIME	–	Timestamp of maximum reactive power on phase 2
0x8B40– 0x8B41	35649– 35650	R	VAr	FLOAT32	–	Maximum reactive power on phase 3

Address	Register	RW	Unit	Type	Range	Description
0x8B42– 0x8B45	35651- 35654	R	–	DATETIME	–	Timestamp of maximum reactive power on phase 3
0x8B46– 0x8B47	35655- 35656	R	VAr	FLOAT32	–	Maximum total reactive power
0x8B48– 0x8B4B	35657- 35660	R	–	DATETIME	–	Timestamp of maximum total reactive power
0x8B4C– 0x8B4D	35661- 35662	R	VA	FLOAT32	–	Maximum apparent power on phase 1
0x8B4E– 0x8B51	35663- 35666	R	–	DATETIME	–	Timestamp of maximum apparent power on phase 1
0x8B52– 0x8B53	35667- 35668	R	VA	FLOAT32	–	Maximum apparent power on phase 2
0x8B54– 0x8B57	35669- 35672	R	–	DATETIME	–	Timestamp of maximum apparent power on phase 2
0x8B58– 0x8B59	35673- 35674	R	VA	FLOAT32	–	Maximum apparent power on phase 3
0x8B5A– 0x8B5D	35675- 35678	R	–	DATETIME	–	Timestamp of maximum apparent power on phase 3
0x8B5E– 0x8B5F	35679- 35680	R	VA	FLOAT32	–	Maximum total apparent power
0x8B60– 0x8B63	35681- 35684	R	–	DATETIME	–	Timestamp of maximum total apparent power

Minimum Power

Address	Register	RW	Unit	Type	Range	Description
0x8B6A– 0x8B6B	35691- 35692	R	W	FLOAT32	–	Minimum active power of phase 1
0x8B6C– 0x8B6F	35693- 35696	R	–	DATETIME	–	Timestamp of minimum active power on phase 1
0x8B70– 0x8B71	35697- 35698	R	W	FLOAT32	–	Minimum active power of phase 2
0x8B72– 0x8B75	35699- 35702	R	–	DATETIME	–	Timestamp of minimum active power on phase 2
0x8B76– 0x8B77	35703- 35704	R	W	FLOAT32	–	Minimum active power of phase 3
0x8B78– 0x8B7B	35705- 35708	R	–	DATETIME	–	Timestamp of minimum active power on phase 3
0x8B7C– 0x8B7D	35709- 35710	R	W	FLOAT32	–	Minimum total active power
0x8B7E– 0x8B81	35711- 35714	R	–	DATETIME	–	Timestamp of minimum total active power
0x8B82– 0x8B83	35715- 35716	R	VAr	FLOAT32	–	Minimum reactive power on phase 1
0x8B84– 0x8B87	35717- 35720	R	–	DATETIME	–	Timestamp of minimum reactive power on phase 1
0x8B88– 0x8B89	35721- 35722	R	VAr	FLOAT32	–	Minimum reactive power on phase 2
0x8B8A– 0x8B8D	35723- 35726	R	–	DATETIME	–	Timestamp of minimum reactive power on phase 2
0x8B8E– 0x8B8F	35727- 35728	R	VAr	FLOAT32	–	Minimum reactive power on phase 3
0x8B90– 0x8B93	35729- 35732	R	–	DATETIME	–	Timestamp of minimum reactive power on phase 3
0x8B94– 0x8B95	35733- 35734	R	VAr	FLOAT32	–	Minimum total reactive power
0x8B96– 0x8B99	35735- 35738	R	–	DATETIME	–	Timestamp of minimum total reactive power

Address	Register	RW	Unit	Type	Range	Description
0x8B9A– 0x8B9B	35739– 35740	R	VA	FLOAT32	–	Minimum apparent power on phase 1
0x8B9C– 0x8B9F	35741– 35744	R	–	DATETIME	–	Timestamp of minimum apparent power on phase 1
0x8BA0– 0x8BA1	35745– 35746	R	VA	FLOAT32	–	Minimum apparent power on phase 2
0x8BA2– 0x8BA5	35747– 35750	R	–	DATETIME	–	Timestamp of minimum apparent power on phase 2
0x8BA6– 0x8BA7	35751– 35752	R	VA	FLOAT32	–	Minimum apparent power on phase 3
0x8BA8– 0x8BAB	35753– 35756	R	–	DATETIME	–	Timestamp of minimum apparent power on phase 3
0x8BAC– 0x8BAD	35757– 35758	R	VA	FLOAT32	–	Minimum total apparent power
0x8BAE– 0x8BB1	35759– 35762	R	–	DATETIME	–	Timestamp of minimum total apparent power

Maximum Power Factor

Address	Register	RW	Unit	Type	Range	Description
0x8BB8– 0x8BB9	35769– 35770	R	–	FLOAT32	–	Maximum power factor on phase 1
0x8BBA– 0x8BBD	35771– 35774	R	–	DATETIME	–	Timestamp of maximum power factor on phase 1
0x8BBE– 0x8BBF	35775– 35776	R	–	FLOAT32	–	Maximum active power factor of phase 2
0x8BC0– 0x8BC3	35777– 35780	R	–	DATETIME	–	Timestamp of maximum active power factor on phase 2
0x8BC4– 0x8BC5	35781– 35782	R	–	FLOAT32	–	Maximum power factor on phase 3
0x8BC6– 0x8BC9	35783– 35786	R	–	DATETIME	–	Timestamp of maximum power factor on phase 3
0x8BCA– 0x8BCB	35787– 35788	R	–	FLOAT32	–	Maximum total power factor
0x8BCC– 0x8BCF	35789– 35792	R	–	DATETIME	–	Timestamp of maximum total power factor
0x8BD0– 0x8BD1	35793– 35794	R	–	FLOAT32	–	Maximum fundamental power factor on phase 1 (cos φ_1)
0x8BD2– 0x8BD5	35795– 35798	R	–	DATETIME	–	Timestamp of maximum fundamental power factor on phase 1 (cos φ_1)
0x8BD6– 0x8BD7	35799– 35800	R	–	FLOAT32	–	Maximum fundamental power factor on phase 2 (cos φ_2)
0x8BD8– 0x8BDB	35801– 35804	R	–	DATETIME	–	Timestamp of maximum fundamental power factor on phase 2 (cos φ_2)
0x8BDC– 0x8BDD	35805– 35806	R	–	FLOAT32	–	Maximum fundamental power factor on phase 3 (cos φ_3)
0x8BDE– 0x8BE1	35807– 35810	R	–	DATETIME	–	Timestamp of maximum fundamental power factor on phase 3 (cos φ_3)
0x8BE2– 0x8BE3	35811– 35812	R	–	FLOAT32	–	Maximum total fundamental power factor (cos φ)
0x8BE4– 0x8BE7	35813– 35816	R	–	DATETIME	–	Timestamp of maximum total fundamental power factor (cos φ)

Minimum Power Factor

Address	Register	RW	Unit	Type	Range	Description
0x8BEE– 0x8BEF	35823- 35824	R	–	FLOAT32	–	Minimum power factor on phase 1
0x8BF0– 0x8BF3	35825- 35828	R	–	DATETIME	–	Timestamp of minimum power factor on phase 1
0x8BF4– 0x8BF5	35829- 35830	R	–	FLOAT32	–	Minimum power factor on phase 2
0x8BF6– 0x8BF9	35831- 35834	R	–	DATETIME	–	Timestamp of minimum power factor on phase 2
0x8BFA– 0x8BFB	35835- 35836	R	–	FLOAT32	–	Minimum power factor on phase 3
0x8BFC– 0x8BFF	35837- 35840	R	–	DATETIME	–	Timestamp of minimum power factor on phase 3
0x8C00– 0x8C01	35841- 35842	R	–	FLOAT32	–	Minimum total power factor
0x8C02– 0x8C05	35843- 35846	R	–	DATETIME	–	Timestamp of minimum total power factor
0x8C06– 0x8C07	35847- 35848	R	–	FLOAT32	–	Minimum fundamental power factor on phase 1 (cos ϕ_1)
0x8C08– 0x8C0B	35849- 35852	R	–	DATETIME	–	Timestamp of minimum fundamental power factor on phase 1 (cos ϕ_1)
0x8C0C– 0x8C0D	35853- 35854	R	–	FLOAT32	–	Minimum fundamental power factor on phase 2 (cos ϕ_2)
0x8C0E– 0x8C11	35855- 35858	R	–	DATETIME	–	Timestamp of minimum fundamental power factor on phase 2 (cos ϕ_2)
0x8C12– 0x8C13	35859- 35860	R	–	FLOAT32	–	Minimum fundamental power factor on phase 3 (cos ϕ_3)
0x8C14– 0x8C17	35861- 35864	R	–	DATETIME	–	Timestamp of minimum fundamental power factor on phase 3 (cos ϕ_3)
0x8C18– 0x8C19	35865- 35866	R	–	FLOAT32	–	Minimum total fundamental power factor (cos ϕ)
0x8C1A– 0x8C1D	35867- 35870	R	–	DATETIME	–	Timestamp of minimum total fundamental power factor (cos ϕ)

Maximum THD and thd

Address	Register	RW	Unit	Type	Range	Description
0x8C24– 0x8C25	35877- 35878	R	–	FLOAT32	–	Maximum of average of 3 phase-to-phase voltage Total Harmonic Distortions (THD) compared to the fundamental
0x8C26– 0x8C29	35879- 35882	R	–	DATETIME	–	Timestamp of maximum of average of 3 phase-to-phase voltage Total Harmonic Distortions (THD) compared to the fundamental
0x8C2A– 0x8C2B	35883- 35884	R	–	FLOAT32	–	Maximum of average of 3 phase-to-neutral voltage Total Harmonic Distortions (THD) compared to the fundamental
0x8C2C– 0x8C2F	35885- 35888	R	–	DATETIME	–	Timestamp of maximum of average of 3 phase-to-neutral voltage Total Harmonic Distortions (THD) compared to the fundamental
0x8C30– 0x8C31	35889- 35890	R	–	FLOAT32	–	Maximum of average of 3 phase-to-phase voltage total harmonic distortions (thd) compared to the RMS voltage
0x8C32– 0x8C35	35891- 35894	R	–	DATETIME	–	Timestamp of maximum of average of 3 phase-to-phase voltage total harmonic distortions (thd) compared to the RMS voltage
0x8C36– 0x8C37	35895- 35896	R	–	FLOAT32	–	Maximum of average of 3 phase-to-neutral voltage total harmonic distortions (thd) compared to the RMS voltage

Address	Register	RW	Unit	Type	Range	Description
0x8C38– 0x8C3B	35897- 35900	R	–	DATETIME	–	Timestamp of maximum of average of 3 phase-to-neutral voltage total harmonic distortions (thd) compared to the RMS voltage
0x8C3C– 0x8C3D	35901- 35902	R	–	FLOAT32	–	Maximum Total Harmonic Distortion (THD) of current on neutral compared to the fundamental
0x8C3E– 0x8C41	35903- 35906	R	–	DATETIME	–	Timestamp of maximum Total Harmonic Distortion (THD) of current on neutral compared to the fundamental
0x8C42– 0x8C43	35907- 35908	R	–	FLOAT32	–	Maximum of average of 3 phase current Total Harmonic Distortions (THD) compared to the fundamental
0x8C44– 0x8C47	35909- 35912	R	–	DATETIME	–	Timestamp of maximum of average of 3 phase current Total Harmonic Distortions (THD) compared to the fundamental
0x8C48– 0x8C49	35913- 35914	R	–	FLOAT32	–	Maximum total harmonic distortion (thd) of current on neutral compared to the RMS current
0x8C4A– 0x8C4D	35915- 35918	R	–	DATETIME	–	Timestamp of maximum total harmonic distortion (thd) of current on neutral compared to the RMS current
0x8C4E– 0x8C4F	35919- 35920	R	–	FLOAT32	–	Maximum of average of 3 phase current total harmonic distortions (thd) compared to the RMS current
0x8C50– 0x8C53	35921- 35924	R	–	DATETIME	–	Timestamp of maximum of average of 3 phase current total harmonic distortions (thd) compared to the RMS current

Minimum THD and thd

Address	Registers	RW	Unit	Type	Range	Description
0x8C5A– 0x8C5B	35931- 35932	R	–	FLOAT32	–	Minimum of average of 3 phase-to-phase voltage total harmonic distortions (THD) compared to the fundamental average
0x8C5C– 0x8C5F	35933- 35936	R	–	DATETIME	–	Timestamp of minimum of average of 3 phase-to-phase voltage total harmonic distortions (THD) compared to the fundamental
0x8C60– 0x8C61	35937- 35938	R	–	FLOAT32	–	Minimum of average of 3 phase-to-neutral voltage Total Harmonic Distortions (THD) compared to the fundamental
0x8C62– 0x8C65	35939- 35942	R	–	DATETIME	–	Timestamp of minimum of average of 3 phase-to-neutral voltage Total Harmonic Distortions (THD) compared to the fundamental
0x8C66– 0x8C67	35943- 35944	R	–	FLOAT32	–	Minimum of average of 3 phase-to-phase voltage total harmonic distortions (thd) compared to the RMS voltage
0x8C68– 0x8C6B	35945- 35948	R	–	DATETIME	–	Timestamp of minimum of average of 3 phase-to-phase voltage total harmonic distortions (thd) compared to the RMS voltage
0x8C6C– 0x8C6D	35949- 35950	R	–	FLOAT32	–	Minimum of average of 3 phase-to-neutral voltage total harmonic distortions (compared to the RMS voltage) since last reset
0x8C6E– 0x8C71	35951- 35954	R	–	DATETIME	–	Timestamp of minimum of average of 3 phase-to-neutral voltage total harmonic distortions (thd) compared to the RMS voltage
0x8C72– 0x8C73	35955- 35956	R	–	FLOAT32	–	Minimum Total Harmonic Distortion (THD) of current on neutral compared to the fundamental
0x8C74– 0x8C77	35957- 35960	R	–	DATETIME	–	Timestamp of minimum Total Harmonic Distortion (THD) of current on neutral compared to the fundamental
0x8C78– 0x8C79	35961- 35962	R	–	FLOAT32	–	Minimum of average of 3 phase current Total Harmonic Distortions (THD) compared to the fundamental
0x8C7A– 0x8C7D	35963- 35966	R	–	DATETIME	–	Timestamp of minimum of average of 3 phase current Total Harmonic Distortions (THD) compared to the fundamental

Address	Registers	RW	Unit	Type	Range	Description
0x8C7E– 0x8C7F	35967- 35968	R	–	FLOAT32	–	Minimum total harmonic distortion (thd) of current on neutral compared to the RMS current
0x8C80– 0x8C83	35969- 35972	R	–	DATETIME	–	Timestamp of minimum total harmonic distortion (thd) of current on neutral compared to the RMS current
0x8C84– 0x8C85	35973- 35974	R	–	FLOAT32	–	Minimum of average of 3 phase current total harmonic distortions (thd) compared to the RMS current
0x8C86– 0x8C89	35975- 35978	R	–	DATETIME	–	Timestamp of minimum of average of 3 phase current total harmonic distortion (thd) compared to the RMS current

Maximum Frequency

Address	Register	RW	Unit	Type	Range	Description
0x8C90– 0x8C91	35985- 35986	R	Hz	FLOAT32	–	Maximum frequency
0x8C92– 0x8C95	35987- 35990	R	–	DATETIME	–	Timestamp of maximum frequency

Minimum Frequency

Address	Register	RW	Unit	Type	Range	Description
0x8C96– 0x8C97	35991- 35992	R	Hz	FLOAT32	–	Minimum frequency
0x8C98– 0x8C9B	35993- 35996	R	–	DATETIME	–	Timestamp of minimum frequency

Maintenance and Diagnostic Data

Contact Wear

Address	Register	RW	Unit	Type	Range	Description
0x5DC0– 0x5DC1	24001–24002	R	–	FLOAT32	–	Rate of contact wear: <ul style="list-style-type: none"> • 0 = the contacts are new • 1 = the contacts are worn, the circuit breaker must be changed

Load profile

Address	Register	RW	Unit	Type	Range	Description
0x5DCE– 0x5DCF	24015–24016	R	s	INT32U	–	Cumulated duration when current was lower than 49% of rated current In
0x5DD0– 0x5DD1	24017–24018	R	s	INT32U	–	Cumulated duration when current was between 50% and 79% of rated current In
0x5DD2– 0x5DD3	24019–24020	R	s	INT32U	–	Cumulated duration when current was between 80% and 89% of rated current In
0x5DD4– 0x5DD5	24021–24022	R	s	INT32U	–	Cumulated duration when current was higher than 90% of rated current In

Maintenance Data

Address	Register	RW	Unit	Type	Range	Bit	Description
0x7E66– 0x7E72	32359– 32371	R	–	INT16U	–	–	Quality of each bit of registers 32384-32396: <ul style="list-style-type: none"> • 0 = Invalid • 1 = Valid
0x7E73– 0x7E76	32372– 32375	R	–	INT16U	–	–	Tripping cause, page 110
0x7E77– 0x7E7C	32376– 32381	R	–	INT16U	–	–	Protection data, page 111
0x7E7D– 0x7E7E	32382– 32383	R	–	INT16U	–	–	Opening/Closing release data, page 118
0x7E7F	32384	R	–	INT16U	–	0	Protection settings changed by display enabled
						1	Protection settings changed by display
						2	Protection settings changed by Bluetooth/USB/IFE
						3	Communication lost with EIFE/IFE module
						4	Communication lost with IO1 module
						5	Communication lost with IO2 module
						6	Configuration mismatch between IO and control unit: dual settings or inhibit close order
						7	Communication lost with IFM module
						8–9	Reserved
						10	Configuration mismatch between IO and control unit: optional protection inhibit
						11	Configuration mismatch between IO and control unit: local/remote mode
12–15	Reserved						
0x7E80	32385	R	–	INT16U	–	0–2	Reserved

Address	Register	RW	Unit	Type	Range	Bit	Description
						3	Control unit firmware update mode
						4	Digital module license expires in 30 days
						5	Digital module license expires in 20 days
						6	Digital module license expires in 10 days
						7	Control unit firmware update unsuccessful
						8	Digital module license installed
						9	Digital module license uninstalled
						10	Digital module license expired
						11	Digital module license rejected
						12–13	Reserved
						14	Date and time set
						15	Remote protection settings change enabled
0x7E81	32386	R	–	INT16U	–	0	Connection on USB port
						1	Bluetooth communication enabled
						2	PowerTag communication enabled
						3	Connection on Bluetooth port
						4–5	Reserved
						6	Schedule basic maintenance within one month
						7	Schedule standard maintenance within one month
						8	Schedule manufacturer maintenance within three months
						9	Protection settings still set on factory default settings 6 months after commissioning
						10	Remaining service life of MicroLogic below alarm threshold
						11	MicroLogic control unit has reached the maximum service life
						12	Partial Internal Current Power Supply (CPS) sensors malfunction
						13	Partial Internal Current Power Supply (CPS) sensors major malfunction
						14–15	Reserved
0x7E82	32387	R	–	INT16U	–	0	Control unit in test mode
						1	Injection test in progress
						2	Test aborted by user
						3	ZSI test in progress
						4	Ig protection configured in OFF mode
						5	Control unit self test major malfunction 1
						6	Ig function inhibited for test purpose
						7	Internal current sensor disconnected
						8	External neutral current sensor disconnected
						9	Earth leakage sensor disconnected
						10	Internal Current Power Supply (CPS) sensors malfunction
						11	Protection settings reset to factory values
						12	Last modification of protection settings has not been completely applied

Address	Register	RW	Unit	Type	Range	Bit	Description
						13	Unable to read sensor plug
						14	Reserved
						15	Invalid control unit factory configuration 1
0x7E83	32388	R	–	INT16U	–	0	Replace internal battery
						1	NFC invalid communication 1
						2	NFC invalid communication 2
						3	NFC invalid communication 3
						4	Internal battery not detected
						5	Internal Current Power Supply (CPS) sensors malfunction. Tsd forced to 0.
						6	Invalid display screen or wireless communication 1
						7	Reserved
						8	Invalid display screen or wireless communication 3
						9	Invalid PowerTag communication
						10	Loss of Bluetooth communication
						11	Reserved
						12	Self diagnostic test - firmware
						13	Reserved
						14	Control unit alarm reset
						15	Reserved
0x7E84	32389	R	–	INT16U	–	0	IΔn/Ig test - no trip
						1	IΔn/Ig test button pressed
						2	Protection settings not accessible 1
						3	Protection settings not accessible 2
						4	Protection settings not accessible 3
						5	Protection settings not accessible 4
						6	Reserved
						7	Control unit self test 1
						8	Control unit self test 2
						9	Control unit self test 3
						10	Control unit self test 4
						11	Control unit self test 5
						12	Invalid measurement and optional protection 1
						13	Invalid measurement and optional protection 2
						14	Invalid measurement and optional protection 3
						15	Invalid optional protection self test
0x7E85	32390	R	–	INT16U	–	0	Critical hardware module discrepancy
						1	Critical firmware module discrepancy
						2	Non-critical hardware module discrepancy
						3	Non-critical firmware module discrepancy
						4	Address conflict between modules
						5	Firmware discrepancy within control unit
						6	Discrepancy between Display and MicroLogic

Address	Register	RW	Unit	Type	Range	Bit	Description
						7	Main voltage loss and circuit breaker is closed
						8	Invalid self test - MX2 shunt trip
						9	MX2 shunt trip not detected
						10	Presence of external 24 V power supply
						11	Events in history log have been erased
						12	Control unit self test major malfunction 2
						13	Control unit self test major malfunction 3
						14	Control unit self test major malfunction 4
						15	Control unit self test major malfunction 5
0x7E86	32391	R	–	INT16U	–	0	Contact wear is above 60%. Check contacts.
						1	Contact wear is above 95%. Plan for replacement.
						2	Contacts 100% worn out. CB needs to be replaced.
						3	Remaining service life of circuit breaker is below the alarm threshold.
						4	Circuit breaker has reached the max number of operations.
						5	Invalid self test - MX1 shunt trip.
						6	MX1 shunt trip not detected.
						7	Invalid self test - XF shunt close.
						8	XF shunt close not detected.
						9	Invalid self test - MN undervoltage release
						10	MN undervoltage release not detected.
						11	MCH charging operation counter is above alarm threshold
						12	MCH has reached the max number of operations
						13	Voltage loss on MN undervoltage release.
						14	Communication loss on MN undervoltage release.
						15	Reserved
0x7E87	32392	R	–	INT16U	–	0	Reset min/max currents
						1	Reset min/max voltages
						2	Reset min/max power
						3	Reset min/max frequency
						4	Reset min/max harmonics
						5	Reset min/max power factor
						6	Reset min/max current demand
						7	Reset min/max power demand
						8	Reset energy counters
						9–15	Reserved
0x7E88– 0x7EB0	32393– 32433	–	–	–	–	–	Reserved

Diagnostic Data

Address	Register	RW	Unit	Type	Range	Description
0x8980	35201	R	–	INT16U	–	MSB: Overall system health state: <ul style="list-style-type: none"> • 0 = Not evaluated • 1 = Ok • 2 = Medium severity alarm detected • 3 = High severity alarm detected LSB: Reserved
0x8981–0x8982	35202–35203	R	–	FLOAT32	–	Breaker remaining service life ratio: <ul style="list-style-type: none"> • 0 = End of typical service life of the breaker • 1 = New breaker
0x8983–0x8984	35204–35205	R	–	INT32U	–	Total number of operations (opening operation counter)
0x8985–0x8986	35206–35207	R	–	INT32U	–	Number of total trips in operation

Energy Measurements

Active, Reactive, and Apparent Energy

Address	Register	RW	Unit	Type	Range	Description
0x7D5F–0x7D62	32096–32099	R	Wh	INT64	–	Total active energy ⁽¹⁾
0x7D63–0x7D66	32100–32103	R	VARh	INT64	–	Total reactive energy ⁽¹⁾
0x7D67–0x7D6A	32104–32107	R	Wh	INT64U	–	Total active energy delivered (into the load, counted positively) ⁽¹⁾
0x7D6B–0x7D6E	32108–32111	R	Wh	INT64U	–	Total active energy received (out of the load, counted negatively) ⁽¹⁾
0x7D6F–0x7D72	32112–32115	R	VARh	INT64U	–	Total reactive energy delivered (into the load, counted positively) ⁽¹⁾
0x7D73–0x7D76	32116–32119	R	VARh	INT64U	–	Total reactive energy received (out of the load, counted negatively) ⁽¹⁾
0x7D77–0x7D7A	32120–32123	R	VAh	INT64U	–	Total apparent energy ⁽¹⁾
0x7D7B–0x7D7E	32124–32127	R	Wh	INT64U	–	Total cumulative active energy delivered (into the load, counted positively, not resettable)
0x7D7F–0x7D82	32128–32131	R	Wh	INT64U	–	Total cumulative active energy received (out of the load, counted negatively, not resettable)

(1) Value reset with the reset energies command.

Address	Register	RW	Unit	Type	Range	Description
0x5608–0x560B	22025–22028	R	Wh	INT64	–	Total cumulative active energy (not resettable)
0x560C–0x5617	22029–22040	–	–	–	–	Reserved
0x5618–0x561B	22041–22044	R	VARh	INT64	–	Total cumulative reactive energy (not resettable)
0x561C–0x561F	22045–22048	R	VARh	INT64	–	Total cumulative reactive energy delivered (out of the load, counted positively, not resettable)
0x5620–0x5623	22049–22052	R	VARh	INT64	–	Total cumulative reactive energy received (into the load, counted negatively, not resettable)
0x5624–0x5627	22053–22056	R	VAh	INT64	–	Total cumulative apparent energy (not resettable)

Timestamp of Reset Actions

Address	Register	RW	Unit	Type	Range	Description
0x8968–0x896B	35177–35180	R	–	DATETIME	–	Timestamp of last reset of accumulated energy

Energy per Phase

Energy per phase is available when the Energy per Phase Digital Module is purchased and installed on a MicroLogic X control unit.

Address	Register	RW	Unit	Type	Range	Description
0xAD70– 0xAD73	44401–44404	R	Wh	INT64	–	Active energy delivered on phase 1 (into the load, counted positively) ⁽¹⁾
0xAD74– 0xAD77	44405–44408	R	Wh	INT64	–	Active energy received on phase 1 (out of the load, counted negatively) ⁽¹⁾
0xAD78– 0xAD7B	44409–44412	R	Wh	INT64	–	Total active energy delivered on phase 1 (not resettable)
0xAD7C– 0xAD7F	44413–44416	R	Wh	INT64	–	Total active energy received on phase 1 (not resettable)
0xAD80– 0xAD83	44417–44420	R	Wh	INT64	–	Active energy delivered on phase 2 (into the load, counted positively) ⁽¹⁾
0xAD84– 0xAD87	44421–44424	R	Wh	INT64	–	Active energy received on phase 2 (out of the load, counted negatively) ⁽¹⁾
0xAD88– 0xAD8B	44425–44428	R	Wh	INT64	–	Total active energy delivered on phase 2 (not resettable)
0xAD8C– 0xAD8F	44429–44432	R	Wh	INT64	–	Total active energy received on phase 2 (not resettable)
0xAD90– 0xAD93	44433–44436	R	Wh	INT64	–	Active energy delivered on phase 3 (into the load, counted positively) ⁽¹⁾
0xAD94– 0xAD97	44437–44440	R	Wh	INT64	–	Active energy received on phase 3 (out of the load, counted negatively) ⁽¹⁾
0xAD98– 0xAD9B	44441–44444	R	Wh	INT64	–	Total active energy delivered on phase 3 (not resettable)
0xAD9C– 0xAD9F	44445–44448	R	Wh	INT64	–	Total active energy received on phase 3 (not resettable)
0xADA0– 0xADA3	44449–44452	R	VArh	INT64	–	Reactive energy delivered on phase 1 (into the load, counted positively) ⁽¹⁾
0xADA4– 0xADA7	44453–44456	R	VArh	INT64	–	Reactive energy received on phase 1 (out of the load, counted negatively) ⁽¹⁾
0xADA8– 0xADAB	44457–44460	R	VArh	INT64	–	Total reactive energy delivered on phase 1 (not resettable)
0xADAC– 0xADAF	44461–44464	R	VArh	INT64	–	Total reactive energy received on phase 1 (not resettable)
0xADB0– 0xADB3	44465–44468	R	VArh	INT64	–	Reactive energy delivered on phase 2 (into the load, counted positively) ⁽¹⁾
0xADB4– 0xADB7	44469–44472	R	VArh	INT64	–	Reactive energy received on phase 2 (out of the load, counted negatively) ⁽¹⁾
0xADB8– 0xADBB	44473–44476	R	VArh	INT64	–	Total reactive energy delivered on phase 2 (not resettable)
0xADBC– 0xADBF	44477–44480	R	VArh	INT64	–	Total reactive energy received on phase 2 (not resettable)
0xADC0– 0xADC3	44481–44484	R	VArh	INT64	–	Reactive energy delivered on phase 3 (into the load, counted positively) ⁽¹⁾
0xADC4– 0xADC7	44485–44488	R	VArh	INT64	–	Reactive energy received on phase 3 (out of the load, counted negatively) ⁽¹⁾
0xADC8– 0xADCB	44489–44492	R	VArh	INT64	–	Total reactive energy delivered on phase 3 (not resettable)
0xADCC– 0xADCF	44493–44496	R	VArh	INT64	–	Total reactive energy received on phase 3 (not resettable)
0xADD0– 0xADD3	44497–44500	R	VAh	INT64	–	Apparent energy on phase 1 ⁽¹⁾
0xADD4– 0xADD7	44501–44504	R	VAh	INT64	–	Cumulative apparent energy on phase 1 (not resettable)
0xADD8– 0xADDB	44505–44508	R	VAh	INT64	–	Apparent energy on phase 2 ⁽¹⁾
0xADDC– 0xADDF	44509–44512	R	VAh	INT64	–	Cumulative apparent energy on phase 2 (not resettable)

Address	Register	RW	Unit	Type	Range	Description
0xADE0– 0xADE3	44513–44516	R	VAh	INT64	–	Apparent energy on phase 3 ⁽¹⁾
0xADE4– 0xADE7	44517–44520	R	VAh	INT64	–	Cumulative apparent energy on phase 3 (not resettable)

(1) Value reset with the reset energies command.

Protection Settings

Active Neutral Protection Settings

Address	Register	RW	Unit	Type	Range	Description
0xAFC8	45001	R	–	INT16U	0–1	Neutral protection mode <ul style="list-style-type: none"> • 0 = Off • 1 = On (tripping)
0xAFC9	45002	R	–	INT16U	0–3	Neutral protection type <ul style="list-style-type: none"> • 0 = Off • 1 = Half neutral protection • 2 = Full neutral protection • 3 = Oversized neutral protection

Active Long Time Over Current Protection Settings

Address	Register	RW	Unit	Type	Range	Description
0xAFDE	45023	R	–	INT16U	0–1	Long time over current protection mode <ul style="list-style-type: none"> • 0 = Off • 1 = On (tripping)
0xAFDF	45024	R	–	INT16U	1	Long time over current protection curve <ul style="list-style-type: none"> • 1 = Inverse time ($I^2t = ON$)
0xAFE0– 0xAFE1	45025–45026	R	A	FLOAT32	–	Long time over current protection threshold
0xAFE2– 0xAFE3	45027–45028	R	s	FLOAT32	–	Long time over current protection time delay

Active Short Time Over Current Protection Settings

Address	Register	RW	Unit	Type	Range	Description
0xAFE8	45033	R	–	INT16U	0–1	Short time over current protection mode <ul style="list-style-type: none"> • 0 = Off • 1 = On (tripping)
0xAFE9	45034	R	–	INT16U	0–1	Short time over current protection curve <ul style="list-style-type: none"> • 0 = Definite time ($I^2t = OFF$) • 1 = Inverse time ($I^2t = ON$)
0xAFEA– 0xAFEB	45035–45036	R	–	FLOAT32	–	Short time over current protection threshold coefficient
0xA FEC– 0xA FED	45037–45038	R	s	FLOAT32	–	Short time over current protection time delay

Active Instantaneous Protection Settings

Address	Register	RW	Unit	Type	Range	Description
0xAFF2	45043	R	–	INT16U	0–1	Instantaneous over current protection mode <ul style="list-style-type: none"> • 0 = Off • 1 = On (tripping)
0xAFF3	45044	R	–	INT16U	0–1	Instantaneous over current protection time delay mode: <ul style="list-style-type: none"> • 0 = Standard • 1 = Fast
0xAFF4– 0xAFF5	45045–45046	R	–	FLOAT32	–	Instantaneous over current protection threshold coefficient

Active Ground Fault Protection Settings

Address	Register	RW	Unit	Type	Range	Description
0xAFFA	45051	R	–	INT16U	0–1	Ground fault protection mode <ul style="list-style-type: none"> • 0 = Off • 1 = On (tripping)
0xAFFB	45052	R	–	INT16U	0–1	Ground fault protection curve <ul style="list-style-type: none"> • 0 = Definite time ($I^2t = OFF$) • 1 = Inverse time ($I^2t = ON$)
0xAFFC– 0xAFFD	45053– 45054	R	A	FLOAT32	–	Ground fault protection threshold
0xAFFE– 0xAFFF	45055– 45056	R	s	FLOAT32	–	Ground fault protection time delay

Active Earth Leakage Protection Settings

Address	Register	RW	Unit	Type	Range	Description
0xB004	45061	R	–	INT16U	0–1	Earth leakage protection mode <ul style="list-style-type: none"> • 0 = Off • 1 = On
0xB005	45062	R	–	–	–	Reserved
0xB006– 0xB007	45063–45064	R	A	FLOAT32	–	Earth leakage protection threshold
0xB008– 0xB009	45065–45066	R	s	FLOAT32	0.06, 0.15, 0.23, 0.35, 0.80	Earth leakage protection time delay

Demand Values of Real-Time Measurements

Current Demand Values

Address	Register	RW	Unit	Type	Range	Description
0x7D9B–0x7D9C	32156–32157	R	A	FLOAT32	–	Current demand value on phase 1: I1 Dmd
0x7D9D–0x7D9E	32158–32159	R	A	FLOAT32	–	Current demand value on phase 2: I2 Dmd
0x7D9F–0x7DA0	32160–32161	R	A	FLOAT32	–	Current demand value on phase 3: I3 Dmd
0x7DA1–0x7DA2	32162–32163	R	A	FLOAT32	–	Current demand value on the neutral: IN Dmd ⁽¹⁾

(1) Value available when system type register returns 30 or 41.

Power Demand Values

Address	Register	RW	Unit	Type	Range	Description
0x7DA3–0x7DA4	32164–32165	R	W	FLOAT32	–	Total active power demand: P Dmd
0x7DA5–0x7DA6	32166–32167	R	VAR	FLOAT32	–	Total reactive power demand: Q Dmd
0x7DA7–0x7DA8	32168–32169	R	VA	FLOAT32	–	Total apparent power demand: S Dmd

Peak Values of Demand Values of Real-Time Measurements

Current Peak Demand Values

Current peak demand values can be reset with the reset minimum/maximum command.

Address	Register	RW	Unit	Type	Range	Description
0x7DA9–0x7DAA	32170–32171	R	A	FLOAT32	–	Current peak demand value on phase 1: I1 dmd max
0x7DAB–0x7DAC	32172–32173	R	A	FLOAT32	–	Current peak demand value on phase 2: I2 dmd max
0x7DAD–0x7DAE	32174–32175	R	A	FLOAT32	–	Current peak demand value on phase 3: I3 dmd max
0x7DAF–0x7DB0	32176–32177	R	A	FLOAT32	–	Current peak demand value on the neutral: IN dmd max ⁽¹⁾
0x7DF3–0x7DF4	32244–32245	R	A	FLOAT32	–	Average peak current demand

(1) Value available when system type register returns 30 or 41.

Power Peak Demand Values

Power peak demand values can be reset with the reset minimum/maximum command.

Address	Register	RW	Unit	Type	Range	Description
0x7DB1–0x7DB2	32178–32179	R	W	FLOAT32	–	Total active power peak demand: P dmd max
0x7DB3–0x7DB4	32180–32181	R	VAR	FLOAT32	–	Total reactive power peak demand: Q dmd max
0x7DB5–0x7DB6	32182–32183	R	VA	FLOAT32	–	Total apparent power peak demand: S dmd max

Timestamp of Peak Demand Values and Reset of Peak Demand Values

Address	Register	RW	Unit	Type	Range	Description
0x8940–0x8943	35137–35140	R	–	DATETIME	–	Timestamp of peak current demand on neutral
0x8944–0x8947	35141–35144	R	–	DATETIME	–	Timestamp of average peak current demand
0x8948–0x894B	35145–35148	R	–	DATETIME	–	Timestamp of last reset of peak demand current
0x894C–0x894F	35149–35152	R	–	DATETIME	–	Timestamp of last reset of peak demand power
0x8950–0x8953	35153–35156	R	–	DATETIME	–	Timestamp of peak demand current on phase 1
0x8954–0x8957	35157–35160	R	–	DATETIME	–	Timestamp of peak demand current on phase 2
0x8958–0x895B	35161–35164	R	–	DATETIME	–	Timestamp of peak demand current on phase 3
0x895C–0x895F	35165–35168	R	–	DATETIME	–	Timestamp of peak demand active power

Address	Register	RW	Unit	Type	Range	Description
0x8960–0x8963	35169–35172	R	–	DATETIME	–	Timestamp of peak demand reactive power
0x8964–0x8967	35173–35176	R	–	DATETIME	–	Timestamp of peak demand apparent power

MicroLogic Control Unit Commands

What's in This Chapter

List of MicroLogic Control Unit Commands and Error Codes	167
Protection Get Commands without Session	168
Protection Set Commands without Session	173
Measurement Set and Reset Commands	176
Diagnostic Get Commands	177
Measurement Settings Set Commands	183
Circuit Breaker Operation Set Commands	185
MicroLogic X Get and Reset Commands	187

List of MicroLogic Control Unit Commands and Error Codes

List of Commands

The MicroLogic control unit commands are performed by the command interface, page 56. They are grouped by their functions and types:

- Protection get commands, page 168
- Protection set commands, page 173
- Measurement set and reset commands, page 176
- Diagnostic get commands, page 177
- Measurement settings set or reset commands, page 183
- Circuit breaker operation set commands, page 185
- MicroLogic X get and reset commands, page 187

In the MicroLogic control unit registers:

- RC indicates the registers that can be read by a get command
- WC indicates the registers that can be written by a set and reset command

Error Codes

Error codes generated by MicroLogic control units are the generic error codes, page 59.

Protection Get Commands without Session

List of Commands

The following table lists the protection get commands without session, their corresponding command codes, and user profiles:

Command	Command code	User profile
Get neutral protection settings , page 168	51589	No password required
Get ZSI configuration parameters , page 169	49025	No password required
Get dual settings control configuration , page 170	49536	No password required
Get active setting group , page 170	49537	No password required
Get ground fault alarm settings , page 171	51590	No password required
Get earth leakage alarm settings , page 172	51591	No password required

Get Neutral Protection Settings

To get the neutral protection settings, set the command registers in the following way:

Address	Register	Unit	Type	Range	Description
0x1F3F	8000	–	INT16U	51589	Requested command code
0x1F40	8001	–	INT16U	14	Number of parameters of the command
0x1F41	8002	–	INT16U	5377 (0x1501)	Destination of the command
0x1F42	8003	–	INT16U	0	Security type of the command
0x1F43– 0x1F44	8004–8005	–	OCTET STRING	0	Password of the command = 0 (no password required)
0x1F45– 0x1F46	8006–8007	–	INT32U	0xFFFFFFFF- F	Key for the protection get command without session

The neutral protection settings are returned to command registers in the following way:

Address	Register	Unit	Type	Range	Description
0x1F53	8020	–	INT16U	51589	Last command code
0x1F54	8021	–	INT16U	–	Command status: <ul style="list-style-type: none"> • 0 = Successful command • Other value = command with error, page 58
0x1F55	8022	–	INT16U	32	Number of bytes returned
0x1F56– 0x1F57	8023–8024	–	INT32U	0xFFFFFFFF- FF	Key for the protection get command without session
0x1F58	8025	–	INT16U	–	MSB: Neutral protection mode <ul style="list-style-type: none"> • 0 = Off • 1 = On LSB: Neutral protection function supported <ul style="list-style-type: none"> • 0 = Not supported • 1 = Supported
0x1F59– 0x1F5C	8026–8029	–	DATETIME	–	Timestamp of last change of neutral protection mode
0x1F5D	8030	–	INT16U	–	Timestamp quality of last change of neutral protection mode

Address	Register	Unit	Type	Range	Description
0x1F5E– 0x1F61	8031–8034	–	DATETIME	–	Timestamp of last change of any parameter of the neutral protection function
0x1F62	8035	–	INT16U	–	Timestamp quality of last change of any parameter of the neutral protection function
0x1F63	8036	–	INT16U	0–3	MSB: 0 LSB: Neutral protection type <ul style="list-style-type: none"> • 0 = OFF • 1 = 0.5 • 2 = 1.0 • 3 = Oversized
0x1F64– 0x1F65	8037–8038	A	FLOAT32	–	Long time over current protection threshold

Get ZSI Configuration Parameter

To get the ZSI configuration parameter settings, set the command registers in the following way:

Address	Register	Unit	Type	Range	Description
0x1F3F	8000	–	INT16U	49025	Requested command code
0x1F40	8001	–	INT16U	10	Number of parameters of the command
0x1F41	8002	–	INT16U	5377 (0x1501)	Destination of the command
0x1F42	8003	–	INT16U	0	Security type of the command
0x1F43– 0x1F44	8004–8005	–	OCTET STRING	0	Password of the command = 0 (no password required)

The ZSI configuration parameter settings are returned to command registers in the following way:

Address	Register	Unit	Type	Range	Description
0x1F53	8020	–	INT16U	49025	Last command code
0x1F54	8021	–	INT16U	–	Command status: <ul style="list-style-type: none"> • 0 = Successful command • Other value = command with error, page 58
0x1F55	8022	–	INT16U	24	Number of bytes returned
0x1F56	8023	–	INT16U	–	MSB: ZSI configuration mode: <ul style="list-style-type: none"> • 0 = Off • 1 = On (tripping) LSB: ZSI configuration function supported <ul style="list-style-type: none"> • 0 = Not supported • 1 = Supported
0x1F57– 0x1F5A	8024–8027	–	DATETIME	–	Timestamp of last change of ZSI configuration mode
0x1F5B	8028	–	INT16U	–	Timestamp quality of last change of ZSI configuration mode.
0x1F5C– 0x1F5F	8029–8032	–	DATETIME	–	Timestamp of last change of any parameter of the ZSI configuration

Address	Register	Unit	Type	Range	Description
0x1F60	8033	–	INT16U	–	Timestamp quality of last change of any parameter of the ZSI configuration
0x1F61	8034	–	INT16U	0-2	ZSI protection selection: <ul style="list-style-type: none"> • 0 = Short time • 1 = Ground/Earth leakage • 2 = All

Get Dual Settings Control Configuration

To get the dual settings control configuration, set the command registers in the following way:

Address	Register	Unit	Type	Range	Description
0x1F3F	8000	–	INT16U	49536	Requested command code
0x1F40	8001	–	INT16U	10	Number of parameters of the command
0x1F41	8002	–	INT16U	5377 (0x1501)	Destination of the command
0x1F42	8003	–	INT16U	0	Security type of the command
0x1F43– 0x1F44	8004–8005	–	OCTET STRING	0	Password of the command = 0 (no password required)

The dual settings control configuration are returned to command registers in the following way:

Address	Register	Unit	Type	Range	Description
0x1F53	8020	–	INT16U	49536	Last command code
0x1F54	8021	–	INT16U	–	Command status: <ul style="list-style-type: none"> • 0 = Successful command • Other value = command with error, page 58
0x1F55	8022	–	INT16U	6	Number of bytes returned
0x1F56	8023	–	INT16U	–	MSB: Setting group control block mode (Dual settings mode) <ul style="list-style-type: none"> • 0 = Disabled (factory setting) • 1 = Enabled LSB: Setting group control block operating behavior (Dual settings switch mode) <ul style="list-style-type: none"> • 0 = Local HMI • 1 = IO module (1 wire) • 2 = IO module (2 wires) • 3 = Remote
0x1F57– 0x1F58	8024–8025	–	–	–	Reserved

Get Active Setting Group

To get the active setting group, set the command registers in the following way:

Address	Register	Unit	Type	Range	Description
0x1F3F	8000	–	INT16U	49537	Requested command code
0x1F40	8001	–	INT16U	10	Number of parameters of the command
0x1F41	8002	–	INT16U	5377 (0x1501)	Destination of the command

Address	Register	Unit	Type	Range	Description
0x1F42	8003	–	INT16U	0	Security type of the command
0x1F43–0x1F44	8004–8005	–	OCTET STRING	0	Password of the command = 0 (no password required)

The active setting group is returned to command registers in the following way:

Address	Register	Unit	Type	Range	Description
0x1F53	8020	–	INT16U	49537	Last command code
0x1F54	8021	–	INT16U	–	Command status: <ul style="list-style-type: none"> • 0 = Successful command • Other value = command with error, page 58
0x1F55	8022	–	INT16U	12	Number of bytes returned
0x1F56	8023	–	INT16U	–	MSB: Active setting group validation <ul style="list-style-type: none"> • 0 = Invalid, the selection of the active setting group is in progress • 1 = Valid LSB: Active setting group <ul style="list-style-type: none"> • 1 = Setting group A • 2 = Setting group B
0x1F57–0x1F5A	8024–8027	–	DATETIME	–	Timestamp of last active setting group change
0x1F5B	8028	–	INT16U	–	Timestamp quality of last active setting group change

Get Ground Fault Alarm Settings

To set the ground fault alarm, use the set ground fault alarm settings command , page 175.

To get the ground fault alarm settings, set the command registers in the following way:

Address	Register	Unit	Type	Range	Description
0x1F3F	8000	–	INT16U	51590	Requested command code
0x1F40	8001	–	INT16U	14	Number of parameters of the command
0x1F41	8002	–	INT16U	5377 (0x1501)	Destination of the command
0x1F42	8003	–	INT16U	0	Security type of the command
0x1F43–0x1F44	8004–8005	–	OCTET STRING	0	Password of the command = 0 (no password required)
0x1F45–0x1F46	8006–8007	–	INT32U	0xFFFFFFFF-F	Reserved

The ground fault alarm settings are returned to command registers in the following way:

Address	Register	Unit	Type	Range	Description
0x1F52	8020	–	INT16U	51590	Last command code
0x1F53	8021	–	INT16U	–	Command status: <ul style="list-style-type: none"> • 0 = Successful command • Other value = command with error, page 58
0x1F54	8022	–	INT16U	34	Number of bytes returned
0x1F55–0x1F56	8023–8024	–	–	0xFFFFFFFF	Reserved

Address	Register	Unit	Type	Range	Description
0x1F57	8025	–	INT16U	–	MSB: Ground fault alarm mode <ul style="list-style-type: none"> • 0 = Off • 1 = On LSB: Ground fault alarm function supported <ul style="list-style-type: none"> • 0 = Not supported • 1 = Supported
0x1F58– 0x1F61	8026–8035	–	–	–	Reserved
0x1F62– 0x1F63	8036–8037	A	FLOAT32	120–1200	lg alarm pickup value
0x1F64– 0x1F65	8038–8039	s	FLOAT32	1–10	tg alarm time delay

Get Earth Leakage Alarm Settings

To set the earth leakage alarm, use the set earth leakage alarm settings command , page 175.

To get the earth leakage alarm settings, set the command registers in the following way:

Address	Register	Unit	Type	Range	Description
0x1F3F	8000	–	INT16U	51591	Requested command code
0x1F40	8001	–	INT16U	14	Number of parameters of the command
0x1F41	8002	–	INT16U	5377 (0x1501)	Destination of the command
0x1F42	8003	–	INT16U	0	Security type of the command
0x1F43– 0x1F44	8004–8005	–	OCTET STRING	0	Password of the command = 0 (no password required)
0x1F45– 0x1F46	8006–8007	–	–	0xFFFFFFFF- F	Reserved

The earth leakage alarm settings are returned to command registers in the following way:

Address	Register	Unit	Type	Range	Description
0x1F53	8020	–	INT16U	51591	Last command code
0x1F54	8021	–	INT16U	–	Command status: <ul style="list-style-type: none"> • 0 = Successful command • Other value = command with error, page 58
0x1F55	8022	–	INT16U	34	Number of bytes returned
0x1F56– 0x1F57	8023–8024	–	–	0xFFFFFFFF	Reserved
0x1F58	8025	–	INT16U	–	MSB: Earth leakage alarm mode <ul style="list-style-type: none"> • 0 =Off • 1 = On LSB: Earth leakage alarm function supported <ul style="list-style-type: none"> • 0 = Not supported • 1 = Supported
0x1F59– 0x1F62	8026–8035	–	–	–	Reserved
0x1F63– 0x1F64	8036–8037	A	FLOAT32	0.5-22	Earth leakage alarm threshold
0x1F65– 0x1F66	8038–8039	s	FLOAT32	1-10	Earth leakage alarm time delay

Protection Set Commands without Session

List of Commands

The following table lists the protection set commands without session, their corresponding command codes, and user profiles:

Command	Command code	User profile
Set external neutral current transformer settings , page 173	45704	Administrator
Set external neutral voltage sensor settings , page 173	46472	Administrator
Set ZSI configuration parameters , page 174	49033	Administrator
Select active curve , page 174	49545	Administrator or Operator
Set earth leakage alarm settings , page 175	51592	Administrator
Set ground fault alarm settings , page 175	51599	Administrator

Set External Neutral Current Transformer Settings

To set the external neutral current transformer settings, set the command registers in the following way:

Address	Register	Unit	Type	Range	Description
0x1F3F	8000	–	INT16U	45704	Requested command code
0x1F40	8001	–	INT16U	12	Number of parameters of the command
0x1F41	8002	–	INT16U	5377 (0x1501)	Destination of the command
0x1F42	8003	–	INT16U	1	Security type of the command
0x1F43– 0x1F44	8004–8005	–	OCTET STRING	–	Password of the command: Administrator user profile password
0x1F45	8006	–	INT16U	0–1	External neutral current transformer: <ul style="list-style-type: none"> • 0 = Not available • 1 = Available

Set External Neutral Voltage Sensor Settings

To set the external neutral voltage sensor settings, set the command registers in the following way:

Address	Register	Unit	Type	Range	Description
0x1F3F	8000	–	INT16U	46472	Requested command code
0x1F40	8001	–	INT16U	12	Number of parameters of the command
0x1F41	8002	–	INT16U	5377 (0x1501)	Destination of the command
0x1F42	8003	–	INT16U	1	Security type of the command
0x1F43– 0x1F44	8004–8005	–	OCTET STRING	–	Password of the command: Administrator user profile password
0x1F45	8006	–	INT16U	0–1	External neutral voltage sensor <ul style="list-style-type: none"> • 0 = Not available • 1 = Available

Set ZSI Configuration Parameter

To get the ZSI configuration parameters, use the get ZSI configuration parameters command , page 169.

To set the ZSI configuration parameter settings, set the command registers in the following way:

Address	Register	Unit	Type	Range	Description
0x1F3F	8000	–	INT16U	49033	Requested command code
0x1F40	8001	–	INT16U	14	Number of parameters of the command
0x1F41	8002	–	INT16U	5377 (0x1501)	Destination of the command
0x1F42	8003	–	INT16U	1	Security type of the command
0x1F43– 0x1F44	8004–8005	–	OCTET STRING	–	Password of the command: Administrator user profile password
0x1F45	8006	–	INT16U	–	MSB: ZSI configuration mode <ul style="list-style-type: none"> • 0 = Off • 1 = On LSB: 0
0x1F46	8007	–	INT16U	0-2	ZSI protection selection <ul style="list-style-type: none"> • 0 = Short time • 1 = Ground fault/Earth fault • 2 = All

Select Active Curve

To get the active setting group, use the get active setting group command , page 170.

To set the active setting group, set the command registers in the following way:

Address	Register	Unit	Type	Range	Description
0x1F3F	8000	–	INT16U	49545	Requested command code
0x1F40	8001	–	INT16U	12	Number of parameters of the command
0x1F41	8002	–	INT16U	5377 (0x1501)	Destination of the command
0x1F42	8003	–	INT16U	1	Security type of the command
0x1F43– 0x1F44	8004–8005	–	OCTET STRING	–	Password of the command: Administrator or Operator user profile password
0x1F45	8006	–	INT16U	–	MSB: Active setting group <ul style="list-style-type: none"> • 1 = Setting curve A • 2 = Setting curve B LSB: Dual setting operating behavior <ul style="list-style-type: none"> • 0 = Local • 1 = IO module (1 wire) • 2 = IO module (2 wires) • 3 = Remote

NOTE: After selecting the active setting group, use the get active setting group command , page 170 to get the confirmation that the set command has been executed successfully.

Set Earth Leakage Alarm Settings

To get the earth leakage alarm settings, use the get earth leakage alarm settings command , page 172.

To set the earth leakage alarm settings, set the command registers in the following way:

Address	Register	Unit	Type	Range	Description
0x1F3F	8000	–	INT16U	51592	Requested command code
0x1F40	8001	–	INT16U	24	Number of parameters of the command
0x1F41	8002	–	INT16U	5377 (0x1501)	Destination of the command
0x1F42	8003	–	INT16U	1	Security type of the command
0x1F43– 0x1F44	8004–8005	–	OCTET STRING	–	Password of the command: Administrator user profile password
0x1F45– 0x1F46	8006–8007	–	INT32U	0xFFFFFFFF- F	Reserved
0x1F47	8008	–	INT16U	–	MSB: Earth leakage alarm mode <ul style="list-style-type: none"> • 0 = Off (alarm disabled) • 1 = On (alarm enabled) LSB: 0
0x1F48– 0x1F49	8009–8010	A	FLOAT32	0.5–22.0 (step 0.1)	Earth leakage alarm threshold
0x1F4A– 0x1F4B	8011–8012	s	FLOAT32	1-10	Earth leakage alarm time delay

Set Ground Fault Alarm Settings

To get the ground fault alarm settings, use the get ground fault alarm settings command , page 171.

To set the ground fault alarm settings, set the command registers in the following way:

Address	Register	Unit	Type	Range	Description
0x1F3F	8000	–	INT16U	51599	Requested command code
0x1F40	8001	–	INT16U	24	Number of parameters of the command
0x1F41	8002	–	INT16U	5377 (0x1501)	Destination of the command
0x1F42	8003	–	INT16U	1	Security type of the command
0x1F43– 0x1F44	8004–8005	–	OCTET STRING	–	Password of the command: Administrator user profile password
0x1F45– 0x1F46	8006–8007	–	INT32U	0xFFFFFFFF- F	Reserved
0x1F47	8008	–	INT16U	–	MSB: Ground fault alarm mode <ul style="list-style-type: none"> • 0 = Off (alarm disabled) • 1 = On (alarm enabled) LSB: 0
0x1F48– 0x1F49	8009–8010	A	FLOAT32	120–1200	Ground fault alarm threshold
0x1F4A– 0x1F4B	8011–8012	s	FLOAT32	1-10	Ground fault alarm time delay

Measurement Set and Reset Commands

List of Commands

The following table lists the measurement set and reset commands, their corresponding command codes, and user profiles:

Command	Command code	User profile
Reset minimum/maximum values and energies , page 176	46728	Administrator or Operator

Reset Minimum/Maximum Values and Energies

To reset minimum/maximum values and energy, set the command registers in the following way:

Address	Register	Unit	Type	Range	Bit	Description
0x1F3F	8000	–	INT16U	46728	–	Requested command code
0x1F40	8001	–	INT16U	12	–	Number of parameters of the command
0x1F41	8002	–	INT16U	5377 (0x1501)	–	Destination of the command
0x1F42	8003	–	INT16U	1	–	Security type of the command
0x1F43– 0x1F44	8004–8005	–	OCTET STRING	–	–	Password of the command: Administrator or Operator user profile password
0x1F45	8006	–	INT16U	–	0	Reset min-max current
					1	Reset min-max voltage
					2	Reset min-max power
					3	Reset min-max power factor and cosφ
					4	Reset min-max THD (% fund)
					5	Reset peak current demand
					6	Reset peak power demand
					7	Reset min-max frequency
					8	Reserved
					9	Reset all energies
10–15	Reserved					

Diagnostic Get Commands

List of Commands

The following table lists the diagnostic get commands, their corresponding command codes, and user profiles:

Command	Command code	User profile
Get coil information , page 177	49793	No password required
Get health state , page 178	49794	No password required
Get trip counters in operation , page 179	49795	No password required
Get trip counters in test mode , page 180	49796	No password required
Get trip counters in manual test mode , page 180	49797	No password required
Get motor charging operation information , page 181	49798	No password required
Get breaker durability , page 181	51328	No password required
Get operating times , page 182	51329	No password required

Get Coil Information

To get the coil information, set the command registers in the following way:

Address	Register	Unit	Type	Range	Description
0x1F3F	8000	–	INT16U	49793	Requested command code
0x1F40	8001	–	INT16U	11	Number of parameters of the command
0x1F41	8002	–	INT16U	5377 (0x1501)	Destination of the command
0x1F42	8003	–	INT16U	0	Security type of the command
0x1F43– 0x1F44	8004–8005	–	OCTET STRING	0	Password of the command = 0 (no password required)
0x1F45	8006	–	INT16U	–	MSB: Requested coil identification: <ul style="list-style-type: none"> • 16 = MX1 opening voltage release • 17 = XF closing voltage release • 18 = MN opening undervoltage release • 19 = MX2 opening voltage release LSB: 0 (not used)

The coil information is returned to command registers in the following way:

Address	Register	Unit	Type	Range	Bit	Description
0x1F53	8020	–	INT16U	49793	–	Last command code
0x1F54	8021	–	INT16U	–	–	Command status: <ul style="list-style-type: none"> • 0 = Successful command • Other value = command with error, page 58
0x1F55	8022	–	INT16U	4	–	Number of bytes returned
0x1F56	8023	–	INT16U	1–3	–	MSB: Responded coil identification: <ul style="list-style-type: none"> • 16 = MX1 opening voltage release • 17 = XF closing voltage release • 18 = MN opening undervoltage release • 19 = MX2 opening voltage release LSB: 0 (not used)

Address	Register	Unit	Type	Range	Bit	Description					
0x1F58	8024	–	INT16U	–	0	Application type: <ul style="list-style-type: none"> • 0 = Opening (MX or MN coil) • 1 = Closing (XF coil) 					
					1	Communication status: <ul style="list-style-type: none"> • 0 = Not communicating (standard voltage or undervoltage release) • 1 = Communicating <ul style="list-style-type: none"> ◦ MX1 (Diagnostic and communication) ◦ XF (Diagnostic and communication) ◦ MN or MX2 (Diagnostic) 					
					2	Physical health (release autotest result): <ul style="list-style-type: none"> • 0 = Release malfunction (release needs to be replaced) • 1 = Release OK 					
					3	Coil activation status: <ul style="list-style-type: none"> • 0 = Plunger not activated <ul style="list-style-type: none"> ◦ MN diagnostic plunger pull out (opening order activated) ◦ MX2 diagnostic plunger pushed in (opening order not activated) • 1 = Plunger activated <ul style="list-style-type: none"> ◦ MN diagnostic plunger pushed in (opening order not activated) ◦ MX2 diagnostic plunger pull out (opening order activated) 					
					4	Model type: <ul style="list-style-type: none"> • 0 = Not MN undervoltage release • 1 = MN undervoltage release 					
					5–7	Reserved					
					8	Application type quality: <ul style="list-style-type: none"> • 0 = Invalid • 1 = Valid 					
					9	Communication status quality: <ul style="list-style-type: none"> • 0 = Invalid • 1 = Valid 					
										10	Physical health quality: <ul style="list-style-type: none"> • 0 = Invalid • 1 = Valid
										11	Quality of coil activation status: <ul style="list-style-type: none"> • 0 = Invalid • 1 = Valid
12	Model type quality: <ul style="list-style-type: none"> • 0 = Invalid • 1 = Valid 										
13–15	Reserved										

Get Health State

To get the health state, set the command registers in the following way:

Address	Register	Unit	Type	Range	Description
0x1F3F	8000	–	INT16U	49794	Requested command code
0x1F40	8001	–	INT16U	14	Number of parameters of the command

Address	Register	Unit	Type	Range	Description
0x1F41	8002	–	INT16U	5377 (0x1501)	Destination of the command
0x1F42	8003	–	INT16U	0	Security type of the command
0x1F43–0x1F44	8004–8005	–	OCTET STRING	0	Password of the command = 0 (no password required)
0x1F45–0x1F46	8006–8007	–	–	0xFFFFFFFF	Reserved

The health state is returned to command registers in the following way:

Address	Register	Unit	Type	Range	Description
0x1F53	8020	–	INT16U	49794	Last command code
0x1F54	8021	–	INT16U	–	Command status: <ul style="list-style-type: none"> • 0 = Successful command • Other value = command with error, page 58
0x1F55	8022	–	INT16U	6	Number of bytes returned
0x1F56–0x1F57	8023–8024	–	–	–	Reserved
0x1F58	8025	–	INT16U	–	MSB: Overall system health state <ul style="list-style-type: none"> • 0 = Not evaluated • 1 = Ok • 2 = Medium severity alarm detected • 3 = High severity alarm detected LSB: Reserved

Get Trip Counters in Operation

To get the trip counters in operation, set the command registers in the following way:

Address	Register	Unit	Type	Range	Description
0x1F3F	8000	–	INT16U	49795	Requested command code
0x1F40	8001	–	INT16U	10	Number of parameters of the command
0x1F41	8002	–	INT16U	5377 (0x1501)	Destination of the command
0x1F42	8003	–	INT16U	0	Security type of the command
0x1F43–0x1F44	8004–8005	–	OCTET STRING	0	Password of the command = 0 (no password required)

The trip counters in operation is returned to command registers in the following way:

Address	Register	Unit	Type	Range	Description
0x1F53	8020	–	INT16U	49795	Last command code
0x1F54	8021	–	INT16U	–	Command status: <ul style="list-style-type: none"> • 0 = Successful command • Other value = command with error, page 58
0x1F55	8022	–	INT16U	24	Number of bytes returned
0x1F56–0x1F57	8023–8024	–	INT32U	–	Number of total trips in operation
0x1F58–0x1F59	8025–8026	–	INT32U	–	Number of long time trips in operation

Address	Register	Unit	Type	Range	Description
0x1F5A– 0x1F5B	8027–8028	–	INT32U	–	Number of short time trips in operation
0x1F5C– 0x1F5D	8029–8030	–	INT32U	–	Number of instantaneous trips in operation
0x1F5E– 0x1F5F	8031–8032	–	INT32U	–	Number of ground/earth leakage fault trips in operation
0x1F60– 0x1F61	8033–8034	–	INT32U	–	Number of other trips in operation

Get Trip Counters in Test Mode

To get the trip counters in test mode, set the command registers in the following way:

Address	Register	Unit	Type	Range	Description
0x1F3F	8000	–	INT16U	49796	Requested command code
0x1F40	8001	–	INT16U	10	Number of parameters of the command
0x1F41	8002	–	INT16U	5377 (0x1501)	Destination of the command
0x1F42	8003	–	INT16U	0	Security type of the command
0x1F43– 0x1F44	8004–8005	–	OCTET STRING	0	Password of the command = 0 (no password required)

The trip counters in test mode is returned to command registers in the following way:

Address	Register	Unit	Type	Range	Description
0x1F53	8020	–	INT16U	49796	Last command code
0x1F54	8021	–	INT16U	–	Command status: <ul style="list-style-type: none"> • 0 = Successful command • Other value = command with error, page 58
0x1F55	8022	–	INT16U	12	Number of bytes returned
0x1F56– 0x1F57	8023–8024	–	INT32U	–	Number of total trips in test mode
0x1F58– 0x1F5B	8025–8028	–	DATETIME	–	Date/Time of last trip in test mode

Get Trip Counters in Manual Test Mode

To get the trip counters in manual test mode, set the command registers in the following way:

Address	Register	Unit	Type	Range	Description
0x1F3F	8000	–	INT16U	49797	Requested command code
0x1F40	8001	–	INT16U	10	Number of parameters of the command
0x1F41	8002	–	INT16U	5377 (0x1501)	Destination of the command
0x1F42	8003	–	INT16U	0	Security type of the command
0x1F43– 0x1F44	8004–8005	–	OCTET STRING	0	Password of the command = 0 (no password required)

The trip counters in manual test mode is returned to command registers in the following way:

Address	Register	Unit	Type	Range	Description
0x1F53	8020	–	INT16U	49797	Last command code
0x1F54	8021	–	INT16U	–	Command status: <ul style="list-style-type: none"> • 0 = Successful command • Other value = command with error, page 58
0x1F55	8022	–	INT16U	12	Number of bytes returned
0x1F56– 0x1F57	8023–8024	–	INT32U	–	Number of total trips in manual test mode
0x1F58– 0x1F5B	8025–8028	–	DATETIME	–	Date/Time of last trip in manual test mode

Get Motor Charging Operation Information

To get the motor charging operation information, set the command registers in the following way:

Address	Register	Unit	Type	Range	Description
0x1F3F	8000	–	INT16U	49798	Requested command code
0x1F40	8001	–	INT16U	10	Number of parameters of the command
0x1F41	8002	–	INT16U	5377 (0x1501)	Destination of the command
0x1F42	8003	–	INT16U	0	Security type of the command
0x1F43– 0x1F44	8004–8005	–	OCTET STRING	0	Password of the command = 0 (no password required)

The motor charging operation information is returned to command registers in the following way:

Address	Register	Unit	Type	Range	Description
0x1F53	8020	–	INT16U	49798	Last command code
0x1F54	8021	–	INT16U	–	Command status: <ul style="list-style-type: none"> • 0 = Successful command • Other value = command with error, page 58
0x1F55	8022	–	INT16U	8	Number of bytes returned
0x1F56– 0x1F57	8023–8024	–	INT32U	–	Motor charging operation counter
0x1F58– 0x1F59	8025–8026	s	FLOAT32	–	Motor last charging time after closing

Get Breaker Durability

To get the breaker durability information, set the command registers in the following way:

Address	Register	Unit	Type	Range	Description
0x1F3F	8000	–	INT16U	51328	Requested command code
0x1F40	8001	–	INT16U	10	Number of parameters of the command
0x1F41	8002	–	INT16U	5377 (0x1501)	Destination of the command

Address	Register	Unit	Type	Range	Description
0x1F42	8003	–	INT16U	0	Security type of the command
0x1F43– 0x1F44	8004–8005	–	OCTET STRING	0	Password of the command = 0 (no password required)

The breaker durability information is returned to command registers in the following way:

Address	Register	Unit	Type	Range	Description
0x1F53	8020	–	INT16U	51328	Last command code
0x1F54	8021	–	INT16U	–	Command status: <ul style="list-style-type: none"> • 0 = Successful command • Other value = command with error, page 58
0x1F55	8022	–	INT16U	28	Number of bytes returned
0x1F56– 0x1F57	8023–8024	–	INT32U	–	Total number of operations (opening operation counter)
0x1F58– 0x1F59	8025–8026	–	INT32U	–	Number of operation with load > 0.4 In
0x1F5A– 0x1F5B	8027–8028	–	FLOAT32	0-1	Breaker remaining service life ratio: <ul style="list-style-type: none"> • 0 = End of typical service life of the breaker • 1 = Breaker is new
0x1F5C– 0x1F63	8029–8036	–	–	–	Reserved

Get Operating Times

To get the operating time information, set the command registers in the following way:

Address	Register	Unit	Type	Range	Description
0x1F3F	8000	–	INT16U	51329	Requested command code
0x1F40	8001	–	INT16U	10	Number of parameters of the command
0x1F41	8002	–	INT16U	5377 (0x1501)	Destination of the command
0x1F42	8003	–	INT16U	0	Security type of the command
0x1F43– 0x1F44	8004–8005	–	OCTET STRING	0	Password of the command = 0 (no password required)

The operating time information is returned to command registers in the following way:

Address	Register	Unit	Type	Range	Description
0x1F53	8020	–	INT16U	51329	Last command code
0x1F54	8021	–	INT16U	–	Command status: <ul style="list-style-type: none"> • 0 = Successful command • Other value = command with error, page 58
0x1F55	8022	–	INT16U	8	Number of bytes returned
0x1F56– 0x1F57	8023–8024	s	INT32U	–	Time of use
0x1F58– 0x1F59	8025–8026	s	INT32U	–	Operating time with load

Measurement Settings Set Commands

List of Commands

The following table lists the measurement settings set commands, their corresponding command codes, and user profiles:

Command	Command code	User profile
Set power flow sign configuration , page 183	47240	Administrator
Set power factor sign convention , page 183	47241	Administrator
Set energy accumulation mode , page 184	47242	Administrator
Set current demand configuration , page 184	47243	Administrator
Set power demand configuration , page 184	47244	Administrator

Set Power Flow Sign Configuration

To set the power flow sign configuration, set the command registers in the following way:

Address	Register	Unit	Type	Range	Description
0x1F3F	8000	–	INT16U	47240	Requested command code
0x1F40	8001	–	INT16U	12	Number of parameters of the command
0x1F41	8002	–	INT16U	5377 (0x1501)	Destination of the command
0x1F42	8003	–	INT16U	1	Security type of the command
0x1F43– 0x1F44	8004–8005	–	OCTET STRING	–	Password of the command: Administrator user profile password
0x1F45	8006	–	INT16U	0–1	Power sign <ul style="list-style-type: none"> • 0 = Direct or P+ = the active power flows from upstream (top) to downstream (bottom) (factory setting) • 1 = Inverted or P– = the active power flows from downstream (bottom) to upstream (top)

Set Power Factor Sign Convention

To set the power factor sign convention, set the command registers in the following way:

Address	Register	Unit	Type	Range	Description
0x1F3F	8000	–	INT16U	47241	Requested command code
0x1F40	8001	–	INT16U	12	Number of parameters of the command
0x1F41	8002	–	INT16U	5377 (0x1501)	Destination of the command
0x1F42	8003	–	INT16U	1	Security type of the command
0x1F43– 0x1F44	8004–8005	–	OCTET STRING	–	Password of the command: Administrator user profile password
0x1F45	8006	–	INT16U	0, 2	Power factor sign convention: <ul style="list-style-type: none"> • 0 = IEC • 2 = IEEE (factory setting)

Set Energy Accumulation Mode

To set the energy accumulation mode, set the command registers in the following way:

Address	Register	Unit	Type	Range	Description
0x1F3F	8000	–	INT16U	47242	Requested command code
0x1F40	8001	–	INT16U	12	Number of parameters of the command
0x1F41	8002	–	INT16U	5377 (0x1501)	Destination of the command
0x1F42	8003	–	INT16U	1	Security type of the command
0x1F43– 0x1F44	8004–8005	–	OCTET STRING	–	Password of the command: Administrator user profile password
0x1F45	8006	–	INT16U	0–1	Energy accumulation mode: <ul style="list-style-type: none"> • 0 = Absolute (factory setting) • 1 = Signed

Set Current Demand Configuration

To set the current demand configuration, set the command registers in the following way:

Address	Register	Unit	Type	Range	Description
0x1F3F	8000	–	INT16U	47243	Requested command code
0x1F40	8001	–	INT16U	12	Number of parameters of the command
0x1F41	8002	–	INT16U	5377 (0x1501)	Destination of the command
0x1F42	8003	–	INT16U	1	Security type of the command
0x1F43– 0x1F44	8004–8005	–	OCTET STRING	–	Password of the command: Administrator user profile password
0x1F45	8006	min	INT16U	1–60	Current demand calculation interval time

Set Power Demand Configuration

To set the power demand configuration, set the command registers in the following way:

Address	Register	Unit	Type	Range	Description
0x1F3F	8000	–	INT16U	47244	Requested command code
0x1F40	8001	–	INT16U	14	Number of parameters of the command
0x1F41	8002	–	INT16U	5377 (0x1501)	Destination of the command
0x1F42	8003	–	INT16U	1	Security type of the command
0x1F43– 0x1F44	8004–8005	–	OCTET STRING	–	Password of the command: Administrator user profile password
0x1F45	8006	–	INT16U	0	Power demand calculation method: <ul style="list-style-type: none"> • 0 = sliding window
0x1F46	8007	min	INT16U	1-60	Power demand calculation interval time

Circuit Breaker Operation Set Commands

List of Commands

The following table lists the circuit breaker operation set commands, their corresponding command codes, and user profiles:

Command	Command code	User profile
Open circuit breaker , page 185	904	Administrator or Operator
Close circuit breaker , page 185	905	Administrator or Operator
Set close breaker inhibition , page 185	910	Administrator or Operator

Open Circuit Breaker

To open the circuit breaker, set the command registers in the following way:

Address	Register	Unit	Type	Range	Description
0x1F3F	8000	–	INT16U	904	Requested command code
0x1F40	8001	–	INT16U	10	Number of parameters of the command
0x1F41	8002	–	INT16U	5377 (0x1501)	Destination of the command
0x1F42	8003	–	INT16U	1	Security type of the command
0x1F43–0x1F44	8004–8005	–	OCTET STRING	–	Password of the command: Administrator or Operator user profile password

NOTE: After use of the open circuit breaker command, check that the circuit breaker is open in register 32001, page 77.

Close Circuit Breaker

To close the circuit breaker, set the command registers in the following way:

Address	Register	Unit	Type	Range	Description
0x1F3F	8000	–	INT16U	905	Requested command code
0x1F40	8001	–	INT16U	10	Number of parameters of the command
0x1F41	8002	–	INT16U	5377 (0x1501)	Destination of the command
0x1F42	8003	–	INT16U	1	Security type of the command
0x1F43–0x1F44	8004–8005	–	OCTET STRING	–	Password of the command: Administrator or Operator user profile password

NOTE: After use of the close circuit breaker command, check that the circuit breaker is closed in register 32001, page 77.

Set Close Breaker Inhibition

To enable or inhibit the close circuit breaker command, set the command registers in the following way:

Address	Register	Unit	Type	Range	Description
0x1F3F	8000	–	INT16U	910	Requested command code
0x1F40	8001	–	INT16U	13	Number of parameters of the command
0x1F41	8002	–	INT16U	5377 (0x1501)	Destination of the command
0x1F42	8003	–	INT16U	1	Security type of the command
0x1F43-0x1F44	8004–8005	–	OCTET STRING	–	Password of the command: Administrator or Operator user profile password
0x1F45	8006	–	INT16U	0–1	Close breaker inhibited by communication: <ul style="list-style-type: none"> • 0 = Enable close order • 1 = Inhibit close order
0x1F46	8007	–	INT16U	1	Origin of the command: <ul style="list-style-type: none"> • 1 = close breaker enable/inhibit command from remote controller using the communication network

MicroLogic X Get and Reset Commands

List of Commands

The following table lists the MicroLogic X get and reset commands, their corresponding command codes, and user profiles:

Command	Command code	User profile
Get date time , page 187	768	No password required
Reset events , page 187	50056	Administrator or Operator
Get events , page 191	50560	No password required
Get list of Digital Modules , page 192	50816	No password required
Get Digital Modules details , page 194	50817	No password required

Get Date Time

To get the date and time of the MicroLogic X control unit, set the command registers in the following way:

Address	Register	Unit	Type	Range	Description
0x1F3F	8000	–	INT16U	768	Requested command code
0x1F40	8001	–	INT16U	10	Number of parameters of the command
0x1F41	8002	–	INT16U	5376 (0x1500)	Destination of the command
0x1F42	8003	–	INT16U	0	Security type of the command
0x1F43– 0x1F44	8004–8005	–	OCTET STRING	0	Password of the command = 0 (no password required)

The date and time of the MicroLogic X control unit is returned to command registers in the following way:

Address	Register	Unit	Type	Range	Description
0x1F53	8020	–	INT16U	768	Last command code
0x1F54	8021	–	INT16U	–	Command status: <ul style="list-style-type: none"> • 0 = Successful command • Other value = command with error, page 58
0x1F55	8022	–	INT16U	8	Number of bytes returned
0x1F56– 0x1F59	8023–8026	–	XDATE	–	Current date/time of the source

Reset Events

To reset events, set the command registers in the following way:

Address	Register	Unit	Type	Range	Description
0x1F3F	8000	–	INT16U	50056	Requested command code
0x1F40	8001	–	INT16U	10	Number of parameters of the command
0x1F41	8002	–	INT16U	5377	Destination of the command

Address	Register	Unit	Type	Range	Description
0x1F42	8003	–	INT16U	1	Security type of the command
0x1F43– 0x1F44	8004–8005	–	OCTET STRING	0	Password of the command: Administrator or Operator user profile password

Get Events Command

To get events, set the command registers in the following way:

Address	Register	Unit	Type	Range	Bit	Description
0x1F3F	8000	–	INT16U	50560	–	Requested command code
0x1F40	8001	–	INT16U	27	–	Number of parameters of the command
0x1F41	8002	–	INT16U	5377 (0x1501)	–	Destination of the command
0x1F42	8003	–	INT16U	0	–	Security type of the command
0x1F43– 0x1F44	8004–8005	–	OCTET STRING	0	–	Password of the command = 0 (no password required)
0x1F45	8006	–	INT16U	–	–	Requested event log book
					0	Trip
					1	Protection
					2	Diagnostic
					3	Metering
					4	Configuration
					5	Operation
					6	Communication
7–15	Reserved					
0x1F46	8007	–	INT16U	0–2	–	Requested get event method , page 191: <ul style="list-style-type: none"> • 0 = Most recent events • 1 = Events before and up to a date • 2 = Events before and up to a sequence number
0x1F47– 0x1F4A	8008–8011	–	DATETIME	–	–	Requested event date time (for method 1 only)
0x1F4B– 0x1F4C	8012–8013	–	INT32U	–	–	Requested event sequence number (for method 2 only)
0x1F4D	8014	–	INT16U	–	–	Requested event severity
					0–7	Reserved
					8	Low
					9	Medium
					10	High
11–15	Reserved					

Events are returned to command registers in the following way:

Address	Register	Unit	Type	Range	Bit	Description
0x1F53	8020	–	INT16U	50560	–	Last command code
0x1F54	8021	–	INT16U	–	–	Command status: <ul style="list-style-type: none"> • 0 = Successful command • Other value = command with error, page 58

Address	Register	Unit	Type	Range	Bit	Description
0x1F55	8022	–	INT16U	–	–	Number of bytes returned
0x1F56	8023	–	INT16U	–	–	Responded event log book
					0	Trip
					1	Protection
					2	Diagnostic
					3	Metering
					4	Configuration
					5	Operation
					6	Communication
7–15	Reserved					
0x1F57	8024	–	INT16U	0-2	–	Responded get event method: <ul style="list-style-type: none"> • 0 = Most recent events • 1 = Events before and up to a date • 2 = Events before and up to a sequence number
0x1F5E	8031	–	INT16U	–	–	Responded event severity
					0–7	Reserved
					8	Low
					9	Medium
					10	High
11–15	Reserved					
0x1F5F	8032	–	INT16U	0–10	–	MSB: Number of events returned
				0–1	–	LSB: Remaining events <ul style="list-style-type: none"> • 0 = No more events to get • 1 = More events to get
0x1F60	8033	–	INT16U	1013-25630	–	First event code , page 287.
0x1F61– 0x1F64	8034–8037	–	DATETIME	–	–	Timestamp of the first event
0x1F65	8038	–	INT16U	–	–	Timestamp quality of the first event
0x1F66– 0x1F67	8039–8040	–	INT32U	–	–	First event sequence number
0x1F68	8041	–	INT16U	–	–	MSB: First event status <ul style="list-style-type: none"> • 1 = Occurrence • 2 = Completion • 3 = Pulse LSB: Reserved
0x1F69	8042	–	INT16U	1–255	–	First event log book
					0	Trip
					1	Protection
					2	Diagnostic
					3	Metering
					4	Configuration
					5	Operation
					6	Communication
7–15	Reserved					
0x1F6A	8043	–	INT16U	–	–	First event severity
					0–7	Reserved

Address	Register	Unit	Type	Range	Bit	Description
					8	Low
					9	Medium
					10	High
					11–15	Reserved
0x1F6B– 0x1F75	8044–8054	–	INT16U	–	–	Characteristics of event 2 (same as event 1)
0x1F76– 0x1F80	8055–8065	–	INT16U	–	–	Characteristics of event 3 (same as event 1)
0x1F81– 0x1F8B	8066–8076	–	INT16U	–	–	Characteristics of event 4 (same as event 1)
0x1F8C– 0x1F96	8077–8087	–	INT16U	–	–	Characteristics of event 5 (same as event 1)
0x1F97– 0x1FA1	8088–8098	–	INT16U	–	–	Characteristics of event 6 (same as event 1)
0x1FA2– 0x1FAC	8099–8109	–	INT16U	–	–	Characteristics of event 7 (same as event 1)
0x1FAD– 0x1FB7	8110–8120	–	INT16U	–	–	Characteristics of event 8 (same as event 1)
0x1FB8– 0x1FC2	8121–8131	–	INT16U	–	–	Characteristics of event 9 (same as event 1)
0x1FC3– 0x1FCD	8132–8142	–	INT16U	–	–	Characteristics of event 10 (same as event 1)

Get Events Procedure

The command allows to get events by using one of the three following methods:

- get the most recent events
- get events logged before and up to a date
- get events before and up to an event sequence number. The event sequence number is an event identifier defined by the device, and is available among the event characteristics. It can be used to sort the events in chronological order.

NOTE: You can detect the occurrence of a new event by reading the last event sequence number available in registers 655–656 , page 119.

The command allows to get 10 events maximum, logged in one or several event log books, for one or several severity levels.

- To get the 10 most recent events, use the method “get the most recent events”.
- If there are more than 10 events, use any of the other two methods (get events logged before and up to a date or get events before and up to an event sequence number) to get rest of the events.

Example 1: Read the new events in all log books

The following diagram shows the steps to follow to read the new events in all log books:

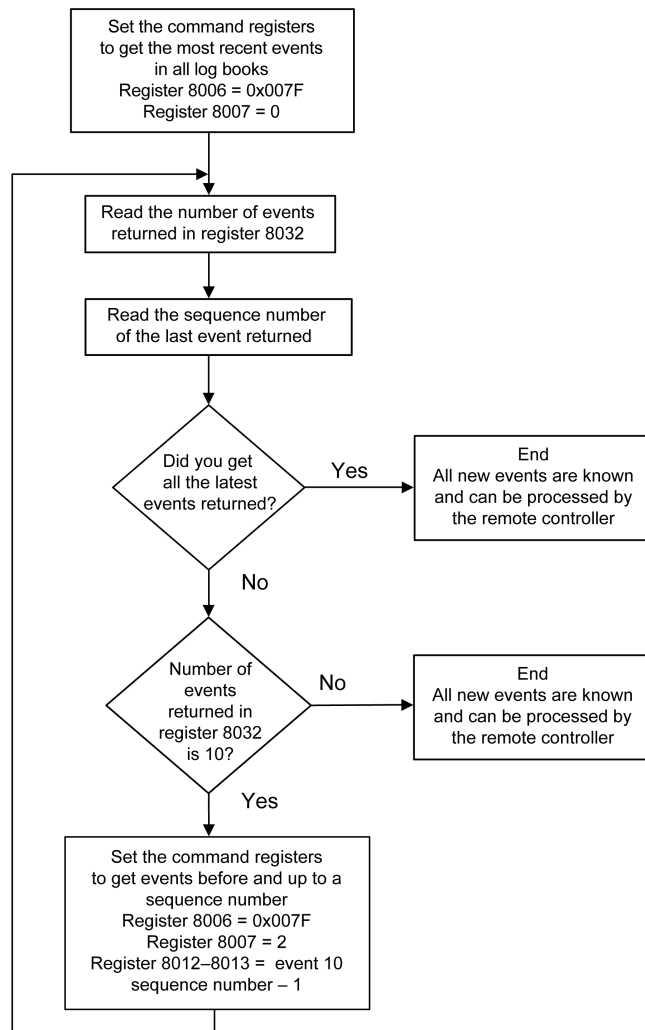

Example 2: Read all events in the protection log book

The following diagram shows the steps to follow to read all events in the protection log book:

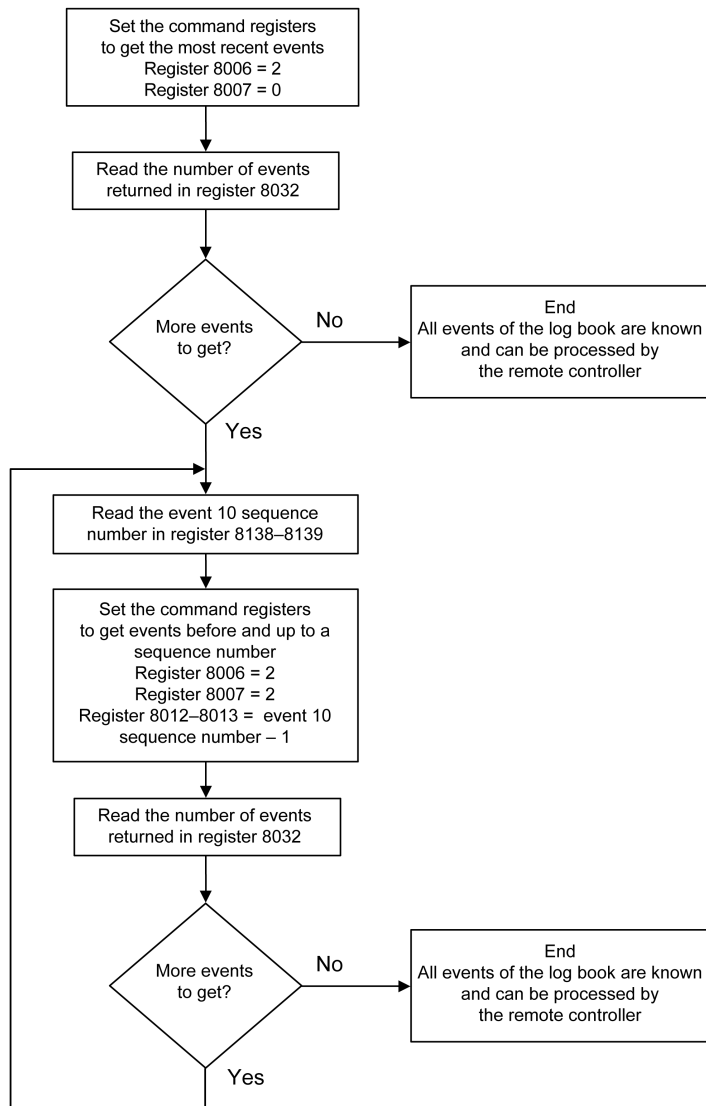

Get List of Digital Modules

To get the list of Digital Modules of the MicroLogic X control unit, set the command registers in the following way:

Address	Register	Unit	Type	Range	Description
0x1F3F	8000	–	INT16U	50816	Requested command code
0x1F40	8001	–	INT16U	12	Number of parameters of the command
0x1F41	8002	–	INT16U	5377 (0x1501)	Destination of the command
0x1F42	8003	–	INT16U	0	Security type of the command
0x1F43– 0x1F44	8004–8005	–	OCTET STRING	0	Password of the command = 0 (no password required)
0x1F45– 0x1F46	8006	–	INT16U	0	All Digital Modules

The list of Digital Modules of the MicroLogic X control unit is returned to command registers in the following way:

Address	Register	Unit	Type	Range	Description
0x1F53	8020	–	INT16U	50816	Last command code
0x1F54	8021	–	INT16U	–	Command status:

Address	Register	Unit	Type	Range	Description
					<ul style="list-style-type: none"> • 0 = Successful command • Other value = command with error, page 58
0x1F55	8022	–	INT16U	–	Number of bytes returned
0x1F56	8023	–	INT16U	0	All Digital Modules
0x1F57	8024	–	INT16U	0–14	Number of Digital Modules returned
0x1F58	8025	–	INT16U	1–13 15 22	First Digital Module firmware identifier entry: <ul style="list-style-type: none"> • 1 = WFC trip oriented • 2 = Energy per phase • 3 = Harmonic ranks • 4 = Assistance to power restoration • 5 = Assistance to recloser • 6 = ANSI 27/59 voltage based protection • 7 = ANSI 32P reverse power protection • 8 = ANSI 51N/51G Ground-fault/Earth-leakage alarm • 9 = ERMS protection • 10 = Legacy dataset • 11 = ANSI 81 frequency based protection • 12 = ANSI 67 – Directional overcurrent protection • 13 = IEC 61850 for MasterPact MTZ • 15 = ANSI 51 – IDMTL overcurrent protection • 22 = ANSI 51G – IDMT ground fault protection
0x1F59	8026	–	INT16U	1–13 15	Second Digital Module firmware identifier entry
0x1F5A	8027	–	INT16U	1–13 15	Third Digital Module firmware identifier entry
0x1F5B	8028	–	INT16U	1–13 15	Fourth Digital Module firmware identifier entry
0x1F5C	8029	–	INT16U	1–13 15	Fifth Digital Module firmware identifier entry
0x1F5D	8030	–	INT16U	1–13 15	Sixth Digital Module firmware identifier entry
0x1F5E	8031	–	INT16U	1–13 15	Seventh Digital Module firmware identifier entry
0x1F5F	8032	–	INT16U	1–13 15	Eighth Digital Module firmware identifier entry
0x1F60	8033	–	INT16U	1–13 15	Ninth Digital Module firmware identifier entry
0x1F61	8034	–	INT16U	1–13 15	Tenth Digital Module firmware identifier entry
0x1F62	8035	–	INT16U	1–13 15	Eleventh Digital Module firmware identifier entry
0x1F63	8036	–	INT16U	1–13 15	Twelfth Digital Module firmware identifier entry
0x1F64	8037	–	INT16U	1–13 15	Thirteenth Digital Module firmware identifier entry
0x1F65	8038	–	INT16U	1–13 15	Fourteenth Digital Module firmware identifier entry

Get Digital Module Details

To get the details of one Digital Module of the MicroLogic X control unit, set the command registers in the following way:

Address	Register	Unit	Type	Range	Description
0x1F3F	8000	–	INT16U	50817	Requested command code
0x1F40	8001	–	INT16U	12	Number of parameters of the command
0x1F41	8002	–	INT16U	5377 (0x1501)	Destination of the command
0x1F42	8003	–	INT16U	0	Security type of the command
0x1F43– 0x1F44	8004–8005	–	OCTET STRING	0	Password of the command = 0 (no password required)
0x1F45– 0x1F46	8006	–	INT16U	1–13 15 22	Requested Digital Module entry: <ul style="list-style-type: none"> • 1 = WFC trip oriented • 2 = Energy per phase • 3 = Harmonic ranks • 4 = Assistance to power restoration • 5 = Assistance to recloser • 6 = ANSI 27/59 voltage based protection • 7 = ANSI 32P reverse power protection • 8 = ANSI 51N/51G Ground-fault/Earth-leakage alarm • 9 = ERMS protection • 10 = Legacy dataset • 11 = ANSI 81 frequency based protection • 12 = ANSI 67 – Directional overcurrent protection • 13 = IEC 61850 for MasterPact MTZ • 15 = ANSI 51 – IDMTL overcurrent protection • 22 = ANSI 51G – IDMT ground fault protection

The Digital Module details of the MicroLogic X control unit is returned to command registers in the following way:

Address	Register	Unit	Type	Range	Description
0x1F53	8020	–	INT16U	50817	Last command code
0x1F54	8021	–	INT16U	–	Command status: <ul style="list-style-type: none"> • 0 = Successful command • Other value = command with error, page 58
0x1F55	8022	–	INT16U	124	Number of bytes returned
0x1F56	8023	–	INT16U	1–13 15 22	Responded Digital Module entry: <ul style="list-style-type: none"> • 1 = WFC trip oriented • 2 = Energy per phase • 3 = Harmonic ranks • 4 = Assistance to power restoration • 5 = Assistance to recloser • 6 = ANSI 27/59 voltage based protection • 7 = ANSI 32P reverse power protection • 8 = ANSI 51N/51G Ground-fault/Earth-leakage alarm • 9 = ERMS protection • 10 = Legacy dataset • 11 = ANSI 81 frequency based protection • 12 = ANSI 67 – Directional overcurrent protection • 13 = IEC 61850 for MasterPact MTZ • 15 = ANSI 51 – IDMTL overcurrent protection • ANSI 51G – IDMT ground fault protection

Address	Register	Unit	Type	Range	Description
0x1F57– 0x1F5E	8024–8031	–	OCTET STRING	–	Digital Module product code (commercial reference)
0x1F5F– 0x1F86	8032–8071	–	OCTET STRING	–	Digital Module model name
0x1F87– 0x1F8C	8072–8077	–	OCTET STRING	–	Digital Module firmware revision
0x1F8D	8078	–	–	–	Reserved
0x1F8E	8079	–	INT16U	–	MSB: Digital Module license type <ul style="list-style-type: none"> • 0 = No license installed • 1 = Temporary license installed • 2 = Permanent license installed
					LSB: Digital Module activation <ul style="list-style-type: none"> • 0 = Off • 1 = On
0x1F8F	8080	Days	INT16U	0–65534	Digital Module license remaining days (only for temporary license installed)
0x1F90– 0x1F93	8081–8084	–	–	–	Reserved

MicroLogic Control Unit Protection Commands with Session

What's in This Chapter

Description of Commands with Session	197
List of MicroLogic Control Unit Protection Commands with Session and Error Codes	199
Session Management Commands	200
Protection Submit Commands	202
Protection Get Commands with Session	207

Description of Commands with Session

Presentation

The procedure for setting a protection setting conforms to UL489SE standard. It is safeguarded by an exclusive editing session and by a two-step procedure for submitting and applying setting changes.

The exclusive editing session means that only one interface at a time can access and set protection settings. Access from other interfaces is blocked when an editing session is open.

During the editing session there is no impact on the active protection provided by the MicroLogic X control unit until the new settings are applied. If the new settings are canceled, or the editing session times out before the new settings are applied, the active settings are maintained.

Enabling and Disabling Access to Protection Settings

You can enable or disable access to the protection settings by using the MicroLogic X display screen at **Home > Configuration > General > Lock protection**.

From the **Lock protection** screen of the MicroLogic X control unit, you can allow changes to the protection settings from the following interfaces:

- **Keypad:** MicroLogic X display screen keypad itself
- **External access:** EcoStruxure Power Commission software, EcoStruxure Power Device app, and communication network

For each interface:

- Set as **Allowed** (factory setting) to enable changes to be made.
- Set as **Not Allowed** to disable changes.

Editing Session for Selecting and Changing Protection Settings

An editing session has the following characteristics:

- Only one editing session at a time can be open. Access to protection settings from other interfaces is blocked when you open an editing session.
- There is a five-minute timeout for submitting and for applying new settings. The session times out as follows:
 - Five minutes after the session opens, if you do not submit the new settings
 - Five minutes after submitting the new settings, if you do not apply the new settings
- After applying new settings, get the apply setting status to check that the new protection settings are applied. Once apply is completed, close the session.
- When setting protection using the communication network, several protection functions of the same setting group can be set in one editing session, with a submit step after changing each function and one apply step to apply all the new settings. Active settings are maintained until the apply step is executed.
- The earth-leakage protection and the neutral protection can be set with the other protections of setting group A or setting group B.

- The protection settings activated when the ERMS function is engaged cannot be set by using the communication network.

The ERMS settings can be set only as follows:

- with EcoStruxure Power Commission software through a USB connection (password-protected)
- with the EcoStruxure Power Device app (password-protected)

Two-Step Procedure for Submitting and Applying Protection Settings

The procedure for changing protection settings requires you to submit and apply the new settings in two consecutive steps:

Step	Action	
1	Submit new settings	Select new settings required and submit. The new settings are displayed so that you can check that the settings are correct before they are applied. Read the new settings to confirm that they are correct.
2	Apply new settings	Apply the new settings. The existing active protection settings are replaced by the new settings.

Protection Setting Procedure with Session

To set protection settings by using the communication network, external access to protection settings must be allowed by using the MicroLogic X display screen , page 197.

The following example shows how to set the long-time overcurrent protection setting group A:

Step	Action
1	Open the editing session with the open setup session command , page 200. Result: The session key for the editing session is returned to the command registers. The returned session key must be used in all commands during the session.
2	Submit the new protection settings with the submit long time over current protection settings command , page 202. The requested session key for the command must be the session key returned by the open setup session command.
3	Use the Get long time over current protection settings command , page 207 to read the submitted settings. The requested session key for the command must be the session key returned by the open setup session command.
4	Check that the protection settings submitted at step 2 and the protection settings got at step 3 are identical: <ul style="list-style-type: none"> • If the settings are identical, go to step 5 • If the settings are not identical, go to step 7 and start the setting procedure again
5	Apply submitted protection settings with the apply settings command , page 200. The requested session key for the command must be the session key returned by the open setup session command.
6	Use the Get apply setting status , page 201 to check that the new protection settings are applied. The requested session key for the command must be the session key returned by the open setup session command. NOTE: If the settings of other protection functions must be changed or if the settings of protection functions of another setting group must be changed, restart the setting procedure at step 2 for each protection functions
7	Close the editing session with the close setup session command , page 201. The requested session key for the command must be the session key returned by the open setup session command.

List of MicroLogic Control Unit Protection Commands with Session and Error Codes

List of Commands

The MicroLogic control unit protection commands with session are performed by the command interface, page 56. They are grouped by their functions and types:

- Session management commands , page 200
- Protection submit commands , page 202
- Protection get commands with session , page 207

In the MicroLogic control unit registers:

- RC indicates the registers that can be read by a get command
- WC indicates the registers that can be written by a set and reset command

Error Codes

Error codes generated by MicroLogic control units are the generic error codes , page 59.

Session Management Commands

List of Commands

The following table lists the commands necessary to manage the editing session of the setting protection function in accordance with UL489SE standard, their corresponding command codes and user profiles.

Command	Command Code	User profile
Open setup session , page 200	1930	Administrator
Apply settings , page 200	1932	Administrator
Get apply setting status , page 201	1924	No password required
Close setup session , page 201	1933	Administrator

Open Setup Session

To open setup session, set the command registers in the following way:

Address	Register	Unit	Type	Range	Description
0x1F3F	8000	–	INT16U	1930	Requested command code
0x1F40	8001	–	INT16U	10	Number of parameters of the command
0x1F41	8002	–	INT16U	5377 (0x1501)	Destination of the command
0x1F42	8003	–	INT16U	1	Security type of the command
0x1F43– 0x1F44	8004–8005	–	OCTET STRING	–	Password of the command: Administrator user profile password

The session key for the editing session is returned to the command registers in the following way:

Address	Register	Unit	Type	Range	Description
0x1F3F	8020	–	INT16U	1930	Last command code
0x1F40	8021	–	INT16U	–	Command status: <ul style="list-style-type: none"> • 0 = Successful command • Other value = Command with error, page 58
0x1F41	8022	–	INT16U	4	Number of bytes returned
0x1F42– 0x1F43	8023–8024	–	INT32U	0– 4294967294	Session key for the command

Apply Settings

To apply settings, set the command registers in the following way:

Address	Register	Unit	Type	Range	Description
0x1F3F	8000	–	INT16U	1932	Requested command code
0x1F40	8001	–	INT16U	14	Number of parameters of the command
0x1F41	8002	–	INT16U	5377 (0x1501)	Destination of the command
0x1F42	8003	–	INT16U	1	Security type of the command

Address	Register	Unit	Type	Range	Description
0x1F43– 0x1F44	8004–8005	–	OCTET STRING	–	Password of the command: Administrator user profile password
0x1F45– 0x1F46	8006–8007	–	INT32U	0– 4294967294	Requested session key for the command

Get Apply Setting Status

To get apply setting status, set the command registers in the following way:

Address	Register	Unit	Type	Range	Description
0x1F3F	8000	–	INT16U	1924	Requested command code
0x1F40	8001	–	INT16U	14	Number of parameters of the command
0x1F41	8002	–	INT16U	5377 (0x1501)	Destination of the command
0x1F42	8003	–	INT16U	0	Security type of the command
0x1F43– 0x1F44	8004–8005	–	OCTET STRING	0	Password of the command = 0 (no password required)
0x1F45– 0x1F46	8006–8007	–	INT32U	0– 4294967294	Requested session key for the command

The apply setting status is returned to the command registers in the following way:

Address	Register	Unit	Type	Range	Description
0x1F53	8020	–	INT16U	1924	Last command code
0x1F54	8021	–	INT16U	–	Command status: <ul style="list-style-type: none"> • 0 = Successful command • Other value = Command with error, page 58
0x1F55	8022	–	INT16U	6	Number of bytes returned
0x1F56– 0x1F57	80023–8024	–	INT32U	0– 4294967294	Responded session key for the command. It must be equal to the requested session key for the command.
0x1F58	8025	–	INT16U	0–1	Status of the apply settings command: <ul style="list-style-type: none"> • 0 = No apply settings in progress • 1 = Apply settings in progress

Close Setup Session

To close setup session, set the command registers in the following way:

Address	Register	Unit	Type	Range	Description
0x1F3F	8000	–	INT16U	1933	Requested command code
0x1F40	8001	–	INT16U	14	Number of parameters of the command
0x1F41	8002	–	INT16U	5377 (0x1501)	Destination of the command
0x1F42	8003	–	INT16U	1	Security type of the command
0x1F43– 0x1F44	8004–8005	–	OCTET STRING	–	Password of the command: Administrator user profile password
0x1F45– 0x1F46	8006–8007	–	INT32U	0– 4294967294	Requested session key for the command

Protection Submit Commands

List of Commands

The following table lists the protection submit commands, their corresponding command codes, and user profiles:

Command	Command code	User profile
Submit long time over current protection settings , page 202	51593	Administrator
Submit short time over current protection settings , page 203	51594	Administrator
Submit instantaneous protection settings , page 203	51595	Administrator
Submit ground fault protection settings , page 204	51596	Administrator
Submit earth leakage protection settings , page 205	51597	Administrator
Submit neutral protection settings , page 206	51598	Administrator

Submit Long Time Over Current Protection Settings

To get the long time over current protection settings, use the get long time over current protection setting command , page 207.

⚠ WARNING
<p>HAZARD OF NUISANCE TRIPPING OR FAILURE TO TRIP</p> <p>Protection setting adjustments must be done only by qualified electrical personnel.</p> <p>Failure to follow these instructions can result in death, serious injury, or equipment damage.</p>

To submit the long time over current protection settings, set the command registers in the following way:

Address	Register	Unit	Type	Range	Description
0x1F3F	8000	–	INT16U	51593	Requested command code
0x1F40	8001	–	INT16U	26	Number of parameters of the command
0x1F41	8002	–	INT16U	5377 (0x1501)	Destination of the command
0x1F42	8003	–	INT16U	1	Security type of the command
0x1F43– 0x1F44	8004-8005	–	OCTET STRING	–	Password of the command: Administrator user profile password
0x1F45– 0x1F46	8006-8007	–	INT32U	0– 4294967294	Requested session key for the command
0x1F47	8008	–	INT16U	–	MSB: 0 LSB: Requested setting group <ul style="list-style-type: none"> • 1 = Setting group A • 2 = Setting group B
0x1F48	8009	–	–	0xFFFF	Reserved
0x1F49– 0x1F4A	8010–8011	A	FLOAT32	–	Long time over current protection threshold setting group A or B (step 0.1 A)
0x1F4B– 0x1F4C	8012–8013	s	FLOAT32	0.5-24.0 (step 0.5)	Long time over current protection time delay setting group A or B

Submit Short Time Over Current Protection Settings

To get the short time over current protection settings, use the get short time over current protection settings command , page 208.

⚠ WARNING

HAZARD OF NUISANCE TRIPPING OR FAILURE TO TRIP

Protection setting adjustments must be done only by qualified electrical personnel.

Failure to follow these instructions can result in death, serious injury, or equipment damage.

To submit the short time over current protection settings, set the command registers in the following way:

Address	Register	Unit	Type	Range	Description
0x1F3F	8000	–	INT16U	51594	Requested command code
0x1F40	8001	–	INT16U	26	Number of parameters of the command
0x1F41	8002	–	INT16U	5377 (0x1501)	Destination of the command
0x1F42	8003	–	INT16U	1	Security type of the command
0x1F43- 0x1F44	8004-8005	–	OCTET STRING	–	Password of the command: Administrator user profile password
0x1F45- 0x1F46	8006-8007	–	INT32U	0– 4294967294	Requested session key for the command
0x1F47	8008	–	INT16U	–	MSB: 0 LSB: Requested setting group <ul style="list-style-type: none"> • 1 = Setting group A • 2 = Setting group B
0x1F48	8009	–	INT16U	–	MSB: 0 LSB: Short time over current protection curve setting group A or B <ul style="list-style-type: none"> • 0 = Definite time ($I^2t = \text{Off}$) • 1 = Inverse time ($I^2t = \text{On}$)
0x1F49– 0x1F4A	8010–8011	–	FLOAT32	1.5–10.0 (step 0.1)	Short time over current protection threshold coefficient setting group A or B
0x1F4B– 0x1F4C	8012–8013	s	FLOAT32	0–0.4 (step0.1)	Short time over current protection time delay setting group A or B

Submit Instantaneous Protection Settings

To get the instantaneous protection, use the get instantaneous protection settings command , page 210.

⚠ WARNING

HAZARD OF NUISANCE TRIPPING OR FAILURE TO TRIP

Protection setting adjustments must be done only by qualified electrical personnel.

Failure to follow these instructions can result in death, serious injury, or equipment damage.

To submit the instantaneous protection settings, set the command registers in the following way:

Address	Register	Unit	Type	Range	Description
0x1F3F	8000	–	INT16U	51595	Requested command code
0x1F40	8001	–	INT16U	22	Number of parameters of the command
0x1F41	8002	–	INT16U	5377 (0x1501)	Destination of the command
0x1F42	8003	–	INT16U	1	Security type of the command
0x1F43- 0x1F44	8004-8005	–	OCTET STRING	–	Password of the command: Administrator user profile password
0x1F45- 0x1F46	8006-8007	–	INT32U	0– 4294967294	Requested session key for the command
0x1F47	8008	–	INT16U	–	MSB: Instantaneous over current protection mode setting group A or B <ul style="list-style-type: none"> • 0 = Off • 1 = On LSB: Requested setting group <ul style="list-style-type: none"> • 1 = Setting group A • 2 = Setting group B
0x1F48– 0x1F49	8009–8010		FLOAT32	(1)	Instantaneous over current protection threshold coefficient setting group A or B
0x1F4A	8011		INT16U		MSB: 0 LSB: Instantaneous over current protection time delay mode setting group A or B <ul style="list-style-type: none"> • 0 = Standard • 1 = Fast
(1) li setting range: <ul style="list-style-type: none"> • for MicroLogic 5.0 X, 6.0 X and 7.0 X: 2.0 to 15.0 (step 0.1) • for MicroLogic 3.0 X: 2.0 to 12.0 (step 0.1) 					

Submit Ground Fault Protection Settings

To get the ground fault protection settings, use the get ground fault protection settings command , page 211.

⚠ WARNING
HAZARD OF NUISANCE TRIPPING OR FAILURE TO TRIP
Protection setting adjustments must be done only by qualified electrical personnel.
Failure to follow these instructions can result in death, serious injury, or equipment damage.

To submit the ground fault protection settings, set the command registers in the following way:

Address	Register	Unit	Type	Range	Description
0x1F3F	8000	–	INT16U	51596	Requested command code
0x1F40	8001	–	INT16U	26	Number of parameters of the command
0x1F41	8002	–	INT16U	5377 (0x1501)	Destination of the command
0x1F42	8003	–	INT16U	1	Security type of the command

Address	Register	Unit	Type	Range	Description
0x1F43-0x1F44	8004–8005	–	OCTET STRING	–	Password of the command: Administrator user profile password
0x1F45-0x1F46	8006–8007	–	INT32U	0–4294967294	Requested session key for the command
0x1F47	8008	–	INT16U	–	MSB: Ground fault protection mode ⁽¹⁾ <ul style="list-style-type: none"> • 0 = Off (protection disabled) • 1 = On (protection enabled) LSB: Requested setting group <ul style="list-style-type: none"> • 1 = Setting group A • 2 = Setting group B
0x1F48	8009	–	INT16U	–	MSB: 0 LSB: Short time over current protection curve setting group A or B <ul style="list-style-type: none"> • 0 = Definite time (I²t = Off) • 1 = Inverse time (I²t = On)
0x1F49–0x1F4A	8010–8011	A	FLOAT32	–	Ground fault protection threshold setting group A or B (step 10 A)
0x1F4B–0x1F4C	8012–8013	s	FLOAT32	0–0.4 (step 0.1)	Ground fault protection time delay setting group A or B

(1) On MicroLogic 6.0 X for UL standard, the ground fault protection mode is always On. In case of setting the ground fault protection mode to Off, the result of the command will be 0x10, Input argument is out of range.

Submit Earth Leakage Protection Settings

To get the earth leakage protection settings, use the get earth leakage protection settings command , page 212.

⚠ WARNING
HAZARD OF NUISANCE TRIPPING OR FAILURE TO TRIP
Protection setting adjustments must be done only by qualified electrical personnel.
Failure to follow these instructions can result in death, serious injury, or equipment damage.

To submit the earth leakage protection settings, set the command registers in the following way:

Address	Register	Unit	Type	Range	Description
0x1F3F	8000	–	INT16U	51597	Requested command code
0x1F40	8001	–	INT16U	24	Number of parameters of the command
0x1F41	8002	–	INT16U	5377 (0x1501)	Destination of the command
0x1F42	8003	–	INT16U	1	Security type of the command
0x1F43-0x1F44	8004–8005	–	OCTET STRING	–	Password of the command: Administrator user profile password
0x1F45-0x1F46	8006–8007	–	INT32U	0–4294967294	Requested session key for the command
0x1F47	8008	–	–	0xFFFF	Reserved
0x1F48–0x1F49	8009–8010	A	FLOAT32	0.5–30.0 (step 0.1)	Earth leakage protection threshold
0x1F4A–0x1F4B	8011–8012	s	FLOAT32	0.06, 0.15, 0.23, 0.35, 0.80	Earth leakage protection time delay

Submit Neutral Protection Settings

To get the neutral protection settings, use the get neutral protection settings command , page 213.

▲ WARNING

HAZARD OF NUISANCE TRIPPING OR FAILURE TO TRIP

Protection setting adjustments must be done only by qualified electrical personnel.

Failure to follow these instructions can result in death, serious injury, or equipment damage.

To submit the neutral protection settings, set the command registers in the following way:

Address	Register	Unit	Type	Range	Description
0x1F3F	8000	–	INT16U	51598	Requested command code
0x1F40	8001	–	INT16U	16	Number of parameters of the command
0x1F41	8002	–	INT16U	5377 (0x1501)	Destination of the command
0x1F42	8003	–	INT16U	1	Security type of the command
0x1F43- 0x1F44	8004–8005	–	OCTET STRING	–	Password of the command: Administrator user profile password
0x1F45- 0x1F46	8006–8007	–	INT32U	0– 4294967294	Requested session key for the command
0x1F47	8008	–	INT16U	0-3	Neutral protection type: <ul style="list-style-type: none"> • 0 = Off • 1 = 0.5 • 2 = 1.0 • 3 = Oversized

Protection Get Commands with Session

List of Commands

The following table lists the protection get commands with session, their corresponding command codes, and user profiles:

Command	Command code	User profile
Get long time over current protection settings , page 207	51584	No password required
Get short time over current protection settings , page 208	51585	No password required
Get instantaneous protection settings , page 210	51586	No password required
Get ground fault protection settings , page 211	51587	No password required
Get earth leakage protection settings , page 212	51588	No password required
Get neutral protection settings , page 213	51589	No password required

Get Long Time Over Current Protection Settings

To get the long time over current protection settings, set the command registers in the following way:

Address	Register	Unit	Type	Range	Description
0x1F3F	8000	–	INT16U	51584	Requested command code
0x1F40	8001	–	INT16U	16	Number of parameters of the command
0x1F41	8002	–	INT16U	5377 (0x1501)	Destination of the command
0x1F42	8003	–	INT16U	0	Security type of the command
0x1F43- 0x1F44	8004–8005	–	OCTET STRING	0	Password of the command = 0 (no password required)
0x1F45- 0x1F46	8006–8007	–	INT32U	0– 4294967294	Key for the protection get command with session
0x1F47	8008	–	INT16U	–	MSB: 0 LSB: Requested setting group <ul style="list-style-type: none"> • 0 = Current setting group • 1 = Setting group A • 2 = Setting group B • 3 = Setting group ERMS

The long time over current protection settings are returned to command registers in the following way:

Address	Register	Unit	Type	Range	Description
0x1F53	8020	–	INT16U	51584	Last command code
0x1F54	8021	–	INT16U	–	Command status: <ul style="list-style-type: none"> • 0 = Successful command • Other value = command with error, page 58
0x1F55	8022	–	INT16U	56	Number of bytes returned
0x1F56-0x1F57	8023–8024	–	INT32U	0– 4294967294	Key for the protection get command with session
0x1F58	8025	–	INT16U	–	MSB: Requested setting group <ul style="list-style-type: none"> • 0 = Current setting group • 1 = Setting group A

Address	Register	Unit	Type	Range	Description
					<ul style="list-style-type: none"> • 2 = Setting group B • 3 = Setting group ERMS LSB: Responded setting group <ul style="list-style-type: none"> • 1 = Setting group A • 2 = Setting group B • 3 = Setting group ERMS • 128 = Fallback setting
0x1F59	8026	–	INT16U	–	MSB: Long time over current protection mode <ul style="list-style-type: none"> • 0 = Off • 1 = On (tripping) LSB: Long time over current protection supported <ul style="list-style-type: none"> • 0 = Not supported • 1 = Supported
0x1F5A-0x1F5D	8027–8030	–	DATE TIME	–	Timestamp of last change of long time over current protection mode
0x1F5E	8031	–	INT16U	–	Timestamp quality of last change of long time over current protection mode
0x1F5F-0x1F62	8032–8035	–	DATE TIME	–	Timestamp of last change of any parameter of the long time over current protection function
0x1F63	8036	–	INT16U	–	Timestamp quality of last change of any parameter of the long time over current protection function
0x1F64-0x1F65	8037–8038	–	FLOAT32	–	Long time over current protection threshold coefficient high limit
0x1F66-0x1F67	8039–8040	s	FLOAT32	–	Long time over current protection time delay high limit
0x1F68	8041	–	INT16U	1	MSB: 0 LSB: Long time over current protection curve <ul style="list-style-type: none"> • 1 = Inverse time ($I^2t = ON$)
0x1F69-0x1F6A	8042–8043	A	FLOAT32	–	Long time over current protection threshold
0x1F6B-0x1F6C	8044–8045	s	FLOAT32	–	Long time over current protection time delay
0x1F6D-0x1F71	8046–8050	–	–	–	Reserved

Get Short Time Over Current Protection Settings

To get the short time over current protection settings, set the command registers in the following way:

Address	Register	Unit	Type	Range	Description
0x1F3F	8000	–	INT16U	51585	Requested command code
0x1F40	8001	–	INT16U	16	Number of parameters of the command
0x1F41	8002	–	INT16U	5377 (0x1501)	Destination of the command
0x1F42	8003	–	INT16U	0	Security type of the command
0x1F43-0x1F44	8004–8005	–	OCTET STRING	0	Password of the command = 0 (no password required)

Address	Register	Unit	Type	Range	Description
0x1F45-0x1F46	8006–8007	–	INT32U	0–4294967294	Key for the protection get command with session
0x1F47	8008	–	INT16U	–	MSB: 0 LSB: Requested setting group <ul style="list-style-type: none"> • 0 = Current setting group • 1 = Setting group A • 2 = Setting group B • 3 = Setting group ERMS

The short time over current protection settings are returned to command registers in the following way:

Address	Register	Unit	Type	Range	Description
0x1F53	8020	–	INT16U	51585	Last command code
0x1F54	8021	–	INT16U	–	Command status: <ul style="list-style-type: none"> • 0 = Successful command • Other value = command with error, page 58
0x1F55	8022	–	INT16U	56	Number of bytes returned
0x1F56-0x1F57	8023–8024	–	INT32U	0–4294967-294	Key for the protection get command with session
0x1F58	8025	–	INT16U	–	MSB: Requested setting group <ul style="list-style-type: none"> • 0 = Current setting group • 1 = Setting group A • 2 = Setting group B • 3 = Setting group ERMS LSB: Responded setting group <ul style="list-style-type: none"> • 1 = Setting group A • 2 = Setting group B • 3 = Setting group ERMS • 128 = Fallback setting
0x1F59	8026	–	INT16U	–	MSB: Short time over current protection mode <ul style="list-style-type: none"> • 0 = Off • 1 = On (tripping) LSB: Short time over current protection supported <ul style="list-style-type: none"> • 0 = Not supported • 1 = Supported
0x1F5A-0x1F5D	8027–8030	–	DATETIME	–	Timestamp of last change of short time over current protection mode
0x1F5E	8031	–	INT16U	–	Timestamp quality of last change of short time over current protection mode
0x1F5F-0x1F62	8032–8035	–	DATETIME	–	Timestamp of last change of any parameter of the short time over current protection function
0x1F63	8036	–	INT16U	–	Timestamp quality of last change of any parameter of the short time over current protection function.
0x1F64-0x1F65	8037–8038	–	FLOAT32	–	Short time over current protection threshold coefficient high limit
0x1F66-0x1F67	8039–8040	s	FLOAT32	–	Short time over current protection time delay high limit
0x1F68	8041	–	INT16U	–	MSB: 0 LSB: Short time over current protection curve <ul style="list-style-type: none"> • 0 = Definite time (I²t = OFF) • 1 = Inverse time (I²t = ON)
0x1F69-0x1F6A	8042–8043	–	FLOAT32	–	Short time over current protection threshold coefficient

Address	Register	Unit	Type	Range	Description
0x1F6B-0x1F6C	8044–8045	s	FLOAT32	–	Short time over current protection time delay
0x1F6D-0x1F71	8046–8050	–	–	–	Reserved

Get Instantaneous Protection Settings

To get the instantaneous protection settings, set the command registers in the following way:

Address	Register	Unit	Type	Range	Description
0x1F3F	8000	–	INT16U	51586	Requested command code
0x1F40	8001	–	INT16U	16	Number of parameters of the command
0x1F41	8002	–	INT16U	5377 (0x1501)	Destination of the command
0x1F42	8003	–	INT16U	0	Security type of the command
0x1F43- 0x1F44	8004–8005	–	OCTET STRING	0	Password of the command = 0 (no password required)
0x1F45- 0x1F46	8006–8007	–	INT32U	0– 4294967294	Key for the protection get command with session
0x1F47	8008	–	INT16U	–	MSB: 0 LSB: Requested setting group <ul style="list-style-type: none"> • 0 = Current setting group • 1 = Setting group A • 2 = Setting group B • 3 = Setting group ERMS

The instantaneous protection settings are returned to command registers in the following way:

Address	Register	Unit	Type	Range	Description
0x1F53	8020	–	INT16U	51586	Last command code
0x1F54	8021	–	INT16U	–	Command status: <ul style="list-style-type: none"> • 0 = Successful command • Other value = command with error, page 58
0x1F55	8022	–	INT16U	44	Number of bytes returned
0x1F56-0x1F57	8023–8024	–	INT32U	0– 4294967294	Key for the protection get command with session
0x1F58	8025	–	INT16U	–	MSB: Requested setting group <ul style="list-style-type: none"> • 0 = Current setting group • 1 = Setting group A • 2 = Setting group B • 3 = Setting group ERMS LSB: Responded setting group <ul style="list-style-type: none"> • 1 = Setting group A • 2 = Setting group B • 3 = Setting group ERMS • 128 = Fallback setting
0x1F59	8026	–	INT16U	–	MSB: Instantaneous over current protection mode <ul style="list-style-type: none"> • 0 = Off • 1 = On (tripping) LSB: Instantaneous over current protection function supported <ul style="list-style-type: none"> • 0 = Not supported • 1 = Supported

Address	Register	Unit	Type	Range	Description
0x1F5A-0x1F5D	8027–8030	–	DATETIME	–	Timestamp of last change of instantaneous over current protection mode
0x1F5E	8031	–	INT16U	–	Timestamp quality of last change of instantaneous over current protection mode
0x1F5E-0x1F62	8032–8035	–	DATETIME	–	Timestamp of last change of any parameter of the instantaneous over current protection mode
0x1F63	8036	–	INT16U	–	Timestamp quality of last change of any parameter of the instantaneous over current protection function
0x1F64-0x1F65	8037–8038	–	FLOAT32	–	Instantaneous over current protection threshold coefficient high limit
0x1F66-0x1F67	8039–8040	–	FLOAT32	–	Instantaneous over current protection threshold coefficient
0x1F68	8041	–	INT16U	–	MSB: 0 LSB: Instantaneous over current protection time delay mode: <ul style="list-style-type: none"> • 0 = Standard • 1 = Fast
0x1F69-0x1F6B	8042–8044	–	–	–	Reserved

Get Ground Fault Protection Settings

To get the ground fault protection settings, set the command registers in the following way:

Address	Register	Unit	Type	Range	Description
0x1F3F	8000	–	INT16U	51587	Requested command code
0x1F40	8001	–	INT16U	16	Number of parameters of the command
0x1F41	8002	–	INT16U	5377 (0x1501)	Destination of the command
0x1F42	8003	–	INT16U	0	Security type of the command
0x1F43- 0x1F44	8004–8005	–	OCTET STRING	0	Password of the command = 0 (no password required)
0x1F45- 0x1F46	8006–8007	–	INT32U	0– 4294967294	Key for the protection get command with session
0x1F47	8008	–	INT16U	–	MSB: 0 LSB: Requested setting group <ul style="list-style-type: none"> • 0 = Current setting group • 1 = Setting group A • 2 = Setting group B • 3 = Setting group ERMS

The ground fault protection settings are returned to command registers in the following way:

Address	Register	Unit	Type	Range	Description
0x1F53	8020	–	INT16U	51587	Last command code
0x1F54	8021	–	INT16U	–	Command status: <ul style="list-style-type: none"> • 0 = Successful command • Other value = command with error, page 58
0x1F55	8022	–	INT16U	56	Number of bytes returned
0x1F56-0x1F57	8023–8024	–	INT32U	0– 4294967294	Key for the protection get command with session

Address	Register	Unit	Type	Range	Description
0x1F58	8025	–	INT16U	–	MSB: Requested setting group <ul style="list-style-type: none"> • 0 = Current setting group • 1 = Setting group A • 2 = Setting group B • 3 = Setting group ERMS LSB: Responded setting group <ul style="list-style-type: none"> • 1 = Setting group A • 2 = Setting group B • 3 = Setting group ERMS • 128 = Fallback setting
0x1F59	8026	–	INT16U	–	MSB: Ground fault protection mode <ul style="list-style-type: none"> • 0 = Off • 1 = On (tripping) LSB: Ground fault protection function supported <ul style="list-style-type: none"> • 0 = Not supported • 1 = Supported
0x1F5A-0x1F5D	8027–8030	–	DATETIME	–	Timestamp of last change of ground fault protection mode
0x1F5E	8031	–	INT16U	–	Timestamp quality of last change of ground fault protection mode
0x1F5F-0x1F62	8032–8035	–	DATETIME	–	Timestamp of last change of any parameter of the ground fault protection function
0x1F63	8036	–	INT16U	–	Timestamp quality of last change of any parameter of the ground fault protection function
0x1F64-0x1F65	8037–8038	–	FLOAT32	–	Ground fault protection threshold coefficient high limit
0x1F66-0x1F67	8039–8040	s	FLOAT32	–	Ground fault protection time delay high limit
0x1F68	8041	–	INT16U	–	MSB: 0 LSB: Ground fault protection curve <ul style="list-style-type: none"> • 0 = Definite time ($I^2t = OFF$) • 1 = Inverse time ($I^2t = ON$)
0x1F69-0x1F6A	8042–8043	A	FLOAT32	–	Ground fault protection threshold
0x1F6B-0x1F6C	8044–8045	s	FLOAT32	–	Ground fault protection time delay
0x1F6D-0x1F71	8046–8050	–	–	–	Reserved

Get Earth Leakage Protection Settings

To get the earth leakage protection settings, set the command registers in the following way:

Address	Register	Unit	Type	Range	Description
0x1F3F	8000	–	INT16U	51588	Requested command code
0x1F40	8001	–	INT16U	16	Number of parameters of the command
0x1F41	8002	–	INT16U	5377 (0x1501)	Destination of the command
0x1F42	8003	–	INT16U	0	Security type of the command
0x1F43-0x1F44	8004–8005	–	OCTET STRING	0	Password of the command = 0 (no password required)
0x1F45-0x1F46	8006–8007	–	INT32U	0–4294967294	Key for the protection get command with session
0x1F47	8008	–	–	0xFFFF	Reserved

The earth leakage protection settings are returned to command registers in the following way:

Address	Register	Unit	Type	Range	Description
0x1F53	8020	–	INT16U	51588	Last command code
0x1F54	8021	–	INT16U	–	Command status: <ul style="list-style-type: none"> • 0 = Successful command • Other value = command with error, page 58
0x1F55	8022	–	INT16U	52	Number of bytes returned
0x1F56-0x1F57	8023–8024	–	INT32U	0–4294967294	Key for the protection get command with session
0x1F58	8025	–	–	0xFFFF	Reserved
0x1F59	8026	–	INT16U	–	MSB: Earth leakage protection mode <ul style="list-style-type: none"> • 0 = Off • 1 = On LSB: Earth leakage function supported <ul style="list-style-type: none"> • 0 = Not supported • 1 = Supported
0x1F5A-0x1F5D	8027–8030	–	DATE TIME	–	Timestamp of last change of earth leakage protection mode
0x1F5E	8031	–	INT16U	–	Timestamp quality of last change of earth leakage protection mode
0x1F5F-0x1F62	8032–8035	–	DATE TIME	–	Timestamp of last change of any parameter of the earth leakage protection function
0x1F63	8036	–	INT16U	–	Timestamp quality of last change of any parameter of the earth leakage protection function
0x1F64-0x1F65	8037–8038	–	FLOAT32	–	Earth leakage protection threshold coefficient high limit
0x1F66-0x1F67	8039–8040	s	FLOAT32	–	Earth leakage protection time delay high limit
0x1F68-0x1F69	8041–8042	A	FLOAT32	–	Earth leakage protection threshold
0x1F6A-0x1F6B	8043–8044	s	FLOAT32	0.06, 0.15, 0.23, 0.35, 0.80	Earth leakage protection time delay
0x1F6C-0x1F6F	8045–8048	–	–	–	Reserved

Get Neutral Protection Settings

To get the neutral protection settings, set the command registers in the following way:

Address	Register	Unit	Type	Range	Description
0x1F3F	8000	–	INT16U	51589	Requested command code
0x1F40	8001	–	INT16U	14	Number of parameters of the command
0x1F41	8002	–	INT16U	5377 (0x1501)	Destination of the command
0x1F42	8003	–	INT16U	0	Security type of the command
0x1F43-0x1F44	8004–8005	–	OCTET STRING	0	Password of the command = 0 (no password required)
0x1F45-0x1F46	8006–8007	–	INT32U	0–4294967294	Key for the protection get command with session

The neutral protection settings are returned to command registers in the following way:

Address	Register	Unit	Type	Range	Description
0x1F53	8020	–	INT16U	51589	Last command code
0x1F54	8021	–	INT16U	–	Command status: <ul style="list-style-type: none"> • 0 = Successful command • Other value = command with error, page 58
0x1F55	8022	–	INT16U	32	Number of bytes returned
0x1F56-0x1F57	8023–8024	–	INT32U	0–4294967-294	Key for the protection get command with session
0x1F58	8025	–	INT16U	–	MSB: Neutral protection mode <ul style="list-style-type: none"> • 0 = Off • 1 = On LSB: Neutral protection function supported <ul style="list-style-type: none"> • 0 = Not supported • 1 = Supported
0x1F59-0x1F5C	8026–8029	–	DATETIME	–	Timestamp of last change of neutral protection mode
0x1F5D	8030	–	INT16U	–	Timestamp quality of last change of neutral protection mode
0x1F5E-0x1F61	8031–8034	–	DATETIME	–	Timestamp of last change of any parameter of the neutral protection function
0x1F62	8035	–	INT16U	–	Timestamp quality of last change of any parameter of the neutral protection function
0x1F63	8036	–	INT16U	0–3	MSB: 0 LSB: Neutral protection type <ul style="list-style-type: none"> • 0 = OFF • 1 = 0.5 • 2 = 1.0 • 3 = Oversized
0x1F64-0x1F65	8037–8038	A	FLOAT32	–	Long time over current protection threshold

IO Module Data for MasterPact MTZ Circuit Breakers

What's in This Part

IO Module Registers.....	216
IO Module Events.....	236
IO Module Commands.....	244

IO Module User Guides

For more information about the IO module functions, refer to [DOCA0055EN IO – Input/Output Application Module for One Circuit Breaker – User Guide](#).

IO Module Registers

What's in This Chapter

Introduction.....	217
Analog Inputs.....	218
Digital Inputs.....	220
Digital Outputs	223
Hardware Setting	225
Digital Input and Output Status	227
IO Module Identification	228
Alarm Status	230
Applications	233

Introduction

This section describes the IO module registers.

Registers 13824 to 15719 are held by the IO 1.

Registers 16824 to 18719 are held by the IO 2:

- The registers of the parameters of IO 2 are equal to the registers of the parameters of IO 1 plus 3000.

Example:

- Register 14599 holds the digital input status register of the IO 1.
- Register 17599 holds the digital input status register of the IO 2.
- The order of the registers is the same as that of the IO 1.
- The characteristics (access type, size, range, and unit) are the same as those of the registers of IO 1.
- Registers 15360 to 16109 containing the predefined application are specific to the IO 1 because they hold the predefined applications.

Analog Inputs

Analog Input Register Mapping

The following table describes the analog inputs and corresponding registers and addresses of the IO module.

IO Module	Analog Input Addresses	Analog Input Registers
IO 1	0x35FF–0x3668	13824–13929
IO 2	0x41B7–0x4220	16824–16929

Analog Input Registers of IO 1

The order and the description of the analog input registers of IO 2 are the same as those of IO 1.

Address	Register	RW	Unit	Type	Range	Description
0x35FF–0x3600	13824–13825	–	–	–	–	Reserved
0x3601–0x3602	13826–13827	R	°C	FLOAT32	-50–250	Analog input sensor Pt100 temperature value (updated once every 1 s)
0x3603	13828	R	–	INT16U	0–1	Data quality of the analog input <ul style="list-style-type: none"> • 0 = Valid • 1 = Invalid
0x3604	13829	–	–	–	–	Reserved
0x3605–0x3608	13830–13833	R	–	DATETIME	–	Timestamp of the last change of +/- 1 °C of the analog data value
0x3609–0x360C	13834–13837	–	–	–	–	Reserved
0x360D–0x360E	13838–13839	R	°C	FLOAT32	-50–250	Analog input Pt100 maximum value
0x360F–0x3610	13840–13841	R	°C	FLOAT32	-50–250	Analog input Pt100 minimum value
0x3611–0x3614	13842–13845	R	–	DATETIME	–	Timestamp of minimum value of analog input value recorded
0x3615–0x3618	13846–13849	R	–	DATETIME	–	Timestamp of maximum value of analog input value recorded
0x3619–0x361C	13850–13853	R	–	DATETIME	–	Timestamp of last reset of min/max values of analog input value recorded
0x361D–0x361E	13854–13855	R	–	INT32U	0–65534	Switchboard temperature threshold 1 counter This counter increments every time threshold 1 is exceeded.
0x361F–0x3620	13856–13857	R	–	INT32U	0–65534	Switchboard temperature threshold 2 counter This counter increments every time threshold 2 is exceeded.
0x3621–0x3622	13858–13859	R	–	INT32U	0–65534	Switchboard temperature threshold 3 counter This counter increments every time threshold 3 is exceeded.
0x3623–0x363A	13860–13883	R	–	OCTET STRING	–	Analog input identification coded over 45 ASCII characters ⁽¹⁾
0x363B	13884	R	–	INT16U	0–2	Analog input type ⁽¹⁾ <ul style="list-style-type: none"> • 0 = Analog input is not valid (factory setting) • 1 = Not applicable • 2 = Pt100
0x363C	13885	–	–	–	–	Reserved

Address	Register	RW	Unit	Type	Range	Description
0x363D– 0x363E	13886– 13887	R	°C	FLOAT32	-50–250	Switchboard temperature threshold 1 pick-up value (Pt100) ⁽¹⁾ Factory setting = 50 °C
0x363F– 0x3640	13888– 13889	R	s	FLOAT32	1–3600	Switchboard temperature threshold 1 pick-up time delay (Pt100) ⁽¹⁾ Factory setting = 10 s
0x3641– 0x3642	13890– 13891	R	°C	FLOAT32	-50–250	Switchboard temperature threshold 1 drop-out value (Pt100) ⁽¹⁾ Factory setting = 45 °C
0x3643– 0x3644	13892– 13893	R	s	FLOAT32	1–3600	Switchboard temperature threshold 1 drop-out time delay (Pt100) ⁽¹⁾ Factory setting = 10 s
0x3645– 0x3646	13894– 13895	R	°C	FLOAT32	-50–250	Switchboard temperature threshold 2 pick-up value (Pt100) ⁽¹⁾ Factory setting = 60 °C
0x3647– 0x3648	13896– 13897	R	s	FLOAT32	1–3600	Switchboard temperature threshold 2 pick-up time delay (Pt100) ⁽¹⁾ Factory setting = 10 s
0x3649– 0x364A	13898– 13899	R	°C	FLOAT32	-50–250	Switchboard temperature threshold 2 drop-out value (Pt100) ⁽¹⁾ Factory setting = 55 °C
0x364B– 0x364C	13900– 13901	R	s	FLOAT32	1–3600	Switchboard temperature threshold 2 drop-out time delay (Pt100) ⁽¹⁾ Factory setting = 10 s
0x364D– 0x364E	13902– 13903	R	°C	FLOAT32	-50–250	Switchboard temperature threshold 3 pick-up value (Pt100) ⁽¹⁾ Factory setting = 70 °C
0x364F– 0x3650	13904– 13905	R	s	FLOAT32	1–3600	Switchboard temperature threshold 3 pick-up time delay (Pt100) ⁽¹⁾ Factory setting = 10 s
0x3651– 0x3652	13906– 13907	R	°C	FLOAT32	-50–250	Switchboard temperature threshold 3 drop-out value (Pt100) ⁽¹⁾ Factory setting = 65 °C
0x3653– 0x3654	13908– 13909	R	s	FLOAT32	1–3600	Switchboard temperature threshold 3 drop-out time delay (Pt100) ⁽¹⁾ Factory setting = 10 s
0x3655– 0x3656	13910– 13911	R	Ω	FLOAT32	200–650	Motor temperature sensor fault threshold
0x3657– 0x3668	13912– 13929	–	–	–	–	Reserved

(1) Value set using the EcoStruxure Power Commission software.

Digital Inputs

Digital Input Register Mapping

Each digital input description is made up of 80 registers. The order and the description of the digital inputs 2, 3, 4, 5, and 6 are the same as those of digital input 1.

IO Module	Digital Input Number	Digital Input Addresses	Digital Input Registers
IO 1	I1	0x3669–0x36B8	13930–14009
	I2	0x36B9–0x3708	14010–14089
	I3	0x3709–0x3758	14090–14169
	I4	0x3759–0x37A8	14170–14249
	I5	0x37A9–0x37F8	14250–14329
	I6	0x37F9–0x3848	14330–14409
IO 2	I1	0x4221–0x4270	16930–17009
	I2	0x4271–0x42C0	17010–17089
	I3	0x42C1–0x4310	17090–17169
	I4	0x4311–0x4360	17170–17249
	I5	0x4361–0x43B0	17250–17329
	I6	0x43B1–0x4400	17330–17409

Digital Input 1 Registers of IO 1

The order and the description of the digital input 1 registers of IO 2 are the same as those of IO 1:

Address	Register	RW	Unit	Type	Range	Bit	Description
0x3669	13930	R	–	INT16U	–	–	Quality of each bit of register 13931: <ul style="list-style-type: none"> 0 = Invalid 1 = Valid
0x366A	13931	R	–	INT16U	–	0	Digital input status: <ul style="list-style-type: none"> 0 = Off 1 = On
						1	Digital input forced status: <ul style="list-style-type: none"> 0 = Unforced 1 = Forced
						2–15	Reserved
0x366B– 0x366E	13932– 13935	R	–	DATETIME	–	–	Timestamp for the last input transition: <ul style="list-style-type: none"> Last rising edge if input is configured as NO (normally open contact) Last falling edge if input is configured as NC (normally closed contact) Valid if input signal type is a normal digital input (not valid for pulse digital input).
0x366F– 0x3670	13936– 13937	–	–	–	–	–	Reserved
0x3671– 0x3672	13938– 13939	R	–	INT32U	0–4294967294	–	Input counter value This counter increments for each rising edge of the input.

Address	Register	RW	Unit	Type	Range	Bit	Description
							Valid if input signal type is normal digital input.
0x3673– 0x3676	13940– 13943	R	–	DATE TIME	–	–	Timestamp for the last input change counter preset/reset Valid if input signal type is normal digital input.
0x3677– 0x3678	13944– 13945	R	–	INT32U	0–4294967294	–	Number of pulses received Valid if input signal type is pulse digital input.
0x3679– 0x367C	13946– 13949	R	–	INT64	–	–	Resettable value of consumption Value = pulse weight x number of pulses received Valid if input signal type is pulse digital input.
0x367D– 0x3680	13950– 13953	R	–	INT64	–	–	Accumulated non-resettable value of consumption Valid if input signal type is pulse digital input.
0x3681– 0x3684	13954– 13957	R	–	DATE TIME	–	–	Timestamp of last resettable consumption value reset Valid if input signal type is pulse digital input.
0x3685– 0x3686	13958– 13959	R	W	FLOAT32	–	–	Power calculation Valid if <ul style="list-style-type: none"> • Input signal type is pulse digital input • the pulse input is from Energy pulse counter
0x3687– 0x369E	13960– 13983	R	–	OCTET STRING	–	–	Digital input identification coded over 45 ASCII characters ⁽¹⁾
0x369F– 0x36A0	13984– 13985	R	s	FLOAT32	0.003–1	–	Digital input 1 filter time
0x36A1	13986	R	–	INT16U	0–1	–	Input contact type ⁽¹⁾ <ul style="list-style-type: none"> • 0 = NO (normally open contact, factory setting) • 1 = NC (normally close contact)
0x36A2	13987	R	–	INT16U	0–1	–	Input signal type ⁽¹⁾ <ul style="list-style-type: none"> • 0 = normal digital input (factory setting) • 1 = pulse digital input
0x36A3	13988	R	–	INT16U	0–1	–	Pulse polarity ⁽¹⁾ <ul style="list-style-type: none"> • 0 = low to high (factory setting) • 1 = high to low Valid if input signal type is pulse digital input.
0x36A4	13989	R	–	INT16U	1–4	–	Pulse unit ⁽¹⁾ <ul style="list-style-type: none"> • 1 = Wh (Watt-hour, factory setting) • 2 = VARh (Reactive Volt-Ampere hour) • 3 = VAh (Volt-Ampere hour) • 4 = m³ (cubic meters) Valid if input signal type is pulse digital input.
0x36A5– 0x36A6	13990– 13991	R	–	FLOAT32	1–16777215	–	Pulse weight ^{(1) (2)}

Address	Register	RW	Unit	Type	Range	Bit	Description
							Valid if input signal type is pulse digital input. Factory setting = 1.0
0x36A7– 0x36A8	13992– 13993	R	–	INT32U	1–4294967294	–	Input counter threshold value ⁽¹⁾ Valid if input signal type is normal digital input. Factory setting = 5000
0x36A9– 0x36B8	13994– 14009	–	–	–	–	–	Reserved

(1) Value set by using the EcoStruxure Power Commission software.

(2) Examples:

- If each incoming pulse represents 125 kWh, and since consumption data must be expressed in watt-hours, the consumption pulse weight is 125,000.
- If each incoming pulse represents 1 US gallon, and since consumption data must be expressed in cubic meters, the consumption pulse weight is 0.003785.

Digital Outputs

Digital Output Register Mapping

Each digital output description is made up of 60 registers. The order and the description of the digital outputs 2 and 3 are the same as those of digital output 1.

IO Module	Digital Output Number	Digital Output Addresses	Digital Output Registers
IO 1	O1	0x3849–0x3884	14410–14469
	O2	0x3885–0x38C0	14470–14529
	O3	0x38C1–0x38FC	14530–14589
IO 2	O1	0x4401–0x443C	17410–17469
	O2	0x443D–0x4478	17470–17529
	O3	0x4479–0x44B4	17530–17589

Digital Output 1 Registers of IO 1

The order and the description of the digital output 1 registers of IO 2 are the same as those of IO 1:

Address	Register	RW	Unit	Type	Range	Bit	Description
0x3849	14410	R	–	INT16U	–	–	Quality of each bit of register 14411: <ul style="list-style-type: none"> 0 = Invalid 1 = Valid
0x384A	14411	R-WC	–	INT16U	–	0	Reserved
						1	Digital output status: <ul style="list-style-type: none"> 0 = OFF 1 = ON
		R				2	Digital output forced status: <ul style="list-style-type: none"> 0 = Unforced 1 = Forced
		3–15				Reserved	
0x384B–0x384E	14412–14415	R	–	DATETIME	–	–	Timestamp for the last output transition: <ul style="list-style-type: none"> Last rising edge if output is configured as NO (normally open contact) Last falling edge if output is configured as NC (normally closed contact)
0x384F–0x3850	14416–14417	–	–	–	–	–	Reserved
0x3851–0x3852	14418–14419	R	–	INT32U	1-4294967294	–	Output counter This counter increments for each rising edge of the output.
0x3853–0x3856	14420–14423	R	–	DATETIME	–	–	Timestamp of the last reset for the output counter
0x3857–0x386E	14424–14447	R	–	OCTET STRING	–	–	Digital output identification coded over 45 ASCII characters
0x386F	14448	R	–	INT16U	0–2	–	Output operating mode ⁽¹⁾ : <ul style="list-style-type: none"> 0 = Non-latching (factory setting) 1 = Latched 2 = Time delayed non-latching
0x3870	14449	R	s	INT16U	0–65534	–	On time for time delayed non-latching mode value ⁽¹⁾

Address	Register	RW	Unit	Type	Range	Bit	Description
							The time for the output to remain energized when the output is in time delayed non-latching mode (Factory setting = 0)
0x3871	14450	R	–	INT16U	0–1	–	Output contact type ⁽¹⁾ : <ul style="list-style-type: none"> • 0 = NO (normally open, factory setting) • 1 = NC (normally close)
0x3872	14451	R	–	INT16U	0–2	–	Indicates On/Off state of the discrete output when any fall back condition occurs ⁽¹⁾ : <ul style="list-style-type: none"> • 0 = OFF (factory setting) • 1 = ON • 2 = Freeze
0x3873– 0x3874	14452– 14453	R	–	INT32U	1-4294967294	–	Output counter threshold value ⁽¹⁾ Factory setting = 5000
0x3875	14454	R-WC	–	INT16U	0–2	–	Simple command for output ⁽¹⁾ : <ul style="list-style-type: none"> • 0 = No command • 1 = OFF • 2 = ON Valid if simple commands are enabled ⁽²⁾ .
0x3876– 0x3884	14455– 14469	–	–	–	–	–	Reserved
<p>(1) Value set using the EcoStruxure Power Commission software.</p> <p>(2) Simple commands are enabled by factory setting. The simple commands can be disabled by using the command Enable/Disable commands.</p>							

Hardware Setting

Addresses and Registers List

The following table describes the hardware settings addresses, and registers regarding the IO module.

IO Module	Addresses	Registers
IO 1	0x38FD–0x3902	14590–14595
IO 2	0x44B5–0x44BA	17590–17595

Hardware Setting Registers for IO 1

The order and the description of the hardware setting registers for IO 2 are the same as those of IO 1.

Address	Register	RW	Unit	Type	Range	Description
0x38FD	14590	R	–	INT16U	1–9	Application rotary switch current position: <ul style="list-style-type: none"> • 1 = position 1 • 2 = position 2 • 3 = position 3 • 4 = position 4 • 5 = position 5 • 6 = position 6 • 7 = position 7 • 8 = position 8 • 9 = position 9
0x38FE	14591	R	–	INT16U	0–1	Remote setup padlock position: <ul style="list-style-type: none"> • 0 = Unlock • 1 = Lock
0x38FF	14592	R	–	INT16U	0–1	Dip switch1 position: <ul style="list-style-type: none"> • 0 = IO 1 • 1 = IO 2
0x3900	14593	–	–	–	–	Reserved
0x3901	14594	R	–	INT16U	1–9	Last validated application set by the test button located on the front of the IO module: <ul style="list-style-type: none"> • 1 = position 1 • 2 = position 2 • 3 = position 3 • 4 = position 4 • 5 = position 5 • 6 = position 6 • 7 = position 7 • 8 = position 8 • 9 = position 9

Address	Register	RW	Unit	Type	Range	Description
0x3902	14595	R	–	INT16U	1–9	Last validated application set by the EcoStruxure Power Commission software: <ul style="list-style-type: none">• 1 = position 1• 2 = position 2• 3 = position 3• 4 = position 4• 5 = position 5• 6 = position 6• 7 = position 7• 8 = position 8• 9 = position 9
0x3903– 0x3904	14596– 14597	–	–	–	–	Reserved

Digital Input and Output Status

Addresses and Registers List

The following table describes the digital inputs and outputs status addresses, and registers regarding the IO module.

IO Module	Addresses	Registers
IO 1	0x3905–0x3908	14598–14601
IO 2	0x44BD–0x44C0	17598–17601

Digital Input and Output Status Registers for IO 1

The order and the description of the digital input and output status registers for IO 2 are the same as those of IO 1.

Address	Register	RW	Unit	Type	Range	Bit	Description
0x3905	14598	R	–	INT16U	–	–	Quality of each bit of register 14599: <ul style="list-style-type: none"> • 0 = Invalid • 1 = Valid
0x3906	14599	R	–	INT16U	–	–	Digital input status register: <ul style="list-style-type: none"> • Input status = 0 when input is OFF • Input status = 1 when input is ON
						0	I1 status
						1	I2 status
						2	I3 status
						3	I4 status
						4	I5 status
						5	I6 status
6–15	Reserved						
0x3907	14600	R	–	INT16U	–	–	Quality of each bit of register 14601: <ul style="list-style-type: none"> • 0 = Invalid • 1 = Valid
0x3908	14601	R–WC	–	INT16U	–	–	Digital output status register: <ul style="list-style-type: none"> • Output status = 0 when output is OFF • Output status = 1 when output is ON
						0	O1 status
						1	O2 status
						2	O3 status
						3–15	Reserved

IO Module Identification

Introduction

The order and the description of the IO module identification registers for IO 2 are the same as those of IO 1.

Addresses and Registers List

The following table describes the identification addresses, and registers regarding the IO module.

IO Module	Addresses	Registers
IO 1	0x392F–0x3982	14640–14723
IO 2	0x44E7–0x453A	17640–17723

IO Hardware Revision

The hardware revision is an ASCII string using the format XXX.YYY.ZZZ with:

- XXX = major version (000–127)
- YYY = minor version (000–255)
- ZZZ = revision number (000–255)

The NULL character ends the revision number.

Address	Register	RW	Unit	Type	Range	Description
0x3961–0x3966	14690–14695	R	–	OCTET STRING	–	Hardware revision

IO Module Firmware Revision

The firmware revision is an ASCII string using the format XXX.YYY.ZZZ with:

- XXX = major version (000–127)
- YYY = minor version (000–255)
- ZZZ = revision number (000–255)

The NULL character ends the revision number.

Address	Register	RW	Unit	Type	Range	Description
0x3967–0x396C	14696–14701	R	–	OCTET STRING	–	Firmware revision

Current Date and Time

Address	Register	RW	Unit	Type	Range	Description
0x396D–0x3970	14702–14705	R	–	DATETIME	–	Current date and time of the IO module in DATETIME format, set by using the EcoStruxure Power Commission software.

Serial Number

The IO module serial number is composed of a maximum of 11 alphanumeric characters with the following format: PPYYWWDnnnn.

- PP = plant code
- YY = year of fabrication (05–99)
- WW = week of fabrication (01–53)
- D = day of fabrication (1–7)
- nnnn = production number of the device on the day (0001–9999)

A read request of 6 registers is necessary to read the IO module serial number.

Address	Register	RW	Unit	Type	Range	Description
0x3971–0x397A	14706-14715	R	–	OCTET STRING	–	Serial number
0x3971	14706	R	–	OCTET STRING	–	'PP'
0x3972	14707	R	–	OCTET STRING	'05'–'99'	'YY'
0x3973	14708	R	–	OCTET STRING	'01'–'53'	'WW'
0x3974	14709	R	–	OCTET STRING	'10'–'79'	'Dn'
0x3975	14710	R	–	OCTET STRING	'00'–'99'	'nn'
0x3976	14711	R	–	OCTET STRING	'0'–'9'	'n' (the NULL character ends the serial number)

Manufacturing Date and Time

Address	Register	RW	Unit	Type	Range	Description
0x397B–0x397E	14716–14719	R	–	DATETIME	–	Manufacturing date and time

Product Identification

Address	Register	RW	Unit	Type	Range	Description
0x392F	14640	R	–	INT16U	15150	Product identification = 15150 for the IO module
0x3930	14641	–	–	–	–	Reserved
0x397F–0x3982	14720–14723	R	–	OCTET STRING	–	Product code = 'LV434063'
0x3D1C–0x3D3B	15645–15676	R–WC	–	OCTET STRING	–	User application name
0x3D3C–0x3D45	15677–15686	R	–	OCTET STRING	–	Vendor name = 'Schneider Electric'
0x3D46–0x3D4D	15687–15694	R	–	OCTET STRING	–	Product range: 'Enerlinx'
0x3D4E–0x3D5D	15695–15710	R	–	OCTET STRING	–	Device family: 'IO device'
0x3D5E–0x3D65	15711–15718	R	–	OCTET STRING	–	Product model

Alarm Status

Addresses and Registers List

The following table describes the alarm status addresses, and registers regarding the IO module.

IO Module	Addresses	Registers
IO 1	0x3989–0x39A6	14730–14759
IO 2	0x4541–0x455E	17730–17759

Generic Alarm Status for IO 1

The order and the description of the generic alarm status registers for IO 2 are the same as those of IO 1.

Address	Register	RW	Unit	Type	Range	Bit	Description
0x3989	14730	R	–	INT16U	–	–	Quality of each bit of register 14731: <ul style="list-style-type: none"> • 0 = Invalid • 1 = Valid
0x398A	14731	R	–	INT16U	–	–	IO module history format register
						0	ULP format
						1	TI086 format
						2–15	Reserved
0x398B	14732	R	–	INT16U	–	–	Quality of each bit of register 14733: <ul style="list-style-type: none"> • 0 = Invalid • 1 = Valid
0x398C	14733	R	–	INT16U	–	–	IO module command type Factory setting = 3, both write command mechanisms are enabled.
						0	1 = Complex commands
						1	1 = Simple commands Simple commands can be disabled by sending a command
						2–15	Reserved
0x398D– 0x3992	14734– 14739	–	–	–	–	–	Reserved
0x3993	14740	R	–	INT16U	–	–	Quality of each bit of register 14741: <ul style="list-style-type: none"> • 0 = Invalid • 1 = Valid
0x3994	14741	R	–	INT16U	–	–	IO module generic alarm 1 status register.
						0	IO module in STOP mode: IO module is not working and must be replaced.
						1	IO module in ERROR mode: IO module is working in degraded mode.
						2	Threshold overrun on I1 counter
						3	Threshold overrun on I2 counter
						4	Threshold overrun on I3 counter
						5	Threshold overrun on I4 counter
						6	Threshold overrun on I5 counter
7	Threshold overrun on I6 counter						

Address	Register	RW	Unit	Type	Range	Bit	Description
						8	Threshold overrun on O1 counter
						9	Threshold overrun on O2 counter
						10	Threshold overrun on O3 counter
						11	Switchboard temperature threshold 1 overrun
						12	Switchboard temperature threshold 2 overrun
						13	Switchboard temperature threshold 3 overrun
						14–15	Reserved
0x3995	14742	R	–	INT16U	–	–	Quality of each bit of register 14743: <ul style="list-style-type: none"> • 0 = Invalid • 1 = Valid
0x3996	14743	R	–	INT16U	–	–	IO module generic alarm 2 status register.
						0	User-defined input 1 alarm
						1	User-defined input 2 alarm
						2	User-defined input 3 alarm
						3	User-defined input 4 alarm
						4	User-defined input 5 alarm
						5	User-defined input 6 alarm
						6–15	Reserved

Cradle and Drawer Management Alarms for IO 1

Address	Register	RW	Unit	Type	Range	Bit	Description
0x3997	14744	R	–	INT16U	–	–	Quality of each bit of register 14745: <ul style="list-style-type: none"> • 0 = Invalid • 1 = Valid
0x3998	14745	R	–	INT16U	–	–	Cradle management alarms register
						0	Cradle position discrepancy
						1	Disconnection of the circuit breaker from cradle is overdue.
						2	Cradle has reached its maximum number of operation
						3	Remaining service life of cradle is below alarm threshold
						4	New MicroLogic control unit has been detected
						5–7	Reserved
						8	Drawer position discrepancy
						9–15	Reserved

Motor Alarms for IO 1

Address	Register	RW	Unit	Type	Range	Bit	Description
0x3999	14746	R	–	INT16U	–	–	Quality of each bit of register 14747: <ul style="list-style-type: none"> • 0 = Invalid • 1 = Valid
0x399A	14747	R	–	INT16U	–	–	IO motor alarms
						0–15	Reserved

Miscellaneous Application Alarms for IO 1

Address	Register	RW	Unit	Type	Range	Bit	Description
0x399B	14748	R	–	INT16U	–	–	Quality of each bit of register 14748: <ul style="list-style-type: none"> • 0 = Invalid • 1 = Valid
0x399C	14749	R	–	INT16U	–	–	Other application alarms register
						0	Auxiliary contact of load contactor 1 is not closed.
						1	Auxiliary contact of load contactor 1 is not opened.
						2	Reserved
						3	Dual settings 2-wire input discrepancy
						4–15	Reserved
0x399D	14750	R	–	INT16U	–	–	Quality of each bit of register 14751: <ul style="list-style-type: none"> • 0 = Invalid • 1 = Valid
0x399E	14751	R	–	INT16U	–	–	Predefined input alarms register
						0	Earth-leakage trip signal contact (SDV)
						1	Control voltage presence contact
						2	Surge protection status contact
						3	Surge failure contact
						4	Switch-disconnector ON/OFF indication contact (OF)
						5	Fuse blown indication contact
						6	Emergency stop
						7	Switchboard temperature contact
						8	Switchboard ventilation contact
						9	Switchboard door contact
						10–15	Reserved
0x399F	14752	R	–	INT16U	–	–	Quality of each bit of register 14753: <ul style="list-style-type: none"> • 0 = Invalid • 1 = Valid
0x39A0	14753	R	–	INT16U	–	–	IO module discrepancy alarms register
						0	Critical hardware discrepancy
						1	Critical firmware discrepancy
						2	Non-critical hardware discrepancy
						3	Non-critical firmware discrepancy
4–15	Reserved						
0x39A1– 0x39A6	14754– 14759	–	–	–	–	–	Reserved

Applications

IO Application Status

Address	Register	RW	Unit	Type	Range	Bit	Description
0x3927	14632	R	–	INT16U	–	0	Cradle application enabled or disabled: <ul style="list-style-type: none"> • 0 = Disabled • 1 = Enabled
						1–15	Reserved
0x3928	14633	R	–	INT16U	–	–	Quality of each bit of register 14632: <ul style="list-style-type: none"> • 0 = Invalid • 1 = Valid

Cradle Management

The table describes the registers related to the cradle management application performed by IO 1 (predefined or user defined application).

The registers 18300–18329 are related to the cradle management application performed by IO 2 (predefined or user defined application).

Address	Register	RW	Unit	Type	Range	Bit	Description
0x3BC3	15300	R-RC	–	INT16U	–	–	Quality of each bit of register 15301: <ul style="list-style-type: none"> • 0 = Invalid • 1 = Valid
0x3BC4	15301	R-RC	–	INT16U	–	–	Cradle status
						0–7	Reserved
						8	Device in disconnected position (CD)
						9	Device in connected position (CE)
						10	Device in the test position (CT)
						11–15	Reserved
0x3BC5– 0x3BC6	15302– 15303	R-RC- WC	–	INT32U	0–65534	–	Cradle connected position counter This counter increments for each rising edge of the cradle connected position
0x3BC7– 0x3BC8	15304– 15305	R-RC- WC	–	INT32U	0–65534	–	Cradle disconnected position counter This counter increments for each rising edge of the cradle disconnected position
0x3BC9– 0x3BCA	15306– 15307	R-RC- WC	–	INT32U	0–65534	–	Cradle test position counter This counter increments for each rising edge of the cradle test position
0x3BCB– 0x3BCE	15308– 15311	R-RC	–	DATETIME	–	–	Timestamp of the last change for the cradle connected position
0x3BCF– 0x3BD2	15312– 15315	R-RC	–	DATETIME	–	–	Timestamp of the last change for the cradle disconnected position
0x3BD3– 0x3BD6	15316– 15319	R-RC	–	DATETIME	–	–	Timestamp of the last change for the cradle test position
0x3BD7– 0x3BD8	15320– 15321	R-WC	s	INT32U	–	–	Operating time since last grease maintenance
0x3BD9– 0x3BDA	15322– 15323	R-WC	s	INT32U	–	–	Operating time since last move connected position

Address	Register	RW	Unit	Type	Range	Bit	Description
0x3BDB	15324	R	–	INT16U	0-65534	–	Cradle contact regrease counter
0x3BDC– 0x3BE0	15325– 15329	–	–	–	–	–	Reserved

Drawer Management

The table describes the registers related to the Drawer management user-defined application performed by IO 1.

The registers 18330–18359 are related to the Drawer management user-defined application performed by IO 2.

Address	Register	RW	Unit	Type	Range	Bit	Description
0x3BE1	15330	R	–	INT16U	–	–	Quality of each bit of register 15331: 0 = Invalid 1 = Valid
0x3BE2	15331	R	–	INT16U	–	–	Drawer status
						0–7	Reserved
						8	Drawer in disconnected position
						9	Drawer in connected position
						10	Drawer in the test position
11–15	Reserved						
0x3BE3– 0x3BE4	15332– 15333	R	–	INT32U	–	–	Drawer connected position counter. This counter increments for each rising edge of the drawer connected position.
0x3BE5– 0x3BE6	15334– 15335	R	–	INT32U	–	–	Drawer disconnected position counter. This counter increments for each rising edge of the drawer disconnected position.
0x3BE7– 0x3BE8	15336– 15337	R	–	INT32U	–	–	Drawer test position counter. This counter increments for each rising edge of the drawer test position.
0x3BE9– 0x3BEC	15338– 15341	R	–	DATETIME	–	–	Timestamp of the last change for the drawer connected position.
0x3BED– 0x3BF0	15342– 15345	R	–	DATETIME	–	–	Timestamp of the last change for the drawer disconnected position.
0x3BF1– 0x3BF4	15346– 15349	R	–	DATETIME	–	–	Timestamp of the last change for the drawer test position.
0x3BF5– 0x3BFE	15350– 15359	–	–	–	–	–	Reserved

Light Control

The table describes the registers related to the Light control predefined application performed by IO 1.

The registers 18400–18409 are related to the Light control predefined application performed by IO 2.

Address	Register	RW	Unit	Type	Range	Description
0x3C27	15400	R	–	INT16U	0–1	Quality of register 15401: <ul style="list-style-type: none"> 0 = Invalid 1 = Valid (application is configured and running)
0x3C28	15401	R	–	INT16U	0–1	Light status: <ul style="list-style-type: none"> 0 = Reset/OFF 1 = Set/ON
0x3C29– 0x3C2A	15402– 15403	R	s	INT32U	0–54000	Remaining time in ON or OFF state (depending of the light status)
0x3C2B–	15404	R	–	INT16U	0–2	Light simple command ⁽¹⁾ : <ul style="list-style-type: none"> 0 = No command 1 = Light OFF 2 = Light ON
0x3C2C– 0x3C30	15405– 15409	–	–	–	–	Reserved

(1) Simple commands are enabled by factory setting. The simple commands can be disabled by using the command Enable/Disable simple commands.

Load Control

The table describes the registers related to the Load control predefined application performed by IO 1.

The registers 18410–18419 are related to the Load control predefined application performed by IO 2.

Address	Register	RW	Unit	Type	Range	Description
0x3C31	15410	R	–	INT16U	0–1	Quality of register 15411: <ul style="list-style-type: none"> 0 = Invalid 1 = Valid (application is configured and running)
0x3C32	15411	R	–	INT16U	0–1	Load status: <ul style="list-style-type: none"> 0 = Reset/OFF 1 = Set/ON
0x3C33– 0x3C34	15412– 15413	R	s	INT32U	0–54000	Remaining time in ON or OFF state (depending of the load status)
0x3C35	15414	R	–	INT16U	0–2	Load simple command ⁽¹⁾ : <ul style="list-style-type: none"> 0 = No command 1 = Load OFF 2 = Load ON
0x3C36– 0x3EEC	15415– 16109	–	–	–	–	Reserved

(1) Simple commands are enabled by factory setting. The simple commands can be disabled by using the command Enable/Disable simple commands.

IO Module Events

What's in This Chapter

Event History	237
IO Module Events and Alarms	239

Event History

General Description

The event history registers describe the last 100 encountered events. The event history format corresponds to a series of 100 records. Each record is composed of 5 registers describing one event.

A read request of $5x(n)$ registers is necessary to read the last n event records, where 5 is the number of registers for each event record.

For example, a read request of $5x3 = 15$ registers is necessary to read the last 3 event records of the event history:

- The first five registers describe the first event record (most recent event).
- The next five registers describe the second event record.
- The last five registers describe the third event record.

There are two event histories, 1 per IO module.

IO Module	Address	Register	Description
IO 1	0x39A7–0x39AB	14760–14764	Event record 1 (most recent event record)
	0x39AC–0x39B0	14765–14769	Event record 2
	0x39A7+5x(n-1)–0x39AB+5x(n-1)	14760+5x(n-1)–14764+5x(n-1)	Event record n
	0x3B96–0x3B9A	15255–15259	Event record 100
IO 2	0x455F–0x4563	17760–17764	Event record 1 (most recent event record)
	0x4564–0x4568	17765–17769	Event record 2
	0x455F+5x(n-1)–0x4563+5x(n-1)	17760+5x(n-1)–17764+5x(n-1)	Event record n
	0x474E–0x4752	18255–18259	Event record 100

NOTE: The event history of IO modules connected to a MasterPact MTZ circuit breaker can be read also by using the [Get events command](#), page 247.

Event Record

A block request of five registers is necessary to read an event record. The order and the description of the event record registers of IO 2 are the same as those of IO 1:

Event Record 1 (Most Recent Event Record)				
Register	Address	RW	Type	Description
0x39A7	14760	R	INT16U	Event code of IO 1 and IO 2, page 239
0x39A8– 0x39AA	14761– 14763	R	ULP DATE	Date and time of the event
0x39AB	14764	R	INT16U	Event type MSB = 0 (reserved) Event occurrence: LSB = 1 Event completion: LSB = 2

Alarm Definition

Alarms are specific events that need to be reset.

The reset mode of an alarm can be:

- automatic: the alarm is reset automatically when the alarm is no more active.
- manual: the alarm is reset manually with the Test/Reset pushbutton located on the front face of the IO module and when the alarm is no more active.
- remote: the alarm is reset remotely with the Reset command sent via the communication and when the alarm is no more active.

Each alarm has a priority level that manages the alarm display on the FDM121 display:

- no priority = N/A (not affected)
- low priority = 1. No alarm display on the FDM121 display
- medium priority = 2. The FDM121 display LED is steady ON.
- high priority = 3. The FDM121 display LED blinks and a pop-up screen informs that the alarm has occurred.

IO Module Events and Alarms

IO 1 Events and Alarms

Code	Application	Description	Type	Priority	Reset Mode
1537 (0x0601)	General	IO1 Watchdog reset	Event	Medium	–
1538 (0x0602)	General	IO1 reset to factory setting	Event	Medium	–
1539 (0x0603)	General	IO1 failure (STOP mode)	Alarm	High	Manual or Remote
1540 (0x0604)	General	IO1 failure (ERROR mode)	Alarm	Medium	Manual or Remote
1541 (0x0605)	General	IO1 functional rotary switch position change	Event	Medium	–
1542 (0x0606)	General	IO1 setting locking pad rotary switch position change	Event	Medium	–
1543 (0x0607)	General	IO1 source address dip switch position change	Event	Medium	–
1552 (0x0610)	General	IO1 O1 rising edge (OFF/ON change)	Event	Low	–
1553 (0x0611)	General	IO1 O2 rising edge (OFF/ON change)	Event	Low	–
1554 (0x0612)	General	IO1 O3 rising edge (OFF/ON change)	Event	Low	–
1555 (0x0613)	General	IO1 I1 rising edge (OFF/ON change)	Event	Low	–
1556 (0x0614)	General	IO1 I2 rising edge (OFF/ON change)	Event	Low	–
1557 (0x0615)	General	IO1 I3 rising edge (OFF/ON change)	Event	Low	–
1558 (0x0616)	General	IO1 I4 rising edge (OFF/ON change)	Event	Low	–
1559 (0x0617)	General	IO1 I5 rising edge (OFF/ON change)	Event	Low	–
1560 (0x0618)	General	IO1 I6 rising edge (OFF/ON change)	Event	Low	–
1561 (0x0619)	General	IO1 threshold overrun on I1 counter	Alarm	Medium	Manual or Remote
1562 (0x061A)	General	IO1 threshold overrun on I2 counter	Alarm	Medium	Manual or Remote
1563 (0x061B)	General	IO1 threshold overrun on I3 counter	Alarm	Medium	Manual or Remote
1564 (0x061C)	General	IO1 threshold overrun on I4 counter	Alarm	Medium	Manual or Remote
1565 (0x061D)	General	IO1 threshold overrun on I5 counter	Alarm	Medium	Manual or Remote
1566 (0x061E)	General	IO1 threshold overrun on I6 counter	Alarm	Medium	Manual or Remote
1567 (0x061F)	General	IO1 threshold overrun on O1 counter	Alarm	Medium	Manual or Remote
1568 (0x0620)	General	IO1 threshold overrun on O2 counter	Alarm	Medium	Manual or Remote
1569 (0x0621)	General	IO1 threshold overrun on O3 counter	Alarm	Medium	Manual or Remote

Code	Application	Description	Type	Priority	Reset Mode
1570 (0x0622)	General	IO1 I1 unforced/forced change	Event	Low	–
1571 (0x0623)	General	IO1 I2 unforced/forced change	Event	Low	–
1572 (0x0624)	General	IO1 I3 unforced/forced change	Event	Low	–
1573 (0x0625)	General	IO1 I4 unforced/forced change	Event	Low	–
1574 (0x0626)	General	IO1 I5 unforced/forced change	Event	Low	–
1575 (0x0627)	General	IO1 I6 unforced/forced change	Event	Low	–
1576 (0x0628)	General	IO1 O1 unforced/forced change	Event	Low	–
1577 (0x0629)	General	IO1 O2 unforced/forced change	Event	Low	–
1578 (0x062A)	General	IO1 O3 unforced/forced change	Event	Low	–
1579 (0x062B)	User-defined input acquisition	IO1 user-defined input 1	Alarm	Medium	Manual or Remote
1580 (0x062C)	User-defined input acquisition	IO1 user-defined input 2	Alarm	Medium	Manual or Remote
1581 (0x062D)	User-defined input acquisition	IO1 user-defined input 3	Alarm	Medium	Manual or Remote
1582 (0x062E)	User-defined input acquisition	IO1 user-defined input 4	Alarm	Medium	Manual or Remote
1583 (0x062F)	User-defined input acquisition	IO1 user-defined input 5	Alarm	Medium	Manual or Remote
1584 (0x0630)	User-defined input acquisition	IO1 user-defined input 6	Alarm	Medium	Manual or Remote
1585 (0x0631)	Cooling system	IO1 switchboard temperature threshold 1 overrun	Alarm	Low	Auto
1586 (0x0632)	Cooling system	IO1 switchboard temperature threshold 2 overrun	Alarm	Medium	Manual or Remote
1587 (0x0633)	Cooling system	IO1 switchboard temperature threshold 3 overrun	Alarm	High	Manual or Remote

NOTE: The alarm exit priority is fixed in IO module firmware. The value is Low, when available.

IO 2 Events and Alarms

Code	Application	Description	Type	Priority	Reset Mode
1793 (0x0701)	General	IO2 watchdog reset	Event	Medium	–
1794 (0x0702)	General	IO2 reset to factory settings	Event	Medium	–
1795 (0x0703)	General	IO2 module failure (STOP mode)	Alarm	High	Manual or Remote
1796 (0x0704)	General	IO2 module failure (ERROR mode)	Alarm	Medium	Manual or Remote
1797 (0x0705)	General	IO2 functional rotary switch position change	Event	Medium	–
1798 (0x0706)	General	IO2 setting locking pad rotary switch position change	Event	Medium	–

Code	Application	Description	Type	Priority	Reset Mode
1799 (0x0707)	General	IO2 source address dip switch position change	Event	–	–
1808 (0x0710)	General	IO2 O1 rising edge (OFF/ON change)	Event	Low	–
1809 (0x0711)	General	IO2 O2 rising edge (OFF/ON change)	Event	Low	–
1810 (0x0712)	General	IO2 O3 rising edge (OFF/ON change)	Event	Low	–
1811 (0x0713)	General	IO2 I1 rising edge (OFF/ON change)	Event	Low	–
1812 (0x0714)	General	IO2 I2 rising edge (OFF/ON change)	Event	Low	–
1813 (0x0715)	General	IO2 I3 rising edge (OFF/ON change)	Event	Low	–
1814 (0x0716)	General	IO2 I4 rising edge (OFF/ON change)	Event	Low	–
1815 (0x0717)	General	IO2 I5 rising edge (OFF/ON change)	Event	Low	–
1816 (0x0718)	General	IO2 I6 rising edge (OFF/ON change)	Event	Low	–
1817 (0x0719)	General	IO2 threshold overrun on I1 counter	Alarm	Medium	Manual or Remote
1818 (0x071A)	General	IO2 threshold overrun on I2 counter	Alarm	Medium	Manual or Remote
1819 (0x071B)	General	IO2 threshold overrun on I3 counter	Alarm	Medium	Manual or Remote
1820 (0x071C)	General	IO2 threshold overrun on I4 counter	Alarm	Medium	Manual or Remote
1821 (0x071D)	General	IO2 threshold overrun on I5 counter	Alarm	Medium	Manual or Remote
1822 (0x071E)	General	IO2 threshold overrun on I6 counter	Alarm	Medium	Manual or Remote
1823 (0x071F)	General	IO2 threshold overrun on O1 counter	Alarm	Medium	Manual or Remote
1824 (0x0720)	General	IO2 threshold overrun on O2 counter	Alarm	Medium	Manual or Remote
1825 (0x0721)	General	IO2 threshold overrun on O3 counter	Alarm	Medium	Manual or Remote
1826 (0x0722)	General	IO2 I1 unforced/forced change	Event	Low	–
1827 (0x0723)	General	IO2 I2 unforced/forced change	Event	Low	–
1828 (0x0724)	General	IO2 I3 unforced/forced change	Event	Low	–
1829 (0x0725)	General	IO2 I4 unforced/forced change	Event	Low	–
1830 (0x0726)	General	IO2 I5 unforced/forced change	Event	Low	–
1831 (0x0727)	General	IO2 I6 unforced/forced change	Event	Low	–
1832 (0x0728)	General	IO2 O1 unforced/forced change	Event	Low	–
1833 (0x0729)	General	IO2 O2 unforced/forced change	Event	Low	–
1834 (0x072A)	General	IO2 O3 unforced/forced change	Event	Low	–

Code	Application	Description	Type	Priority	Reset Mode
1835 (0x072B)	User-defined input acquisition	IO2 user-defined input 1	Alarm	Medium	Manual or Remote
1836 (0x072C)	User-defined input acquisition	IO2 user-defined input 2	Alarm	Medium	Manual or Remote
1837 (0x072D)	User-defined input acquisition	IO2 user-defined input 3	Alarm	Medium	Manual or Remote
1838 (0x072E)	User-defined input acquisition	IO2 user-defined input 4	Alarm	Medium	Manual or Remote
1839 (0x072F)	User-defined input acquisition	IO2 user-defined input 5	Alarm	Medium	Manual or Remote
1840 (0x0730)	User-defined input acquisition	IO2 user-defined input 6	Alarm	Medium	Manual or Remote
1841 (0x0731)	Cooling system	IO2 switchboard temperature threshold 1 overrun	Alarm	Low	Auto
1842 (0x0732)	Cooling system	IO2 switchboard temperature threshold 2 overrun	Alarm	Medium	Manual or Remote
1843 (0x0733)	Cooling system	IO2 switchboard temperature threshold 3 overrun	Alarm	High	Manual or Remote

NOTE: The alarm exit priority is fixed in IO firmware. The value is Low, when available.

IO 1 and IO 2 Events and Alarms

Code	Application	Description	Type	Priority	Reset Mode
2304 (0x0900)	Cradle management	Cradle position discrepancy	Alarm	Medium	Manual or Remote
2305 (0x0901)	Cradle management	Cradle connected contact change	Alarm	Low	Manual or Remote
2306 (0x0902)	Cradle management	Cradle disconnected contact change	Alarm	Low	Manual or Remote
2307 (0x0903)	Cradle management	Cradle test contact change	Alarm	Low	Manual or Remote
2308 (0x0904)	Cradle management	Remove device from cradle and put it back	Alarm	Medium	Manual or Remote
2309 (0x0905)	Cradle management	Cradle has reached its maximum number of operations	Alarm	High	Manual or Remote
2310 (0x0906)	Cradle management	Remaining service life of cradle is below alarm threshold	Alarm	Medium	Manual or Remote
2311 (0x0907)	Cradle management	New MicroLogic control unit has been detected.	Alarm	High	Manual or Remote
2432 (0x0980)	Drawer management	Drawer position discrepancy	Alarm	Medium	Manual or Remote
2560 (0x0A00)	Load control	Auxiliary contact of the load contactor 1 is not closed	Alarm	Medium	Manual or Remote
2561 (0x0A01)	Load control	Auxiliary contact of the load contactor 1 is not opened	Alarm	Medium	Manual or Remote
2816 (0x0B00)	Predefined input acquisition	Earth leakage trip signal contact (SDV)	Alarm	Medium	Manual or Remote
2817 (0x0B01)	Predefined input acquisition	Control voltage presence contact	Alarm	Medium	Manual or Remote
2818 (0x0B02)	Predefined input acquisition	Surge protection status contact	Alarm	Medium	Manual or Remote
2819 (0x0B03)	Predefined input acquisition	Surge failure contact	Alarm	Medium	Manual or Remote

Code	Application	Description	Type	Priority	Reset Mode
2820 (0x0B04)	Predefined input acquisition	Switch-disconnector ON/OFF indication contact (OF)	Alarm	Medium	Manual or Remote
2821 (0x0B05)	Predefined input acquisition	Fuse blown indication contact	Alarm	Medium	Manual or Remote
2822 (0x0B06)	Predefined input acquisition	Emergency stop	Alarm	High	Manual or Remote
2823 (0x0B07)	Cooling system	Switchboard temperature contact	Alarm	Medium	Manual or Remote
2824 (0x0B08)	Cooling system	Switchboard ventilation contact	Alarm	Medium	Manual or Remote
2825 (0x0B09)	Cooling system	Switchboard door contact	Alarm	Medium	Manual or Remote
3328 (0x0D00)	General	Critical hardware modules discrepancy	Alarm	High	Auto
3329 (0x0D01)	General	Critical firmware modules discrepancy	Alarm	High	Auto
3330 (0x0D02)	General	Non-critical hardware modules discrepancy	Alarm	Medium	Auto
3331 (0x0D03)	General	Non-critical firmware modules discrepancy	Alarm	Medium	Auto
3333 (0x0D05)	Dual Settings	Dual settings 2-wire input discrepancy	Alarm	High	Auto

IO Module Commands

What's in This Chapter

List of IO Module Commands	244
Generic Commands	245
Application Commands	250

List of IO Module Commands

List of Commands

There are two types of command:

- generic commands which work independently of the application selected.
- application commands which are dedicated to an application. A command is only valid if the related application is configured.

The following table lists the available IO module commands, their corresponding application, command codes and user profiles. Follow the command execution procedures accordingly , page 56.

Application	Command	Command code	User profile
Generic	Change output state, page 245	1672	Administrator or Operator
Generic	Reset IO module alarms, page 245	41099	Administrator or Operator
Generic	Enable/Disable simple commands, page 245	41100	Administrator or Operator
Generic	Acknowledge latched output, page 246	41102	Administrator or Operator
Generic	Reset analog input minimum/maximum values, page 246	42890	Administrator or Operator
Generic	Get events, page 248	50560	No password
Cradle and drawer management	Preset cradle/drawer counters, page 250	41352	Administrator or Operator
Cradle and drawer management	Preset cradle/drawer regrease timers, page 250	41353	Administrator or Operator
Light control	Light control, page 251	42120	Administrator or Operator
Load control	Load control, page 251	42376	Administrator or Operator
Pulse counter management	Preset input pulse counter, page 252	42888	Administrator or Operator
Cooling system	Preset switchboard temperature threshold counter, page 253	42889	Administrator or Operator

IO Module Error Codes

The error codes generated by the IO module are the generic error codes , page 59.

Generic Commands

Change Output State

The command is used to change the state of IO module digital outputs assigned as user-defined outputs using the EcoStruxure Power Commission software.

To change the output state, set the command registers in the following way:

Address	Register	Unit	Type	Range	Description
0x1F3F	8000	–	INT16U	1672	Command code = 1672
0x1F40	8001	–	INT16U	13	Number of parameters (bytes) = 13
0x1F41	8002	–	INT16U	–	Destination = <ul style="list-style-type: none"> IO 1: 8193 (0x2001) IO 2: 8449 (0x2101)
0x1F42	8003	–	INT16U	1	Security type of the command
0x1F43– 0x1F44	8004– 8005	–	OCTET STRING	–	Password of the command: Administrator or Operator user profile password
0x1F45	8006	–	INT16U	1–3	Output number <ul style="list-style-type: none"> 1 = output 1 2 = output 2 3 = output 3
0x1F46	8007	–	INT16U	–	Value to set: <ul style="list-style-type: none"> 0x0000 = Change output state to 0 (OFF) 0x0100 = Change output state to 1 (ON)

Reset IO Module Alarm

The alarms can be read from the alarm status register, page 230.

To reset IO module alarms, set the command registers in the following way:

Address	Register	Unit	Type	Range	Description
0x1F3F	8000	–	INT16U	41099	Command code = 41099
0x1F40	8001	–	INT16U	10	Number of parameters (bytes) = 10
0x1F41	8002	–	INT16U	–	Destination = <ul style="list-style-type: none"> IO 1: 8193 (0x2001) IO 2: 8449 (0x2101)
0x1F42	8003	–	INT16U	1	Security type of the command
0x1F43– 0x1F44	8004– 8005	–	OCTET STRING	–	Password of the command: Administrator or Operator user profile password

Enable/Disable Simple Commands

To enable or disable the simple commands, set the command registers in the following way:

Address	Register	Unit	Type	Range	Description
0x1F3F	8000	–	INT16U	41100	Command code = 41100
0x1F40	8001	–	INT16U	11	Number of parameters (bytes) = 11

Address	Register	Unit	Type	Range	Description
0x1F41	8002	–	INT16U	–	Destination = <ul style="list-style-type: none"> IO 1: 8193 (0x2001) IO 2: 8449 (0x2101)
0x1F42	8003	–	INT16U	1	Security type of the command
0x1F43– 0x1F44	8004– 8005	–	OCTET STRING	–	Password of the command: Administrator or Operator user profile password
0x1F45	8006	–	INT16U	–	MSB: Enable or disable: <ul style="list-style-type: none"> 0 = Disable simple command 1 = Enable simple command LSB: 0 (not used)

Acknowledge Latched Output

To acknowledge the latched output, set the command registers in the following way:

Address	Register	Unit	Type	Range	Description
0x1F3F	8000	–	INT16U	41102	Command code = 41102
0x1F40	8001	–	INT16U	11	Number of parameters (bytes) = 11
0x1F41	8002	–	INT16U	–	Destination = <ul style="list-style-type: none"> IO 1: 8193 (0x2001) IO 2: 8449 (0x2101)
0x1F42	8003	–	INT16U	1	Security type of the command
0x1F43– 0x1F44	8004– 8005	–	OCTET STRING	–	Password of the command: Administrator or Operator user profile password
0x1F45	8006	–	INT16U	–	MSB: <ul style="list-style-type: none"> 0x01 = Digital output relay 1 0x02 = Digital output relay 2 0x03 = Digital output relay 3 0xFF = Unlatch all digital output LSB: 0 (not used)

Reset Analog Input Minimum/Maximum Values

The analog input maximum and minimum values can be read from the analog input registers, page 218.

To reset the minimum/maximum analog input values, set the command registers in the following way:

Address	Register	Unit	Type	Range	Description
0x1F3F	8000	–	INT16U	42890	Command code = 42890
0x1F40	8001	–	INT16U	10	Number of parameters (bytes) = 10
0x1F41	8002	–	INT16U	–	Destination = <ul style="list-style-type: none"> IO 1: 8193 (0x2001) IO 2: 8449 (0x2101)
0x1F42	8003	–	INT16U	1	Security type of the command
0x1F43– 0x1F44	8004– 8005	–	OCTET STRING	–	Password of the command: Administrator or Operator user profile password

Get Events Command

To get events, set the command registers in the following way:

Address	Register	Unit	Type	Range	Bit	Description
0x1F3F	8000	–	INT16U	50560	–	Command code = 50560
0x1F40	8001	–	INT16U	27	–	Number of parameters (bytes) = 27
0x1F41	8002	–	INT16U	–	–	Destination = <ul style="list-style-type: none"> IO 1: 8193 (0x2001) IO 2: 8449 (0x2101)
0x1F42	8003	–	INT16U	0	–	Security type of the command
0x1F43– 0x1F44	8004– 8005	–	OCTET STRING	–	–	Password of the command = 0 (no password required)
0x1F45	8006	–	–	–	–	Reserved
0x1F46	8007	–	INT16U	0, 2	–	Requested get event method , page 248: <ul style="list-style-type: none"> 0 = Most recent events 2 = Events before and up to a sequence number
0x1F47– 0x1F4A	8008–8011	–	–	–	–	Reserved
0x1F4B– 0x1F4C	8012–8013	–	INT32U	–	–	Requested event sequence number (for method 2 only)
0x1F4D	8014	–	INT16U	–	–	Requested event severity
					0–7	Reserved
					8	Low
					9	Medium
					10	High
11–15	Reserved					

Events are returned to command registers in the following way:

Address	Register	Unit	Type	Range	Bit	Description
0x1F53	8020	–	INT16U	50560	–	Last command code
0x1F54	8021	–	INT16U	–	–	Command status: <ul style="list-style-type: none"> 0 = Successful command Other value = command with error, page 58
0x1F55	8022	–	INT16U	–	–	Number of bytes returned
0x1F56	8023	–	–	–	–	Reserved
0x1F57	8024	–	INT16U	0, 2	–	Responded get event method: <ul style="list-style-type: none"> 0 = Most recent events 2 = Events before and up to a sequence number
0x1F5E	8031	–	INT16U	–	–	Responded event severity
					0–7	Reserved
					8	Low
					9	Medium
					10	High
11–15	Reserved					
0x1F5F	8032	–	INT16U	–	–	MSB: Number of events returned
					–	LSB: Remaining events <ul style="list-style-type: none"> 0 = No more events to get 1 = More events to get

Address	Register	Unit	Type	Range	Bit	Description
0x1F60	8033	–	INT16U	1013-25630	–	First event code, page 239
0x1F61–0x1F64	8034–8037	–	DATETIME	–	–	Timestamp of the first event
0x1F65	8038	–	INT16U	–	–	Timestamp quality of the first event
0x1F66–0x1F67	8039–8040	–	INT32U	–	–	First event sequence number
0x1F68	8041	–	INT16U	–	–	MSB: First event status <ul style="list-style-type: none"> • 1 = Occurrence • 2 = Completion • 3 = Pulse LSB: Reserved
0x1F69	8042	–	–	–	–	Reserved
0x1F6A	8043	–	INT16U	–	–	First event severity
					0–7	Reserved
					8	Low
					9	Medium
					10	High
11–15	Reserved					
0x1F6B–0x1F75	8044–8054	–	INT16U	–	–	Characteristics of event 2 (same as event 1)
0x1F76–0x1F80	8055–8065	–	INT16U	–	–	Characteristics of event 3 (same as event 1)
0x1F81–0x1F8B	8066–8076	–	INT16U	–	–	Characteristics of event 4 (same as event 1)
0x1F8C–0x1F96	8077–8087	–	INT16U	–	–	Characteristics of event 5 (same as event 1)
0x1F97–0x1FA1	8088–8098	–	INT16U	–	–	Characteristics of event 6 (same as event 1)
0x1FA2–0x1FAC	8099–8109	–	INT16U	–	–	Characteristics of event 7 (same as event 1)
0x1FAD–0x1FB7	8110–8120	–	INT16U	–	–	Characteristics of event 8 (same as event 1)
0x1FB8–0x1FC2	8121–8131	–	INT16U	–	–	Characteristics of event 9 (same as event 1)
0x1FC3–0x1FCD	8132–8142	–	INT16U	–	–	Characteristics of event 10 (same as event 1)

Get Events Procedure

The command allows to get events by using one of the two following methods:

- get the most recent events
- get events before and up to an event sequence number. The event sequence number is an event identifier defined by the device, and is available among the event characteristics. It can be used to sort the events in chronological order.

The command allows to get 10 events maximum for one or several severity levels.

- To get the 10 most recent events, use the method “get the most recent events”.
- If there are more than 10 events, use the other method “get events before and up to an event sequence number” to get rest of the events.

Example: Read all events:

The following diagram shows the steps to follow to read all events recorded in the device:

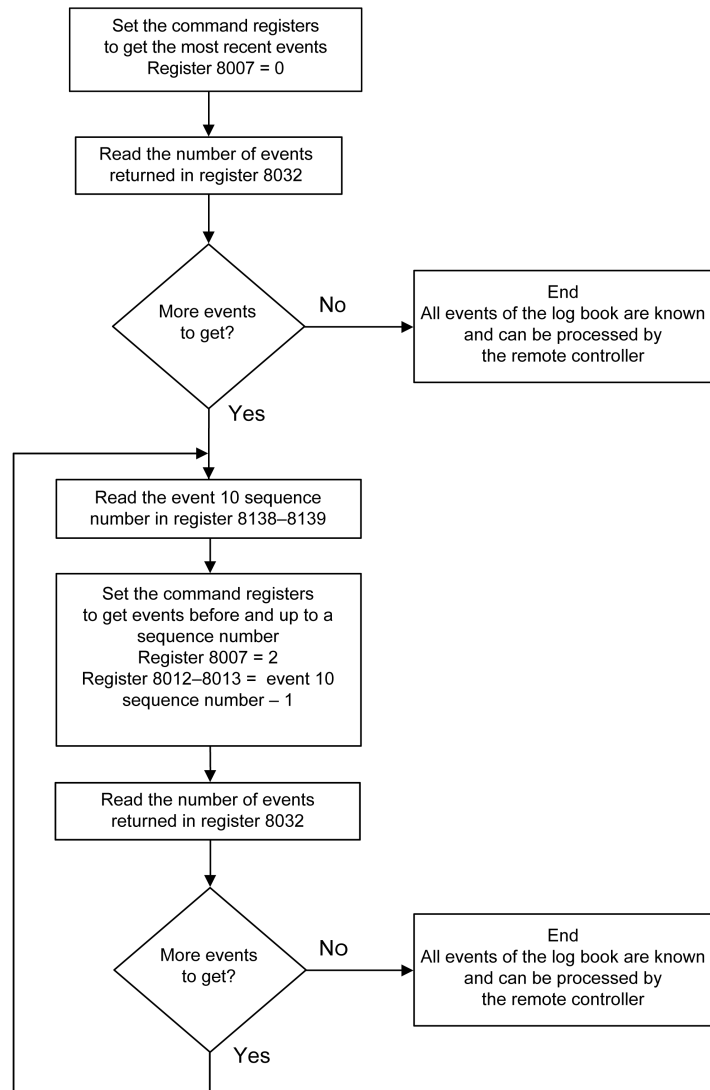

Application Commands

Preset Cradle/Drawer Counters

The cradle/drawer counter values can be read from the cradle management registers, page 233.

To preset the cradle or drawer counters, set the command registers in the following way:

Address	Register	Unit	Type	Range	Description
0x1F3F	8000	–	INT16U	41352	Command code = 41352
0x1F40	8001	–	INT16U	16	Number of parameters (bytes) = 16
0x1F41	8002	–	INT16U	–	Destination = <ul style="list-style-type: none"> • IO 1: 8193 (0x2001) • IO 2: 8449 (0x2101)
0x1F42	8003	–	INT16U	1	Security type of the command
0x1F43– 0x1F44	8004– 8005	–	OCTET STRING	–	Password of the command: Administrator or Operator user profile password
0x1F45	8006	–	INT16U	0–65535	Connected counter reset/preset: <ul style="list-style-type: none"> • 0–65534 = preset value of the connected counter • 65535 (0xFFFF) = do not preset the connected counter
0x1F46	8007	–	INT16U	0–65535	Disconnected counter reset/preset: <ul style="list-style-type: none"> • 0–65534 = preset value of the disconnected counter • 65535 (0xFFFF) = do not preset the disconnected counter
0x1F47	8008	–	INT16U	0–65535	Test counter reset/preset: <ul style="list-style-type: none"> • 0–65534 = preset value of the test counter • 65535 (0xFFFF) = do not preset the test counter

Preset Regrease Timers

To preset regrease timers, set the command registers in the following way:

Address	Register	Unit	Type	Range	Description
0x1F3F	8000	–	INT16U	41353	Command code = 41353
0x1F40	8001	–	INT16U	18	Number of parameters (bytes) = 18
0x1F41	8002	–	INT16U	–	Destination = <ul style="list-style-type: none"> • IO 1: 8193 (0x2001) • IO 2: 8449 (0x2101)
0x1F42	8003	–	INT16U	1	Security type of the command
0x1F43– 0x1F44	8004– 8005	–	OCTET STRING	–	Password of the command: Administrator or Operator user profile password
0x1F45– 0x1F46	8006–8007	–	INT16U	–	Operating time since last grease maintenance <ul style="list-style-type: none"> • 0–157766400 = preset value of regrease timer counter • 4294967295 (0xFFFFFFFF) = No preset
0x1F47– 0x1F48	8008–8009	–	INT32U	–	Operating time since last move in rack in position (delay from last disconnection) <ul style="list-style-type: none"> • 0–28944000 = preset value of remove timer • 4294967295 (0xFFFFFFFF) = No preset

Light Control

The light command status can be read from the light control registers, page 234.

To control the light, set the command registers in the following way:

Address	Register	Unit	Type	Range	Bit	Description
0x1F3F	8000	–	INT16U	42120	–	Command code = 42120
0x1F40	8001	–	INT16U	13	–	Number of parameters (bytes) = 13
0x1F41	8002	–	INT16U	–	–	Destination = IO 1: 8193 (0x2001)
0x1F42	8003	–	INT16U	1	–	Security type of the command
0x1F43– 0x1F44	8004– 8005	–	OCTET STRING	–	–	Password of the command: Administrator or Operator user profile password
0x1F45	8006	–	INT16U	–	–	MSB: State
					0	<ul style="list-style-type: none"> 0 = Light OFF 1 = Light ON
					1	<ul style="list-style-type: none"> 0 = without time delay 1 = with time delay
					–	LSB = Timer (MSB) 1–54000 seconds (if bit 1 in set state) Any value 0-0xffff (if bit 1 in reset state)
0x1F46	8007	–	INT16U	–	–	MSB = Timer (LSB) 1 to 54000 seconds (if bit 1 is in set state) Any value 0-0xffff (if bit 1 is in reset state) LSB = 0 (not used)

Load Control

The load command status can be read from the load control registers, page 235.

To control the load, set the command registers in the following way:

Address	Register	Unit	Type	Range	Bit	Description
0x1F3F	8000	–	INT16U	42376	–	Command code = 42376
0x1F40	8001	–	INT16U	13	–	Number of parameters (bytes) = 13
0x1F41	8002	–	INT16U	–	–	Destination = IO 1: 8193 (0x2001)
0x1F42	8003	–	INT16U	1	–	Security type of the command
0x1F43– 0x1F44	8004– 8005	–	OCTET STRING	–	–	Password of the command: Administrator or Operator user profile password
0x1F45	8006	–	INT16U	–	–	MSB: State
					0	<ul style="list-style-type: none"> 0 = Load OFF 1 = Load ON
					1	<ul style="list-style-type: none"> 0 = without time delay 1 = with time delay
					–	LSB = Timer (MSB) 1–54000 seconds (if bit 1 in set state) Any value 0-0xffff (if bit 1 in reset state)

Address	Register	Unit	Type	Range	Bit	Description
0x1F46	8007	–	INT16U	–	–	MSB = Timer (LSB) 1–54000 seconds (if bit 1 in set state) Any value 0-0xffff (if bit 1 in reset state)
					–	LSB = 0 (not used)

Preset Input Pulse Counters

To preset pulse counters, set the command registers in the following way:

Address	Register	Unit	Type	Range	Description
0x1F3F	8000	–	INT16U	42888	Command code = 42888
0x1F40	8001	–	INT16U	34	Number of parameters (bytes) = 34 NOTE: The number of parameters corresponds to the number of bytes of the 17 registers 8001–8015 and 8022–8023. The bytes of the registers 8016–8021 are not counted as command parameters.
0x1F41	8002	–	INT16U	–	Destination = <ul style="list-style-type: none"> IO 1: 8193 (0x2001) IO 2: 8449 (0x2101)
0x1F42	8003	–	INT16U	1	Security type of the command
0x1F43– 0x1F44	8004– 8005	–	OCTET STRING	–	Password of the command: Administrator or Operator user profile password
0x1F45– 0x1F46	8006– 8007	–	INT32U	0–4294967295	I1 pulse counter reset/preset: <ul style="list-style-type: none"> 0–4294967294 = preset value of the I1 pulse counter 4294967295 (0xFFFFFFFF) = do not preset the I1 pulse counter
0x1F47– 0x1F48	8008– 8009	–	INT32U	0–4294967295	I2 pulse counter reset/preset: <ul style="list-style-type: none"> 0–4294967294 = preset value of the I2 pulse counter 4294967295 (0xFFFFFFFF) = do not preset the I2 pulse counter
0x1F49– 0x1F4A	8010– 8011	–	INT32U	0–4294967295	I3 pulse counter reset/preset: <ul style="list-style-type: none"> 0–4294967294 = preset value of the I3 pulse counter 4294967295 (0xFFFFFFFF) = do not preset the I3 pulse counter
0x1F4B– 0x1F4C	8012– 8013	–	INT32U	0–4294967295	I4 pulse counter reset/preset: <ul style="list-style-type: none"> 0–4294967294 = preset value of the I4 pulse counter 4294967295 (0xFFFFFFFF) = do not preset the I4 pulse counter
0x1F4D– 0x1F4E	8014– 8015	–	INT32U	0–4294967295	I5 pulse counter reset/preset: <ul style="list-style-type: none"> 0–4294967294 = preset value of the I5 pulse counter 4294967295 (0xFFFFFFFF) = do not preset the I5 pulse counter
0x1F4F	8016	–	–	–	Must be set to 0 (factory setting).
0x1F50	8017	–	–	–	Must be set to 8019 (factory setting).
0x1F51	8018	–	–	–	Must be set to 8020 (factory setting).
0x1F52	8019	–	–	–	Must be set to 8021 (factory setting).
0x1F53	8020	–	–	–	Must be set to 0.

Address	Register	Unit	Type	Range	Description
0x1F54	8021	–	–	–	Must be set to 0.
0x1F55– 0x1F56	8022– 8023	–	INT32U	0–4294967295	l6 pulse counter reset/preset: <ul style="list-style-type: none"> 0–4294967294 = preset value of the l6 pulse counter 4294967295 (0xFFFFFFFF) = do not preset the l6 pulse counter

Preset Switchboard Temperature Threshold Counters

To preset switchboard temperature threshold counters, set the command registers in the following way:

Address	Register	Unit	Type	Range	Description
0x1F3F	8000	–	INT16U	42889	Command code = 42889
0x1F40	8001	–	INT16U	16	Number of parameters (bytes) = 16
0x1F41	8002	–	INT16U	–	Destination = <ul style="list-style-type: none"> IO 1: 8193 (0x2001) IO 2: 8449 (0x2101)
0x1F42	8003	–	INT16U	1	Security type of the command
0x1F43– 0x1F44	8004– 8005	–	OCTET STRING	–	Password of the command: Administrator or Operator user profile password
0x1F45	8006	–	INT16U	0–65535	Switchboard temperature threshold 1 counter reset/preset: <ul style="list-style-type: none"> 0–65534 = preset value of the switchboard temperature threshold 1 counter 65535 (0xFFFF) = do not preset the counter
0x1F46	8007	–	INT16U	0–65535	Switchboard temperature threshold 2 counter reset/preset: <ul style="list-style-type: none"> 0–65534 = preset value of the switchboard temperature threshold 2 counter 65535 (0xFFFF) = do not preset the counter
0x1F47	8008	–	INT16U	0–65535	Switchboard temperature threshold 3 counter reset/preset: <ul style="list-style-type: none"> 0–65534 = preset value of the switchboard temperature threshold 3 counter 65535 (0xFFFF) = do not preset the counter

IFM Interface Data for MasterPact MTZ Circuit Breakers

What's in This Part

IFM Interface Registers.....	255
IFM Interface Commands.....	261

IFM Interface Registers

What's in This Chapter

IFM Interface Identification	256
Modbus Network Parameters	259

IFM Interface Identification

IFM Interface Firmware Revision

The IFM interface firmware revision starts at register 11776 and has a maximum length of eight registers.

The firmware revision is an ASCII string using the format XXX.YYY.ZZZ with:

- XXX = major version (000–127)
- YYY = minor version (000–255)
- ZZZ = revision number (000–255)

The NULL character ends the revision number.

Address	Register	RW	Unit	Type	Range	Description
0x2DDF– 0x2DEE	11744– 11759	R	–	OCTET STRING	–	Device family
0x2DEF– 0x2DF6	11760– 11767	R	–	OCTET STRING	–	Product range
0x2DF7– 0x2DFE	11768– 11775	R	–	OCTET STRING	–	Product model
0x2DFF– 0x2E04	11776– 11781	R	–	OCTET STRING	–	Firmware revision

Serial Number for IFM Interface TRV00210 or STRV00210

The serial number of IFM interface TRV00210 or STRV00210 is composed of a maximum of 11 alphanumeric characters with the following format: PPLYWWDnnnn.

- PP = plant code
- YY = year of fabrication (05–99)
- WW = week of fabrication (01–53)
- D = day of fabrication (1–7)
- nnnn = production number of the device on the day (0001–9999)

A read request of six registers is necessary to read the IFM interface serial number.

Address	Register	RW	Unit	Type	Range	Description
0x2E07	11784	R	–	OCTET STRING	–	'PP'
0x2E08	11785	R	–	OCTET STRING	'05'–'99'	'YY'
0x2E09	11786	R	–	OCTET STRING	'01'–'53'	'WW'
0x2E0A	11787	R	–	OCTET STRING	D: '1'–'7' n: '0'–'9'	'Dn'
0x2E0B	11788	R	–	OCTET STRING	'00'–'99'	'nn'
0x2E0C	11789	R	–	OCTET STRING	'0'–'9'	'n' (the NULL character ends the serial number)

Serial Number for IFM Interface LV434000

The serial number of IFM interface LV434000 is composed of a maximum of 17 alphanumeric characters with the following format: P P P P P P Y Y W W D L n n n n 0.

- P P P P P P = plant code (example: BATAM plant code is 0000HL)
- Y Y = year of fabrication (05–99)
- W W = week of fabrication (01–53)
- D = day of fabrication (1–7)
- L = line or machine number (0-9 or a-z)
- n n n n = production number of the device on the day (0001–9999)

A read request of ten registers is necessary to read the IFM interface serial number.

Address	Register	RW	Unit	Type	Range	Description
0x2E5C-0x2E5E	11869-11871	R	–	OCTET STRING	–	'PPPPPP'
0x2E5F	11872	R	–	OCTET STRING	'05'–'99'	'YY'
0x2E60	11873	R	–	OCTET STRING	'01'–'53'	'WW'
0x2E61	11874	R	–	OCTET STRING	D: '1'–'7' L: '0'–'9' or 'a'–'z'	'DL'
0x2E62	11875	R	–	OCTET STRING	'00'–'99'	'nn'
0x2E63	11876	R	–	OCTET STRING	'00'–'99'	'nn'
0x2E64-0x2E65	11877-11878	R	–	OCTET STRING	'0'	'0' (the NULL character ends the serial number)

Current Date and Time

Address	Register	RW	Unit	Type	Range	Description
0x2E73–0x2E76	11892–11895	R-WC	–	DATETIME	–	Current date and time in DATETIME format
0x2E77–0x2E78	11896–11897	R	Seconds	INT32U	0x00–0xFFFF-FFF	Number of seconds counted since last start

Product Identification

Address	Register	RW	Unit	Type	Range	Description
0x2E7C	11901	R	–	INT16U	–	Product identification = 15146 for the IFM interface

Hardware Revision for IFM Interface LV434000

The hardware revision of IFM interface LV434000 starts at register 11922 and has a maximum length of ten registers.

The hardware revision is an ASCII string using the format XXX.YYY.ZZZ with:

- XXX = major version (000–127)
- YYY = minor version (000–255)

- ZZZ = revision number (000–255)

The NULL character ends the revision number.

Address	Register	RW	Unit	Type	Range	Description
0x2E91– 0x2E96	11922– 11927	R	–	OCTET STRING	–	Hardware revision

Read Device Identification

The Read Device Identification function is used to access in a standardized manner the information required to identify a device clearly. The description is made up of a set of objects (ASCII character strings).

A complete description of the Read Device Identification function is available at www.modbus.org.

The coding for the identification of the IFM interface is the following:

Name	Type	Description
Vendor name	OCTET STRING	'Schneider Electric' (18 characters)
Product code	OCTET STRING	'LV434000' or 'TRV00210' (1) or 'STRV00210'
Firmware revision	OCTET STRING	'XXX.YYY.ZZZ' from IFM interface revision 002.002.000
Vendor URL	OCTET STRING	'https://www.se.com' (33 characters)
Product name	OCTET STRING	'ULP/Modbus-SL communication interface module'

(1) Product code returns 'TRV00210-L' when IFM interface TRV00210 is loaded with IFM legacy firmware. For more information, refer to *MasterPact Modbus Legacy User Guide*.

IMU Identification

Identification of the IMU can be set by using the *EcoStruxure Power Commission software*, page 18. When not programmed, the IMU identification registers return 0 (0x0000).

The FDM121 display displays the first 14 characters of the IMU name.

Address	Register	RW	Unit	Type	Range	Description
0x2801– 0x2820	10242– 10273	R-WC	–	OCTET STRING	–	User application name Maximum length is 64 characters.

Address	Register	RW	Unit	Type	Range	Description
0x2E2F– 0x2E38	11824– 11833	R	–	OCTET STRING	–	Vendor name = 'Schneider Electric'
0x2E39– 0x2E42	11834– 11843	R	–	OCTET STRING	–	Product Code = 'LV434000' or 'TRV00210' or 'STRV00210'
0x2E43– 0x2E44	11844– 11845	R	–	OCTET STRING	–	Reserved

Modbus Network Parameters

Modbus Locking Pad Position

Address	Register	RW	Unit	Type	Range	Description
0x2E72	11891	R	–	INT16U	1–3	Modbus locking pad position <ul style="list-style-type: none"> 1 = Modbus locking pad is on the locked position 3 = Modbus locking pad is on the open position

Validity Duration of Data

Address	Register	RW	Unit	Type	Range	Description
0x306A	12395	R	s	INT16U	5–300 (in step of 5 s)	Duration of validity of data in the dataset

Auto-Speed Sensing State

Address	Register	RW	Unit	Type	Range	Description
0x306E	12399	R	–	INT16U	0–1	Auto-Speed sensing state <ul style="list-style-type: none"> 0 = Auto-Speed sensing is disabled 1 = Auto-Speed sensing is enabled (factory setting)

IFM Interface Modbus Address

Address	Register	RW	Unit	Type	Range	Description
0x306F	12400	R	–	INT16U	1–99	IFM interface Modbus address

Modbus Parity

Address	Register	RW	Unit	Type	Range	Description
0x3070	12401	R	–	INT16U	1–3	Modbus parity <ul style="list-style-type: none"> 1 = no parity (none) 2 = even parity (factory setting) 3 = odd parity

Modbus Baud Rate

Address	Register	RW	Unit	Type	Range	Description
0x3071	12402	R	–	INT16U	5–8	Modbus Baud rate <ul style="list-style-type: none"> 5 = 4800 Baud 6 = 9600 Baud 7 = 19200 Baud (factory setting) 8 = 38400 Baud

Number of Stop Bits

Address	Register	RW	Unit	Type	Range	Description
0x3072	12403	R	–	INT16U	0–5	Number of stop bits <ul style="list-style-type: none">• 0 = no change• 1 = standard Modbus• 2 = 1/2 stop bit• 3 = 1 stop bit• 4 = 1 and 1/2 stop bit• 5 = 2 stop bits

IFM Interface Commands

What's in This Chapter

List of IFM Interface Commands	261
IFM Interface Commands.....	262

List of IFM Interface Commands

List of Commands

The following table lists the IFM interface commands, their corresponding command codes and user profiles. Follow the command execution procedures accordingly, page 56.

Command	Command code	User profile
Get current time, page 262	768	No password required
Set absolute time, page 262	769	No password required
Read IMU Name and Location, page 263	1024	No password required
Write user application name, page 263	1032	No password required
Set Validity Duration of Data, page 264	41868	Administrator, Services, Engineer, or Operator

Error Codes

Error codes generated by the IFM interface are the generic error codes, page 59.

IFM Interface Commands

Get Current Time

The get current time command is not hardware protected. When the arrow of the Modbus locking pad (located on the front panel of the IFM interface) points to the closed padlock, the get current time command is still enabled.

To get the current time for all modules, set the command registers in the following way:

Address	Register	Unit	Type	Range	Description
0x1F3F	8000	–	INT16U	768	Command code = 768
0x1F40	8001	–	INT16U	10	Number of parameters (bytes) = 10
0x1F41	8002	–	INT16U	768	Destination = 768 (0x0300)
0x1F42	8003	–	INT16U	0	Security type of the command
0x1F43– 0x1F44	8004–8005	–	OCTET STRING	0	Password of the command = 0 (no password required)

The following registers contain the time data:

- Register 8023 holds the month in the MSB, the day in the LSB.
- Register 8024 holds the year offset in the MSB (add 2000 to get the year) and the hour in the LSB.
- Register 8025 holds the minutes in the MSB, the seconds in the LSB.
- Register 8026 holds the milliseconds.

Set Absolute Time

The set absolute time command is not hardware protected. When the arrow of the Modbus locking pad (located on the front panel of the IFM interface) points to the closed padlock, the set absolute time command is still enabled.

To set the absolute time for all the IMU modules, set the command registers in the following way:

Address	Register	Unit	Type	Range	Description
0x1F3F	8000	–	INT16U	769	Command code = 769
0x1F40	8001	–	INT16U	18	Number of parameters (bytes) = 18
0x1F41	8002	–	INT16U	768	Destination = 768 (0x0300)
0x1F42	8003	–	INT16U	0	Security type of the command
0x1F43– 0x1F44	8004–8005	–	OCTET STRING	0	Password of the command = 0 (no password required)
0x1F45	8006	–	INT16U	–	MSB = month (1–12) LSB = day in the month (1–31)
0x1F46	8007	–	INT16U	–	MSB = year (0–99, 0 meaning year 2000) LSB = hour (0–23)
0x1F47	8008	–	INT16U	–	MSB = minute (0–59) LSB = second (0–59)
0x1F48	8009	ms	INT16U	0–999	Milliseconds (0–999)

In case of 24 Vdc power loss, date and time counter is reset and will restart at January 1 2000. It is therefore mandatory to set absolute time for all the IMU modules after recovering the 24 Vdc power supply.

Furthermore, due to the clock drift of each IMU module, it is mandatory to set absolute time for all the IMU modules periodically. Recommended period is at least every 15 minutes.

Read IMU Name and Location

The FDM121 display displays the IMU name but it is limited to the first 14 characters.

To read the IMU name and location, set the command registers in the following way:

Address	Register	Unit	Type	Range	Description
0x1F3F	8000	–	INT16U	1024	Command code = 1024
0x1F40	8001	–	INT16U	16	Number of parameters (bytes) = 16
0x1F41	8002	–	INT16U	768	Destination = 768 (0x0300)
0x1F42	8003	–	INT16U	0	Security type of the command
0x1F43– 0x1F44	8004–8005	–	OCTET STRING	0	Password of the command = 0 (no password required)
0x1F45– 0x1F46	8006–8007	–	INT32U	–	17039489 = read IMU name (load 0x0104 into register 8006, 0x0081 into 8007) 17039490 = read IMU location (load 0x0104 into register 8006, 0x0082 into 8007)
0x1F47	8008	–	INT16U	2048	2048

The IMU name and location are returned to command registers in the following way:

Address	Register	Unit	Type	Range	Description
0x1F53	8020	–	INT16U	1024	Last Command Code
0x1F54	8021	–	INT16U	–	Command status 0 = command succeeded Otherwise, command failed
0x1F55	8022	–	INT16U	–	Number of bytes returned (0 if command failed)
0x1F56	8023	–	OCTET STRING	–	If command succeeded MSB = first character of IMU name or location LSB = second character of IMU name or location
0x1F57– 0x1F6D	8024–8046	–	OCTET STRING	–	Depends on the length of the IMU name or location and ends by the NULL character 0x00

Write User Application Name

The user application name can be read from registers 10242 to 10273 , page 258.

The FDM121 display displays the IMU name but it is limited to the first 14 characters.

To write the user application name, set the command registers the following way:

Address	Register	Unit	Type	Range	Description
0x1F3F	8000	–	INT16U	1032	Command code = 1032
0x1F40	8001	–	INT16U	–	Number of parameters (bytes) = depends on the length of the user application name (up to 46 characters)
0x1F41	8002	–	INT16U	0	Destination = 0 (0x0000)

Address	Register	Unit	Type	Range	Description
0x1F42	8003	–	INT16U	0	Security type of the command
0x1F43– 0x1F44	8004–8005	–	OCTET STRING	0	Password of the command = 0 (no password required)
0x1F45– 0x1F46	8006–8007	–	INT32U	–	17039366 = User application name (load 0x0104 into register 8006, 0x0081 into 8007)
0x1F47	8008	–	INT16U	2048	2048
0x1F48	8009	–	OCTET STRING	–	<ul style="list-style-type: none"> • MSB = First character of the user application name • LSB = Second character of the user application name
0x1F49– 0x1F5F	8010–8038	–	OCTET STRING	–	Depends on the length of the user application name and ends by the NULL character 0x00

Set Validity Duration of Data

This command allows to set the validity duration of data in the standard and legacy datasets.

The validity duration of data can be read in a register *Validity Duration of Data*, page 259.

To set the validity duration of data, set the command registers in the following way:

Address	Register	Unit	Type	Range	Description
0x1F3F	8000	–	INT16U	41868	Command code = 41868
0x1F40	8001	–	INT16U	12	Number of parameters (bytes) = 12
0x1F41	8002	–	INT16U	769	Destination = 769 (0x0301)
0x1F42	8003	–	INT16U	1	Security type of the command
0x1F43– 0x1F44	8004–8005	–	OCTET STRING	–	Password of the command: Administrator, Services, Engineer, or Operator user profile password
0x1F45	8006	s	INT16U	5–300 (in step of 5 s)	Validity duration of data Factory setting: 10 s

IFE/EIFE Interface Data for MasterPact MTZ Circuit Breakers

What's in This Part

IFE/EIFE Interface Registers.....	266
IFE/EIFE Interface Commands.....	275

IFE/EIFE Interface User Guides

For more information about IFE/EIFE functions, refer to the relevant document:

- [DOCA0142EN](#) IFE – Ethernet Interface for One Circuit Breaker – User Guide
- [DOCA0106EN](#) EIFE – Embedded Ethernet Interface for One MasterPact MTZ Drawout Circuit Breaker – User Guide
- [DOCA0084EN](#) IFE – Ethernet Switchboard Server – User Guide

IFE/EIFE Interface Registers

What's in This Chapter

IFE/EIFE Interface Identification and Status Registers.....	267
EIFE Interface Specific Registers	272
IP Network Parameters	274

IFE/EIFE Interface Identification and Status Registers

IFE/EIFE Interface Firmware Revision

The IFE/EIFE interface firmware revision starts at register 11776 and has a maximum length of eight registers.

The firmware revision is an ASCII string using the format XXX.YYY.ZZZ with:

- XXX = major version (000–127)
- YYY = minor version (000–255)
- ZZZ = revision number (000–255)

The NULL character ends the revision number.

Address	Register	RW	Unit	Type	Range	Description
0x2DDF– 0x2DEE	11744–11759	R	–	OCTET STRING	–	Device family
0x2DEF– 0x2DF6	11760–11767	R	–	OCTET STRING	–	Product range
0x2DF7– 0x2DFE	11768–11775	R	–	OCTET STRING	–	Product model
0x2DFF– 0x2E04	11776–11781	R	–	OCTET STRING	–	Firmware revision

IFE/EIFE Interface Hardware Revision

The IFE/EIFE interface hardware revision starts at register 11784 and has a maximum length of eight registers.

The hardware revision is an ASCII string using the format XXX.YYY.ZZZ with:

- XXX = major version (000–127)
- YYY = minor version (000–255)
- ZZZ = revision number (000–255)

The NULL character ends the revision number.

Address	Register	RW	Unit	Type	Range	Description
0x2E07– 0x2E0C	11784–11789	R	–	OCTET STRING	–	Hardware revision

IMU Identification

Identification of the IMU can be set by using the [EcoStruxure Power Commission software](#), page 18. When not programmed, the IMU identification registers return 0 (0x0000).

The FDM121 display displays the first 14 characters of the IMU name.

Address	Register	RW	Unit	Type	Range	Description
0x2801– 0x2820	10242–10273	R-WC	–	OCTET STRING	–	User application name Device name used for acquiring the IP address using DHCP and also the friendly name on DPWS device discovery. Example: 'IFE-0A129F' Maximum length is 64 characters.

Address	Register	RW	Unit	Type	Range	Description
0x2E2F– 0x2E38	11824–11833	R	–	OCTET STRING	–	Vendor name = 'Schneider Electric'
0x2E39– 0x2E42	11834–11843	R	–	OCTET STRING	–	Product code: <ul style="list-style-type: none"> 'LV434001' or 'LV434010' = IFE-Ethernet com Modbus TCP/IP 'LV434002' or 'LV434011' = IFE-Ethernet com Modbus TCP/IP master 'LV851001' = EIFE Embedded Ethernet interface
0x2E43– 0x2E44	11844–11845	–	–	–	–	Reserved

Locking Pad Position

Address	Register	RW	Unit	Type	Range	Description
0x2E72	11891	R	–	INT16U	1,3	Locking pad position <ul style="list-style-type: none"> 1 = locking pad is in the locked position 3 = locking pad is in the unlocked position

Current Date and Time

Address	Register	RW	Unit	Type	Range	Description
0x2E73– 0x2E76	11892–11895	R-WC	–	DATETIME	–	Current date and time in DATETIME format
0x2E77– 0x2E78	11896– 11897	R	Seconds	INT32U	0x00– 0xFFFFFFFF- F	Number of seconds counted since last start

Product Identification

Address	Register	RW	Unit	Type	Range	Description
0x2E7C	11901	R	–	INT16U	17100– 17101	Product identification: <ul style="list-style-type: none"> 17100 for IFE Ethernet interface for one circuit breaker ('LV434001' or 'LV434010') 17101 for IFE Ethernet switchboard server ('LV434002' or 'LV434011') 17107 for EIFE embedded Ethernet interface ('LV851001')

Validity Duration of Data

Address	Register	RW	Unit	Type	Range	Description
0x306A	12395	R	s	INT16U	5–300 (in step of 5 s)	Duration of validity of data in the dataset

Read Device Identification

The Read Device Identification function is used to access in a standardized manner the information required to identify a device clearly. The description is made up of a set of objects (ASCII character strings).

A complete description of the Read Device Identification function is available at www.modbus.org.

The coding for the identification of the IFE/EIFE interface is the following:

Name	Type	Description
Vendor name	OCTET STRING	'Schneider Electric' (18 characters)
Product code	OCTET STRING	<ul style="list-style-type: none"> 'LV434001' or 'LV434010' 'LV434002' or 'LV434011' 'LV851001' (EIFE)
Firmware revision	OCTET STRING	'XXX.YYY.ZZZ'
Vendor URL	OCTET STRING	'www.se.com' (26 characters)
Product name	OCTET STRING	<ul style="list-style-type: none"> For IFE Ethernet interface for one circuit breaker (LV434001 or LV434010): 'Ethernet interface for LV breakers' For IFE Ethernet switchboard server (LV434002 or LV434011): 'Ethernet interface for LV breakers + gateway' For EIFE Ethernet interface (LV851001): 'Embedded Ethernet interface for LV breakers'
Family	OCTET STRING	'Gateway and server'
Range	OCTET STRING	'Enerlin'X'
Model	OCTET STRING	'IFE Ethernet interface', 'IFE/Gateway', or 'EIFE Ethernet interface'
Product ID	INT16U	Product ID of the core of IMU: <ul style="list-style-type: none"> 17100 = IFE without gateway 17101 = IFE with gateway 17107 = EIFE

MAC Address of the IFE/EIFE Server

Address	Register	RW	Unit	Type	Range	Description
0x2E7D– 0x2E7F	11902– 11904	R	–	INT16U	–	MAC address of the IFE/EIFE interface coded over 3 registers (6 bytes) in hexadecimal. Example: The MAC address 00:80:F4:02:12:34 (or 00-80-F4-02-12-34) is coded in hexadecimal as follows: 0080F4021234 (0x00 0x80 0xF4 0x02 0x12 0x34).

Manufacturing Date and Time

Address	Register	RW	Unit	Type	Range	Description
0x2E89– 0x2E8C	11914– 11917	R	–	DATETIME	–	Manufacturing date and time

IFE Interface Serial Number

The IFE interface serial number is composed of a maximum of 11 alphanumeric characters with the following format: PPYYWWDnnnn.

- PP = plant code
- YY = year of fabrication (05–99)
- WW = week of fabrication (01–53)
- D = day of fabrication (1–7)
- nnnn = production number of the device on the day (0001–9999)

A read request of 6 registers is necessary to read the IFE interface serial number.

Address	Register	RW	Unit	Type	Range	Description
0x02E91	11922	R	–	OCTET STRING	–	'PP'
0x02E92	11923	R	–	OCTET STRING	'05'–'99'	'YY'
0x02E93	11924	R	–	OCTET STRING	'01'–'53'	'WW'
0x02E94	11925	R	–	OCTET STRING	D: '1'–'7' n: '0'–'9'	'Dn'
0x02E95	11926	R	–	OCTET STRING	'00'–'99'	'nn'
0x02E96	11927	R	–	OCTET STRING	'0'–'9'	'n' (the NULL character ends the serial number)

EIFE Interface Serial Number

The EIFE interface serial number is composed of a maximum of 16 alphanumeric characters with the following format: PPPPPYYWWDLnnnn.

- PPPPPP = plant code
- YY = year of fabrication (05–99)
- WW = week of fabrication (01–53)
- D = day of fabrication (1–7)
- L = Line or machine number (0–9 or a–z)
- nnnn = production number of the device on the day (0001–9999)

A read request of 8 registers is necessary to read the EIFE interface serial number.

Address	Register	RW	Unit	Type	Range	Description
0x02E91– 0x02E93	11922– 11924	R	–	OCTET STRING	–	'PPPPPP'
0x02E94	11925	R	–	OCTET STRING	'05'–'99'	'YY'
0x02E95	11926	R	–	OCTET STRING	'01'–'53'	'WW'
0x02E96	11927	R	–	OCTET STRING	D: '1'–'7' L: '0'–'9' or 'a'–'z'	'DL'
0x02E97– 0x02E98	11928– 11929	R	–	OCTET STRING	'0000'–'9- 999'	'nnnn'

Modbus Parameters of the IFE Server

These parameters are valid for the IFE switchboard server only.

Address	Register	RW	Unit	Type	Range	Description
0x306F	12400	R	–	INT16U	–	Modbus address of IFE server (always 255)
0x3070	12401	R	–	INT16U	1–3	Modbus parity: <ul style="list-style-type: none"> • 1 = no parity • 2 = even parity (factory setting) • 3 = odd parity
0x3071	12402	R	–	INT16U	5–8	Modbus Baud rate: <ul style="list-style-type: none"> • 5 = 4800 Baud • 6 = 9600 Baud • 7 = 19,200 Baud (factory setting) • 8 = 38,400 Baud
0x3072	12403	R	–	INT16U	1,3,5	Number of stop bits: <ul style="list-style-type: none"> • 1 = Auto (factory setting) • 3 = 1 stop bit • 5 = 2 stop bits

Time Synchronization

Address	Register	RW	Unit	Type	Range	Description
0x3098– 0x30B7	12441– 12472	R	–	OCTET STRING	–	The type of source use for time synchronization: <ul style="list-style-type: none"> • ‘Auto–SNTP’ • ‘Manual–Modbus’ • ‘Manual–ULP’ • ‘Manual–Webpage’
0x30B8– 0x30BB	12473– 12476	R	–	DATETIME	–	Date and time of last time synchronization
0x30BC– 0x30BD	12477– 12478	R	s	FLOAT32	–	Time since last time synchronization
0x30BE	12479	R	–	INT16U	0–2	Status of automatic time synchronization: <ul style="list-style-type: none"> • 0 = SNTP disabled • 1 = SNTP failed • 2 = SNTP succeeded
0x30BF	12480	R	–	INT16	–	SNTP fails count

EIFE Interface Specific Registers

Cradle Alarms

Address	Register	RW	Unit	Type	Range	Bit	Description
0x3997	14744	R	–	INT16U	–	–	Quality of each bit of register 14745: <ul style="list-style-type: none"> • 0 = Invalid • 1 = Valid
0x3998	14745	R	–	INT16U	–	–	Cradle management alarms register
						0	Cradle position discrepancy
						1	No racking-out operation for the last 11 months
						2	Cradle has reached its max number of operation
						3	Remaining service life of cradle is below alarm threshold
						4	New MicroLogic control unit has been detected
						5–15	Reserved

Cradle Management

The table describes the registers related to the Cradle management function performed by EIFE embedded Ethernet interface.

Address	Register	RW	Unit	Type	Range	Bit	Description
0x3BC3	15300	R-RC	–	INT16U	–	–	Quality of each bit of register 15301: <ul style="list-style-type: none"> • 0 = Invalid • 1 = Valid
0x3BC4	15301	R-RC	–	INT16U	–	–	Cradle status
						0–7	Reserved
						8	Device in disconnected position (CD)
						9	Device in connected position (CE)
						10	Device in the test position (CT)
11–15	Reserved						
0x3BC5– 0x3BC6	15302– 15303	R-RC- WC	–	INT32U	0–65534	–	Cradle connected position counter This counter increments for each rising edge of the cradle connected position
0x3BC7– 0x3BC8	15304– 15305	R-RC- WC	–	INT32U	0–65534	–	Cradle disconnected position counter This counter increments for each rising edge of the cradle disconnected position
0x3BC9– 0x3BCA	15306– 15307	R-RC- WC	–	INT32U	0–65534	–	Cradle test position counter This counter increments for each rising edge of the cradle test position
0x3BCB– 0x3BCE	15308– 15311	R-RC	–	DATETIME	–	–	Timestamp of the last change for the cradle connected position
0x3BCF– 0x3BD2	15312– 15315	R-RC	–	DATETIME	–	–	Timestamp of the last change for the cradle disconnected position
0x3BD3– 0x3BD6	15316– 15319	R-RC	–	DATETIME	–	–	Timestamp of the last change for the cradle test position
0x3BD7– 0x3BD8	15320– 15321	R-WC	–	INT32U	–	–	Operating time since last grease maintenance

Address	Register	RW	Unit	Type	Range	Bit	Description
0x3BD9– 0x3BDA	15322– 15323	R-WC	–	INT32U	–	–	Operating time since last move connected position
0x3BDB	15324	R	–	INT16U	0-65534	–	Cradle contact regrease counter
0x3BDC– 0x3BE0	15325– 15329	–	–	–	–	–	Reserved

IP Network Parameters

Network Parameters

Address	Register	RW	Unit	Type	Range	Description
0x27FF– 0x2800	10240– 10241	R	–	INT32	0–1	Network configuration mode: <ul style="list-style-type: none"> • 0 = IPv4 only • 1 = IPv4 and IPv6

IPv4 Parameters

Address	Register	RW	Unit	Type	Range	Description
0x2823– 0x2824	10276– 10277	R-WC	–	INT32U	0–2	IPv4 address acquisition mode, set by using the EcoStruxure Power Commission software: <ul style="list-style-type: none"> • 0 = Static • 1 = BootP • 2 = DHCP
0x2825– 0x2826	10278– 10279	R	–	INT32U	–	IPv4 address acquisition status: <ul style="list-style-type: none"> • 0 = IP acquisition successful • 1 = IP acquisition in progress • 2 = Acquired IP address is duplicated • 3 = Error in IP acquisition
0x2827– 0x2828	10280– 10281	R-WC	–	INT32U	–	IPv4 address of IFE/EIFE interface Example: 169.254.1.1 Register 10280 = 0xA9FE Register 10281 = 0x0101
0x2829– 0x282A	10282– 10283	R-WC	–	INT32U	–	IPv4 subnet mask Example: 255.255.0.0 Register 10282 = 0xFFFF Register 10283 = 0x0000
0x282B– 0x282C	10284– 10285	R-WC	–	INT32U	–	IPv4 default gateway address Example: 169.154.1.1 Register 10284 = 0xA9FE Register 10285 = 0x0101
0x282D– 0x2846	10286– 10311	–	–	–	–	Reserved

IFE/EIFE Interface Commands

What's in This Chapter

List of IFE/EIFE Interface Commands	275
IFE/EIFE Interface Generic Commands	276
EIFE Interface Specific Commands	278

List of IFE/EIFE Interface Commands

List of Commands for IFE/EIFE Interfaces

The following table lists the IFE/EIFE interface commands, their corresponding command codes and user profiles. Follow the command execution procedures accordingly , page 56.

Command	Command code	User profile
Get current time, page 276	768	No password required
Set absolute time, page 276	769	No password required
Write user application name, page 277	1032	No password required
Set validity duration of the data, page 277	41868	Administrator, Services, Engineer, or Operator

List of Specific Commands for EIFE Interface

The following table lists the EIFE interface commands, their corresponding command codes and user profiles. Follow the command execution procedures accordingly.

Command	Command code	User profile
Reset EIFE alarms, page 278	41099	Administrator or Operator
Preset cradle/drawer counters, page 278	41352	Administrator or Operator
Preset regrease timers, page 278	41353	Administrator or Operator
Get events, page 281	50560	No password required

Error Codes

Error codes generated by the IFE/EIFE interface are the generic error codes .

IFE/EIFE Interface Generic Commands

Get Current Time

The get current time command is not hardware protected. The get current time command is still enabled when the locking pad located on the front panel on the IFE/EIFE interface is in locked position.

To get the current time for all modules, set the command registers in the following way:

Address	Register	Unit	Type	Range	Description
0x1F3F	8000	–	INT16U	768	Command code = 768
0x1F40	8001	–	INT16U	10	Number of parameters (bytes) = 10
0x1F41	8002	–	INT16U	8704	Destination = 8704 (0x2200)
0x1F42	8003	–	INT16U	0	Security type of the command
0x1F43– 0x1F44	8004–8005	–	OCTET STRING	0	Password of the command = 0 (no password required)

The following registers contain the time data:

- Register 8023 holds the month in the MSB, the day in the LSB.
- Register 8024 holds the year offset in the MSB (add 2000 to get the year) and the hour in the LSB.
- Register 8025 holds the minutes in the MSB, the seconds in the LSB.
- Register 8026 holds the milliseconds.

Set Absolute Time

The set absolute time command is still enabled when the locking pad located on the front panel on the IFE/EIFE interface is in locked position.

To set the absolute time for all the IMU modules, set the command registers in the following way:

Address	Register	Unit	Type	Range	Description
0x1F3F	8000	–	INT16U	769	Command code = 769
0x1F40	8001	–	INT16U	18	Number of parameters (bytes) = 18
0x1F41	8002	–	INT16U	8704	Destination = 8704 (0x2200)
0x1F42	8003	–	INT16U	0	Security type of the command
0x1F43– 0x1F44	8004–8005	–	OCTET STRING	0	Password of the command = 0 (no password required)
0x1F45-0x1F48	8006–8009	–	XDATE	–	Current date/time

NOTE: Date and time counter is reset and will restart at January 1, 2000 when the internal battery of the MicroLogic X control unit is removed, if the control unit has no other power supply.

NOTE: If the IFE/EIFE interface is not configured in SNTP mode it is mandatory to set absolute time for all the IMU modules periodically, due to the clock drift of each IMU module. Recommended period is at least every 15 minutes.

Write User Application Name

The user application name can be read from registers 10242 to 10273 , page 267.

To write the user application name, set the command registers the following way:

Address	Register	Unit	Type	Range	Description
0x1F3F	8000	–	INT16U	1032	Command code = 1032
0x1F40	8001	–	INT16U	–	Number of parameters (bytes) = depends on the length of the user application name (up to 46 characters)
0x1F41	8002	–	INT16U	0	Destination = 0 (0x0000)
0x1F42	8003	–	INT16U	0	Security type of the command
0x1F43–0x1F44	8004–8005	–	OCTET STRING	0	Password of the command = 0 (no password required)
0x1F45–0x1F46	8006–8007	–	INT32U	–	17039366 = User application name (load 0x0104 into register 8006, 0x0081 into 8007)
0x1F46	8008	–	INT16U	2048	2048
0x1F48	8009	–	OCTET STRING	–	<ul style="list-style-type: none"> MSB = First character of the user application name LSB = Second character of the user application name
0x1F49–0x1F5F	8010–8038	–	OCTET STRING	–	Depends on the length of the user application name and ends by the NULL character 0x00

Set Validity Duration of Data

This command allows to set the validity duration of data in the standard and legacy datasets.

The validity duration of data can be read in a register Validity Duration of Data, page 268.

To set the validity duration of data, set the command registers in the following way:

Address	Register	Unit	Type	Range	Description
0x1F3F	8000	–	INT16U	41868	Command code = 41868
0x1F40	8001	–	INT16U	12	Number of parameters (bytes) = 12
0x1F41	8002	–	INT16U	8705	Destination = 8705 (0x2201)
0x1F42	8003	–	INT16U	1	Security type of the command
0x1F43–0x1F44	8004–8005	–	OCTET STRING	–	Password of the command: Administrator, Services, Engineer, or Operator user profile password
0x1F45	8006	s	INT16U	5–300 (in step of 5 s)	Validity duration of data Factory setting: 10 s

EIFE Interface Specific Commands

Reset EIFE Alarms

To reset EIFE interface alarms, set the command registers in the following way:

Address	Register	Unit	Type	Range	Description
0x1F3F	8000	–	INT16U	41099	Command code = 41099
0x1F40	8001	–	INT16U	10	Number of parameters (bytes) = 10
0x1F41	8002	–	INT16U	8705 (0x2201)	Destination = 8705 (0x2201)
0x1F42	8003	–	INT16U	1	Security type of the command
0x1F43– 0x1F44	8004– 8005	–	OCTET STRING	–	Password of the command: Administrator or Operator user profile password

Preset Cradle/Drawer Counters

To preset the cradle or drawer counters, set the command registers in the following way:

Address	Register	Unit	Type	Range	Description
0x1F3F	8000	–	INT16U	41352	Command code = 41352
0x1F40	8001	–	INT16U	16	Number of parameters (bytes) = 16
0x1F41	8002	–	INT16U	8705	Destination = 8705 (0x2201)
0x1F42	8003	–	INT16U	1	Security type of the command
0x1F43– 0x1F44	8004– 8005	–	OCTET STRING	–	Password of the command: Administrator or Operator user profile password
0x1F45	8006	–	INT16U	0–65535	Connected counter reset/preset: <ul style="list-style-type: none"> 0–65534 = preset value of the connected counter 65535 (0xFFFF) = do not preset the connected counter
0x1F46	8007	–	INT16U	0–65535	Disconnected counter reset/preset: <ul style="list-style-type: none"> 0–65534 = preset value of the disconnected counter 65535 (0xFFFF) = do not preset the disconnected counter
0x1F47	8008	–	INT16U	0–65535	Test counter reset/preset: <ul style="list-style-type: none"> 0–65534 = preset value of the test counter 65535 (0xFFFF) = do not preset the test counter

Preset Regrease Timers

To preset regrease timers, set the command registers in the following way:

Address	Register	Unit	Type	Range	Description
0x1F3F	8000	–	INT16U	41353	Command code = 41353
0x1F40	8001	–	INT16U	18	Number of parameters (bytes) = 18
0x1F41	8002	–	INT16U	8705	Destination = 8705 (0x2201)
0x1F42	8003	–	INT16U	1	Security type of the command
0x1F43–	8004–	–	OCTET STRING	–	Password of the command: Administrator or Operator user profile password

Address	Register	Unit	Type	Range	Description
0x1F44	8005				
0x1F45– 0x1F46	8006–8007	–	INT16U	–	Operating time since last grease maintenance <ul style="list-style-type: none"> 0–157766400 = preset value of regrease timer counter 4294967295 (0xFFFFFFFF) = No preset
0x1F47– 0x1F48	8008–8009		INT32U	–	Operating time since last move in rack in position (delay from last disconnection) <ul style="list-style-type: none"> 0–28944000 = preset value of remove timer 4294967295 (0xFFFFFFFF) = No preset

Get Events Command

To get events, set the command registers in the following way:

Address	Register	Unit	Type	Range	Bit	Description
0x1F3F	8000	–	INT16U	50560	–	Command code = 50560
0x1F40	8001	–	INT16U	27	–	Number of parameters (bytes) = 27
0x1F41	8002	–	INT16U	8705 (0x2201)	–	Destination = 8705 (0x2201)
0x1F42	8003	–	INT16U	0	–	Security type of the command
0x1F43– 0x1F44	8004– 8005	–	OCTET STRING	–	–	Password of the command = 0 (no password required)
0x1F45	8006	–	–	–	–	Reserved
0x1F46	8007	–	INT16U	0, 2	–	Requested get event method , page 281: <ul style="list-style-type: none"> 0 = Most recent events 2 = Events before and up to a sequence number
0x1F47– 0x1F4A	8008–8011	–	–	–	–	Reserved
0x1F4B– 0x1F4C	8012–8013	–	INT32U	–	–	Requested event sequence number (for method 2 only)
0x1F4D	8014	–	INT16U	–	–	Requested event severity
					0–7	Reserved
					8	Low
					9	Medium
					10	High
					11–15	Reserved

Events are returned to command registers in the following way:

Address	Register	Unit	Type	Range	Bit	Description
0x1F53	8020	–	INT16U	50560	–	Last command code
0x1F54	8021	–	INT16U	–	–	Command status: <ul style="list-style-type: none"> 0 = Successful command Other value = command with error, page 58
0x1F55	8022	–	INT16U	–	–	Number of bytes returned
0x1F56	8023	–	–	–	–	Reserved
0x1F57	8024	–	INT16U	0, 2	–	Responded event requested method: <ul style="list-style-type: none"> 0 = Most recent events 2 = Events before and up to a sequence number

Address	Register	Unit	Type	Range	Bit	Description
0x1F5E	8031	–	INT16U	–	–	Responded event severity
					0–7	Reserved
					8	Low
					9	Medium
					10	High
					11–15	Reserved
0x1F5F	8032	–	INT16U	–	–	MSB: Number of events returned
					–	LSB: Remaining events <ul style="list-style-type: none"> • 0 = No more events to get • 1 = More events to get
0x1F60	8033	–	INT16U	1013-25630	–	First event code, page 282
0x1F61–0x1F64	8034–8037	–	DATETIME	–	–	Timestamp of the first event
0x1F65	8038	–	INT16U	–	–	Timestamp quality of the first event
0x1F66–0x1F67	8039–8040	–	INT32U	–	–	First event sequence number
0x1F68	8041	–	INT16U	–	–	MSB: First event status <ul style="list-style-type: none"> • 1 = Occurrence • 2 = Completion • 3 = Pulse LSB: Reserved
0x1F69	8042	–	–	–	–	Reserved
0x1F6A	8043	–	INT16U	–	–	First event severity
					0–7	Reserved
					8	Low
					9	Medium
					10	High
					11–15	Reserved
0x1F6B–0x1F75	8044–8054	–	INT16U	–	–	Characteristics of event 2 (same as event 1)
0x1F76–0x1F80	8055–8065	–	INT16U	–	–	Characteristics of event 3 (same as event 1)
0x1F81–0x1F8B	8066–8076	–	INT16U	–	–	Characteristics of event 4 (same as event 1)
0x1F8C–0x1F96	8077–8087	–	INT16U	–	–	Characteristics of event 5 (same as event 1)
0x1F97–0x1FA1	8088–8098	–	INT16U	–	–	Characteristics of event 6 (same as event 1)
0x1FA2–0x1FAC	8099–8109	–	INT16U	–	–	Characteristics of event 7 (same as event 1)
0x1FAD–0x1FB7	8110–8120	–	INT16U	–	–	Characteristics of event 8 (same as event 1)
0x1FB8–0x1FC2	8121–8131	–	INT16U	–	–	Characteristics of event 9 (same as event 1)
0x1FC3–0x1FCD	8132–8142	–	INT16U	–	–	Characteristics of event 10 (same as event 1)

Get Events Procedure

The command allows to get events by using one of the two following methods:

- get the most recent events
- get events before and up to an event sequence number. The event sequence number is an event identifier defined by the device, and is available among the event characteristics. It can be used to sort the events in chronological order.

The command allows to get 10 events maximum for one or several severity levels.

- To get the 10 most recent events, use the method “get the most recent events”.
- If there are more than 10 events, use the other method “get events before and up to an event sequence number” to get rest of the events.

Example: Read all events

The following diagram shows the steps to follow to read all events recorded in the device:

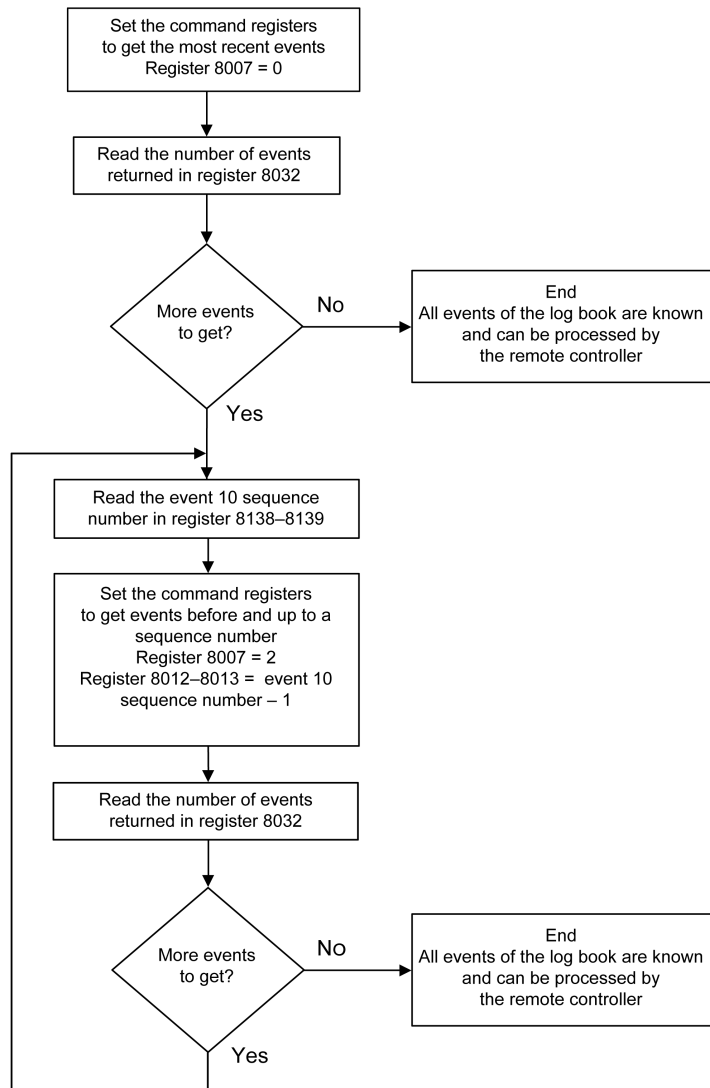

EIFE Interface Events

Event Code	Description
2304 (0x0900)	Cradle position discrepancy
2305 (0x0901)	Cradle connected contact change
2306 (0x0902)	Cradle disconnected contact change
2307 (0x0903)	Cradle test contact change
2308 (0x0904)	Remove device from cradle and put it back
2309 (0x0905)	Cradle has reached its maximum number of operations
2310 (0x0906)	Remaining service life of cradle is below alarm threshold
2311 (0x0907)	New MicroLogic control unit has been detected

Appendices

What's in This Part

MicroLogic X Events	284
---------------------------	-----

MicroLogic X Events

What's in This Chapter

Event History	285
Event List	287

Event History

Overview

All events are logged in one of the histories of the MicroLogic X control unit:

- Trip
- Protection
- Diagnostic
- Metering
- Configuration
- Operation
- Communication

All severities of events are logged, including low-severity events.

Events logged in histories are displayed as follows:

- On the MicroLogic X display screen
- With EcoStruxure Power Commission software
- With the EcoStruxure Power Device app

The event histories can be downloaded using the communication network.

The following information is logged in a history for each event:

- Event ID: event code
- Event type: Entry/Exit or Pulse
- Time stamp: date and time of occurrence and completion
- Context data (only for certain events)

Maximum Number of Events in Each History

Each history has a predefined maximum size. When a history is full, each new event overwrites the oldest event in the relevant history.

Event history	Maximum number of events stored in history
Trip	50
Protection	100
Diagnostic	300
Metering	300
Configuration	100
Operation	300
Communication	100

Displaying Event History on MicroLogic X Display Screen

For more information about how events are displayed on MicroLogic X display screen, refer to Alarm and History menu.

Displaying Event History on EcoStruxure Power Commission Software

All events logged in histories can be consulted using EcoStruxure Power Commission software. The events can be exported as an Excel file.

Events in histories are displayed in chronological order, starting with the most recent event.

Displaying Event History on EcoStruxure Power Device App

All events logged in histories are displayed on the EcoStruxure Power Device app.

Events in histories are displayed in chronological order, starting with the most recent event.

Events can be sorted by date and time, or by sequence number, and filtered by using the following criteria:

- Type
- Severity
- History

Clicking on a specific event in the list displays a list of all occurrences of the same event, in chronological order.

Event List

Event Characteristics

The events are listed according to the history in which they are logged (refer to Event History, page 285).

Each event is defined by the following characteristics:

- Code: event code
- Event: user message
- History, page 285
- Type: not customizable
 - Entry/Exit: occurrence/completion event.
 - Pulse: instantaneous event.
- Latched:
 - Yes: the event is latched and the user must reset the event status.
 - No: the event is unlatched.

NOTE: The latch mode of events marked ⁽¹⁾ in the following tables can be customized with EcoStruxure Power Commission software.
- Activity:
 - Enabled
 - Disabled

NOTE: The activity of events marked ⁽¹⁾ in the following tables can be customized with EcoStruxure Power Commission software.
- Severity:
 - High severity events.
 - Medium severity events.
 - Low severity events.
- Service LED:
 - Yes: the service LED is lit in either orange or red, depending on the severity of the event. Maintenance action is required
 - No: the service LED is not lit. No maintenance action is required.

Trip Events

Code	Event	History	Type	Latched	Activity	Severity	Service LED
0x6400 (25600)	Ir trip	Trip	Pulse	Yes	Enabled	High	No
0x6401 (25601)	Isd trip	Trip	Pulse	Yes	Enabled	High	No
0x6402 (25602)	Ii trip	Trip	Pulse	Yes	Enabled	High	No
0x6403 (25603)	Ig trip	Trip	Pulse	Yes	Enabled	High	No
0x6404 (25604)	IΔn trip	Trip	Pulse	Yes	Enabled	High	No
0x6406	Ultimate self-protection trip (SELLIM)	Trip	Pulse	Yes	Enabled	High	No

Code	Event	History	Type	Latched	Activity	Severity	Service LED
(25606)							
0x6407 (25607)	Self diagnostic trip	Trip	Pulse	Yes	Enabled	High	No
0x641F (25631)	Circuit breaker self diagnostic trip	Trip	Pulse	Yes	Enabled	High	No
0x641D (25629)	Ultimate self-protection trip (DIN/DINF)	Trip	Pulse	Yes	Enabled	High	No
0x641E (25630)	IΔn/Ig test trip	Trip	Pulse	Yes	Enabled	High	No
0x6414 (25620)	Reverse power trip	Trip	Pulse	Yes	Enabled	High	No
0x6410 (25616)	Undervoltage on 1 phase trip	Trip	Pulse	Yes	Enabled	High	No
0x642A (25642)	Undervoltage on all 3 phases trip	Trip	Pulse	Yes	Enabled	High	No
0x6411 (25617)	Overvoltage on 1 phase trip	Trip	Pulse	Yes	Enabled	High	No
0x642B (25643)	Overvoltage on all 3 phases trip	Trip	Pulse	Yes	Enabled	High	No
0x6415 (25621)	Underfrequency trip	Trip	Pulse	Yes	Enabled	High	No
0x6416 (25622)	Overfrequency trip	Trip	Pulse	Yes	Enabled	High	No
0x6421 (25633)	IDMTL long-time trip	Trip	Pulse	Yes	Enabled	High	No
0x6423 (25635)	Forward directional overcurrent trip	Trip	Pulse	Yes	Enabled	High	No
0x6424 (25636)	Reverse directional overcurrent trip	Trip	Pulse	Yes	Enabled	High	No
0x6432 (25650)	IDMT ground fault trip	Trip	Pulse	Yes	Enabled	High	No

Protection Events

Code	Event	History	Type	Latch	Activity	Severity	Service LED
0x631D (25373)	Ultimate self-protection (DIN/DINF) operate	Protection	Entry/Exit	No	Enabled	Medium	No
0x6306 (25350)	Ultimate self-protection (SELLIM) operate	Protection	Entry/Exit	No	Enabled	Medium	No
0x0F11 (3857)	Thermal memory reset order	Protection	Pulse	No ⁽¹⁾	Enabled	Low	No

Code	Event	History	Type	Latch	Activity	Severity	Service LED
0x03F5 (1013)	Ir prealarm (I > 90% Ir)	Protection	Entry/Exit	No	Enabled ⁽¹⁾	Medium	No
0x6200 (25088)	Ir start (I > 105% Ir)	Protection	Entry/Exit	No ⁽¹⁾	Enabled	Medium	No
0x6300 (25344)	Ir operate	Protection	Entry/Exit	No	Enabled	Medium	No
0x6201 (25089)	Isd start	Protection	Entry/Exit	No ⁽¹⁾	Enabled	Low	No
0x6301 (25345)	Isd operate	Protection	Entry/Exit	No	Enabled	Medium	No
0x6302 (25346)	Ii operate	Protection	Entry/Exit	No	Enabled	Medium	No
0x050C (1292)	Ig alarm	Protection	Entry/Exit	No ⁽¹⁾	Enabled	Medium	No
0x6203 (25091)	Ig start	Protection	Entry/Exit	No ⁽¹⁾	Enabled	Low	No
0x6303 (25347)	Ig operate	Protection	Entry/Exit	No	Enabled	Medium	No
0x050D (1293)	IΔn alarm	Protection	Entry/Exit	No ⁽¹⁾	Enabled ⁽¹⁾	Medium	No
0x6204 (25092)	IΔn start	Protection	Entry/Exit	No ⁽¹⁾	Enabled	Low	No
0x6304 (25348)	IΔn operate	Protection	Entry/Exit	No	Enabled	Medium	No
0x6210 (25104)	Undervoltage on 1 phase start	Protection	Entry/Exit	No ⁽¹⁾	Enabled	Low	No
0x6310 (25360)	Undervoltage on 1 phase operate	Protection	Entry/Exit	No	Enabled	Medium	No
0x622A (25130)	Undervoltage on all 3 phases start	Protection	Entry/Exit	No ⁽¹⁾	Enabled	Low	No
0x632A (25386)	Undervoltage on all 3 phases operate	Protection	Entry/Exit	No	Enabled	Medium	No
0x6211 (25105)	Overvoltage on 1 phase start	Protection	Entry/Exit	No ⁽¹⁾	Enabled	Low	No
0x6311 (25361)	Overvoltage on 1 phase operate	Protection	Entry/Exit	No	Enabled	Medium	No
0x622B (25131)	Overvoltage on all 3 phases start	Protection	Entry/Exit	No ⁽¹⁾	Enabled	Low	No
0x632B (25387)	Overvoltage on all 3 phases operate	Protection	Entry/Exit	No	Enabled	Medium	No
0x6216 (25110)	Overfrequency start	Protection	Entry/Exit	No	Enabled ⁽¹⁾	Low	No

Code	Event	History	Type	Latch	Activity	Severity	Service LED
0x6316 (25366)	Overfrequency operate	Protection	Entry/Exit	No	Enabled	Medium	No
0x6215 (25109)	Underfrequency start	Protection	Entry/Exit	No	Enabled ⁽¹⁾	Low	No
0x6315 (25365)	Underfrequency operate	Protection	Entry/Exit	No	Enabled	Medium	No
0x6214 (25108)	Reverse power start	Protection	Entry/Exit	No ⁽¹⁾	Enabled	Medium	No
0x6314 (25364)	Reverse power operate	Protection	Entry/Exit	No	Enabled	Medium	No
0x6221 (25121)	IDMTL long-time start	Protection	Entry/Exit	No	Enabled	Low	No
0x6321 (25377)	IDMTL long-time operate	Protection	Entry/Exit	No	Enabled	Medium	No
0x6232 (25138)	IDMT ground fault start	Protection	Entry/Exit	No	Enabled	Low	No
0x6332 (25394)	IDMT ground fault operate	Protection	Entry/Exit	No	Enabled	Medium	No
0x6223 (25123)	Forward directional overcurrent start	Protection	Entry/Exit	No ⁽¹⁾	Enabled	Low	No
0x6224 (25124)	Reverse directional overcurrent start	Protection	Entry/Exit	No ⁽¹⁾	Enabled	Low	No
0x6323 (25379)	Forward directional overcurrent operate	Protection	Entry/Exit	No	Enabled	Medium	No
0x6324 (25380)	Reverse directional overcurrent operate	Protection	Entry/Exit	No	Enabled	Medium	No
0x0C03 (3075)	ERMS engaged	Protection	Entry/Exit	No	Enabled	Low	No
0x0C04 (3076)	ESM (ERMS switch module) self diagnostic alarm	Protection	Entry/Exit	No	Enabled	Medium	No
0x0C05 (3077)	Communication lost with ESM (ERMS switch module)	Protection	Entry/Exit	No	Enabled	Medium	No
0x0C06 (3078)	Request to unlock ERMS by smartphone	Protection	Pulse	No	Enabled	Low	No
0x1300 (4864)	B curve active	Protection	Entry/Exit	No	Enabled	Low	No
0x1309 (4873)	Protection settings change by display enabled	Protection	Entry/Exit	No ⁽¹⁾	Enabled	Low	No
0x130A (4874)	Remote protection settings change enabled	Protection	Entry/Exit	No ⁽¹⁾	Enabled	Low	No
0x1100 (4352)	Protection settings changed by display	Protection	Pulse	No ⁽¹⁾	Enabled	Low	No

Code	Event	History	Type	Latch	Activity	Severity	Service LED
0x1108 (4360)	Protection settings changed by Bluetooth/USB/IFE	Protection	Pulse	No ⁽¹⁾	Enabled	Medium	No
0x0EF8 (3832)	Optional protections inhibited by IO	Protection	Entry/Exit	No	Enabled	Low	No

(1) Customizable with EcoStruxure Power Commission software

Diagnostic Events

Code	Event	History	Type	Latch	Activity	Severity	Service LED
0x1120 (4384)	Communication lost with IO#1 module	Diagnostic	Pulse	Yes	Enabled ⁽¹⁾	Medium	No
0x1121 (4385)	Communication lost with IO#2 module	Diagnostic	Pulse	Yes	Enabled ⁽¹⁾	Medium	No
0x1122 (4386)	Communication lost with EIFE or IFE module	Diagnostic	Pulse	Yes	Enabled ⁽¹⁾	Medium	No
0x1123 (4387)	Communication lost with IFM module	Diagnostic	Pulse	Yes	Enabled ⁽¹⁾	Medium	No
0x1302 (4866)	Control unit in test mode	Diagnostic	Entry/Exit	No	Enabled	Low	No
0x1303 (4867)	Injection test in progress	Diagnostic	Entry/Exit	No	Enabled	Low	No
0x1304 (4868)	Test aborted by user	Diagnostic	Pulse	No	Enabled	Low	No
0x142C (5164)	Ig protection configured in OFF mode	Diagnostic	Pulse	No	Enabled	Medium	No
0x142D (5165)	Ig function inhibited for test purpose	Diagnostic	Entry/Exit	No	Enabled	Low	No
0x1400 (5120)	Control unit self test major malfunction 1	Diagnostic	Entry/Exit	No	Enabled	High	Yes
0x1404 (5124)	Control unit self test major malfunction 2	Diagnostic	Entry/Exit	No	Enabled	High	Yes
0x1405 (5125)	Control unit self test major malfunction 3	Diagnostic	Entry/Exit	No	Enabled	High	Yes
0x1406 (5126)	Control unit self test major malfunction 4	Diagnostic	Entry/Exit	No	Enabled	High	Yes
0x1416 (5142)	Control unit self test major malfunction 5	Diagnostic	Entry/Exit	No	Enabled	High	Yes
0x1402 (5122)	Internal current sensor disconnected	Diagnostic	Entry/Exit	No	Enabled	High	Yes
0x1403 (5123)	External neutral current sensor disconnected	Diagnostic	Entry/Exit	No	Enabled	High	Yes

Code	Event	History	Type	Latch	Activity	Severity	Service LED
0x1408 (5128)	Earth leakage (Vigi) sensor disconnected	Diagnostic	Entry/Exit	No	Enabled	High	Yes
0x1430 (5168)	Protection settings reset to factory values	Diagnostic	Entry/Exit	No	Enabled	High	Yes
0x142F (5167)	Last modification of protection settings has not been completely applied	Diagnostic	Entry/Exit	No	Enabled	Medium	No
0x140F (5135)	Protection settings no accessible #1	Diagnostic	Entry/Exit	No	Enabled	Medium	Yes
0x1474 (5236)	Protection settings no accessible #2	Diagnostic	Entry/Exit	No	Enabled	Medium	Yes
0x1475 (5237)	Protection settings no accessible #3	Diagnostic	Entry/Exit	No	Enabled	Medium	Yes
0x1476 (5238)	Protection settings no accessible #4	Diagnostic	Entry/Exit	No	Enabled	Medium	Yes
0x1407 (5127)	Control unit self test #1	Diagnostic	Entry/Exit	No	Enabled	Low	No
0x1470 (5232)	Control unit self test #2	Diagnostic	Entry/Exit	No	Enabled	Low	No
0x1471 (5233)	Control unit self test #3	Diagnostic	Entry/Exit	No	Enabled	Medium	Yes
0x1472 (5234)	Control unit self test #4	Diagnostic	Entry/Exit	No	Enabled	Medium	Yes
0x1473 (5235)	Control unit self test #5	Diagnostic	Entry/Exit	No	Enabled	Low	No
0x1411 (5137)	Invalid measurement and optional protection #1	Diagnostic	Entry/Exit	No	Enabled	Medium	No
0x1478 (5240)	Invalid measurement and optional protection #2	Diagnostic	Entry/Exit	No	Enabled	Low	No
0x1479 (5241)	Invalid measurement and optional protection #3	Diagnostic	Entry/Exit	No	Enabled	Medium	Yes
0x147C (5244)	Invalid optional protection self test	Diagnostic	Entry/Exit	No	Enabled	Medium	Yes
0x1412 (5138)	NFC invalid communication #1	Diagnostic	Entry/Exit	No	Enabled ⁽¹⁾	Low	Yes
0x1414 (5140)	NFC invalid communication #2	Diagnostic	Entry/Exit	No	Enabled ⁽¹⁾	Medium	Yes
0x1415 (5141)	NFC invalid communication #3	Diagnostic	Entry/Exit	No	Enabled ⁽¹⁾	Medium	Yes
0x140A (5130)	Invalid display screen or wireless communication #1	Diagnostic	Entry/Exit	No	Enabled	Low	No
0x147B (5243)	Invalid display screen or wireless communication #3	Diagnostic	Entry/Exit	No	Enabled	Medium	Yes

Code	Event	History	Type	Latch	Activity	Severity	Service LED
0x1422 (5154)	Invalid Bluetooth communication	Diagnostic	Entry/Exit	No	Enabled ⁽¹⁾	Medium	Yes
0x1433 (5171)	Replace internal battery	Diagnostic	Entry/Exit	No	Enabled ⁽¹⁾	Medium	Yes
0x1437 (5175)	Internal battery not detected	Diagnostic	Entry/Exit	No	Enabled ⁽¹⁾	Low	No
0x1436 (5174)	Control Unit alarm reset	Diagnostic	Pulse	No	Enabled	Low	No
0x1434 (5172)	Self diagnostic test - firmware	Diagnostic	Entry/Exit	No	Disabled	Medium	No
0x1409 (5129)	Unable to read sensor plug	Diagnostic	Entry/Exit	No	Enabled	High	Yes
0x0D0A (3338)	Invalid Control Unit factory config #1	Diagnostic	Entry/Exit	No	Enabled	Medium	No
0x0D0E (3342)	Discrepancy between display and MicroLogic	Diagnostic	Entry/Exit	No	Enabled	Medium	Yes
0x0D00 (3328)	Critical hardware modules discrepancy	Diagnostic	Entry/Exit	No	Enabled	Medium	No
0x0D01 (3329)	Critical firmware modules discrepancy	Diagnostic	Entry/Exit	No	Enabled	Medium	No
0x0D02 (3330)	Non critical hardware modules discrepancy	Diagnostic	Entry/Exit	No	Enabled	Medium	No
0x0D03 (3331)	Non critical firmware modules discrepancy	Diagnostic	Entry/Exit	No	Enabled	Medium	No
0x0D08 (3336)	Address conflict between modules	Diagnostic	Entry/Exit	No	Enabled	Medium	No
0x0D09 (3337)	Firmware discrepancy within control unit	Diagnostic	Entry/Exit	No	Enabled	Medium	Yes
0x1413 (5139)	IΔn/Ig test - no trip IΔn Ig	Diagnostic	Pulse	No	Enabled	High	No
0x142A (5162)	IΔn/Ig test button pressed IΔn Ig	Diagnostic	Pulse	No	Enabled	Low	No
0x1305 (4869)	ZSI test in progress	Diagnostic	Pulse	No	Enabled	Low	No
0x1440 (5184)	Contact wear is above 60%. Check contacts	Diagnostic	Entry/Exit	No	Enabled ⁽¹⁾	Medium	Yes
0x1441 (5185)	Contact wear os above 95%. Plan for replacement	Diagnostic	Entry/Exit	No	Enabled ⁽¹⁾	Medium	Yes
0x1442 (5186)	Contacts 100% worn out. CB needs to be replaced	Diagnostic	Entry/Exit	No	Enabled	High	Yes

Code	Event	History	Type	Latch	Activity	Severity	Service LED
0x1443 (5187)	Remaining service life of circuit breaker is below alarm threshold	Diagnostic	Entry/Exit	No	Enabled ⁽¹⁾	Medium	Yes
0x1444 (5188)	Circuit breaker has reached the max number of operations	Diagnostic	Entry/Exit	No	Enabled ⁽¹⁾	High	Yes
0x1460 (5216)	Invalid self test - MX1 voltage release	Diagnostic	Entry/Exit	No	Enabled	Medium	Yes
0x1461 (5217)	MX1 voltage release not detected	Diagnostic	Entry/Exit	No	Disabled ⁽¹⁾	Medium	Yes
0x1450 (5200)	MCH charging operations above threshold	Diagnostic	Entry/Exit	No	Enabled ⁽¹⁾	Medium	Yes
0x1451 (5201)	MCH has reached the max number of operations	Diagnostic	Entry/Exit	No	Enabled ⁽¹⁾	High	Yes
0x1462 (5218)	Invalid self test - XF voltage release	Diagnostic	Entry/Exit	No	Enabled	Medium	Yes
0x1463 (5219)	XF voltage release not detected	Diagnostic	Entry/Exit	No	Disabled ⁽¹⁾	Medium	Yes
0x1464 (5220)	Invalid self test - MN undervoltage release	Diagnostic	Entry/Exit	No	Enabled	Medium	Yes
0x1465 (5221)	MN undervoltage release not detected	Diagnostic	Entry/Exit	No	Disabled ⁽¹⁾	Medium	Yes
0x1466 (5222)	Voltage loss on MN undervoltage release	Diagnostic	Entry/Exit	No	Disabled ⁽¹⁾	Medium	Yes
0x1467 (5223)	Communication loss on MN undervoltage release	Diagnostic	Entry/Exit	No	Disabled ⁽¹⁾	Medium	Yes
0x1468 (5224)	Invalid self test - MX2 voltage release	Diagnostic	Entry/Exit	No	Enabled	Medium	Yes
0x1469 (5225)	MX2 voltage release not detected	Diagnostic	Entry/Exit	No	Disabled ⁽¹⁾	Medium	Yes
0x1306 (4870)	Presence of external 24V power supply	Diagnostic	Entry/Exit	No	Enabled ⁽¹⁾	Low	No
0x150F (5391)	Internal Current Power Supply (CPS) sensors malfunction.	Diagnostic	Entry/Exit	No	Enabled	High	No
0x1510 (5392)	Internal Current Power Supply (CPS) sensors malfunction. Tsd forced to 0.	Diagnostic	Entry/Exit	No	Enabled	High	No
0x1511 (5393)	Partial Internal Current Power Supply (CPS) sensors malfunction.	Diagnostic	Entry/Exit	No	Enabled	Medium	No
0x1512 (5394)	Partial Internal Current Power Supply (CPS) sensors major malfunction.	Diagnostic	Entry/Exit	No	Enabled	High	No
0x1438 (5176)	Main voltage loss and CB is closed	Diagnostic	Entry/Exit	No	Enabled ⁽¹⁾	Medium	No
0x1445 (5189)	Remaining service life of MicroLogic is below alarm threshold	Diagnostic	Entry/Exit	No	Enabled ⁽¹⁾	Medium	Yes

Code	Event	History	Type	Latch	Activity	Severity	Service LED
0x1446 (5190)	MicroLogic control unit has reached the max service life	Diagnostic	Entry/Exit	No	Enabled ⁽¹⁾	High	Yes
0x1452 (5202)	MX1 voltage release operation counter is above alarm threshold	Diagnostic	Entry/Exit	No	Enabled ⁽¹⁾	Medium	Yes
0x1453 (5203)	MX1 voltage release has reached the max number of operations	Diagnostic	Entry/Exit	No	Enabled ⁽¹⁾	High	Yes
0x1454 (5204)	XF voltage release operation counter is above alarm threshold	Diagnostic	Entry/Exit	No	Enabled ⁽¹⁾	Medium	Yes
0x1455 (5205)	XF voltage release has reached the max number of operations	Diagnostic	Entry/Exit	No	Enabled ⁽¹⁾	High	Yes
0x1456 (5206)	MN undervoltage release operation counter is above alarm threshold	Diagnostic	Entry/Exit	No	Enabled ⁽¹⁾	Medium	Yes
0x1457 (5207)	MN undervoltage release has reached the max number of operations	Diagnostic	Entry/Exit	No	Enabled ⁽¹⁾	High	Yes
0x1458 (5208)	MX2 voltage release operation counter is above alarm threshold	Diagnostic	Entry/Exit	No	Enabled ⁽¹⁾	Medium	Yes
0x1459 (5209)	MX2 voltage release has reached the max number of operations	Diagnostic	Entry/Exit	No	Enabled ⁽¹⁾	High	Yes
0x1480 (5248)	Schedule basic maintenance within one month	Diagnostic	Entry/Exit	No	Disabled ⁽¹⁾	Medium	Yes
0x1481 (5249)	Schedule standard maintenance within one month	Diagnostic	Entry/Exit	No	Enabled ⁽¹⁾	Medium	Yes
0x1482 (5250)	Schedule manufacturer maintenance within three months	Diagnostic	Entry/Exit	No	Enabled ⁽¹⁾	Medium	Yes

(1) Customizable with EcoStruxure Power Commission software

Metering Events

Code	Event	History	Type	Latch	Activity	Severity	Service LED
0x0F12 (3858)	Reset Min/Max currents	Metering	Pulse	No ⁽¹⁾	Enabled	Low	No
0x0F13 (3859)	Reset Min/Max voltages	Metering	Pulse	No ⁽¹⁾	Enabled	Low	No
0x0F14 (3860)	Reset Min/Max power	Metering	Pulse	No ⁽¹⁾	Enabled	Low	No
0x0F15 (3861)	Reset Min/Max frequency	Metering	Pulse	No ⁽¹⁾	Enabled	Low	No
0x0F16 (3862)	Reset Min/Max harmonics	Metering	Pulse	No ⁽¹⁾	Enabled	Low	No
0x0F17 (3863)	Reset Min/Max power factor	Metering	Pulse	No ⁽¹⁾	Enabled	Low	No

Code	Event	History	Type	Latch	Activity	Severity	Service LED
0x0F19 (3865)	Reset Min/Max current demand	Metering	Pulse	No ⁽¹⁾	Enabled	Low	No
0x0F1A (3866)	Reset Min/Max power demand	Metering	Pulse	No ⁽¹⁾	Enabled	Low	No
0x0F18 (3864)	Reset energy counters	Metering	Pulse	No ⁽¹⁾	Enabled	Low	No

(1) Customizable with EcoStruxure Power Commission software

Operation Events

Code	Event	History	Type	Latch	Activity	Severity	Service LED
0x0C02 (3074)	ERMS engaged for more than 24 hours	Operation	Entry/Exit	No	Enabled	Low	No
0x1000 (4096)	Circuit breaker opened	Operation	Pulse	No ⁽¹⁾	Enabled ⁽¹⁾	Low	No
0x1001 (4097)	Circuit breaker closed	Operation	Pulse	No ⁽¹⁾	Enabled ⁽¹⁾	Low	No
0x0411 (1041)	Closing order sent to XF voltage release	Operation	Pulse	No	Enabled ⁽¹⁾	Low	No
0x0410 (1040)	Opening order sent to MX voltage release	Operation	Pulse	No	Enabled ⁽¹⁾	Low	No
0x1002 (4098)	Manual mode enabled	Operation	Entry/Exit	No	Enabled	Low	No
0x1004 (4100)	Local mode enabled	Operation	Entry/Exit	No	Enabled	Low	No
0x111F (4383)	Allow control by digital input is disabled	Operation	Pulse	No	Enabled	Low	No
0x100A (4106)	Closing inhibited by communication	Operation	Entry/Exit	No	Enabled	Low	No
0x1009 (4105)	Closing inhibited through IO module	Operation	Entry/Exit	No	Enabled	Low	No
0x1307 (4871)	Alarm reset	Operation	Pulse	No	Enabled	Low	No
0x130B (4875)	M2C output 1 is forced	Operation	Entry/Exit	No	Enabled	Low	No
0x130C (4876)	M2C output 2 is forced	Operation	Entry/Exit	No	Enabled	Low	No

(1) Customizable with EcoStruxure Power Commission software

Configuration Events

Code	Event	History	Type	Latch	Activity	Severity	Service LED
0x0D06 (3334)	Config error IO/CU:dual settings or inhibit cls. Dual settings Inhibit close order	Configuration	Entry/Exit	No	Enabled	Medium	No
0x0D0C (3340)	Config error IO/CU: optional protection inhibit	Configuration	Entry/Exit	No	Enabled	Medium	No
0x0D0D (3341)	Config. error IO and CU - Local/ Remote mode	Configuration	Entry/Exit	No	Enabled	Medium	No
0x112B (4395)	Control unit firmware update mode	Configuration	Entry/Exit	No	Enabled	Low	No
0x112C (4396)	Control unit firmware update unsuccessful	Configuration	Pulse	No	Enabled	Medium	No
0x1107 (4359)	Date and time set	Configuration	Pulse	No ⁽¹⁾	Enabled	Low	No
0x1130 (4400)	Digital Module license installed	Configuration	Pulse	No	Enabled	Low	No
0x1131 (4401)	Digital Module license uninstalled	Configuration	Pulse	No	Enabled	Low	No
(1) Customizable with EcoStruxure Power Commission software							

Communication Events

Code	Event	History	Type	Latch	Activity	Severity	Service LED
0x1301 (4865)	Connection on USB port	Communication	Entry/Exit	No	Enabled	Low	No
0x1429 (5161)	Bluetooth communication enabled	Communication	Entry/Exit	No	Enabled ⁽¹⁾	Low	No
0x1427 (5159)	Connection on Bluetooth port	Communication	Entry/Exit	No	Enabled	Low	No
(1) Customizable with EcoStruxure Power Commission software							

Schneider Electric
35 rue Joseph Monier
92500 Rueil Malmaison
France

+ 33 (0) 1 41 29 70 00

www.se.com

As standards, specifications, and design change from time to time,
please ask for confirmation of the information given in this publication.

© 2023 Schneider Electric. All rights reserved.

DOCA0105EN-10