



Harmony GTU

High-performance IoT-ready modular HMI panels



Harmony

Discover [Harmony](#)

Advanced operator interface and industrial relays

Harmony operator interface and industrial relays enhance operational efficiency and equipment availability across industrial and building applications. Harmony includes intelligent connected products and edge terminals that visualize, gather and process data, enabling informed operator decisions

Explore our offer

- [Harmony Push Buttons and Switches](#)
- [Harmony HMI Operator Terminals, iPC and EdgeBox](#)
- [Harmony Signaling Devices](#)
- [Harmony Electrical Relays](#)
- [Harmony Safety](#)

Life Is On

Schneider
Electric

General contents

Harmony GTU

■ General presentation

- Unique HMI flexibility [page 2](#)
- Operate intuitively and comfortably..... [page 2](#)
- Maintain easily [page 3](#)
- Ready for IIoT [page 3](#)

■ Selection guide [page 4](#)

■ Presentation

- Operation..... [page 6](#)
- Environment [page 6](#)
- Maintenance..... [page 7](#)
- Configuration [page 7](#)

■ Communication

- Via Ethernet protocol [page 7](#)
- Via Modbus protocol [page 8](#)
- Via wireless connectivity with Smart WLAN display [page 8](#)
- Via fieldbus modules..... [page 8](#)
- Via USB for HMI accessories [page 9](#)

■ Functions

- Software functions [page 9](#)
- Companion Products [page 10](#)
- Industrial automation solutions [page 10](#)
- Harmony GTU Hardware and Software compatibility table [page 10](#)

■ Panel operating modes

- Edit mode [page 11](#)
- Operating mode..... [page 11](#)

■ Conformal coating for improved environmental resistance [page 11](#)

■ Description..... [page 12](#)

- Advanced and Smart Display modules [page 12](#)
- Display modules with Multi-display adapter [page 13](#)
- Standard, Premium and Open Box modules [page 14](#)

■ References

- Advanced and Smart displays [page 17](#)
- Standard, Premium and Open Box modules [page 17](#)
- Accessories [page 18](#)
- Separate parts [page 18](#)
- Replacement parts [page 19](#)
- Connection accessories [page 20](#)
- Equivalent product table [page 23](#)
- Connection system [page 24](#)

■ Product reference index..... [page 26](#)

High performance IoT-ready modular HMI panels

Harmony GTU is a high-end HMI range designed in a unique modular format that allows you to select and assemble the optimum combination of display unit and processing box as required by your applications.

Harmony Universal panels combine operator efficiency, simplified installation, and flexibility to suit all industrial architectures. This range comprises display modules (Advanced and Smart) and box modules (Standard, Premium and Open).



Advanced display + Premium box



Smart display + Open box

Certified for use in the most demanding automation systems, including industrial control equipment, Hazardous locations, and marine applications.

Unique HMI flexibility

Modular and scalable

- > Choice of screen size, format, image quality, and processing levels enable Harmony GTU to be used in a wide range of applications
- > Universal panels are available in various combinations by simply assembling display modules and box modules

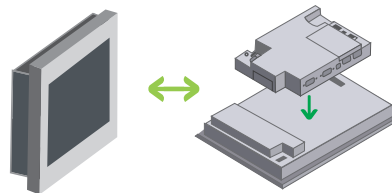

Harmony GTU panel = Display module + Box module

Monitoring and communication capable

- > Easily integrated into industrial architectures via embedded dual interfaces (2 serial ports with different signal types, 2 Gigabit Ethernet ports, 2/4 USB host ports) and an optional Fieldbus interface
- > Innovative wireless connectivity of 12" Smart WLAN display with embedded antenna



Wireless Harmony 12" Smart display

Operate intuitively and comfortably

Smartphone-like interface

- > Easy and comfortable handling with intuitive navigation similar to smartphones/ tablets
- > Projected-Capacitive or Resistive technology designed multi-touch screen supports zooming in/out, swiping, and scrolling through menus even with protective gloves or a protective display screen cover



Touch Screen Gestures

+ Harmony GTU → Multiple combinations with easy assembly

Operate intuitively and comfortably (continued)

Operator efficiency with good visualization

- > High-resolution screen with 16 M colors for a crystal-clear view
- > 16/9 Wide display available in 5 sizes (7", 10", 12", 15", 19") for easy sharing of images with external multimedia devices
- > LED backlight for maximum screen comfort with excellent brightness, complete dimming (100 levels), and auto-adjustment to the environment

Maintain easily

- > Parts can be replaced individually thanks to the modular design
- > Easy installation with anti-drop retractable embedded fasteners and no accessories
- > Robust panel housed in an aluminum material with high temperature resistance (up to 60 °C/140 °F)
- > Dual removable storage units in Box modules speed up maintenance of panels
- > Easy migration of Harmony GTU panels with Smart display as these displays have cut-outs similar to the old range of HMI

Harmony GTU panel box units have SD or CFast card slots for huge external data storage.



Ready for IIoT

- > Dual LAN (Local Area Network) separates IT and PLC communication for better performance and data security
- > Manage all types of data with Open HMI: Microsoft Office and PDF documents, CAD files, Web pages, and Multimedia (sound and video)
- > Leverage plant floor-to-enterprise communication with OPC-UA interface on Open Box

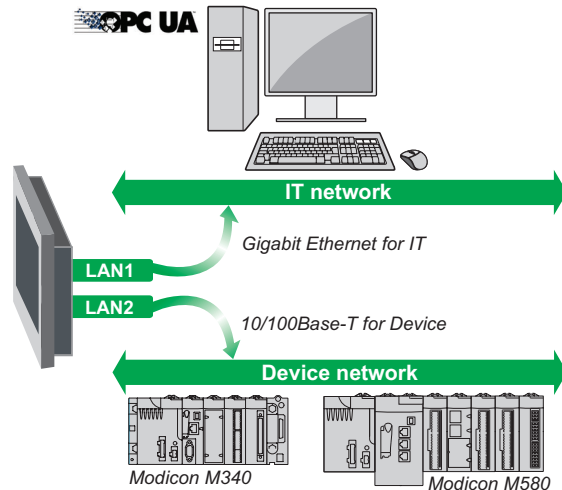

Harmony GTU

High performance IoT-ready modular HMI panels

Applications	Display of text messages, graphic objects, and synoptic views Control and configuration of data
Type of display module	Advanced Display



Display	Touchscreen, size Resolution (pixels) Type	7" Wide 800 x 480 262 K colors, TFT	10" Wide 1,280 x 800	12" Wide 1,280 x 800
Gesture support		Single touch: sliding, scrolling		
Functions	Brightness control Front USB ports Wireless antenna Backlight service life	0...100 (Adjusted with touch panel or software) Optional with XBTZGUSB (Type A port) or HMIZSUSBB (Type mini-B port) — 50,000 h		
Dimensions	External W x H x D mm/in. Cut-out W x H mm/in.	204 x 149 x 67/ 8.03 x 5.86 x 2.64	269 x 199 x 67/ 10.59 x 7.83 x 2.64	309 x 231 x 67/ 12.17 x 9.09 x 2.64
Supply voltage		12...24 V ---		
Environment		Operating temperature 0...60 °C/32...140 °F, Front face protection IP67		
Conformity to standards		EN, IEC, UL 508, CSA, ATEX, Marine		
Compatible box models		Standard, Premium and Open box models		

Display module reference	HMIDT351	HMIDT551	HMIDT651
Pages	17		
Type of box module	Standard Box		



CPU		RISC, 600 MHz
Operating system		Real Time
Memory	RAM Backup memory Main storage: OS with HMI application Memory storage extension	256 MB 512 KB (FRAM/MRAM) 1 GB internal flash EPROM SD card (up to 4 GB)
Functions	Real-time clock Max. variables	Yes, built-in 8,000 (in Vijeo Designer)
Video interface		No
Sound input interface		—
Sound output interface	Speaker output LINE output	— —
Alarm output/Buzzer output		—
Communication	Ethernet port Serial line Expansion unit USB	x2 RJ45 (independent) RS-232C (COM1) + RS-485 (COM2) — 2x USB 2.0 (Type A), 1x USB 2.0 (Type mini-B) Yes (HMIZGBAT)
Optional battery		Yes (HMIZGBAT)
Third-party protocols supported		Siemens, Omron, Mitsubishi, Allen-Bradley (Rockwell Automation), ABB
Compatible display units		HMIDT351, HMIDT551, HMIDT651, HMIDT542, HMIDT642, HMIDT732

Box module reference	HMIG2U (3)
Pages	17

(1) Vijeo Designer and EcoStruxure Operator Terminal Expert Runtime unlimited version pre-installed.
(2) Microsoft Office & PDF readers, Internet browser V11, .Net 4.6.2, Vijeo Citect web client.

Applications	Display of text messages, graphic objects, and synoptic views Control and configuration of data
Type of display module	Smart Display



Display	10.4" 800 x 600 16 M colors, TFT	12.1" 1,024 x 768	15" 1,024 x 768	15" Wide 1,366 x 768	19" Wide
Gesture support	Single touch: sliding, scrolling; Multi-touch: zooming, double touch				
Functions	0...100 (Adjusted with embedded sensor, touch panel or software) 1x Embedded USB 2.0 (Type A), 1x USB 2.0 (Type mini-B) — Yes —				
Dimensions	273 x 215 x 67/ 10.74 x 8.46 x 2.64	315 x 241 x 67/ 12.40 x 9.50 x 2.64	397 x 296 x 67/ 15.63 x 11.65 x 2.64	414 x 295 x 69/ 16.30 x 11.61 x 2.72	483 x 337 x 69/ 19.02 x 13.27 x 2.72
Supply voltage	12...24 V ---				
Environment	Operating temperature 0...60 °C/32...140 °F, Front face protection IP67			Operating temperature 0...55 °C/32...131 °F, IP67	
Conformity to standards	EN, IEC, UL 508, CSA, ATEX, Marine				
Compatible box models	Standard, Premium and Open box models	Open box model	Standard, Premium and Open box models	Premium and Open box models	

Display module reference	HMIDT542	HMIDT642	HMIDT643	HMIDT732	HMIDT752	HMIDT952
Pages	17					
Type of box module	Premium Box		Open Box			

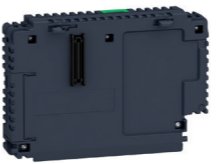

CPU		RISC, 600 MHz	x86, 1.33 GHz
Operating system		Real Time	Windows 7 Embedded Windows 10 IoT Enterprise 32-bit
Memory	RAM Backup memory Main storage: OS with HMI application Memory storage extension	256 MB 512 KB (FRAM/MRAM) 1 GB SD card SD card (up to 4 GB) Yes, built-in 8,000 (in Vijeo Designer) No	2 GB 32 GB CFast card SD card (up to 4 GB) and CFast card (up to 32 GB) — 12,000 (in Vijeo Designer) 1x DVI-D OUT MIC or LINE input (software switch)
Functions	Real-time clock Max. variables	Yes, built-in 8,000 (in Vijeo Designer) No	— 300 mW (rated load: 8 Ω, frequency: 1 KHz) Rated load: 10 KΩ or more Yes (24 V ---/50 mA or less)
Video interface		No	—
Sound input interface		—	—
Sound output interface	Speaker output LINE output	— —	—
Alarm output/Buzzer output		—	—
Communication	Ethernet port Serial line Expansion unit USB	x2 RJ45 (independent) RS-485 (Isolated) (COM1) + RS-232C/RS-422/RS-485 (COM2) 1x fieldbus unit 2x USB 2.0 (Type A), 1x USB 2.0 (Type mini-B) Yes (HMIZGBAT)	1x fieldbus unit 3x USB 2.0 (Type A), 1x USB 2.0 (Type mini-B) Yes (HMIZGBAT)
Optional battery		Yes (HMIZGBAT)	—
Third-party protocols supported		Siemens, Omron, Mitsubishi, Allen-Bradley (Rockwell Automation), ABB	—
Compatible display units		HMIDT351, HMIDT551, HMIDT651, HMIDT542, HMIDT642, HMIDT732, HMIDT752, HMIDT952	HMIDT351, HMIDT551, HMIDT651, HMIDT542, HMIDT642, HMIDT643, HMIDT732, HMIDT752, HMIDT952

Box module reference	HMIG3U (1)	HMIG5U2 (2)(3)	HMIG5U21 (4), HMIG5U22 (1)
Pages	17		

(1) Vijeo Designer unlimited version pre-installed.
(2) No HMI software pre-installed.



Harmony HMI GTU color display modules



Harmony HMI GTU Box modules

Presentation

The Harmony GTU series are high-end HMIs built on an innovative concept of modularity. This offers you a choice of options to find the most suitable Universal panels for your application. Harmony GTU panels comprise a front panel display and a processing box module.

The display modules are available in two versions:

- **Advanced Display:** compact wide screens in 3 sizes
 - 7" W
 - 10" W
 - 12" W
- **Smart Display:** large multi-touch screens in 5 sizes
 - 10.4"
 - 12.1" (with or without wireless Ethernet)
 - 15"
 - 15" W
 - 19" W

The box modules are available in three versions:

- **Standard Box** with Real Time operating system
- **Premium Box** with Real Time operating system
- **Open Box** with Windows 7 Embedded operating system or Windows 10 IoT Enterprise 32-bit operating system

Operation

Harmony GTU Universal panels feature powerful information and communication technologies with maximum operator efficiency in terms of viewing which, depending on the model, include:

- Clear display with standard or wide-format, single or multi-touch technology
- High level of communication with all embedded dual interfaces: 2 serial ports, up to 4 USB host ports, and 2 Gigabit Ethernet ports (Multi-link, Webserver and FTP, E-mail, Remote services)
- Embedded wireless Ethernet function (1) in Access point mode or Station mode
- Removable storage units for operating system easy save/restore, HMI application, and user data (SD memory cards, CFast cards, and USB memory stick management)
- Management of many peripherals: printers, barcode readers, external monitor display, external keyboard/mouse, and Schneider Electric smart USB accessories (tower light, illuminated switch, keyboard, biometric switch, USB keyboard)
- View and record video for USB and IP cameras on Open Box
- Duplicate the image on a large monitor display up to WUXGA resolution (1920x1200) with DVI output, ideal for the Andon application to show production in manufacturing plants
- Multi-operation with up to 3 additional external Harmony GTU displays on the Ethernet network in either duplicate or extended modes

Environment

The high-end Harmony GTU Universal panels have been designed in accordance with numerous standards, certifications, and requirements:

- **Standards:** IEC/EN 61131-2, IEC 61000-6-2, and IEC 61000-6-4
- **Certifications:**
 - RCM (Australia), EAC (Eurasia), KC (Korea)
 - cULus Industrial Control Equipment (UL508 and CSA 22.2 No. 142)
 - cULus Hazardous Locations (ANSI/ISA 12.12.01 and CSA 22.2 No. 213)
 - Atex zone 2/22
- **Marine certifications:** BV, CCS, DNV, GL, LR, RINA, ABS
- **Operating temperature:** up to 60 °C/140 °F
- **Degree of protection on front face** IP 66/67 (according to IEC 60529)
- **Extended power supply voltage** 12...24 V $\overline{\text{DC}}$
- **Brightness sensor** on Smart Display for automatic brightness adjustment to the environment

(1) Supported by HMIDT643 only.

Presentation (continued)

Maintenance

Harmony GTU panels supports the following features for ease of maintenance:

- Easy installation with anti-drop retractable embedded fasteners
- Front USB ports to access all data without opening the cabinet
- Scaler function to manage unique application files with any display size and resolution
- Isolation on RJ45-RS-485 port for more reliable communication in complex grounding applications
- Robust panel with complete aluminum housing
- Dual removable storage units in Harmony GTU boxes for storing applications and data, thus enabling zero downtime while changing panels
- Easy migration of Harmony GTU panels with Smart display as they have cut-outs similar to the old range of HMI

Configuration

Like all other Harmony panels, Harmony GTU Universal panels can be configured using Vijeo Designer software in a Windows environment. This software has an advanced user interface with many configurable windows enabling projects to be developed quickly and easily.

Harmony GTU is also configurable with EcoStruxure Operator Terminal Expert software. This software with the user interface brings greater ease to project development and online updates. EcoStruxure Operator Terminal Expert allows you to create an innovative HMI project that can be operated on Harmony GTU like a smartphone.

For more information on Vijeo Designer and EcoStruxure Operator Terminal Expert, please refer to our website www.se.com/HMI_Software.



EcoStruxure Operator
Terminal Expert



Vijeo Designer

Communication

The following illustrations show the equipment that Universal panels can communicate via Ethernet and Modbus protocols, and also via USB, wireless, and Fieldbus interfaces.

Via Ethernet protocol

Harmony GTU with two Ethernet ports can share data with other Harmony HMIs, browse the PLC's Webserver and SCADA server, and also communicate with PLCs using:

- Modbus TCP protocol
- Third-party Ethernet protocol

OPC-UA protocol is also available on Harmony GTU for IIoT connectivity.

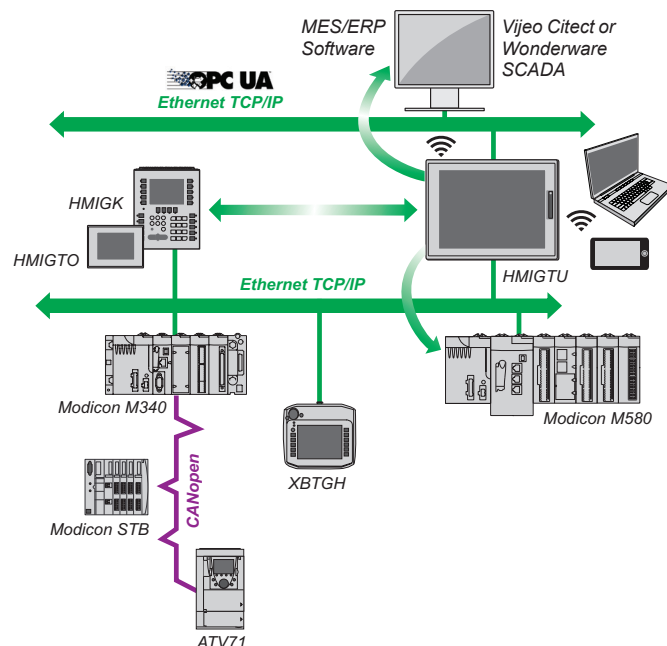

Communication (continued)

Via Modbus protocol

Harmony GTU communicates with PLCs via one or two integrated serial links, using the following communication protocols:

- Schneider Electric (Uni-TE, Modbus)
- Third-party: Mitsubishi Electric, Omron, Allen-Bradley, and Siemens

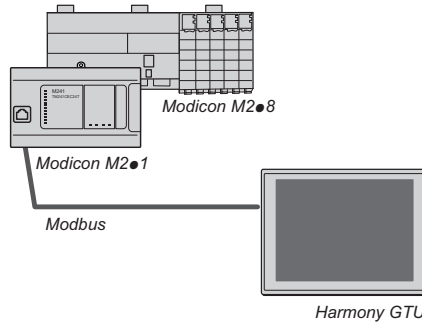

Via wireless connectivity with Smart WLAN display and Vijeo Designer (1)

The 12" Smart WLAN display when configured with Open Box meets setup and maintenance requirements in the following modes:

- Access point mode: The Smart WLAN HMI application display can be accessed wirelessly with a smartphone and Vijeo Designer Air software or with a PC that has an Internet browser and Web Gate function. All HMI applications connected to one of the Harmony GTU Open Box (Bridge function) Ethernet networks can also be accessed wirelessly.
- Station mode: PLCs and other Harmony HMIs can be communicated wirelessly via an existing access point with a Smart WLAN display in the Ethernet architecture to be used in flexible production lines for data sharing.

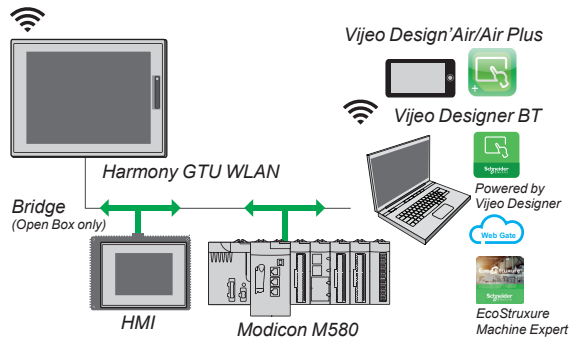

Smart WLAN display in Access point mode

Via fieldbus modules with EcoStruxure Operator Terminal Expert

By attaching the fieldbus module to the Box unit, you can join a PROFIBUS DP network or MPI network to communicate with PROFIBUS DP master or MPI equipment. You can also join a CANopen network to communicate with a CANopen master.

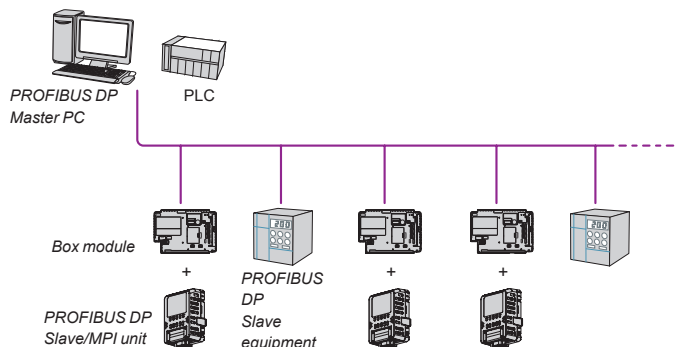

(1) Depending on the environment, location (distance and angle), and application used and displayed on the Harmony GTU screen.



EcoStruxure Operator Terminal Expert



Vijeo Designer



Vijeo Design'Air



Vijeo Design'Air Plus

Communication (continued)

Via USB for HMI accessories with Vijeo Designer

The Harmony USB accessories are designed to expand the selection range of user applications by offering value-added/differentiated HMI solutions. These innovative USB accessories can easily be installed and operated with HMI panels.

The Harmony USB accessories supported by Harmony GTU include:

- Harmony XVGU USB tower light (only on Standard and Premium Boxes)
- Harmony HMIZ illuminated USB switch
- Harmony HMIZ USB keyboard (only on Standard and Premium Boxes)

For more information on HMI USB accessories, please refer to our website [www.se.com/USB Accessories for Harmony Terminals](http://www.se.com/USB_Accessories_for_Harmony_Terminals).

Functions

Software functions

Harmony GTU panels with Vijeo Designer offer the following functions:

- Display of animated synoptic views with 8 types of animation (pressing the touch panel, color changes, filling, movement, rotation, size, visibility, and value display)
- Control and modification of numeric and alphanumeric values
- Display of current date and time
- Real-time and trending curves with log
- Alarm display, alarm log, and management of alarm groups
- Multi-window and recipe management
- Operator-initiated page calls
- Multilingual application management (10 languages at the same time)
- Data processing via Java script
- Storage of the application and logs on external application memory card in SD format, USB stick, or CFast card
- Management of serial printers and barcode readers
- Sound Message management

In addition, the Harmony GTU display units offer a multi-touch screen feature with EcoStruxure Operator Terminal Expert software. These features, such as drag, click, and dual-press gestures are similar to those of smartphones.

The flexibility of Windows 7 Embedded or Windows 10 IoT Enterprise on Harmony GTU Open Box allows:

- Running a Vijeo Designer application or EcoStruxure Operator Terminal Expert software application
- Dual-screen support and cloning function on external monitor with DVI port connected to Open Box
- Multi-operation with up to 3 external Harmony GTU displays connected on Ethernet to the Open Box host in either duplicate or extended modes with touch exclusive control function that is configurable on each display
- Web video support with view and record functions on Open Box
- Navigate HTML pages and send e-mails
- Simultaneous functions such as:
 - Use of Internet Explorer, Windows Media Player, Office Viewer, and Adobe Reader (pdf, doc, xls documents)

The following programs enable you to connect remotely to HMI panels and access processes at any time from anywhere:

- Vijeo Design'Air enables you to connect remotely to the Harmony GTU terminal and have a remote view of the terminal on your tablet and smartphone (mirror function).
- Vijeo Design'Air Plus enables you to create a tablet/smartphone project for a specific display size of the tablet/smartphone. During runtime, an operator can access the Harmony GTU user application to display data and control automation processes on the tablet/smartphone.
- Web Viewer tool enables you to connect remotely to Harmony GTU terminal running an application EcoStruxure Operator Terminal Expert and have a remote of Terminal on a PC, Tablet, or Smartphone (mirror function).

(1) Depending on the environment, location (distance and angle), and application used and displayed on the Harmony GTU screen.



EcoStruxure Secure Connect remote maintenance

Functions

Companion Products

With EcoStruxure Secure Connect, all Harmony GTUs serve as a service enabler and access point for remote maintenance of your machine. EcoStruxure Secure Connect provides a more secure way to access existing Schneider Electric tools (for example: Vijeo Designer, Unity, EcoStruxure Machine Expert) to program or monitor machines remotely. The maintenance personnel can also access Schneider Electric software and update it remotely and securely via the HMI, PLC, and other connected devices as if they were on-site. Troubleshooting and repair can also be performed remotely upon request.

For more information, please refer to the [EcoStruxure Secure Connect](#) catalog available on our website www.se.com.

Industrial automation solutions

The Harmony GTU integrated (1) in MachineStruxure™ (2) automation solutions offer will help machine manufacturers (OEMs) to quickly design optimized machines (in terms of cost and energy efficiency).

MachineStruxure solutions are based on high-performance control platforms and EcoStruxure Machine Expert single software package. EcoStruxure Machine Expert allows the development, commissioning, and programming of machines. With Vijeo Designer software, this software allows programming of panels in the Harmony range.

Harmony GTUs have been designed for PlantStruxure™ (2) architecture, MachineStruxure (2) architecture, and Transparent Ready equipment (combination of Web and Ethernet TCP/IP technologies). Therefore, all panels with an Ethernet port have a built-in FTP server for data file transfer and a Web Gate function for remote access to the panel application from a PC with an Internet browser.

Harmony GTU Hardware and Software compatibility table

GTU Hardware		HMI software (Minimum version required)	
Display	Box	Vijeo Designer	EcoStruxure Operator Terminal Expert
HMIDT●51/●42/●32	HMIG2U	V6.2 SP8	No
	HMIG3U	V6.2 SP1	V3.1
	HMIG5U2	V6.2 SP5.1	No
	HMIG5U22	V6.2SP11	V3.2
HMIDT●52	HMIG2U	No	No
	HMIG3U	V6.2 SP9	V3.1
	HMIG5U2	V6.2 SP7	No
	HMIG5U22	V6.2 SP11	V3.2
HMIDT643	HMI G2U/G3U	No	No
	HMIG5U2	V6.2 SP5.1	No
	HMIG5U22	V6.2SP11	No
HMIDT●●●	HMI G3U/G5U2 + Fieldbus modules	No	V3.1 (3)
	HMIG5U22 + Fieldbus modules	No	V3.2
	HMIG5U21	No	No

(1) Harmony GTU is integrated into MachineStruxure with Vijeo Designer version V6.2 SP3 or later.

(2) For more information on the MachineStruxure and PlantStruxure solutions, please refer to our website www.se.com.

(3) Not supported by HMIG5U2.

Panel operating modes

The following illustrations show the equipment that can be connected to Universal panels depending on their two operating modes.

Edit mode

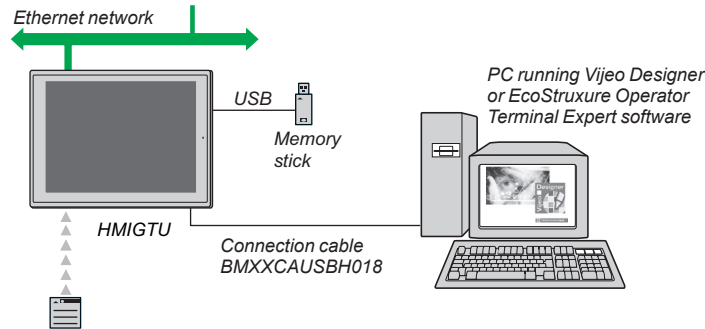

SD memory card for Premium Box and CFast card for Open Box

Operating mode

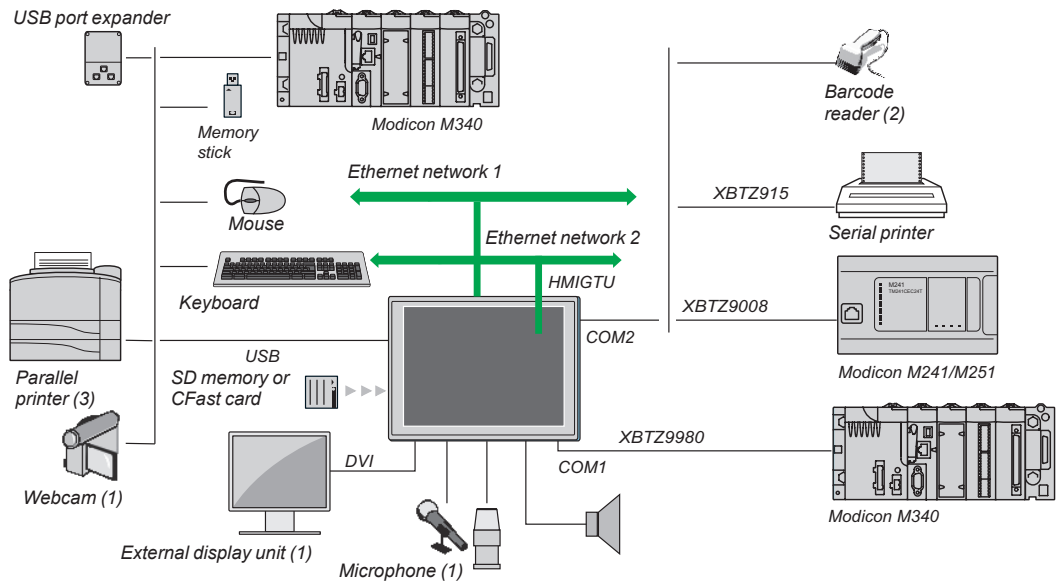

Conformal coating for improved environmental resistance

The Conformal coating service offers varnishing of electronic cards to prolong the service life of the panels and enable them to be used in corrosive environments. The varnishing increases resistance to condensation, dusty atmospheres, and chemical corrosion (sulfurous and halogenous atmospheres). This coating service is applicable to all display and box modules of Harmony GTU. For more information on this service offer, please contact our Customer Care Centre.

(1) With Open Box unit.

(2) Validated with DataLogic Gryphon barcode reader.

(3) Validated with Hewlett Packard printer via USB/PIO converter.

Harmony GTU

High performance IoT-ready modular HMI panels
Advanced and Smart Display modules

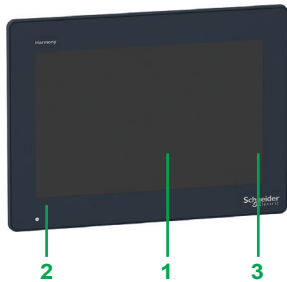

Advanced Display front view

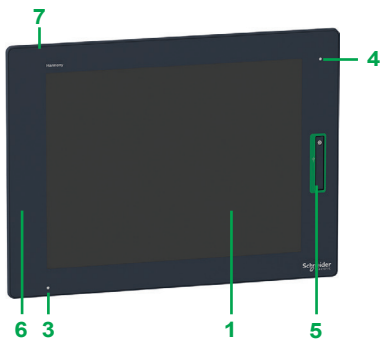

Smart Display front view

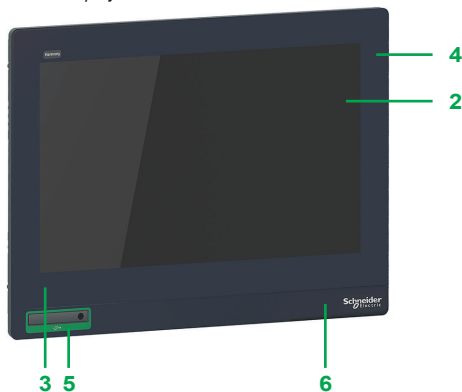

Smart XL display front view

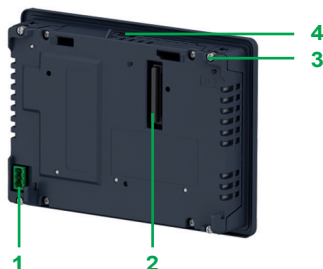

Advanced and Smart display rear view

Description

Harmony Advanced Display modules

Front view

- 1 Single-touch resistive screen for displaying synoptic views (262 K colors LCD TFT LED with brightness adjustable to 100 levels) in sizes 7", 10", and 12" wide
- 2 Multi-color status indicator (green, orange, and red) showing the panel's operating mode
- 3 Aluminum alloy front panel providing IP 66/67 protection when mounted on panel or enclosure door

Harmony Smart Display modules

Front view

- 1 Multi-touch resistive screen for displaying synoptic views (16 M colors, LCD TFT LED with brightness adjustable to 100 levels) in sizes 10.4", 12.1", and 15" standard format
- 2 Multi-touch Projected-Capacitive screen with glass top cover for displaying synoptic view (16 M colors, LCD TFT LED with brightness adjustable up to 100 levels) in sizes 15" and 19" Wide format
- 3 Multi-color indicator (green, orange, and red) showing the panel's operating mode
- 4 Brightness sensor to automatically adjust the level of brightness to the environment
- 5 Front USB ports 2.0 Host & Device with screw protective cover
- 6 Aluminum alloy front panel providing IP 66/67 protection when mounted on panel or enclosure door
- 7 For HMIDT643 GTU display (1), a wireless antenna is embedded in the front bezel with:
 - 2.4 GHz bandwidth
 - Maximum speed: 72.2 Mbps (in IEEE 802.11n mode), 54 Mbps (in IEEE 802.11g mode), 11 Mbps (in IEEE 802.11b mode)
 - Standard IEEE802.11 b/g/n
 - Distance 30 m max. according to the environment
 - Access point or station modes
 - Communication mode for infrastructure only
 - WEP/WPA/WPA2 security
 - Radio frequency certifications for Europe, USA, Canada, China, Taiwan, South Korea, Japan

Advanced and Smart Display rear view

- 1 Removable screw terminal block for 12...24 V $\bar{\text{DC}}$ power supply
- 2 Box interface
- 3 4x retractable embedded screw fasteners
- 4 Anti-Drop lock

(1) Depending on the environment, location (distance and angle), and application used and displayed on the Harmony GTU screen.

Harmony GTU

High performance IoT-ready modular HMI panels
Display modules with Multi-display adapter

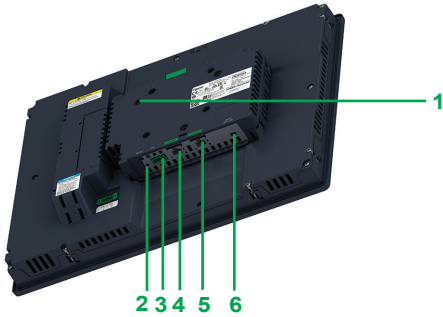

Rear view of the mounted Multi-display adapter HMIZMDARX

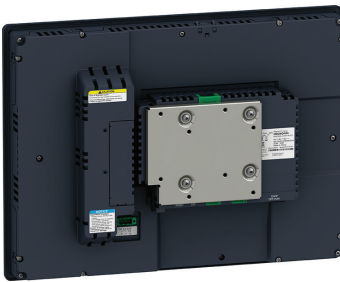

VESA mounted Multi-display adapter

Description

Harmony GTU Display with Multi-display adapter

Rear view

- 1 Screw hole for VESA accessory
- 2 Reset switch (Factory Reset)
- 3 Direct IOs interface
- 4 Ethernet 1
- 5 Ethernet 2 (Embedded Hub)
- 6 ON/OFF switch for DHCP Server

Operating mode

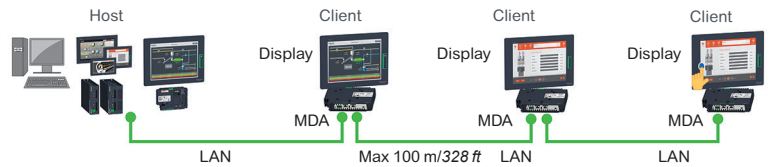

The multi-display adapter is mounted on the rear side of Harmony GTU Display to extend up to 3 remote displays for one host station. The host station (1) can be a Harmony GTU Open, a Harmony iPC, or a general PC.

- Standard Ethernet cable (up to 100 m/328 ft) can be used between adapters for transmission of images and touch signals. The display adapters can be wired in either Line or Star connection modes.
- Configuration software is provided with the adapter (MDA configuration tool) to install on the host station for complete architecture configuration.
- Allows selection of Duplicate or Extended modes for each display's visualization.
- Touch operation exclusive control can be managed either by "first touch priority" mode using a configurable temporization or "Excluded" mode using the direct inputs/outputs with external push buttons and lights.
- VESA mounting accessory is available for the Multi-display adapter.

(1) Operating System supported: Microsoft Windows 7 32-bit/64-bit, Windows 8 32-bit/64-bit, Windows Embedded Standard 7 32-bit/64-bit, Windows Embedded 8.1 Industry Pro 32-bit/64-bit, Windows 10 32-bit/64-bit, and Windows 10 IoT Enterprise for Harmony products only.

Harmony GTU

High performance IoT-ready modular HMI panels
Standard Box module

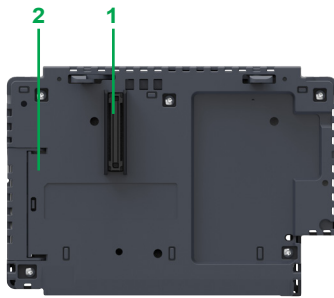

Standard Box Rear view

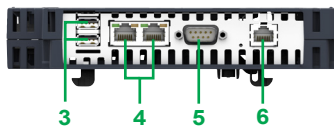

Standard Box Underside view

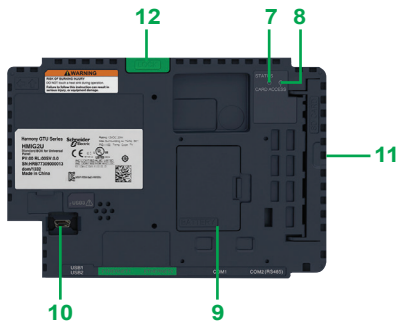

Standard Box Front view

Description

Harmony Standard Box module

Rear view

- 1 Display interface
- 2 Internal Flash Memory (1 GB) with
 - Realtime operating system
 - Vijeo Designer Runtime

Underside view

- 3 2 Type A USB host connectors for connecting peripherals, transferring applications, and Modicon M340 terminal port communication
- 4 RJ45 connector for Ethernet TCP/IP link, 10BASE-T/100BASE-TX with an activity LED
- 5 9-way male SUB-D connector for RS-232C serial link to PLCs (COM1)
- 6 RJ45 connector for RS-485 serial link (COM2)

Front view

- 7 Status LED indicating the operating mode of the terminal
- 8 LED indicating access to the SD memory card
- 9 Expansion unit cover for optional battery
- 10 Type mini-B USB connector for application transfer
- 11 Storage unit Cover for SD slot memory card dedicated to user data
- 12 LOCK button for attaching the box module to the display module

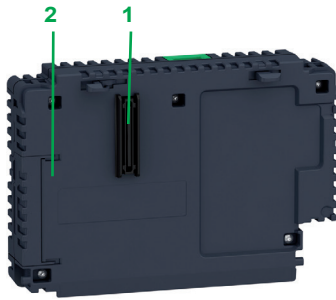

Premium Box rear view

Description

Harmony Premium Box module

Rear view

- 1 Display interface
- 2 Storage unit Cover 1 with an SD card (1 GB) and pre-installed:
 - Real Time operating system
 - Vijeo Designer Runtime or EcoStruxure Operator Terminal Expert Runtime

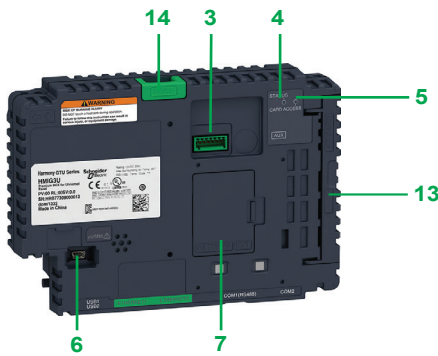

Premium Box front view

Front and underside views

- 3 Auxiliary interface for alarm, buzzer, and speaker outputs
- 4 Status LED indicating the operating mode of the terminal
- 5 LED indicating access to the SD memory card
- 6 Type mini-B USB connector for application transfer
- 7 Expansion unit cover for optional battery or optional FieldBus card
- 8 2 Type A USB host connectors for connecting peripherals, transferring applications, and Modicon M340 terminal port communication
- 9 RJ45 connector for Ethernet TCP/IP link, 10BASE-T/100BASE-TX/1000BASE-T with an activity LED
- 10 COM1 LED indicating data transmission
- 11 RJ45 connector for RS-485 serial link with isolation (COM1)
- 12 9-way male SUB-D connector for RS-232C or RS-422/RS-485 serial link to PLCs (COM2)
- 13 Storage unit Cover 2 for SD slot memory card dedicated to user data
- 14 LOCK button for attaching the box module to the display module

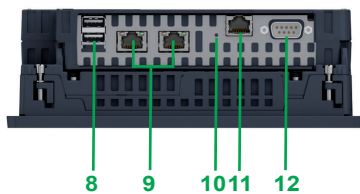

Premium Box underside view

Harmony GTU

High performance IoT-ready modular HMI panels

Open Box module

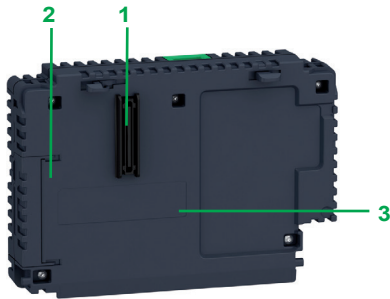

Open Box rear view

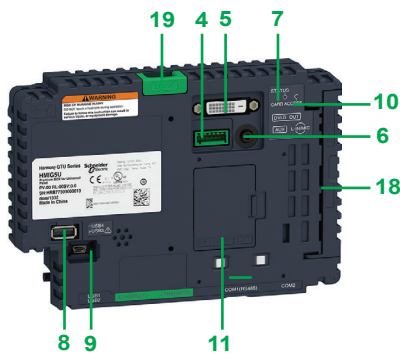

Open Box front view

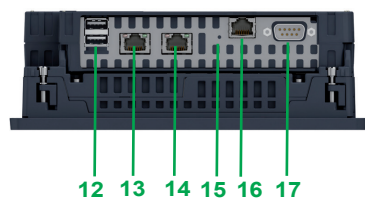

Open Box underside view

Description

Harmony Open Box module

Rear view

- 1 Display interface
- 2 Storage unit Cover 1 that has a CFast card (32 GB) for:
 - **HMIG5U2** pre-installed with Windows® Embedded 7 supplied in 9 languages (English, French, German, Italian, Portuguese, Spanish, Swedish, Chinese, Russian) including:
 - Internet Explorer V11.0 Web browser
 - Notepad
 - Windows Media Player
 - PDF Reader, Microsoft Word/Excel Viewer
 - Framework.Net 4
 - VNC Client/Server (Virtual Network Computing) for remote connection
 - Vijeo Citect Web Client
 - **HMIG5U21/HMIG5U22** pre-installed with Windows 10 IoT Enterprise 32-bit LTSC 2019 supplied in 8 languages (English, French, German, Italian, Portuguese, Spanish, Chinese Simplified and Traditional) including:
 - Internet Explorer V11.0 Web browser
 - Edge Web browser
 - Windows Media Player
 - Framework.Net 4
- 3 Each Open Box reference is dedicated to a different HMI Runtime as explained below:
 - **HMIG5U2**: Runtime Vijeo Designer and registered with Open Box
 - **HMIG5U21**: No HMI Runtime
 - **HMIG5U22**: Runtime Vijeo Designer and EcoStruxure Operator Terminal Expert registered

Front and underside views

- 4 Auxiliary interface for alarm, buzzer, and speaker outputs
- 5 DVI-D interface to connect Harmony iDisplay or LCD monitor display
- 6 Mini-jack connector for microphone input
- 7 Status LED indicating the operating mode of the terminal
- 8 Type A USB connector for application transfer
- 9 Type mini-B USB connector for application transfer
- 10 LED indicating access to SD or CFast cards
- 11 Expansion unit cover for optional battery or optional Fieldbus card
- 12 2 Type A USB host connectors for connecting peripherals, transferring applications, and Modicon M340 terminal port communication
- 13 RJ45 connector for Ethernet TCP/IP link, 10BASE-T/100BASE-TX/1000BASE-T with an activity LED
- 14 RJ45 connector for Ethernet TCP/IP link, 10BASE-T/100BASE-TX/1000BASE-T with an activity LED
- 15 COM1 LED indicating data transmission
- 16 RJ45 connector for RS-485 serial link with isolation (COM1)
- 17 9-way male SUB-D connector for RS-232C or RS-422/RS-485 serial link to PLCs (COM2)
- 18 Storage Cover 2 for SD slot and CFast slot card dedicated to user data
- 19 LOCK button for attaching the box module to the display module



Harmony GTU Universal Display modules

Data entry method	Size	Resolution (pixels)	Colors	Touch type	Options	Reference	Weight kg/lb
Advanced Display							
Via touch screen	7", format 16/9	800 × 480	262 K	Single resistive	No	HMIDT351	1.200/ 2.600
	10", format 16/9	1280 × 800	262 K	Single resistive	No	HMIDT551	2.500/ 5.500
	12", format 16/9	1280 × 800	262 K	Single resistive	No	HMIDT651	3.000/ 6.600
Smart Display							
Via touch screen	10.4", format 4/3 Standard	800 × 600	16 M	Multi resistive	Front USB (Type A + Type mini-B), Brightness sensor, Scaler	HMIDT542	2.700/ 5.900
					Front USB (Type A + Type mini-B), Brightness sensor, Scaler	HMIDT642	3.000/ 6.600
	12.1", format 4/3 Standard	1024 × 768	16 M	Multi resistive	Front USB (Type A + Type mini-B), Brightness sensor, Scaler	HMIDT643	3.000/ 6.600
					Front USB (Type A + Type mini-B) Brightness sensor, Scaler, Wireless antenna	HMIDT732	4.500/ 9.900
	15", format 4/3 Standard	1024 × 768	16 M	Multi resistive	Front USB (Type A + Type mini-B) Brightness sensor, Scaler	HMIDT732	4.500/ 9.900
					Front USB (Type A + Type mini-B) Brightness sensor, Scaler	HMIDT752	5.000/ 11.023
19", format 16/9	1366 × 768	16 M	Multi-touch Projected-capacitive technology	Front USB (Type A + Type mini-B) Brightness sensor, Scaler	HMIDT952	6.800/ 14.991	

Harmony GTU Universal Box modules

Operating system	RAM memory	Storage units	USB ports	Communication	Multimedia interface	Reference	Weight kg/lb
Standard Box							
Real Time	256 MB	1x Internal Flash and 1x SD card	2x Hosts (Type A), 1x Device (Type mini-B)	2x Serial, 2x Fast Ethernet	No	HMIG2U	0.900/ 1.980
Premium Box							
Real Time	256 MB	2x SD cards	2x Hosts (Type A), 1x Device (Type mini-B)	2x Serial, 2x Gigabit Ethernet	Sound output	HMIG3U	0.900/ 1.980
Open Box							
Windows® 7 Embedded	2 GB	2x CFast cards 1x SD card	3x Hosts (Type A), 1x Device (Type mini-B)	2x Serial, 2x Gigabit Ethernet	Sound output, Microphone input, External display output (DVI)	HMIG5U2 (2)	0.900/ 1.980
Windows 10 IoT Enterprise 32bit	4 GB	2x CFast cards 1x SD card	3x Hosts (Type A), 1x Device (Type mini-B)	2x Serial, 2x Gigabit Ethernet	Sound output, Microphone input, External Display output (DVI)	HMIG5U21 (1) HMIG5U22 (2)	

Note: See the table of compatibility on [page 10](#) for Box modules and Display modules with the related HMI software used.

(1) Open Box with no Runtime HMI.

(2) Each Open Box reference is dedicated to run an HMI Runtime application.

GTU_61881_CPMIGU18001



HMIZMDARX

Accessories

Description	Host type compatible	Display compatible	Reference	Weight kg/lb
Harmony GTU Universal Smart System Adapter	HMIG5U2 Harmony iPC General PC	HMIDT●●●	HMIZMDARX	–

Separate parts

Description	Characteristics	Compatible with panels	Reference	Weight kg/lb
SD memory card system	1 GB, blank	HMIG3U	HMIZSD1GS	–
CFast card system	32 GB, blank	HMIG5U2/HMIG5U22	HMIZCFA32S	–
CFast card	32 GB, blank	HMIG5U2/HMIG5U22	HMIZCFA32	–
SD card	4 GB, blank	HMIG3U/HMIG5U2/ HMIG5U22	HMIZSD4G	–
Protective sheets against dirt and moisture (5 peel-off sheets)	–	HMIDT351	HMIZG63	–
		HMIDT551	HMIZD65W	–
		HMIDT651	HMIZD66W	–
		HMIDT542	HMIZG65	–
		HMIDT642/HMIDT643	HMIZG66	–
Protective sheets against ultraviolet light (1 peel-off sheet)	–	HMIDT732	MPCYK50SPSKIT	–
		HMIDT351	HMIZUV3W	–
		HMIDT551	HMIZUV5W	–
		HMIDT651	HMIZUV6W	–
		HMIDT542	HMIZUV5	–
Anti-glare protective sheets (5 peel-off sheets)	Help prevent reflections with dirt resistance	HMIDT642/HMIDT643	HMIZUV6	–
		HMIDT732	HMIZUV7	–
Plastic covers for harsh environments (IP 67 protection)	–	HMIDT752	HMIZDAG7W	–
		HMIDT952	HMIZDAG9W	–
VESA mount adapter	–	HMIDT542	HMIZDCOV5	–
		HMIDT642/HMIDT643	HMIZDCOV6	–
		HMIDT732	HMIZDCOV7	–

105950-35M

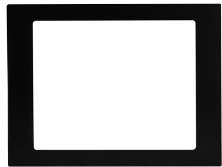

XBTZGCO

GTU_61881_CPMIGU18003



HMIZMDRVS

Description	Characteristics	Length m/ft	Reference	Weight kg/lb
Mechanical adapters for substitution of Harmony range panels	From XBTGT5230 to HMIDT542 From XBTGT4●●● to HMIDT351	– –	XBTZGCO4 HMIZGCO1	– –
Remote USB port for HMI panels	Enables the USB Type-A port to be located remotely on the rear of the XBT or HMIGTU terminal, on a panel, or on an enclosure door (Ø 21 mm fixing device)	1/3.28	XBTZGUSB	–
Remote USB port for HMI panel	Enables the USB mini-B port to be located remotely on the rear of the HMIGTU panel, on a panel, or on an enclosure door (Ø 21 mm fixing device)	1/3.28	HMIZSUSBB	–
DVI-D cable	For connecting an external Harmony iDisplay to the HMIG5U2/HMIG5U22 Open Box	10/32.81	HMIYCABDVI1011	–
Battery	HMIGTU	–	HMIZGBAT	–
Auxiliary connector Sold in sets of 5 units	HMIGTU	–	HMIZGAUX	–
Stylus Sold in lots of 5	–	–	XBTZGPEN	–

105872-35M



XBTZGUSB

Note: Separate part products may be changed or discontinued without notice. Please check our website www.se.com for the latest information.

GTU_61981_CPNGU16002

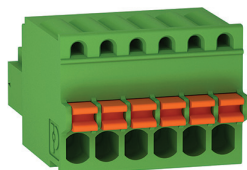

HMIZMDIO

Spare parts				
Description	For use with panels	Reference	Weight	
Seals	HMIDT351	HMIZD53W		–
	HMIDT551	HMIZD55W		–
	HMIDT651	HMIZD56W		–
	HMIDT542	HMIZD55		–
	HMIDT642/HMIDT643	HMIZD56		–
	HMIDT732	HMIZD57		–
	HMIDT752	HMIZD57W		–
	HMIDT952	HMIZD59W		–
USB fastenings Sold in lots of 5	HMIGTU (USB Type A)	HMIZGCLP1		–
	HMIGTU (USB Type mini-B)	HMIZSCLP3		–
Power supply connectors Sold in lots of 5	HMIGTU (direct connection)	HMIZGPWS	0.030/ 0.066	–
	HMIGTU (right-angle connection)	HMIZGPWS2	0.030/ 0.066	–
Direct IO connector	HMIZMDARX	HMIZMDIO		–

Cables for application transfer - Terminal to PC					
Type of terminal (terminal end connector)	Connector (PC end)	Type	Length m/ft	Reference (1)	Weight kg/lb
HMIGTU	USB	USB Type mini-B	1.80/ 5.91	BMXXCAUSBH018	–
		USB Type A		XBTZG935	–

Printer connection cables					
Type of printer (2)	Connector (printer end)	Type	Length m/ft	Reference	Weight kg/lb
HMIGTU	25-way female SUB-D	RS-232C (COM2)	2.5/ 8.20	XBTZ915	0.200/ 0.441
Serial printer for HMIGTU	9-way female SUB-D	USB Type A/RS-232C	1.80/ 5.91	HMIZURS	–

Adapters and isolation boxes for HMIGTU panels

According to the application concerned, these 3 adapters are used with the connection cables.

Description	Type of connector (automation product end)	Physical link (HMIGTU terminal end)	Length m/ft	Reference	Weight kg/lb
Adapter for HMIGTU	25-way SUB-D connector	RJ45 connector	0.2/ 0.66	XBTZG939	–
Adapter for HMIGTU (COM2 port)	25-way SUB-D connector	9-way SUB-D connector, RS-232C	0.2/ 0.66	XBTZG919	–
Description	For use with	Link to isolate	Reference	Weight kg/lb	
Serial link isolation units for HMIGTU	- Isolated link on 9-way SUB-D connector (3) - Box power supply via terminal USB port Incorporates a USB port expander	RS-232C/RS-485 (COM1)	XBTZGI232		–
		RS-485 (COM2)	XBTZGI485		–

(1) Cable included (depending on model) with Vijeo Designer software packages (refer to HMI Configuration Software catalog).

(2) Parallel printer (see [page 11](#)).

(3) Male connector with [XBTZGI232](#).

Note: The spare parts and accessories may be changed or discontinued without notice. Please check our website www.se.com for the latest information.

PF600286



TSXPCX1031

Cables for connecting Harmony panels to other Schneider Electric products								
Automation product type	Type of connector (automation product end)	Protocol	Type of terminal	Link	On port	Length m/ft	Reference	Weight kg/lb
Nano, Modicon TSX Micro, Modicon Premium	Terminal port, 8-way female mini-DIN	Uni-TE (V1/V2), Modbus	HMIGTU	RS-485	COM1	2.5/8.20	XBTZ9780	0.180/0.397
						10/32.80	XBTZ9782	–
			HMIGTU	RS-232	COM2	2.5/8.20	TSXPCX1031	–
Modicon M340 Modicon M241 Modicon M258 Modicon M2•1	RJ45	Modbus	HMIGTU	RS-485	COM1	2.5/8.20	XBTZ9980	0.230/0.507
						10/32.80	XBTZ9982	–
						COM2	2.5/8.20	XBTZ9008
Modicon M340	USB Type mini-B	Terminal port	HMIGTU	USB	USB type A	1.8/5.91	BMXXCAUSBH018	0.230/0.507
						4.5/14.76	BMXXCAUSBH045	–
Modicon Quantum	9-way male SUB-D	Modbus	HMIGTU	RS-232C	COM2	2.5/8.20	XBTZ9710 + (1)	0.210/0.463
						3.7/12.14	990NAA26320	0.290/0.639
Modicon STB	HE13 (NIM, network interface module)	Modbus	HMIGTU	RS-232C	COM2	2/6.56	STBXCA4002	0.210/0.463
						2.5/8.20	XBTZ988 + (1)	0.220/0.485
Modicon Momentum M1	RJ45 (port 1 on Momentum M1)	Modbus	HMIGTU	RS-232C	COM2	2.5/8.20	XBTZ9711 + (1)	0.210/0.463
TeSys U, T starters ATV 312/61/71 variable speed drives ATS 48 starters Lexium 05 Preventa XPSMC	RJ45	Modbus	HMIGTU	RS-485	COM1	3/9.84	VW3A8306R30	0.060/0.132
						1/3.28	VW3A8306R10	–
						2.5/8.20	XBTZ9980	–
						10/32.80	XBTZ9982	–
					COM2	2.5/8.20	XBTZ9008	–

(1) XBTZG919 adapter should be used with cables with "+ (1)" after the reference.

Note: The connection accessories may be changed or discontinued without notice. Please check our website www.se.com for the latest information.

Cables and adapters for connecting Harmony panels to third-party PLCs

Mitsubishi, Melsec PLCs

Description Driver used	Type of terminal	Type of connector (fitted to cable, excluding adapter)	Physical link (COM2)	Length m/ft	Reference	Weight kg/lb
Connection cable, Q Link (SIO)	HMIGTU	9-way SUB-D 9-way SUB-D	RS-232C	5/16.40	XBTZG9772	–
Connection cable, Q CPU (SIO)	HMIGTU	9-way SUB-D mini-DIN	RS-232C	5/16.40	XBTZG9774	–
Connection cable, A Link (SIO)	HMIGTU	9-way SUB-D 25-way SUB-D	RS-232C	5/16.40	XBTZG9731	–
Connection cable, FX (CPU)	HMIGTU	9-way SUB-D mini-DIN	RS-232/ RS-422	5/16.40	XBTZG919 + XBTZ980	–



XBTZG9772



XBTZG9731

Omron, Sysmac PLCs

Description Driver used	Type of terminal	Type of connector (fitted to cable, excluding adapter)	Physical link (COM2)	Length m/ft	Reference	Weight kg/lb
Connection cables, Link (SIO)	HMIGTU	9-way SUB-D 9-way SUB-D	RS-232C	5/16.40	XBTZG9740	–
		9-way SUB-D 25-way SUB-D	RS-232C	5/16.40	XBTZG9731	–
Connection cable, FINS (SIO)	HMIGTU	9-way SUB-D/ 9-way SUB-D	RS-232C	5/16.40	XBTZG9740	–

Rockwell Automation, Allen-Bradley PLCs

Description Driver used	Type of terminal	Type of connector (fitted to cable, excluding adapter)	Physical link (COM2)	Length m/ft	Reference	Weight kg/lb
Connection cable, DF1 Full Duplex	HMIGTU	9-way SUB-D/ 25-way SUB-D	RS-232C	5/16.40	XBTZG9731	–
Connection cable, DH485	HMIGTU	9-way SUB-D	RS-485	5/16.40	XBTZ9732 + (1)	–

Siemens, Simatic PLCs

Description Driver used	Type of terminal	Type of connector (fitted to cable, excluding adapter)	Physical link	Length m/ft	Reference	Weight kg/lb
Connection cable, PPI, S7 200	HMIGTU (3)	RJ45/9-way SUB-D	RS-485 (COM1)	2.5/ 8.20	XBTZG9721	–
Connection cables, MPI port, S7 300/400	HMIGTU	9-way SUB-D/ 9-way SUB-D	RS-232C (COM2)	3/ 9.84	XBTZG9292	–
		HMIGTU (3)	RJ45/flying leads at other end	RS-485 (2) (COM1)	3/ 9.84	VW3A8306D30
			RJ45/9-way SUB-D	RS-485 (2) (COM1)	2.5/ 8.20	XBTZG9721

(1) XBTZG939 adapter should be used with cables with “+ (1)” after the reference (see [page 19](#)).

(2) Non-isolated RS-485 serial link, 12 Mbps.

(3) Available only with Premium Box HMIG3U.

Note: The connection accessories may be changed or discontinued without notice. Please check our website www.se.com for the latest information.

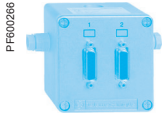

TSXSACA62



TSXPACC01



TSXSACA64



VW3A8306TF10

Connection of Harmony panels via serial links and Ethernet network

Type of bus/network	Tap-off units	Connector (tap-off unit end)	Panel type	Length m/ft	Reference	Weight kg/lb
Uni-Telway serial link	Subscriber socket TSXSACA62	15-way female SUB-D	HMIGTU	3/9.84	VW3A8306	0.150/ 0.331
	Connection box TSXPACC01	8-way female mini-DIN	HMIGTU	2.5/8.20	XBTZ9780	0.180/ 0.396
Modbus serial link	Subscriber socket TSXSACA64	15-way female SUB-D	HMIGTU	3/9.84	VW3A8306	0.150/ 0.331
	T-junction box	With integrated cable, RJ45 fitted	HMIGTU	1/6.56	VW3A8306TF10	–
Ethernet TCP/IP network	Hubs 499 NEH/NOH Switches 499 NES, 499 NMS, 499 NSS and 499 NOS	RJ45	HMIGTU	2/6.56	490NTW00002	–
				5/16.40	490NTW00005	–
				12/39.37	490NTW00012	–
				40/131.23	490NTW00040	–
				80/262.47	490NTW00080	–

Connection of Harmony panels to fieldbuses

Type of bus/network	Connection components	Type of terminal	Reference	Weight kg/lb
FIPWAY, FIPIO	USB gateway	HMIG3U	TSXCUSBFIP	–
Modbus Plus	USB gateway	HMIG3U	XBTZGUMP	–
		HMIG5U2	TSXCUSBMBP	–
CANopen (Slave)	Copla Harmony module	HMIG3U, HMIG5U2, HMIG5U22	HMIZGCAN	–
Profibus DP (Slave)	Copla Harmony module	HMIG3U, HMIG5U2, HMIG5U22	HMIZGPDP	–

Note: The connection accessories may be changed or discontinued without notice. Please check our website www.se.com for the latest information.

Harmony GTU

High-performance IoT-ready modular HMI panels
Equivalent product table

Equivalent product table between XBTGT panels and HMIGTU panels

Old range XBTGT	New range HMIGTU	Comments
XBTGT2120/2220/2330/2430	HMIDT351 + HMIG3U	Different cut-out, no adapter
XBTGT4230/4330	HMIDT351 + HMIG3U	Different cut-out, HMIZGC01 adapter
XBTGT4340	HMIDT351 + HMIG3U	Different cut-out, HMIZGC01 adapter, no video support
XBTGT5230	HMIDT542 + HMIG3U	Different cut-out, XBTZGCO4 adapter
XBTGT5330/5430	HMIDT542 + HMIG3U	–
XBTGT5340	HMIDT542 + HMIG3U	No video support
XBTGT6330	HMIDT642 + HMIG3U	–
XBTGT6340	HMIDT642 + HMIG3U	No video support
XBTGT7340	HMIDT732 + HMIG3U	No video support

Notes: When upgrading from the Harmony XBT range to the Harmony GTU range, the following points should be considered:

- connection to the Profibus DP and Device Net fieldbuses will be possible in the next software release
- serial ports COM1 and COM2 are identical but inverted
- no CF card but SD card provided as optional storage unit
- no CANopen Master connection on Harmony GTU

Equivalent product table between HMIGTW panels and HMIGTU panels

Old range XBTGTW/HMIGTW	New range HMIGTU	Comments
HMIGTW5354	HMIDT542 + HMIG5U2/ HMIG5U22	Different cut-out, no adapter
HMIGTW7354	HMIDT732 + HMIG5U2/ HMIG5U22	3 USB hosts, no jack output but auxiliary output for speakers
XBTGTW652	HMIDT642 + HMIG5U2/ HMIG5U22	–

Notes: When upgrading from the Harmony XBTGTW/HMIGTW range to the Harmony GTU range, the following points should be considered:

- no CF card but CFast card provided as an optional storage unit
- no Windows XP Embedded but Windows 7 Embedded or Windows 10 IoT Enterprise 32-bit are provided for the operating system

HMIGTU panels and Schneider Electric products

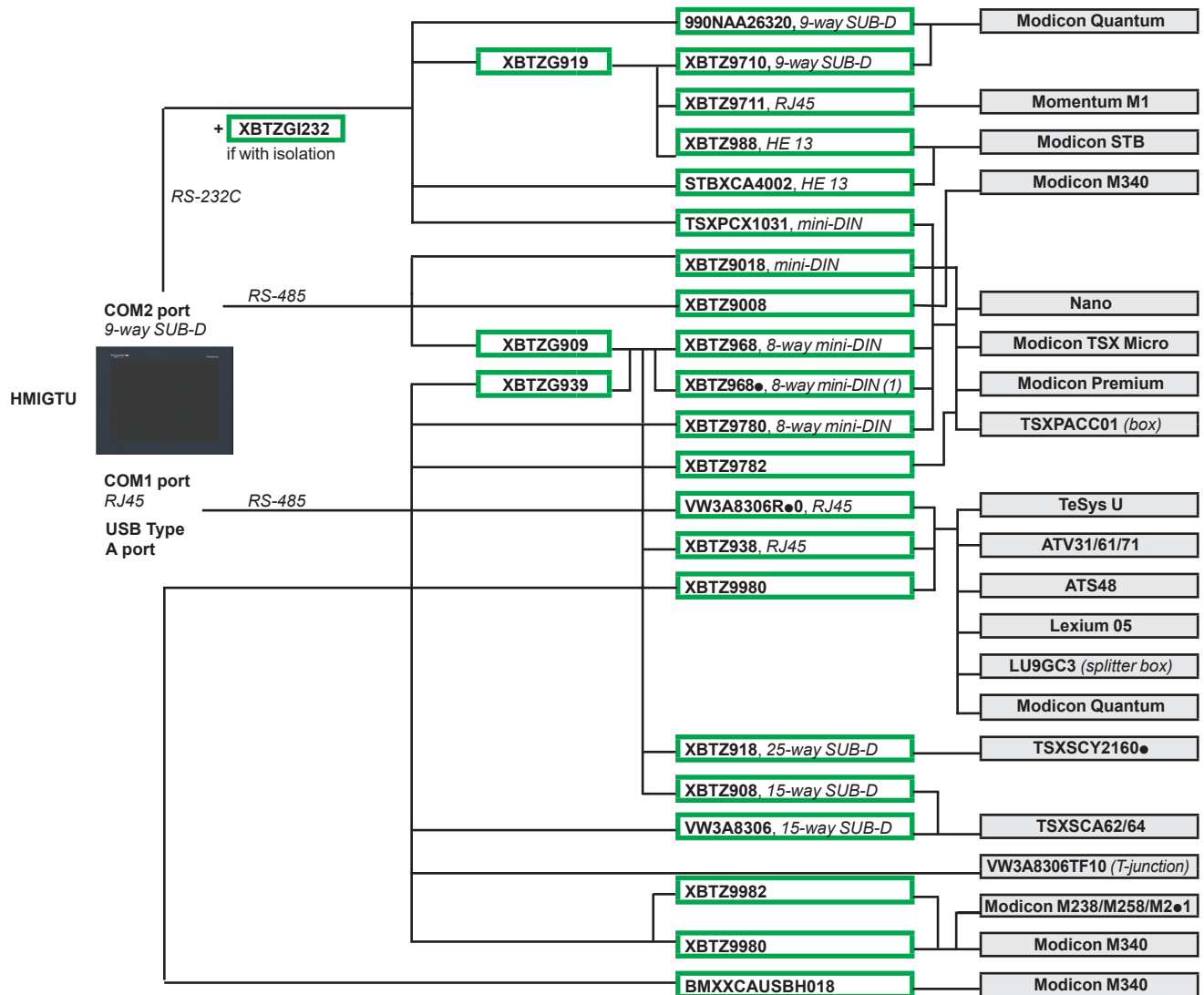

(1) ● defines the length:
 - 0 m/0 ft, 2.5 m/8.20 ft (elbowed connector)
 - 1 m/3.28 ft, 5 m/16.40 ft
 - 6 m/19.68 ft, 16 m/52.49 ft
 - 7 m/22.96 ft, 20 m/65.61 ft
 - 8 m/26.24 ft, 25 m/82.02 ft

HMIGTU panels and third-party PLCs

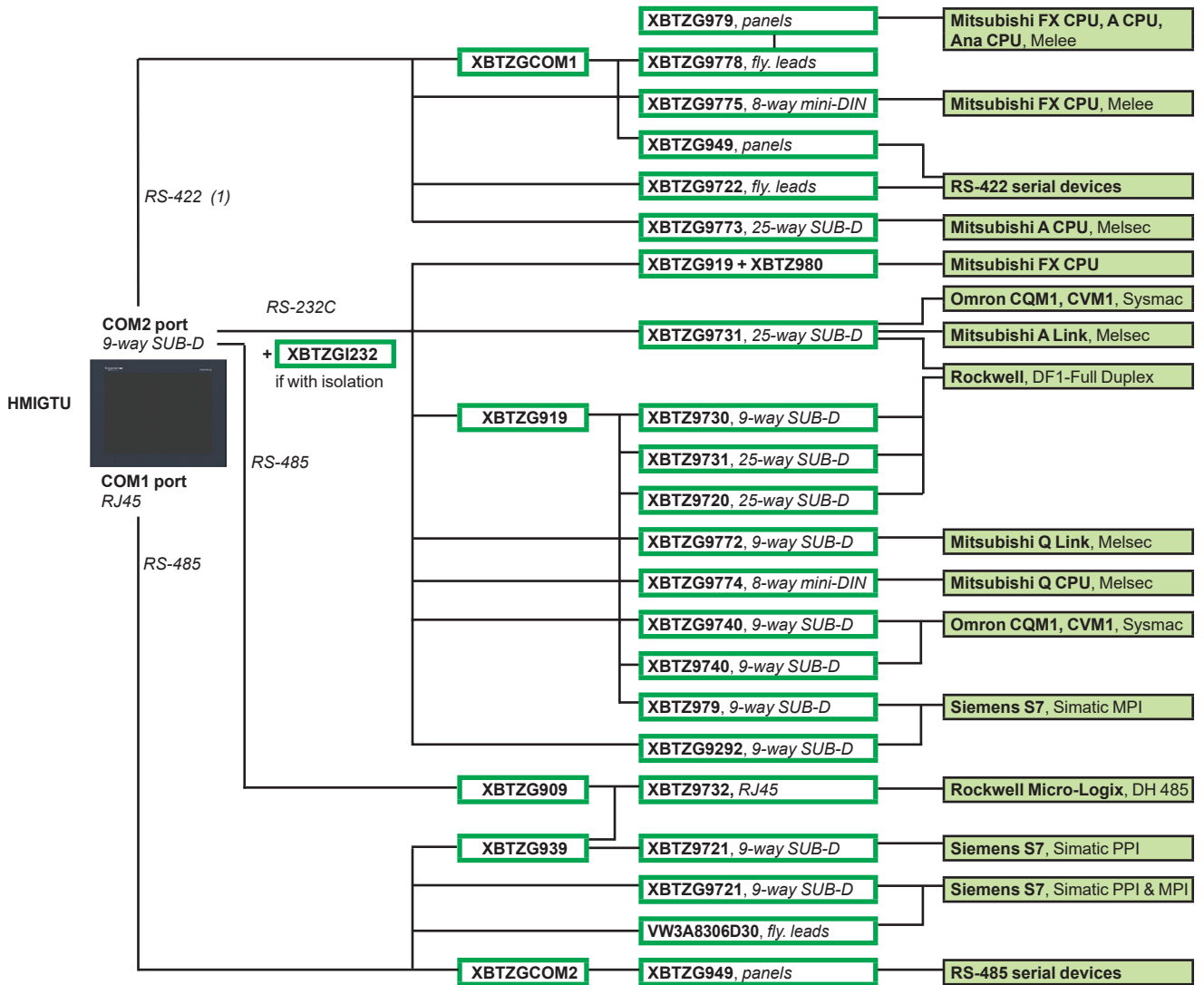

Application transfer from HMIGTU panels to PC

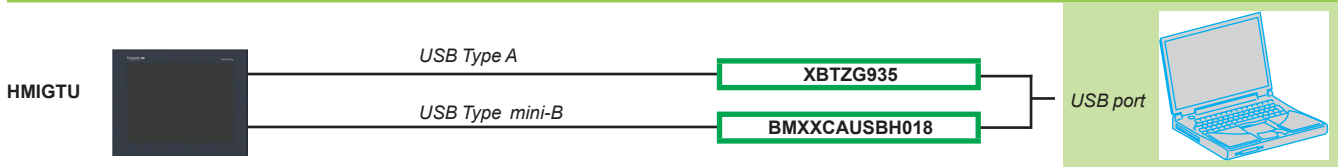

#		HMIZSD1GS	18
490NTW00002	22	HMIZSD4G	18
490NTW00005	22	HMIZSUSBB	18
490NTW00012	22	HMIZURS	19
490NTW00040	22	HMIZUV3W	18
490NTW00080	22	HMIZUV5	18
990NAA26320	20	HMIZUV5W	18
		HMIZUV6	18
B		HMIZUV6W	18
BMXXCAUSBH018	19	HMIZUV7	18
	20	HMIZUV6W	18
BMXXCAUSBH045	20	HMIZUV7	18
H		M	
HMIDT351	17	MPCYK50SPSKIT	18
HMIDT542	17		
HMIDT551	17	S	
HMIDT642	17	STBXCA4002	20
HMIDT643	17		
HMIDT651	17	T	
HMIDT732	17	TSXCUSBFIP	22
HMIDT752	17	TSXCUSBMBP	22
HMIDT952	17	TSXPCX1031	20
HMIG2U	17		
HMIG3U	17	V	
HMIG5U2	17	VW3A8306	22
HMIG5U21	17	VW3A8306D30	21
HMIG5U22	17	VW3A8306R10	20
HMIYCABDV11011	18	VW3A8306R30	20
HMIZCFA32	18	VW3A8306TF10	22
HMIZCFA32S	18		
HMIZD53W	19	X	
HMIZD55	19	XBTZ9008	20
HMIZD55W	19	XBTZ915	19
HMIZD56	19	XBTZG935	19
HMIZD56W	19	XBTZ9710	20
HMIZD57	19	XBTZ9711	20
HMIZD57W	19	XBTZ9732	21
HMIZD59W	19	XBTZ9780	20
HMIZD65W	18		22
HMIZD66W	18	XBTZ9782	20
HMIZDAG7W	18	XBTZ980	21
HMIZDAG9W	18	XBTZ988	20
HMIZDCOV5	18	XBTZ9980	20
HMIZDCOV6	18	XBTZ9982	20
HMIZDCOV7	18	XBTZG919	19
HMIZG63	18		21
HMIZG65	18	XBTZG9292	21
HMIZG66	18	XBTZG939	19
HMIZGAUX	18	XBTZG9721	21
HMIZGBAT	18	XBTZG9731	21
HMIZGCAN	22	XBTZG9731	21
HMIZGCLP1	19	XBTZG9740	21
HMIZGCO1	18	XBTZG9772	21
HMIZGPDP	22	XBTZG9774	21
HMIZGPWS	19	XBTZGCO4	18
HMIZGPWS2	19	XBTZGI232	19
HMIZMDARX	18	XBTZGI485	19
HMIZMDIO	19	XBTZGPEN	18
HMIZMDRVS	18	XBTZGUMP	22
HMIZSCLP3	19	XBTZGUSB	18

Life Is On



Learn more about our products at www.se.com/hmi

The information provided in this documentation contains general descriptions and/or technical characteristics of the performance of the products contained herein. This documentation is not intended as a substitute for and is not to be used for determining suitability or reliability of these products for specific user applications. It is the duty of any such user or integrator to perform the appropriate and complete risk analysis, evaluation and testing of the products with respect to the relevant specific application or use thereof. Neither Schneider Electric nor any of its affiliates or subsidiaries shall be responsible or liable for misuse of the information contained herein.

Design: Schneider Electric
Photos: Schneider Electric

Schneider Electric Industries SAS

Head Office
35, rue Joseph Monier - CS 30323
F-92500 Rueil-Malmaison Cedex
France

DIA5ED2140401EN
September 2023 - V10